

27631



National Library of Canada

Bibliothèque nationale du Canada

CANADIAN THESES ON MICROFICHE

THÈSES CANADIENNES SUR MICROFICHE

NAME OF AUTHOR NOM DE L'AUTEUR William Cameron Clark

TITLE OF THESIS TITRE DE LA THÈSE A Histological Investigation of a Temperature-Sensitive Cell-Lethal Mutant of *Drosophila melanogaster*

UNIVERSITY UNIVERSITÉ University of Alberta Edmonton Canada

DEGREE FOR WHICH THESIS WAS PRESENTED GRADE POUR LEQUEL CETTE THÈSE FUT PRÉSENTÉE M. Sc (Genetics)

YEAR THIS DEGREE CONFERRED ANNÉE D'OBTENTION DE CE GRADE 1976

NAME OF SUPERVISOR NOM DU DIRECTEUR DE THÈSE Dr. M. A. Russell

Permission is hereby granted to the NATIONAL LIBRARY OF CANADA to microfilm this thesis and to lend or sell copies of the film.

The author reserves other publication rights, and neither the thesis nor extensive extracts from it may be printed or otherwise reproduced without the author's written permission.

L'autorisation est, par la présente, accordée à la BIBLIOTHÈQUE NATIONALE DU CANADA de microfilmer cette thèse et de prêter ou de vendre des exemplaires du film.

L'auteur se réserve les autres droits de publication, ni la thèse ni de longs extraits de celle-ci ne doivent être imprimés ou autrement reproduits sans l'autorisation écrite de l'auteur.

DATED / DATE Ap 23/76 SIGNED / SIGNÉ William C. Clark

PERMANENT ADDRESS / RÉSIDENCE FIXE Dept. of Genetics  
University of Alberta  
Edmonton, Alberta, Canada

INFORMATION TO USERS

THIS DISSERTATION HAS BEEN  
MICROFILMED EXACTLY AS RECEIVED

This copy was produced from a microfiche copy of the original document. The quality of the copy is heavily dependent upon the quality of the original thesis submitted for microfilming. Every effort has been made to ensure the highest quality of reproduction possible.

PLEASE NOTE: Some pages may have indistinct print. Filmed as received.

Canadian Theses Division  
Cataloguing Branch  
National Library of Canada  
Ottawa, Canada K1A 0N4

AVIS AUX USAGERS

LA THESE A ETE MICROFILMEE  
TELLE QUE NOUS L'AVONS RECUE

Cette copie a été faite à partir d'une microfiche du document original. La qualité de la copie dépend grandement de la qualité de la thèse soumise pour le microfilmage. Nous avons tout fait pour assurer une qualité supérieure de reproduction.

NOTA, BENE: La qualité d'impression de certaines pages peut laisser à désirer. Microfilmée telle que nous l'avons reçue.

Division des thèses canadiennes  
Direction du catalogage  
Bibliothèque nationale du Canada  
Ottawa, Canada K1A 0N4

THE UNIVERSITY OF ALBERTA

HISTOLOGICAL INVESTIGATION OF A TEMPERATURE-SENSITIVE  
CELL-LETHAL MUTANT OF *DROSOPHILA MELANOGASTER*

by

WILLIAM C. CLARK



A THESIS

SUBMITTED TO THE FACULTY OF GRADUATE STUDIES AND RESEARCH  
IN PARTIAL FULFILMENT OF THE REQUIREMENTS FOR THE DEGREE  
OF MASTER OF SCIENCE

DEPARTMENT OF GENETICS

EDMONTON, ALBERTA

SPRING, 1976

THE UNIVERSITY OF ALBERTA  
FACULTY OF GRADUATE STUDIES AND RESEARCH

The undersigned certify that they have read, and recommend to the Faculty of Graduate Studies and Research, for acceptance, a thesis entitled, "Histological Investigation of a Temperature-Sensitive Cell-Lethal Mutant of *Drosophila melanogaster*," submitted by William C. Clark in partial fulfilment of the requirements for the degree of Master of Science.

M. A. R. M. L. L.  
.....  
Supervisor

S. L. L. L. L.  
.....

David W. W.  
.....

G. R. W. L. K. E. R.  
.....

P. J. H. E. S. T. I. N. G.  
.....

Date ..... April 15, 1976 .....



## ABSTRACT

A temperature-sensitive cell-autonomous lethal mutant in *Drosophila melanogaster*, *ts726*, which in temperature shift experiments causes a variety of developmental abnormalities, including delayed pupariation and the occurrence in highly ordered patterns of deficiencies and duplications of imaginal cuticular structures, was investigated histologically. Products of cellular degeneration were identified ultra-structurally, and histochemically, through acid phosphatase staining, thereby establishing criteria for the scoring of cell death in serial sections with the light microscope. Evidence was presented indicating a lack of cell death of morphogenetic significance in mature control eye-antennal, leg and wing discs.

Evidence of tissue specificity with respect to the cell lethality induced by a restrictive temperature pulse in *ts726* suggested that the mutant primarily affects those tissues which grow by cell division. Heat-treated larvae showed increased levels of cell death relative to unpulsed controls in all imaginal discs investigated. In eye-antennal disc reconstructions, regions of extreme cellular degeneration correlated with regions of the fate map corresponding to the imaginal structures most frequently found to be deficient. It was concluded that cell death induced at the restrictive temperature acted upon a pre-existing mosaic of specified cells to cause the cuticular deficiencies observed. It was also suggested that duplications arise secondarily as a result of cell death-induced proliferation within the disc.

Cell death in imaginal discs could, by these same mechanisms, account for the cuticular effects of a variety of agents, including

various forms of irradiation, a diversity of cytotoxic chemicals, and genetically controlled biochemical defects.

The results were discussed in relation to the theory of pattern formation in imaginal discs, a major implication being that pattern formation occurs progressively during normal disc growth.

#### ACKNOWLEDGEMENTS

I wish to express my sincere thanks to my supervisor, Dr. M. A. Russell, for his encouragement, guidance and patience throughout the course of this work. I would also like to thank Mr. Reg Storms for many helpful discussions, and for his valuable advice on the technical aspects of the histology. I am further indebted to Dr. G. W. R. Walker, who graciously allowed me full use of his laboratory facilities. The expert assistance of my typist, Mrs. Kay Baert, in the final preparation of the manuscript, is gratefully acknowledged.

To my wife I extend special thanks for her enduring patience and understanding.

The financial support of the National Research Council of Canada, in the form of a Postgraduate Scholarship, is sincerely acknowledged.

## TABLE OF CONTENTS

	Page
ABSTRACT	iii
ACKNOWLEDGEMENTS	v
LIST OF TABLES	ix
LIST OF FIGURES	x
Chapter	
I. INTRODUCTION	
II. MATERIALS AND METHODS	
<i>Drosophila</i> Stocks	22
Media and Rearing Conditions	24
Temperature-Shift Experiments	24
Scoring of Imaginal Cuticular Patterns	26
Histological Procedures	29
Larval Histology	29
Vital Staining of Discs	33
Localization of Cell Death in Thin Sections	33
Electron Microscopy	35
Acid Phosphatase Histochemistry	37
Imaginal Disc Reconstruction	38
III. RESULTS	41
Characterization of the <i>ts</i> Lethal Mutants <i>ts</i> <sup>26</sup> and <i>ts</i> <sup>67</sup>	41
Temperature-Sensitivity	41



Chapter	Page
Stage-Distributed Mortalities at the Restrictive Temperature . . . . .	42
Allelism Test . . . . .	44
Phenotypic Characterization of the Mutant Stocks in Temperature-Shift Experiments . . . . .	45
Histological Investigations . . . . .	64
Larval Histology . . . . .	64
Vital Staining of Imaginal Discs . . . . .	69
Disc Morphology and Ultrastructure in Epoxy-Embedded Material . . . . .	79
Histochemical Identification of Basophilic Bodies . . . . .	94
Correlation of Light and Electron Microscopic Observations . . . . .	101
Cell Death in <i>ts67</i> Imaginal Discs . . . . .	106
Density and Spatial Distribution of Cell Death in <i>ts726</i> Imaginal Discs . . . . .	107
Extent of Cellular Degeneration in Control and 96-144 Hour Heat-Treated <i>ts726</i> Discs . . . . .	107
Spatial Distribution of Cell Death in <i>ts726</i> Imaginal Discs . . . . .	112
IV. DISCUSSION . . . . .	165
The Detection, Localization, and Quantification of Cell Death in Imaginal Discs . . . . .	165
Tissue Specificity of the Cell Lethality in Restrictive Temperature Pulsed <i>ts726</i> Larvae . . . . .	169
Extent and Distribution of Cell Death in <i>ts726</i> Imaginal Discs . . . . .	172
General Implications for Pattern Formation Theory . . . . .	184

	Page
REFERENCES . . . . .	187
APPENDIX . . . . .	203

LIST OF TABLES

Table	Description	Page
I.	Number of Progenitor Cells in <i>Drosophila melanogaster</i> Imaginal Discs	8
II.	Some Key References to Fate Maps in Imaginal Discs	14
III.	<i>Drosophila melanogaster</i> Stocks, Mutants, and Chromosomes Employed	23
IV.	Survival to Eclosion in <i>wan<sup>1</sup> ts226/C(1)RM/Y</i> Cultures Reared at Permissive and Restrictive Temperatures	43
V.	Survival to Eclosion in <i>ear ts67</i> Cultures Reared at Permissive and Restrictive Temperatures	43
VI.	Expected and Observed Results of Allelism Test between <i>ts67</i> and <i>ts226</i>	46
VII.	Results of Temperature-shift Experiments with <i>ts226</i>	47
VIII.	Results of Temperature-shift Experiments with <i>ts67</i>	48
IX.	Overall Cuticular Defect Frequency for the Head with respect to Day of Eclosion in <i>ts226</i> Following a 96-144 Hour 29°C Pulse	56
X.	Cuticular Abnormalities of the Head in <i>ts226</i> Following a 96-144 Hour 29°C Pulse	57
XI.	Classification of Eye Types in <i>ts226</i> Survivors and Pharate Adults Following a 96-144 Hour 29°C Pulse	58
XII.	Most frequent $\frac{1}{2}$ -Head Types Observed in <i>ts226</i> Following a 96-144 Hour 29°C Pulse	63
XIII.	Ultrastructural Identification of Cytoplasmic Basophilia from Heat-Treated <i>ts226</i> Discs	102
XIV.	<i>ts226</i> Imaginal Disc Reconstruction Data	109
XV.	Number of Cells and Type I Bodies in Sections Sampled from Control and Heat-treated <i>ts226</i> Eye-antennal Discs	113
XVI.	Fit of Predicted and Observed $\frac{1}{2}$ -Head Deficiency Types in 96-144 Hour 29°C Pulsed <i>ts226</i>	180

LIST OF FIGURES

Figure	Page
1. The head of <i>Drosophila melanogaster</i>	28
2. Two eye facet deficiency types, a. anteriorly indented, b. posteriorly indented	53
3. Deficiency and duplication frequencies of head structures in 96-144 hour heat-treated <i>ts726</i>	62
4. Gomori trichrome/hematoxylin-stained paraffin cross-section in the thoracic region of <i>wen<sup>3</sup></i> larva	68
5. Hematoxylin-stained paraffin cross-section through the eye-antennal discs of a 96-144 hour heat-treated <i>wen<sup>3</sup> ts726</i> larva	71
6. <i>ts726</i> wing discs stained with acridine orange, a. unpulsed control, b. 96-144 hour heat-treated	75
7. 96-144 hour heat-treated <i>y ts726</i> eye-antennal discs stained with acridine orange	77
8. 96-144 hour heat-treated <i>y ts726</i> first leg discs stained with trypan blue	81
9. Light micrographs of toluidine blue-stained $\frac{1}{2}$ $\mu$ epoxy sections of control <i>y ts726</i> discs	84
10. Electron micrographs of control <i>y ts726</i> discs	86
11. Light micrographs of toluidine blue-stained $\frac{1}{2}$ $\mu$ epoxy sections of 96-144 hour heat-treated <i>y ts726</i> discs	89
12. Electron micrographs of 96-144 hour heat-treated eye-antennal discs in regions of concentrated cellular degeneration	91
13. Electron micrographs of 96-144 hour heat-treated eye discs showing control for acid phosphatase staining	93
14. Electron micrographs of 96-144 hour heat-treated eye discs stained for acid phosphatase	97

Figure	Page
15. Electron micrographs of 'nuclear inclusions' from a 96-144 hour heat-treated eye disc	100
16. Adjacent thin and ultrathin sections from a 96-144 hour heat-treated leg disc	105-106
17. a. Fate map of the wing disc. b. Control <i>y ts726</i> wing disc reconstruction	116-117
18. 96-144 hour heat-treated <i>y ts726</i> wing disc reconstructions	119-120
19. Control <i>y ts726</i> leg disc reconstructions	123-127
20. Heat-treated <i>y ts726</i> leg disc reconstructions	129-131
21. a. Fate map of the leg disc. b. Leg disc grid and average Type I body frequencies	133
22. Contour maps of cellular degeneration in <i>y ts726</i> leg discs. a. control, b. heat-treated	136
23. a. Fate map of the eye-antennal disc. b-j. Control <i>y ts726</i> eye-antennal disc reconstructions	138-147
24. Heat-treated <i>y ts726</i> eye-antennal disc reconstructions	149-158
25. a. Eye-antennal grid and average Type I body frequencies. b. <i>y ts726</i> eye-antennal derivative deficiency and duplication frequencies	161
26. Contour maps of cellular degeneration in <i>y ts726</i> eye-antennal discs. a. control, b. heat-treated	163

## INTRODUCTION

Developmental biology is that branch of science concerned with the nature of those transient and normally irreversible processes which result in biological change during ontogeny. Developmental genetics, arising from the general acceptance among biologists of the theory of evolution and the principles of transmission heredity, has as its basic premise the contention that ultimately all developmental changes are genetically determined. In other words, for each developmental process it is assumed there exists a 'genetic program'. Development as a whole, then, is thought to be controlled via temporal and spatial differences in gene activity. Hence, understanding the relationships between the genetic complexity on the one hand, and the so-called 'epigenetic processes' on the other, can be regarded as the central problem in developmental biology today.

In this regard, one intriguing aspect of morphogenesis, the question of pattern formation, is currently receiving considerable attention (Stern, 1954; Sondhi, 1963; Ursprung, 1963; Wolpert, 1969; Lawrence, 1970, 1973; Garcia-Bellido, 1972; Waddington, 1973; Postlethwait and Schneiderman, 1974; Bryant, 1974; Porter and Rivers, 1975). The term 'pattern' will be used here to refer to any array of structures which have fixed positions relative to one another in a tissue (cf. Garcia-Bellido, 1972; Lawrence, 1973; Waddington, 1973). Wolpert (1971) states the problem as follows: "Given an ensemble of more or less identical cells, how can states be assigned to these cells such that when they undergo molecular differentiation the cells will form a well defined spatial pattern?" Here the insect integument is

a favorable experimental system. The pattern elements are epidermal cell derivatives such as chaetae (bristles), trichomes (hairs), and sensilla arranged in regions which, although sometimes intricately folded, may be regarded as two-dimensional since the insect epidermis consists of a single layer of cells.

In the higher Diptera and Hymenoptera the entire adult epidermis is derived from groups of cells, imaginal discs and abdominal histoblasts, found in the larval hemocoel. These cell groups occur to some extent in all holometabolous insects but in the Cyclorrhaphan Diptera, including *Drosophila*, and the Apocritous Hymenoptera, their evolution is most complete, allowing the insect two distinct developmental phases: the larva, highly adapted for feeding and rapid growth, and the adult, specialized for mobility and reproduction.

The imaginal discs of *Drosophila* are sac-like invaginations from the larval epidermis, each consisting of a single continuous epithelial cell layer, which becomes folded during the course of its development and encloses a narrow lumen (Weismann, 1864; Chen, 1929; Auerbach, 1936; Robertson, 1936). Continuous with the disc proper is an enclosing cellular peripodial membrane, the whole system being bound by a basement lamina.

The discs are first evident histologically in the late embryo (genital disc — Laugé, 1967) and early first instar larva (thoracic discs — Auerbach, 1936). They grow during larval life by cell division. At maturity the larger discs contain several thousand cells while the smaller ones are made up of only a few hundred. Throughout larval life the disc cells remain morphologically undifferentiated even at the ultrastructural level (see Ursprung, 1972). They are columnar and

small, averaging not more than five microns in diameter. Each has a pronounced oval nucleus with little surrounding cytoplasm, thereby presenting an embryonic appearance. This lack of differentiation at the cellular level is accompanied by a lack of larval function for the discs themselves. In a screen for late lethal mutants, Shearn et al. (1971) isolated *Drosophila* mutants lacking some or all discs which were viable throughout larval life.

Further analysis of late lethal mutants has demonstrated that the development of the imaginal discs is under direct genetic control (Shearn and Garen, 1974). In these studies 57 mutants analysed were found to fall into 52 separate complementation groups, of which 48 contained one mutant, three contained two mutants each, and one contained three mutants. Evidence was presented which indicated that the mutants were blocked in disc-specific functions.

The abdominal histoblasts are small nests of cells lying continuous with the larval abdominal epidermal cells. Unlike discs, they are not sac-like invaginations and are not enclosed by a peripodial membrane. Nor do they grow during larval life; rather, their cells begin proliferation at about the time of pupariation (Robertson, 1936; Garcia-Bellido and Merriam, 1971a; Guerra et al., 1973).

At metamorphosis the invaginated discs accomplish a process of evagination known as *eversion* following which their cells, and those of the histoblasts, replace the histolysed larval epidermis and secrete the adult cuticle. It has long been known from histological studies of development that each imaginal disc gives rise to a specific portion of the adult epidermis. Furthermore, in *Drosophila*



total extirpation of a disc from a larva leads to a precisely corresponding cuticular deficiency in the resulting adult integument (Zalokar, 1943; Chiarodo, 1963; Murphy, 1967; Wildermuth, 1968; Dubendorfer, 1971). Three pairs of discs form the head: the labial, the clypeo-labral, and the eye-antennal (Gehring and Seippel, 1967), a pair of dorsal and a pair of ventral discs form each thoracic segment, pairs of dorsal and ventral histoblasts form each of the first eight abdominal segments, and a single genital disc forms the external genitalia and the ninth and tenth abdominal segments.

In spite of the apparently undifferentiated state of the imaginal discs during larval life, experimental evidence indicates that within them certain determinative events have occurred. The term 'determination' has been widely used to describe the process(es) by which a population of cells is programmed for a specific pathway of development, ". . . singling it out from among the various possibilities for which a cellular system is competent" (Hadorn, 1965). Evidence has been presented that as early as the cellular blastoderm stage in *Drosophila* embryogenesis (2-1/2—3 hours after fertilization) restrictions in the capacity for specific adult differentiation have occurred.

Chan and Gehring (1971) mechanically dissociated blastoderm embryos into single cells. After culturing reaggregated cell pellets in adult hosts, metamorphosis of the imaginal cells was induced by transplantation into metamorphosing host larvae. The state of determination of blastoderm cells was tested by cutting embryos in half and intermixing cells from the anterior or posterior half with genetically marked cells from whole embryos. The whole embryo cells served as internal controls and these produced structures derived from all regions

of the adult body in implants. Head structures were formed by anterior halves but not by posterior ones; abdominal structures were derived only from posterior halves. This result clearly indicated a determination for anterior and posterior adult structures as early as the cellular blastoderm stage.

On the other hand, Illmensee (1972), using the technique of nuclear transplantation, has shown that cleavage nuclei, pole nuclei from preblastoderm embryos, and lateral nuclei from syncytial blastoderm embryos can produce any of the adult structures normally derived from imaginal discs when injected into host embryos. These results along with those cited above have lent support to the theory that the cleavage nuclei are initially multipotent and their developmental fates become determined when they enter the egg cortex where regional determinative factors may be located (see Counce, 1973). However, in spite of extensive searches, the disc-specific maternal effect mutants that the hypothesis would suggest have not been found.

Defect experiments have also provided support for the idea that imaginal disc determination occurs around the time of blastoderm cellularization. Defects have been produced in embryos at various stages of development by extirpation of cytoplasm (Howland and Sonneblick, 1936), by thermocautery (Bownes, 1975), and by localized ultraviolet irradiation (Geigy, 1981; Nöthiger and Strub, 1972). A generalisation that can be drawn from these experiments is that if the defects are made at the cellular blastoderm stage or later they can be correlated with the positions of resulting adult abnormalities.

Further evidence for disc-specific determination of blastoderm

cells comes from somatic recombination data. Clones of genetically marked cells induced by X-irradiation of heterozygous blastoderm embryos are confined to an area of adult epidermis derived from one disc only (Bryant and Schneiderman, 1969; Bryant, 1970; Garcia-Bellido and Merriam, 1971b; Postlethwait and Schneiderman, 1971). Since individual clones initiated at this early stage never encompass cuticle derived from more than one disc, the developmental fate of the progeny of each cell present is already disc-specific. It follows that the cells which will go to make up each individual disc are already segregated at this time. Also, exchange of cells between these segregated populations cannot occur. Analysis of clones initiated at even earlier embryonic stages is precluded by extreme X-ray sensitivity (see, for example, Wieschaus, 1974).

Gynandromorph data are also compatible with the idea that disc-specific determination has occurred by the cellular blastoderm stage. 'Gynandromorphs', or sexual mosaics, are easily produced in *Drosophila*, for instance, by spontaneous somatic elimination of an unstable ring X chromosome. Any recessive marker mutations carried on the X chromosome retained are uncovered and expressed in the descendants of the original cell where the loss occurred. Analyses of gynandromorphs indicate that chromosome elimination must occur rather early in development since, in general, they consist of large contiguous areas of either male or female cells. Also, any given adult structure is male about half the time in gynanders. Consequently the mosaicism is initiated in an early cleavage division and the plane of the earliest cleavage division relative to the principal axes of the egg must be oriented indeterminately. The latter conclusion is supported by earlier

cytological observations (Wald, 1936).

The number of cells segregated to give rise to a particular disc has been estimated by the elegant method of Sturtevant (1929) perfected by Stern (1940). The calculation is based on the fact that in gynandromorphs the cuticular derivatives of certain discs are more frequently mosaic than those of others. It follows that the frequency of mosaicism should be higher for those discs with a larger number of initial progenitor cells, assuming that cell division rates in the system are more or less constant (see, however, Becker, 1957; Garcia-Bellido and Merriam, 1971b; Postlethwait and Schneiderman, 1971 ). An estimate of the number of progenitor cells of any given disc can then be obtained from the reciprocal of the smallest fraction of the disc's derivatives which is marked in gynandromorphs. Table I summarizes the estimates arrived at for the various *Drosophila melanogaster* discs utilizing this method. From these results it appears that small populations of cells, rather than single ones, initially acquire the determination to develop into the various discs. These small numbers of cells of course limit the extent of cellular patterning present at this stage.

The analysis of gynandromorph data has also had important implications to the theory of pattern formation itself in imaginal discs. The concept of 'prepatterns' (Stern, 1954) was derived from such data. *Drosophila* are sexually dimorphic in certain of their adult cuticular patterns such as the basitarsus of the foreleg where males develop sex comb teeth and females transverse row chaetae. In gynandromorphs, when the male/female boundary passes through this pattern, the male and female cells differentiate their structures autonomously. Although the cellular derivatives develop autonomously their spatial organisation in

Table I. Number of Progenitor Cells in *Drosophila melanogaster* Imaginal Discs

Disc or primordium	n	References
Antennal	7-9	Postlethwait and Schneiderman (1971)
Eye anlage	2	Becker (1957)
Eye-antennal	13	Garcia-Bellido and Merriam (1969a)
Ventral thoracic (leg)	~20	Garcia-Bellido and Merriam (1969a) Bryant and Schneiderman (1969)
Dorsal mesothoracic (wing)	16	Stern (1940)
	12	Garcia-Bellido and Merriam (1969a)
	11	Bryant (1970)
	~40	Ripoll (1972)
Abdominal histoblasts	8	Garcia-Bellido and Merriam (1971b)
Genital	~2	Garcia-Bellido and Merriam (1969a)

After Nöthiger, 1972.

mosaics consistently appears as a hybrid in that it is neither male nor female but rather an integrated intermediate (Stern and Hannah, 1950). This suggested to Stern that the male and female patterns shared the same building principle or 'prepattern'. According to this concept mutants altering patterns should fall into two formally distinct classes: those with an altered prepattern, and those with altered 'competence' to respond to the normal prepattern (Stern, 1968). Since a prepattern would be generated co-operatively by a group of cells, small mutant patches in mosaics should be non-autonomous. Conversely, a cell's response, or competence to respond to a prepattern, should depend upon its individual genotype and hence mutants of the latter class should be autonomous. Most mutants which alter cuticular patterns are clearly autonomous in mosaics; however, a few, such as *eyeless-dominant* ( $ey^D$ ), have been suggested as possible 'prepattern mutants'.  $ey^D$  is lethal when homozygous but in heterozygotes that survive, extra sex comb teeth are formed in an enlarged male basitarsus. Several wild type clones induced in a heterozygous background were found to behave non-autonomously, that is, they contained extra sex comb teeth (Stern and Tokunaga, 1967; Tokunaga, 1970).

Considering the overall phenotype of  $ey^D$ , it is possible that its mechanism of action in mosaics may involve cell death in the imaginal discs. A secondary consequence of this death could be localized cellular proliferation (cf. Schweizer, 1972) which might somehow account for the non-autonomous differentiation of extra sex comb teeth. Such growth disturbances in discs may well explain the pattern alterations in other alleged prepattern mutants such as *comb gap* (Datta and Mukherjee, 1971) and *Hairy-wing* (Stern, 1968).

Gottlieb (1964) has interpreted the non-autonomy of *Hairy-wing* (*hw*) in another way. This mutant produces extra bristles in the region of the dorsocentrals of the thorax. In mosaics where a *hw/hw* clone existed adjacent to a *hw<sup>+</sup>/hw<sup>+</sup>* twin in a heterozygous background Gottlieb found that extra bristles were formed not only in the homozygous mutant patch but also in the adjacent patch homozygous for the *wild-type* allele. He interpreted this non-autonomous development as resulting from the spread of a "chaetogenic substance" from the *hw/hw* to the *hw<sup>+</sup>/hw<sup>+</sup>* tissue. This can be considered as an example of induction, in the broadest sense of the term. Its importance in the theory of pattern formation in imaginal discs was suggested earlier (Waddington, 1940; Lees, 1941) for the induction by the dorsal wing cells of vein formation by ventral wing cells. Recently, Green and Lawrence (1975) have demonstrated the importance of the process in the recruitment of epidermal cells by the developing eye in the hemipteran *Oncopeltus*.

An alternative interpretation of the *hw* data might invoke inhibitory rather than inductive fields (see Bryant, 1974) in normal disc development. By this interpretation the *hw/hw* constitution may block the inhibition of bristle production in surrounding tissue which normally occurs at the sites of the dorsocentral-forming cells. Additional evidence for such a mechanism comes from mosaic analyses of the mutant *achaete* (*ac*) (Stern, 1954; Claxton, 1969). This mutation results in a lack of the anterior dorsocentral bristle (*adc*) and in mosaics it generally behaves autonomously. However, occasionally an *adc* was observed to develop slightly out of place in closely adjacent *wild-type* tissue when its proper site was covered by *ac* tissue. An

obvious interpretation of this result is that in normal development a cell that becomes committed to forming an *adc* inhibits nearby cells from following the same differentiation pathway, whereas when *ac* tissue covers the region the inhibitory field is not established. Such "fine-tuning" mechanisms, involving inductive or inhibitory fields, might simplify pattern formation considerably.

Several authors have suggested that pattern formation in imaginal discs may involve yet another process, resulting in subdivision of the discs into several differently committed parts ('regional blastemae', 'organ districts', and/or 'compartments') (see Hadorn, 1966 ; Ouwenel, 1972; Garcia-Bellido et al., 1973). Evidence in support of this hypothesis again stems mostly from clonal analyses in *Drosophila*. The pioneering studies of Becker (1957) on the cell lineage relations in the developing eye suggested a dorsal/ventral segregation in the first larval instar such that clones initiated at that stage of development or later were never found to traverse a dorsal/ventral boundary in the adult eye. Garcia-Bellido et al. (1973) have suggested that by a series of successive segregations of this kind a mosaic of committed cells may be generated. Considerable data now exist which can be interpreted in terms of this notion of progressive compartmentalisation within a growing disc. Becker's (1957) early work on clonal analysis of the eye also suggested a later, possibly third instar, segregation of ommatidia from the remainder of the eye disc's derivatives. Segmental clonal restrictions occurring in the third instar have been demonstrated for the leg (Bryant and Schneiderman, 1969) and the antenna (Postlethwait and Schneiderman, 1971). It has been shown for the genital disc that the primordia for anal structures remain clonally



distinct from those for genital structures soon after disc determination (Ulrich, 1971; Nöthiger, 1972). Ripoll (1972) provided evidence for compartmentalisation, in the wing and Bryant's (1970) data for mesothorax indicated two compartmentalisation events there. The analysis of the wing disc derivatives has been extended (Garcia-Bellido et al., 1973) by an improved technique where rapidly growing clones are created in a slowly proliferating background with the aid of *Minute* mutants (see Brehme, 1941). This allowed the testing of compartmental restrictions even at the later stages of development when ordinary clones are too small. These authors interpret their data as being indicative of an organized sequence of successive restrictions which starts during embryogenesis and generates some fourteen clonally distinct compartments by the early third larval instar. Some of these compartment boundaries follow prominent cuticular discontinuities in the adult fly while others do not; but more interesting is the fact that certain region-specific transdeterminations associated with homeotic mutants follow precisely the same boundaries (Garcia-Bellido, 1975). This observation adds further support to the idea that for imaginal discs at least compartmentalisation is a significant process in normal pattern formation.

That patterning of a very detailed nature develops in imaginal discs prior to metamorphosis is demonstrated by disc fragment transplantation experiments. Ephrussi and Beadle (1936) devised a method for transplanting imaginal discs into larval or adult hosts for *in vivo* culture. In larval hosts the implanted disc grows and upon metamorphosis of the host secretes its own imaginal cuticle. Results of transplantation experiments of this kind agree with histological

and extirpation studies in the assigning of particular imaginal fates to each of the discs.

In the abdominal body cavity of an adult fly a transplanted disc simply proliferates as the hormonal milieu does not stimulate eversion and cuticle secretion. By transferring *in vivo* cultured discs from adult abdomen to adult abdomen, and testing implants at various stages by transferring to larval hosts, Hadorn (1963) has shown that the differentiation capacities of each disc are normally very stable.

Through testing fragments of mature discs in metamorphosing larval hosts by examining the cuticular structures which are secreted, various workers have been able to construct 'fate maps' for the different discs. A given disc fragment was found to give rise to a defined array of cuticular structures corresponding to a portion of the normal imaginal derivatives of the disc concerned. The complementary disc fragment differentiated the remaining structures. By fragmenting the mature disc in many ways and asking what each fragment produced when forced to secrete cuticle, detailed fate maps of some of the discs have been produced (see Table II for references). For instance, Schubiger (1968) was able to map the precise location of a single bristle, the edge bristle, on the foreleg disc. Since regulation was not observed in these experiments they suggested that the cells of a mature disc exhibit detailed patterning of a mosaic nature.

The regular and constant fates of particular disc regions, as defined by these fragment transplantation experiments, can however be altered by cell proliferation. Metamorphosis of a disc fragment can be delayed by transplanting it into a young larval host or by a two-step procedure in which it is first cultured in an adult abdomen and then

Table II. Some Key References to Fate Maps in Imaginal Discs

Genus	Disc	Investigator
<i>Drosophila</i>	Eye-antennal T	Vogt, 1946 Gehring, 1966 Ouweneel, 1970
	Wing	Hadorn and Buck, 1962 Murphy, 1972 Bryant, 1975
	Haltere	Loosli, 1959 Ouweneel and van der Meer, 1973
	Leg	Bodenstein, 1941
	Male Foreleg	Nöthiger and Schubiger, 1966 Schubiger, 1968
	Female Genital	Hadorn and Gloor, 1946 Hadorn and Chen, 1956 Ursprung, 1957
	Male Genital	Hadorn et al., 1949 Ursprung, 1959 Luond, 1961
	Abdominal Histo- blasts	Santamaria and Garcia-Bellido, 1972
<i>Calliphora</i>	Leg	Darchia, 1964
	Histoblasts	Emmert, 1972
	Wing	Sprey and Oldenhave, 1974
<i>Musca</i>	Female Genital	Dübendorfer, 1971
<i>Culex</i>	Leg	Spinner, 1969
<i>Formica</i>	Labial Gland	Emmert, 1969

(Updated from Gehring and Nöthiger 1973).

reimplanted into a larval host. In both cases the fragment grows through cell proliferation prior to differentiation even though it was derived from a mature disc. The cuticular patterns formed after such proliferation are determined by the origin of the fragment. Two outcomes are common: (1) duplication of anlagen already present in the disc fragment, whereby more or less symmetrical mirror-image patterns of adult structures differentiate, and (2) 'regeneration' of missing anlagen, such that sometimes the complete inventory of disc derivatives is differentiated. For instance, Gehring (1972) reported that an eye fragment from a mature eye-antennal disc, if allowed to grow, could differentiate the missing antennal portion; whereas an antennal fragment could only duplicate itself or regenerate a missing palpus. He also found that the wing blade portion of a wing disc after growth could differentiate the missing mesothoracic portion, but the mesothoracic fragment itself was restricted to duplication. Schubiger (1971) and Bryant (1971) have shown that for leg discs, proximal portions can regenerate while distal ones duplicate and medial parts can regenerate while lateral ones duplicate. Similar findings have been reported for other discs (reviewed in Bryant, 1975).

That the pattern differentiated depends upon whether or not cell proliferation occurred led Bryant (1974) to suggest the necessity of a more precise definition for the term 'determination'. According to his proposal this term should be restricted to mean only those commitments which show cell heredity, such as the decision to be a particular disc — leg or wing for instance. For nonheritable commitments made by cells, such as the decision to become a particular part of a disc

---

term 'specification'. This latter process, then, can be altered by cell proliferation as described above.

Wolpert's (1969) concept of 'positional information' can be applied to the detailed commitment (specification) of cells within a disc. The decision as to what part of the adult a particular cell of an imaginal disc will produce would then depend upon its position within the developing system rather than its clonal ancestry. Some experimental evidence supports this concept of differentiation according to position (see Wolpert, 1969, 1971). Bryant (1971) has presented results from disc fragment transplantation experiments in terms of a positional information model. He postulates that disc cells acquire positional information via a 'gradient of developmental capacity' which extends throughout the disc. Fragmentation surgery on discs can then be interpreted as removing a portion of the gradient. The model assumes that the cells in any disc fragment, upon proliferation, can only regenerate portions of the gradient lower than their original level in it. Regeneration of missing parts of a disc by a fragment would then be possible upon growth if the fragment included the high point of the gradient. A complementary fragment lacking the high point could only regenerate the gradient levels it already contained, and therefore would form a mirror-image duplication.

A similar gradient model has been proposed by Ouwens (1972). He suggests that disc size just prior to the time of differentiation specifies the reference points of a gradient and hence determines the positional information. A distinguishing feature of this model is that given sufficient time for proliferation a fragment should be able to re-

---

which could be interpreted as such 'duplicative regeneration' have been reported (van der Meer and Ouweneel, 1974; Bryant, 1975) but the necessary controls, in which both fragments of the same disc are analysed, were not reported.

The concept of specification of positional information via gradients is formally distinct from the notion of progressive compartmentalisation in that, in the former, growth and patterning are not temporally linked, while in the latter they are.

The results of defect experiments on imaginal discs and various mutant phenotypes have also been interpreted in terms of the models arising from the disc fragmentation experiments described above (see, for example, Postlethwait and Schneiderman, 1974). Waddington (1973) has categorized the pattern alterations that could theoretically arise and those obtained in *Drosophila* have been summarized by Garcia-Bellido (1972). Two types common in both defect experiments and mutant phenotypes are cuticular deficiencies and duplications.

Ultraviolet microbeam irradiation of early embryonic stages was found to induce imaginal cuticular abnormalities including deficiencies and duplications (Geigy, 1931; Nöthiger and Strub, 1972). X-irradiation of mid-larvae with a high dose (Waddington, 1942) and of late embryos and early larvae with a lower dose (Postlethwait and Schneiderman, 1973) also produced structural deficiencies and duplications in adult cuticle. A variety of chemical insults have been shown to produce similar effects. Exposure to the mutagen nitrogen mustard (Bodenstein and Abdel-Malek, 1949), the thymine analogue fluorouracil (Gehring, 1964), the RNA synthesis inhibitor actinomycin-D (Margulies, 1972), and borate (Sang and McDonald, 1954; Goldschmidt and Piternick, 1957) caused such abnormalities.

---

Heat shocks applied to pupae can induce deficiencies in the wing (Henke, 1947; Waddington, 1953a; Stumpf, 1959).

The wealth of mutants in *Drosophila melanogaster* (see Lindsley and Grell, 1968) provides ample examples of these particular pattern alterations. Mutants which are characterized by the absence of structures normally present in *wild-type* strains, such as eye facets, leg bristles, and wing regions are common. Deficiency phenotypes are often accompanied by duplicated structures. The mutants *crippled*, *extra organs*, and *reduplicated* cause legs or their distal segments to duplicate in mirror-image symmetry. Duplicated antennae and other head structures are produced in *erosion*, *antennalless*, *deformed-recessive-Luers*, *eyeless*, and other mutant stocks. The mutant *scalloped* shows wing deficiencies and thoracic pattern duplications, and even *vestigial* has been shown to exhibit duplicated thoracic structures (Waddington, 1953b).

One hypothesis to account for these pattern effects would invoke cell death in the imaginal discs. The importance of cell death in developmental systems has only recently come under scrutiny. In vertebrates it is of significance in normal morphogenesis (review by Sanders, 1966) and it has been suggested to be important in this capacity in the higher Diptera as well (Whitten, 1969; Sprey, 1971). In mutants with pattern abnormalities cell death might account directly for deficiencies and indirectly, through a secondary effect such as induced cellular proliferation (see Waddington, 1942; Schneider, 1972), for duplications. Surgical extirpation of cells from a disc might be equivalent in terms of its effect on the resulting cuticular pattern to localized cell death which effectively removes cells from the disc. Irradiation, chemicals, and heat shocks at appropriate levels are

---

known to kill cells and in these different circumstances cell death might be a common factor involved in the production of the abnormal patterns.

D. Fristrom (1968, 1969) has examined cytologically the discs of the wing mutants *vestigial*, *apterous-Xasta*, *Beadex*, and *cut*, and the eye mutants *Bar*, *eyeless*, and *lozenge*. These mutants are characterized by structural deficiencies in the adult cuticle. In all but *lozenge* she found evidence of cellular degeneration and reported "the onset and duration of degeneration and the number and distribution of dying cells were specific characteristics for each mutant." The presence of cell death in *Bar* eye discs has been confirmed by Michinomae and Kaji (1973) and in *vestigial*, *Beadex*, and *apterous-Xasta* wing discs by Sprey (1971). However, although this work suggests that cell death is often involved in the production of mutant phenotypes with cuticular deficiencies, a complete analysis of the spatial and temporal distribution of degenerating cells within the discs, and a thorough correlation of ultrastructural and histochemical evidence with the light microscopic observations, was not attempted. Such an analysis is critical for testing the hypothesis that cell death is responsible for the observed pattern alterations and for elucidation of the precise mechanism(s).

A genetic method for producing cell death at will would be useful for this and other studies. As Auerbach (1936) pointed out, and Suzuki (1970) and others have effectively demonstrated in the last decade, temperature-sensitivity in mutations is of considerable value in developmental studies. With this in mind, Russell (1974) has isolated a series of temperature-sensitive recessive cell lethal mutants in *Drosophila* which can be used as a genetic tool for the production of



cell death in developmental studies. These t.s. lethals were selected as ethylmethane sulfonate-induced X-linked mutants which fail to complete development at 29°C but are viable at 22°. Since cell-autonomy of the lethal effect was desirable for investigations involving mosaicism, 'twin spot' tests modified from the method of Stern and Tokunaga (1971) were carried out to identify 'cell lethals'. Mapping and complementation data have identified one such mutant, *ts726*, as an allele at the *suppressor-of-forked* locus (1-65.9) which, in a preliminary report, has been implicated as a ribosomal protein gene (Finnerty et al., 1973). More recently, Lambertson (1975) has reported that the transition from larval to adult ribosomal proteins is delayed in *su(f)* and another allele, *ts67*, at this locus.

In temperature shift experiments in which developing *ts726* larvae are exposed to the restrictive temperature for a 48-hour period, there results delayed pupariation, reduced survival to eclosion, and up to 80 per cent of surviving adults show cuticular deficiencies and duplications (Russell, 1974). The pattern abnormalities observed are similar to those described above for other mutants and experimental treatments, and to those produced in other t.s. cell lethal mutants (see Russell, 1974; Arking, 1975). In mosaics, the cell-autonomous lethal effect of *ts726* can lead to the nonautonomous expression of pattern duplications, and thus *ts726* fits the definition of a prepattern mutant.

Although such pattern abnormalities have been interpreted in terms of any number of models of pattern formation, in no case has a detailed study of the development of the imaginal discs been made. In order to test the various models it is essential that the intermediate stages in

appropriate for such a study for several reasons. Firstly, because of the high penetrance of the pattern abnormality phenotype (a feature not found in most of the other systems) histological observations can be correlated with cuticular observations. Secondly, the pattern abnormalities are simple to induce in large numbers with this mutant. And finally, the mutant tissue can be associated with various marker mutations for convenient clonal analysis. This thesis presents the results of histological and cytological investigations of *ts726* designed to ascertain the presence and distribution of cell death, its tissue specificity, and its relationship, if any, to the observed cuticular pattern abnormalities.

## MATERIALS AND METHODS

### *Drosophila* Stocks

Table III lists the mutations, chromosomal rearrangements, and stocks of *Drosophila melanogaster* utilized in the investigations reported in this thesis. The *wild-type* stock used was an *Oregon R* inbred line, which also constitutes the genetic background for the mutant stocks. Except where stated elsewhere, all stocks were from this laboratory. Detailed descriptions and references for the marker mutations can be found in Lindsley and Grell (1968). The temperature-sensitive lethal mutations are described briefly here.

Russell (1974) has described *ts726* thoroughly and his findings are summarized here. This mutant is an X-linked recessive lethal mutation recovered as one of a series of temperature-sensitive lethals induced with ethylmethane sulfonate. It is cell autonomous for lethality as determined by the twin spot test method of Stern and Tokunaga (1968). Its temperature-sensitive period (TSP) for lethality extends from the first larval instar into pupation, 22°C being the permissive and 29°C the restrictive temperatures respectively. When maintained continuously at 29°C immatures grow slowly, leave the food early, and eventually die predominantly as second and third instar larvae. If developing *ts726* larvae are pulsed for 48 hours at the restrictive temperature survival is reduced, eclosion is delayed one to four days, and deficiencies and duplications of imaginal cuticular patterns occur at high frequencies in surviving and pharate adults. As adults, females are sterile and males fertile at 29°C. The mutant is an allele at the *suppressor-of-forked* (*su(f)*, 1-65.9) locus.

Table III. *Drosophila melanogaster* Stocks, Mutants, and Chromosomes Employed

Mutation	Map Position	Phenotype	Reference
<i>y</i>	1 - 0.0	yellow adult body color and derivative structures	Lindsley and Grell (1968)
<i>w</i>	1 - 1.5	white eye color	"
<i>sn<sup>3</sup></i>	1 - 21.0	singed bristles, female-fertile allele	"
<i>car</i>	1 - 62.5	carnation-colored eyes	"
<i>su(f)<sup>1</sup>(1)ts67<sup>1</sup></i>	1 - 65.9	temperature-sensitive lethal. See text.	Dudick et al. (1974) Lambertson (1975)
<i>su(f)<sup>1</sup>(1)ts726<sup>2</sup></i>	1 - 65.9	temperature-sensitive lethal. See text.	Russell (1974)
Chromosome	Description	Reference	
C(1)RM	Compound reversed metacentric X-chromosome. Carries <i>y</i> , <i>su(w<sup>a</sup>)</i> , <i>w<sup>a</sup></i> and <i>bb</i> homozygous.	Lindsley and Grell (1968)	

<sup>1</sup>Referred to in this thesis as *ts67*.

<sup>2</sup>Referred to in this thesis as *ts726*.

The temperature-sensitive lethal *ts67* has been described by Dudick et al. (1974). It is one of two *ts* lethals induced in the same X-chromosome in a screen for *ts* lethal alleles of *lethal (1) myospheroid* (1-21.7) (Wright, 1968). In the *ts67* stock used here most of the mutagenized chromosome had been replaced by a cross-over to the left of *carnation* (1-62.5). The TSP for lethality reported for *ts67* begins in the second larval instar and ends at pupation, 22° and 30°C being the permissive and restrictive temperatures respectively. *ts67* has also been reported as an allele at the *su(f)* locus. Lambertson (1975), in an investigation of the ribosomal proteins of this mutant, has reported that the transition from the larval to the imaginal complement is delayed at 30°C.

#### Media and Rearing Conditions

Cultures were reared on the yeast-sucrose-agar medium of Nash and Bell (1968) (Appendix I) in quarter pint bottles or shell vials. Incubation temperatures were controlled to within one degree of the nominal value. Humidity was not controlled. Prior to egg collections flies were fed on the standard medium supplemented with a live yeast paste.

#### Temperature-Shift Experiments

In experiments where developing larvae were to be exposed to either 29° or 30°C for a defined period, cultures were initiated from eggs collected over a one hour period. Three to eight day old well-fed adults at 25°C were used for egg production. Prior to collections these adults were transferred regularly to fresh food in order to

prevent egg retention by the females. This method ensured uncrowded, initially synchronous cultures.

Following collection, eggs were immediately transferred from 25° to 22°C, the permissive temperature, and incubated until the time of administration of the restrictive pulse. Various pulse durations were used and these were controlled to within one quarter hour of the stated period. Larval ages in all cases were recorded in hours from the end of the egg collection period. Cultures were observed in the morning and evening daily and notes on their developmental progress were recorded.

Larvae sampled for dissection or histological examination were sexed while alive by observation of gonad size (Deperec and Kaufmann, 1950) as detected at X250 magnification with a dissecting microscope using transmitted light. The unsampled larvae in each culture were allowed to complete development at the permissive temperature (22°C). Adults, collected daily as they eclosed and aged for one day at 22°C to allow maturation of the imaginal cuticle, were stored in 70% ethanol until they were examined. By this method the cuticular morphology of adults could be correlated with microscopic observations made on the imaginal discs sampled from sibs in the same treatment.

Where  $C(1)RM/Y$  females served as internal controls, per cent survival to eclosion of males relative to females was determined as total males/total females X100, and delay in eclosion of males relative to females as  $\sum\{ix(M_i - F_i)\}$  days, where  $M_i$  and  $F_i$  represent the fractions of males and females eclosing on the  $i^{\text{th}}$  day of eclosion. For a sample calculation of mean male delay in eclosion consider the following

hypothetical situation:

Day of eclosion	<u>1</u>	<u>2</u>	<u>3</u>
Number of females eclosing	50	50	0
Number of males eclosing	0	50	50
Mean male delay = $\sum\{ix(M_i - F_i)\}$			
	= 1 (-.5) + 2(.5-.5) + 3(.5-0) = 1.0 day		

### Scoring of Imaginal Cuticular Patterns

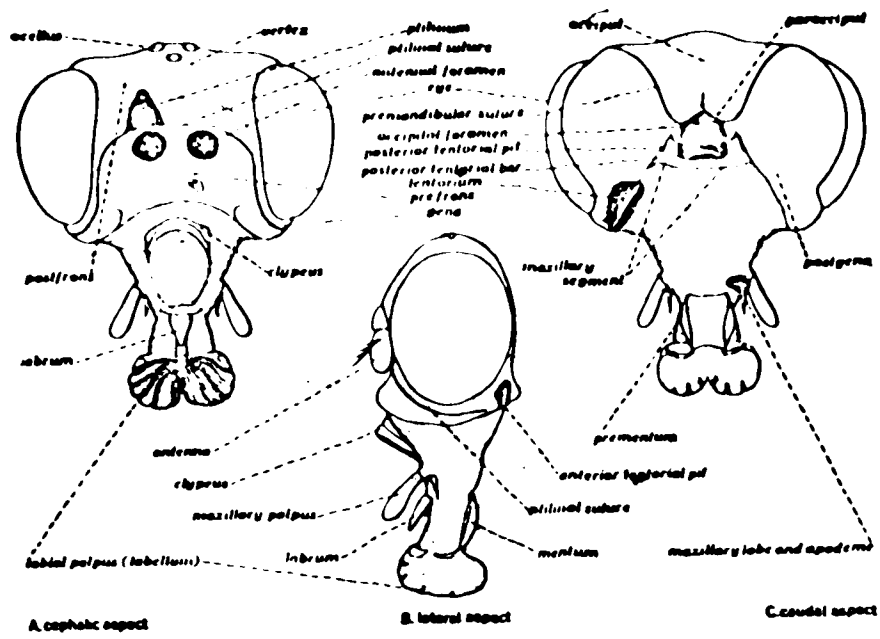
Flies were aged one day following eclosion to allow for cuticle maturation and then were scored for phenotypic abnormalities under the dissecting microscope at X80, 200, and 400 magnifications. Cuticular patterns of the head (see Fig. 1) were examined in most detail. Increased or decreased numbers of each of the major groups of bristles were scored including frontal, fronto-orbital, interocellar, and postorbital microchaetae and vertical, postvertical, ocellar, orbital and vibrissae macrochaetae. Roughness or reduction in number of compound eye facets, number of ocelli, and condition of maxillary and labial palps and antennae were noted as well. For the thorax, segmentation was examined and orientation and number of dorsocentral bristles on the scutum and scutellars on the scutellum were noted. Legs were scored for segmentation abnormalities, bristle orientation, and distal duplications of any size including those involving just the claw. In males the metatarsal sexcomb of the first leg was examined for abnormalities in tooth number and distribution. Wings and halteres were not examined in detail and only gross pattern abnormalities would have been detected. Abdomens were scored for abnormal segmentation and micro- and macrochaetal distributions and orientations. Genitalia were not examined.

Fig. 1. The head of *Drosophila melanogaster*.

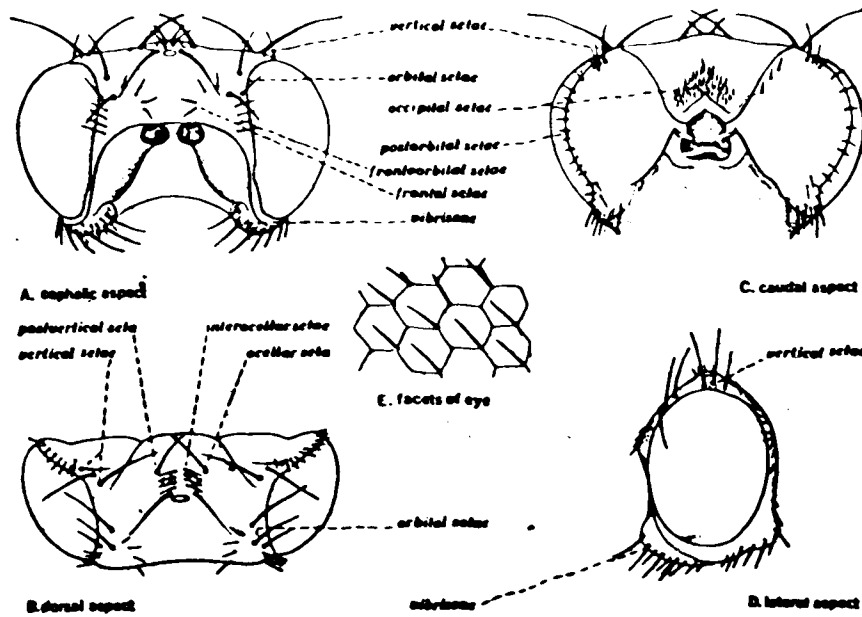
a. The head and mouthparts, general structure and areas,  
setae omitted.

b. Chaetotaxy of the head. (After Ferris, 1950).





a



b

A permanent record of cuticular abnormalities detected under the dissecting microscope was made in the following manner. From 70% ethanol, flies of interest were rinsed in distilled water, cooked in 1N NaOH at 60°C until only cuticle remained (about 30 minutes), then cut with microscissors into head, leg pairs, wings, halteres, and abdomen. These cuticular pieces were of convenient size for mounting in Gurr's water mounting medium between two 22 x 40 mm glass coverslips. In this way all the parts of an individual fly were kept together and could be viewed and photographed from both sides.

After adult eclosion had ceased for at least 24 hours from any particular culture the remaining pharate adults were carefully dissected from their pupal cases. Those with a completely secreted imaginal cuticle were scored phenotypically as described above.

### Histological Procedures

Larvae were collected for histological purposes by submerging a sample of the culture medium in 7.0% sodium chloride and decanting the floating immatures into a strainer. They were then rinsed with distilled water and sexed immediately in sterile modified insect Ringer (Ephrussi and Beadle, 1936) as described above. Only small groups of larvae, which could be handled quite quickly, were dealt with at any one time.

#### *Larval Histology*

Larvae were relaxed prior to fixation by bringing them to about 50° for two to five minutes in a solution of 4.0% (w/v) magnesium sulfate in sterile Ringer (Gottlieb, 1966). Relaxed larvae, their

bodies ~~distended~~, were then immediately fixed by one of the two following standard methods:

1. *Alcoholic Bouin Fixation.* The Bouin Duboscq (alcoholic Bouin) fixative has been recommended for tissues difficult to penetrate (Pantin, 1946). Its composition is as follows:

80% ethanol	150 ml
40% formaldehyde	60 ml
glacial acetic acid	15 ml
picric acid crystals	1.0 g.

Relaxed larvae were immersed in freshly prepared hot (60°C) alcoholic Bouin for 60 minutes and then were allowed to cool to room temperature. The posterior abdominal segment of each larva was then punctured with a dissecting needle to improve tissue penetration, and fixation was continued for another 18 to 24 hours at room temperature. At all times the fixative volume was kept large relative to the amount of tissue being processed (at least 20 ml of fixative for every 10 larvae). Because of the high alcoholic content of this fixative, dehydration was initiated with 95% ethanol following fixation.

2. *Chrome Alum Fixation.* The other fixation procedure employed was that of Gottlieb (1966) for the punctureless preparation of insect specimens, which employs a chrome alum fixative. The composition of this fixative follows:

40% formaldehyde	30
dimethyl sulphoxide	25 ml
propionic acid	2.0 ml
distilled water	238 ml
chromium potassium sulfate	3.0 g.

Relaxed larvae were immersed for 5 minutes in hot (60°C) fixative

which was then allowed to cool at room temperature for an additional ten minutes. Larvae fixed in this manner were rinsed in distilled water and dehydrated in a graded ethanol series beginning with 50 and proceeding through 70, 80, 90, 95 and 98.5% with one-hour stops in each concentration except the last where three one-hour changes were used. Alternatively, rinsed larvae were dehydrated in two one-hour changes each of 50 and 100% dioxane.

Where the ethanol series was used for dehydration specimens were cleared in two one-hour changes of toluene prior to infiltration with paraffin (Gurr's paraffin, m.p. 58°, ESBE Laboratory Supplies). Dioxane-dehydrated larvae required no special clearing step. Infiltration was accomplished by gradually increasing the paraffin concentration in a solution kept just above the melting point of the wax. This required about eight hours for the punctured specimens and 24 hours for the unpunctured ones, after which two final baths of pure melted paraffin (one hour each for the punctured specimens and 12 hours each for the unpunctured ones) were utilized. Individual larvae were then transferred to gelatine capsules containing fresh paraffin, cooled, and blocks were trimmed for sectioning as described in standard textbooks on histological techniques (see, for example, Humason, 1972).

Six or seven micron thick transverse sections were cut with a stainless steel knife mounted in a Leitz Minot 1212 rotary microtome. Serial sections were affixed to gellatinized microscope slides, deparaffinized in xylene, and hydrated in an ethanol series with two to three minutes in each stop. Hydrated sections were stained by one of the following three procedures.

1. *Delafield Hematoxylin (Progressive Method)*. Delafield hematoxylin was prepared as described in Humason (1972). Hydrated slides were stained for two to five minutes, checked for intensity of the stain under the compound microscope, and either returned to the stain if necessary or transferred to running water for three minutes prior to dehydration in 70, 95, and 98.5% ethanol (a few minutes each). Dehydrated stained sections were made permanent with a drop of Euparal and a coverslip.

2. *Gomori Trichrome Staining*. The trichrome mixture is composed of the following:

chromotrope 2R, C.I. 16570	0.6 g
fast green FCF, C.I. 42053, or	
light green SF, C.I. 42095	0.3 g
phosphotungstic acid	0.6-0.7 g
glacial acetic acid	1.0 ml
distilled water	100 ml.

Hydrated slides were slightly overstained with Delafield hematoxylin (three to five minutes), washed in running water five minutes, stained in the trichrome mixture five to twenty minutes, rinsed briefly in distilled water to remove excess stain, dehydrated in 70, 95, and 98.5% ethanol, and made permanent.

3. *Toluidine Blue Staining*. Hydrated slides were stained for about one and one-half minutes in freshly prepared one per cent toluidine blue O (C.I. 52040) in one per cent sodium borate, rinsed well in running water, dehydrated in 70, 95, and 98.5% ethanol (a few minutes in each) and mounted in Euparal. Photomicrographs were taken on Kodak Panatomic-X film using a Wild M20 photomicroscope.

### *Vital Staining of Discs*

1. *Acridine Orange Fluorescence Method.* Imaginal disc complexes and individual discs were prepared for whole mount fluorescence microscopy by the method of Spray (1971). Cephalic complexes (eye-antennal discs, brain, first and second leg discs) and wing complexes (wing, haltere and third leg discs) were dissected from larvae in freshly prepared sterile *Drosophila* Ringer (Bphrussi and Beadle, 1936). These were immediately stained with  $1.6 \times 10^{-6}$  M acridine orange (C.I. 46005) in Ringer for about five minutes. After a brief rinse in fresh Ringer, individual discs were gently covered with a coverslip suspended on spots of petroleum jelly to prevent squashing of the tissue. Photographs were taken immediately with a Zeiss Photomicroscope III equipped for fluorescence microscopy using exciter filters BG12 and BG38, barrier filter 44, and Kodak Tri-X film developed to 400 ASA.

2. *Trypan Blue Exclusion.* Discs obtained as described above were immediately stained with 0.5% trypan blue (direct blue 14) (C.I. 23850) in *Drosophila* Ringer for five to ten minutes, rinsed in fresh Ringer, gently covered with a coverslip suspended on spots of petroleum jelly, and photographed. Kodak Panatomic-X film was used in a Wild M20 photomicroscope.

### *Localization of Cell Death in Thin Sections*

Imaginal disc complexes and individual imaginal discs were prepared for thin (1/2 to 2 micron thick) sectioning as follows. Larvae were collected and sexed as described previously, then immediately were dissected in a solution consisting of one part Ringer to one part primary fixative (0.1M phosphate buffered 3% glutaraldehyde, pH 7.0 at 22°C).

Each imaginal disc complex obtained was then quickly transferred to an undiluted solution of the primary fixative. The initial fixation proceeded for two hours at room temperature (22°C). After two 15-minute rinses in buffer without fixative the discs were placed in the secondary fixative, 1% osmium tetroxide in the same buffer, for two hours again at room temperature.

Following this double fixation procedure the discs were washed twice in 10 ml phosphate buffer baths (fifteen minutes each) and transferred to 50% ethanol to initiate dehydration. A graded ethanol series consisting of 50, 70, 80, 90, 95 and 98.5% steps was used with 5-minute changes in each but the last where there were three 5-minute changes. Dehydration was followed by clearing in three 5-minute baths of propylene oxide and infiltration beginning with a one to one (v/v) solution of propylene oxide and Araldite epoxy resin (Ladd Research Industries Ltd.). The epoxy resin consisted of one part Araldite 502 resin to one part dodecenyl succinic anhydride, with 2% dimethylaminomethylphenol added to accelerate hardening. The tissue was left uncovered in the mixture overnight at room temperature so that the propylene oxide could gradually evaporate off. In the morning the tissue was transferred to fresh epoxy resin in rubber molds and polymerized at 60°C for 48 hours.

Blocks were trimmed with a sharp single-edged razor blade and half micron thick serial sections were cut with glass knives mounted in a Sorvall JB4 (Porter Blum) rotary microtome. Sections were collected in consecutive groups of fifteen and placed in drops of 10% aqueous acetone arranged in order on acetone-washed microscope slides. Evaporation of the drops over an alcohol lamp heat-affixed the sections to the slide in ordered groups.

Cooled slides were then stained by flooding with 1% toluidine blue O (C.I. 52040) in 1% sodium borate and heating over an alcohol lamp until steam rose from the stain. Caution was taken to avoid boiling of the stain which wrinkles the flattened sections. The slides were cooled to room temperature and rinsed in running distilled water for 20 to 30 seconds. They were then air-dried and checked under the compound microscope for stain intensity. The procedure was repeated if the sections were insufficiently stained. Otherwise a coverslip was affixed with Permount (Fisher Scientific), a toluene-based mounting medium, in which fading of the stain does not occur. The resulting permanent slides were later used for photomicroscopy. Kodak Panatomic-X film was used with a Wild M20 photomicroscope.

#### *Electron Microscopy*

A review of the general features of imaginal disc organization, based on epoxy sections, has been presented by Poodry and Schneiderman (1970). The ultrastructure of *Drosophila* imaginal discs has been described by Waddington and Perry (1960), Fristrom (1968, 1969), Perry (1968), Ursprung and Schabtach (1968, 1972), Gateff et al. (1969), Wehman (1969), Poodry and Schneiderman (1970), Wehman and Brager (1971), and Fristrom and Fristrom (1975). It is reviewed by Ursprung (1972).

Epoxy embedded imaginal discs prepared as described above for thin sectioning and light microscopy were also suitable for electron microscopy. The same blocks were used for both types of examination by taking adjacent thin and ultrathin sections. This procedure facilitated correlation of light and electron microscopic observations.

For the electron microscopy ultrathin sections (600-1000 Å), cut



with a diamond knife mounted in a Reichert OmU2 ultramicrotome and collected on Formvar-coated 100-mesh copper grids, were stained with 2% (w/v) aqueous uranyl acetate for three to four hours and then with 0.25% lead citrate (Reynolds, 1963) for two to four minutes. Staining with uranium was sometimes omitted. The preparations were viewed in a Philips 200 electron microscope. Electron micrographs were made from 35 mm Kodak Fine Grain Positive FRP 426 film.

Lysosomes are cellular organelles defined by morphological and histochemical criteria. Daems, Wisse, and Brederoo (1972) have reviewed the electron microscopic appearance of these cytoplasmic bodies and their progressive changes during sequential stages of cellular degeneration. Their criteria for the ultrastructural identification of these bodies, and the generally accepted functional interpretation, are summarized here for the reader's convenience. Although the continuous nature of lysosomal transition is stressed, three kinds of lysosomal bodies are described. 'Primary lysosomes' contain the degradative hydrolytic enzymes and ultrastructurally they appear as small (a micron or less at their widest point), generally oval, unit membrane-bound, electron-dense structures often exhibiting a narrow electron-faint "halo" beneath their limiting membrane. They fuse with cellular fragments to form secondary lysosomes. 'Secondary lysosomes' are active in the process of degradation and are 'fusion compatible' with primary or other secondary lysosomes until a 'maximum loading capacity' is reached when the indigestible residues have accumulated to such an extent that they saturate the digestive capacity of the lysosome. Early secondary lysosomes are larger than primary lysosomes and much more variable in

shape. They show morphological evidence of fusion, are membrane-bound, and often contain inclusions identifiable as various cellular components. More spherical bodies of fairly constant size with only degradation resistant remnants of cellular structures, such as mitochondria and nuclear membrane tracts, present within them are considered late secondary lysosomes. 'Residual bodies' (post-lysosomes, telolysosomes) are no longer enzymatically active in degradation but contain the remaining indigestible residues accumulated during the degradation/fusion cycle and are often egested from the cell following their formation.

#### *Acid Phosphatase Histochemistry*

Acid phosphatase, a marker enzyme for lysosomes, was stained histochemically at the electron microscopic level by a lead precipitation method (Gomori, 1952) modified for use on imaginal discs from the procedure of Maunsbach (1966). Imaginal discs were dissected from larvae in *Drosophila* Ringer, fixed for two hours at room temperature in 3% glutaraldehyde in 0.05 M sodium cacodylate buffer with 4.5% dextrose, and rinsed in fresh buffer for twelve hours. Incubation in the staining medium followed. It was prepared fresh as follows: 10 ml of distilled water was added to 10 ml of 1.29% aqueous sodium- $\beta$ -glycerophosphate (w/v) and 10 ml 0.1 M tris maleate buffer (pH 5.0) (see below). 20 ml 0.2% aqueous lead nitrate (w/v) were then added dropwise with continual stirring. The pH was adjusted to 5.0 with normal HCl. The tris maleate buffer consisted of 7 ml 0.2 M sodium hydroxide, 50 ml 0.2 M tris acid maleate (that is, 24.2 g tris amino methane plus 23.2 g anhydrous maleic acid in 1 litre distilled water) and 43 ml distilled water.

Incubation periods of 20, 40, and 60 minutes were used prior to

two 15-minute buffer rinses and post-fixation with 1% (w/v) osmium tetroxide in 0.1 M phosphate buffer with 1% sucrose (pH 7.2) for one hour. Following such treatment the tissue was rinsed twenty to thirty minutes in fresh phosphate-sucrose buffer, dehydrated in a graded ethanol series, cleared, embedded in Araldite, and sectioned, as described above, for electron microscopy. Both unstained and lead citrate stained ultrathin sections were viewed in the electron microscope. Again all electron micrographs were made from Kodak Fine Grain Positive FRP 426 film.

The detection of the enzyme by this method results when phosphate groups, released enzymatically from the substrate, react with lead ions and precipitate, thereby producing an electron-dense deposit. This deposit, when detected in the electron microscope, indicates the distribution of acid phosphatase activity within the tissue. As a control for the method, discs were incubated in medium lacking the substrate, sodium- $\beta$ -glycerophosphate.

#### Imaginal Disc Reconstruction

Imaginal disc complexes, serially-sectioned and stained as described above, provided material for reconstructions of eye-antennal, leg, and wing discs. Control (*ts726* at 22°C for 144 hours) and treated (*ts726* at 22°C for 96 hours and 29°C for an additional 48 hours) discs were reconstructed. Generally, only material in which cephalic and wing complexes remained together and intact upon dissection was used in these studies. Camera lucida drawings of entire sections (magnification 200 or 400 X) were made using a Wild M20 microscope equipped with a drawing

tube. In order that many discs could be constructed, the reduced section thickness ( $1/2 \mu$ ) required for adequate resolution of cellular detail necessitated the use of a section sampling system. The method fixed upon, after considerable familiarity with the sectioning of discs had been achieved, was as follows. One section per group of fifteen on a microscope slide was drawn after being selected as the first section free from wrinkles, folds, and staining artifacts observed when the group was scanned under the microscope. In this way individual sections, drawn in a random fashion from small consecutive groups, were used for the reconstructions.

Each disc was identified in the sections by means of a number of criteria including size, shape, position in the complex (Chen, 1929; Auerbach, 1936; Robertson, 1936), and other disc-specific features such as optic stalks attaching eye-antennal discs directly to the brain hemispheres, both first leg discs being enclosed in one peripodial membrane, third leg discs lacking a direct nervous stalk to the ventral ganglion, etc.

Evidence of cellular degeneration (see Results) was plotted on each drawing. It was quantified by using small x's to indicate the position of each late secondary lysosome and residual body (that is, the Type I bodies of Table XIII in the Results) on the drawing. Hence the relative extent and distribution of cellular degeneration in the selected sections was indicated by the number and position of x's on the camera lucida drawings. The information gathered from all the drawings associated with one disc was then plotted on a standard surface map of the disc to provide a reconstruction.

Each camera lucida drawing was represented by one dotted line oriented appropriately on the surface map of the disc. The number and position of  $x$ 's per drawing were indicated on the line. The number of parallel lines across the surface map, then, corresponded to the number of sections drawn, and depended upon the size of the disc and the angle at which it was sectioned.

The orientation of the plane of each section was determined as follows. The angle at which the disc complex was sectioned relative to its major axes (anterior/posterior, dorsal/ventral, and medial/lateral) was estimated. The fixed positions of the discs in a complex relative to one another, their paired nature, and other disc features such as characteristic regional folds of the epithelia, size and shape of the lumen, position of nervous connections (Chen, 1929; Auerbach, 1936) and adepithelial cells (Bryant, 1974), *et cetera* indicate the orientation of the sections and help identify what region of a disc one is viewing in a particular section. Cases where section orientation was subject to doubt were not used for reconstructions.

Orientation of disc sections and identification of particular discs is often more difficult if only part of the disc complex is present. For this reason use of such material was avoided.

## RESULTS

The work described here was designed to test and elaborate the hypothesis that cell death in the imaginal discs of *ts726* accounts for its cuticular effects in temperature-shift experiments. In particular I was interested in how the pattern of cell death discernible histologically might correlate with the ultimate morphological effects. To increase the scope of the investigations another temperature-sensitive lethal allele at the *su(f)* locus, not known to produce cuticular deficiencies and duplications, was also tested.

The results are presented in three sections. The first deals with general characterization of the two *ts* lethals, the second with the development of an appropriate histological system for the detection of cell death in imaginal discs, and the third with the patterns of death detected in *ts726* imaginal discs.

### Characterization of the *ts* Lethal Mutants *ts726* and *ts67*

#### *Temperature Sensitivity*

In light of the instabilities known to be associated with the phenotypes of many temperature-sensitive stocks (Igarashi, 1966; Smith, 1968; Suzuki, 1970; Mayoh and Suzuki, 1973; Wright, 1973; Kaufman and Suzuki, 1974), the two conditional lethal *Drosophila* stocks to be investigated histologically here were first tested for lethality.

The *wan*<sup>3</sup> *ts726*/C(1)RM/Y stock produces zygotes of four different genetic constitutions: *wan*<sup>3</sup> *ts726*/C(1)RM diploid metafemales, Y/Y nullo-X individuals, C(1)RM/Y females, and *wan*<sup>3</sup> *ts726*/Y males. Only

the latter two survive to adulthood and perpetuate the stock, the males expressing the conditional lethal, and their female sibs serving as controls. Egg samples, collected as described in the Materials and Methods, were transferred to either the permissive or restrictive temperature for incubation.

The *car ts67* stock produces only hemizygous mutant males and homozygous mutant females. Eggs were collected on medium supplemented with a live yeast paste in petri plates over which stock bottles were inverted. The eggs were counted and transferred to the appropriate culture temperature. After two days all the medium and larvae were transferred from the petri dish to a fresh bottle of food for further incubation.

The data presented in Tables IV and V indicate that both stocks were still temperature-sensitive for lethality at the time of testing. A similar test with the *p ts726* stock showed to be fully temperature-sensitive as well. The single male escaper at 30°C in the *car ts67* stock eclosed late and exhibited a "Minute-like" phenotype with several macrochaetae reduced in size or missing, both eyes rough, and a blistered wing.

#### *Stage-Distributed Mortalities at the Restrictive Temperatures*

Stage distributions of mortalities in *ts726* and *ts67* maintained at the restrictive temperatures were also examined. Daily records were kept of the developmental stages attained in each culture. For the *tsn<sup>3</sup> ts726/C(1)RM/Y* stock about half the larvae grew slowly at 29°C, left the food early, wandered on the sides of the culture bottle as immature larvae,

Table IV. Survival to Eclosion in *won<sup>3</sup> ts726/C(1)RM/Y* Cultures Reared at Permissive and Restrictive Temperatures

Culture temperature (°C)	Number of <i>won<sup>3</sup></i> males eclosed	Number of attached-X females eclosed	Relative % survival of Males to Females
22	241	312	77.2
29	0	299	0

Table V. Survival to Eclosion in *car ts67* Cultures Reared at Permissive and Restrictive Temperatures

Culture temperature (°C)	Egg count	Number of <i>car</i> males eclosed	Number of <i>car</i> females eclosed	Total survival (male + female) from eggs (%)
22	307	115	121	76.9
30	250	1 <sup>1</sup>	0	0.4

<sup>1</sup>"Minute-like" phenotype of lone survivor described in text.



and died after two to ten days, predominantly as second and third instar larvae as determined by examination of the number of teeth on their mandibular hooks (Bodenstein, 1950). Although they could not be unambiguously sexed because of their small size, presumably they represent the lethal-bearing males as these flies, eclosing without developmental delay were all females.

For *ts67* Dudick et al. (1974) have reported combined embryonic and larval mortality of 100% at 30°C. However, the *car ts67* stock tested here gave significantly different results, with mostly late larval death, but up to 25% pupal and considerable prepupal mortality. In contrast to *ts726*, larvae grew to normal or near normal size with only a slight developmental delay, and did not leave the food prematurely.

From these results, then, it is apparent that for these stocks at least, *ts726* showed an earlier effective lethal phase at the restrictive temperature. Such a result might be predicted on the basis of the published TSP's for the two mutants, since that for *ts726* begins earlier in development, and lasts longer than that for *ts67* (Russell, 1974; Dudick et al., 1974).

#### *Allelism Test*

As both *ts726* and *ts67* had been reported as mutations at the *su(f)* locus (Russell, 1974; Dudick et al., 1974) it was of interest whether or not they would complement with respect to lethality in a simple allelism test. With this in mind the F<sub>1</sub> progeny from reciprocal crosses between the homozygous mutant stocks, *ts726* and *car ts67* were cultured at 22° and 30°C.

Virgin females were mated in groups of about 20 to an equal number

of males from the other stock in vials. Eggs were collected over 4-hour periods on food supplemented with a live yeast paste. Vials with sufficient eggs were cultured at either 22° or 30°C. Although egg counts were not made, the developmental progress of each culture was recorded daily. Incubation continued until all survivors had eclosed. These were counted and scored with respect to sex and genetic markers expressed.

No F<sub>1</sub> progeny from these crosses survived to eclose at 30°C, whereas the predicted phenotypes appeared at 22°C (see Table VI). From these results it was concluded that, with respect to viability at the restrictive temperature, the two mutations fail to complement, and can be considered allelic.

#### *Phenotypic Characterization of the Mutant Stocks in Temperature-Shift Experiments*

##### *a) Various temperature treatments.*

The experiments described here were designed to characterize the two ts lethal mutants with respect to survival to eclosion, developmental delay, and effects on imaginal cuticular patterns in temperature-shift experiments, inasmuch as these characters might be related to the hypothesized cell death in the imaginal discs. The results of these experiments were then to be used to help determine which temperature treatment and mutant stock would be most suitable for the detailed histological investigations to follow. The results of these experiments are summarized in Tables VII and VIII.

Part A of Table VII confirms and extends the earlier work of Russell (1974) on 48-hour restrictive temperature pulses during larval life in

Table VI. Expected and Observed Results of Allelism Test Between *ts67* and *ts726*

Cross	A		B	
	♀♀	♂♂	♀♀	♂♂
parental genotypes	$\frac{car\ ts67}{car\ ts67}$	$\frac{y\ ts726}{y}$	$\frac{y\ ts726}{y\ ts726}$	$\frac{car\ ts67}{y}$
expected F <sub>1</sub> genotypes	$\frac{car\ ts67}{y\ ts726}$	$\frac{car\ ts67}{y}$	$\frac{y\ ts726}{car\ ts67}$	$\frac{y\ ts726}{y}$
expected F <sub>1</sub> phenotypes	wild-type	carnation	wild-type	yellow
Survival:				
a) assuming complementation	22°	+	+	+
	30°	+	+	-
b) assuming no complementation	22°	+	+	+
	30°	-	-	-
observed F <sub>1</sub> survivors	22°	105	98	178
	30°	0	0	0

Table VII. Results of Temperature-Shift Experiments With t6726

Temperature-Shift Treatment			Developmental stages present at initiation of pulse	Survival to eclosion (%)	Mean developmental delay (days)	Inaginal Cuticular Abnormalities of Survivors and Pharate Adults					
Temperature of pulse (°C)	Duration of pulse (hours)	Initiation of pulse (hours from end of egg collection)				Heads	Legs		Abdomens		
						Defl- cians	Defl- cians	Dupli- cations	Defl- cians	Dupli- cations	
<b>A 29</b>											
	48	48	late first and early second instar larvae	7.9	2.27	+	+	+	-	-	
	.	72	late second instar larvae	25.8	3.30	++	++	++	-	-	
	.	96	early third instar larvae	30.3	3.43	++	+	+	-	-	
	.	120	mid third instar larvae	13.2	1.18	++	-	-	-	-	
<b>B 29</b>											
	48	staged as per text	mature third instar larvae	0.2	not determined	+	-	+	-	++	
	.	.	white prepupae	14.0	.	+	-	-	-	++	
	.	.	tanned prepupae	53.8	.	+	-	-	-	++	
	.	.	young pupae	96.1	.	+	-	-	-	++	
<b>C 40</b>											
	3	24	early first instar larvae	48.1	0.22	-	-	-	-	-	
	.	48	late first and early second instar larvae	47.5	0.15	-	-	-	-	-	
	.	72	late second instar larvae	52.3	0.40	-	-	-	-	-	
	.	96	early third instar larvae	74.3	0.01	-	-	-	-	-	
<b>33</b>											
	15	24	early first instar larvae	92.3	0.42	-	-	-	-	-	
	.	48	late first and early second instar larvae	111.0	0.32	-	-	-	-	-	
	.	72	late second instar larvae	92.0	0.44	+	-	-	-	-	
	.	96	early third instar larvae	92.0	0.88	+	-	-	-	-	

-, essentially absent (i.e. frequency < 1%); +, present, frequency > 1 but < 10%; ++, present at high frequency, i.e. > 30%.


Table VIII. Results of Temperature-Shift Experiments With t<sub>67</sub>

Temperature-Shift Treatment			Imaginal C <sub>1</sub> Abnormality Frequencies in Survivors					
Temperature of pulse (°C)	Duration of pulse (hours)	Initiation of pulse (hours from end of egg collection)	Developmental stages present at initiation of pulse	Survival to eclosion (%)	Mean developmental delay (days)	Eye facet deficiencies	Other deficiencies	Duplications
unpulsed	22°C	control	not applicable <sup>1</sup>	84.7	not applicable	0	0	0
30	48	0	early embryos	68.9	0.40	0	0	0
30	48	24	early first instar larvae	67.0	0.55	0	0	0
30	48	48	late first and early second instar larvae	76.3	0.65	0.066	0	0.021
30	48	72	late second instar larvae	78.0	0.63	0.104	0	0.090
30	48	96	early third instar larvae	71.3	0.25	0	0	0
30	48	120	mid third instar larvae	66.2	0.19	0	0	0

<sup>1</sup>Frequencies calculated on a per 1/2-head basis.

*ts726*. The *wan<sup>3</sup> ts726/C(1)RM/Y* stock was used here and it can be seen that survival to eclosion of the mutant males relative to the control females was most significantly reduced in cultures pulsed at 48 (7.9%) and 120 hours (13.2%). However, mean developmental delay was not as great in these treatments as in those pulsed at 72 and 96 hours (Table VII) in which abnormalities of the imaginal cuticular patterns of surviving and pharate males were most frequent. These morphological abnormalities will be described in detail below.

The results in part B of Table VII illustrate the effects of restrictive temperature pulses administered late in the *ts726* TSP. It has long been known from histological studies (Ganin, 1876; Robertson, 1936) that the imaginal abdomen is formed from small nests of cells, abdominal histoblasts, which unlike imaginal discs only begin to divide much later in development at the time of pupariation. Since restrictive temperature pulses during *ts726* larval development did not affect the cuticle of the imaginal abdomen at significant frequencies, it was of interest to determine the effects of restrictive temperature treatments late in the TSP, at the time when abdominal histoblasts normally proliferate.

For this purpose staged larvae, prepupae, and pupae were subjected to heat treatments as follows. Cultures of *y ts726* larvae were incubated at 22°C until white prepupae were present. At this time, mature larvae (ML) and white prepupae (WP) were picked from the sides of the culture bottles (a fine artist paint brush well-moistened with distilled water was used) and placed in vials. Tanned prepupae (TP) and young pupae (P) were obtained by allowing WP to age 12 and 24 hours, respectively, at 22°C. Since the white prepupal stage only lasts from  to two hours at 22°C

this method provides an excellent means of developmental synchronization just prior to restrictive temperature pulsing.

The survival to eclosion of these staged animals following a 48-hour 29°C pulse is shown in Table VII and confirms that those animals spending a greater portion of the TSP at the restrictive temperature suffer the greatest mortality. Developmental delays were not determined. Cuticular effects were of two types, both designated as deficiencies in Table VII. In the heads and legs, individual macrochaetae were often missing, or grossly reduced in size, although the surrounding cuticle was not deficient. This was thought to be indicative of a block in bristle differentiation itself. In the abdomens of surviving flies these bristle deficiencies were again observed and in several cases involved the microchaetae as well. In the pharate adults imaginal abdominal cuticle was often entirely or partially absent, and frequently tracts of bristleless, trichomeless cuticle were observed. External genitalia, which are derived from the genital disc rather than the histoblasts, were invariably present. The deficiencies described above were observed throughout the treatments although the most severe effects were observed in those animals treated at the ML stage, and the incidence of missing abdominal microchaetae and abdominal cuticle declined with increasing age at treatment. Deficiencies and duplications of cuticular regions in the head, thorax, wings and legs were not observed in any of these treatments.

Part C of Table VII presents data on the effects of certain other temperature treatments on *ts726*. As it was known that this mutant failed to produce imaginal cuticular pattern alterations in experiments in which pulses much shorter than 48 hours at the restrictive temperature were

employed (Russell, 1974 and unpublished results), it was of interest to determine whether elevated pulse temperatures might effectively reduce the required pulse duration.

40°C pulses of 3, 6, 12 and 24 hours duration were administered to *wen<sup>3</sup> ts726/C(1)RM/Y* cultures beginning at 24, 48, 72 and 96 hours of development following egg collection. At this temperature pulses of 6, 12 and 24 hours duration proved virtually lethal to both mutant males and control females. In those cultures pulsed for 3 hours the males showed reduced survival to eclosion relative to their female sibs, ranging from 47.5 to 74.3%, and significant developmental delay, from 0.01 to 0.40 days (see Table VII). However, significant frequencies of cuticular abnormalities in surviving and pharate males were not detected.

In an attempt to increase the frequency of imaginal cuticular pattern alterations, 33°C treatments of 15 hours duration were administered to *wen<sup>3</sup> ts726/C(1)RM/Y* cultures at various developmental stages. Here survival to eclosion of mutant males was high and developmental delays, although small, were significant (see Table VII). However, again cuticular abnormality frequencies were very low, mostly below one per cent. However, in those males pulsed at 72 and 96 hours of development, eye facet deficiencies occurred at frequencies just less than 5% when pharate and surviving adult data were combined. The eye facet deficiencies recovered were predominantly of the type shown in Figure 2a, that is, reduced along the anterior margin adjacent to the antennae such that the eyes were kidney-shaped.

The results of less extensive investigation with the *oar ts67* stock are summarized in Table VIII. Here survival to eclosion was reduced

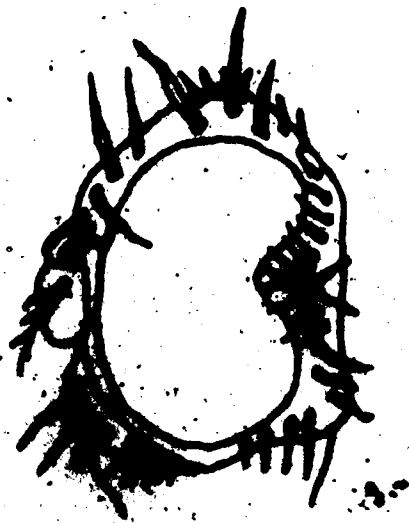


Fig. 2. Two eye facet deficiency types observed in restrictive temperature pulse experiments:

- a. anteriorly-indented eye from a *wsn<sup>3</sup> ts726* adult pulsed from 72-87 hours at 33°C
- b. posteriorly-indented eye from a *oar ts67* adult pulsed from 48-96 hours at 30°C.



7



only slightly by a 48-hour restrictive temperature pulse, and developmental delays were much smaller, compared to equivalent treatments with the *ts726* mutant. Cultures pulsed at 48 and 72 hours gave the highest survivals and greatest developmental delays as well as the only cuticular abnormalities. The latter consisted solely of eye facet deficiencies with occasional accompanying head bristle duplications. Two types of abnormal eyes were observed: (1) eyes lacking facets along the anterior margin (anteriorly-indented, as described above, see Fig. 2a) occasionally associated with duplicated (extra) fronto-orbitals and/or orbitals, and (2) eyes missing facets along the posterior margin (posteriorly-indented, see Fig. 2b) sometimes accompanied by duplicated postorbitals. Anteriorly-indented eyes were produced predominantly when the pulse was initiated at 72 hours, that is when second instar larvae were present in the culture almost exclusively, while posteriorly-indented ones occurred only in flies from those cultures which were pulsed at 48 hours, when late first and early second instar larvae are present (cf. report by Poodry et al. [1973] on a similar phenomenon with *shi*<sup>ts1</sup>). By the contingency Chi-square test there were significantly more anteriorly-indented eyes in the hemizygous males than in the homozygous females from the culture pulsed at 72 hours ( $P < 0.001$ ).

*b) Imaginal cuticular pattern abnormalities in ts726 pulsed from 96-144 hours at 29°C.*

With the results of these temperature-shift experiments in mind it was decided that 48-hour 29°C pulsed *ts726* larvae would be used for the histological investigations. Where whole larvae were to be sectioned both pulses initiated at 72 and 96 hours were selected as suitable, while for procedures requiring dissection of the imaginal discs from the larvae,

the size constraint suggested the 96 hour pulsed larvae as most suitable. Both these treatments result in reduced survival to eclosion, lengthy developmental delay, and high frequencies of cuticular deficiencies and duplications (see Table VII). The imaginal pattern alterations observed in surviving and pharate *ta226* adults following a 48-hour 29°C pulse initiated at 96 hours of development will now be described in some detail. The data presented here are from sibs of *y ta226* male and female larvae used in the histological investigations reported in the remainder of the Results. In this way cuticular and histological effects could be compared and correlated where possible.

A total of 111 eclosing flies and 15 pharate adults were scored for cuticular abnormalities as described in the Materials and Methods. Heads were examined in most detail and the data for them are presented in Tables IX, X and XI. With respect to the flies which survived the restrictive temperature pulse, it can be seen from Table IX that abnormalities of the head occur in early as well as late eclosing flies. However, when the type of abnormality is considered, there is a noticeable frequency difference associated with developmental delay. Eye facet deficiencies were the most common abnormality observed with an overall frequency of 46%. The various eye types and their frequencies are summarized in Table XI. In the eclosing flies some eyes (25 out of 222) were missing facets along their anterior border adjacent to the antennae (class 2 in Table XI, see Fig. 2a). These anteriorly-indented eyes were all found in flies eclosing within the first three days of the nine-day eclosion period (see Table XI) when only 35.1% of the survivors had eclosed. Thirty eyes were found to be deficient for peripheral facets just in the region of the eye adjacent to the vibrissae (class 3 in Table XI). This

Table IX. Overall Cuticular Defect Frequency for the Head with Respect to Day of Eclosion in 111 to 726 Survivors Following a 96-144 Hour Restrictive Temperature Pulse.

Day of development (from egg collection)	10	11	12	13	14	15	16	17	18
Day of eclosion	1	2	3	4	5	6	7	8	9
Number of flies eclosing	1	6	32	32	16	9	8	6	1
Frequency of 1/2-heads with any abnormality <sup>1</sup>	1.00	.75	.39	.38	.53	.17	.25	.25	.50

<sup>1</sup>See text for description of abnormalities and Tables X and XI for their frequencies and classification.

Table X. Cuticular Abnormalities of the Head in ts226 Survivors and Pharate Adults Following a 96-144 Hour Restrictive Temperature Pulse

Cuticular Structure <sup>1</sup>	Surviving Flies (n=111)			Pharate Adults (n=15)		
	normal	deficient	duplicated	normal	deficient	duplicated
eye facets <sup>2</sup>	120 (.54)	102 (.46)	0 (0)	13 (.43)	17 (.57)	0 (0)
frontals <sup>3</sup>	111 (1.00)	0 (0)	0 (0)	14 (.93)	1 (.07)	0 (0)
ocelli <sup>3</sup>	111 (1.00)	0 (0)	0 (0)	11 (.73)	4 (.27)	0 (0)
ocellars	220 (.99)	2 (.01)	0 (0)	26 (.87)	4 (.13)	0 (0)
postverticals	220 (.99)	2 (.01)	0 (0)	25 (.83)	5 (.17)	0 (0)
interocellars <sup>3</sup>	110 (.99)	1 (.01)	0 (0)	11 (.73)	4 (.27)	0 (0)
postorbitals	218 (.98)	0 (0)	4 (.02)	30 (1.00)	0 (0)	0 (0)
verticals	218 (.98)	5 (.01)	1 (.01)	28 (.93)	2 (.07)	0 (0)
orbitals	189 (.85)	5 (.02)	28 (.15)	23 (.76)	2 (.07)	5 (.17)
frontoorbitals	170 (.77)	1 (.01)	51 (.23)	22 (.73)	0 (0)	8 (.27)
vibrissae	213 (.96)	4 (.02)	5 (.02)	27 (.90)	2 (.07)	1 (.03)

<sup>1</sup>See Figure 4 for designation of structures; only those structures found to be abnormal in one or more heads are included in the table.

<sup>2</sup>See Table XI for classification and text for description.

<sup>3</sup>Scored per head rather than per 1/2-head.

Table XI. Classification of Eye Types in ts<sub>726</sub> Survivors and Pharate Adults from a 96-144 Hour Restrictive Temperature Pulse

Class	Eye Description <sup>1</sup>	Number (Frequency) of Eyes Observed	
		Surviving Flies (n=111)	Pharate Adults (n=15)
(1)	No facets missing (normal eye)	120 (.54)	13 (.43)
(2)	Anterior border facets missing	25 (.11)	1 (.03)
(3)	Facets adjacent to vibrissae missing	30 (.14)	0 (0)
(4)	Facets missing in both regions (2) and (3) above	40 (.18)	8 (.27)
(5)	Peripheral facets grossly deficient	2 (.01)	6 (.20)
(6)	Facets completely missing	5 (.02)	2 (.07)

<sup>1</sup>See text for details.

eye type began to appear in flies eclosing on the third day of eclosion, and became more frequent in flies eclosing towards the end of the eclosion period. Forty eyes were observed with both of the facet deficiencies described above (class 4 in Table XI). These occurred in flies which began to appear on the third day of eclosion and had all eclosed by the end of the fifth day. The seven remaining eye abnormalities were the most extreme defects, two being deficient for many facets thereby reducing the eye to a small number of centrally-located facets covering less than half the area of a normal eye (class 5 in Table XI), and five completely lacking facets (class 6 in Table XI). Six of these seven severe eye deficiencies occurred in flies eclosing on or after the fifth day of eclosion (see Table IX) when over 64% of the surviving flies had already eclosed. The remaining one had eclosed on the fourth day of eclosion. Thus, with respect to surviving 28726 flies, those with the most severe head abnormalities tend to eclose later.

Data for the heads of the 15 pharate adults scored are included in Tables X and XI. From Table X it can be seen that 57% of the eyes of the pharate adults were deficient. The various classes of eyes that occurred in the eclosing flies, save class 3 (Table XI), were also found in the pharate adults. However, the more severe eye defects which include classes 5 and 6 of Table XI, occurred at a much higher combined frequency in the pharate adults than in the eclosing flies ( $\chi^2_{(1)} = 7.83$  with Yates' correction,  $0.005 < p < 0.010$ ). Eye facet duplications into other regions of the head were never detected.

Although the eyes were the most frequently affected, other cuticular structures of the head were deficient or duplicated at lower frequencies (see Table X). Orbital and fronto-orbital bristles were found to duplicate



at the highest frequencies in eclosing flies, 0.13 and 0.23 respectively. These duplications were always associated with eye facet deficiencies. Vibrissae were duplicated in five of the 222 half-heads of survivors scored, while postorbitals and verticals were duplicated in four and one half heads, respectively. Ocellars, postverticals, interocellars, verticals, orbitals, fronto-orbitals, and vibrissae were found to be deficient only at low frequencies (see Table X). Data for the heads of the 15 pharate adults scored show somewhat elevated frequencies of duplication for certain structures such as ocellars, postverticals and interocellars. For other structures, such as frontals and ocelli, deficiencies were observed which had not been detected in the eclosing flies. In pharate adults, as in the eclosing flies, and with comparable frequencies, the fronto-orbitals and orbitals were the cuticular structures duplicated most often. More pharate adults would be required to elaborate these conclusions.

Thus, following a 96-144 hour 29°C pulse some imaginal structures, such as eye facets, become deficient but apparently never duplicate; others, such as postorbitals, duplicate occasionally but rarely or never are found to be deficient; and still others, such as verticals, orbitals, fronto-orbitals, and vibrissae, both duplicate and become deficient at easily detectable frequencies. Structures scored but not listed in Table X were not affected in any of the heads observed.

Frequencies of deficiency and duplication for each cuticular structure of the adult head were calculated using the combined data from the eclosing and pharate adults. These figures were then plotted on a fate map of the eye-antennal disc as shown in Figure 3. The eight most frequently observed cuticular patterns in all 252 half-heads scored are depicted in Table XII. Together, these eight patterns account for 225 or 89.3% of the half-heads

Fig. 3. Deficiency (upper figures) and duplication (lower figures) frequencies of imaginal cuticular structures derived from the eye-antennal disc in *ta726* pulsed from 96-144 hours at 29°C. Fate map modified from Gehring (1966) and Ouweneel (1970). AE, anterior eye factes; AN1-3 first, second and third antennal segments; ARS, arista; FO, fronto-orbita; LE, lower eye facets; LPO, lower postorbita; OB, orbital bristles; PLP, palpus; ROS, rostrum; UPO, upper postorbita; VER, vertex; VIB, vibrissae.

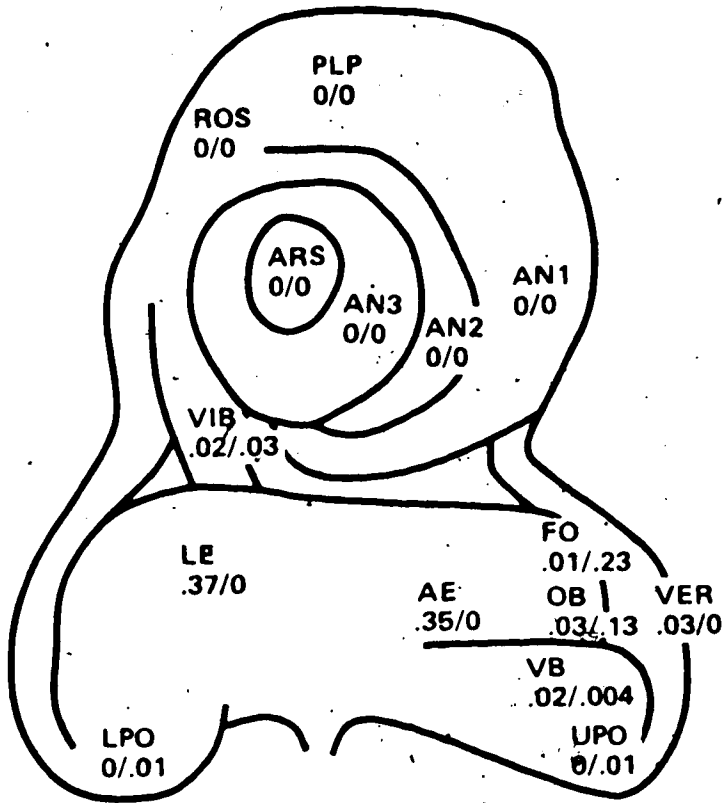


Table XII. Most Frequent 1/2-Head Types Observed in Surviving and Pharate Adults from *ts726* Pulsed at 29°C from 96-144 Hours of Development

Head Type	Imaginal Cuticular Head Structure Affected				Number (frequency) 1/2-Heads
	Eye Facets		Fronto-orbital Microchaetae	Orbital Macrochaetae	
	Anterior Region	Near Vibrissae			
A	+	+	+	+	129 (0.912)
B	+	-	+	+	28 (0.111)
C	-	-	++	++	24 (0.095)
D	-	-	++	+	16 (0.064)
E	-	+	+	+	14 (0.056)
F	-	+	++	++	5 (0.020)
G	-	-	+	+	5 (0.020)
H	-	+	++	+	4 (0.016)

Note: Cuticular structures indicated are those abnormal in these most frequent 1/2-head types.

+, normal structure; -, deficient or partially deficient; ++, duplicated or partially duplicated.

observed.

Cuticular pattern abnormalities in regions of the adult other than the head were much less frequent in these 96-144 hour pulsed cultures. They were generally found in adults with severe head defects and included bristle deficiencies from the scutellum and abdominal tergites, adventitious bristles in one abdomen and one labial palp, and nine leg abnormalities. The leg abnormalities consisted of one distally truncated first leg ending with the second tarsal segment, two distally truncated third legs, one ending with the tibia, the other with the basitarsus, two distally duplicated third legs, both involving the entire tarsus, and four third legs with abnormally short and/or thickened segments. The third leg, then, was involved in eight of the nine leg pattern abnormalities observed. Seven of the leg abnormalities occurred in the pharate adults, two in the eclosing flies.

### Histological Investigations

#### *Larval Histology*

Larvae from the *wbn<sup>3</sup> ts726/C(1)RM/Y* stock were fixed immediately following 48-hour 29°C pulses initiated 72 or 96 hours after egg collection. Females of the C(1)RM/Y constitution served as internal controls, while *wbn<sup>3</sup>* males from parallel cultures which experienced identical temperature treatment, and unpulsed *wbn<sup>3</sup> ts726* males, were studied along with the treated mutant males.

Comparative histological features of the thoracic region were ascertained from serial cross-sections of treated and control larvae. The presence or absence of the eye-antennal, wing, haltere and leg discs,

their positions, morphological appearance, and size, as well as the condition of various larval tissues, including the hypodermis, muscles, salivary glands, fat body, Malpighian tubes, oesophagus, brain and ring gland, were investigated.

Special fixatives and procedures (see Materials and Methods) were employed for these preliminary histological studies in order to obtain sections free from distortion of the internal spatial organization as it exists in the live larva. Because larval cuticle is resistant to penetration by histological reagents, attaining the precise degree of fixation desired has always been a problem. Normal fixation techniques involve puncturing the specimen at some time prior to, or during, fixation to circumvent the cuticular barrier. However, the subsequent drop in hydrostatic pressure often alters the internal spatial order of tissues and organs. Consequently, Gottlieb's (1966) punctureless procedure was employed, along with a modified technique employing puncture, and the results were compared.

Both fixation methods resulted in some variability from specimen to specimen and adjusting the fixation periods failed to eliminate the occasional poorly fixed specimen. This problem was slightly more prevalent with the punctureless procedure; however, with the fixation periods used, only a minority of larvae showed signs of unsatisfactory fixation such as cytoplasmic leaching and cell rupture. In general, gross morphology in the thoracic region was adequately preserved by both methods. The advantage of rapid fixation by the chrome alum fixative utilized in the punctureless method was negated by increased dehydration and infiltration time relative to the other procedure.

In general, it was found that relaxation of the larvae in warm 4% magnesium sulfate (w/v) prior to fixation proved effective in eliminating abnormal muscle contraction as indicated by excessive folding of the larval epidermis between muscle attachment sites.

Dehydration by both the traditional graded ethanol series and the two-step dioxane procedure was satisfactory. Where alcoholic Bouin's fixative was used ethanol dehydration was preferred, while chrome alum fixation could be followed by either form of dehydration with comparable results. The rapidity of the dioxane method, and the elimination of the necessity of a clearing step prior to infiltration, were found to constitute two advantages of this procedure.

Of the staining methods, the Gomori Trichrome procedure (see Materials and Methods) proved most satisfactory and is highly recommended. It consistently resulted in excellent tissue differentiation with uniform stain intensity throughout a section. (A representative example is shown in the light micrograph in Figure 4. Both hematoxylin and toluidine blue when used alone often resulted in uneven staining intensity throughout a section, and neither attained the degree of tissue differentiation achieved with the trichrome staining.

From this whole larva histology it was found that in all specimens examined basic larval morphology appeared normal. There was no evidence of larval tissue degeneration in either control or treated animals. Internal tissue organization remained unaltered and all disc pairs were consistently present. In these relatively thick sections the larval tissues from experimental and control specimens were indistinguishable.

Average imaginal disc size for the six pairs examined appeared slightly





Fig. 4. Gomori trichrome/hematoxylin-stained paraffin cross-section  
in the thoracic region of a *w<sup>bn</sup>3* larva illustrating excellent  
tissue differentiation.







reduced in the treated mutant males. This apparent size reduction was also reported by Russell (1974) who confirmed it by measuring eye-antennal and wing disc areas in whole mounts. An initial estimation of disc size carried out here, and based on counts of the number of consecutive sections in which a disc appeared, failed to confirm the apparent size reduction. However, data from epoxy sections of dissected discs, to be presented later, did suggest a size reduction for the eye-antennal disc at least.

The detection of cellular degeneration in imaginal discs using this thick-sectioned material proved less than satisfactory. Relative to larval tissues, which grow predominantly by cell enlargement (Bodenstein, 1950), these mitotically growing organs have very small cells, only 2-6  $\mu$  in diameter (Poodry and Schneiderman, 1970), and this small size in conjunction with thick sections results in poor cellular resolution under the microscope. The "pycnotic nuclei" recorded in the literature as evidence of cell death were difficult to discern as individual entities in this material, and only regions of fairly concentrated staining could be tentatively identified as regions of cellular degeneration. One such region of high intensity staining which appeared fairly consistently in treated mutant males and not in controls was a region in the eye disc adjacent to the brain hemisphere (see Fig. 5). However, it was felt that possibly only heavy concentrations of degenerating cells were being detected by this method, and since much thinner sections could not be produced with paraffin-embedded material it became apparent that other methods would have to be employed.

#### *Vital Staining of Imaginal Discs*

As an alternative to paraffin-sectioned material whole mount methods

Fig. 5. Hematoxylin-stained paraffin cross-section through the eye-antennal discs of a 96-144 hour restrictive temperature pulsed *won*<sup>3</sup> *ts726* larva. Notice region of intense staining in left eye and antennal discs. a, antennal disc; b, brain; e, eye disc; f, fat body; s, salivary gland. X 180.



were considered for the detection and localization of cellular degeneration in imaginal discs. The literature contains various reports on the utilization of stains for distinguishing live and dead cells (Luyet, 1957; King et al., 1959; Emmel and Cowdry, 1964; Gaff and Okong'O-Ogola, 1971; Sprey, 1971; DeRenzis and Schechtman, 1973). Two of these were selected and applied to restrictive temperature pulsed *ts226* imaginal discs.

a) *Acridine orange fluorescence method.*

Strugger (1949) considered acridine orange staining a specific test to distinguish living from dead cells. The acridine orange vitality test itself is briefly reviewed by Price and Schwartz (1956). According to Koenig (1965), basic dyes such as neutral red, methylene blue, azure B, and acridine orange, which stain cytoplasmic inclusions, are specific for lysosomes. For acridine orange, this conclusion was based primarily on *in vitro* studies of particulate fractions of rat brain, liver, and kidney. However, there are no data available as yet for the specificity of the dye in living cells (Smith-Sonneborn, 1974):

Sprey (1971) has reported a method using acridine orange fluorescence for detecting cell death in dissected whole imaginal discs (see Materials and Methods). He used the distribution of acridine orange fluorescing spots as an indication of the distribution of cellular degeneration in *wild-type Calliphora* discs and in *wild-type* and mutant *Drosophila* discs. Murphy (1974) deemed the method useful for detecting the presence of cell death in the discs of a series of X-linked lethal mutants in *Drosophila*.

My observations on imaginal discs from 144 hour-old unpulsed control, and 96-144 hour 29°C pulsed, *y ts226* larvae, prepared according to Sprey's procedure (see Materials and Methods) are summarized here. Considerable

variability in staining was observed from one disc to the next but, in general, eye-antennal, wing, haltere and leg discs from treated larvae showed increased frequencies of fluorescing spots relative to unshifted controls (see Fig. 6). Some of these spots appeared randomly distributed throughout the disc, similar to those seen in Figure 26 of Murphy (1974). Clumps of fluorescing spots which appeared to be localized in specific regions of the discs were detected; however, it was difficult to discern their precise location in the three-dimensional folded structure. Similarly, it could not be directly determined whether or not the peripodial membrane, which is cellular, contained any sources of fluorescence. The clumps of fluorescing spots were usually not apparent in control discs. However, in treated eye-antennal discs fluorescing spots and aggregates of spots were observed in both the eye and antennal portions of the disc, as shown in Figures 7a and 7b, with consistent staining in the facet-forming area. It could not be directly determined whether variability in pattern of fluorescence between discs was real or artifactual.

A serious problem encountered with the method was thought to arise from degeneration within a disc following dissection from the larva, which involves severing the nervous, tracheal and hypodermal connections, and possibly introduces other damage during handling of the disc. This problem may be reflected in the progressive increase in fluorescence observed from both control and treated discs over short periods of time under the microscope. Degenerative changes may or may not be uniform from disc to disc or from region to region within a disc, and hence have the potential of introducing artifacts into the data compiled. Possibly

Fig. 6. *y ta728* wing discs stained with acridine orange:

a. unpulsed control

b. 96-144 hour restrictive temperature pulsed

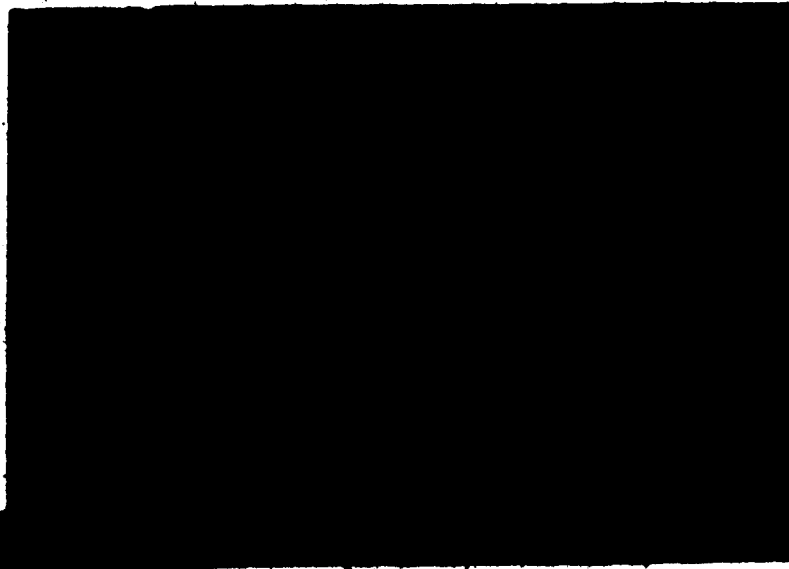
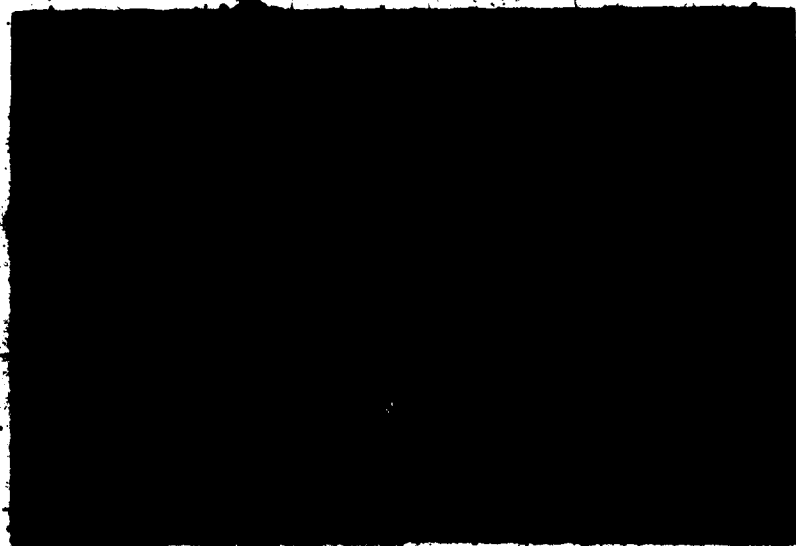




Fig. 7. Acridine orange stained 96-144 hour restrictive, temperature-pulsed  $\gamma$ -ts726 eye-antennal disc. Staining in eye facet and vibrissae-forming region.



fixation of the discs immediately subsequent to staining with acridine orange would eliminate this problem.

In their critical evaluation of the use of acridine orange for distinguishing live and dead cells, Wolf and Aronson (1961) concluded that the acridine orange stain is not a self-sufficient vitality test, but must be critically interpreted along with other data. They also indicated that concentrations of acridine orange greater than  $10^{-6}$  g/ml proved lethal to four types of cultured animal cells. The eye concentration used in Sprey's method for imaginal discs, about  $7.0 \times 10^{-7}$  g/ml, approaches this concentration. With these considerations in mind, and results which showed considerable variability from disc to disc with respect to distribution and concentration of fluorescing spots, ambiguity as to where in the disc the fluorescence arose, and uncertainty as to what in reality was stained, the necessity of an alternative approach more amenable to analysis was indicated.

b) *Trypan blue exclusion method.*

The other whole mount method investigated was modified from the trypan blue exclusion test for vital cells (Pappenheimer, 1917; DeRenzi and Schechtman, 1973) for use on dissected imaginal discs (see Materials and Methods). The underlying assumption of this method is that the differentially-permeable plasma membranes of living cells exclude the dye particles from their contents, while dead cells take up the dye resulting in a more or less diffuse distribution of stain within them (King et al., 1959).

Staining of whole discs, from unpulsed control and 96-144 hour 29°C treated *ts726* larvae, with trypan blue produced results which were

difficult to interpret. Often whole areas of a disc appeared to be densely stained while adjacent to these staining was less intense and other regions of the disc appeared unstained (see Fig. 8). Whether or not this variation in stain intensity was due to various stages of cell death as hypothesized by King et al. (1959) could not be directly determined; however, the distribution of stained areas was variable suggesting that they might simply represent positions of leakage in the basement lamina surrounding the disc, possibly due to damage inflicted during dissection. The frequent staining of areas of the discs adjacent to severed hypodermal stalks, and the failure to detect significantly different staining properties between pulsed and unpulsed *ts726* discs, lends support to the suggestion that the staining might be, at least in part, artifactual. Consequently the method was not pursued further at this point.

#### *Disc Morphology and Ultrastructure in Epoxy-Embedded Material*

The use of epoxy-embedded imaginal discs permits sections for both light and electron microscopy to be taken from the same disc. Hence, a correlation of ultrastructural detail and light microscopic localization of cellular degeneration could be attempted. Imaginal disc complexes from 144 hour old unpulsed control and 96-144 hour 29°C pulsed *y ts726* larvae were prepared as described in Materials and Methods.

The gentle buffered glutaraldehyde fixative used here produced excellent tissue preservation. Thin sections (0.5-2.0  $\mu$ ) stained with either of the basic dyes, methylene blue or toluidine blue, resulted in good resolution of cellular detail under the light microscope. Nucleoli

Fig. 8. First leg discs from a *y ta*<sup>228</sup> larva, stained with trypan blue after a 96-144 hour restrictive temperature pulse.



stained intensely, nucleoplasm resisted the stain, and cytoplasm stained lightly. The suggestion that these dyes bind predominantly to ribonucleic acid is supported by the studies of Gersh (1968) in which the staining of sections preincubated with RNAase was investigated. The presence of densely stained toluidine blue positive cytoplasmic inclusions in disc cells has been reported by Fristrom (1969) and Murphy (1974) as evidence of cellular degeneration. Fristrom describes these as degenerating bodies or cells while Murphy simply refers to them as dead cells.

a) *Unpulsed ts726 control discs.*

Unpulsed *ts726* control discs showed morphological features consistent with previous reports for *wild-type* discs at the same developmental stage (Poody and Schneiderman, 1970; Ursprung, 1972). Representative light (Fig. 9, a and b) and electron (Fig. 10, a and b) micrographs are presented here which confirm the *wild-type* appearance of control discs at the gross morphological and ultrastructural levels, respectively.

Under the light microscope serial sections revealed occasional small darkly-stained cytoplasmic globules or basophilia like those described by Fristrom (1969). These occurred in all discs of the wing and cephalic complexes and in the cellular portion of the brain hemisphere, but only at very low levels, that is, in less than one per cent of the cells present for the eye-antennal disc and even less frequently in the wing and leg discs. Their distribution in the disc epithelia appeared to be random. No evidence of localized concentrations of basophilia was detected in any of the late third instar control imaginal discs examined here.

Electron microscopic observations on control eye-antennal, wing,

Fig. 9. Light micrographs of toluidine blue-stained  $\frac{1}{2}$   $\mu$  epoxy sections of unpulsed control  $\mu$  ts726 discs. a, eye-disc; b, wing disc. a, X 800; b, X 720.





Fig. 10. Electron micrographs of unpulsed control *y ts726* eye discs.

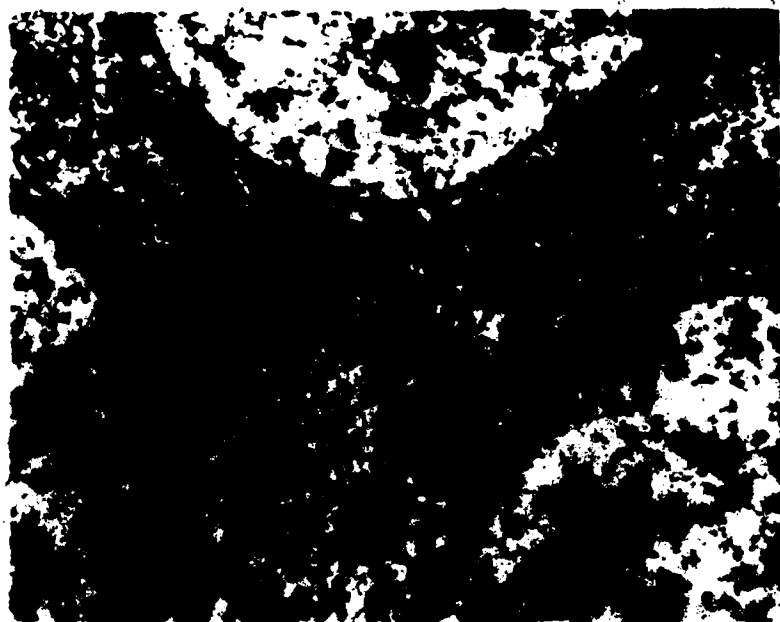
a. Low power, showing disc organization. X 2700.

b. Higher power. X 25,500.

bl, basement lamina; c, cytoplasm; l, lumen; mt, mitochondria; mv, microvilli; n, nucleus; pm, peripodial membrane; r, ribosomes



a



b

and leg discs support earlier reports (reviewed by Ursprung, 1972) that different discs, or regions within a disc, cannot be ultrastructurally distinguished at this developmental stage. Ribosomes were commonly found lined up along nuclear membranes (Fig. 10b), a feature not previously noted in disc cells, but evident in the published micrographs of several authors. As reported by Fristrom and Fristrom (1975), microtubules were not found to be prominent with this method of fixation.

*Effect of temperature pulsed ts726 imaginal discs*

Imaginal discs from ts726 larvae pulsed 96-144 hours after egg collection and prepared immediately for microscopy were also examined. Under the light microscope these showed the same basic-histological features as the unpulsed control discs except for one major difference, a dramatic increase in the frequency of occurrence of darkly-stained cytoplasmic globules in the pulsed discs (compare Figs. 9 and 11). This observation applied to all treated discs examined as well as to the cellular portion of the brain hemisphere. It was investigated further ultrastructurally in the eye-antennal disc.

Serial sections through eye-antennal discs revealed elevated frequencies of toluidine blue positive cytoplasmic spheres throughout the disc epithelium with dense concentrations occurring in particular regions. Their numbers rose from control levels averaging less than one per hundred disc cells to about 75 per hundred cells in some regions of concentration. In such regions one cell often contained more than one basophilic body in its cytoplasm. A sample of electron micrographs prepared from ultrathin sections taken in these regions of concentrated basophilia is presented in Figure 12, a and b. These demonstrate a variety




Fig. 11. Light micrographs of toluidine blue stained  $\frac{1}{2}$   $\mu$  epoxy sections of 96-144 hour restrictive temperature pulsed *y ts726* eye discs. Notice cytoplasmic basophilia. a, X 1280; b, X 1400.



Fig. 12. Electron micrographs of 96-144 hour restrictive temperature pulsed *ts726* eye discs in regions of concentrated cellular degeneration. l, disc lumen; n, nucleus; p, post-lysosome; s, secondary lysosome. a, X 7360; b, X 7820.


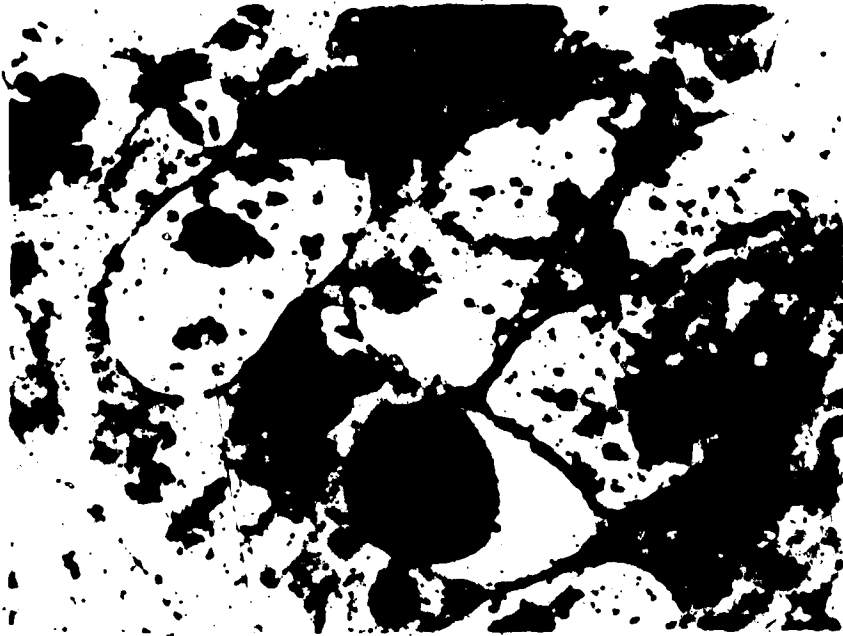






Fig. 13. Electron micrographs of 96-144 hour restrictive temperature pulsed *y ts726* eye discs. Acid phosphatase staining control. Incubation medium lacked substrate. Background precipitate evident. n, nucleus; s, secondary lysosome.  
a, X 12,160; b, X 12,160.



of electron-dense cytoplasmic bodies, like those described by Fristrom (1968, 1969) in various mutant discs, but uncommon in *wild-type* discs and here in unpulsed control discs. These were tentatively identified as lysosomal products on the basis of the morphological criteria.

#### *Histochemical Identification of Basophilic Bodies*

Histochemically, lysosomes are a distinct class of cellular organelles rich in acid hydrolase activity (see review by de Duve and Wattiaux, 1966). Of their various degradative enzymes acid phosphatase is the most commonly used as a marker enzyme for these organelles (Novikoff, 1963). Acid phosphatase staining sometimes marks Golgi and/or endoplasmic reticulum as well; however, these are distinguishable ultrastructurally from lysosomes.

A lead precipitation method for acid phosphatase staining was adapted and applied to cephalic complexes from 96-144 hour 29°C pulsed *ts726* larvae to determine the ultrastructural localization of the enzyme activity in the eye-antennal disc. Half micron sections were taken from various regions in the disc, stained with toluidine blue, and viewed under the light microscope. The observations were correlated with histochemical localization of acid phosphatase in adjacent ultra-thin sections viewed in the electron microscope.

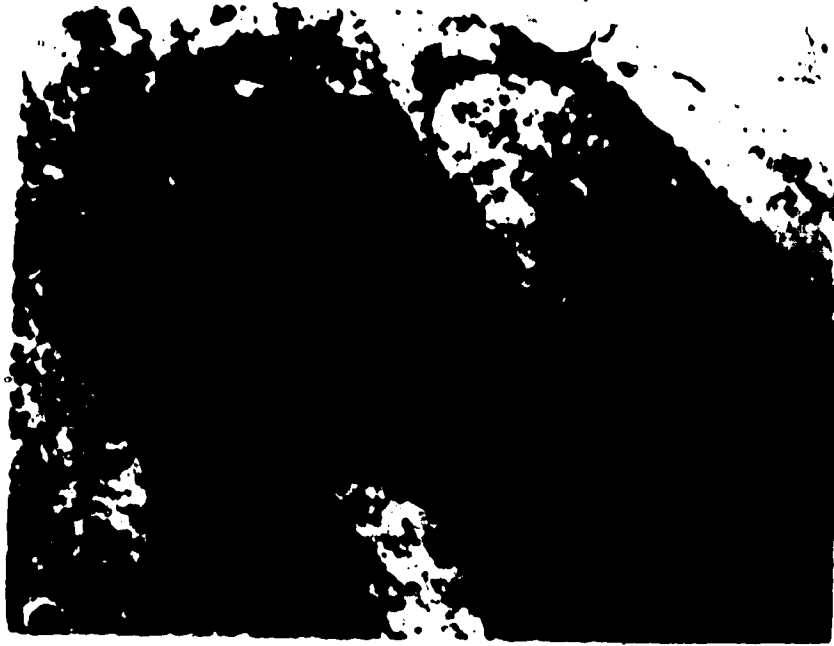
Sections from heat-treated discs used as controls for the staining procedure (incubated in medium lacking substrate) showed no cellular organelles marked with dense lead precipitate, although bodies tentatively identified as lysosomes on the basis of morphology were present in numerous sections (see Fig. 13, a and b), and background precipitate, uniformly distributed, was evident. Heat-treated discs incubated with

substrate generally yielded sections with specific organelles marked as strongly acid phosphatase positive (see Fig. 14, a and b). Their morphology and acid phosphatase activity identified them as primary and secondary lysosomes. Their staining is similar to that reported in other systems (Beck; Lloyd and Squier, 1972; Daems, Wisse and Brederoo, 1972). In Figure 14b partially marked and unmarked electron dense organelles can be seen. These represent late secondary lysosomes and residual bodies (post-lysosomes) respectively. The lack of acid phosphatase activity associated with the latter is consistent with other studies as well.

For the times tested, the influence of the duration of the incubation period (time spent in staining medium) was found to have only a slight effect on the acid phosphatase staining obtained. All three incubation durations produced satisfactory results. Lysosome staining was slightly less dense in several discs incubated for 20 minutes and background precipitation higher in some 60-minute ones. Hence, 30 minutes seemed to be a suitable incubation period in this system, and has independently been suggested as optimal for the localization of acid phosphatase in *Drosophila* salivary glands (Anastasia-Sawicki, 1974).

Two minor observations should be mentioned briefly. The first involved apparent acid phosphatase staining of the plasma membranes within an otherwise ostensibly representative disc in a sample incubated 60 minutes. Similar results in which acid phosphatase activity was apparently detected outside the lysosomal system have been previously reported (see, for example, Neil and Horner, 1964a,b). No other disc was found to illustrate this feature.

Fig. 14. Electron micrographs of 96-144 hour restrictive temperature pulsed *y ts216* eye discs stained for acid phosphatase. Substrate present. Notice post-lysosomes fail to stain. n, nucleus; p, post-lysosome; s, secondary lysosome. a, X 9860; b, X 12,160.



The other unexplained result was the observation of nuclear inclusions in two cells from discs incubated 20 and 60 minutes each (see Fig. 15). Both nuclei were observed in regions of the discs where secondary and post-lysosomes were numerous. The nuclear membranes appeared diffuse. From their size and appearance it was felt these inclusions might have been transversely-sectioned, closely aligned spindle microtubules of cells preparing for division.

Heat-treated discs, or portions of them, infrequently failed to produce evidence of acid phosphatase activity even when incubated with substrate. This occasional lack of staining was not associated with any one particular sample of discs. It is taken to represent artifact introduced by enzyme inactivation during preparation. As noted by Daems, Wisse, and Brederoo (1972), the consequence of the inactivation of enzyme activity by the pre-fixation procedure is that only the actual demonstration of enzyme activity has a positive value; the absence of demonstrable enzyme activity generally means either a real absence or that the pre-fixation procedure has so greatly diminished it that the cytochemical method is no longer sensitive enough to detect the remnants of activity. Alternatively, the pre-fixation may not have made the lysosomal membrane sufficiently permeable to the incubation medium (cf. Seeman and Palade, 1967).

With respect to the distribution of lysosomal types, primary lysosomes, identified by their size, morphology and extremely dense acid phosphatase marking were found throughout both treated and control eye-antennal disc epithelia and peripodial membranes. Secondary lysosomes were found to be concentrated in regions of treated discs which also had large numbers of residual bodies. These regions corresponded to parts

Fig. 15. Electron micrographs of nuclear inclusions (i) from a *y ts726* eye disc pulsed from 96-144 hours at the restrictive temperature.

a. Low power. X 9860.

b. Higher power. X 12,160.

s, acid phosphatase stained secondary lysosome





of the disc found to contain large numbers of toluidine blue staining cytoplasmic basophilia in  $1/2 \mu$  sections viewed under the light microscope. No concentrations of early or late secondary lysosomes, or of post-lysosomes, were found in control discs.

*Correlation of Light and Electron  
Microscopic Observations*

The observation of large numbers of cytoplasmic basophilia in certain thin sections from restrictive temperature pulsed *ts726* imaginal discs, along with the ultrastructural and histochemical demonstration of lysosomal products in the same regions, confirmed that observations made under the light microscope on serial sections stained with toluidine blue would be useful in localizing cellular degeneration within the discs. Therefore, to make a positive identification of the toluidine blue staining cytoplasmic bodies, adjacent thin and ultrathin sections were taken from epoxy blocks and prepared for light and electron microscopy respectively as described in Materials and Methods. These sections were sampled from six different eye-antennal discs and three different leg discs from 96-144 hour  $29^{\circ}\text{C}$  pulsed  $\mu$  *ts726* larvae.

Those cytoplasmic basophilic bodies stained with toluidine blue were classified into two more or less distinct categories. Type I bodies stained intensely, were spherical, and fairly uniform in size. Type II bodies stained less intensely and were more variable in morphology and size. From adjacent ultrathin sections 42 of the former, and 11 of the latter class were identified ultrastructurally. The results are presented in Table XIII and examples of adjacent sections are shown in Figures 16, a-e. From the table and figures it can be seen that those

Table XIII. Ultrastructural Identification of 53 Toluidine Blue Stained Cytoplasmic Bodies from Adjacent Sections in Restrictive Temperature Pulsed *y ts726* Eye-antennal and Leg Discs

Type of Body <sup>1</sup> and Number Observed		Ultrastructural Identification <sup>1</sup>
<u>I</u>	<u>II</u>	
0	0	primary lysosome
0	11	early secondary lysosome
19	0	late secondary lysosome
23	0	post-lysosome (residual body)
0	0	other (including artifacts)

<sup>1</sup>See text for description of cytoplasmic body classification and criteria for ultrastructural identification.

Fig. 16. a. Light micrograph of a thin toluidine blue-stained section of a leg disc from a 96-144 hour heat-treated *y ts726* larva. b-c and d-f. Electron micrographs of adjacent ultrathin sections of regions 1 and 2, respectively, in a.

t<sub>1</sub>, Type I body; t<sub>2</sub>, Type II body; l, late secondary lysosome; n, nucleus; p, post-lysosome; s, secondary lysosome.

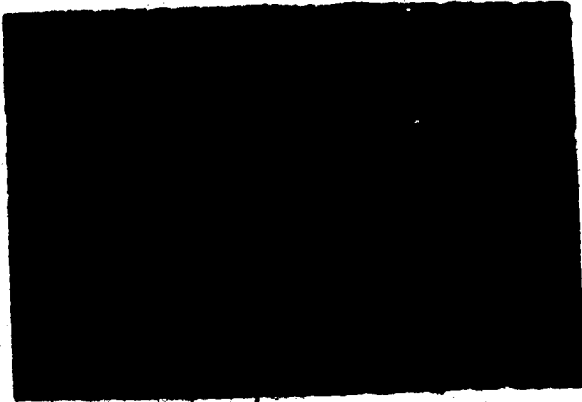
a, X 680; b, X 2900; c, X 12,160; d, X 2900; e, X 6080; f, X 12,160.



b



c



cytoplasmic bodies staining with toluidine blue in thin sections are virtually all secondary or post-lysosomes. Furthermore, it is apparent that the Type I bodies were, in fact, made up of late secondary and post-lysosomes, while all Type II bodies were early secondary lysosomes.

In other animal systems the presence of secondary and post-lysosomes (residual bodies) is indicative of cellular degeneration, and their number corresponds to the extent of cell death in a tissue (reviewed in Dingle and Fell, 1969). Hence their distribution in imaginal discs, as detected under the light microscope with toluidine blue staining, could be used to localize and quantify heat-induced cell death.

#### *Cell Death in ts67 Imaginal Discs*

For comparative purposes disc complexes from unpulsed 144 hour old control and 96-144 hour 30°C-pulsed *car ts67* larvae were also examined in epoxy sections under the light microscope. Four control and four treated intact wing/cephalic complexes were sectioned. Sections from various regions of treated leg, wing, and haltere discs revealed a level and distribution of cytoplasmic basophilia difficult to distinguish from that in controls. This level was equivalent to that found in *ts726* controls. Treated *ts67* eye-antennal discs showed a slightly elevated level of cytoplasmic basophilia relative to controls in both the eye and antennal portions. The frequency of cytoplasmic basophilia per disc cell was roughly two to four times that in controls. No localized concentration of these bodies was detected in any of the eight treated eye-antennal discs sampled and the significance of the slight increase in basophilia over control levels was not investigated further.

Density and Spatial Distribution of Cell Death  
in *ts726* Imaginal Discs

The extent and distribution of cell death in *ts726* imaginal discs was determined by reconstructing discs from serial thin sections as described in the Materials and Methods. Discs used were from sibs of *ts726* larvae which were allowed to complete development and then were scored for abnormalities of the imaginal cuticle. Control and 96-144 hour 29°C-pulsed eye-antennal, leg, and wing discs were reconstructed. The total number of degenerating bodies present in the sampled sections and the average frequency of bodies per section were determined for each disc reconstructed. Direct cell counts, in sections selected at random, provided an idea of the absolute frequency of cellular degeneration. The distribution of cell death within the disc epithelium was determined and plotted on a surface map for each reconstructed disc. This allowed comparison of the patterns of cell death found in the various reconstructions with the cuticular abnormality frequencies observed in the adults (described above).

*Extent of Cellular Degeneration in Control and 96-144  
Hour Heat-Treated ts726 Discs*

The total number of Type I basophilic bodies (late secondary and post-lysosomes, see Table XIII) found in the sections sampled from each disc were recorded in the reconstructions (to be presented later). Only Type I bodies were enumerated as these were uniform in morphology, stained intensely with toluidine blue in thin sections, and were thought to be indicative of an advanced stage of cellular degeneration. Their numbers provided an estimate of the extent of cellular degeneration



in each disc.

The data obtained for the various discs reconstructed are presented in Table XIV. The number of sampled sections (one from each consecutive group of 15) and the total number of Type I bodies for each reconstructed disc are given. Excluding reconstructions of incomplete discs, the total number of Type I bodies ranged from 13 to 41 for control ( $\bar{x} = 28.00$ ) and 57 to 319 for heat-treated ( $\bar{x} = 137.17$ ) eye-antennal discs. Application of the  $t$ -test gave  $t_{(11)} = 2.47$  which confirmed that there was significantly more cellular degeneration in the heat-treated sample ( $0.025 < p < 0.05$ ). Similarly, in the combined first and second leg disc data the observed number of degenerating bodies in the discs from 29°C-pulsed larvae ( $\bar{x} = 24.20$ ) was found to be significantly greater than in controls ( $\bar{x} = 6.40$ ) ( $t_{(13)} = 4.05$ ;  $0.001 < p < 0.005$ ). In the control wing discs sectioned very few Type I bodies were detected. But again this frequency increased dramatically in the heat-treated discs. However, *ts726* failed to produce high frequencies of pattern abnormalities in the imaginal cuticle derived from the wing disc. Consequently, only a few reconstructions of this disc were made.

As it was possible that variability in disc size itself was influencing the total number of Type I bodies observed above, this factor was roughly estimated as follows. Since one section out of each consecutive group of 15 had been sampled for reconstruction purposes, and section thickness was maintained constant throughout, the number of sampled sections required to traverse the entire disc provided an approximation of relative disc size. This estimate was, of course, affected not only by actual disc size, but also, since discs are not perfect spheres, by

Table XIV. Imaginal Disc Reconstruction Data

Disc Designation	Treatment	Disc Designation	Number of Sections Sampled (S)	Total Number of Type I Bodies (D)	Ratio D/S
Eye-antennal	control	a	25	13	0.52
		b	23	20	0.87
		c	47	41	0.87
		d	44	34	0.77
		e	28	21	0.75
		f	25	35	1.40
		g	21	32	1.52
		h(I) <sup>1</sup>	(20)	(9)	0.45
		i(I)	(21)	(10)	0.48
	29°C-treated	a	27	218	8.07
		b	26	319	12.27
		c	18	57	3.17
		d	18	69	3.83
		e	13	101	7.77
		f	16	59	3.69
Leg <sup>2</sup>	control-1	g(I)	(30)	(106)	3.53
		h(I)	(22)	(64)	2.91
		i(I)	(7)	(51)	7.29
		j(I)	(7)	(66)	9.43
Leg <sup>2</sup>	control-1	a	17	4	0.24
		b	14	4	0.29
		c	14	3	0.21
		d	13	2	0.15
		e	21	9	0.43
		f	22	13	0.59

<sup>1</sup>(I) indicates reconstruction incomplete (sections missing).

<sup>2</sup>Both first and second leg discs sampled (-1 and -2 respectively under treatment).

(Cont'd)

Table XIV (cont'd)

Disc Designation	Treatment	Disc Designation	Number of Sections Sampled (S)	Total Number of Type I Bodies (D)	Ratio D/S
	control-2	g	17	0	0
	"	h	20	4	0.20
	"	i	23	11	0.48
	"	j	26	14	0.54
	29°C-treated-1	a	19	21	1.11
	"	b	18	14	0.78
	29°C-treated-2	c	20	37	1.85
	"	d	16	30	1.88
	"	e	16	19	1.19
	"	f(I)	(20)	(12)	0.60
Wing	control	a	28	2	0.07
	29°C-treated	a	36	146	4.06
		b	26	124	4.77

the plane of section. To minimize this latter source of variation an attempt was made to obtain transverse sections of the disc complexes.

For eye-antennal discs, considerable variability was observed in the number of sampled sections for both control and treated discs (see Table XIV). The effect of the treatment on disc size was roughly estimated by comparing the mean number of sections for control and treated discs by the *t*-test. Incompletely sectioned discs were omitted from the calculation. By this method, treated eye-antennal discs had significantly fewer sections, with a mean of 19.67, as compared to 30.43 for controls ( $t_{(11)} = 2.34, 0.025 < p < 0.050$ ). The result of the same test on the combined first and second leg values was non-significant (control  $\bar{x} = 18.70$ , treated  $\bar{x} = 17.80$ ;  $t_{(13)} = 0.56, p > 0.5$ ).

The last column in Table XIV presents the average number of degenerating bodies per section scored for each reconstruction. This ratio provides an estimate of the extent of degeneration which minimizes the effect of differences in disc size. Here again the values are significantly greater for the treated discs. Their means and standard errors, incomplete reconstructions included, are as follows:

	<i>Control</i>	<i>Heat-treated</i>
eye-antennal	0.85±0.13	6.20±1.02
leg	0.31±0.06	1.24±0.22

The final feature of the data in Table XIV, which should be noted, is that both control and treated eye-antennal discs showed more cellular degeneration than the corresponding leg discs. This was apparent from both the total number of degenerating bodies and the frequency of these bodies per section.

In order to relate the extent of degeneration to the number of cells present, sections were sampled at random from control and heat-treated eye-antennal discs, and direct cell counts were made. Epithelial cells of the disc proper and peripodial membrane were counted, while nerve, tropholar, and adepithelial cells were not included. In addition, any cell not sectioned through the nucleus was omitted from a count. The exact number of Type I bodies in each section sampled was also recorded. When a section traversed both eye and antennal portions of a disc, each region was counted separately. The data obtained are presented in Table XV. From these it can be seen that the ratio of degenerating bodies to live cells has a much extended and elevated range in the heat-treated discs. This applies for sections in both the eye and antennal portions of the disc. The mean values and their standard errors are as follows:

	<i>Control</i>	<i>Heat-treated</i>
antenna	0.006±0.002	0.045±0.015
eye	0.005±0.003	0.211±0.060

#### *Spatial Distribution of Cell Death in ts726 Imaginal Discs*

##### *a) Wing discs*

Sections through control (*y ts726* 144 hours at 22°C) wing discs showed very few Type I cytoplasmic basophilia. For example, the reconstruction presented in Figure 17 revealed only two Type I bodies in 28 sampled sections. Other control wing discs sectioned showed similar low levels of cell death. Two heat-treated discs (96-144 hours at 29°C) were reconstructed and the results are presented in Figure 18. These demonstrate the greatly increased frequency of cell death over controls, and its non-uniform distribution, which differed in these two discs.

Table XV. Number of Cells and Type I Bodies in Sections Sampled from Control and Heat-Treated *ts726* Eye-antennal Discs

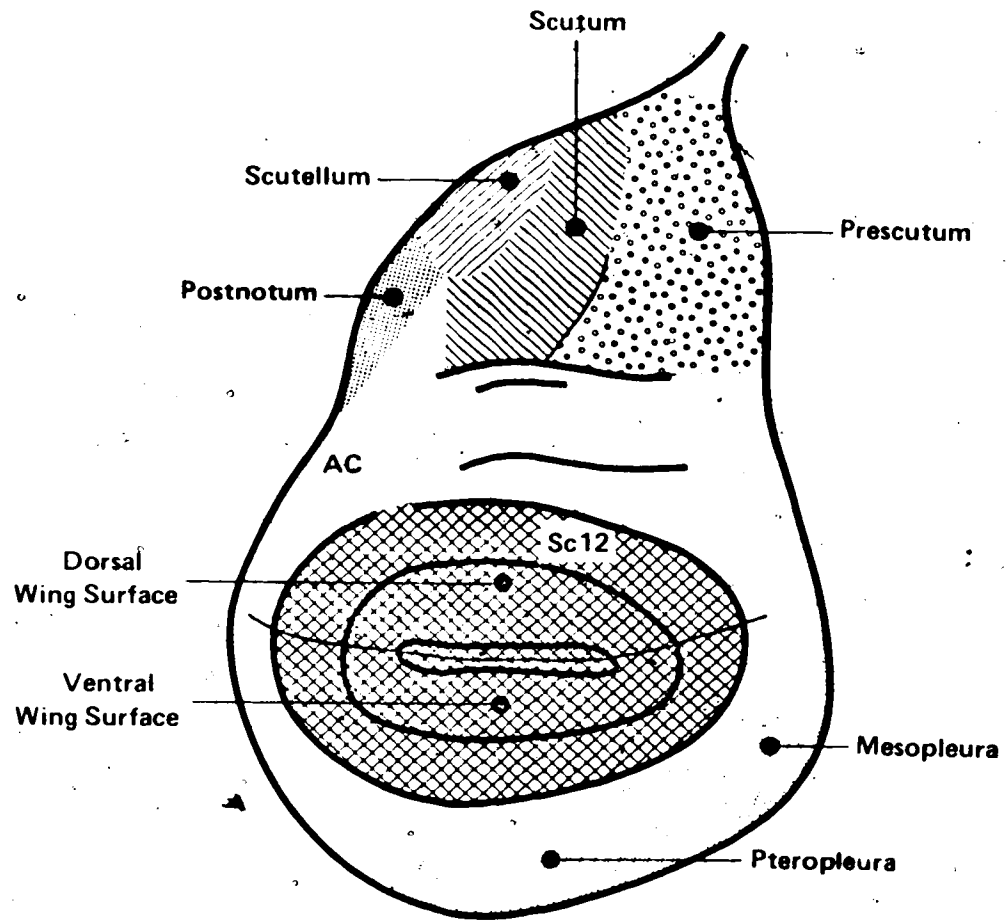
Disc Designation	Cell Count (C)	Number of Type I Bodies (D)	Ratio D/C
		<i>Antenna</i>	
Control-2	221	1	.005
" -2	229	0	<.004
" -11	339	2	.006
" -11	212	1	.005
" -12	161	0	<.006
" -12	139	2	.014
" -13	77	1	.013
" -13	48	0	<.021
" -13	288	3	.010
" -14	173	1	.006
Treated-1	111	9	.081
" -6	176	4	.023
" -40	120	3	.025
" -40	311	0	<.003
" -40	43	2	.047
" -60	157	15	.096
		<i>Eye</i>	
Control-2	186	0	<.005
" -2	301	1	.003
" -11	366	3	.008
" -11	317	2	.006
" -12	198	0	<.005
" -12	150	0	<.006
" -13	191	1	.005

Table XV (Cont'd)

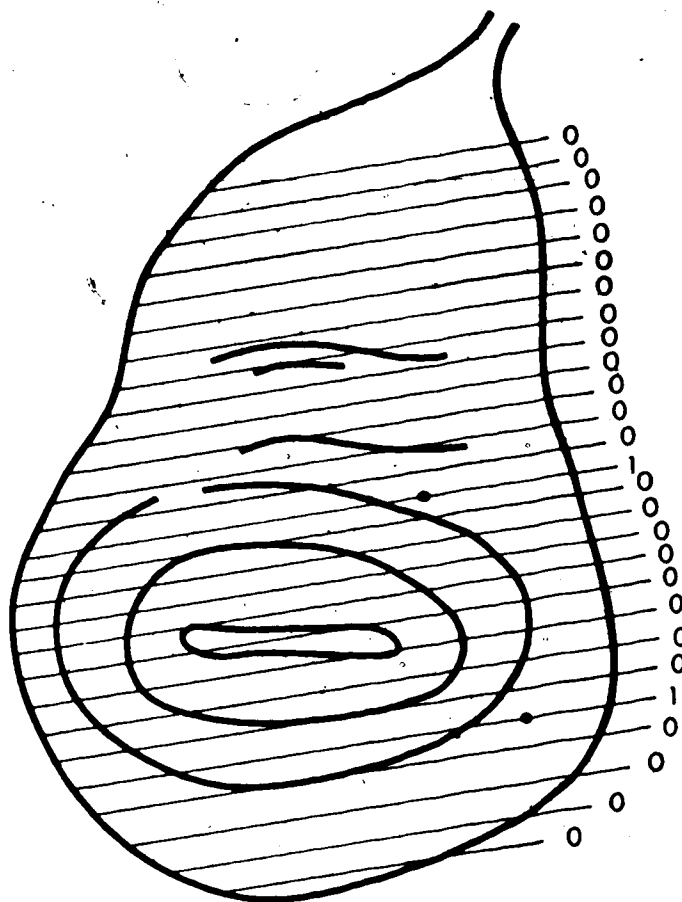
Designation	Cell Count (C)	Number of Type I Bodies (D)	Ratio D/C
Control-13	69	0	<.014
" -13	152	5	.033
" -13	180	0	<.005
" -14	203	0	<.005
Treated-1	73	24	.329
" -1	95	9	.095
" -6	131	74	.565
" -6	120	56	.467
" -9	51	3	.059
" -21	87	15	.172
" -22	147	20	.136
" -22	133	15	.133
" -40	168	11	.065
" -40	131	1	.008
" -40	253	20	.079
" -60	165	40	.242
" -60	294	39	.133

- Fig. 17. a. Imaginal fate map of wing disc, simplified from Bryant (1975). AC, axillary cord of wing hinge; Scl2, twelve sensilla campaniformia between the first and second septa of the proximal dorsal radius.
- b. Control *ts726* wing disc reconstruction. Lines indicate positions of sampled sections. Figures represent the number of Type I cytoplasmic basophilia per section. S, number of sampled sections; D, total number of Type I bodies in sampled sections.





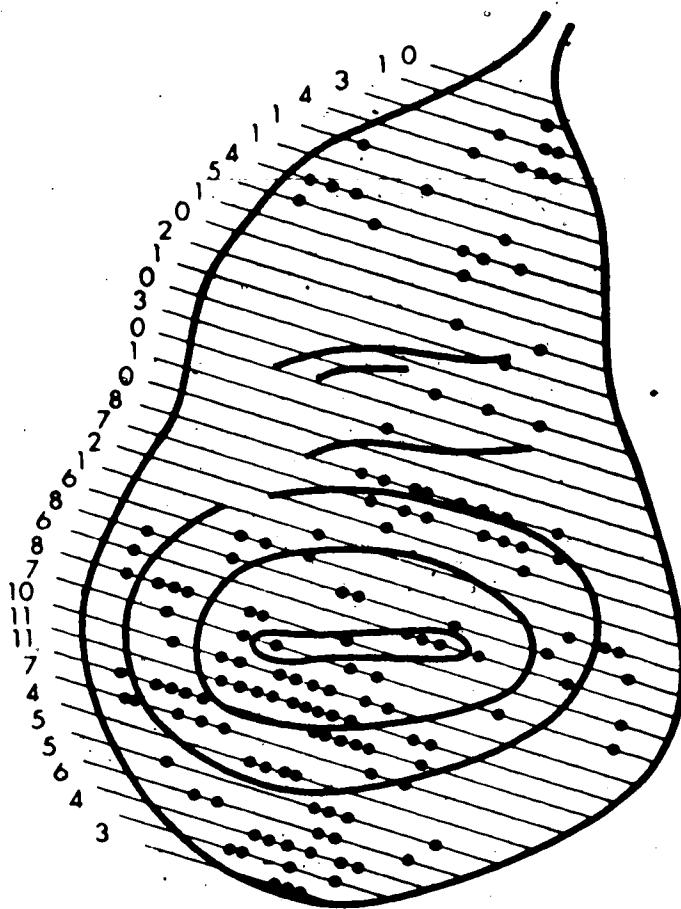
(b)



S = 28  
D = 2

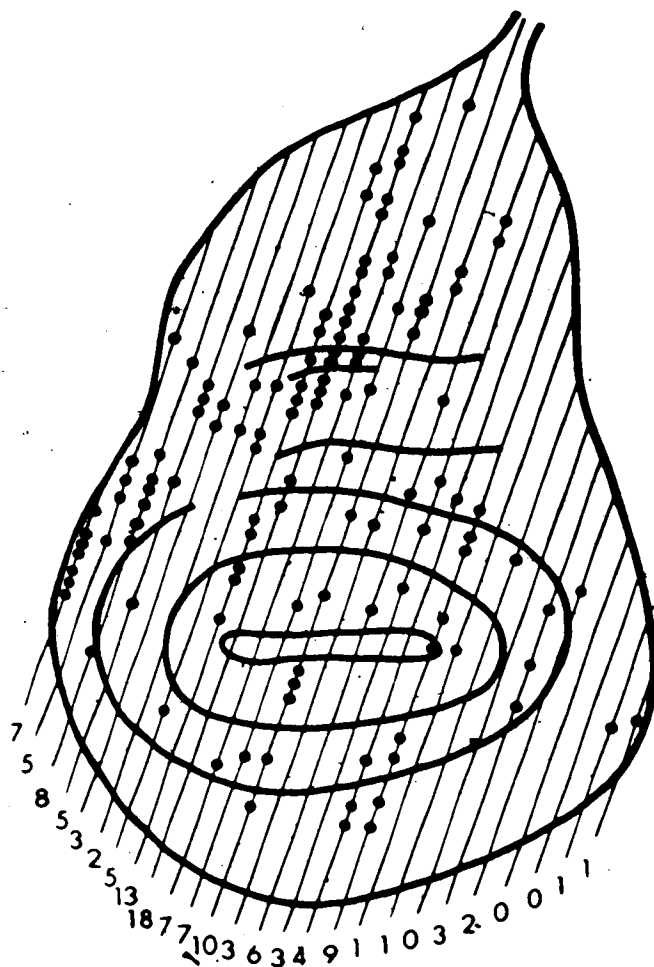
Fig. 18, a and b. Heat-treated *ts726* wing disc reconstructions.

(a)



S = 36  
D = 146

(b)



S = 26  
D = 124

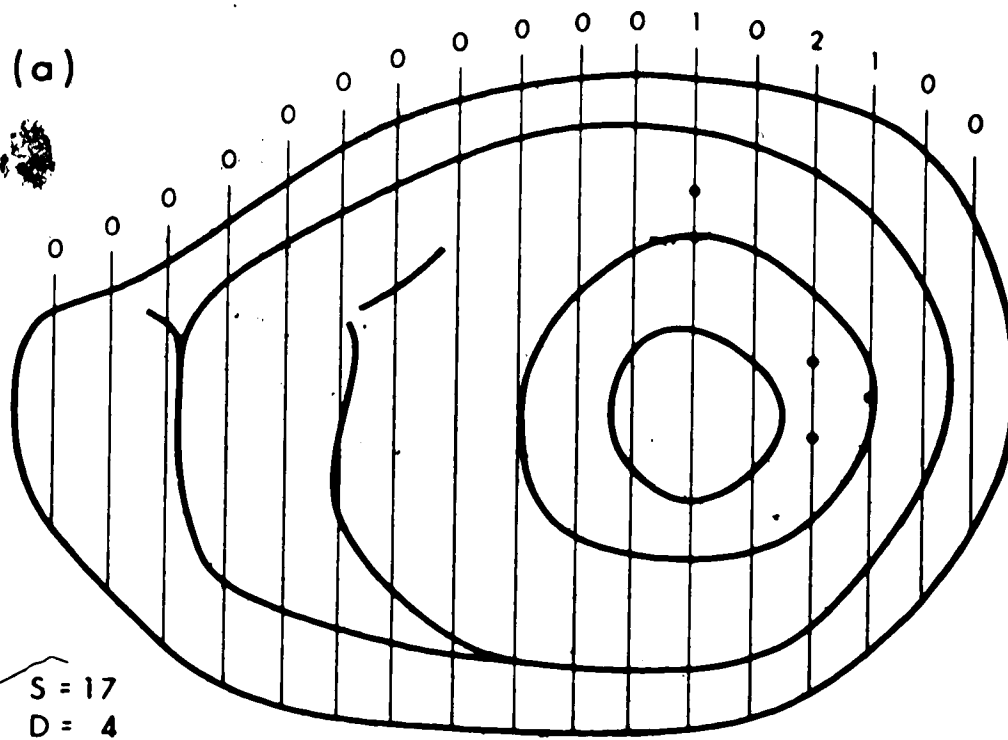
In both, regions of somewhat concentrated cellular degeneration occurred. In Figure 18a a concentration of Type I bodies can be seen in the region of the disc corresponding to the ventral wing surface (see fate map presented in Fig. 17a), and in Figure 18b two regions of concentration occur, one in the part of the disc which goes to form the imaginal scutum, and the other, which is less extensive, in a region which includes the axillary cord (AC) of the wing hinge. Since there were no pattern abnormalities observed in the imaginal cuticular derivatives of the wing disc, whether or not these concentrations reflected patterned cell death, or simply a statistical effect of random cellular degeneration, was not further investigated here.

*b) Leg Discs*

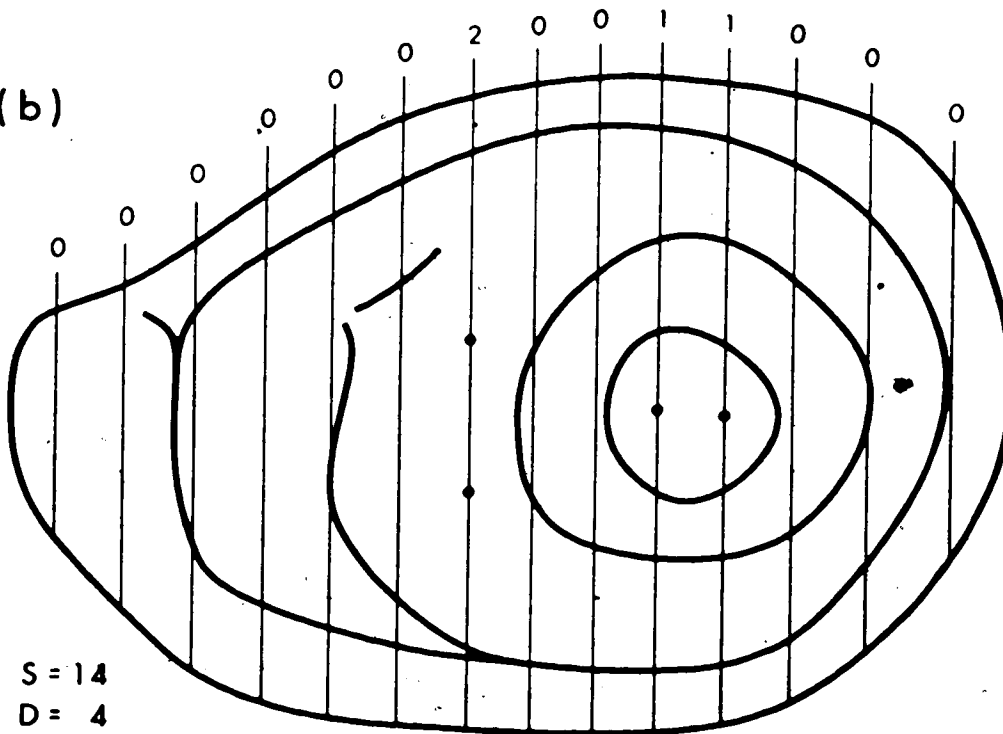
Several control and heat-treated first and second leg discs were reconstructed. Figure 19 presents the reconstructions of the unpulsed control discs. It can be seen from these that Type I bodies appear at a low level similar to that observed in the wing disc and are apparently randomly distributed throughout the disc epithelium. Figure 20 presents the heat-treated leg disc reconstructions. From these an increased frequency of cell death over controls is evident, but again there is no clear indication of recurring patterned degeneration. However, when a grid system, devised for counting cytoplasmic basophilia in various regions of the disc, was applied to these reconstructions, apparent regional frequency differences were detected. The grid, shown in Figure 21, was drawn on a plastic transparency and then superimposed in the same position over each of the reconstruction surface maps. In this way, numbers of degenerating bodies per grid square were recorded for

Fig. 19. Control leg disc reconstructions. Symbols as in previous Figures. a-f, first leg discs; g-j, second leg discs.

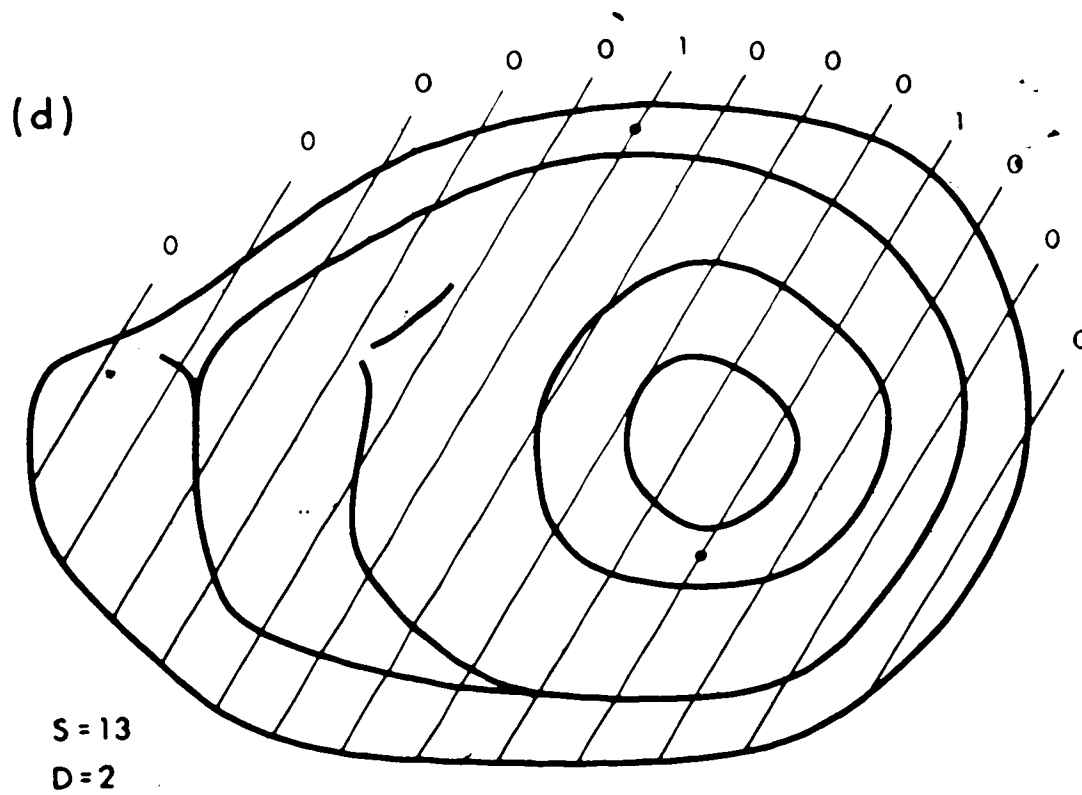
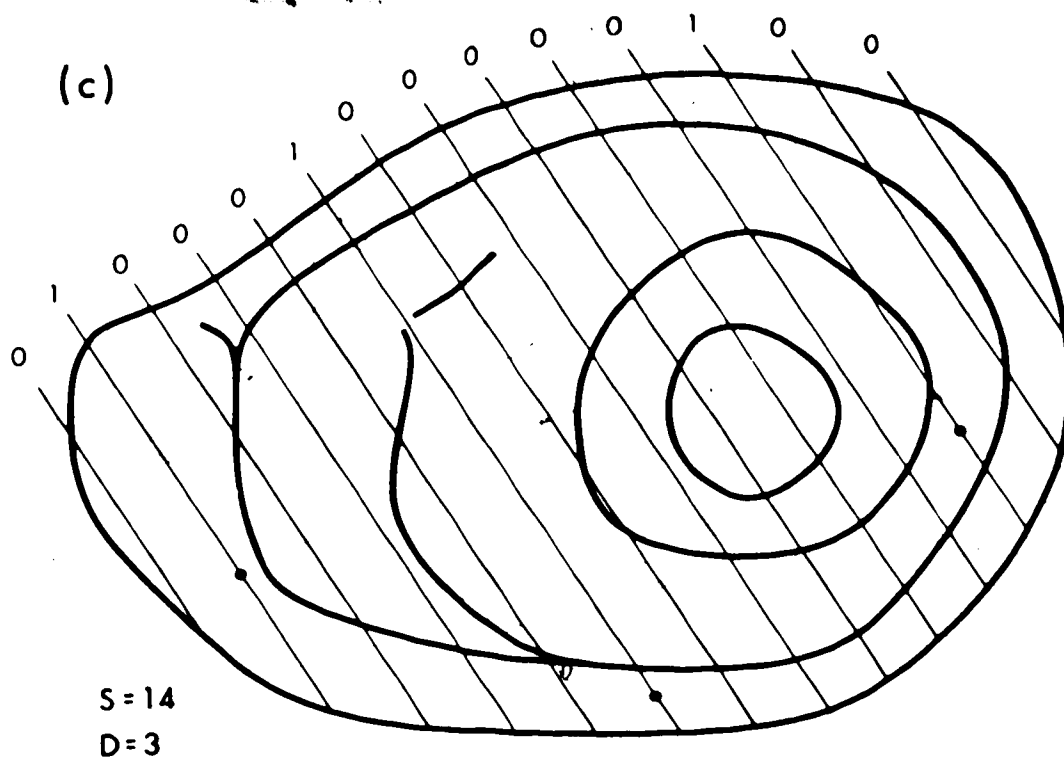
(a)



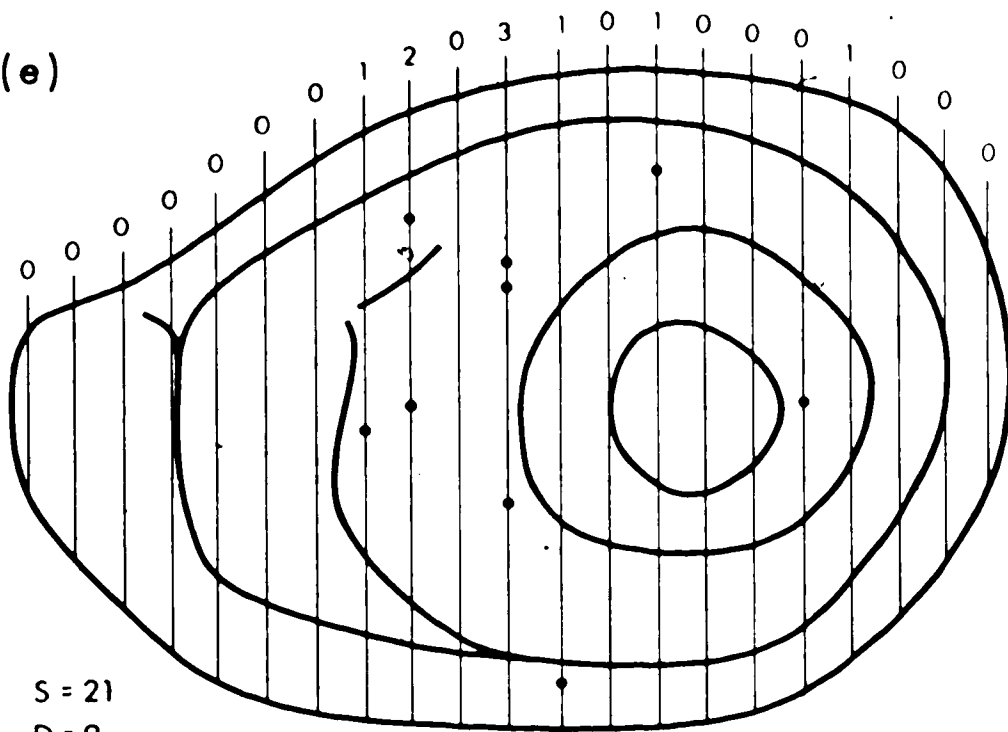
(b)





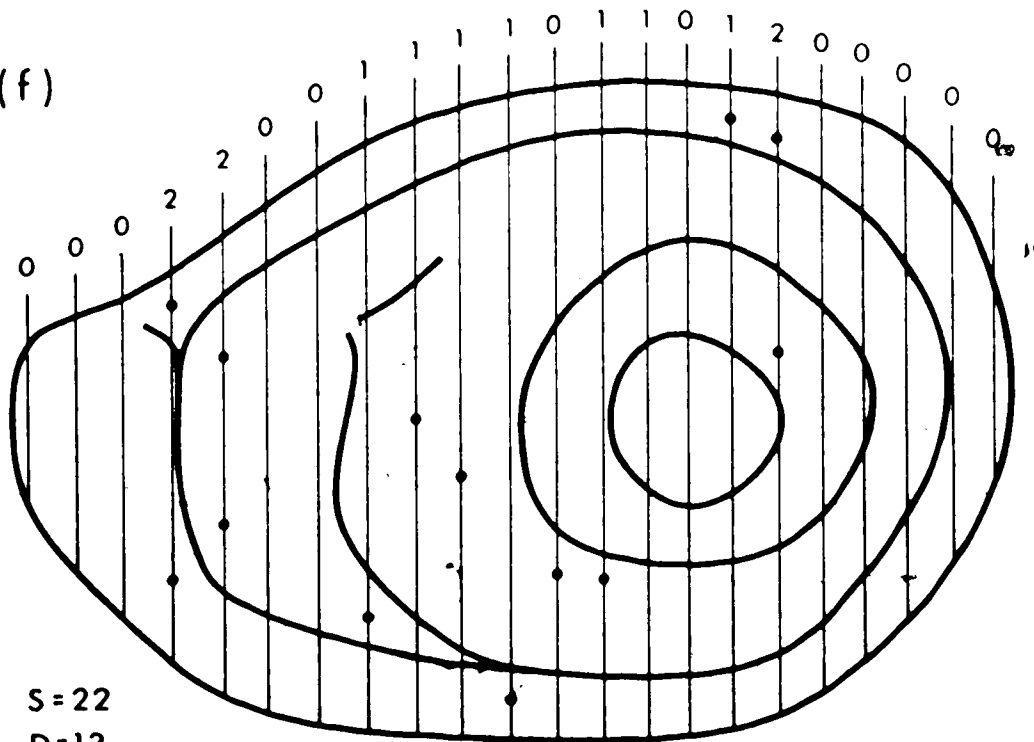


(e)

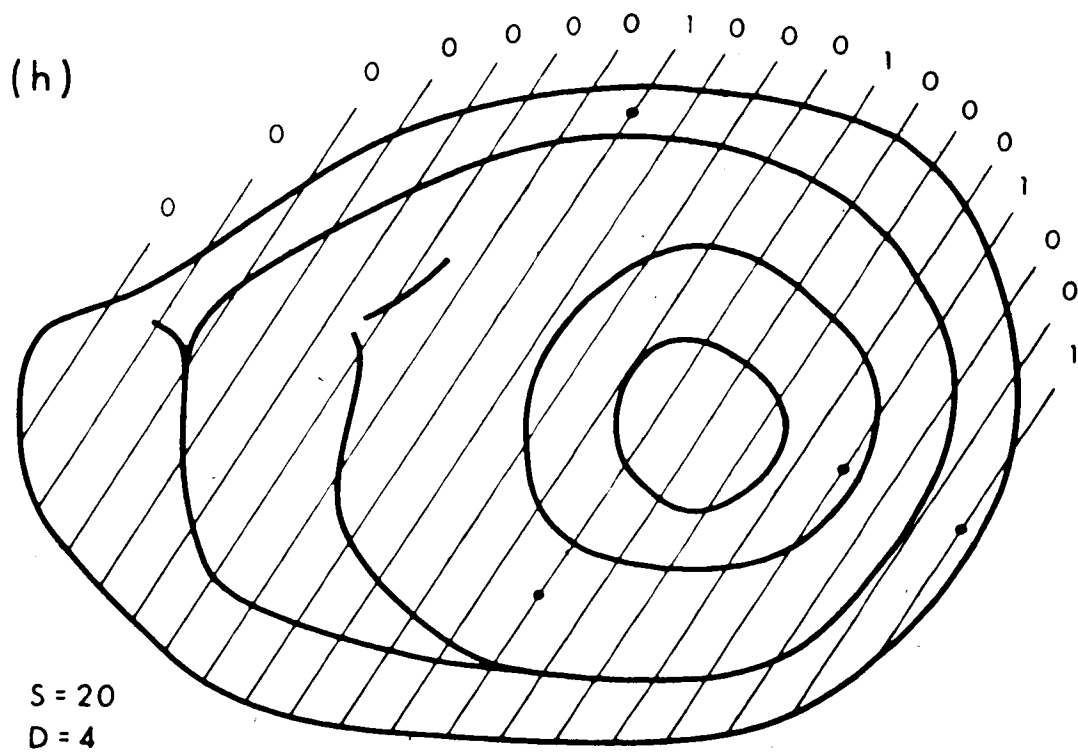
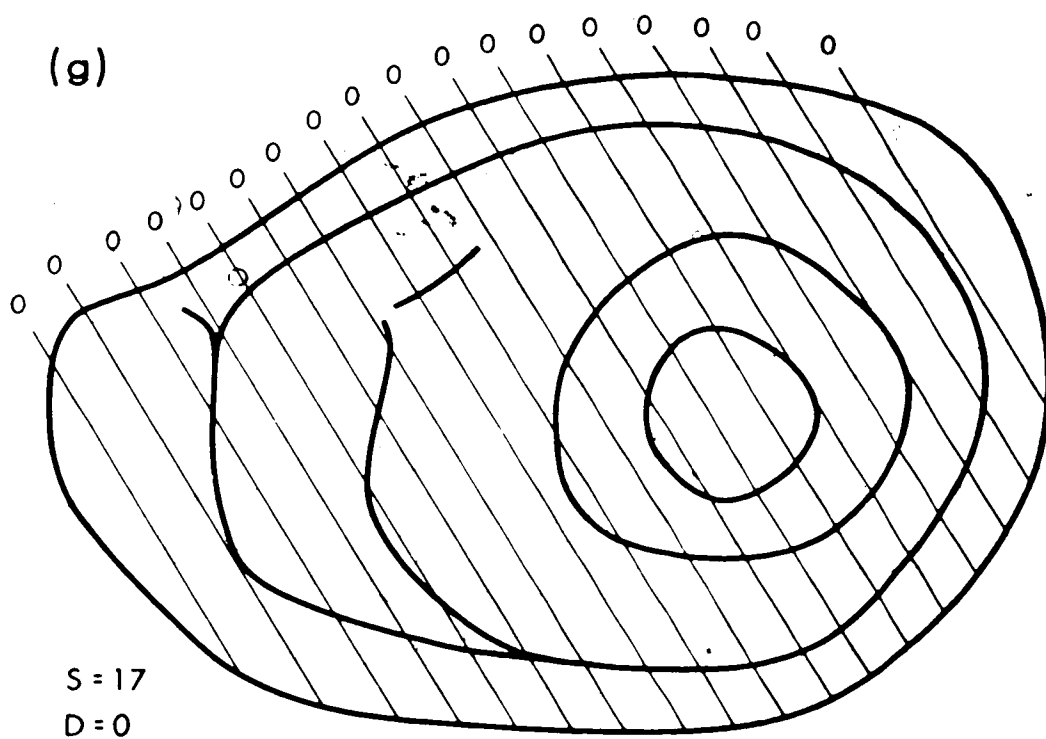


S = 21  
D = 9

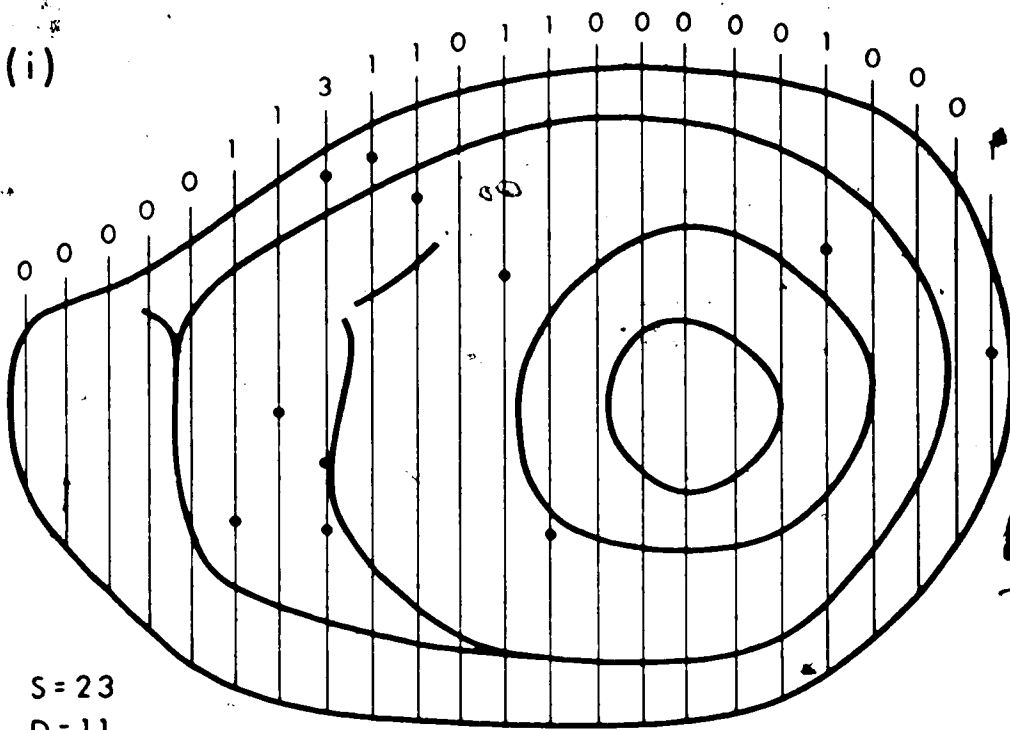
(f)



S = 22  
D = 13



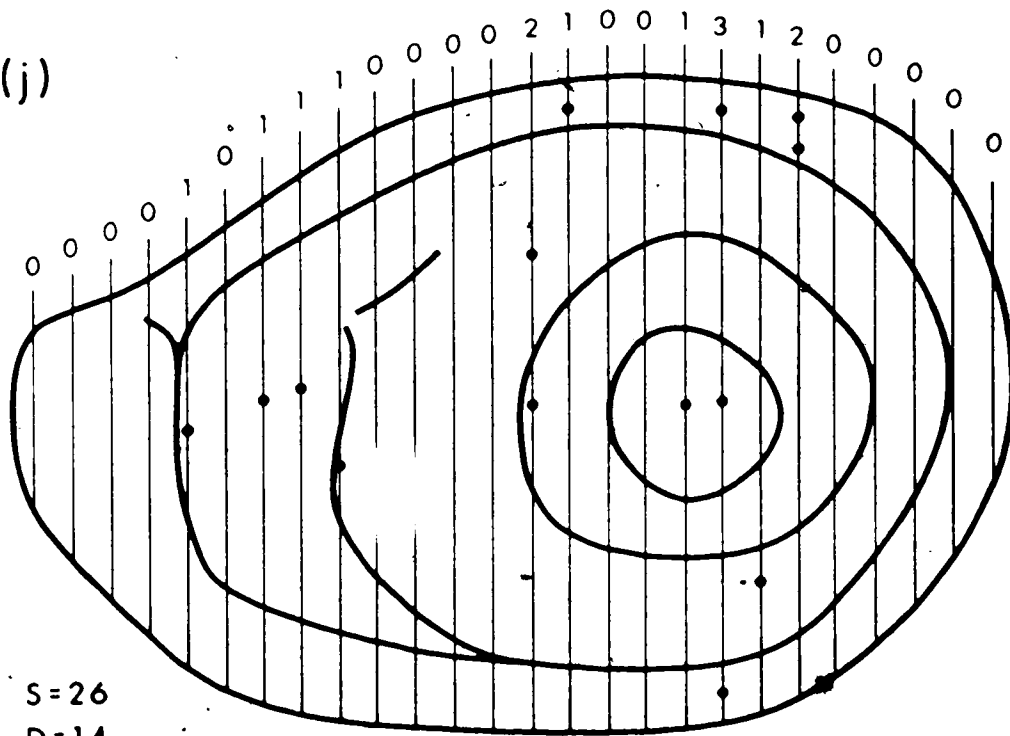
(i)



S = 23

D = 11

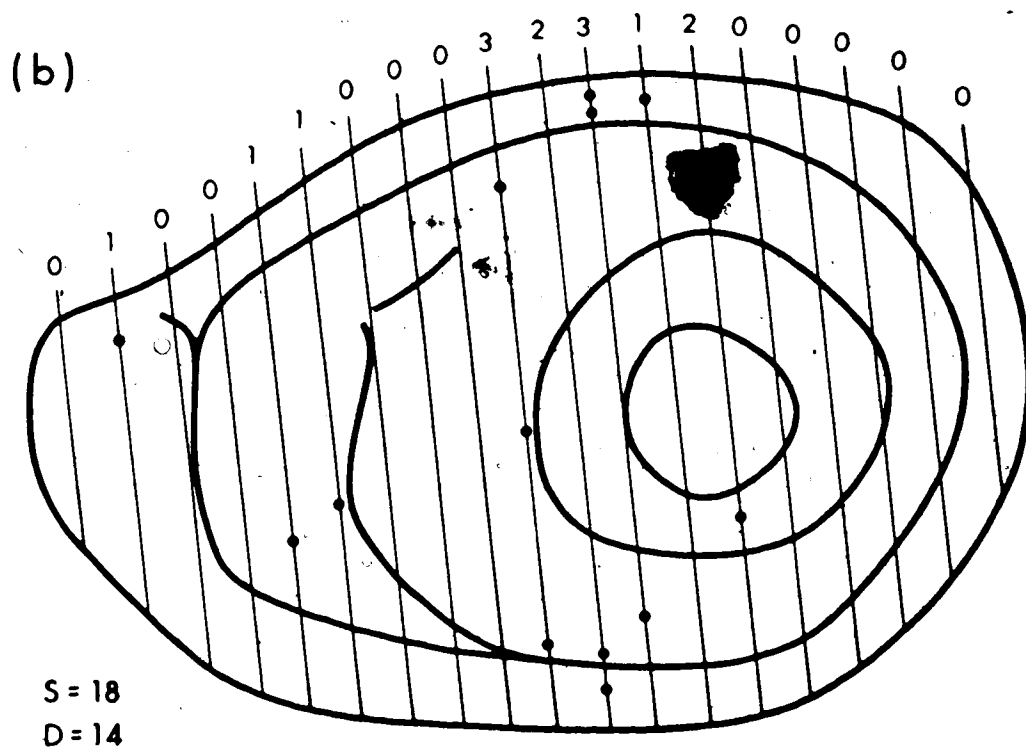
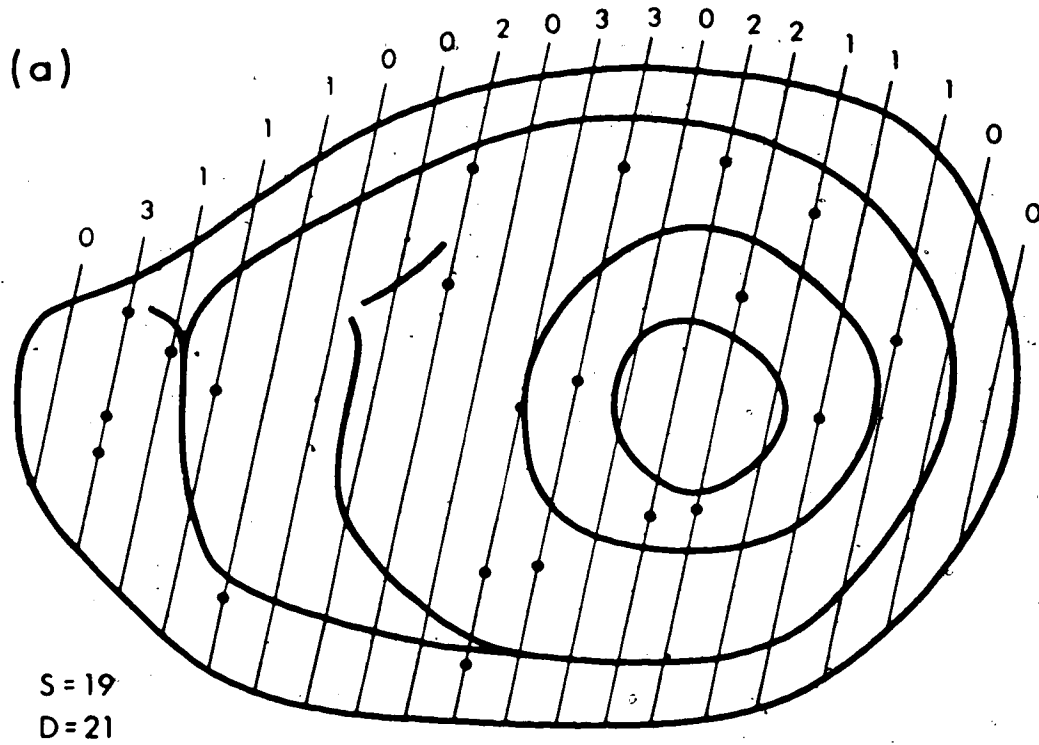
(j)



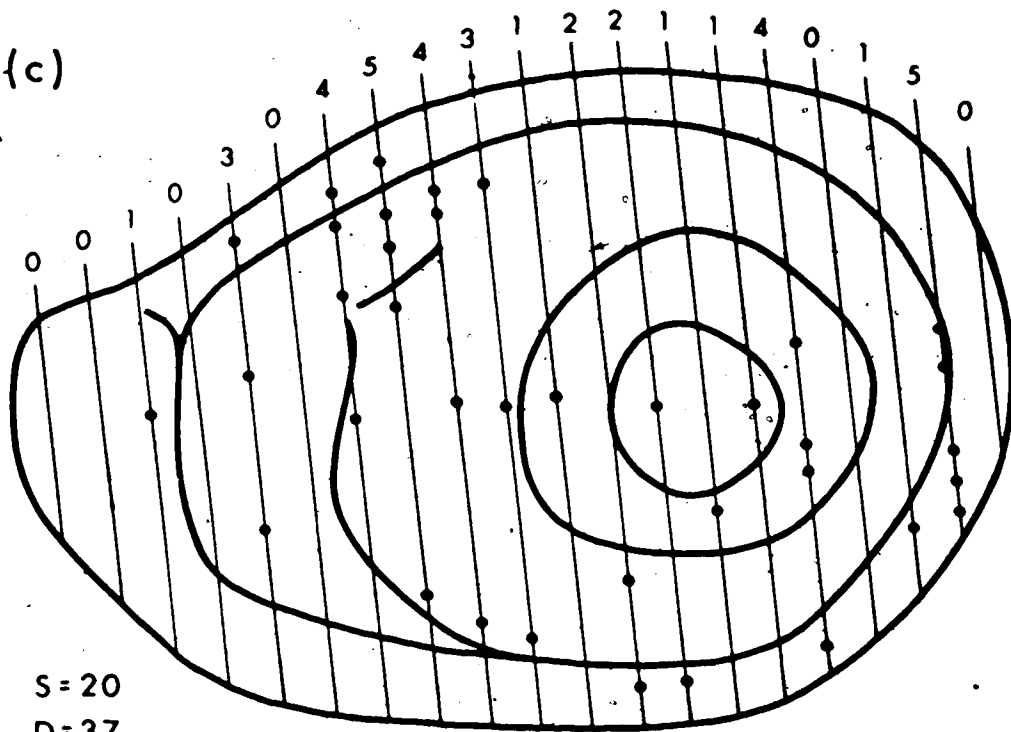
S = 26

D = 14

Fig. 20. Heat-treated leg disc reconstructions. Symbols as in previous Figures. a—b, first leg discs; c—f, second leg discs. Shaded area in f represents ventral portion of disc epithelium lost when block was trimmed for sectioning.

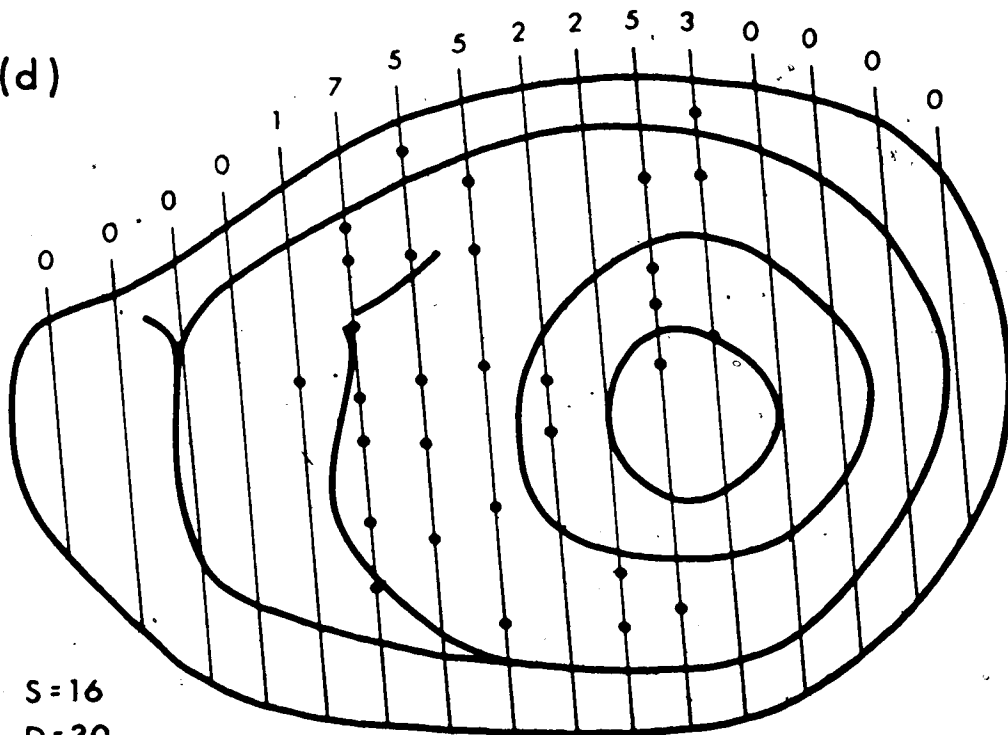


(c)



S=20  
D=37

(d)



S=16  
D=30

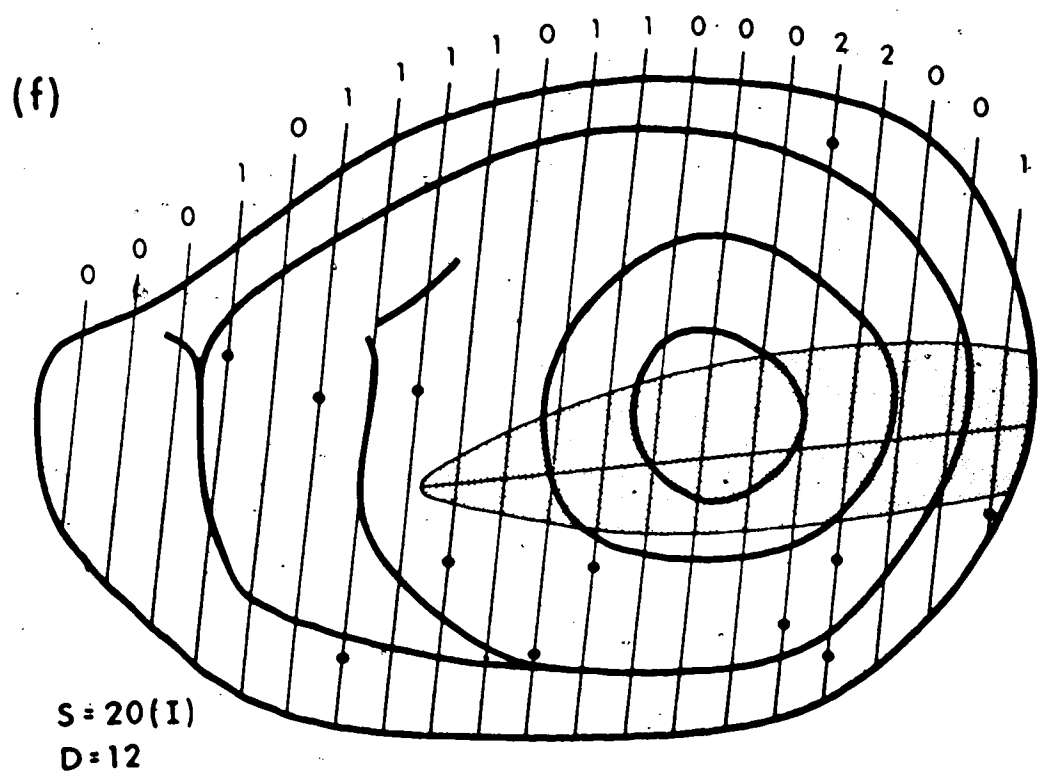
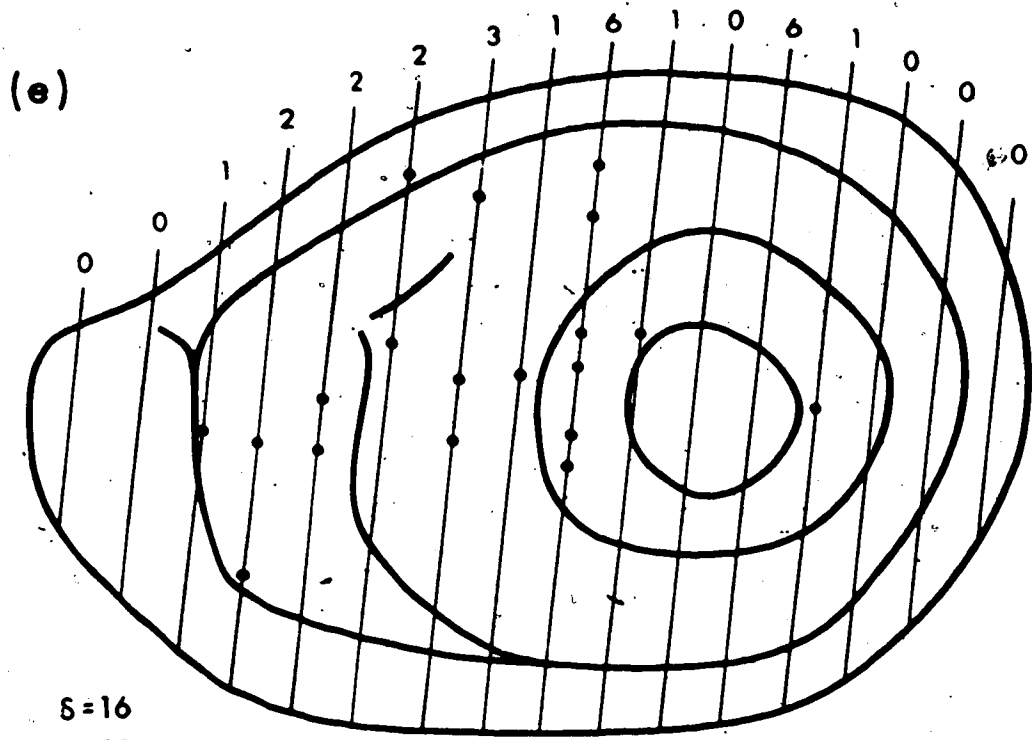
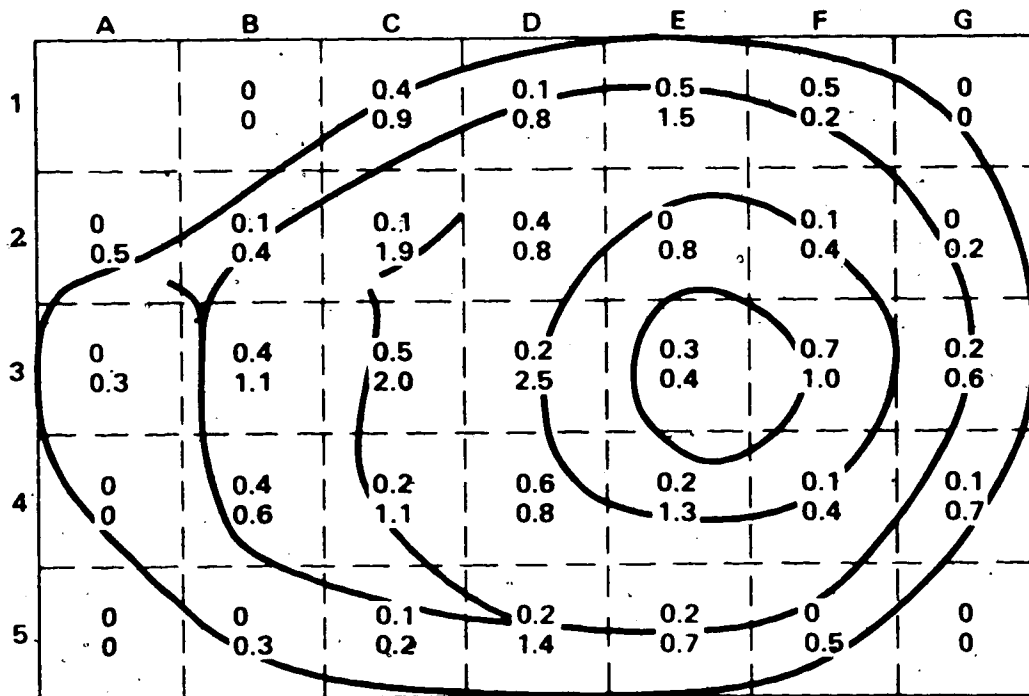
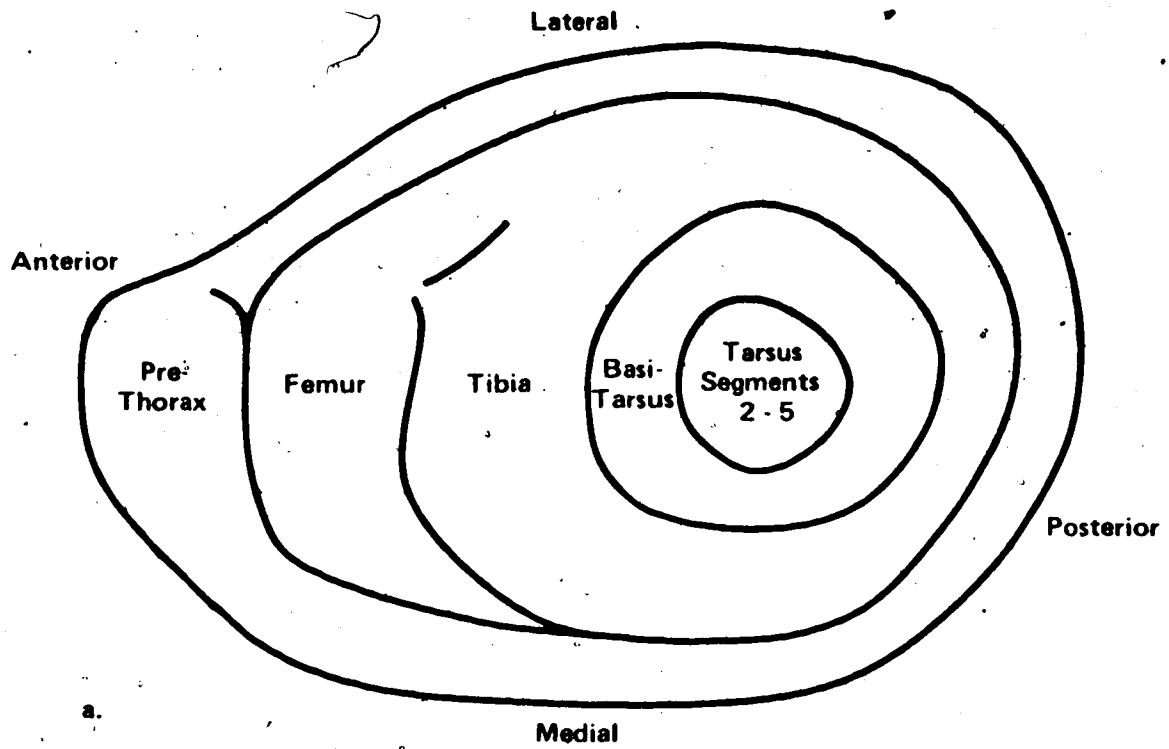




Fig. 21. a. Imaginal fate map of the mature leg disc. Simplified from Schubiger (1968).

b. Frequencies of Type I bodies per grid square in control (upper figures) and heat-treated (lower figures) *ts728* leg discs.



b.

each reconstruction and average frequencies were calculated based on all reconstructions. A correction factor for each grid square which extended over the border was used to adjust the average frequencies of Type I bodies for these squares appropriately. Frequencies for both control and heat-treated leg discs are indicated in Figure 21 which includes a fate map of the disc. The average regional frequencies of Type I bodies were then used to construct contour maps of cellular degeneration as shown in Figure 22. From these it would appear that in leg discs which experienced a 96-144 hour 29°C pulse, cell death was more extensive in the anterior halves, particularly in the regions which correspond to portions of the tibia and femur. However, it cannot be ruled out that the regional frequency differences observed within the disc were merely due to the combined effects of randomly distributed cell death, which could generate some localized concentrations of Type I bodies, and sampling error, due to the small number of reconstructions. Further elaboration of this point would require more reconstructions.

*c) Eye-antennal Discs*

The eye-antennal discs were of particular interest because their cuticular derivatives showed the highest frequencies of pattern abnormalities in adults following a restrictive temperature pulse. Reconstructions of control and heat-treated *ts726* eye-antennal discs are presented in Figures 23 and 24 respectively. A fate map of the mature disc is included for the reader's convenience.

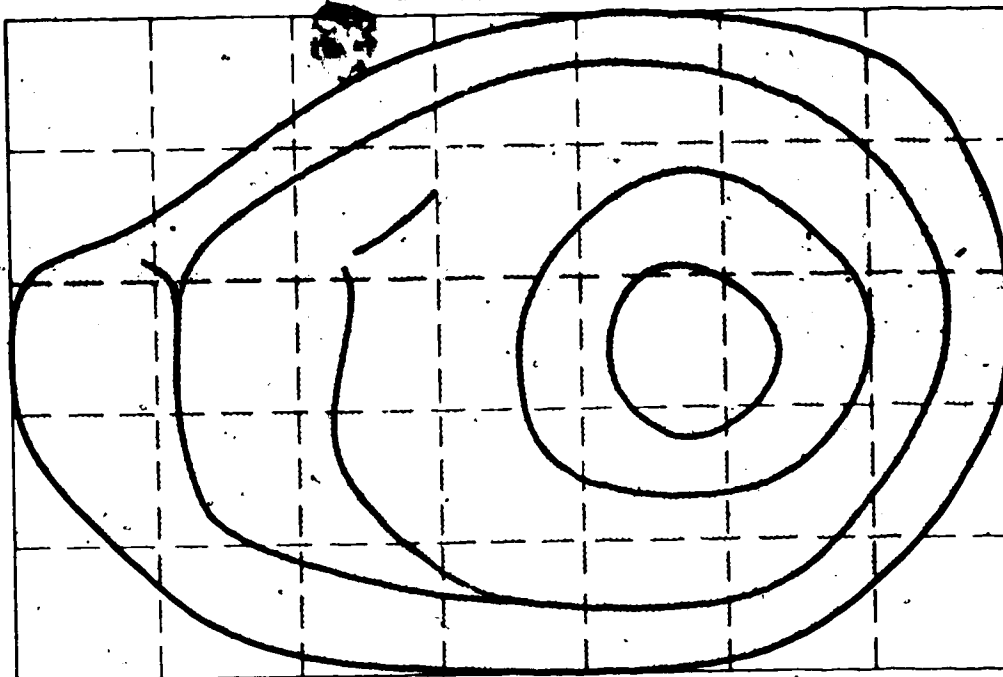
From the control reconstructions it appeared as though the cellular degeneration present was distributed at random throughout the disc epithelium. Type I bodies were found in both eye and antennal portions

Fig. 22. Contour maps of cellular degeneration in:

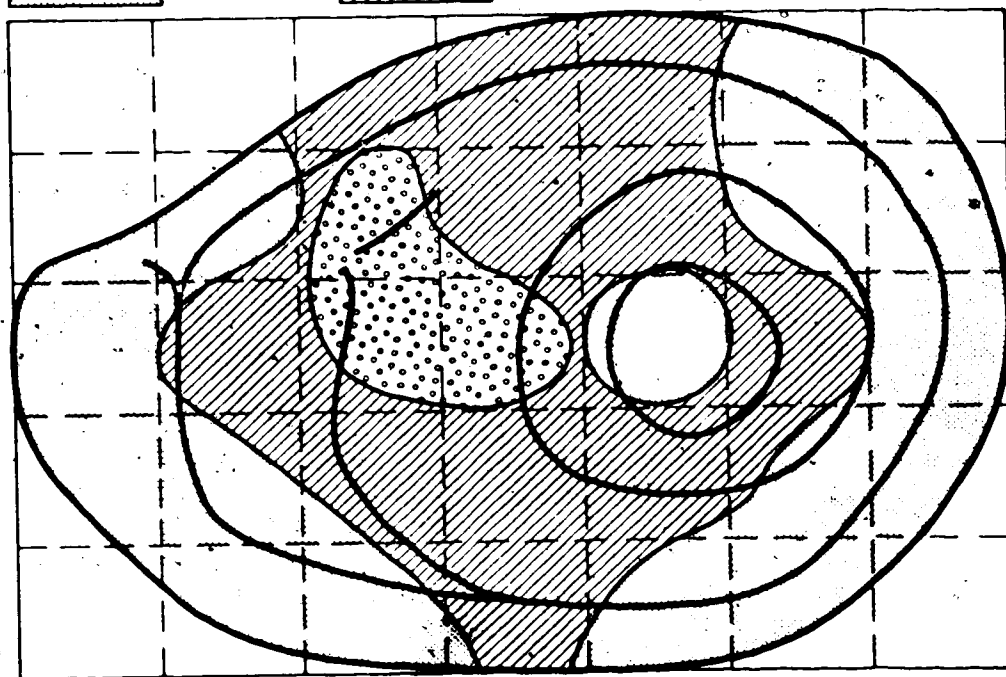
a. control (based on 10 reconstructions), and

b. heat-treated (based on 6 reconstructions) *ts726* leg discs.

a. Control



Type I Body Frequency Per Grid Square



b. Heat-Treated


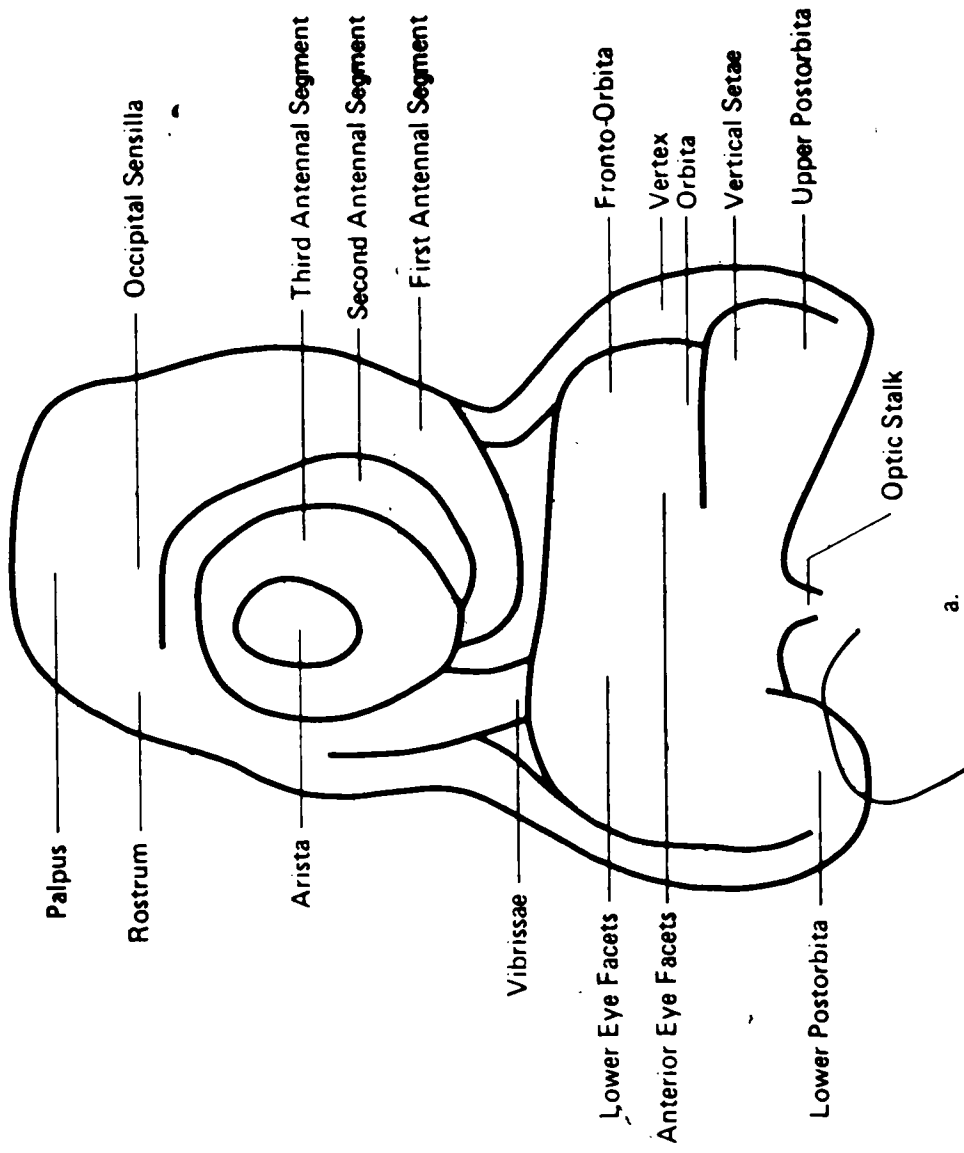
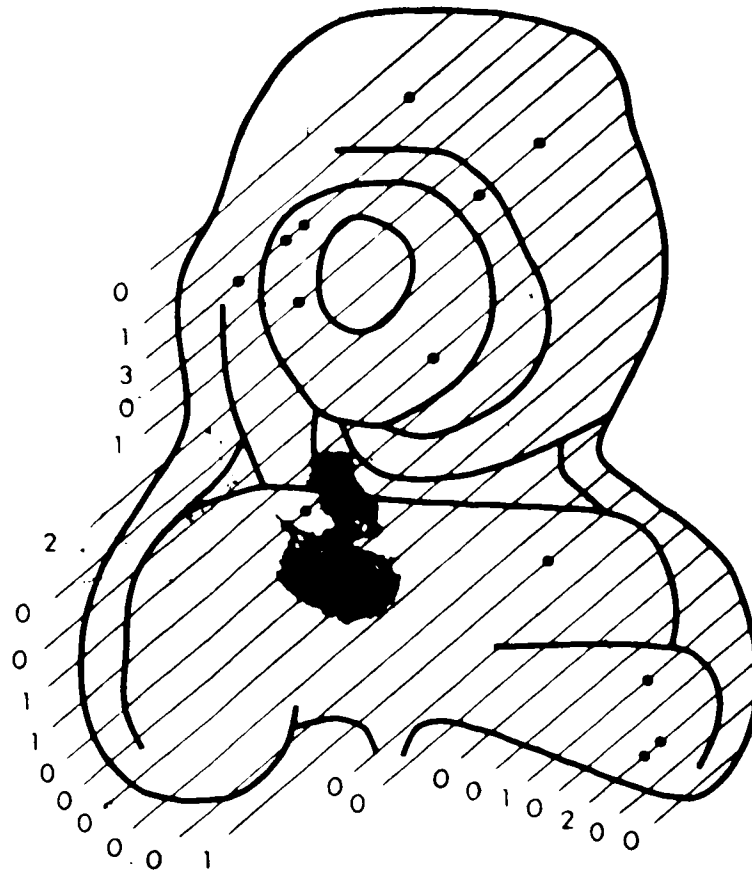


Fig. 23. a. Preliminary imaginal fate map of the mature eye-antennal disc. After Gehring (1966) and Ouweneel (1970).  
b—j. Unpulsed control *ts726* eye-antennal disc reconstructions. Symbols as in previous Figures.



(b)

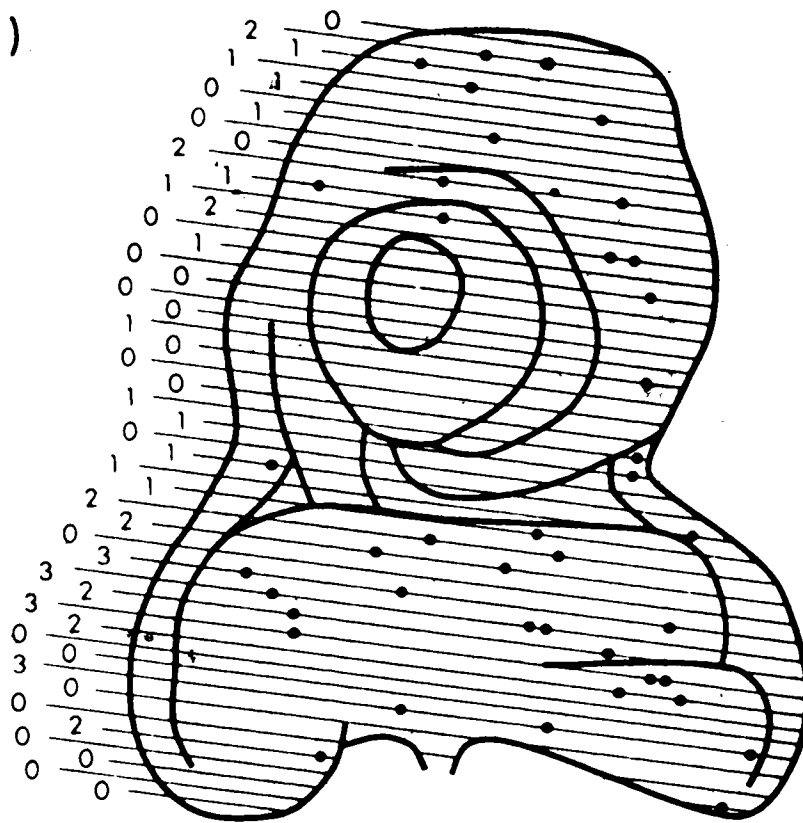


S = 25  
D = 13





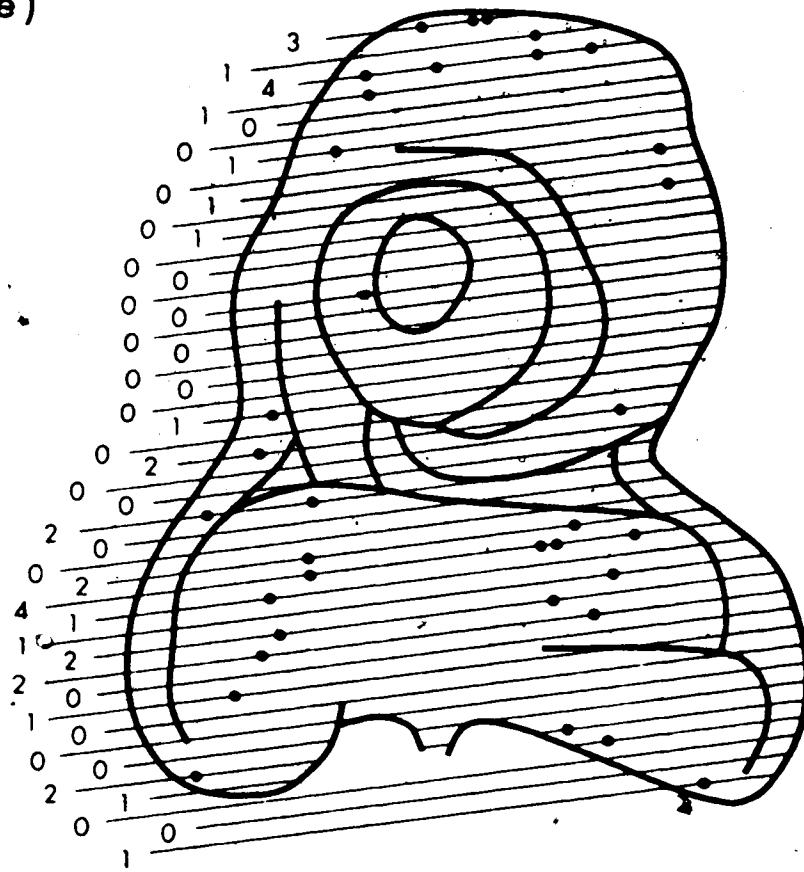
(d)



S = 47

D = 41

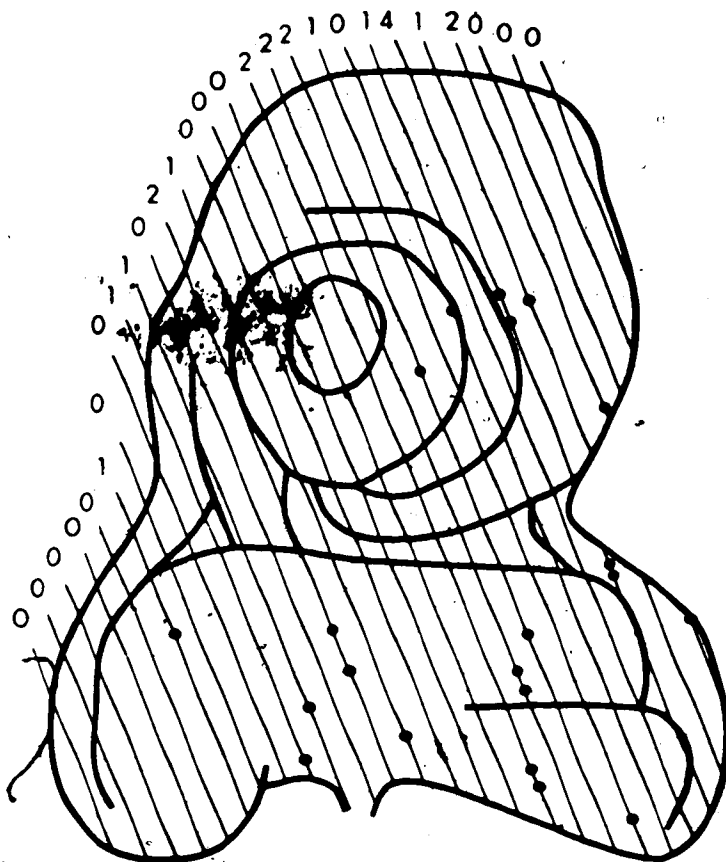
(e)



S = 44

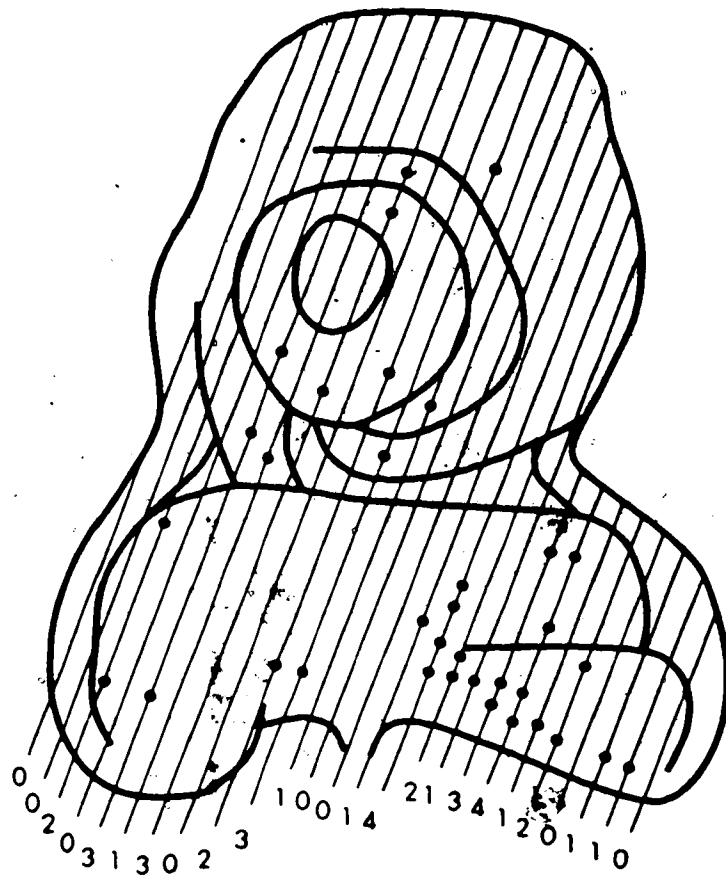
D = 34

(f)



S=28  
D=21

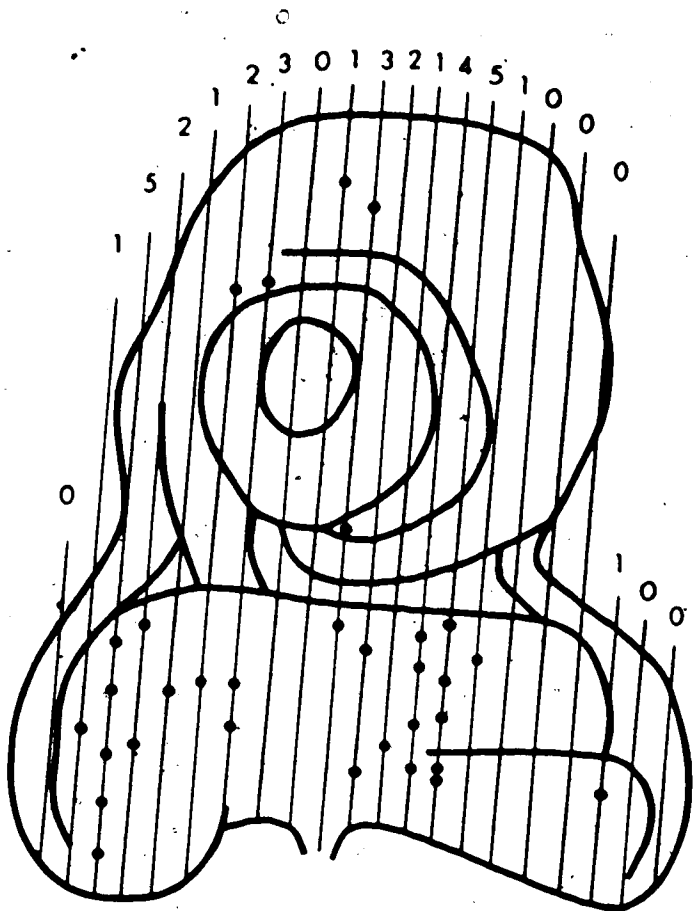
(a)



S=25

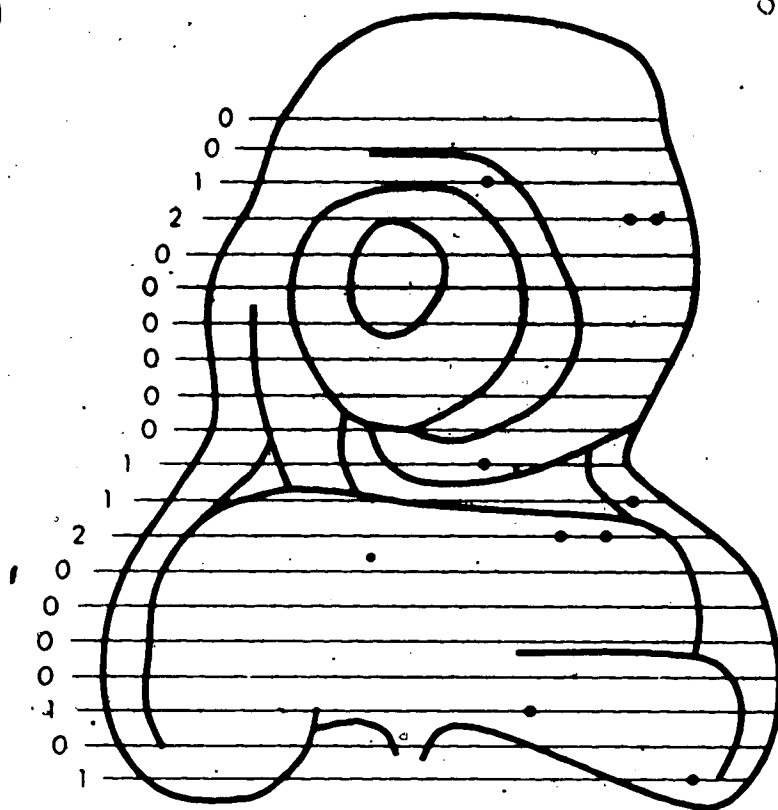
D=35

(h)



S = 21  
D = 32

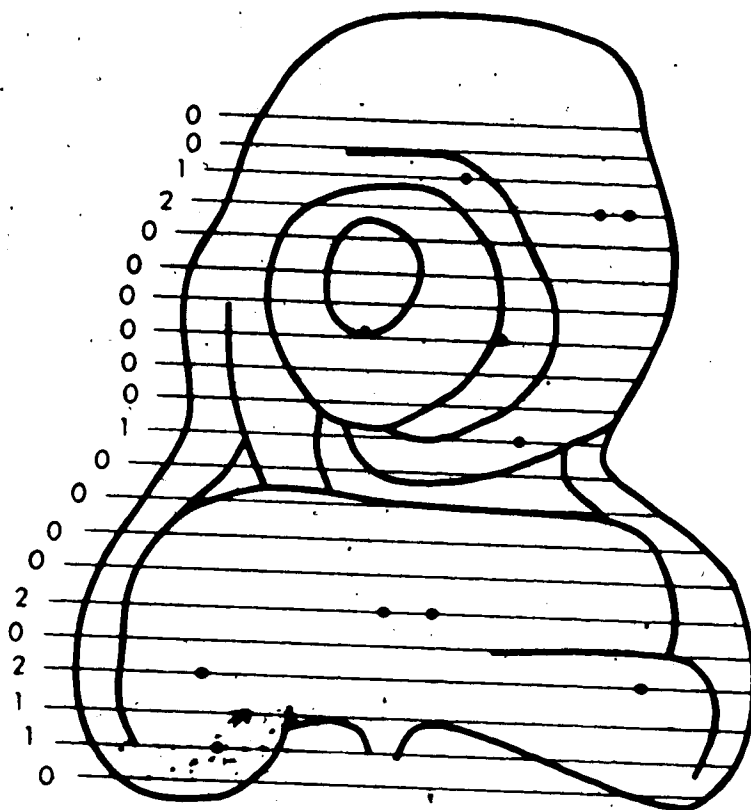
(i)



$S = 20(I)$

$D = 9$

(j)



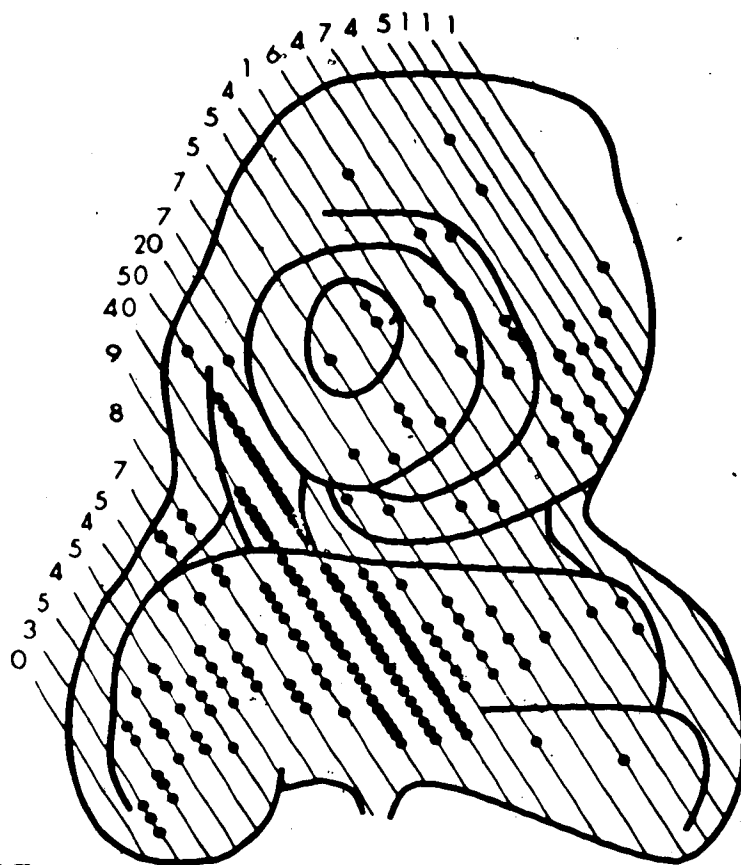
S = 21 (I)

D = 10

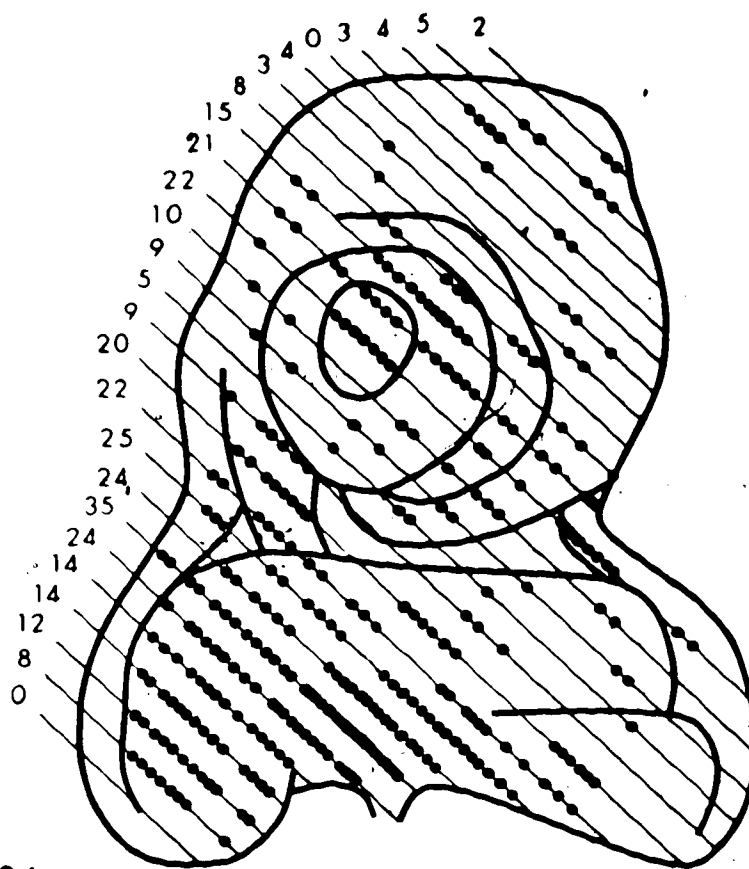


Fig. 24. a-j. Reconstructions of heat-treated *ts726* eye-antennal discs. Symbols as in previous Figures.

(a)

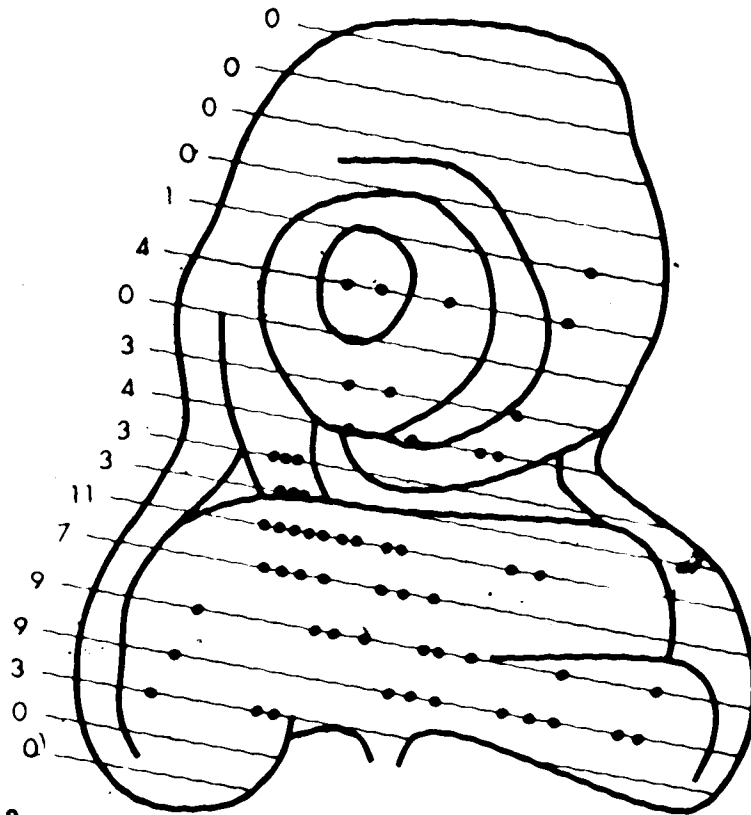
 $S = 27$  $D = 218$

(b)



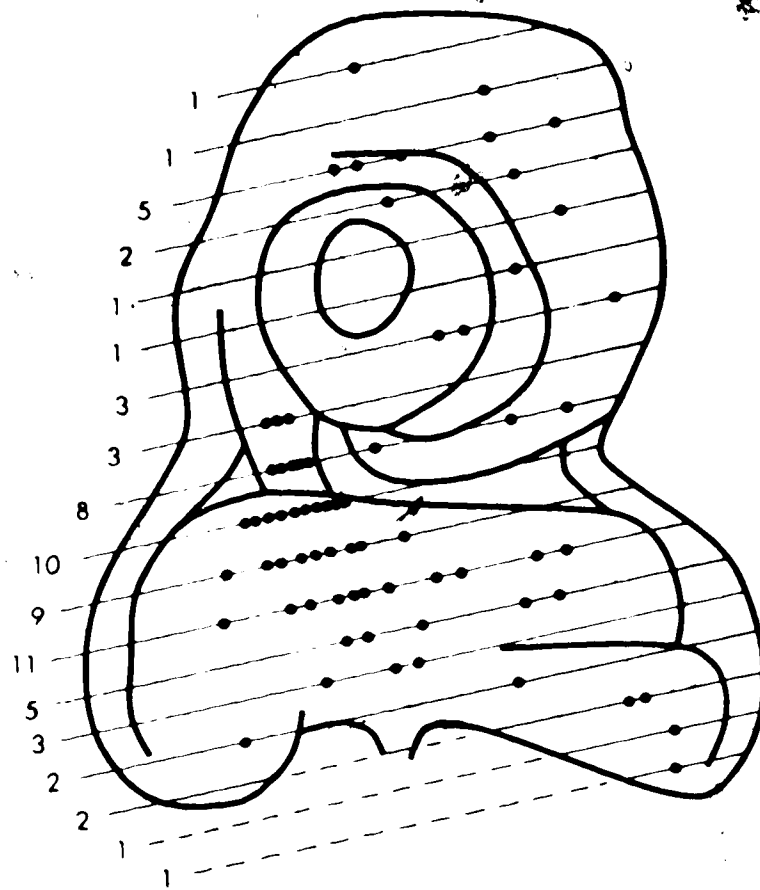
S = 26  
D = 319

(c)



S=18  
D=57

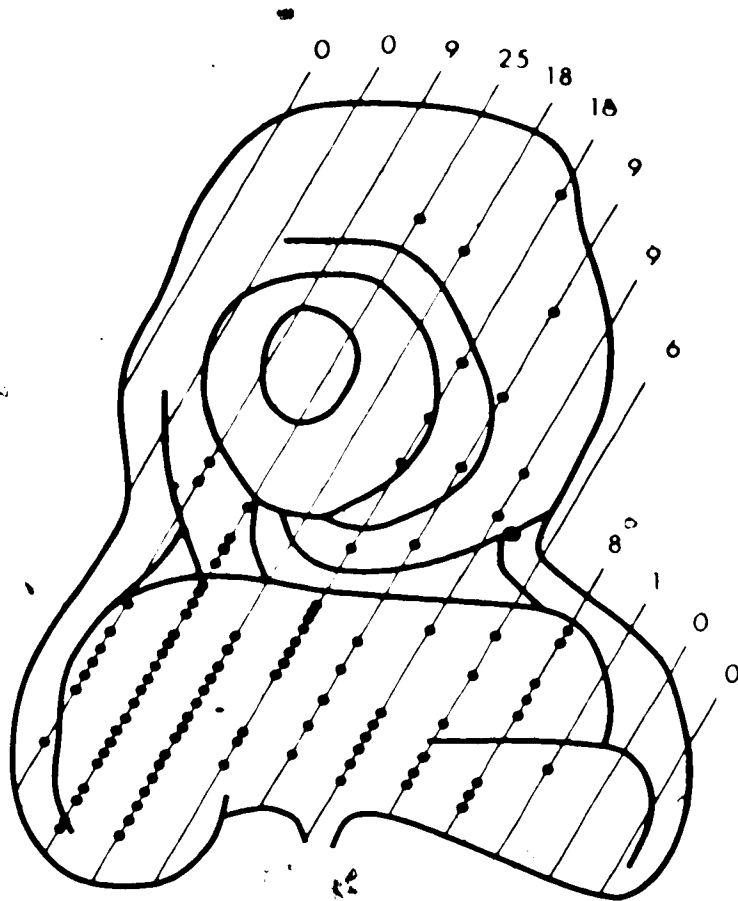
(d)



S=18

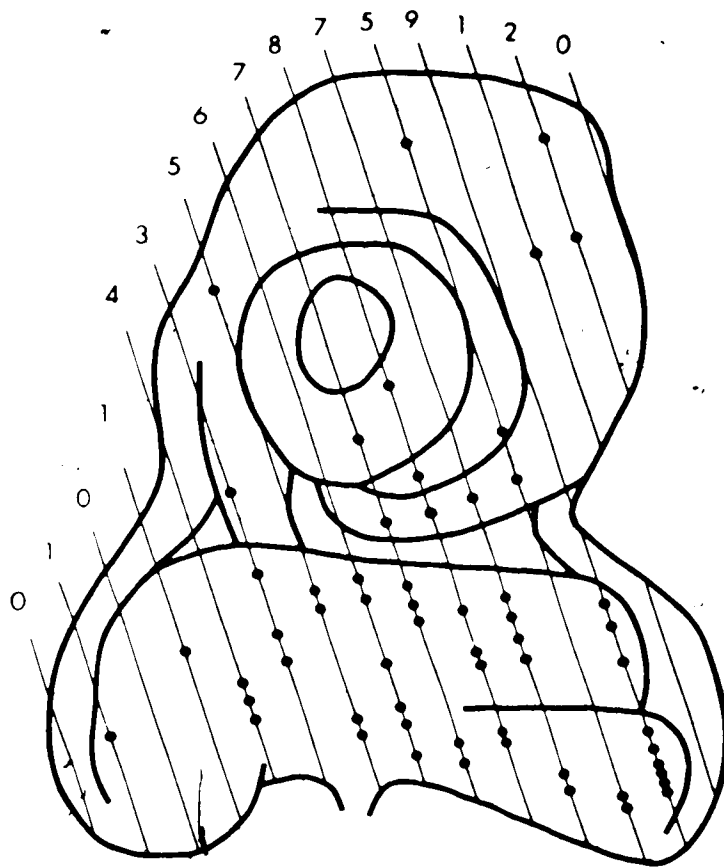
D=69

(e)



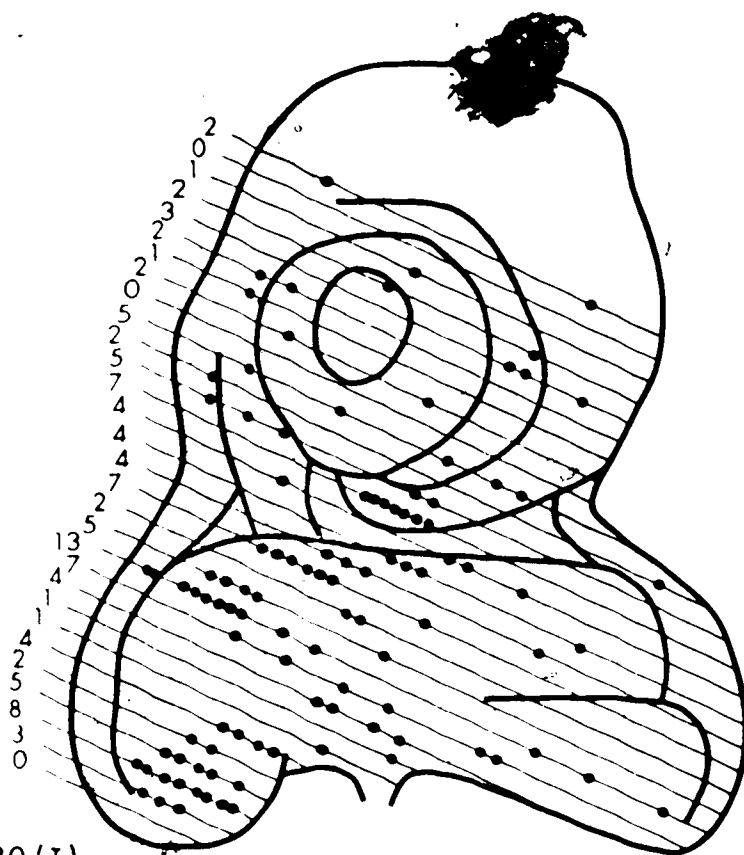
S = 13  
D = 101

(f)



S = 16  
D = 59

(g)

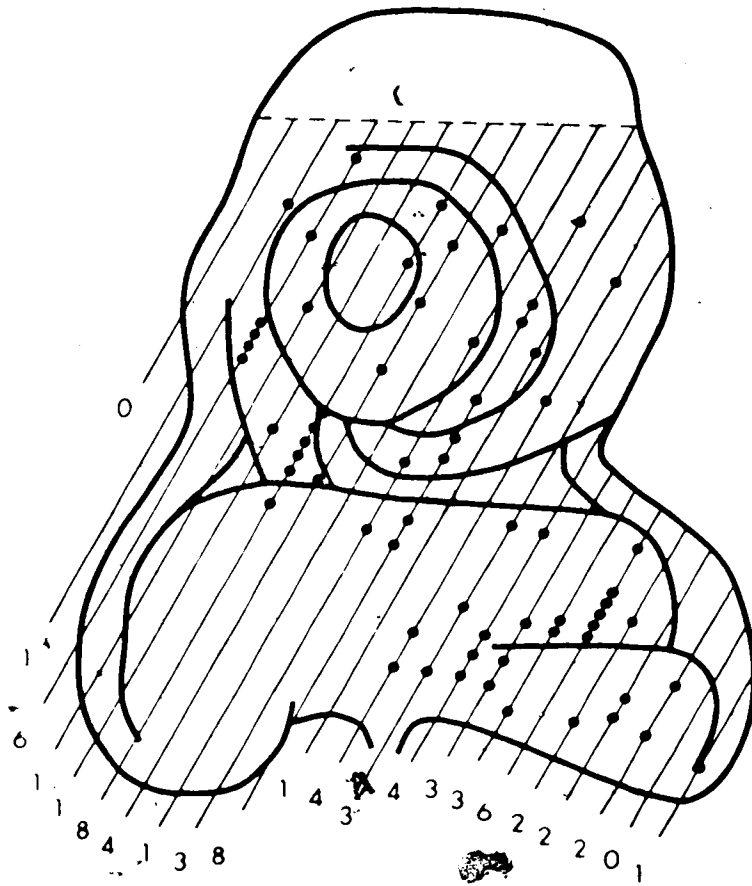


S = 30 (I)

D = 106



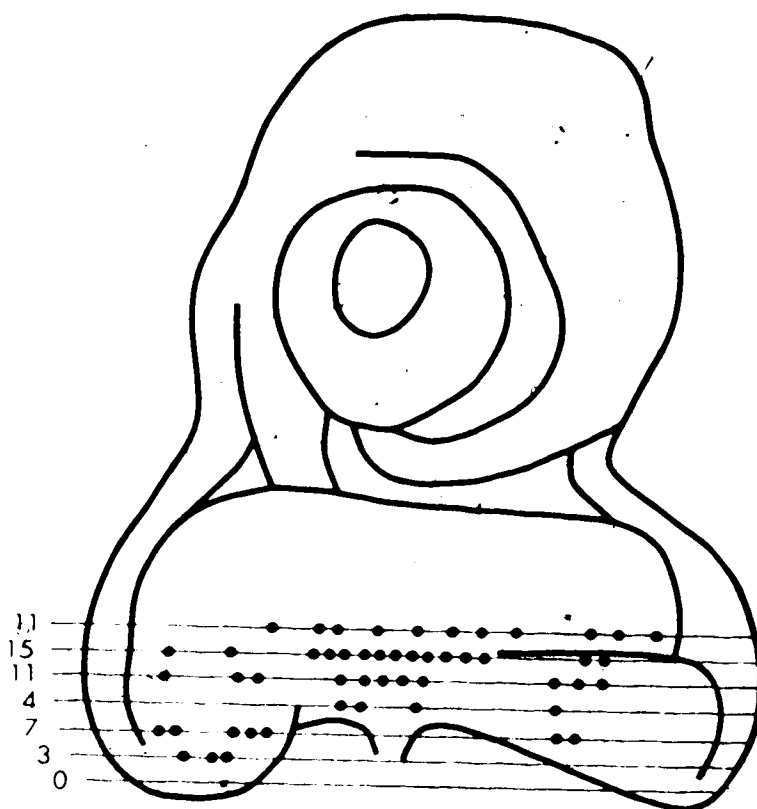
(h)



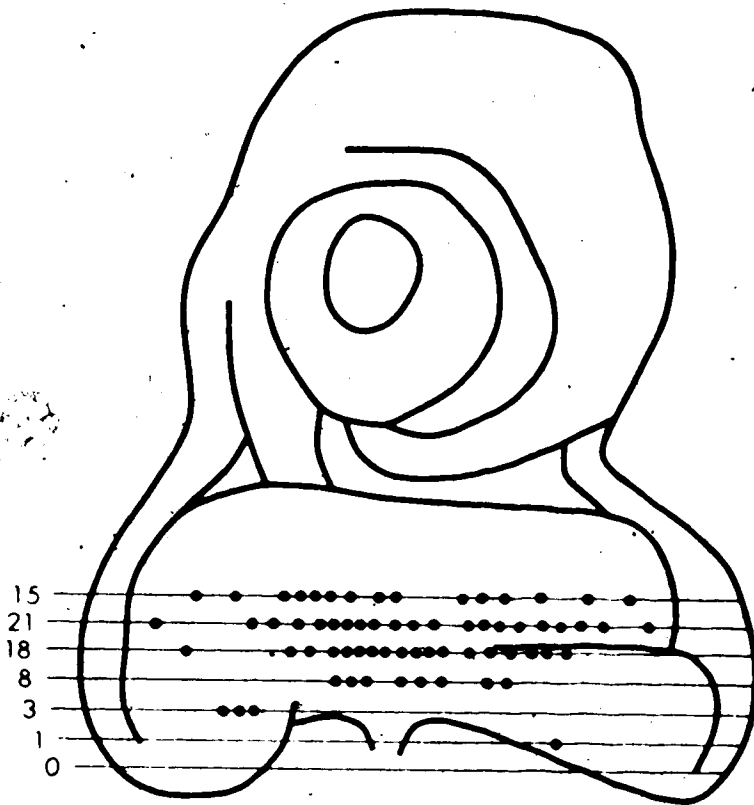
$$S = 22(I)$$

$$D = 64$$

(i)

 $S = 7(I)$  $D = 51$

(j)



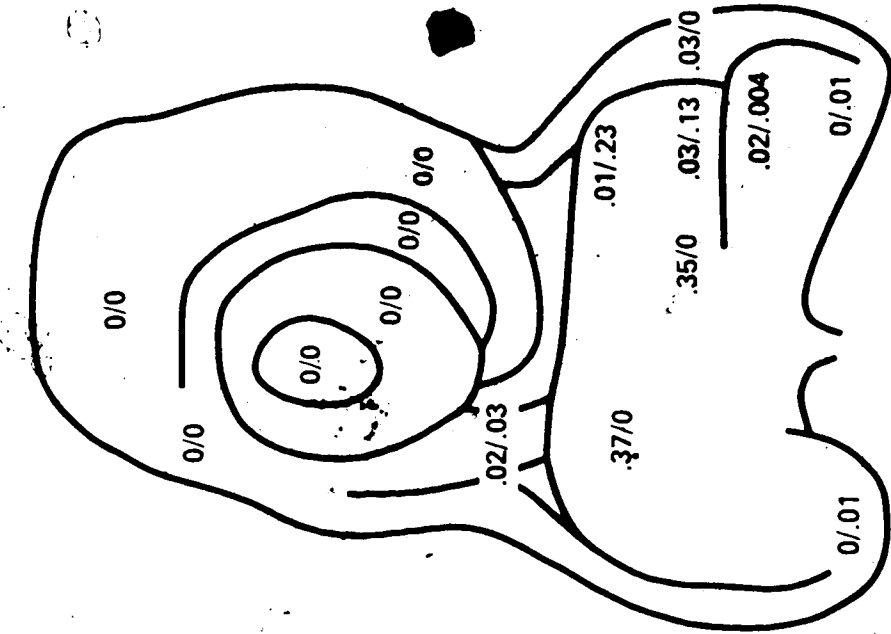
S=7(I)

D=66

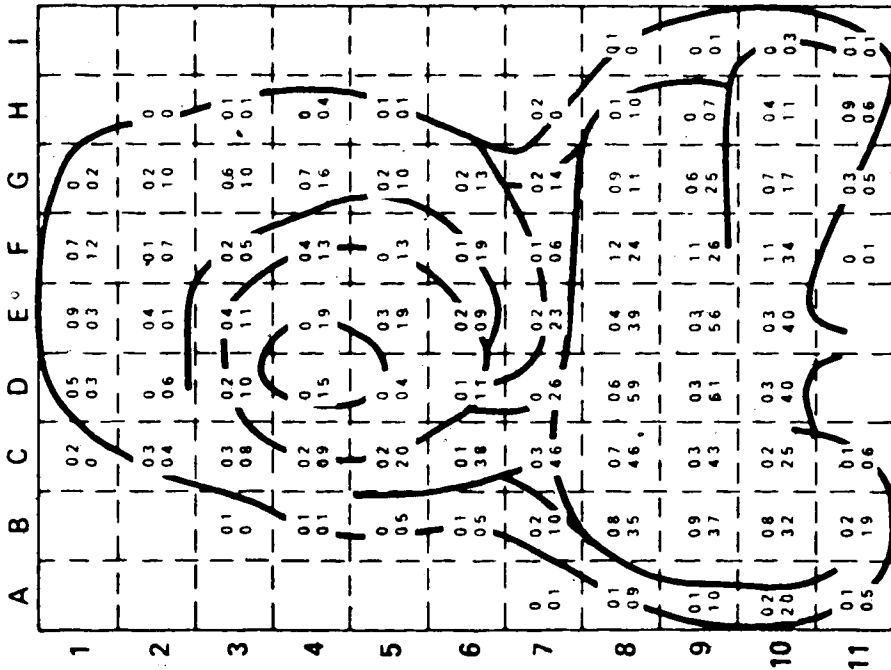
of control discs. However, in heat-treated discs the distribution of the greatly increased numbers of Type I bodies was obviously non-random. Disc-to-disc variation in the patterned distributions of heat-induced cell death was considerable, but certain regions within the epithelium exhibited concentrations of degenerating bodies more regularly than others. The eye facet-forming part, and in particular the lower eye portion (see fate map in Fig. 23), usually included the most extensively necrotic regions of any given heat-pulsed disc. An adjacent region, that which, by the fate map, corresponds to the vibrissae, was often a center of degeneration as well. Other regions of the disc, such as the palpus-forming part, showed levels of Type I bodies only slightly elevated relative to those found in control disc reconstructions. In no disc reconstructed was a uniform distribution (even spacing) of degenerating bodies observed.

A grid system, similar to that utilized for the leg discs, was developed for the eye-antennal reconstructions. For each reconstruction, Type I bodies were enumerated in each grid square, and average frequencies based on all reconstructions were again calculated. Those values for grid squares extending beyond the border of the surface map were corrected appropriately as before. The grid and mean Type I body frequencies obtained for both control and heat-treated eye-antennal discs are presented in Figure 25. A summary (from Table X) of the corresponding deficiency and duplication frequencies of imaginal cuticular structures is included for comparison purposes. Regional differences in Type I body frequencies facilitated the construction of contour maps of cellular degeneration, which are presented in Figure 26. The spatial

- Fig. 25. a. Control (upper figures) and heat-treated (lower figures) Type I body frequencies per grid square based on *ts726* reconstructed eye-antennal discs.
- b. Deficiency (upper figures) and duplication (lower figures) frequencies for imaginal cuticular structures derived from the eye-antennal disc in 252 *ts726*  $\frac{1}{2}$ -heads after a 96-144 hour 29°C pulse. For cuticular structures see fate map presented in Figure 23a.

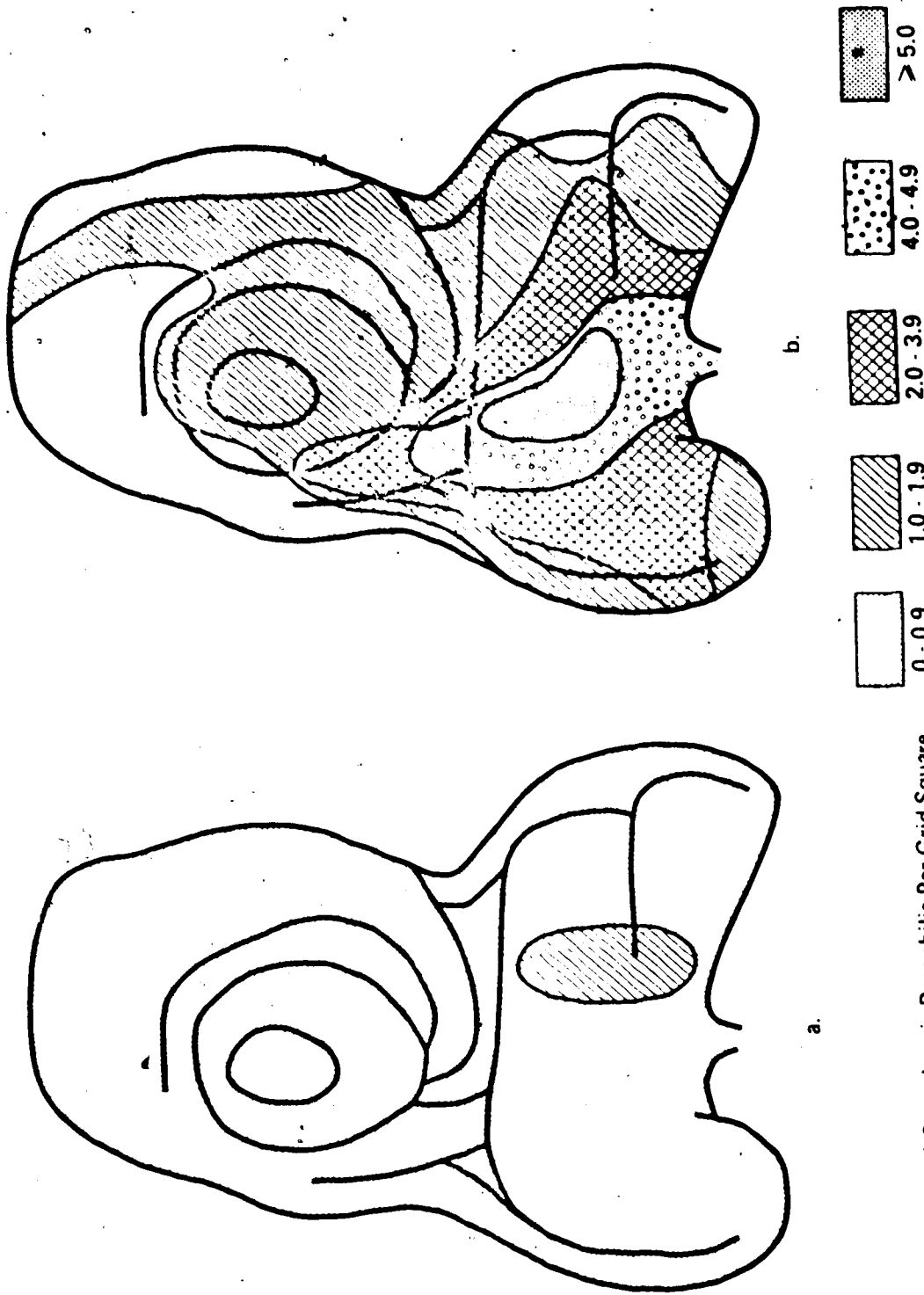


b.



a.

Fig. 26. Contour maps of cellular degeneration in:  
a. unpulsed control (based on 9 reconstructions), and  
b. heat-treated (based on 10 reconstructions) *ts226*  
eye-antennal discs.



Frequency of Type I Cytoplasmic Basophilia Per Grid Square



distribution of cellular degeneration within the disc thus depicted, as well as that observed in any individual reconstruction, can be compared with the imaginal pattern abnormality frequencies, and such comparisons suggest the following relationships. Eye facets, in general, were the most frequently deficient imaginal cuticular structure and apparently never duplicated. The lower eye region in particular corresponds to that part of the disc which showed the highest frequency of degeneration. The vibrissae duplicated or became deficient only infrequently while the corresponding region of the disc showed a high average frequency of Type I bodies. The antennae and maxillary palps showed no cuticular abnormalities in these limited experiments, and the corresponding regions of the disc had relatively low frequencies of degeneration. Those structures which duplicated most frequently and were deficient only infrequently, the fronto-orbitals and orbitals, were located in regions of the disc exhibiting low frequencies of Type I bodies that were adjacent to regions with higher levels.

^

## DISCUSSION

### The Detection, Localization, and Quantification of Cell Death in Imaginal Discs

Considerable time and effort during the initial stages of these investigations went towards the evaluation of various methods for the detection of cell death in imaginal discs. Initially, conventional histological technique using paraffin sections was employed. However, even though a variety of staining techniques were investigated, and excellent material suitable for gross morphological studies was obtained, the results were ambiguous with respect to the detection and localization of cell death in the imaginal discs. The inadequacy of this method arises from the very small size of imaginal disc cells (2–6  $\mu$  in diameter, Poodry and Schneiderman, 1970) and the consequent lack, in thick sections, of resolution at the cellular and sub-cellular levels. With hematoxylin-stained wax sections the so-called "pycnotic nuclei," reported in the literature as evidence of cell death, could not be resolved as individual entities in the imaginal discs. Although regions of certain discs stained intensely with hematoxylin, it was not apparent whether this staining was of nuclear or cytoplasmic origin. Consequently, for the purposes of further investigation of cell death, the method was abandoned.

Various vital stains have been reported as useful for the detection of cell death. Of the two investigated here the acridine orange fluorescence technique appeared to be the more useful. Various patterns of fluorescing spots, similar to those reported by Sprey (1971) as being indicative of degenerating cells, were observed in heat-treated *ts726*

discs. However, the problem of poor resolution remained and identification of exactly what was fluorescing was not possible. Also, whether the fluorescence arose from the folded disc epithelium, the lumen, or the peripodial membrane could not be unambiguously determined.

Koenig's (1965) *in vitro* experiments on particulate fractions of rat tissues have been reported as evidence that acridine orange stains lysosomes specifically. Considering the extensive work with thin sections reported here, this conclusion seems to be substantiated. However, it is also apparent that, as it now stands, acridine orange staining is not a self-sufficient vitality test (cf. Wolf and Aronson, 1961). More specifically, if all classes of lysosomes are stained by acridine orange then any pattern of fluorescing spots will include those arising from primary lysosomes, which are normal cytoplasmic organelles and are not indicative of cell death. Consequently, the apparent degree of cell death may be greatly overestimated by this method, which could lead to a spurious attribution of morphogenetic significance to cell death in a system. This suggests a possible explanation for the existence of contradictory views on the importance of cell death in normal imaginal disc development. Using the acridine orange procedure, Sprey (1971) felt he had detected morphogenetic cell death in the mature *wild-type* wing disc, a conclusion which has been widely quoted. The results obtained here with thin-sectioned material indicate that although there is more cell death in eye-antennal than in leg and wing discs from mature control *ts228* larvae (Table XIV, Results), no extensive degeneration occurs in any of these discs. This latter aspect is in agreement with the results of Poodry and Schneiderman (1970) for *wild-type* leg discs, and Fristrom (1969) for *wild-type* wing and

eye-antennal discs. These considerations cast doubt on the notion of morphogenetic cell death in the mature eye-antennal, leg and wing discs of *Drosophila melanogaster*.

Furthermore, the acridine orange procedure may lead to artifactual results through post-operative degeneration. Under the microscope a progressive increase in fluorescence was observed with time. This may be accounted for by the fact that the method does not employ fixation and consequently cellular degeneration can proceed unrestricted

following dissection of a disc from a larva.

Finally, when acridine orange staining is applied to an intact tissue or organ, such as an imaginal disc, the problem of differential permeation must be considered. If the distribution of fluorescing spots is to be taken as indicative of the locations of cell death, then one assumption is that all regions within the disc are equally accessible to the stain molecules. The basement lamina surrounding an intact disc may restrict the rate of entry of stain and, along with the folded nature of the epithelium, could result in regional concentration differences of stain within the disc. The same problem was suggested with regard to the results obtained with trypan blue staining of whole discs. The complete lack of resolution and apparent diffusion of stain attained with the latter method can be seen in Figures 6 and 7 of Arking (1975). For these reasons the vital staining methods were abandoned.

The above problems led to the adoption of thin epoxy sections stained with toluidine blue for a more detailed investigation of cell death in imaginal discs. By this method the various difficulties associated with paraffin sections and vital staining were overcome.

The immediate fixation of dissected disc complexes ensured that post-operative degeneration did not occur. Staining of sectioned material also eliminated the possibility that cell death might go undetected because of stain permeation problems. Furthermore, it permitted, through serial section reconstruction, an accurate localization of the cellular degeneration within the disc. The gentle double fixation employed preserved cellular and sub-cellular detail thereby allowing combined light and electron microscopic examination. This latter feature enabled the positive identification of bodies thought to be indicative of cellular degeneration. These same bodies were observed by Fristrom (1969) in the discs of various *Drosophila* mutants which exhibit cuticular deficiency phenotypes. She referred to these simply as "degenerating cells." Here a more positive identification, based on electron microscopic observations of adjacent ultrathin sections (see, for example, Fig. 16, a-f, in the Results) and acid phosphatase histochemistry, has been made. The bodies were resolved under the light microscope as members of two more or less distinct classes of cytoplasmic basophilia (see Table XIII, Results): one consisting of late secondary and post-lysosomes (Type I bodies), and the other of early secondary lysosomes (Type II bodies). Together these in all probability represent the bodies which, because of the problem of resolution in wax sections, have been referred to in the literature as pycnotic nuclei.

Thus, the cellular degeneration occurring in heat-treated *ts726* imaginal discs in all probability proceeds by the lysosomal cycle as it has been described, on the basis of ultrastructural studies, in other systems (Dingle and Fell, 1969; Daems, Wisse and Brederoo, 1972)..

Briefly, a dying cell or cell fragment is taken up by a neighboring epithelial cell. This fragment fuses with one or more primary lysosomes thereby forming an early secondary lysosome in which enzymatic degradation occurs. Further fusion of primary and secondary lysosomes may ensue until the digestive capacity of the body has been saturated and a late secondary lysosome has been formed. Upon cessation of enzymatic degradation the body, now known as a post-lysosome (residual body), contains only indigestible residues, and may be egested from the cell (see Fig. 12, Results).

The cytoplasmic basophilia scored here as being indicative of cellular degeneration (that is, the Type I bodies) were identified ultrastructurally as late secondary and post-lysosomes (Table XIII, Results). In a homogeneous cell population a direct proportionality between the number of cells killed and the number of Type I bodies produced may be assumed. This has enabled me, by counting the number of Type I bodies observed under the light microscope in toluidine blue-stained thin epoxy sections, to quantify, accurately and reliably, the relative extent of cellular degeneration within imaginal discs. In the absence of evidence to the contrary on the absolute relationship between cell death and Type I body production, I suggest here a reasonable proportionality factor would be one Type I body per dead cell.

#### Tissue Specificity of the Cell Lethality in Restrictive Temperature Pulsed *ta726* Larvae

A variety of evidence suggests that a restrictive temperature pulse of 48 hours duration during larval life does not cause extensive cell death in *ta726* larval tissues, excluding brain. Larval survival, body

weights (unpublished data) and morphological features in sections and upon dissection all suggest ostensibly normal larval development. Furthermore, *ts226* larvae maintained continually at the restrictive temperature survived for up to 10 days although none attained pupariation (Table IV, Results). By contrast, evidence presented above conclusively demonstrates the presence of induced cell death in the imaginal discs of *ts226* larvae subjected to a restrictive temperature pulse. Extensive cellular degeneration, significantly above control levels, was found in all imaginal discs examined (eye-antennal, all three legs, wing and haltere) (see, for example, Tables XIV and XV, Results) and in the cellular cortex of the brain hemisphere. That this cell death was not simply due to the temperature treatment, rather than the *ts* lethal itself, was indicated by the use of several controls. Pulsed non-mutant larvae (*tsm<sup>3</sup>* males and attached X females) showed the same low levels of cell death in their imaginal discs as unpulsed *ts226* larvae. Apparently then the lethal effect associated with *ts226* shows considerable tissue specificity in temperature pulse experiments.

These results suggest that it is the mitotically active cell types which are primarily affected by the restrictive temperature pulse. The imaginal discs and brain, which grow by cell division during larval life, are affected, while the larval tissues, which grow predominantly by increase in cell size, seem not to be.

In contrast to the imaginal discs themselves, the abdominal histoblasts begin an extremely rapid cellular proliferation at pupariation, with an average cell cycle for the tergites of only 2.7 hours (García-Bellido, 1973). Thus, if mitotically active cell types are

indeed more sensitive to restrictive temperature-induced cell death, then, since the TSP for lethality in *ts226* extends beyond puparium formation, one would predict that cell death in the imaginal abdomen would be induced by appropriately administered 29°C pulses. Extensive abdominal cuticular deficiencies in such experiments (Table VII, part B) suggest that indeed cell death was induced, while earlier pulses, applied when the histoblasts were not proliferating, produced no abdominal defects. However, it might be argued that the abdominal deficiencies observed in these experiments result simply from a block in differentiation rather than from induced cell death. A histological investigation of the histoblasts after a restrictive temperature pulse late in the TSP would settle this question.

With these considerations in mind it is interesting to consider the suggestion which has been repeatedly made, that mutations at the *su(f)* locus (1-65.9) affect protein synthesis (Schalet, 1970, 1973; Dudick, 1973; Wright, 1973). Finnerty et al. (1973) and Dudick et al. (1974) have suggested that the locus is involved in the production of a ribosomal protein. However, Lambertson's (1975) investigation of the ribosomal proteins in the *ts67* allele failed to confirm this notion. Instead, he reports a delay in the transition from the larval to the imaginal complement of proteins and a reduction in the amount of ribosomes present.

These effects may reflect a partially defective protein synthesizing apparatus in this mutant. Based on a comparative phenotypic characterization, it can be hypothesized that the *ts726* allele results in even more severely defective protein synthesis. In temperature shift experiments, survival to eclosion is less in *ts726* than in *ts67* (Russell, 1974;



Dudick et al., 1974), and *ts726* produces imaginal cuticular abnormalities of a much greater variety, increased severity, and at higher frequencies than *ts67* (see Tables VII, VIII and X, Results). The TSP of *ts726* is broader, and stage distributed mortalities at the restrictive temperature were found to be, on the average, earlier for *ts726*. Thus, if these mutants are directly affecting the efficiency of protein synthesis, then the observed tissue specificity for *ts726* would imply that mitotically active cells are more strictly dependent upon protein synthesis for viability.

#### Extent and Distribution of Cell Death in *ts726* Imaginal Discs

The purpose of the research reported in this thesis was to test and elaborate the hypothesis that cell death in the imaginal discs of *ts726* accounts for its cuticular effects. Cuticular abnormalities were restricted to the derivatives of the eye-antennal and leg discs following a 96-144 hour 29°C pulse. Induced cell death was detected in both of these discs (see Table XIV, Results) after such a temperature treatment. However, induced cell death was also detected in the other discs examined, that is, the wing and haltere discs, the cuticular derivatives of which exhibited no abnormalities. This latter result suggests that the presence of induced cell death in an imaginal disc is not a sufficient condition for the production of a cuticular abnormality.

The question which now arises is what causes some discs with cell death to give rise to cuticular abnormalities while others fail to do so. One possible explanation would be that the amount of cell death present is the critical factor. On the basis of this hypothesis one would

predict that those discs with the most cell death would produce cuticular deficiencies most frequently. The following data were obtained for a 96-144 hour restrictive temperature pulse. For *ts726*, the eye-antennal disc showed the greatest extent of cellular degeneration in reconstructions. Its average Type I body frequency per section was 6.03 as compared to 1.22 for leg discs (data from Table XIV, Results). The reconstruction data for the wing disc are insufficient for it to enter this comparison. The overall frequency of *ts726* eye-antennal discs producing a deficiency was 38.9%, while only 0.6% legs exhibited a cuticular abnormality, and no wings did. The extent of cell death in leg and wing discs could not be distinguished from that in controls. Cell death in the eye-antennal disc was only elevated about 2-4-fold over control levels. No cuticular abnormalities were detected in the derivatives of any of the *ts67* discs treated at this stage (see Table XIII, Results). These results are tabulated below:

mutant	disc	percentage of discs giving rise to an abnormality	av. no. of Type I bodies per section, ratio heat-treated/control
<i>ts726</i>	eye-antennal	38.9	5.11
	leg	0.6	3.59
	wing	0	> 1
<i>ts67</i>	eye-antennal	0	≈ 2-4
	other	0	≈ 1

This comparison confirms that discs with greater than control levels of cell death, such as *ts726* wing and *ts67* eye-antennal, do not necessarily produce cuticular abnormalities. Furthermore, although all *ts726*

eye-antennal, leg and wing discs sectioned showed evidence of restrictive temperature-induced cell death, only 38.9% of the heads and 0.6% of the legs from surviving and pharate adults had cuticular abnormalities. This suggests that the discs have considerable regulative capacities. Despite this regulation, the results agree in general with the notion that the amount of cell death is directly related to the production of cuticular abnormalities.

Evidence from the literature bears on the question. With 1000 r of X-rays Postlethwait and Schneiderman (1973) found that irradiation of any stage later than early first instar larvae resulted in no cuticular abnormalities at all. According to Haynie (cited in Simpson and Schneiderman, 1975), a dose of 1000 r kills about 30% of the cells in an imaginal disc. Thus, at any stage after the early first larval instar, discs can sustain 30% cell death and still give rise to normal imaginal cuticular patterns. This again indicates regulation. Yet, a restrictive temperature pulse administered to *ts726* larvae during the TSP produces extensive cuticular abnormalities in the adult head and legs. From Table XV (Results) the average frequency of Type I bodies per disc cell is only 0.13 in the eye-antennal discs following such a pulse. Thus, if the proportionality factor suggested above of one Type I body per dead cell is at all close to the real relationship, then the total cell death in *ts726* which results in cuticular abnormalities is less than that induced by 1000 r of X-rays which fail to cause the abnormalities. Consequently, extent of cell death alone apparently fails to account for the production of cuticular deficiencies and duplications.

One hypothesis to account for the production of cuticular abnormalities by the cell death in *ts726* imaginal discs would be that these effects

result specifically from cellular degeneration that is localized or concentrated in a particular region or regions of the disc epithelium. A prediction of this hypothesis would be that in those discs whose cuticular derivatives show deficiencies and duplications one should find localized cell death. The data for *ts726* provide a ~~control~~ of this hypothesis. The imaginal cuticular structures most frequently deficient or duplicated were derived from the eye-antennal disc. The histological data for the eye-antennal disc indicate that localized cell death was present in each disc reconstructed (see Fig. 24 Results), while certain other disc regions showed only control (low) levels of death (see Table XV, Results). The data for the leg (Fig. 20, Results) and wing (Fig. 18, Results) discs suggest less obvious localization of cell death and their cuticular derivatives were less frequently abnormal. These results are consistent with the hypothesis that localized cell death is required in an imaginal disc for cuticular deficiencies and duplications to be induced. Additional support for this hypothesis comes from gynandromorph data involving *ts726*. Russell (personal communication) found that the frequency of cuticular abnormalities in derivatives of discs which were mosaics of mutant and non-mutant cells increased significantly relative to those from discs comprised entirely of *ts726* tissue. Since the mutant is a cell-autonomous lethal, mosaicism would tend to enhance the localization of cell death in the imaginal discs, which on the basis of the above hypothesis would account for the observed increased frequency of abnormalities. The hypothesis also provides an explanation why 1000 r of X-rays fail to induce the abnormalities. Although whole organism irradiation causes extensive cellular degeneration in discs, it does not


induce localized cell death when applied to developing larvae (Sprey, 1971). That localized cell death has been detected in the discs of various mutants which exhibit cuticular deficiencies (Fristrom, 1969) provides additional support for the hypothesis of a localized cell death effect.

The question which now arises concerns the mechanism(s) by which localized cell death in imaginal discs produces cuticular abnormalities. The cuticular effects observed include both deficiencies and duplications. The deficiencies are observed more frequently and are often unaccompanied by duplications, while the duplications occur almost exclusively in association with deficiencies. Consequently, deficiencies are considered the primary, and duplications secondary, effects (cf. Russell, 1974). The production of deficiencies will be dealt with first.

An obvious hypothesis to account for the induction of deficiencies by localized cell death would be that presumptive hypodermal cells are directly eliminated from the disc epithelium by the cell death. On the basis of this hypothesis it would be predicted that the site(s) of localized cell death would be directly correlated, through a fate map of the disc, with the cuticular structure(s) most frequently deficient. Here again the reconstruction data for the eye-antennal disc can be drawn on for evidence, but first it is important to consider the theoretically possible distributions of cell death. These include uniform, random and patterned types as well as any combination of these. A uniform distribution of cell death would exist if there was an even spacing of cells killed in the disc epithelium. By definition such a distribution would show no localization. Random cell death would occur if the probability that a given cell would be killed was equal for all

cells in the disc. In this case the death of a cell would be an event completely independent of the state of the other cells in the disc. Consequently, on the basis of statistical considerations, such random cell death would be expected to generate localized cell death at a frequency dependent upon the probability of death for the cells and the number of cells in the system. However, these localized effects would not occur in any preferred position within the epithelium and different discs would show different distributions. On the other hand, in a patterned distribution of cell death, the probability that a cell might die would vary from region to region in the disc, and therefore the distribution of cellular degeneration would be constant from disc to disc.

The results for the eye-antennal disc seem to indicate a combination of both random and patterned distributions of cell death (see reconstructions, Fig. 24, Results). Localized concentrations of cell death occurred in the eye facet-forming region in most of the reconstructions and in the vibrissae-forming part in about three quarters of them. Cell death in the remainder of the disc appeared randomly distributed.

On the basis of the observed tissue specificity of cell lethality in *ts726* and its distribution within the imaginal discs, one might speculate that the localized death observed in heat-treated discs might arise as a consequence of differential regional cell division rates such that the comparatively rapidly dividing cells suffer greater lethality. Whereas the overall rate of increase in cell number, as estimated by induced mitotic recombination, appear  for the major discs

(Nöthiger, 1972), regional differences in mitotic activity within various discs have been detected. Becker (1957) has shown that among twin spots induced during the first larval instar in the eye, clones in the anterior region consistently exceeded in size their partners in the posterior region. Similar observations have been made for the antennal disc (Postlethwait and Schneiderman, 1971) where clones were found to be larger in the ventral than in the dorsal part of the third antennal segment, and for the wing disc (Garcia-Bellido and Merriam, 1971b) where they were larger in the posterior than in the anterior part of the wing blade.

Cuticular deficiency frequencies in surviving and pharate adults were highest for the eye facets (0.47, Table X, Results). Vibrissae were scored as deficient in 2% of the observed 4-heads; however, the method of detection of these did not involve exact bristle counts and consequently might have resulted in slight deficiencies going unnoticed. On the other hand, the regulative capacities of the disc may account for the apparent paucity of vibrissae deficiencies. Other cuticular structures of the head were deficient only at low frequencies or not at all and can best be accounted for on the basis of random cell death.

Based on the hypothesis of localized cell death-induced cuticular deficiencies, expected 4-head cuticular patterns could be predicted from the eye-antennal disc reconstructions. This was done by setting the level of cell death required to induce a deficiency at various arbitrary thresholds. The best fit of predicted with observed patterns was obtained with the threshold at the level of 12 Type I bodies-per grid square (see Fig. 25). That this high level of cell death is required to induce

a deficiency again demonstrates considerable regulative potential in the disc. From eight reconstructions of heat-treated discs it was found that when this threshold level was employed the predicted  $\frac{1}{2}$ -head types overlapped 182 (72.2%) of the total of 252 observed, as shown in Table XVI, and accounted for most of the commonly observed cuticular deficiency patterns (see Table XII, Results). Thus, it would appear that cuticular deficiencies result from a direct effect of localized concentrations of cell death.

With these considerations for deficiencies, duplications can now be considered. That duplicated cuticular structures were observed almost exclusively in association with deficiencies suggests the following mechanism by which duplication might occur. If restrictive temperature-induced cell death was to stimulate cell proliferation, duplicated patterns might somehow result from this subsequent growth within the disc. That X-ray-induced cell death is followed by 'regulative cell division' is reflected in an increase in clone size with dose of irradiation (Schweizer, 1972). It can be hypothesized that the induction of localized cell death in heat-treated *ts22c* imaginal discs accounts for pattern duplication through induced growth in adjacent disc regions. This suggestion is supported by the data for cuticular abnormality frequencies in the eye-antennal disc (Table X, Fig. 3, Results) which show that, in general, duplication and deficiency frequencies bear an inverse relationship (cf. Russell, 1974). Those structures which were found to duplicate most frequently, the fronto-orbital and orbital bristles, are derived from regions of the disc with comparatively less cell death adjacent to the anterior eye facet-forming region in which extensive



Table XVI. Fit of Predicted with Observed  $\frac{1}{2}$ -Head Cuticular Deficiencies in

96-144 Hour 29°C Pulsed  $\frac{1}{2}$ 72E

Reconstruction Designation <sup>1</sup>	Deficiency Prediction	Common $\frac{1}{2}$ -Head Type <sup>2</sup>	Number (and Frequency) of Observed $\frac{1}{2}$ -Heads	Cumulative Number (and Frequency) of Observed $\frac{1}{2}$ -Heads Accounted For
c	No cuticular deficiency	A	129 (0.512)	129 (0.512)
e				
f				
g				
h				
d	Lower eye facet deficiency	B	29 (0.115)	158 (0.627)
b	Anterior eye facet deficiency	E, F and H	23 (0.091)	181 (0.715)
a	Anterior and lower eye facet deficiencies, vibrissae deficiency	-	1 (0.004)	182 (0.722)

<sup>1</sup>Heat-treated eye-antennal disc<sup>3</sup> reconstructions are presented in Fig. 24 (Results).

<sup>2</sup>Classification of most commonly observed  $\frac{1}{2}$ -head types is given in Table 1 (Results).

degeneration was found to occur frequently (Fig. 26, Results). In fact, all fronto-orbital and orbital duplications observed here were associated with anterior eye facet deficiencies. That duplications occur in other *ts* cell lethals (Russell, 1971; Arking, 1975) and, indeed, in various non-conditional mutants, is consistent with this proposed mechanism of pattern duplication. Additional support comes from the fact that heat treatments administered to *ts728* earlier in development, for instance at 72 hours, which allow more time for growth in the disc subsequent to the induced cell death, result in higher duplication frequencies (Table VII, Results).

From the above considerations it would appear that following localized cell death in an imaginal disc one of two distinct developmental pathways will be taken. Either the disc will give rise to a normal pattern of cuticular structures, through regulation or regeneration, or it will produce deficiencies and sometimes duplications. The problem is to find out what 'decides' which pathway will be taken.

Various theoretical models proposed to account for pattern deficiencies and duplications in discs can be applied to this problem. These can be called upon to make distinct predictions regarding the relationship between cell death in *ts728* discs and resulting cuticular abnormalities. Although a chemical correlate has proved elusive, the interpretation of pattern formation in terms of gradients has been popular in recent years because of their elegant simplicity and remarkable facility in accounting for experimental data. Bryant (1971) and Ouweneel (1972) have proposed similar 'gradient' models for the specification of positional information in imaginal discs (see p. 16, Introduction). On

the basis of Bryant's 'gradient of developmental capacity,' disc fragments are unable to regenerate higher gradient levels and consequently a sufficient condition for the production of a deficiency in 2072 would be the effective removal of a gradient 'high point' by localized cell death. Duplications are accounted for in the model by replication of a disc fragment's existing gradient levels in the new growth arising from it. Therefore, Bryant would predict that localized concentrations of cell death would be found in duplicating 2072 discs, but not in regions that produce duplicate structures. Alternatively, according to Quenecel (1972) the size of the disc at the time of differentiation directly specifies its positional information. He assumes that when disc size is reduced a symmetrical gradient is formed, which accounts for duplications, but higher values of positional information are lost in the process, which accounts for deficiencies. On the basis of this model, 2072 would simply have to reduce disc size to produce cuticular abnormalities and cell death would not have to be in any specific part of the disc. In 2072, the parts of the head which were never deficient, such as the antennae and palps, are derived from regions of the eye-antennal disc which in reconstructions do not show extensive cell death (Fig. 26, Table XV, Results). The data demonstrate a direct correlation of the positions of localized cell death in the disc with those of the cuticular deficiencies in the head (compare Figs. 25b and 26b, Results). Those structures most frequently duplicated, the fronto-orbitals and orbitals, are from parts of the disc with relatively less cell death adjacent to localized concentrations. Thus, the results are exactly what Bryant would predict even when considered in some detail, and on the basis

of the gradient of developmental capacity would suggest that the eye facet-forming region, which (i) gives rise to deficiencies most frequently, (ii) apparently never duplicates, and (iii) is surrounded by regions which do duplicate, should include a gradient high point. This prediction from the *te226* data is consistent with the transplantation data for the eye-antennal disc in which the duplication and regeneration properties of *te226* disc fragments have been assayed (Gehring, 1966, 1972).

The gradient of developmental capacity model also suggests an explanation for cuticular abnormality frequency differences observed among different discs in *te226*. From transplantation experiments the locations of hypothetical gradient high points have been quite accurately pinpointed in the leg (Schubiger, 1971) and wing (Bryant, 1975) discs. For the leg it is found somewhere in the anterior medial quarter of the disc. The contour map of cell death in heat-treated *te226* leg discs (see Fig. 22, Results) suggests that this is not a region in which localized cell death frequently occurs. The high point for the wing is near the anlagen for a group of 12 sensilla campaniformia on the dorsal wing hinge (SC12 in Fig. 17, Results). Thus, the reduced abnormality frequencies in derivatives of these discs may result from a lower frequency of occurrence of localized cell death in their high point regions after a restrictive temperature pulse. Both patterned and random cell death distributions could generate such an effect. Localized cell death induced in other regions of these discs may not be expressed later as cuticular deficiencies because of regeneration from higher gradient levels present in the remainder of the disc. This, then,

an account for how the decision is made as to whether discs with localized cell death will give rise to normal or abnormal cuticular patterns.

### General Implications for Pattern Formation Theory

The results discussed above can now be related to the general theory of pattern formation. The term 'positional information' has been proposed to describe what a cell needs to 'know' in order to differentiate appropriately in a pattern. Various mechanisms, including morphogenetic gradients, developmental compartmentalization, and inductive fields (see Introduction), have been suggested to account for the specification of positional information. For each of these processes there exists a body of supporting evidence but their functional significance in pattern formation in general is not known. It is possible that any particular developmental system may involve more than one of these mechanisms.

The fact that in imaginal discs differentiation is temporally separated from the specification of positional information permits an experimental approach not available in other systems. Pattern duplication following surgical bisection of mature discs may be interpreted as evidence for an underlying gradient of positional information (see, for instance, Bryant, 1974). Geigy (1951) has shown that ultraviolet microbeam irradiation of 7-17 hour (post-gastrula) embryos in *Drosophila* can result in imaginal cuticular duplications. Wieschaus (1974) has shown that 1000 r of X-rays applied as early as 7 hours after oviposition also results in some duplicated cuticular patterns. The same dose of X-rays is also effective throughout the remainder of

embryogenesis and into the early first larval instar (Postlethwait and Schneiderman, 1933), while a much higher dose (7000 r) has a similar effect when applied to late second and early third instar larvae (Waddington, 1942). Restrictive temperature pulses in *Drosophila* cause duplications when applied any time from early second to late third instar (Russell, personal communication). Thus, it appears that given the appropriate experimental conditions imaginal-cuticular duplications can be induced any time from early embryogenesis through to larval maturity. One interpretation of these results is that gradients of developmental capacity are present from the time the initial populations of cells (or nuclei) are determined to become discs.

An alternative interpretation of the experimental production of duplicated patterns is based on the concept of regulation in an inductive field (see Counce, 1973). Here, duplications are thought to arise by the splitting of an inductive field into two portions and subsequent regulation in each of these such that two patterns develop where normally there would be only one.

The formal distinction between these two interpretations is that in the first, duplications arise via *regeneration* in a system in which positional information is already specified, while in the second, the specification process is assumed to occur subsequent to a separation into two independent fields. Experimentally, the distinction may be made on the basis of the position of 'duplication-inducing' cell death in relation to the fate map. By the gradient model cell death would be predicted in those parts of the disc corresponding to the deficient cuticular structures, but not in duplicating regions. The results

described in this thesis for *eye-antennal* discs support this model. Since various experimental treatments known to cause cell death can induce exactly the same phenotypes from very early stages in development right through to disc maturity, perhaps the 'regulative' capacities of discs should really be thought of in terms of regeneration, and gradients as prepatterns which direct regeneration. From this conceptual viewpoint, any experimental intervention which ablates the high point of such a gradient would create a new prepattern of positional information. This resolves the paradox of how a cell-autonomous lethal mutant, such as *eye-antennal*, can result in non-autonomous pattern formation and therefore fit the definition of a prepattern mutant.

## REFERENCES

- Anastasia-Sawicki, J. (1974) Ultrastructural histochemical localization of acid phosphatase in salivary glands of *Drosophila melanogaster*. *Proc. Inform. Serv.* 51: 40-1.
- Apter, M.J. and Wolpert, L. (1965) Cybernetics and development. I. Information theory. *J. theor. Biol.* 8: 244-57.
- Arking, R. (1975) Temperature-sensitive cell-lethal mutants of *Drosophila*: isolation and characterization. *Genetics* 80: 519-37.
- Auerbach, C. (1936) The development of the legs, wings, and halteres in wild-type and some mutant strains of *Drosophila melanogaster*. *Trans. Roy. Soc. Edinburgh* 58: 787-815.
- Beck, F., Lloyd, J.B., and Squier, C.A. (1972) Histochemistry. In J.T. Dingle (ed.), *Lysosomes: A Laboratory Handbook*. Amsterdam: North-Holland Pub. Co.
- Becker, H.J. (1957) Über Löntgenmosaikflecken und Defektmutationen am Auge von *Drosophila* und die Entwicklungsphysiologie des Auges. *Z. Vererb.-Lehre* 88: 333-73.
- Bodenstein, D. (1950) The postembryonic development of *Drosophila*. In M. Demerec (ed.), *Biology of Drosophila*. New York: Hafner Pub. Co.
- Bodenstein, D. and Abdel-Malek, A. (1949) The induction of *antistopedia* by nitrogen mustard in *Drosophila melanogaster*. *J. Exp. Zool.* 111: 95-114.
- Bowles, M. (1975) Adult deficiencies and duplications of head and thoracic structures resulting from microcautery of blastoderm stage *Drosophila* embryos. *J. Embryol. exp. Morph.* 34: 33-54.



- Brehme, K.S. (1941) Development of the *Minute* phenotype in *Drosophila melanogaster*. A comparative study of the growth of three *Minute* mutants. J. Exp. Zool. 88: 135-60.
- Bryant, P.J. (1970) Cell lineage relationships in the imaginal wing disc of *Drosophila melanogaster*. Dev. Biol. 22: 389-411.
- \_\_\_\_\_ (1974) Determination and pattern formation in the imaginal discs of *Drosophila*. In A. Moscona and A. Monroy (eds.), Current Topics in Developmental Biology, vol. 8. New York: Academic Press.
- \_\_\_\_\_ (1975) Pattern formation in the imaginal wing disc of *Drosophila melanogaster*: fate map, regeneration and duplication. J. Exp. Zool. 193: 49-78.
- Bryant, P.J. and Schneiderman, H.A. (1969) Cell lineage, growth and Determination in the imaginal leg discs of *Drosophila melanogaster*. Dev. Biol. 20: 263-79.
- Chan, L.-N. and Gehring, W. (1971) Determination of blastoderm cells in *Drosophila melanogaster*. PNAS (Wash.) 68: 2217-21.
- Chen, T.-Y. (1929) On the development of imaginal buds in normal and mutant *Drosophila melanogaster*. J. Morph. 47: 135-99.
- Chiarodo, A.J. (1963) The effects of mesothoracic leg disc extirpation on the postembryonic development of the nervous system of the blowfly, *Sarcophaga bullata*. J. Exp. Zool. 153: 263-78.
- Claxton, J.H. (1969) Mosaic analysis of bristle displacement in *Drosophila*. Genetics 63: 883-96.
- Counce, S.J. (1973) The causal analysis of insect embryogenesis. In S.J. Counce and C.H. Waddington (eds.), vol. II Developmental Systems: Insects. London: Academic Press.

- Daems, W., Wisse, E., and Brederoo, P. (1972) Electron microscopy of the vacuolar apparatus. In: J.T. Dingle (ed.), *Lysosomes: A Laboratory Handbook*. Amsterdam: North-Holland Pub. Co.
- Datta, R.K. and Mukherjee, A.S. (1971) Developmental genetics of the mutant *forked* in *Drosophila melanogaster*. I. Effect on the morphology and chaetotaxy of the prothoracic leg. *Genetics* 68: 269-86.
- Duve, C. and Wattiaux, R. (1966) Functions of lysosomes. *A. Rev. Physiol.* 28: 435-92.
- Demerec, M. and Kaufman, B.P. (1950) *Drosophila* Guide. 5th ed. Washington, D.C.: Carnegie Inst. of Washington.
- DeRenzis, F.A. and Schechtman, A. (1973) Staining by neutral red and trypan blue in sequence for assaying vital and nonvital cultured cells. *Stain Tech.* 48: 135-6.
- Dingle, J.T. and Fell, H.B. (eds.) (1969) *Lysosomes in Biology and Pathology*. Amsterdam: North-Holland Pub. Co.
- Dübendorfer, A. (1971) Untersuchungen zum Anlageplan und Determinationszustand der weiblichen Genital- und Analprimordien von *Musca domestica* L. *Wilhelm Roux' Arch.* 168: 142-68.
- Dudick, M.E. (1973) A temperature sensitive allele of a suppressor gene in *Drosophila*. M.A. Thesis, University of Virginia, Charlottesville.
- Dudick, M.E., Wright, T., and Brothers, L. (1974) The developmental genetics of the temperature-sensitive lethal allele of the suppressor-of-forked, *U(1) su(f)<sup>ts67g</sup>*, in *Drosophila melanogaster*. *Genetics* 76: 487-510.
- Emmel, V.M. and Cowdry, E.V. (1964) *Laboratory Technique in Biology and Medicine*. 4th ed. Baltimore: Williams & Wilkins Co.

- Lphrussi, B. and Beadle, G.W. (1956) A technique of transplantation for *Drosophila*. *Am. Natur.* 70: 218-25.
- Ferris, G.L. (1950) External morphology of the adult. In M. Demerec, (ed.), *Biology of Drosophila*. New York: Hafner Pub. Co.
- Finnerty, V.G., Barton, L.M., Schalet, A., Elmer, W., and Smith, P. (1965) The *eng* gene *eng<sup>1</sup>* mutation: a putative protein synthesis mutant in *Drosophila melanogaster*. *Genetics* 74S: 79.
- Fristrom, D. (1968) Cellular degeneration in wing development of the mutant *ventral* of *Drosophila melanogaster*. *J. Cell Biol.* 39: 488-91.
- \_\_\_\_\_ (1969) Cellular degeneration in the production of some mutant phenotypes in *Drosophila melanogaster*. *Molec. gen. Genet.* 103: 363-79.
- Fristrom, D. and Fristrom, J.W. (1975) The mechanism of evagination of imaginal discs of *Drosophila melanogaster*. *Dev. Biol.* 43: 1-23.
- Gaff, D.F. and Okong'O-Ogola, O. (1971) The use of non-permeating pigments for testing the survival of cells. *J. Exp. Bot.* 22: 756-8.
- Ganin, M. (1876) Materials for a knowledge of the postembryonic development of insects. *Am. Natur.* 11: 423-30.
- Garcia-Bellido, A. (1972) Pattern formation in imaginal discs. In H. Ursprung and R. Nöthiger (eds.), *Results and Problems in Cell Differentiation V*. Germany: Springer.
- \_\_\_\_\_ (1973) The corrected number of adult epidermal cells of the tergites. *Proc. Inform. Serv.* 50: 99.
- \_\_\_\_\_ (1975) Genetic control of wing disc development in

- Drosophila*. In R. Porter and J. Rivers (eds.), Cell Patterning, Ciba Foundation Symp. 29 (new series).
- García-Bellido, A. and Merriam, J.R. (1971a) Clonal parameters of tergaite development in *Drosophila*. *Dev. Biol.* 26: 264-76.
- \_\_\_\_\_ (1971b) Parameters of the wing imaginal disc development of *Drosophila melanogaster*. *Dev. Biol.* 24: 61-87.
- García-Bellido, A., Ripoll, P., and Morata, G. (1973) Developmental compartmentalisation of the wing disk of *Drosophila*. *Nature New Biology* 245: 251-3.
- Gateff, I. and Schneiderman, H.A. (1969) Neoplasms in mutant and cultured *Drosophila* tissues of *Drosophila*. National (USA) Cancer Inst. Monograph 31: 365-97.
- \_\_\_\_\_ (1973) Developmental capacities of immature eye antennal imaginal discs of *Drosophila melanogaster*. *Wilhelm Roux' Arch.* 176: 171-89.
- Gehring, W.J. (1964) Phenocopies produced by 5-fluorouracil. *Dev. Inform. Serv.* 39: 102.
- \_\_\_\_\_ (1966) Übertragung und Änderung der Determinationsqualitäten in Antennenscheiben-Kulturen von *Drosophila melanogaster*. *J. Embryol. exp. Morph.* 15: 77-111.
- \_\_\_\_\_ (1972) The stability of the determined state in cultures of imaginal discs in *Drosophila*. In H. Ursprung and R. Nöthiger (eds.), *Results and Problems in Cell Differentiation*. Germany: Springer.
- Gehring, W.J. and Nöthiger, R. (1973) The imaginal discs of *Drosophila*. In S.J. Counce and C.H. Waddington (eds.), vol. II. *Developmental Systems: Insects*. London: Academic Press.

- Gehring, W.J. and Scrpel, S. (1967) Die Imaginalzellen des Clypeo Labrums und die Bildung des Brustels von *Drosophila melanogaster*. Rev. Suisse Zool. 74: 589-96.
- Geigy, R. (1931) Erzeugung rein imaginaler Defekte durch ultraviolette Lichtstrahlung bei *Drosophila melanogaster*. Wilhelm Roux' Arch. 125: 406-47.
- Gersh, I. (1968) cited in textbook of Histology, 9th ed. W. Bloom and D.W. Lawcett (eds.) p. 15. Philadelphia: W.B. Saunders.
- Goldschmidt, R.B. and Pitternick, L.K. (1957) The genetic background of chemically induced phenocopies in *Drosophila*. J. Exp. Zool. 135: 127-202.
- Gomori, G. (1952) Microscopic Histochemistry: Principles and Practice. Chicago: University of Chicago Press.
- Gottlieb, E.J. (1964) Genetic control of pattern determination in *Drosophila*. The action of *hairy-~~1~~*. Genetics 49: 759-60.
- \_\_\_\_\_ (1966) Punctureless preparation of insect specimens. J. Roy. Microscopical Soc. 85: 569-73.
- Green, S.M. and Lawrence, P.A. (1975) Recruitment of epidermal cells by the developing eye of *Drosophila* (Hemiptera). Wilhelm Roux' Arch. 177: 61-5.
- Guerra, M., Postlethwait, J.H., and Schneiderman, H.A. (1973) The development of the imaginal abdomen of *Drosophila melanogaster*. Dev. Biol. 32: 361-72.
- Hadorn, E. (1963) Differenzierungsleistungen wiederholt fragmentierter Teilstücke männlicher Genitalscheiben von *Drosophila melanogaster* nach Kultur *in vivo*. Dev. Biol. 7: 617-29.
- \_\_\_\_\_ (1965) Problems of determination and transdetermination.

Brookhaven Symp. Biol. 18: 148-61.

(1966) Über eine Änderung mütterbestimmender Qualitäten in einer Blastemkultur von *Drosophila melanogaster*. Rev. Suisse Zool. 73: 253-65.

Hadorn, E. and Buck, D. (1962) Über entwicklungsleistungen transplantierter Zellstücke von Flügelmaginalscheiben von *Drosophila melanogaster*. Rev. Suisse Zool. 69: 302-10.

Henke, K. (1947) Einfache Grundvorgänge in der tierischen Entwicklung. Naturwissenschaften 34: 149-57, 180-86.

Howland, R.B. and Sonnenblick, B.P. (1956) Experimental studies on development in *Drosophila melanogaster*. II. Regulation in the early egg. J. Exp. Zool. 73: 109-25.

Humason, G.F. (1972) Animal Tissue Techniques, 3rd ed. San Francisco: W.H. Freeman.

Igarashi, S. (1966) Temperature sensitive mutation in *Drosophila*. I. Induction and inheritance. Mutation Res. 3: 13-24.

Illmensee, K. (1972) Developmental potencies of nuclei from cleavage, preblastoderm and syncytial blastoderm transplanted into unfertilized eggs of *Drosophila melanogaster*. Wilhelm Roux' Arch. 170: 267-98.

Kaufman, T.C. and Suzuki, D.T. (1974) Temperature-sensitive mutations in *Drosophila melanogaster*. XX. Lethality due to translocations. Can. J. Genet. Cytol. 16: 579-92.

King, D.W., Paulson, S., Puckett, B., and Krebs, A. (1959) Cell death. IV. The effect of injury on the entrance of vital dyes in Ehrlich tumor cells. Am. J. Path. 35: 1067-79.

- Koenig, H. (1965) The staining of lysosomes by basic dyes. *J. Histochem. Cytochem.* 13: 20.
- Lebertson, A. (1975) The ribosomal proteins of *Drosophila melanogaster*. V. Analysis by 2-D gel electrophoresis of the ribosomal proteins of the ts-lethal allele of *suppressor- $\beta$* , *sup $\beta$ ts*, a putative ribosome protein mutant. *Molec. gen. genet.* 139: 45-56.
- Lugé, G. (1967) Origine et croissance du disque génital de *Drosophila melanogaster*. *C.R. Acad. Sci. (Paris)* 265: 811-17.
- Lawrence, P.A. (1970) Polarity and patterns in the postembryonic development of insects. *Advanc. Insect Physiol.* 7: 197-266.
- Lawrence, P.A. (1975) The development of spatial patterns in the integument of insects. In S.J. Conner and C.H. Waddington (eds.), *Developmental Systems: Insects*, v. II. London: Academic Press.
- Lees, A.D. (1941) Mutations in the pupal wing of *Drosophila melanogaster*. *J. Genet.* 42: 415-42.
- Lindsley, D. and Grell, E. (1968) Genetic variations of *Drosophila melanogaster*. Carnegie Inst. Wash. Publ. 627.
- Luyet, B.J. (1957) Differential staining for living and dead cells. *Science* 85: 106.
- Margulies, L. (1972) Actinomycin D-induced phenocopies in *Drosophila melanogaster* and their relevance to the time of gene action. *Genetica* 43: 207-22.
- Maunsbach, A.B. (1966) Observations on the ultrastructure and acid phosphatase activity of the cytoplasmic bodies in rat kidney proximal tubule cells. *J. Ultrastruct. Res.* 16: 197-238.
- Mayoh, H. and Suzuki, D.T. (1973) Temperature-sensitive mutations in

- ..... (1971) The genetic properties of sex-linked recessive cold-sensitive mutants. *Can. J. Genet. Cytol.* 15: 257-54.
- Machinome, M. and Kim, S. (1975) Cell death during the development of the imaginal discs in *Drosophila melanogaster*. *Japan. J. Genet.* 48: 307-10.
- Murphy, C. (1973) Determination of the dorsal mesothoracic disc in *Drosophila*. *Dev. Biol.* 15: 368-94.
- ..... (1972) Localization of the primordia within the dorsal mesothoracic disc of *Drosophila*. *J. Exp. Zool.* 179: 51-62.
- ..... (1974) Cell death and autonomous gene action in lethals affecting imaginal discs in *Drosophila melanogaster*. *Dev. Biol.* 39: 25-36.
- Nishi, D. and Bell, J. (1968) Larval age and pattern of DNA synthesis in polytene chromosomes. *Can. J. Genet. Cytol.* 10: 82-90.
- Nell, M.W. and Berner, M.W. (194a) Studies on acid hydrolases in adult and foetal tissues. I. Acid p-nitrophenyl phosphate phosphohydrolases of adult guinea-pig liver. *Biochem. J.* 92: 217-19.
- ..... (194b) Studies on acid hydrolases in adult and foetal tissues. 2. Acid phenyl phosphomonoesterases of adult mouse liver. *Biochem. J.* 93: 220-4.
- Nothiger, R. (1972) The larval development of imaginal discs. In H. Ursprung and R. Nothiger (eds.), *Results and Problems in Cell Differentiation V.* Germany: Springer.
- Nothiger, R. and Staub, S. (1972) Imaginal defects after UV-microbeam irradiation of early cleavage stages of *Drosophila melanogaster*. *Rev. Suisse Zool.* 79: 267-79.



- Novikoff, A.B. (1965). Lysosomes in the physiology and pathology of the cell; contribution of staining methods. In A. de Peuck and M. Cameron (eds.) Lysosomes. Ciba Found. Symp. London: J. and A. Churchill.
- Ouweneel, W.J. (1970). Developmental capacities of young and mature, *Drosophila*, and leg eye imaginal discs in *Drosophila melanogaster*. Wilhelm Roux' Arch. 166: 76-88.
- ..... (1972). Determination, regulation and positional information in insect development. Acta Biotheoretica 21: 115-31.
- Ouweneel, W.J. and van der Meer, J.M. (1975). Differentiation capacities of the dorsal metathoracic (halter) disc of *Drosophila melanogaster*. Wilhelm Roux' Arch. 172: 149-61.
- Pappenheimer, A.J. (1917). Experimental studies upon lymphocytes: The reactions of lymphocytes under various experimental conditions. J. Exp. Med. 25: 633-50.
- Pantin, C. (1946). Notes on Microscopical Technique for Zoologists. Cambridge: Cambridge University Press.
- Perry, M. (1968). Further studies on the development of the eye of *Drosophila melanogaster*. 1. The ommatidia. 2. The interommatidial bristles. J. Morph. 124: 227-61.
- Poodry, C., Hall, L., and Suzuki, D.T. (1975). Developmental properties of *shib<sup>1</sup>*; a pleiotropic mutation affecting larval and adult locomotion and development. Dev. Biol. 32: 873-86.
- Poodry, C. and Schneiderman, H.A. (1970). The ultrastructure of the developing leg of *Drosophila melanogaster*. Wilhelm Roux' Arch. 166: 1-44.
- Porter, R. and Rivers, J. (eds.) (1975). Cell Patterning. Ciba Found. Symp. 29 (new series). Amsterdam: Assoc. Sci. Pub.

- Postlethwait, J.H. and Schneiderman, H.A. (1971) A clonal analysis of development in *Drosophila melanogaster*: morphogenesis, determination and growth in the *antennal* antenna. Dev. Biol. 24: 519.
- Postlethwait, J.H. (1973) Pattern formation in imaginal discs of *Drosophila melanogaster* after irradiation of embryos and young larvae. Dev. Biol. 32: 545-60.
- Postlethwait, J.H. (1974) Developmental genetics of *Drosophila* imaginal discs. A. Rev. Genet. 7: 381-433.
- Price, G.R. and Schwartz, S. (1956) Fluorescence microscopy. In G. Oster and A. Pollister (eds.), Physical Technique in Biology and Medicine. New York: Academic Press.
- Reynolds, E.S. (1963) The use of lead citrate at high pH as an electron opaque stain in electron microscopy. J. Cell Biol. 17: 208-12.
- Ripoll, P. (1972) The embryonic organization of the imaginal wing disc of *Drosophila melanogaster*. Wilhelm Roux' Arch. 169: 200-15.
- Robertson, C.W. (1956) Metamorphosis of *Drosophila melanogaster*, including an accurately timed account of the principle morphological changes. J. Morph. 59: 351-99.
- Russell, M.A. (1974) Pattern formation in the imaginal discs of a temperature-sensitive cell-lethal mutant of *Drosophila melanogaster*. Dev. Biol. 40: 24-39.
- Sang, J. and McDonald, J. (1954) Production of phenocopies in *Drosophila* using salts, particularly sodium metaborate. J. Genet. 52: 392-412.
- Saunders, J.W. (1966) Death in embryonic systems. Science 154: 604-12.
- Schalet, A. (1970) Some observations on the proximal euchromatic-heterochromatic region of the X-chromosome in *Drosophila melanogaster*. Genen. en Phaenen. 14: 16-7.

- \_\_\_\_\_ (1973) The *suppressor-of-forked* locus: seven characteristics in search of a molecular author. Third European *Drosophila* Res. Conf. Abstracts.
- Schmidt, G. (1961) Nonspecific acid phosphomonoesterases. In P. Boyer, H. Lardy, and K. Myrbäck (eds.), *The Enzymes*. New York: Academic Press.
- Schubiger, G. (1968) Anlageplan, Determinationszustand und Transdeterminationsleistungen der männlichen Vorderbeinscheike von *Drosophila melanogaster*. *Wilhelm Roux' Arch.* 160: 9-40.
- \_\_\_\_\_ (1971) Regeneration, duplication and transdetermination in fragments of the leg disc of *Drosophila melanogaster*. *Dev. Biol.* 26: 277-95.
- Schweizer, P. (1972) Wirkung von Röntgenstrahlen auf die Entwicklung der männlichen Genitalprimordien von *Drosophila melanogaster*. Untersuchung von Erholungsvorgängen durch Zellklon-Analyse. *Biophysik* 8: 158-88.
- Seeman, P.M. and Palade, G.E. (1967) Acid phosphatase localization in rabbit eosinophils. *J. Cell Biol.* 34: 745-56.
- Shearn, A. and Garen, A. (1974) Genetic control of imaginal disc development in *Drosophila*. *PNAS (Wash.)* 71: 1393-7.
- Shearn, A., Rice, T., Garen, A., and Gehring, W. (1971) Imaginal disc abnormalities in lethal mutants of *Drosophila*. *PNAS (Wash.)* 68: 2594-8.
- Simpson, P. and Schneiderman, H.A. (1975) Isolation of temperature sensitive mutations blocking clone development in *Drosophila melanogaster*, and the effects of a temperature sensitive cell lethal mutation on pattern formation in imaginal discs. *Wilhelm Roux'*

- Arch. 178: 247-75.
- Smith, R.H. (1968) Unstable temperature-sensitive mutations in *Habrobracon*. Genetics 60: 227.
- Smith-Sonneborn, J. (1974) Acridine orange fluorescence: a temporary stain for *Paramecia*. Stain Tech. 49: 77-80.
- Sondhi, K.C. (1963) The biological foundations of animal patterns. Quart. Rev. Biol. 38: 289-327.
- Sprey, T.E. (1971) Cell death during the development of the imaginal disks of *Calliphora erythrocephala*. Netherlands J. Zool. 21: 221-64.
- Sprey, T.E. and Oldenhave, M. (1974) A detailed organ map of the wing disk of *Calliphora erythrocephala*. Netherlands J. Zool. 24: 291-310.
- Stern, C. (1940) The prospective significance of imaginal discs in *Drosophila*. J. Morph. 67: 107-22.
- \_\_\_\_\_ (1954) Genes and developmental patterns. Proc. Int. Congr. Genet. 9th, 355-69.
- \_\_\_\_\_ (1968) Genetic Mosaics and Other Essays. Cambridge: Harvard University Press.
- Stern, C. and Hannah, A. (1950) The sex-combs in gynanders of *Drosophila melanogaster*. Portugal Acta Biol. Series A. (R.B. Goldschmidt vol.) pp. 798-812.
- Stern, C. and Tokunaga, C. (1967) Non-autonomy in differentiation of pattern-determining genes in *Drosophila*. I. The sexcomb of *eyeless-dominant*. PNAS (Wash.) 57: 658-64.
- \_\_\_\_\_ (1968) Autonomous pleiotropy in *Drosophila*. PNAS (Wash.) 60: 1252-9.

- \_\_\_\_\_ (1971) On cell lethals in *Drosophila*. PNAS (Wash.) 68: 329-31.
- Strugger, S. (1949) Fluoreszenzmikroskopie und Microbiologie. Hanover: Schaper.
- Stumpf, H. (1959) Die Wirkung von Hitzereizen auf Entwicklungsvorgänge im Puppenflügel von *Drosophila*. Biol. Zbl. 78: 116-42.
- Sturtevant, A.H. (1929) The *claret* mutant type of *Drosophila simulans*: a study of chromosome elimination and of cell-lineage. Z. Wiss. Zool. 135: 323-56.
- Suzuki, D.T. (1970) Temperature-sensitive mutations in *Drosophila melanogaster*. Science 170: 695-705.
- Tokunaga, C. (1970) The effect on somatic crossing over of an *ey<sup>D</sup>* inserted into chromosome 3. Dros. Inform. Serv. 45: 58.
- Ulrich, E. (1971) Cell lineage, determination and regulation in the female genital disc of *Drosophila melanogaster*. Wilhelm Roux' Arch. 167: 64-82.
- Ursprung, H. (1963) Development and genetics of patterns. Am. Zool. 3: 71-86.
- \_\_\_\_\_ (1972) The fine structure of imaginal disks. In H. Ursprung and R. Nöthiger (eds.), Results and Problems in Cell Differentiation V. Germany: Springer.
- Ursprung, H. and Schabtach, E. (1968) The fine structure of the male *Drosophila* genital disk during late larval and early pupal development. Wilhelm Roux' Arch. 160: 243-54.
- \_\_\_\_\_ (1972) On the syncytial nature of *Drosophila* imaginal discs: influence of fixatives on membrane fine structure. Rev. Suisse Zool. 79S: 65-73.

- van der Meer, J.M. and Ouweneel, W.M. (1974) Differentiation capacities of the dorsal mesothoracic (halter) disc of *Drosophila melanogaster*. II. Regeneration and duplication. Wilhelm Roux' Arch. 174: 361-73.
- Vogt, M. (1946) Zur labilen Determination der Imaginalscheiben von *Drosophila*. I. Verhalten verschiedenalteriger Imaginalanlagen bei operativer Defektsetzung. Biol. Zentralbl. 65: 223-38.
- Waddington, C.H. (1940) The genetic control of wing development in *Drosophila*. J. Genet. 41: 75-139.
- \_\_\_\_\_ (1942) Some developmental effects of X-rays in *Drosophila*. J. exp. Biol. 19: 101-17.
- \_\_\_\_\_ (1953a) Genetic assimilation of an acquired character. Evolution 7: 118-26.
- \_\_\_\_\_ (1953b) The interactions of some morphogenetic genes in *Drosophila melanogaster*. J. Genet. 51: 243-58.
- \_\_\_\_\_ (1973) The morphogenesis of patterns in *Drosophila*. In S.J. Counce and C.H. Waddington (eds.), Developmental Systems: Insects. v.II. London: Academic Press.
- Waddington, C.H. and Peury, M.M. (1960) The ultrastructure of the developing eye of *Drosophila*. Proc. roy. Soc. B 153: 155-78.
- Wald, H. (1936) Cytological studies on abnormal development of eggs of the *claret* mutant type of *Drosophila simulans*. Genetics 21: 264-81.
- Wehman, H.J. (1969) Fine structure of *Drosophila* wing imaginal disks during early stages of metamorphosis. Wilhelm Roux' Arch. 163: 375-90.
- Wehman, H.J. and Brager, M. (1971) Viruslike particles in *Drosophila*: Constant appearance in imaginal disks *in vitro*. J. Invertebr. Pathol. 18: 127-30.

- Weismann, A. (1864) Die nachembryonale Entwicklung der Musciden, nach Beobachtungen an *Musca vomitoria* und *Sarcophaga carnaria*. Z. wiss. Zoöl. 14: 267-333.
- Whitten, J.M. (1969) Cell death during early morphogenesis: parallels between insect limb and vertebrate limb development. Science 163: 1456-7.
- Wieschaus, E. (1974) X-ray induction of pattern abnormalities in early embryos. Dros. Inform. Serv. 51: 88-9.
- Wilderemuth, H.R. (1968) Differenzierungsleistungen, Mustergliederung und Transdeterminationmechanismen in hetero- und homoplastischen Transplantaten der Rüsselprimordien von *Drosophila*. Wilhelm Roux' Arch. 160: 41-75.
- Wolf, M.K. and Aronson, S.B. (1961) Growth, fluorescence and metachromasy of cells cultured in the presence of acridine orange. J. Histochem. Cytochem. 9: 22-9.
- Wolpert, L. (1969) Positional information and the spatial pattern of cellular differentiation. J. theor. Biol. 25: 1-47.
- \_\_\_\_\_ (1971). Positional information and pattern formation. In A. Mascona and A. Monroy (eds.), Current Topics in Developmental Biology, v.6. New York: Academic Press.
- Wright, T.R.F. (1968) The phenogenetics of temperature-sensitive alleles of *lethal myospheroid* in *Drosophila*. Proc. of the XII Intern. Congr. Genet. 1: 141.
- \_\_\_\_\_ (1973) The recovery, penetrance and pleiotropy of X-linked, cold-sensitive mutants in *Drosophila*. Molec. gen. Genet. 122: 101-18.
- Zalokar, M. (1943) L'ablation des disques imaginaux chez la larve de *Drosophila*. Rev. Suisse Zool. 50: 232-6.

A P P E N D I X



Composition of *Drosophila* Culture Medium<sup>1</sup>

Per liter of distilled water:

dried brewers' yeast	100 g
sucrose	100 g
agar	20 g
propionic acid	7 ml
chloramphenicol (1000 mcg/mg, Parke-Davis & Co.)	0.1 g

---

<sup>1</sup>After Nash and Bell, 1968.