

13590

NATIONAL LIBRARY  
OTTAWA



BIBLIOTHÈQUE NATIONALE  
OTTAWA

NAME OF AUTHOR... *PENNY ANN SWANSON* .....

TITLE OF THESIS... *CYSTIC FIBROSIS: STUDIES OF THE*  
*CILIARY INHIBITION FACTOR AND*  
*CELLULAR PHENOTYPE* .....

UNIVERSITY OF... *ALBERTA* .....

DEGREE FOR WHICH THESIS WAS PRESENTED... *M.Sc.* .....

YEAR THIS DEGREE GRANTED... *1972* .....

Permission is hereby granted to THE NATIONAL LIBRARY  
 OF CANADA to microfilm this thesis and to lend or sell copies  
 of the film.

The author reserves other publication rights, and  
 neither the thesis nor extensive extracts from it may be  
 printed or otherwise reproduced without the author's  
 written permission.

(Signed)... *Penny Ann Swanson* .....

PERMANENT ADDRESS:

*#4-11420 - 100 Ave.*  
*Edmonton, Alberta* .....

DATED... *Sept. 26* ..... 1972

NL-91 (10-68)

THE UNIVERSITY OF ALBERTA

CYSTIC FIBROSIS: STUDIES OF THE CILIARY  
INHIBITION FACTOR AND CELLULAR PHENOTYPE

by



PENNY ANN SWANSON

A THESIS

SUBMITTED TO THE FACULTY OF GRADUATE STUDIES AND RESEARCH  
IN PARTIAL FULFILMENT OF THE REQUIREMENTS FOR THE DEGREE  
OF MASTER OF SCIENCE

DEPARTMENT OF GENETICS

EDMONTON, ALBERTA

FALL, 1972

## ABSTRACT

Experiments to determine if cystic fibrosis serum was inhibitory to the cilia of Paramecium showed that serum of both cystic fibrosis subjects and controls was similarly toxic to the whole organism. Heat inactivation of serum complement abolished this toxicity, but did not allow detection of any type of ciliary toxicity.

When assayed on the ciliated outgrowth of human nasopharyngeal tissue, both cystic fibrosis and control sera were found to be minimally and non-differentially toxic to the ciliary motion.

Reaction of Salmonella flagellar antigen with cystic fibrosis serum in an Ouchterlony immunodiffusion plate showed no evidence of an antigen-antibody precipitation.

Metachromasia in cultured fibroblasts with toluidine blue o stain was found to be erratic and did not differentiate cystic fibrosis subjects, San Filippo subjects, and controls. Parameters such as method of fixation, nature of dye solution, and dehydration were found not to alter the nature of the non-specific staining. Sulfation of the mucopolysaccharide constituents of the fibroblast monolayer was unsatisfactory because of disruption of cellular architecture.

A correlation of metachromasia in normal control cells with donor age and generations in culture was found. The older strains showed significant levels of metachromasia, while younger cell strains rarely demonstrated metachromasia.

Hydrocortisone in the medium was found to reduce levels of non-specific metachromasia in cystic fibrosis and control cells. Dimethyl sulfoxide reduced metachromasia that was considered to be cystic fibrosis specific.

An attempt to visualize cystic fibrosis fibroblast mucopolysaccharides by methylene blue extinction was not successful.

#### ACKNOWLEDGEMENTS

I wish to express my sincerest thanks to the cystic fibrosis families who were unfailing in their cooperation, and especially the cystic fibrosis children whose volunteer bravery was vital to this project. I would like to thank the members of my committee, who have all been helpful: Dr.'s Bowen and McCoy for general project and thesis support, Dr. Shnitka for specific experimental suggestions, and Dr. Hastings for support and specific criticisms. Thanks are also extended to Miss Edith Markstad who was most helpful with her vast store of information about local and federal cystic fibrosis affairs. I also owe appreciation to Luella Yakimishyn whose discussions and specific suggestions have helped me to write a more intelligible piece of prose.

Special gratitude goes to Rick, my husband, whose thoughtful and penetrating contributions touch every aspect of this thesis and my graduate school tenure.

Financial support for the work in this thesis was in most part from the Medical Research Council of Canada in grants to Dr. P. Bowen and Dr. E.E. McCoy.

## TABLE OF CONTENTS

	Page
INTRODUCTION AND LITERATURE REVIEW	1
Ciliary and membrane transport studies	1
Mucopolysaccharides and cellular phenotype with toluidine blue o stain	7
MATERIALS AND METHODS	12
I. Subjects used for ciliary inhibition and fibroblast mucopolysaccharide studies	12
II. Ciliary inhibition studies	12
III. Differential staining of fibroblasts with basic dyes	17
RESULTS	20
I. Ciliary inhibition studies	20
II. Differential staining of fibroblasts with basic dyes	29
DISCUSSION	52
I. Ciliary inhibition studies	52
II. Differential staining of fibroblasts with basic dyes	55
BIBLIOGRAPHY	61

LIST OF TABLES

Table	Page
1 Identification Data and Diagnostic Criteria of the Eight Cystic Fibrosis Subjects.	14
2 Effects of Plasma Compared with Isotonic Buffered Saline and Anti-coagulant Additives on Survival of <u>Paramecium</u> .	21
3 Effects of Serum or Plasma from Cystic Fibrosis Patients and Normals on Survival of <u>Paramecium</u> .	22
4 Effects of Serially Diluted Normal Serum on Survival of <u>Paramecium</u> .	23
5 Effects of Serially Diluted Cystic Fibrosis and Normal Plasma on Survival of <u>Paramecium</u> .	24
6 Effects of Euglobulin Fraction from Cystic Fibrosis Patients and Normals on Survival of <u>Paramecium</u> .	25
7 Effects of De complemented Serum from a Cystic Fibrosis Heterozygote and Homozygote and a Normal on Survival of <u>Paramecium</u> .	27
8 Qualitative Assessment for Metachromasia on Control Strains Matched Against their Age.	34
9 Metachromasia Ratings with Cetyltrimethylammonium Bromide Precipitation.	38
10 Appearance of Metachromasia in Cystic Fibrosis and Control Cells Related to Concentration of MeOH and Dye in Stain.	40
11 Effect of pH Variation on Appearance of Cells Stained with Toluidine Blue o.	41
12 Staining Results with Toluidine Blue o at pH 4.5.	43

LIST OF FIGURES

Figure	Page
1 Pedigrees of Cystic Fibrosis Subjects.	13
2 Hanging-drop Slide with <u>Paramecium</u> plus Medium Sealed into Well.	16
3 Immunodiffusion Plate with Cystic Fibrosis Serum Reacted Against <u>Salmonella</u> Flagellar Antigen and Stained with Amido Black.	30
4 Cells from a Cystic Fibrosis Homozygote Stained 3 and 22 Days after Subculture.	32
5 Demonstration of True and False Metachromasia and Ametachromasia in the Cells of One Control Strain.	35
6 Cells Fixed with Cetyltrimethylammonium Bromide from a Control and a Cystic Fibrosis Subject.	39
7 Cells from WDS (CFhom) Stained at pH 4.0 and pH 4.5.	42
8 Cells after Sulfation and Toluidine Blue o Stain from a Cystic Fibrosis Subject, a San Filippo Subject, and a Control.	46
9 Percentages of Metachromatic Cells Grown in Hydrocortisone, 1 ug/ml, Compared with Cells Removed from Hydrocortisone for 7 and 17 Days.	49
10 Percentages of Metachromatic Cells Grown in Maintenance Medium Compared with Cells having Hydrocortisone, 1 ug/ml, Introduced into the Medium for 7 and 16 Days.	50



INTRODUCTION AND LITERATURE REVIEW

Cystic fibrosis of the pancreas or mucoviscidosis, is a recessively inherited disease which seriously affects exocrine glands. Population studies have implicated one locus with one mutant allele (Danks et al., 1965; Wright and Morton, 1968), whereas recent studies on fibroblast cultures from cystic fibrotics suggest the involvement of more than one mutant allele or one locus (Danes and Bearn, 1969a; Matalon and Dorfman, 1969; Danes and Flensburg, 1971). Pathological investigation shows general exocrine dysfunction and degeneration (di Sant' Agnese and Talamo, 1967). Ductal clogging may be the essential pathogenesis in exocrine degeneration. Obvious clinical manifestations of the disease are pancreatic insufficiency, chronic pulmonary disease, and increased  $\text{Na}^+$  and  $\text{Cl}^-$  concentrations in sweat. A less obvious, although documented manifestation of cystic fibrosis, is liver cirrhosis due to biliary duct clogging (Craig et al., 1957; Feigelson et al., 1972).

Homozygotes usually die before their third decade of pulmonary infection. About one in forty Caucasians carries a cystic fibrosis allele, but other races do not show this high frequency (Wright and Morton, 1968). The high incidence of cystic fibrosis with early mortality indicates the urgency for a better understanding of the basic defect. The following review covers several approaches in cystic fibrosis research and documents some difficulties and conflicts that await solution.

Ciliary and membrane transport studies. In 1967 Spock et al. published a method for determining homozygotes and heterozygotes from

control populations. They observed effects of sera on the ciliary motion of tissue explants of rabbit respiratory epithelium. Controls were adolescents with diseases having clinical features similar to those seen in cystic fibrosis (CF). They assayed seventy-five CF patients, twenty-five heterozygotic parents of cystic fibrotics and seventy-five adolescent controls. The results showed that sera from all patients and some parents caused rapid ciliary dyskinesia when applied to tracheal explants. Control sera did not have this effect. Parents of cystic fibrotics whose whole sera did not affect cilia showed positive results with their fractionated serum concentrates. In a separate adult control group using fractionated serum concentrate, only one in twenty-five showed results similar to CF heterozygotes.

Realizing the importance of an accessible source of cilia for heterozygote screening programs, Bowman et al. (1969) tested sera on oyster gill cilia and were able to distinguish homozygotes and heterozygotes from a control population without using fractionated serum concentrates. The effect on gill cilia was cessation of beat in contrast to tracheal cilia dyskinesia. Bowman's experiments showed the causative factor to be similar to Spock's by its activity being non-dialyzable and heat labile, with a molecular weight range of 75,000 - 180,000. The organic bases polylysine and polyornithine reproduced this effect on the cilia. Further work from Bowman's lab (Herzberg, 1971) reported the effect of antibodies directed against oyster cilia for comparison with the CF factor. The factor previously was isolated with immunoglobulin G but could not be shown to duplicate a typical antigen-antibody reaction.

Schmoyer et al. (1972) subsequently improved purification of the serum factor with isoelectric focusing in conjunction with the oyster assay system. They found two active fractions and suggested a similarity to those obtained with gel filtration by Spock. Bowman et al. (1970a) reported only one active fraction.

Concurrently, Besley et al. (1969) independently found inhibitory effects of CF plasma on gill cilia of a European freshwater mussel, Dreissensia. The activity was heat-labile, lost when frozen, and showed a rapid decrease when stored in glass. Besley's group suggested a seasonal fluctuation in test efficacy. From late September to early April, which approximates the mussel's dormant period, serum effects on mussel gill cilia did not differentiate CF victims from controls. This seasonal variation with mussels was also observed by Bowman (1970b) with oysters.

Not all attempts with this assay have been successful. Biddle (1971) from Vancouver tried the assay on both Atlantic and Pacific varieties of oyster and found extensive time overlap of ciliary beat cessation with homozygote, heterozygote and control sera. A report by Iacocca et al. (1971) which in essence confirmed the oyster assay, mentioned that overlap of inhibition time for heterozygotes and controls was extensive enough to prevent reliable conclusions. Most recently, Cherry et al. (1971) applied sera to chicken and rabbit tracheal explants and found that all sera were markedly ciliotoxic. Cystic fibrosis and control samples could not be differentiated.

Assuming a CF serum factor having a unique effect on ciliary tissue, one wonders about its molecular classification and initial site

of action. Spock (1971) has discussed a possible relationship of ciliary inhibition to altered membrane permeability. This idea originates from several studies of cystic fibrotics to determine the cause of excess electrolytes in their sweat and saliva.

Perhaps the most extensive research in this area has been done by Mangos et al. (1967, 1968). Using rat parotid salivary gland in vivo, they studied  $\text{Na}^+$  reabsorption in the gland duct. This reabsorption is markedly decreased by retrograde perfusion of the duct with CF saliva, whereas control saliva allows production of normal hypotonic saliva. Investigation of a possible mechanism revealed that basic polyelectrolytes such as polylysine were able to produce the same effect as CF saliva. Heparin, mixed with either CF saliva or polylysine eliminated the inhibition. It should be mentioned again that Bowman et al. (1969) tried polylysine on oyster gill cilia and found effects similar to CF serum. Experiments by Kaiser et al. (1970) showed that retrograde perfusion of a normal sweat gland with CF sweat caused the normal gland to produce sweat with a significant increase in  $\text{Na}^+$  concentration. These results with salivary and sweat glands demonstrate the humoral transducibility of the CF electrolyte defect.

Another study relating CF humoral factors and membrane transport was made by Brown et al. (1971) who found that plasma from CF patients inhibited uptake of the glucose analogue, arbutin, by rat intestine in vitro. The heparinized plasma used in these experiments questions similarity to the salivary factor studied by Mangos and McSherry (1968) which is inhibited by heparin. Spock et al. (1967) also used heparinized plasma but did not comment on interference of heparin with the

effect on cilia. Unpublished data from a joint study by Spock and Mangos indicate that whole CF serum does not inhibit  $\text{Na}^+$  transport in the rat parotid gland, but Spock (1971) discusses their identification of a serum fraction capable of inhibition.

Benke et al. (1972) studied the membrane transport of labelled sugars and amino acids in CF and control fibroblasts after treating them with saliva or plasma from CF patients and controls. He could find no differences and concluded that the essential problem lies with  $\text{Na}^+$  transport as detailed by Mangos et al. (1967, 1968) and Kaiser et al. (1970). The use of different tissues in the various studies was not discussed. Fibroblast membranes in vitro may not be analogous to exocrine duct epithelium. Nonetheless, in this area of conflicting reports, fibroblasts physiology appears to be a valid source of information, considering that CF victims show excess mucopolysaccharide storage in cultured fibroblasts (Matalon and Dorfman, 1968).

In contrast to Benke's conclusion of altered  $\text{Na}^+$  transport as being important, Gibson et al. (1970, 1971) concluded that abnormal variation of  $\text{Ca}^{++}$  levels is the primary cause of CF pathogenesis. Unusual  $\text{Na}^+$  concentrations are simply an occasional result of the CF disease process. Gibson's theory about the disease is based on a belief that mucus has a primary function in retardation of the passive flow of water and small ions. He postulated that cystic fibrotics have hyperpermeable mucus and designed experiments to examine this. Hyperpermeable mucous would allow excessive reabsorption of water in exocrine duct cells and make the ductal fluid hypertonic. This hyperpermeability that he found in dried films of CF saliva can be produced in control saliva by addition

of  $\text{Ca}^{++}$  and eliminated in CF saliva by  $\text{Ca}^{++}$  chelation. Gibson et al. (1971) surveyed the published data and found that  $\text{Ca}^{++}$  is the only ion increased in all CF exocrine secretions. Supporting this hypothesis, Horton et al. (1970) had already found  $\text{Ca}^{++}$  dependent ATPase activity significantly reduced in CF erythrocyte membranes, while  $\text{Mg}^{++}$  dependent ATPase and  $(\text{Na}^+ + \text{K}^+)$  dependent ATPase activities were normal. The severity of the disease correlated with the degree of reduction of  $\text{Ca}^{++}$  dependent ATPase activity.

Previous evidence pointing to  $\text{Ca}^{++}$  as an important element in CF had come from experiments with acrylamide gel electrophoretic patterns of CF saliva. Cystic fibrotics show an abnormal pattern that can be imitated by control saliva if  $\text{Ca}^{++}$  is added (Gugler et al. 1967). Fitzpatrick et al. (1972) have recently showed abnormal acrylamide gel patterns from extracts of CF red-cell membranes which also indicated excess  $\text{Ca}^{++}$  as the cause. Following their preliminary evidence they also identified a CF serum factor with an abnormally high affinity for  $\text{Ca}^{++}$ . A relationship between this  $\text{Ca}^{++}$  binding factor and the one in serum responsible for ciliary malfunction and faulty ductal reabsorption has not been established, but remains a possibility.

A recent publication (Eckert, 1972) concerning control of ciliary motion may be relevant to the aforementioned CF data. On the basis of several lines of investigation,  $\text{Ca}^{++}$  flux has been suggested as the regulator of ciliary motion in protozoa. Experiments extending this to other organisms have not been done, but the findings to date may hold significance for CF research.

Mucopolysaccharides and cellular phenotype with toluidine blue o stain In the course of conducting a study of accumulated mucopolysaccharides in cultured fibroblasts from the various forms of mucopolysaccharide storage disease, Danes and Bearn (1968; 1969a) found that fibroblasts cultured from homozygous and heterozygous cystic fibrotics exhibited excess metachromatic material when stained with the basic dye toluidine blue o at pH 3.8. Next, Danes and Bearn (1969b) reported that CF metachromasia, like the mucopolysaccharide storage disorders, was due to an increase in mucopolysaccharides. Upon biochemical analysis, this increase was evident in the medium and trypsin released extracellular matrix, while intracellular mucopolysaccharides matched controls. The storage disorders showed excess mucopolysaccharides located within the cell.

Matalon and Dorfman (1968) corroborated the data of Danes and Bearn. Unfortunately, when measuring mucopolysaccharides, they did not divide their fibroblast cultures into medium, extracellular matrix and cell pellet, so that the increase cannot be specifically assigned. Preliminary work by these authors (1969) identified the component mucopolysaccharides which, though increased, have a relative distribution similar to controls, with hyaluronic acid predominating and dermatan sulfate and chondroitin 4/6 sulfates in lesser, but equal amounts. This data contrasts with the storage disorders which tend to show an abnormal distribution of component mucopolysaccharides.

Increased mucopolysaccharide in the CF fibroblasts has value as a marker for study of the basic physiology of the disease and for heterozygote detection. Many research teams have attempted the technique

of metachromatic staining with CF fibroblasts and have met with variable success - none being able to completely reproduce the striking results of Danes and Bearn. Control cells may demonstrate metachromasia or affected cells may produce none (Taysi et al., 1969; Bartman et al., 1970; Reed et al., 1970; Nadler et al., 1969a; Milunsky and Littlefield, 1969; Kraus et al., 1971; Conen, 1972). Measuring mucopolysaccharides, Wiesmann and Neufeld (1970) could not find excess material in CF fibroblasts with biochemical analysis of 3-day cultures using  $^{35}\text{SO}_4^{--}$ . In control populations, metachromatic cultures from 5 - 10% of persons tested is considered acceptable by workers in the field, since heterozygote cells are positive.

One of the major problems with the staining procedure is that toluidine blue o, a basic stain, can adhere non-specifically to any acidic molecule. Hence, other macromolecules in the cell take up toluidine blue o, and depending on the pH of the stain, the impurities in the dye, and the steric configuration of the acid groups on the macromolecule, such things as phospholipids, nucleic acids, and glycogen can produce metachromasia (Schubert and Hamerman, 1956). The dye, in combination with the acid groups, produces a new absorption maxima, in this case from blue to pink and similar to that seen in concentrated dye solutions (Barka and Anderson, 1963, p. 84). Because of this lack of specificity, most workers in the field prefer to combine precise biochemical assay with histology.

Danes and Flensburg (1971) studied a Danish CF population with the intention of defining the genetic and clinical significance of the metachromasia studies on a new and different population. They were able



to duplicate previous findings. One of the more interesting and important findings of the studies Danes has taken part in is that they have distinguished three classes of CF based on staining patterns in the cell. These classes have been designated I, II, and III; class I shows vesicular metachromasia, class II shows generalized metachromasia (vesicular-granular-cytoplasmic), and class III is ametachromatic. Comparing American and Danish CF classification data along the above lines shows that the patients' metachromasia follows a different distribution in the two populations. It is as follows:

<u>CLASS</u>	<u>AMERICAN</u>	<u>DANISH</u>
I	26.7%	20.0%
II	60.0	37.8
III	13.3	42.2

In all populations she has studied, Danes has established these classes as consistent within a family tree, which provides evidence for either several alleles at one locus which must be paired homogeneously for manifestation, or several loci at which the disease may be expressed when homozygous for a mutant allele. Other investigators, using this technique, have not reported the classification of types of metachromasia in CF fibroblasts.

Because CF metachromasia appeared vesicular in some cases, its location in subcellular organelles was investigated. In 1970, Bartman et al. published an electron microscope study on CF and control fibroblasts that elucidated some ultrastructural comparisons between them. The overabundant organelle in CF cells was designated lysosomal-like by the authors. However, Nadler (1969b) has said that in his laboratory,

excess vesicular structures identified in electron micrographs of CF fibroblasts did not resemble lysosomes. Bartman published his pictures.

Assuming possible lysosomal and degradative enzyme defect in CF, several studies have been done on enzymes related to mucopolysaccharide catabolism. Assays done directly on biopsied tissue had decreased beta-glucuronidase in epidermis and sweat glands (Gibbs and Griffin, 1970; Wilson 1972b). Wilson (1972a) also found increased uronic acid in CF skin which is an indication of increased mucopolysaccharides, but the hexosamine content, another constituent of mucopolysaccharide, was normal. Griffin and Gibbs (1971), culturing white blood cells from cystic fibrotics, found levels of beta-glucuronidase reduced to about three-quarters normal values. In contrast, fibroblast studies (Kraus et al. 1971; Benke 1971; Russell et al. 1971) showed beta-glucuronidase levels did not differ from normal, nor did other related enzymes. Kinetic studies by Wiesmann and Neufeld (1970) showed that CF fibroblasts have normal rates of mucopolysaccharide degradation when monitored with  $^{35}\text{SO}_4$  in pulse-chase experiments. These reports may mean that fibroblasts and lymphocytes differentiate along different paths in vitro, however in the hands of Danes and associates both fibroblasts and lymphoblasts (1969c) show excess mucopolysaccharides with toluidine blue o stain.

One goal of the work in this thesis was to find a more convenient, accessible, and economical source of ciliated tissue for the CF ciliary inhibition studies and heterozygote detection. To that end, serum and plasma were assayed on Paramecium, the ciliated outgrowth of human nasopharyngeal explants, and Salmonella flagellar antigen.

Another aspect of the thesis concerns use of fibroblasts and uptake of the basic dyes toluidine blue o and methylene blue as a tool in the study of CF pathophysiology and for heterozygote detection. In this area, standardization and calibration of the technique were paramount. Experiments with dimethyl sulfoxide and hydrocortisone were done to assess lysosomal response via metachromasia.

MATERIALS AND METHODS

I. Subjects used for ciliary inhibition and fibroblast mucopolysaccharide studies

A. The cystic fibrosis families (Figure 1) were contacted through the out-patient department of the University of Alberta Hospital or the Edmonton Cystic Fibrosis Parents Club. Table I summarizes some pertinent clinical data. When referred to in the thesis, (CFhom) follows homozygotes and (CFhet) follows heterozygotes.

B. Two brothers with San Filippo's Syndrome (SF) and residents at the Alberta School Hospital, Red Deer were used as positive controls in the fibroblast studies (Danes and Bearn, 1966a). The diagnosis was based on a compatible clinical picture combined with the demonstration of increased heparan sulfate in the urine of one of them (courtesy of Dr. L. J. le Vann, Superintendent, Alberta School Hospital and Dr. G. C. Robinson, Professor, Department of Pediatrics, University of British Columbia, Vancouver).

C. Subjects used as negative controls in the ciliary and fibroblast studies consisted of healthy laboratory and clinical personnel.

II. Ciliary inhibition studies

A. Paramecium

1. The Paramecium strain was cloned from a natural stock of W. A. Samorodin, biology teacher, East Glenn High School, Edmonton. These were maintained in a growth medium of lettuce infusion (Wichterman, 1953, p. 98), kept at room temperature, and subcultured about every ten days into fresh medium.

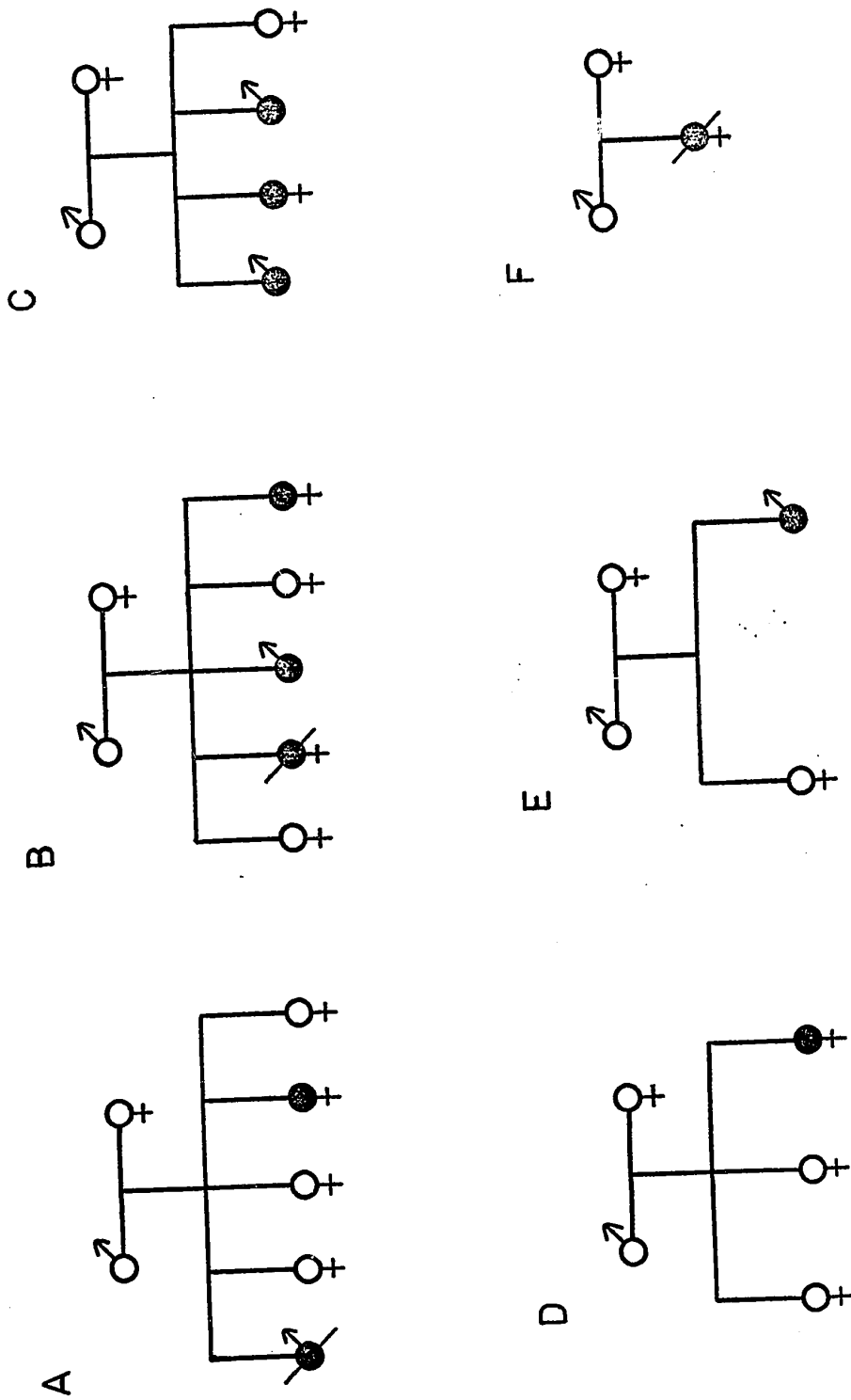

Figure 1. Pedigrees of Cystic Fibrosis Subjects

<u>Patient's</u>	<u>Family#</u>	<u>Sibship#</u>	<u>Hospital*</u>	<u>Birthdate</u>	<u>Age at</u>	<u>Presenting Manifestation</u>	<u>Sweat Chlorides<sup>+</sup></u>
<u>WDS</u>	<u>A</u>	<u>4</u>	<u>I.D. No.</u>	<u>(in yrs)</u>	<u>Diagnosis</u>		
			231907	5/56	6	Chronic cough and heavy sputum	106; 121 meq/l <sup>@</sup>
JEI	B	3	261714	12/55	6/12	Chronic pulmonary disease	115; 145
SEI	B	5	203018	8/60	7/12	Bulky, foul stools	73; 76
MIY	D	3	317154	5/68	1	Distressing, persistent cough	100; 128
NRH	E	2	240657	4/64	3/2	Severe bronchiolitis and chronic diarrhea	107; 100
LRT	C	1	280494	4/62	4	Fever, recurrent colds, pneumonia	108; 109
RRT	C	2	293529	2/58	10	Persistent cough, family history <sup>&amp;</sup>	79; 94
EWR	F	1	233579	12/61	5	Nasal obstruction and discharge	160; 226

# See Figure 1

\* University of Alberta Hospital, Edmonton

+ Normal values, 4-60 meq/l

@ Values for two separate tests

& Younger sister diagnosed first

Table 1. Identification Data and Diagnostic Criteria of the Eight Cystic Fibrosis Subjects

In addition, all eight subjects have chronic pulmonary disease despite therapy, and all receive pancreatic enzymes daily.

2. The Paramecium were concentrated for assay by chilling and gentle centrifugation, a treatment that was not disruptive or lethal to the organism.

3. Freshly separated serum or plasma, the plasma being collected in Becton Dickinson vacutainer tubes with heparin or sodium citrate, was transferred aseptically to plastic tubes for storage at 4° C. The samples were used within 7 days of collection.

4. The euglobulin fraction from serum was prepared according to Spock (1967) by saturating ice-cold H<sub>2</sub>O with CO<sub>2</sub>, adding 0.5 ml serum to 5.0 ml of the saturated H<sub>2</sub>O, mixing, centrifuging at 2000 rpm for 5 min., removing the supernatant, and resuspending the precipitate in isotonic phosphate buffered saline to the desired concentration.

5. The standard assay for the Paramecium experiments was done at room temperature in the well of a hanging-drop slide (Figure 2) with a total volume of about 30 ul. The well was sealed with a cover slip and petrolatum. Observations were made with an inverted microscope at 40X magnification. The mark of death was loss of form coupled with immobility of the Paramecium.

B. Nasopharyngeal explants

1. Adenoid tissue removed from patients at the University of Alberta Hospital was inspected with an inverted phase contrast microscope at 200X magnification, and areas of healthy ciliated epithelium were excised. These fragments were cut into small pieces, 2mm<sup>2</sup>, and put into a 30 ml Falcon plastic T-flask with a small amount of medium (Eagle's Minimum Essential Medium with 10% Gibco fetal calf serum plus 50 ug/ml streptomycin and 50 IU's/ml penicillin). The reduced amount of medium

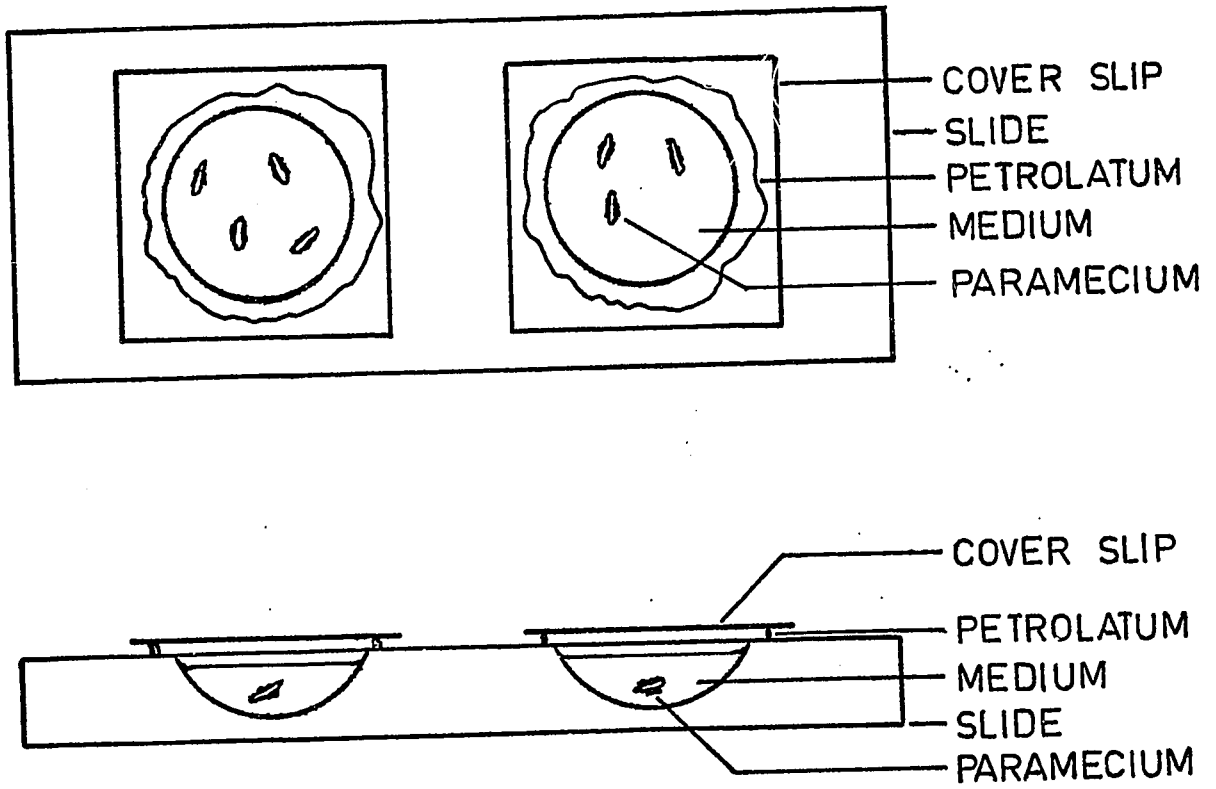

Figure 2. Hanging-drop Slide with Paramecium plus Medium Sealed into Well



prevented the tissue fragments from floating. In a few days, when the fragments had adhered to the flask, more medium was added. The flasks were gassed with 5% CO<sub>2</sub> in air and incubated at 37° C. (Bhonsdale, 1970).

2. Blood from a cystic fibrosis homozygote (CF<sub>hom</sub>) and a normal control (N) was collected, clotted, and the serum used full strength on two separate flasks with ciliated monolayers. Observations of cell integrity and ciliary motion on the outgrowth were made at 200X magnification with an inverted phase contrast microscope.

C. Salmonella flagellar antigen

1. The Ouchterlony immunodiffusion plate was made with 1.5% agarose in Veronal buffer, 0.075 M, pH 8.6.

2. Salmonella flagellar antigen (Pol antigen) was obtained from Dr. N. Kraft of the Immunology Unit at the University of Alberta, Faculty of Medicine.

3. Wells in the Ouchterlony plate were filled with appropriate sample, and the plate was placed in a moist chamber for 48 hrs. to allow diffusion and interaction. Following this, a saline rinse for 24 hrs. dissolved out unprecipitated material. The agarose layer was then dried, stained with amido black for 1 hr. and rinsed.

III. Differential staining of fibroblasts with basic dyes

A. Methods, including related materials

1. Fibroblast cultures were established from 6 mm<sup>2</sup> skin biopsies taken from the inside of the forearm or from foreskins of newborns. These were cut into small fragments and settled in a 30 ml Falcon plastic T-flask with enough medium to wet the entire flask surface. The medium consisted of Eagle's Minimum Essential Medium (MEM) plus 20% Gibco fetal

calf serum (FCS), plus penicillin, 50 IU's/ml, and streptomycin, 50 ug/ml. The flask was gassed with 5% CO<sub>2</sub> in air, sealed, and kept at 37° C. After 3-4 days, when the fragments had adhered to the surface and fibroblasts or epithelial cells were growing from them, medium was added to the flask and subsequently replaced by 1/2 its volume every 4-5 days. Fibroblasts in quantities sufficient for propagation generally appeared within 6-8 weeks.

2. Fibroblast cultures were maintained in 30 ml Bellco glass T-flasks with MEM containing 10% FCS and penicillin/streptomycin, gassed with 5% CO<sub>2</sub> in air, sealed, and kept at 37° C. The medium was changed every 4-5 days and subcultures were done every 8-10 days with Gibco trypsin, 0.25%, in Tyrode's buffer without Ca<sup>++</sup> and Mg<sup>++</sup>.

3. Coverslip preparations were made by subculturing into Leighton tubes fitted with number 1 glass coverslips.

4. The toluidine blue o staining procedure was as follows (Danes and Bearn, 1966a):

- a. The cell monolayer was rinsed in balanced salt solution at pH 7.2 for 15 sec., then allowed to drip and evaporate excess moisture for 5 min.
- b. Cells were fixed 5 min. in absolute MeOH and dried.
- c. Cells were stained 10 min. in 0.1% toluidine blue o (Fisher, dye lot EU-23, 88% dye content or Matheson, Coleman and Bell, dye lot CU-22, 91% dye content) in 30% MeOH brought to pH 3.8 with 0.1 M HCl.
- d. Dehydration was done with two rinses of reagent

grade acetone or isopropanol.

- e. Two final rinses were done in xylene, the monolayer dried and then mounted with Fisher Permunt.

5. For photography, red-blue contrast of the cells was enhanced with a Corning color filter #5120. Agfa film and paper were used for the color prints.

6. The methylene blue extinction method was from Barka and Anderson (1963, pp. 81-83). New methylene blue (Allied Chemical, dye lot 1343P) stock solution was made up to 0.25 M in distilled H<sub>2</sub>O, and the final concentration of dye for staining was 0.005 M in Michaelis veronal acetate buffer at a pH range of 2.6-8.0, with steps of 0.5 pH units. Seven day cultures were fixed, stained for approximately 20 hours, rinsed in distilled H<sub>2</sub>O, dried and mounted with Fisher Permunt. The coverslips were inspected at 400X magnification for changes in dye uptake and intensity.

- B. Materials not included in methods described above
  1. Baltimore Biological Laboratories Basal Medium Eagle
  2. Dimethyl sulfoxide, industrial chemical, Crown Zellerbach
  3. Hydrocortisone, Cortril, USP

RESULTS

I. Ciliary inhibition studies

A. Paramecium

Neither rabbit trachea nor oyster gill cilia are convenient sources of ciliated tissue. Paramecium can be found in most ponds and sloughs and are easily cultivated in an artificial environment. The cilia on Paramecium are a structural and functional analogue of the cilia on mammals and mollusks (Sleigh, 1962, pp. 1-10). To differentiate the effect of CF serum from normal, a series of experiments using a clone of wild-type Paramecium (species unidentified) were carried out.

Preliminary assays with control and CF serum showed that both had a generally lethal effect on the Paramecium within 30 min., and differential effect on cilia was not observed. Table 2 shows the results of an experiment designed to compare the effects of plasma and anti-coagulant compounds on Paramecium. Plasma had a lethal effect. Table 3 shows that serum from cystic fibrotics and controls killed the Paramecium in about 30 min., and combining the data in Tables 2 and 3, one can see that it took twice as long for plasma to kill the Paramecium as serum.

The effects of serial dilution of normal serum are shown in Table 4. The range of 1:2-1:3 dilution was a survival limit. This is a final concentration in the sample well of 1:6-1:9. Comparisons of CF homozygote, CF heterozygote, and normal control plasma in serial dilution are shown in Table 5. At each dilution up to 1:4, where there is 100% survival in all samples overnight, one can observe that Paramecium survival is best in CF homozygote plasma. In two cases, one finds control plasma was more lethal than heterozygote, and in two other cases, the reverse.

The effect of the euglobulin fraction of serum is shown in Table 6.

<u>Sample</u>	<u>Observation of Death or Significant Alteration of <u>Paramecium</u></u>
Isotonic buffered saline with sodium citrate	120 min. - 100% survival
Isotonic buffered saline with heparin	120 min. - 100% survival
Normal plasma with sodium citrate	60 min. - 0% survival
Normal plasma with heparin	65 min. - 0% survival
Isotonic buffered saline	120 min. - 100% survival

Table 2. Effects of Plasma Compared with Isotonic Buffered Saline and

Anti-coagulant Additives on Survival of Paramecium in Lettuce

Medium

Ten  $\mu$ l of plasma or saline with additive were applied to twenty  $\mu$ l of one-half strength lettuce medium containing at least twelve Paramecium. The buffered saline samples in anti-coagulant were prepared by putting the appropriate volume into a vacutainer tube, identical to the tube that drew the blood sample.

<u>Sample</u>	<u>Observation of Death or Significant Alteration of <u>Paramecium</u></u>
NRH (CF hom)*	27 min. - 0% survival
EWR (CF hom)*	20 min. - 0% survival
PSW (N)*	38 min. - 0% survival
BCK (N)#	56 min. - 0% survival

\* serum  
# plasma

Table 3. Effects of Serum or Plasma from Cystic Fibrosis Patients and Normals on Survival of Paramecium in Lettuce Medium

Ten  $\mu$ l of serum or plasma were applied to twenty  $\mu$ l of one-half strength lettuce medium containing at least six Paramecium. The plasma contains heparin.

<u>Sample Dilution</u>	<u>Observation of Death or Significant Alteration of <u>Paramecium</u></u>
PSW(N)	
1:1	45 min. - 0% survival
1:2	65 min. - 0% survival
1:5	overnight - 90-100% survival
1:10	overnight - 90-100% survival
CFT(N)	
1:1	60 min. - 0% survival
1:2	65 min. - 0% survival
1:3	180 min. - 50% survival overnight - 0% survival
1:4	180 min. - 67% survival overnight - 20% survival

Table 4. Effects of Serially Diluted Normal Serum on Survival of Paramecium in Lettuce Medium

Ten  $\mu$ l of normal serum diluted to specifications with lettuce medium were applied to twenty  $\mu$ l of one-half strength lettuce medium containing ten to thirty Paramecium.

Sample Dilution	Time of Observation	Observation of Death or Significant Alteration of <u>Paramecium</u>		
		BBR(N)	CEI (CFhet)	SEI (CFhom)
1:1	5-6 hrs.* overnight	0% S <sup>#</sup>	20% S	50% S
		0% S	0% S	0% S
1:2	5-6 hrs. overnight	67% S	10% S	90% S
		50% S	5% S	50% S
1:2.5	5-6 hrs. overnight	100% S	33% S	87% S
		33% S	5% S	87% S
1:3	5-6 hrs. overnight	100% S	70% S	100% S
		0% S	50% S	100% S
1:4	5-6 hrs. overnight	100% S	100% S	100% S
		100% S	100% S	100% S
1:5	5-6 hrs. overnight	100% S	100% S	not
		100% S	100% S	done

\* CF het observed at 5 hrs., other at 6 hrs.

# S = survival

Table 5. Effects of Serially Diluted Cystic Fibrosis and Normal Plasma on Survival of Paramecium in Lettuce Medium

Ten  $\mu$ l of plasma diluted to specifications with lettuce medium were applied to twenty  $\mu$ l of one-half strength lettuce medium containing at least six Paramecium. Sodium citrate was the anti-coagulant in the plasma.



Sample	* Euglobulin (A) Concentration	No. of $\mu$ l (B)	A X B	Observation of Death or Significant Alteration of <u>Paramecium</u>
ACN	2	1	2	120 min. - 100% survival
ACN	2	2	4	"
ACN	5	2	10	"
	"	"	"	"
	"	"	"	"
RRT (CFhom)	2	1	2	"
	"	"	"	"
LRT (CFhom)	5	5	25	"

Table 6. Effects of Euglobulin Fraction from Cystic Fibrosis Patients and Normals on Survival of Paramecium in Lettuce Medium

Relative amounts corresponding to the euglobulin concentration multiplied by the number of  $\mu$ l used were applied as specified to twenty  $\mu$ l of one-half strength lettuce medium containing at least six Paramecium. Preparation of euglobulin described in Materials & Methods.

\* Concentration of euglobulin was achieved by resuspending the precipitate in buffered saline to either 1/2 or 1/5 the original serum volume used to obtain the precipitate.

Euglobulins were precipitated by acidification of serum with CO<sub>2</sub>, which excludes the pseudoglobulins and albumin, thus considerably reducing the amount of protein in the sample (Cantarow and Shepartz, 1962, p. 51). Normal and CF euglobulin fractions at the strengths tested did not have any deleterious effect on the Paramecium after two hrs.

The effects of heat inactivation of serum complement on survival of Paramecium are shown in Table 7. In all cases complement inactivation of serum allowed for good survival of Paramecium overnight in serum diluted in the minimal proportion of 1:3 which was standard for the assay system.

Scoring ciliary change in the Paramecium was difficult and was the reason death and membrane lysis were chosen as the end point. Aberrant ciliary activity was never differentially noted when comparing the application of CF versus normal serum or plasma to Paramecium.

#### B. Nasopharyngeal explants

Observation of the cultured ciliated fragment showed epithelial outgrowth by the third day, and cilia present on portions of this epithelial monolayer by the fourth day. The epithelial cells also produced mucous globules which were readily observable within the cell cytoplasm. The cilia on the outgrowth moved isochronally, slowly, and even jerkily in contrast to most ciliary motion which is smooth and co-ordinated in a wave-like motion. They also appeared larger than the cilia directly on the explant, and although it was difficult to distinguish a particular site of attachment, they were associated with cells. Preliminary experiments were designed to test the effect of CF and normal sera on the ciliated epithelium in monolayer culture.

For the first hour after replacement of the medium with untreated

Sample	Observation of Death or Significant Alteration of <u>Paramecium</u>
PSW(N)	
H	overnight - 100% survival
UH	25 min. - 10% survival
AEI (CFhet)	
H	overnight - 100% survival
UH	75 min. - 0% survival*
SEI (CFhom)	
H	overnight - 100% survival
UH	30 min. - 10% survival

---

\* At 30 min. 90% were dying.

Table 7. Effects of Decomplemented Serum from a Cystic Fibrosis Heterozygote and Homozygote and a Normal on Survival of Paramecium in Lettuce Medium

Ten  $\mu$ l of undiluted serum which had been heated at 56 degrees C for 15 min. were applied to twenty  $\mu$ l of one-half strength lettuce medium containing at least six Paramecium. Unheated serum from the same sample served as a control. In the table, H and UH refer respectively to heated and unheated samples.

serum, observations were made more or less continuously on the two flasks. No change in cell integrity or ciliary motion was apparent in either the CF or normal sample. Three hours later there was still no change or difference in the two. At nineteen hours the ciliary motion had become a bit stiffer in both, but there was an identical change in the CF and normal samples. The experiment was terminated at this point, and this approach was not pursued further because the degree of general serum toxicity to this ciliated tissue was minimal. Both Spock (1967) and Bowman et al. (1969) found the serum of controls to be ciliotoxic on their cilia sources within one to two hours. They found CF toxicity more rapidly active than normal, and it would seem that a tissue on which serum does not act within eighteen hours is probably not going to behave analogously to the successfully affected rabbit trachea and oyster gills.

### C. Salmonella flagellar antigen

To date, cilia have been the organelle affected by CF serum, however flagella are considered to be a biological and structural equivalent of cilia (Sleigh, 1962, pp. 3-7). Pol antigen is a soluble unit of Salmonella flagella, and because of its solubility can be used in immunodiffusion assays for typical antigen-antibody reaction. Bowman et al. (1970) isolated the active ciliary factor with the immunoglobulin G fraction of serum from cystic fibrotics. It seemed possible that the inhibition was caused by an immunoglobulin G molecule, and that it might have been a typical antigen-antibody precipitation reaction. The demonstration of such an effect would not only be a refinement in the testing for the serum factor but would have important implications regarding pathogenesis of CF.

To investigate this possibility, serum was collected from two CF heterozygotes and one homozygote and reacted against Pol antigen in an Ouchterlony immunodiffusion gel (Figure 3). No precipitation arcs developed during the incubation and diffusion.

## II. Differential staining of fibroblasts with basic dyes

### A. Toluidine blue o and metachromasia

The difficulty of the technique of metachromatic staining was introduced previously. Because erratic and non-specific staining was also the experience of this investigator, several variables were studied.

1. Growth conditions in any study involving tissue culture must be considered important, and in this study these were more subject to random, uncontrollable variation than the staining materials and technique.

a. Coverslip lots were checked against one another and were also washed in acid or wiped with ethanol to ensure cleanliness.

b. Eagle's Minimum Essential Medium was replaced with Basal Medium Eagle which contains 1/2 the amino acid supplement.

c. Commercial serum supplies can vary widely in their quality and effect on growing cells, so two separate lots of fetal calf serum were compared.

d. Erratic metachromasia was first noticed during the spring months when local water is heavily treated with chlorine-amines for sanitation. At the time, the water used to make up the medium was triple-distilled but not regularly deionized. Deionization is required for removal of chlorine-amines. The water used in the preparation of

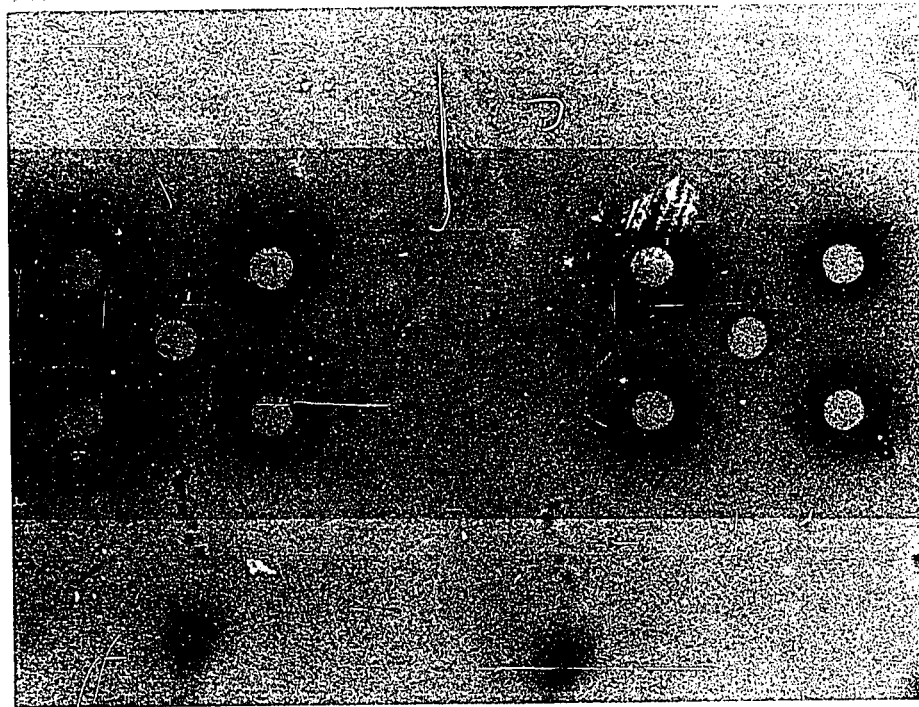

Figure 3. Immunodiffusion Plate with Cystic Fibrosis Serum Reacted

Against Salmonella Flagellar Antigen and Stained with Amido Black

1. SEI (CFhom), 15  $\mu$ l serum
2. CEI (CFhet), 15  $\mu$ l serum
3. SEI (CFhom), 10  $\mu$ l serum plus 5  $\mu$ l water
4. AEI (CFhet), 15  $\mu$ l serum
5. Pol antigen, 10  $\mu$ l
6. SEI (CFhom), 15  $\mu$ l serum
7. CEI (CFhet), 10  $\mu$ l serum plus 5  $\mu$ l H<sub>2</sub>O
8. SEI (CFhom), 10  $\mu$ l serum plus 5  $\mu$ l H<sub>2</sub>O
9. AEI (CFhet), 10  $\mu$ l serum plus 5  $\mu$ l H<sub>2</sub>O
10. Pol antigen, 5  $\mu$ l plus 5  $\mu$ l H<sub>2</sub>O

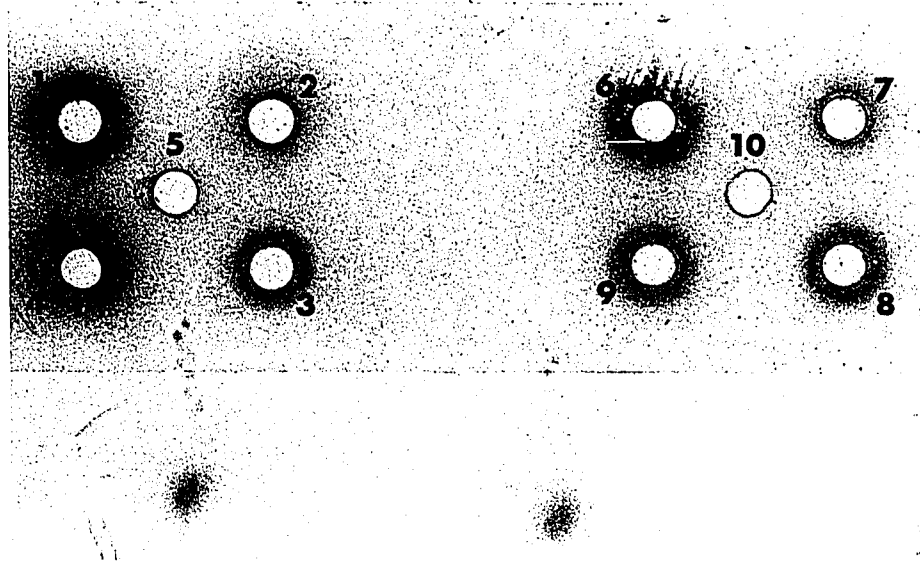

Figure 3. Immunodiffusion Plate with Cystic Fibrosis Serum Reacted

Against Salmonella Flagellar Antigen and Stained with Amido Black

1. SEI (CFhom), 15  $\mu$ l serum
2. CEI (CFhet), 15  $\mu$ l serum
3. SEI (CFhom), 10  $\mu$ l serum plus 5  $\mu$ l water
4. AEI (CFhet), 15  $\mu$ l serum
5. Pol antigen, 10  $\mu$ l
6. SEI (CFhom), 15  $\mu$ l serum
7. CEI (CFhet), 10  $\mu$ l serum plus 5  $\mu$ l H<sub>2</sub>O
8. SEI (CFhom), 10  $\mu$ l serum plus 5  $\mu$ l H<sub>2</sub>O
9. AEI (CFhet), 10  $\mu$ l serum plus 5  $\mu$ l H<sub>2</sub>O
10. Pol antigen, 5  $\mu$ l plus 5  $\mu$ l H<sub>2</sub>O

media was distilled, deionized, and then re-distilled in an all glass still.

e. Culture contamination for bacteria was checked with thioglycollate medium, for fungus and yeast with Saboraud's agar, and for mycoplasma at the Provincial Laboratory.

f. Kraus et al. (1971) found that density of inoculum at subculture had an effect on percentage of metachromatic cells with CF. Sparse and dense inocula showed maximum metachromasia, whereas intermediate inocula had reduced levels of metachromatic cells. Results in this present investigation were reassessed to ascertain a difference in level of metachromasia from time of subculture, with a range of 3-32 days. This assessment could be analogous to variation by inoculum size, because Kraus and workers stained their samples regularly at intervals shortly after subculture. No difference in levels of metachromatic cells was recorded for any CF strain when comparing length of time from subculture. Figure 4 shows CF fibroblasts stained at 3 and 22 days after subculture.

g. Normal, diploid cell strains such as the ones employed for this study are known to age in culture and eventually die (Hayflick, 1970). Also, the number of potential doublings of a cell strain continually declines as the age of the donor increases, which indicates a correlation of in vivo and in vitro aging. In vitro aging can be followed by certain changes such as an increase in cell size, increased activity of acid phosphatase, and increased RNA content (Cristofalo, 1970). Nadler (1969b) has noted an increase of metachromasia in control cell strains as their age increases. He does not distinguish combined in vivo/in vitro cell strain age from simple in vitro cell aging.



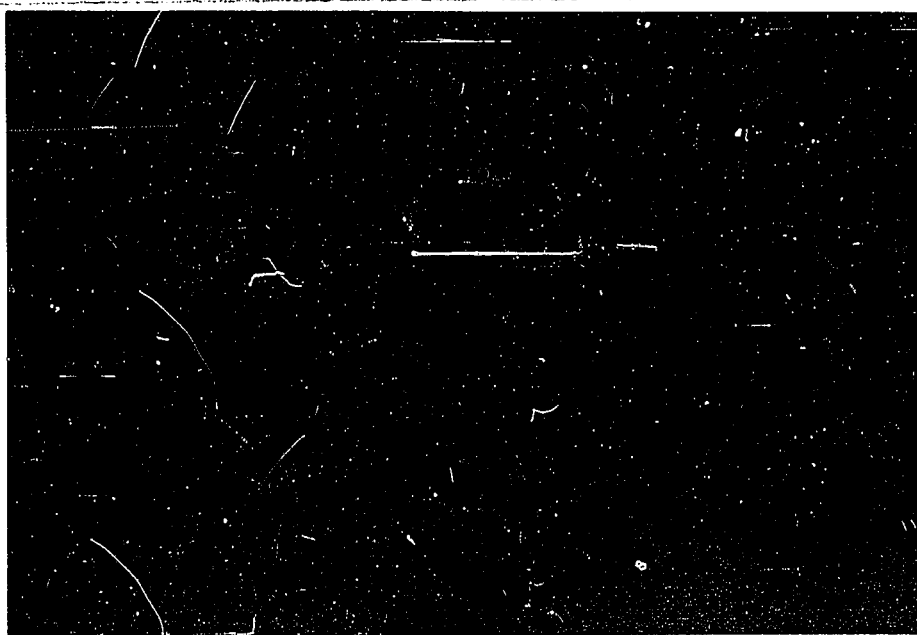
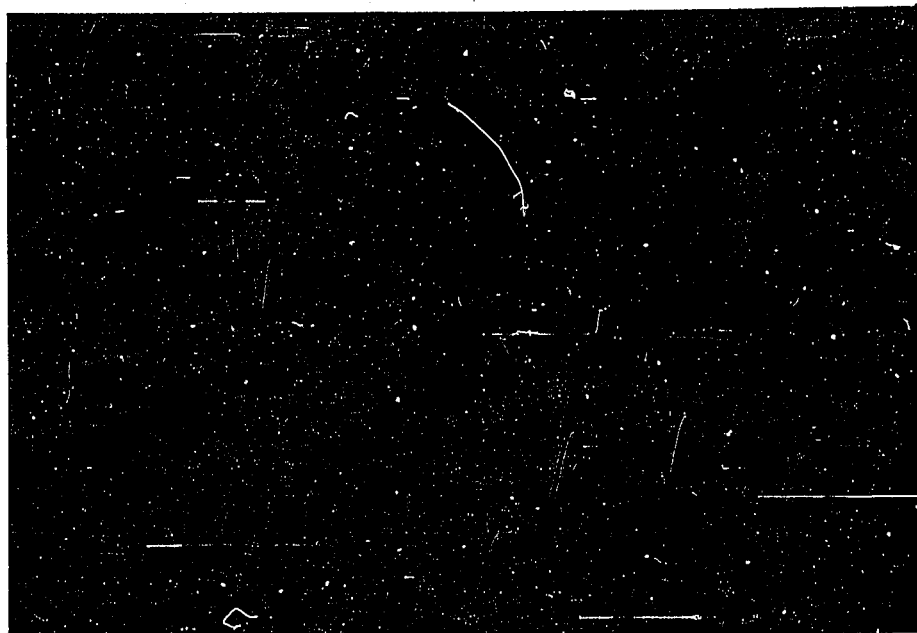

Figure 4, a & b. Cells from a Cystic Fibrosis Homozygote Stained  
3 (a) and 22 (b) Days after Subculture.

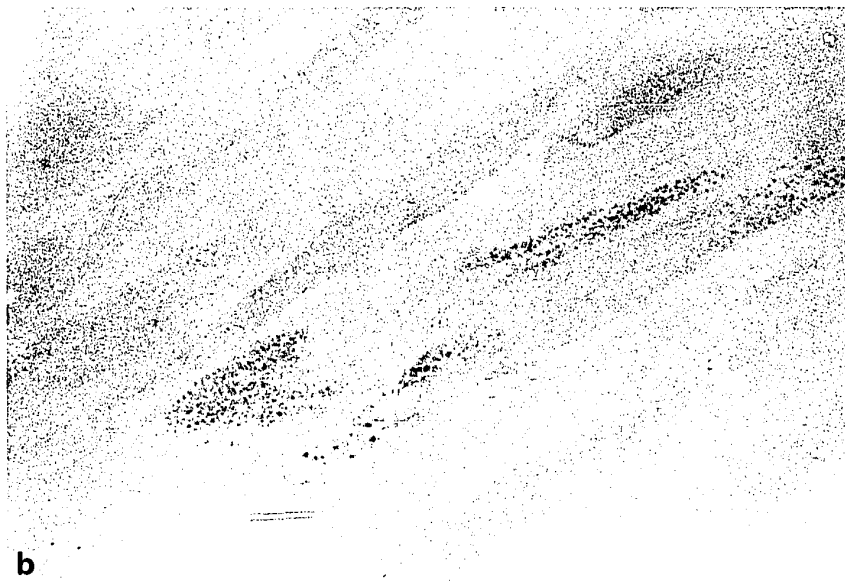
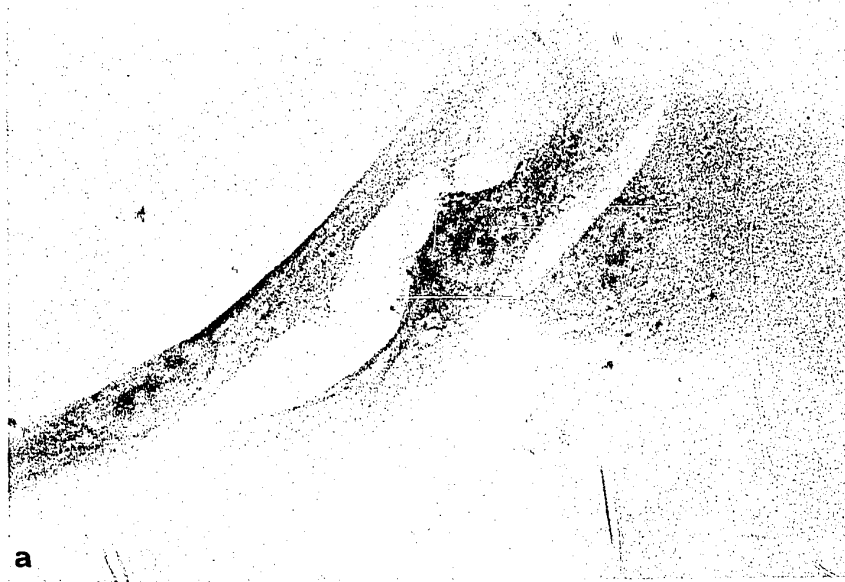

Figure 4, a & b. Cells from a Cystic Fibrosis Homozygote Stained  
3 (a) and 22 (b) Days after Subculture.

Table 8 illustrates an assessment of metachromasia in control cell strains in relation to age of donor and age, in months, of strains in culture. Each month of culture age represents about 4 cell doublings. The strains exhibited both false and true metachromasia, and the difference between them is in the degree of red; true is more pink, false is dark purple, but clearly set apart from the blue color of the rest of the cell. False metachromasia was characterized as the type of metachromasia most prevalent in control cells, but in addition would appear in CF and San Filippo cells as well. Danes and Bearn (1969a) published color photographs of metachromatic CF cultures, and in those it can be seen that their metachromasia is pink, not purple. Therefore, it was decided that in this investigation the dark purple metachromasia would not be accepted as a true positive. It was not determined what molecular species was responsible for this dark metachromasia, but since it was present extensively in several controls it was assumed not to be acid mucopolysaccharides. Unfortunately, the distinction between dark and pink metachromasia was not always clear, and made scoring that distinguished the two very arbitrary and difficult. Figure 5 shows true, false, and ametachromatic cells from 3 separate slides of the same control subject.

The only variable found to have a definite influence on the expression of cellular metachromasia was in vivo/in vitro aging. False positive results in several control strains were a continual obstacle in the attempt to differentiate them from CF and San Filippo strains. These false positives could appear as either pink or purple metachromasia, and their frequency in the control population prompted categorization of them as false. More than 10% metachromatic controls

Control Strain Code	Age of Donor (in yrs)	Culture Age of Cell Strain in Months												
		2	3	4	5	6	7	8	9	10				
SLR(N)	0.02	-/-/ f	-/-/ f	-/-	-	-/-/ -	-/ f/f	+	+					
OEN(N)	0.02	-/-/ f	-/-	-/-/ -	-	-/-	-/ f/f	+	+					
LSK(N)	7	-/-/ -												
DMK(N)	15													
KKY(N)	15													
BBR(N)	22													
JAN(N)	22													
HGL(N)	32													

Table 8. Qualitative Assessment for Metachromasia on Control Strains Matched Against their Age (Donor Age plus Culture Age)

- = ametrachromatic, f = false or purple metachromasia, + = true or pink metachromasia  
 Each mark (-, f, +) is the score of metachromatic type for one cover slip stained in a routine experiment with toluidine blue o. Runs whose samples (including CF and San Filippo) were completely ametrachromatic were not scored.

Figure 5, a, b, & c. Demonstration of True (a) and False (b)  
Metachromasia and Ametachromasia (c) in the Cells of One  
Control Strain.

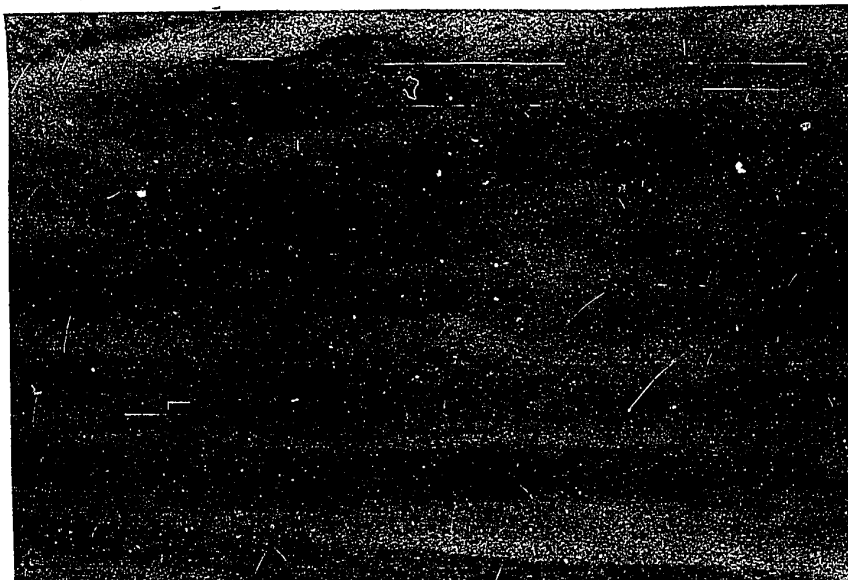
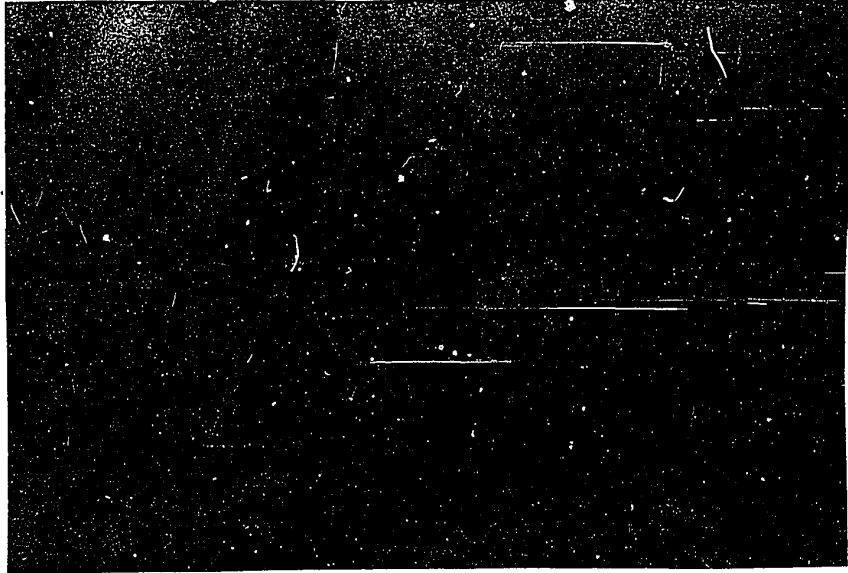

is higher than the expected frequency (Bearn and Danes, 1970). As Table 8 demonstrates, there was a definite trend to have metachromasia in an older cell strain, with both in vivo and in vitro age playing a role.

2. As mucopolysaccharides are soluble in aqueous solution, the possibility of faulty fixation before submitting the monolayer to a 70% aqueous stain solution was considered. McManus and Mowry (1960, p. 133) state that strong oxidants in the fixative can produce "factitious metachromasia", and simple fixatives such as alcohol or formalin are the best.

a. Absolute MeOH was the routine fixative, and since the supply was periodically renewed, several sources of MeOH were compared. The MeOH was treated with 2-mercaptoethanol to reduce oxidation products and prevent further oxidation. Formaldehyde, as a typical oxidation product in MeOH and a common fixative, was added in amounts from 0.4-2.0% of the MeOH. The pH of the MeOH was adjusted in another series of experiments to 5.5, 6.0, 8.0, and 9.5 with an unadjusted pH of 6.0-7.0.

b. A mixture of tetrahydrofuran (THF) and acetone, 1:1, was used successfully by Matalon and Dorfman (1969) to fix cells for metachromatic staining. Proportions of THF/acetone at 7:3, 1:1, and 3:7 were compared with MeOH. Although the pH of this mixture is difficult to measure, solutions at pH greater than 7.0 and less than 7.0 were compared.

c. Barka and Anderson (1963, p. 16) recommend freeze substitution as a superior method of fixation, and this was tried. The monolayer was fixed in MeOH at  $-50^{\circ}$  C overnight after being frozen at  $-192^{\circ}$  C.

d. Selective precipitation of acid mucopolysaccharides can be

accomplished with detergents like cetyltrimethylammonium bromide (Brimacombe and Webber, 1964, p. 4). The detergent makes a quaternary ammonium complex with the anion which is insoluble in aqueous solutions of low ionic strength:

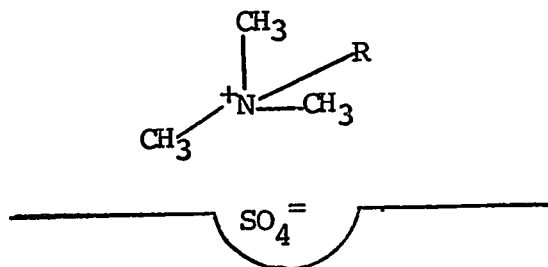

Using cultured epithelial cells, Wiebkin (1971, pp. 16 & 30) obtained his best results using cetylpyridinium chloride to precipitate acid mucopolysaccharides. In the next step, the dye replaces the detergent on the anionic group. To try this method, the monolayers were fixed in absolute MeOH containing 1% cetyltrimethylammonium bromide, and CF cells were compared with control and San Filippo cell strains.

None of the described variations in fixation were successful in differentiating CF, San Filippo, and control cells in a consistent manner. For example, a THF/acetone mixture at 3:7 proportions and near neutral pH would only occasionally provide distinguishing metachromasia when comparing the three populations. Freeze substitution gave the highest level of dark purple or false metachromasia in CF cells and the lowest in San Filippo cells, with controls at intermediate levels.

Table 9 shows a summary of four experiments on cells fixed with 1% cetyltrimethylammonium bromide in absolute MeOH. Three CF patients, six controls, and one San Filippo patient are included in this table.



<u>Experiment</u>	<u>Cystic Fibrosis</u>	<u>Control</u>	<u>San Filippo</u>
I	+	-	not done
II	±/+	+ / ± / - / - / ± / +	-
III	± / ±	+ / ± / - / + / - / ±	±
IV	- / ±	± / ±	- / -

+ = greater than 5% metachromatic cells  
 ± = 1-5% metachromatic cells  
 - = less than 1% metachromatic cells

Table 9. Metachromasia Ratings with Cetyltrimethylammonium Bromide Precipitation

Figure 6 compares cells from the CF and control noted in Experiment I, Table 9.

3. Theoretical considerations More important than fixative for success of the technique is the nature of the dye and the dye solution (Barka and Anderson, 1963, p. 85; Kelly, 1966; Kramer and Windrum, 1955). Basophilia or the tendency of the acid groups to bind a cation such as dye, depends on several factors, chiefly pH, ionic concentration, and dielectric constant of the staining bath (Kelly, 1966). The importance of these variables lies in their effect on the dissociation of the anions or on the interaction and possible polymerization of the dye molecules during their binding on the anions. The concentration of the dye is also important, since the shift in wavelength that causes metachromasia is dependent on the steric interaction of the bound dye molecules, and the spatial relationship of dye bound to acid groups can be influenced by dye concentration. Too much dye can bring metachromasia back to orthochromasia (Schubert and Hamerman, 1956). This evidence has chiefly been obtained with solutions of dye and target molecule, but can be

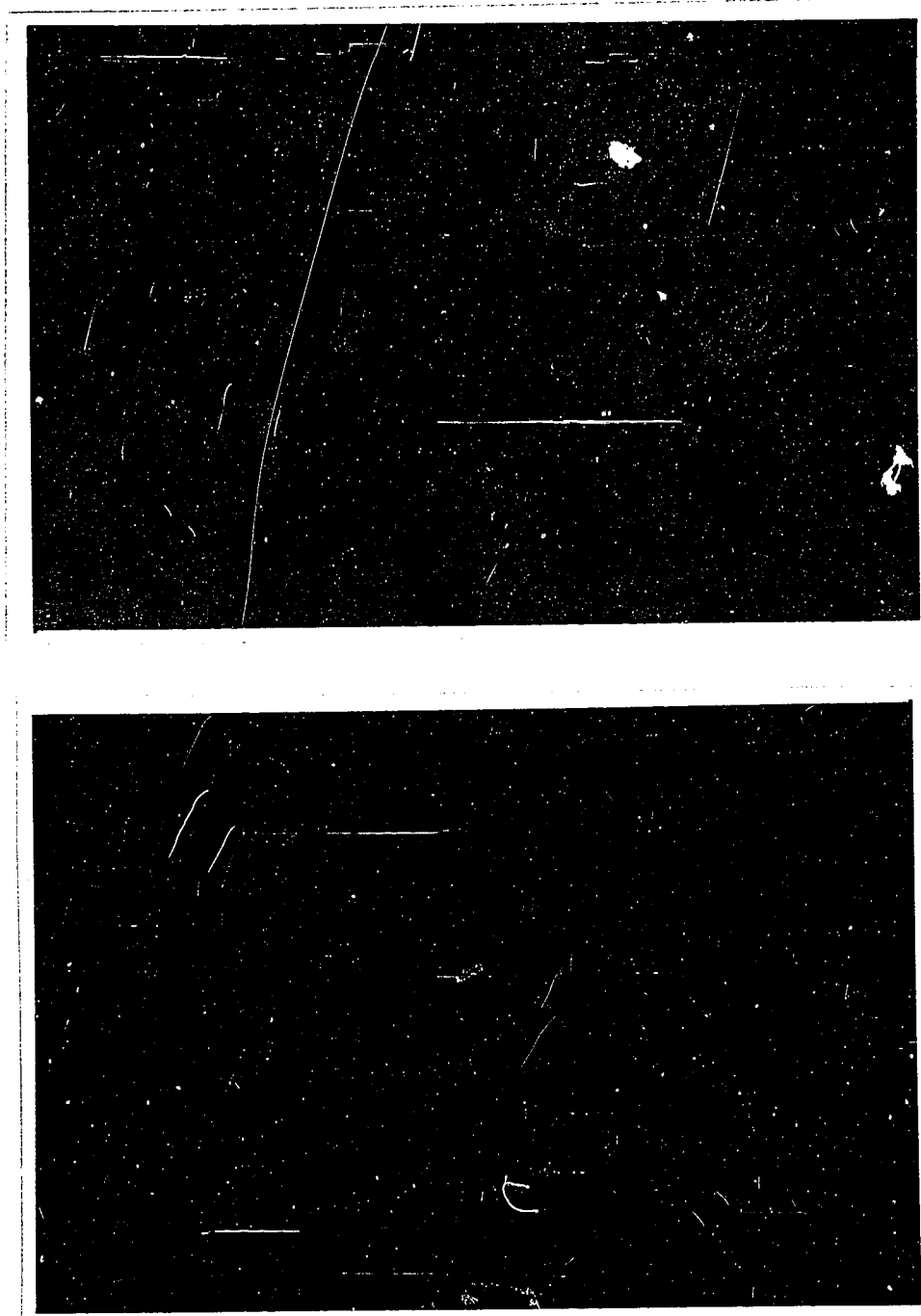

Figure 6, a & b. Cells Fixed with Cetyltrimethylammonium Bromide from a Control (a) and a Cystic Fibrosis Subject (b).

applied to and evidenced in tissue staining (Kramer and Windrum, 1955). With these points in mind, some experiments with the dye solution were done.

a. Results of varying concentrations of toluidine blue o and MeOH are seen in Table 10.

		Percentage of MeOH			
		16	30	50	70
Percentage of Toluidine blue o	0.1	-	-	-	nd
	0.3	nd	nd	±	-
	0.4	nd	nd	±	nd
	0.5	nd	nd	±	nd

- = no metachromasia    nd = not done  
± = some metachromasia

Table 10. Appearance of Metachromasia in Cystic Fibrosis and Control

Cells Related to Concentration of MeOH and Dye in the Stain

Each negative (-) result was obtained on 2 CF samples. The positive (±) results were obtained on 4-7 CF samples and 1-4 control samples.

b. Time of dye interaction with cells was varied. All monolayers in this series were stained with 0.25% dye in 50% meOH. Indications for this approach arose from observations of good metachromasia on CF and San Filippo cells and no metachromasia on control cells started from a newborn, when the cells were accidentally subjected to a very brief staining.

In the first set of experiments cells were stained no more than 30 sec. Out of four trials, metachromasia was present in CF and San Filippo cells only in two, and controls only in two.

In the second set of experiments cells were stained 3, 5, and 7 min. The results were erratic with no correlation of metachromasia with any cell type.

It should be noted that the positive controls were from older cell strains and older donors.

c. The effect of pH of the dye solution is shown in Table 11.

<u>Sample</u>	<u>pH of Stain</u>				
	<u>3.0</u>	<u>3.5</u>	<u>4.0</u>	<u>4.5</u>	<u>5.0</u>
SLR(N)	-	-	-	-	-
WDS (CFhom)	-	-	+	++	++
JEI (CFhom)	-	-	-	++	++
BST(SF)	-	-	-	++	++

- = no metachromasia

+ = a few pale pink vesicles

++ = some vesicular and granular metachromasia

Table 11. Effect of pH Variation of Stain on Appearance of Cells Stained with Toluidine Blue o

The intensity of the blue stain in the cells increased as the  $[H^+]$  of the stain was lowered. Figure 7 shows cells from WDS (CFhom) at pH 4.0 and 4.5.

Metachromasia was not noted for the San Filippo positive control until pH 4.5 at which pH the two CF strains also showed metachromasia, but the control did not. To ascertain the possible consistency of these results at pH 4.5, three experiments reported in Table 12 were done.

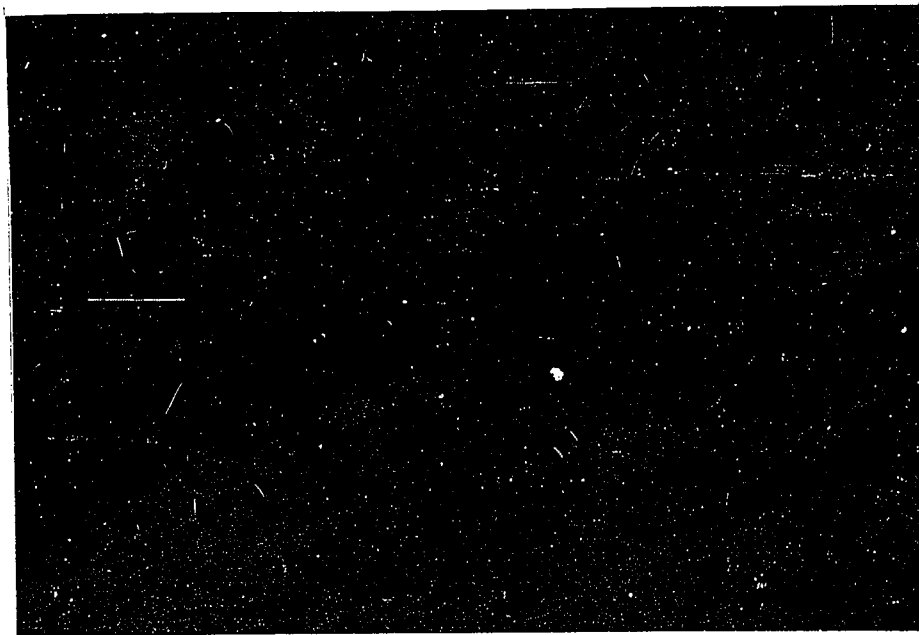

Figure 7, a & b. Cells from WDS (CFhom) Stained at pH 4.0 (a)  
and pH 4.5 (b).

<u>Sample</u>	<u>Experiment</u>		
	<u>I</u>	<u>II</u>	<u>III</u>
SLR(N)	1-2%	0%	0%
WDS (CFhom)	10-20	10	5-10
JEI (CFhom)	10	1-2	1-2
BST(SF)	1-2	2-3	1-2

Table 12. Staining Results with Toluidine Blue o at pH 4.5

Percentages represent estimates of metachromatic cells

d. As barium and uranium salts have been reported to enhance metachromasia (Gabe, 1968, p. 360), 0.001 M Ba<sup>++</sup> was added to the stain solution on several occasions. Qualitative assessment indicated that there was no obvious improvement in results using Ba<sup>++</sup>, and this approach was therefore abandoned.

e. Various acidic groups attached to macromolecules can display metachromasia, and the ease with which alcohol dehydration can abolish this metachromasia is used to differentiate the groups (Barka and Anderson, 1963, p. 85; Schubert and Hamerman, 1956; Kramer and Windrum, 1955). Schubert and Hamerman feel that the molecules that lose metachromasia in alcohol are dissolving in it, and that precipitated anion-dye complexes that do not dissolve also do not lose their metachromasia. Sulfate groups are considered the strongest metachromatic anion with carboxyl and phosphate groups exhibiting a weaker metachromasia. Presumably, sulfate esters retain their metachromasia through any amount of dehydration. The most prevalent acid mucopolysaccharide in CF cells is hyaluronic acid, a non-sulfated mucopolysaccharide (Matalon and

Dorfman, 1968), and therefore a less strongly metachromatic molecule.

Dehydration was considered a possible problem in technique because of certain results obtained fairly consistently in this work. A noticeable increase in percentage of metachromatic cells was usually found at a point on the coverslip in contact with the staining basket where less vigorous dehydration would take place. After shortening dehydration, initial results indicated a trend toward metachromasia in CF and San Filippo cells and not in controls. However, the improvement was not sustained in subsequent experiments and the possibility that the initial results were fortuitous must therefore be considered.

4. Sulfate esters are the most strongly metachromatic anion in tissue, but the predominant acid mucopolysaccharide in CF cells is hyaluronic acid which is non-sulfated. Sulfation of neutral mucopolysaccharides and mucoproteins can result in their becoming more highly metachromatic (Spicer and Henson, 1967, p. 89). The sulfation technique of Moore and Schoenberg as described by Barka and Anderson (1963, p. 164) was modified and applied to the cell monolayers of control, CF, and San Filippo cells in order to assess the effect on "positive" and "negative" controls. San Filippo cells have high stored amounts of dermatan sulfate and hyaluronic acid (Matalon and Dorfman, 1960). Danes and Bearn (1966b) have found that mucopolysaccharide storage disorder cells take from 2-6 mos. to show maximum storage and metachromasia. They also found that the degree of sulfation of the molecule can vary depending on culture conditions. At the time of the sulfation experiments the San Filippo cells had been in culture for 3 1/2 mos., and had not demonstrated appreciable levels of metachromasia in any experiment prior to that time. It is possible that the San

Filippo cells did not have high enough amounts of dermatan sulfate to provide a sufficient concentration of sulfate ester to produce metachromasia. It was hoped that higher levels of sulfation on the mucopolysaccharides of both CF and San Filippo cells would make them more easily demonstrated with toluidine blue o stain.

Two experiments were done and results showed that sulfation had destroyed the cells to the extent of abolishing definitive estimation of metachromasia. This was likely due to the harsh treatment required for sulfation which involves a 10 min. immersion of the cells in a mixture of equal parts of concentrated sulfuric acid and glacial acetic acid. Figure 8 shows a CF, San Filippo, and control monolayer, and while one can discern a trend toward more metachromatic material in the CF and San Filippo slides, overall destruction of the cells was too extensive for quantitative assessment of the different strains.

5. Bartman et al. (1970) concluded from electron micrographs on fibroblasts that CF metachromasia was contained in excess lysosomes. Dimethyl sulfoxide (DMSO) is a dipolar, aprotic solvent that is considered to increase membrane permeability. Studies by Misch and Misch (1969) and Lee (1970) showed that DMSO increases the detectable specific activity of lysosomal enzymes in rat liver homogenates with lysosomes intact. If the increased mucopolysaccharide in CF cells is contained in lysosomes, then DMSO might be expected to reduce metachromasia by increasing lysosomal permeability and making the mucopolysaccharide more available to the degradative enzymes found in the lysosomes. Stenchever et al. (1967) showed that concentrations of 1% DMSO on human fibroblasts did not have any serious adverse effects on growth. Chang and Simon (1968) found that growth of HeLa cells was



Figure 8, a, b, & c. Cells after Sulfation and Toluidine Blue o  
Stain from a Cystic Fibrosis Subject (a), a San Filippo  
Subject (b), and a Control (c).

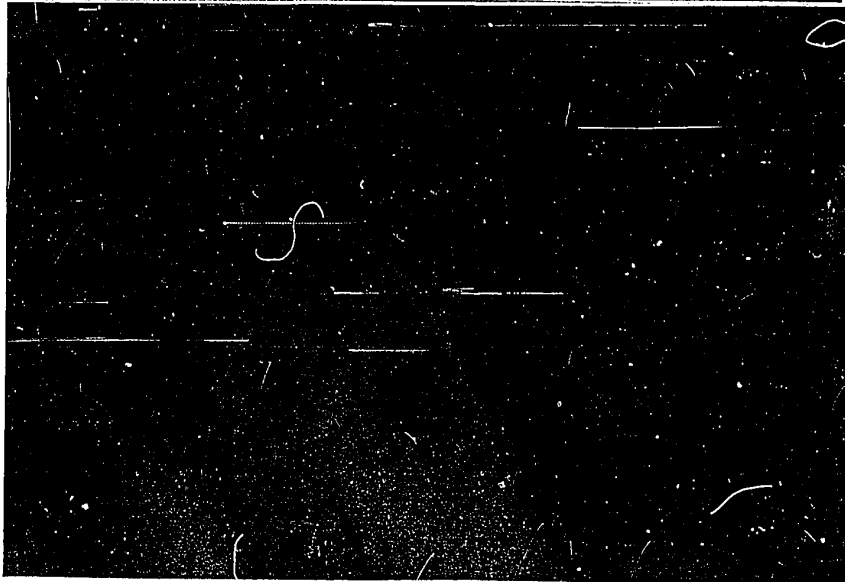
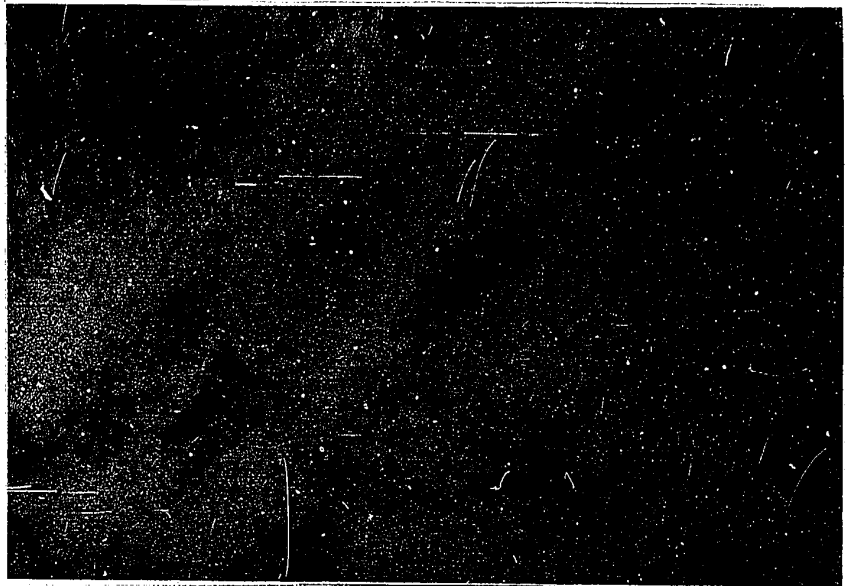
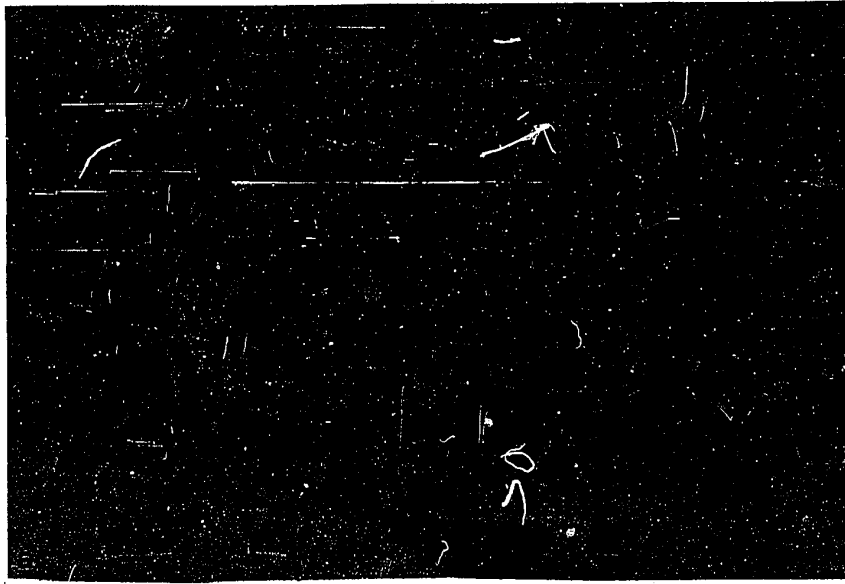

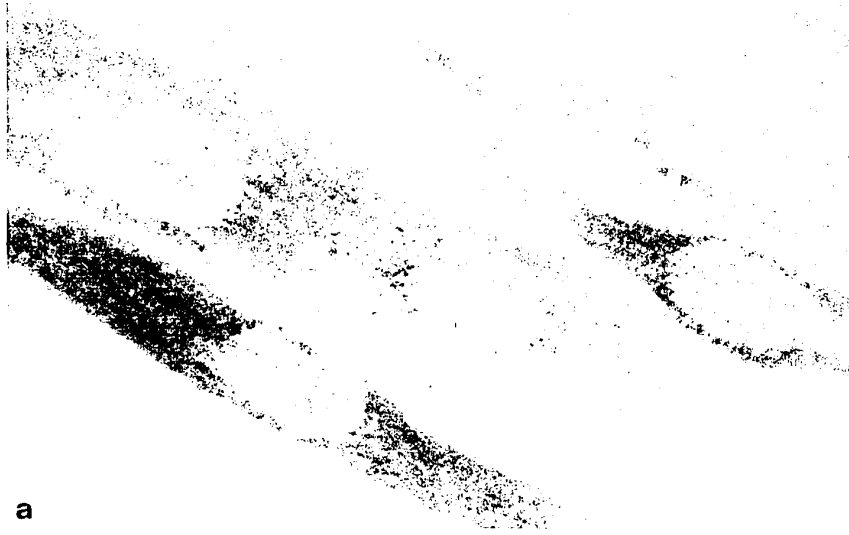

**a**



**b**

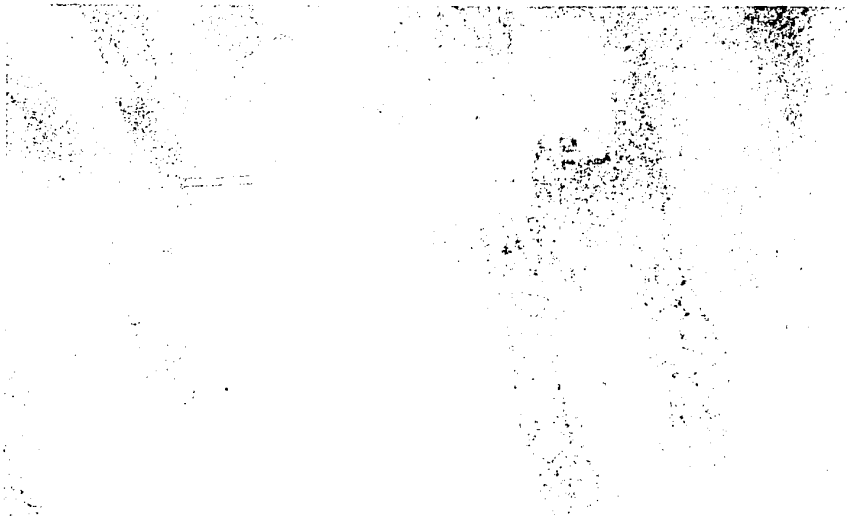

**c**

not restricted until 2% DMSO was used, and L-cells could grow well in up to 3%.

Replicate cultures with DMSO at concentrations up to 1.5% were run for 3-15 days and were then stained in 0.1% dye in 30% MeOH. At the time these experiments were run, the appearance of metachromasia was consistent in CF cells only, and the metachromasia was pink, not purple. San Filippo cells were not available for these experiments.

The data obtained were preliminary and qualitative in nature, nonetheless, it was readily observable that DMSO in increasing amounts on CF cells showed a proportionate decrease in numbers of metachromatic cells, indicating a probable DMSO effect.

6. Hydrocortisone stabilizes lysosomes (Weissmann, 1969, pp. 276-279), and also is known to extend the doubling potential of cells in tissue culture (Hayflick, 1970). It was thought that perhaps hydrocortisone would enhance metachromasia by protecting the mucopolysaccharide from degradative lysosomal enzymes, in contrast to the effects of DMSO. Levels of 1 ug/ml ( $2.75 \times 10^{-6}$  M) were used in the medium, because Reynolds (1966) found that this amount did not inhibit DNA synthesis in cultures of chick bone rudiments.

Preliminary results showed that, contrary to expectations, hydrocortisone reduced metachromasia in both CF and control cells. Unfortunately, at this stage of the work the staining was non-differential, however, experiments were undertaken to find out if all metachromasia was being abolished by hydrocortisone, or if only false positive metachromasia was being affected.

Two experimental designs were used to evaluate the effects of hydrocortisone on metachromasia. One experiment recorded effects of

addition of hydrocortisone, and the second experiment monitored withdrawal of hydrocortisone. Cells were fixed in THF/acetone and stained with 0.25% dye in 50% MeOH at approximately one and two week intervals following the hydrocortisone change in their growth medium. Scoring was done blind.

Figure 9 shows the effect of withdrawal. After at least 4 weeks in the presence of hydrocortisone, only a CF strain shows appreciable metachromasia, but cultures of all strains have high levels of metachromasia after withdrawal of hydrocortisone. In this experiment, the control is an older cell strain.

Figure 10 gives metachromatic indices on strains after hydrocortisone had been added to the medium. At day 7 there is noticeable reduction in the number of metachromatic cells in 2 CF strains, although the third strain showed no metachromasia either with or without hydrocortisone. At day 16, two aging controls show marked decrease in metachromatic index. Two CF strains show some decrease and the third an increase.

In general, significant increase in metachromasia was seen in 8 out of 8 cultures following withdrawal of hydrocortisone. After addition of hydrocortisone, 6 out of 12 cultures showed significant reduction in metachromasia, 3 others showed significant increase, and 3 showed no change.

#### B. Methylene blue extinction

Methylene blue extinction is a useful staining method for visualizing the isoelectric point (pI) of tissue constituents. The principle is that the dye uptake of single molecular species will be extinguished as the pH of the stain approaches the isoelectric point of the molecule to which the stain binds. For a basic dye such as

7 Day Withdrawal from Hydrocortisone

17 Day Withdrawal from Hydrocortisone

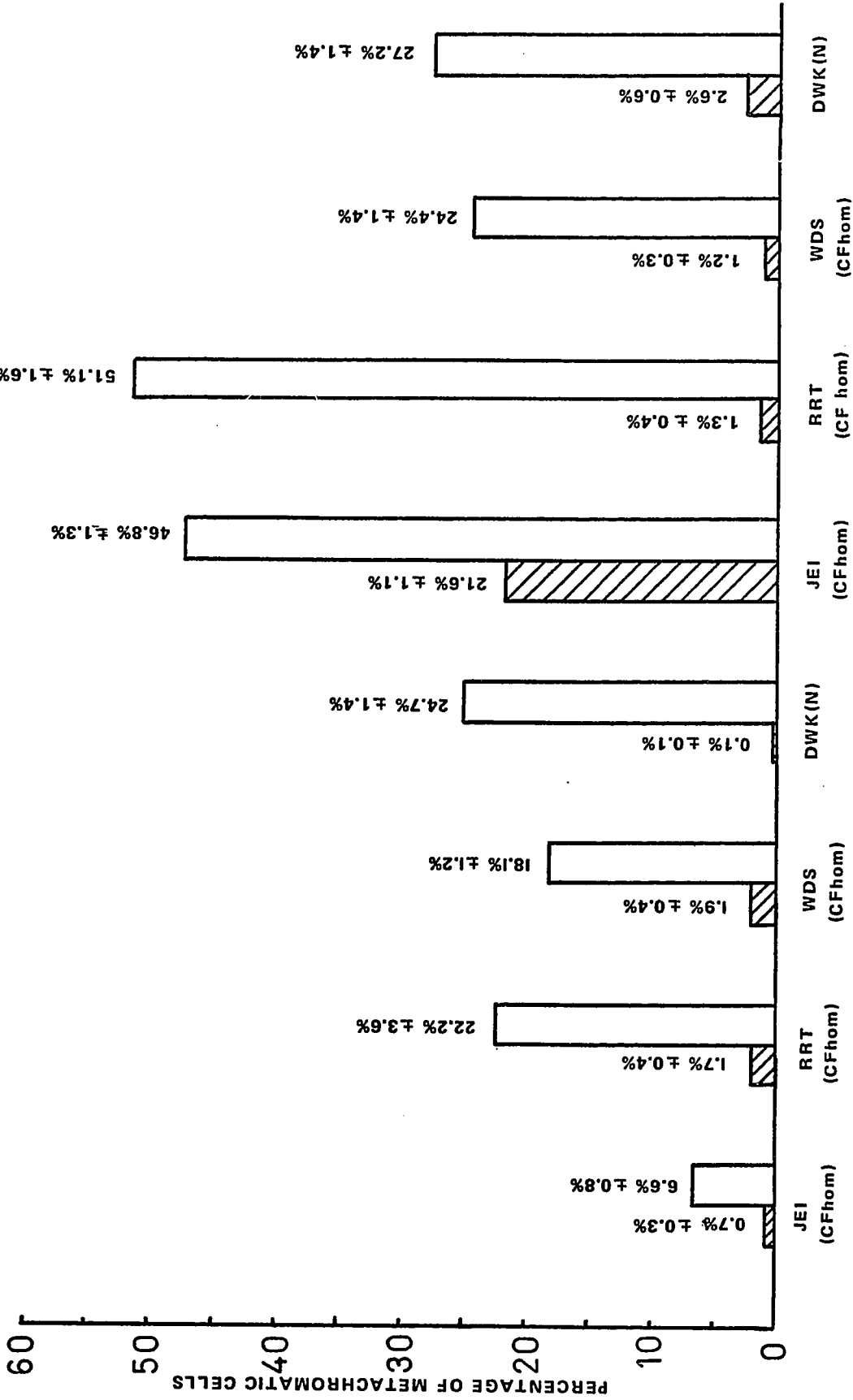

SUBJECTS

Figure 9. Percentages of Metachromatic Cells Grown in Hydrocortisone, 1 ug/ml, Compared with Cells Removed from Hydrocortisone for 7 and 17 Days.

Cross-hatched bars represent cells in the presence of hydrocortisone.  
 Range of percentages is Standard Error of the Proportion,  $\# - .05$ .

7 Days in Hydrocortisone

16 Days in Hydrocortisone

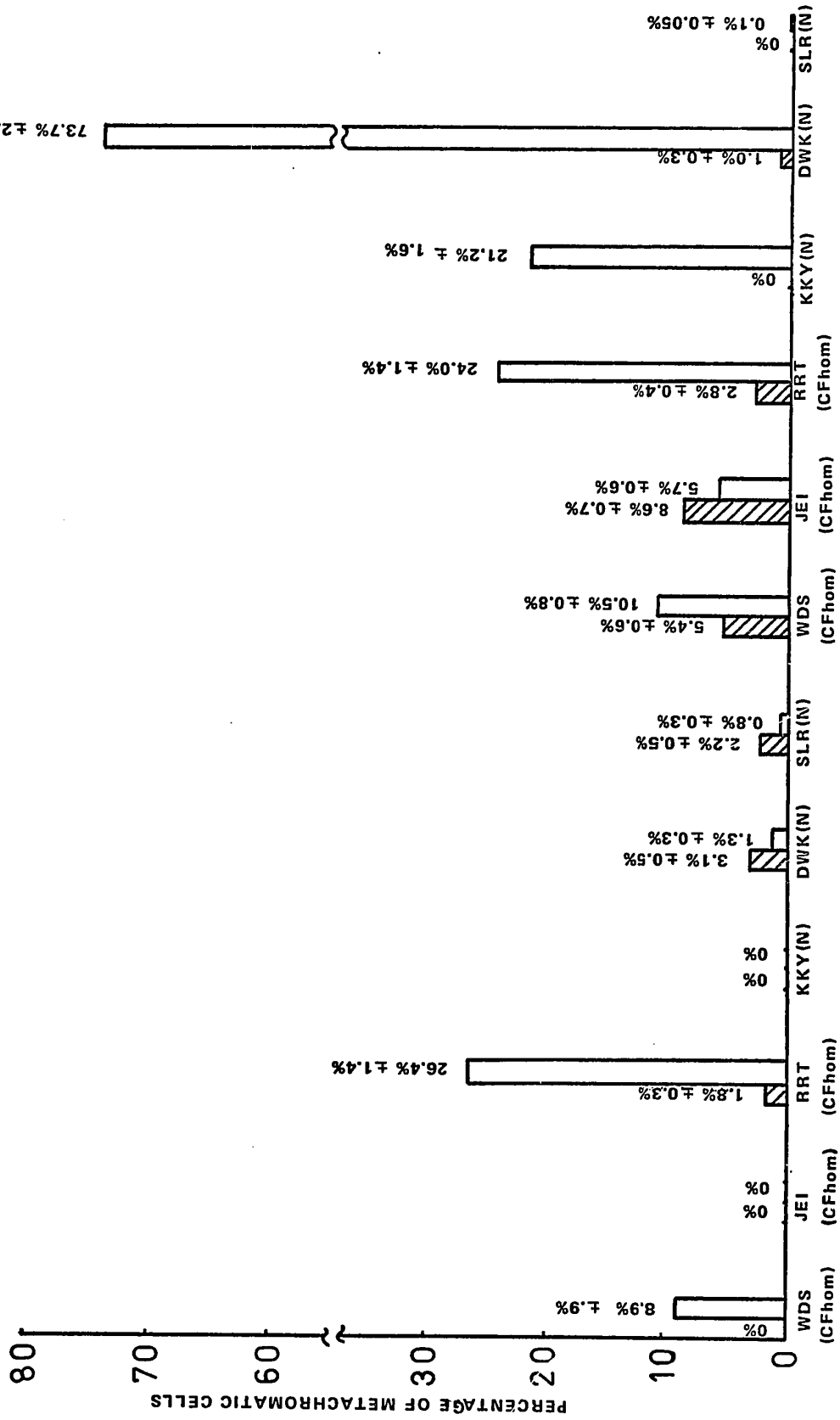

SUBJECTS

Figure 10. Percentages of Metachromatic Cells Grown in Maintenance Medium Compared with Cells having Hydrocortisone, 1 ug/ml, Introduced into the Medium for 7 and 16 Days.

Cross-hatched bars represent cells in the presence of hydrocortisone. Range of percentages is Standard Error of the Proportion,  $\bar{z} = .05$ .

methylene blue, there will be no available anions to bind the dye on the molecule as the pH is brought to the acid side of the pI (Barka and Anderson, 1963, pp. 81-82). Fibroblasts in tissue culture contain such macromolecules as collagen, pI = 6.7, and lipoproteins, pI = 5.2-5.9. Acid mucopolysaccharides and nucleic acids have a pI in the range of 2.0. The excess of acid mucopolysaccharides in the CF and San Filippo cells should appear quite visibly as dark blue cytoplasm or cytoplasmic inclusions at a pH well below that for dense basophilia in normal cells.

Two series of experiments were done, each having a CF subject, a San Filippo subject, and a control; six different strains all together. The two experiments varied only in the method of fixation. The first series was fixed in THF/acetone, and the second series in 1% cetyltrimethylammonium bromide in absolute MeOH.

The intensity in color for all cells increased with increasing pH. For example, the cytoplasm from pH 2.6 to 3.6 was almost invisible, but then began to appear, at pH 4.1, as pale blue becoming increasingly darker with each increment upward in pH, and the nucleolus was observed to be white until pH 5.1, when it began to appear blue. However, no difference in dye intensity between CF subjects, San Filippo subjects, and controls at any pH for any area of the cell was observed in either series.



DISCUSSION

I. Ciliary inhibition studies

A. Paramecium

The goal of the ciliary inhibition studies was to find an easily obtainable source of ciliated tissue that would serve as a substitute for rabbit trachea and oyster gill.

The first experiments showed that normal plasma kills the Paramecium in about one hour, and normal serum acts in one-half that time. Since plasma contains clotting factors, it might be inferred that coagulation increases availability of a toxic factor to the Paramecium, or that additives such as heparin and sodium citrate interfere with the toxic factor. Lethal dilutions of serum and plasma were found on Paramecium. Again, serum is seen to be more lethal than plasma: serum at 6.5% or less of the chamber medium was the limit for 100% survival of Paramecium overnight, but plasma could be as high as 8.5% of the chamber medium. This plasma/serum difference was not paralleled on other tissues used by Spock, Besley, or Bowman and prompts suspicion that the Paramecium lethality factor is different from the CF inhibition factor.

A difference between CF and control serum or plasma cannot be seen in these experiments. Similarly, the euglobulin concentrates did not distinguish CF from control serum but did abolish serum toxic effects. The predicted effect of the ciliary inhibition factor on Paramecium is either not present or not demonstrated due to non-specific toxic effects of serum in the test system.

The effect of heat inactivation in abolishing serotoxicity seemed to implicate a complement dependent immune factor in human serum directed at Paramecium. Abolition of this effect still did not permit

the differentiation of CF and normal sera on the basis of ciliary inhibition.

Subsequently, similar results were reported. Preston and Jahn (1972) observed complement mediated death on Tetrahymena pyriformis, a ciliated protozoan, and found that de complementation by BSA-antiBSA precipitation in serum samples enabled the Tetrahymena to remain intact. Before de complementation, they found the sera to be decreasingly cytolytic in this order; normal, CF heterozygote, CF homozygote. It therefore appears that serum toxicity to ciliated protozoans is not directly related to CF in the way that has been shown on other ciliated tissue. Preston and Jahn feel there may be some significance in the inverse relationship.

The experiments reported in this thesis do not fully support that contention, as it was never clearly obvious that control samples were more rapidly lethal than CF samples. A trend in that direction was observed but was not pronounced enough to serve as a discriminant between CF and control samples in the test system used. Assuming the complement mediated lethal effect on ciliated protozoans to be the reverse of the CF ciliary inhibition effect, it is possible that the CF inhibitor is a molecule that can interfere with complement as suggested by Preston and Jahn.

#### B. Nasopharyngeal explants

Since the cilia on epithelial monolayers in vitro do not move in synchrony, the effect of the CF ciliary inhibitor would not be expected to be dyskinesia, but rather a cessation of beat with a possible disruption of underlying cells. Any change of this nature was not evident. There would be every reason to expect an effect on

these cultured human epithelial cells and their cilia. The electrical and physiological basis for ciliary beat is similar for Protozoa and Metazoa (Eckert, 1972), and if one ciliated tissue is affected by the CF factor, then the effect should be apparent in all.

Other laboratories have had difficulty with the assay on both rabbit trachea (Cherry et al., 1971) and oysters (Biddle, 1972). Cilia are extremely sensitive to a variety of environmental conditions such as temperature, moisture, air currents, oxygen tension, and carbon dioxide tension. They are especially dependent on their ionic environment (Rivera, 1962, pp. 50-71). It would appear logical that these secondary conditions could have profound effect on the success of CF factor inhibition, and characterization of these conditions would be of help in devising an ideal test system. Possibly, stressing the cilia by non-optimal environmental conditions is required for identification of CF ciliary inhibition.

#### C. Salmonella flagellar antigen

Failure of CF sera to produce a precipitation arc with Pol antigen can be interpreted in at least two ways. The possibility that Salmonella flagella are not the antigenic equivalent of rabbit trachea or oyster gill cilia must be considered. Bacterial flagella do have characteristics which sharply distinguish them from the cilia and flagella of all other organisms (Sleigh, 1962, pp. 75-76).

However, if Pol antigen were a suitable substitute, then there is the possibility that the CF inhibitor does not behave as a true antigen-antibody interaction. There is evidence for the latter in studies

done by Herzberg (1971) which compared antibodies against oyster gill cilia to the CF inhibitor. The behavior of the two was not analogous. This supports the conclusion drawn from the immunodiffusion study, that the inhibition of ciliary motion is not mediated by typical antibody precipitation.

## II. Differential staining of fibroblasts with basic dyes

### A. Toluidine blue o and metachromasia

1. The dual involvement of the sensitive procedure of tissue culture and metachromatic staining with toluidine blue o to the success of identifying excess mucopolysaccharides in CF cells suggested investigation be directed in both areas in the case of failure. Initially, following the occurrence of erratic, non-specific staining, culture conditions were varied to try and reinstate differentiating results. Unfortunately, none of these environmental changes were successful. The importance of nutritional factors can be demonstrated for metachromasia in mucopolysaccharide storage disorders (Danes and Beam, 1966b), but the exact conditions for demonstration in CF have not been similarly analyzed. For most of this investigation, the medium and other cell environment factors were carefully kept constant and followed those recommended by workers successful with metachromatic technique. That is why other parameters such as the fixation and staining seemed more germane to the problem.

One physiological factor that could be clearly shown to influence the development or degree of cellular metachromasia was the degree of senescence as determined by age of the donor and generations in culture. Cristofalo (1970) has found that older cell strains show a positive

association with increasing RNA levels, and nucleic acid is reportedly metachromatic at pH ranges similar to mucopolysaccharides (Schubert and Hamerman, 1956). It is possible that the metachromasia in older control strains is being caused by pools of RNA, and that depending on conditions, this appears either false (purple) or true (pink). As metachromasia in donors past adolescence, which is presumably a false positive indication, appeared with the first or second subculture on 6 control subjects, this phenomenon could be expected to interfere on older CF subjects whose true metachromasia also appears in the first few weeks after fibroblasts are established (Danes and Bearn, 1969a).

2. Fixation procedures with such things as MeOH, TNE/acetone, freeze substitution, and cetyltrimethylammonium bromide failed to eliminate erratic, non-differentiating results. Alcohol precipitation of mucopolysaccharides and nucleic acids occurs in the presence of traces of salt, and one expects that putting the cells from the isotonic rinse into absolute MeOH would suffice to precipitate both molecular species. Schubert and Hamerman (1956) state that if alcohol precipitates a metachromatic complex, additional washing with alcohol, such as the dehydration step, will not abolish its metachromasia. Both isopropanol and acetone were used in this investigation as dehydrating agents. However, neither increased the specificity of the technique.

Formaldehyde was a particularly poor fixative for this staining technique. Cells treated with formaldehyde showed almost no pink metachromasia, but instead had extensive quantities of false or purple metachromasia in all types of cells. The reason for this may lie in formaldehyde's efficient fixation of protein. Schubert and Hamerman

(1956) believe that proteins can inhibit metachromasia in several ways. The first is as a salt cation and simple competitor with the dye, second by steric masking of the anion, and third by covalent linkage of the anion. The purple metachromasia produced by formaldehyde could have been from RNA that has been fixed in association with protein.

The failure of precipitation of the mucopolysaccharides with cetyltrimethylammonium bromide to selectively stain CF and San Filippo cells for metachromasia may have been due to incomplete dissociation of this complex when introduced into the dye. Wiebkin (personal communication) found it necessary to briefly immerse the precipitated complex in 0.5 M  $MgCl_2$  to facilitate metachromatic staining with cultured epithelial cells.

3. Results of experiments that altered conditions in the stain solution showed that the most noticeable in their effects on uptake of dye by the cells were changes in alcohol concentration and pH. High percentages of alcohol and low pH seemed undesirable since the cells failed to bind toluidine blue o and were almost invisible. However, it is at a low pH of about 2.5 that acid mucopolysaccharides are expected to uniquely bind dye molecules and exhibit metachromasia. The metachromatic material would then appear bright pink against a very pale blue cell, but this phenomenon was not observed at low pH in either CF or San Filippo cells. The metachromasia observed at pH 4.5 in this investigation cannot theoretically be expected to be only acid mucopolysaccharides, but could include other molecules.

Addition of  $Ba^{++}$  to the stain, varying time in the stain, and

varying time of dehydration did not provide a radical change in cell appearance. In a system that was giving differential results, these factors might be expected to enhance the appearance of true metachromasia.

4. Theoretically, sulfation should have enhanced the metachromatic properties of the excess acid mucopolysaccharides found with CF cells. However, results clearly indicate that the concentrated acid bath for 10 min. is too harsh for treating fibroblast monolayers.

5. Altered membrane permeability seems to be related to several findings in CF research, a concept reviewed by Spock (1971). DMSO is an agent known to increase general membrane permeability. If the accumulation of acid mucopolysaccharides in the extracellular matrix of CF cells is related to an altered membrane permeability, then perhaps it is possible that the reduced metachromasia of CF cells in the presence of DMSO is a correction of this faulty permeability.

The particular ion flux that has been implicated in CF membrane dysfunction is  $Ca^{++}$  (Gibson et al., 1970, 1971; Horton et al., 1970; Kopito et al., 1972; Gugler et al., 1967). Horton and his co-workers (1970) have found that CF red cell membranes have reduced  $Ca^{++}$  dependent ATPase activity. It is not known if  $Ca^{++}$  transport in cultured fibroblasts differs from normal, but  $Ca^{++}$  is present in excess in CF exocrine secretions more consistently than any other ion (Gibson et al., 1971). The recent identification of a CF serum factor that has abnormally high binding affinity for  $Ca^{++}$  by Fitzpatrick et al. (1972) lends support to Gibson's notion that  $Ca^{++}$  is a crucial element in CF pathogenesis.

Wiebkin (1971, pp. 245-248) summarized literature pointing to  $Ca^{++}$  as the most important cation in the association of mucopolysaccharides

and their role in cell adhesion. If one presumes that unusual  $\text{Ca}^{++}$  transport in the fibroblast membrane could cause the excessive accumulation of acid mucopolysaccharides as a sort of control mechanism, then one might suppose that the permeability process being affected by DMSO is  $\text{Ca}^{++}$  flux.

While some authors have observed a drop in beta-glucuronidase levels in CF tissue and cultured lymphocytes (Gibbs and Griffin, 1970; Griffin and Gibbs, 1971; Wilson, 1972a), other authors do not find parallel changes in cultured fibroblasts (Kraus et al., 1971; Russell et al., 1971; Benke, 1971). DMSO was originally used in this investigation for effect on lysosomes, however, I believe that the DMSO reduction of metachromasia is not due to the increased availability of mucopolysaccharide to a degradative enzyme found in lysosomes, but rather to a more general change in cell membrane permeability.

6. The effect of hydrocortisone on levels of metachromasia was seen generally as a reduction, and in no case did control cells show appreciable metachromasia in the presence of hydrocortisone. Hydrocortisone may act by altering the presence of molecules other than acid mucopolysaccharides. Since nucleic acids stain metachromatically (Schubert and Hamerman, 1956), and since aging cell strains pool higher amounts of RNA than do young strains (Cristofalo, 1970), they could be responsible for the metachromasia seen in most older strains in the course of this investigation. Nadler (1969b) also noticed increasing metachromasia in aging cell strains.

Hydrocortisone is known to extend the doubling potential of fibroblast strains from a donor of any age (Hayflick, 1970), and the possibility exists that this rejuvenating effect of hydrocortisone is



associated with lesser amounts of RNA accumulation. The importance of age matched controls in experiments with cellular metachromasia will be evident from what has been said.

B. Methylene blue extinction

Methylene blue failed to distinguish CF and San Filippo cells from controls, possibly for the same reasons that toluidine blue o failed in this investigation. If CF cells fail to show intense blue staining at a pH lower than controls, this could be due to poor fixation, unfavorable ionic conditions, or other factors. The utilization of the low isoelectric point of mucopolysaccharides as the basis for a differential staining technique remains an attractive theoretical approach despite the fact that preliminary attempts were unsuccessful.

BIBLIOGRAPHY

- Barka, T. and Anderson, P.J. 1963. *Histochemistry: Theory, Practice, and Bibliography*. Hoeber Medical Division, Harper and Row. New York.
- Bartman, J., Wiesmann, U., and Blanc, W.A. 1970. Ultrastructure of cultivated fibroblasts in cystic fibrosis of the pancreas. *J. Pediat.* 76:430.
- Bearn, A.G. and Danes, B.S. 1970. Metachromasia elaborated. *New Eng. J. Med.* 282:102.
- Benke, P.J. 1971. Beta-glucuronidase and cystic fibrosis. *New Eng. J. Med.* 284:731.
- Benke, P.J., Erbstoeszner, M., and Pitot, H.C. 1972. Transport of labelled compounds in control and cystic fibrosis cells in vitro. *Lancet* i:182.
- Besley, G.T.N., Patrick, A.D., and Norman, A.P. 1969. Inhibition of the motility of gill cilia of *Dreissensia* by plasma of cystic fibrosis patients and their parents. *J. Med. Genet.* 6:278.
- Bhonsdale, N.B. 1970. Cultivation in vitro of ciliated epithelium from human nasopharynx. *Experientia* 8:873.
- Biddle, F.G. 1971. personal communication.
- Bowman, B.H., Lockhart, L.H., and McCombs, M.L. 1969. Oyster ciliary inhibition by cystic fibrosis factor. *Science* 164:325.
- Bowman, B.H., McCombs, M.L., and Lockhart, L.H. 1970a. Cystic fibrosis: Characterization of the inhibitor to ciliary action in oyster gills. *Science* 167:871.
- Bowman, B.H. 1970b. Personal communication to F.G. Biddle.
- Brown, G.A., Oshin, A., Goodchild, M.C., and Anderson, C.M. 1971. Inhibition of sugar transport by plasma from cystic fibrosis patients. *Lancet* ii:639.
- Cantarow, A. and Shepartz, B. 1962. *Biochemistry*. W.B. Saunders Co. Philadelphia.
- Chang, C.Y. and Simon E. 1968. The effect of dimethyl sulfoxide (DMSO) on cellular systems. *Proc. Soc. Exp. Biol. and Med.* 128:60.
- Cherry, J.D., Rodin, V.J., Rejent, A.J., and Dorner, R.W. 1971. The inhibition of ciliary activity in tracheal organ culture by sera from children with cystic fibrosis and controls. *J. Pediat.* 79:937.

- Conen, P.E. 1972. Personal communication.
- Craig, J., Haddad, M., and Shwachman, H. 1957. The pathological changes in the liver in cystic fibrosis of the pancreas. *Am. J. Dis. Child.* 93:357.
- Cristofalo, V.J. 1970. Metabolic aspects of aging in diploid human cells. In Holecckova, E. and Cristofalo, V.J. *Aging in Cell and Tissue Culture.* Plenum Press. New York.
- Danes, B.S. and Bearn, A.G. 1966a. Hurler's syndrome: A genetic study in cell culture. *J. Exp. Med.* 123:1.
- Danes, B.S. and Bearn, A.G. 1966b. Hurler's syndrome: Effects of retinol (vitamin A alcohol) on cellular mucopolysaccharides in cultured human skin fibroblasts. *J. Exp. Med.* 124:1181
- Danes, B.S. and Bearn, A.G. 1968. A genetic cell marker in cystic fibrosis of the pancreas. *Lancet* i:1061.
- Danes, B.S. and Bearn, A.G. 1969a. Cystic fibrosis of the pancreas: A study in cell culture. *J. Exp. Med.* 129:775.
- Danes, B.S. and Bearn, A.G. 1969b. Cystic fibrosis: Distribution of mucopolysaccharides in fibroblast cultures. *Bioch. Biophys. Res. Comm.* 36:919.
- Danes, B.S., Foley, K.M., Dillon, S.D., and Bearn, A.G. 1969c. A genetic study of cystic fibrosis of the pancreas using white blood cell cultures. *Nature* 222:685.
- Danes, B.S. and Flensburg, E.W. 1971. Cystic fibrosis: Cell culture studies on a Danish population. *Am. J. Hum. Genet.* 23:297.
- Danks, D.M., Allan, J. and Anderson, C.M. 1965. Genetic study of fibrocystic disease of pancreas. *Ann. Hum. Genet.* 28:323.
- di Sant' Agnese, P.A. and Talamo, R.C. 1967. Pathogenesis and physiopathology of cystic fibrosis of the pancreas. *New Eng. J. Med.* 277:1287, 1344, 1399.
- Eckert, R. 1972. Bioelectric control of ciliary activity. *Science* 176:473.
- Feigelson, J., Pecau, Y., and Perez, R. 1972. Liver scanning and liver function in cystic fibrosis. *Acta Paed. Scand.* 61:337.
- Fitzpatrick, D.F., Landon, E.J., and James, V. 1972. Serum binding of calcium and the red cell membrane in cystic fibrosis. *Nature* 235:173.

- Gabe, M. 1968. *Techniques Histologiques*. Masson and Cie. Paris.
- Gibbs, G.E. and Griffin G.D. 1970. Beta-glucuronidase activity in skin components of cystic fibrosis. *Science* 167:993.
- Gibson, L.E., Matthews, W.J., and Minihan, P.T. 1970. Hyperpermeable mucus in cystic fibrosis. *Lancet* ii:189.
- Gibson, L.E., Matthews, W.J., Minihan, P.T., and Patti, J.A. 1971. Relating mucus, calcium, and sweat in a new concept of cystic fibrosis. *Pediat.* 48:695.
- Griffin, G.D. and Gibbs, G.E. 1971. Lysosomal enzymes of cultured white blood cells from cystic fibrosis. *Proc. Soc. Exp. Biol. and Med.* 137:438.
- Gugler, E., Pallavicini, J.C., Severdlow, H., and di Sant' Agnese, P.A. 1967. Role of calcium in submaxillary saliva of patients with cystic fibrosis. *J. Pediat.* 71:585.
- Hayflick, L. 1970. Aging under glass. *Exp. Geront.* 5:291.
- Herzberg, V.S. 1971. Action of the Cystic Fibrosis Inhibitor: A Comparison with Antibodies Directed against Oyster Cilia. *Dissertation Abstracts* 32:3794B.
- Horton, C.R., Cole, W.Q., and Bader, H. 1970. Depressed ( $\text{Ca}^{++}$ ) -transport ATPase in cystic fibrosis erythrocytes. *Bioch. and Biophys. Res. Comm.* 40:505.
- Iacocca, V.F., Braddock, L.I., and Barbero, G.J. 1971. Confirmation of the inhibitory effect of cystic fibrosis sera on oyster cilia. *J. Pediat.* 79:508.
- Kaiser, D., Drack, E., and Rossi, E. 1970. Effect of cystic fibrosis sweat on  $\text{Na}^+$  reabsorption by the normal sweat gland. *Lancet* i:1003.
- Kelly, J.W. 1966. Quantitative cytochemistry of acid mucopolysaccharides. In Wied, G.L. *Introduction to Quantitative Cytochemistry*. Academic Press. New York.
- Kopito, L., Elian, E., and Shwachman, H. 1972. Sodium, potassium, calcium, and magnesium in hair from neonates with cystic fibrosis and in amniotic fluid from mothers of such children. *Pediat.* 49:620.
- Kramer, H. and Windrum, G.M. 1955. The metachromatic staining reaction. *J. Histochem. Cytochem.* 3:227.

- Kraus, I., Antonowicz, I., Shah, H., Lazarus, H., and Shwachman, H. 1971. Metachromasia and assay for lysosomal enzymes in skin fibroblasts cultured from patients with cystic fibrosis and controls. *Pediat.* 47:1010.
- Lee, D. 1971. The effect of dimethylsulfoxide on the permeability of the lysosomal membrane. *Bioch. Biophys. Acta* 233:619.
- Mangos, J.A., McSherry, N.R., and Benke, P.J. 1967. A sodium transport inhibitory factor in the saliva of patients with cystic fibrosis of the pancreas. *Pediat. Res.* 1:436.
- Mangos, J.A. and McSherry, N.R. 1968. Studies on the mechanism of inhibition of sodium transport in cystic fibrosis of the pancreas. *Pediat. Res.* 2:378.
- Matalon, R. and Dorfman, A. 1968. Acid mucopolysaccharides in cultured fibroblasts of cystic fibrosis of the pancreas. *Bioch. and Biophys. Res. Comm.* 33:954.
- Matalon, R. and Dorfman, A. 1969. Acid mucopolysaccharides in cultured human fibroblasts. *Lancet* ii:838.
- McManus, J.F.A. and Mowry, R.W. 1960. *Staining Methods: Histologic and Histochemical.* Hoeber Medical Division, Harper and Row. New York.
- Milunsky, A. and Littlefield, J.W. 1969. Diagnostic limitations of metachromasia. *New Eng. J. Med.* 281:1128.
- Misch, D.W. and Misch, M.S. 1969. Reversible activation of lysosomes by dimethyl sulfoxide. *Nature* 221:862.
- Nadler, H.L., Swae, M.A., Wodnicki, J.M., and O'Flynn, M.E. 1969a. Cultivated amniotic fluid cells and fibroblasts derived from families with cystic fibrosis. *Lancet* ii:84.
- Nadler, H.L. 1969b. Metachromatic granules in cultivated fibroblasts derived from patients with genetic disorders. *J. Pediat. Abstracts* 74:823.
- Preston, J.T. and Jahn, T.L. 1972. Cytolytic properties of normal and cystic fibrotic sera on *Tetrahymena pyriformis*. *Cystic Fibrosis Club Abstracts. 13<sup>th</sup> Annual Meeting.*
- Reed, G.B., Bain, A.D., McCrae, W.M., and Scott, F.M. 1970. Cellular metachromasia in cystic fibrosis. *J. Path.* 101:251.
- Reynolds, J.J. 1966. Hydrocortisone and chick bone rudiments. *Exp. Cell Res.* 41:174.

- Rivera, J.A. 1962. Cilia, Ciliated Epithelium, and Ciliary Activity. Pergamon Press, New York.
- Russell, S.B., Russell, J.D., and Littlefield, J.W. 1971. Beta-glucuronidase activity in fibroblasts cultured from persons with and without cystic fibrosis. J. Med. Genet. 8:441.
- Schmoyer, I.R., Fischer, J.F., and Brooks, S.P. 1972. Fractionation of oyster cilia inhibitor from cystic fibrosis heterozygote serum. Bioch. and Biophys. Res. Comm. 46:1923.
- Schubert, M. and Hamerman, D. 1956. Metachromasia: Chemical theory and histochemical use. J. Histochem. Cytochem. 4:159.
- Sleigh, M.A. 1962. The Biology of Cilia and Flagella. Pergamon Press. New York.
- Spicer, S.S. and Henson, J.G. 1967. Methods for localizing mucosubstances in epithelial and connective tissue. In Bajusz, E. and Jasmin, G. Methods and Achievements in Experimental Pathology. Vol. 2. S. Karger. Basel.
- Spock, A., Heick, H.M.C., Cress, H., and Logan, W.S. 1967. Abnormal serum factor in patients with cystic fibrosis of the pancreas. Pediat. Res. 1:173.
- Spock, A. 1971. Theories of the pathogenesis of cystic fibrosis. Postgrad. Med. 50:92.
- Stenchever, M.A., Hopkins, A.L., and Sipes, J. 1967. Dimethyl sulfoxide and related compounds: Some effects on human fibroblasts in vitro. Proc. Soc. Exo. Biol. and Med. 126:270.
- Taysi, K., Kistenmacher, M.L., Punnett, H.H., and Mellman, W.J. 1969. Limitations of metachromasia as a diagnostic aid in pediatrics. New Eng. J. Med. 281:1108.
- Weissmann, G. 1969. The effects of steroids and drugs on lysosomes. In Dingle, J.T. and Fell, H.B. Lysosomes in Biology and Pathology. North Holland. Amsterdam.
- Wichterman, R. 1953. Biology of Paramecium. Blakiston. New York.
- Wiebkin, O. 1971. In Vitro Mucopolysaccharide Metabolism in Epithelial Tissue. Phd. thesis, unpublished, Univ. of Adelaide, Australia.
- Wiesmann, U. and Neufeld, E.F. 1970. Metabolism of sulfated mucopolysaccharides in cultured fibroblasts from cystic fibrosis patients. J. Pediat. 77:685.
- Wilson, R.G. 1972a The activities of some acid hydrolases in the skin of patients with cystic fibrosis of the pancreas. Clin. Chim. Acta 36:113.

Wilson, R.G. 1972b. Glycosaminoglycans in the skin of patients with cystic fibrosis of the pancreas. Clin. Chim. Acta 36:189.

Wright, S.W. and Morton, N.E. 1968. Genetic studies on cystic fibrosis in Hawaii. Am. J. Hum. Genet. 20:157.