

17628

NATIONAL LIBRARY
OTTAWA



BIBLIOTHÈQUE NATIONALE
OTTAWA

NAME OF AUTHOR: DAVID T. MORRIS

TITLE OF THESIS: THE TOTAL REPLACEMENT

ARTIFICIAL HEART: A STUDY
OF LIMITING FACTORS

UNIVERSITY: ALBERTA

DEGREE FOR WHICH THESIS WAS PRESENTED: PH.D.

YEAR THIS DEGREE GRANTED: 1973

Permission is hereby granted to THE NATIONAL LIBRARY
OF CANADA to microfilm this thesis and to lend or sell copies
of the film:

The author reserves other publication rights, and
neither the thesis nor extensive extracts from it may be
printed or otherwise reproduced without the author's
written permission.

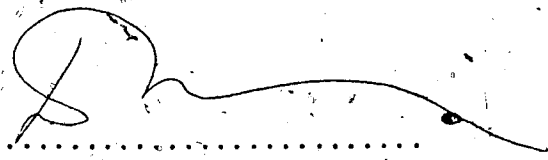
(Signed) 

PERMANENT ADDRESS:

H 1004, 87th St - 106 St
EDMONTON, ALTA.
CANADA

DATED 13 JUNE 1973

THE UNIVERSITY OF ALBERTA

THE TOTAL REPLACEMENT ARTIFICIAL HEART:

A STUDY OF LIMITING FACTORS

By



DAVID THOMAS MORRIS

A THESIS

SUBMITTED TO THE FACULTY OF GRADUATE STUDIES AND RESEARCH

IN PARTIAL FULFILLMENT OF THE REQUIREMENTS

FOR THE DEGREE OF DOCTOR OF PHILOSOPHY

IN EXPERIMENTAL SURGERY

DEPARTMENT OF SURGERY

EDMONTON, ALBERTA

FALL, 1973

THE UNIVERSITY OF ALBERTA
FACULTY OF GRADUATE STUDIES AND RESEARCH

The undersigned certify that they have read, and recommend to the Faculty of Graduate Studies and Research for acceptance, a thesis entitled "The Total Replacement Artificial Heart: A Study of Limiting Factors" submitted by David Thomas Morris in partial fulfillment of the requirements for the degree of Doctor of Philosophy in Experimental Surgery.

[Signature]
.....

SUPERVISOR

..... *Fred N. Huffman*
External Examiner

[Signature]
.....

[Signature]
.....

[Signature]
.....

[Signature]
.....

Date *in* 1973

Abstract

Total heart replacement may be the only cure for persons suffering from irreversible myocardial damage. One type of heart replacement with a possible future would be an orthotopic cardiac prosthesis or artificial heart. Artificial heart research has been active for fifteen years and experimental implantations have kept animals alive for up to eleven days.

When this artificial heart program began three years ago the problems accompanying total artificial heart replacement were not well defined. We believed that a systematic study of the limiting factors of total artificial heart replacement would contribute to artificial heart development.

There were three phases in the project. The first phase included the preliminary design, fabrication and in vitro testing of a suitable artificial heart, driving system and testing apparatus. An air-powered sac-type device was developed with acceptable in vitro performance. The second phase saw the development of the basic design with experimental implantations. Twelve different models, including both sac-type and diaphragm-type hearts were developed and nine models were tested in the chests of 43 dogs, pigs and calves. An implantation procedure was developed and survival times in calves reached a maximum of 33 hours. Some of the animals made excellent post-operative recoveries with normal behavior. The third phase was an in depth study of the results from the last 22 implantations. From the causes of death and pathological review

of the 22 implantations five limiting factors were established.

The limiting factors are:

low cardiac output

thrombosis

pulmonary complications

blood damage

and surgical procedure and experimental animals.

We feel that these limitations are not unique to our own experiences, but common to other artificial heart developments throughout the world.

ACKNOWLEDGEMENTS

A project of this dimension requires the coordinated efforts of many individuals and generous financial assistance.

I would like to thank the following persons for their individual contributions to our artificial heart program and in particular to the preparation of this thesis.

Dr. Cecil M. Couves, for his shared knowledge, his guidance and his persistent enthusiasm and encouragement.

Dr. Tadashi Nishizawa, for his excellent surgery, medical interpretations and constructive ideas offered with unusual zeal.

Mr. Alan Wells, for his efficient preparation and maintenance of the laboratory and his cheerful paramedical assistance during lengthy experiments.

Drs. Byung Chung, Bill Griswold, S.S. (Nick) Nakai; Messrs. Tom Jones, Paul Kolodej, Riivo Ilves, Don Quinn, Trevor Theman and Paul Thiessen for their helpful surgical and medical assistance.

Messrs. Bob Orchard, Jim Soldan and Malcolm Wharton for their willing technical help and Mrs. Mildred Demers and Diane Gunderman for light-hearted and efficient secretarial help.

The financial contributions from the following individuals and institutions have been greatly appreciated.

Project Grants from:

The Medical Research Council, MA2553, 1970, 1971.

The Alberta Heart Foundation, #72-97, 1972.

Personal Grants from:

The Province of Alberta Graduate Fellowship, 1970.

The Edmonton Civic Employees Chest Trust, 1971, 1972.

Academic Travel Grants from:

The Department of Surgery Excess Earnings Fund, 1969-1972.

Investigations were carried out in the Department of Surgery and at the Surgical-Medical Research Institute, University of Alberta.

TABLE OF CONTENTS

Page :

CHAPTER I	INTRODUCTION, HISTORICAL REVIEW AND JUSTIFICATION FOR ARTIFICIAL HEART RESEARCH	7
	1.1 Introduction	1
	1.2 The Artificial Heart: Historical Events. .	3
	1.3 Justification for Artificial Heart Research	18
	1.4 Division of Phases	24
CHAPTER II	PHASE I - PRELIMINARY DESIGN TOTAL ARTIFICIAL HEART, TIMING AND DRIVING DEVICE, AND TESTING EQUIPMENT . .	25
	2.1 Preliminary Heart Design	25
	2.2 The Timing and Driving Unit	35
	2.3 The Mock Circulations	38
	2.4 In Vitro Performance Characteristics of the Pump	40
	2.5 Summary	43
CHAPTER III	PHASE II- DEVELOPMENT OF THE PRELIMINARY DESIGN ARTI- FICIAL HEART FOR IMPLANTATION IN EXPERIMENTAL ANIMALS	44
	3.1 Model Mk II	44
	3.2 Model Mk III	47
	3.3 Model Mk IV	50
	3.4 Model Mk V	53
	3.5 Model Mk VI	55
	3.6 Model Mk VII	64
	3.7 Model Mk VIII	66
	3.8 Model Mk IX	69
	3.9 Model Mk X	71

TABLE OF CONTENTS (continued)		Page
3.10	Model Mk XI	72
3.11	Model Mk XII	73
3.12	Artificial heart valves	76
CHAPTER IV	PHASE III-LIMITING FACTORS	78
4.1	Introduction	78
4.2	Methods	78
4.3	Results and Postoperative Events.	90
4.4	Pathological Findings	104
4.5	Causes of Death	118
4.6	Limiting Factors	122
	1. Low Cardiac Output	122
	2. Thrombosis	127
	3. Pulmonary Complications	134
	4. Hematological Changes	140
	5. Experimental Animals and Surgical Procedures	149
CHAPTER V	CONCLUSIONS AND SUGGESTIONS FOR FURTHER WORK	154
REFERENCES	156
APPENDIX A	IN VITRO HEMOLYSIS TESTS	165
APPENDIX B	THE DEVELOPMENT OF A PREBIOLIZED NATURAL RUBBER	169
APPENDIX C	HYPOTHERMIA	172
APPENDIX D	DETAILED SUMMARY OF 3 LONG SURVIVORS	177
CURRICULUM VITAE	209

LIST OF TABLES

		Page
TABLE I	Summary of 22 total heart replacements.	94
TABLE II	Summary of 4 control bypasses	102
TABLE III	Chronological record of events - Experiment #7	179
TABLE IV	Perfusion record - Experiment #7	181
TABLE V	Liquid balance record - Experiment #7	182
TABLE VI	Blood pressures and flow rates - Experiment #7	184
TABLE VII	Blood examination - Experiment #7	185
TABLE VIII	Plasma examination - Experiment #7	186
TABLE IX	Chronological record of events - Experiment #23	191
TABLE X	Perfusion record - Experiment #23	193
TABLE XI	Blood pressures and heart rates - Experiment #23	194
TABLE XII	Liquid balance record - Experiment #23	195
TABLE XIII	Whole blood clotting times - Experiment #23	196
TABLE XIV	Blood examination - Experiment #23	197
TABLE XV	Plasma examination - Experiment #23	198
TABLE XVI	Chronological record of events - Experiment C-7	203
TABLE XVII	Perfusion record - Experiment C-7	204
TABLE XVIII	Liquid balance record - Experiment C-7	205
TABLE XIX	Whole blood clotting times - Experiment C-7	205
TABLE XX	Blood examination - Experiment C-7	206
TABLE XXI	Plasma examination - Experiment C-7	206

LIST OF FIGURES AND SOURCES

Page

Fig. 1.1	Electromagnetic artificial heart. Solenoids pull diaphragms inward and pressure transferred by hydraulic fluid forces sacs to contract. From 'An Artificial Heart Inside the Body' by Willem J. Kolff, Copyright (c) 1965 by Scientific American, Inc. All rights reserved	4
Fig. 1.2	Pendulum artificial heart. Swinging pendulum collapses left and right ventricle sacs. From 'An Artificial Heart Inside the Body' by Willem J. Kolff, Copyright (c) 1965 by Scientific American, Inc. All rights reserved	5
Fig. 1.3	Roller artificial heart has no inlet valves and uses a peristaltic action to pump blood. Reprinted from Trans Am Soc Artif Intern Organs 6: 302, 1960 with permission of the editor, Dr. George Schreiner, Georgetown University, Washington, D.C.	6
Fig. 1.4	Sac-type artificial heart fills passively during diastole. Systole occurs when compressed air is injected between the flexible sac and the semi-rigid housing. From 'An Artificial Heart Inside the Body' by Willem J. Kolff, Copyright (c) 1965 by Scientific American, Inc. All rights reserved	7
Fig. 1.5	Sac-type artificial heart used in dogs for up to 27 hours. From 'An Artificial Heart Inside the Body' by Willem J. Kolff, Copyright (c) 1965 by Scientific American, Inc. All rights reserved	8
Fig. 1.6	Double bypass pumps used to assist both ventricles by pumping in parallel. Reprinted from the Trans Am Soc Artif Intern Organs 10: 155, 1960 with permission of the editor, Dr. George Schreiner, Georgetown University, Washington, D.C.	9
Fig. 1.7	Air-driven intraventricular pumping sleeves did not require removal of the natural heart. Reprinted from the Trans Am Soc Artif Intern Organs 11: 264, 1965 with permission of the editor, Dr. George Schreiner, Georgetown University, Washington, D.C.	9

LIST OF FIGURES AND SOURCES (continued)

Page

Fig. 1.8	Rolling diaphragm artificial heart is powered by compressed air and the ventricles fill by venous pressure. Reprinted from the Trans Am Soc Artif Intern Organs 7: 384, 1961 with permission of the editor, Dr. George Schreiner, Georgetown University, Washington, D.C.	10
Fig. 1.9	One sac-type heart used a fluid amplifier control mechanism. Reprinted from the Trans Am Soc Artif Intern Organs 8: 34, 1962 with permission of the editor, Dr. George Schreiner, Georgetown University, Washington, D.C.	11
Fig. 1.10	Electrohydraulic artificial heart. Both the ventricular and hydraulic units were implanted in the animal's chest and abdomen. Reprinted from the Trans Am Soc Artif Intern Organs 12: 273, 1966 with permission of the editor, Dr. George Schreiner, Georgetown University, Washington, D.C.	12
Fig. 1.11	Air-driven diaphragm-type bypass device. Reprinted from the Trans Am Soc Artif Intern Organs 12: 132, 1966 with permission of the editor, Dr. George Schreiner, Georgetown University, Washington, D.C.	13
Fig. 1.12	Velour lined bypass device designed for semi-implantation. Reprinted from the Am J Surg 114: 27, 1967	14
Fig. 1.13	Diaphragm-type orthotopic cardiac prosthesis used in the only total artificial heart replacement in a human being. Reprinted from the Trans Am Soc Artif Intern Organs 15: 256, 1969 with permission of the editor, Dr. George Schreiner, Georgetown University, Washington, D.C.	14
Fig. 1.14	Air-powered biventricular sac-type artificial heart made of Silastic. Calves were kept alive for 247 hours with the device. Supplied by Dr. T. Akutsu, Jackson, Mississippi	15

LIST OF FIGURES AND SOURCES (continued)

Page

Fig. 1.15	Diaphragm-type design made of Silastic and acrylics. The inside is lined with dacron velour. The heart has pumped for 124 hours in calves. Reprinted from the Trans Am Soc Artif Intern Organs 18: 170, 1972 with permission of the editor, Dr. George Schreiner, Georgetown University, Washington, D.C.	16
Fig. 1.16	World record survivals of up to 264 hours in calves have been reported with this air-powered silicone rubber artificial heart with hemispherical ventricles. Reprinted from the Trans Am Soc Artif Intern Organs 17: 479, 1971 with permission of the editor, Dr. George Schreiner, Georgetown University, Washington, D.C.	17
Fig. 1.17	Heart disease is the major cause of death among the Canadian population. Reprinted from the Canada Yearbook 262, 1972.	18
Fig. 2.1	Schematic of artificial heart design criteria	26
Fig. 2.2	Starling's regulation ensures a balance of output between the left and right ventricles	27
Fig. 2.3	The increase in cardiac output during exercise is mostly due to an increase in venous return	28
Fig. 2.4	Schematic of the first sac-type artificial heart	30
Fig. 2.5	First model artificial heart fabricated of natural rubber and polyurethane.	30
Fig. 2.6	Pump fabrication sequence with wax and rubber molds, rubber sacs, and finished ventricles	34
Fig. 2.7	The timing and driving unit	35
Fig. 2.8	Schematic of timing and driving system	36
Fig. 2.9	Electronic circuit for timing unit	37
Fig. 2.10	A mock circulation unit with the left ventricle pumping	38
Fig. 2.11	The test bed for in vitro performance tests with left and right mock circulations connected in series	39

LIST OF FIGURES AND SOURCES (continued)

	Page
Fig. 2.12 Function curve from a left ventricle showing obeysance of Starling's Law	40
Fig. 2.13 The sensitivity of the function curve changes when the rate is changed. The optimum rate is 80 beats per minute with a diastolic:systolic ratio of about 2:1	41
Fig. 2.14 Pressure recordings from the chambers of an artificial heart on the mock circulation	42
Fig. 3.1 First implantation model	45
Fig. 3.2 Poor fit in the chest of a 30 kg. dog due to orientation of arterial connectors and stiff atrial cuff	46
Fig. 3.3 Mk III model has longer arteries and a more flexible atrial cuff	47
Fig. 3.4 Mk III model in the chest of a 30 kg. dog. Fit was acceptable, but since the animal was too small for the device, the diaphragm had to be split. Dogs had poor recovery and lived up to 6 hours	48
Fig. 3.5 Blood pressure recordings from a 30 kg. dog after 4 hours of pumping with a Mk III device	49
Fig. 3.6 Mk IV model showing teflon ring for left atrial anastomosis and teflon valve holder in the bicuspid position. Survival times were increased to 9 hours	51
Fig. 3.7 Moving the pressure vents to the tops of the vessels permitted more complete exhaustion of air when priming. New position of the air driving tubes no longer required splitting of the diaphragm	51
Fig. 3.8 With the Mk V model each atrial remnant was sutured to a dacron graft and velour cuff	53
Fig. 3.9 One calf lived for 8 hours with a Mk V device until a ventricle cracked. Recovery was good with spontaneous breathing and numerous attempts to stand up	54
Fig. 3.10 Mk VI model with more spherical ventricles and brass connectors for air driving tubes which would pass through one side of the heart	56

LIST OF FIGURES AND SOURCES (continued)

	Page.
Fig. 3.11 Schematic of the Mk VI model	57
Fig. 3.12 Teflon valve holders used to connect atrial cuffs to the ventricles	57
Fig. 3.13 Function curve for the Mk VI artificial heart	58
Fig. 3.14 The artificial heart fits well in the chest of an 80 kg. calf	59
Fig. 3.15 Cage designed to support calf and control mechanism	60
Fig. 3.16 Head restraint bars permit calf to stand up without interference. Calves with Mk VI devices lived for up to 33 hours	60
Fig. 3.17 The timing device was modified to utilize slight suction to the ventricles during diastole	61
Fig. 3.18 8-10 mm. Hg. of suction during diastole reduces atrial pressure by 4 mm. Hg, increases arterial pressure by 15 mm. Hg and increases pump output by improving ventricular filling	61
Fig. 3.19 Blood pressures from an 80 kg. calf showing progressive shock after 26 hours pumping with a Mk VI total replacement artificial heart	62
Fig. 3.20 Mk VII design was fabricated entirely from natural rubber but could not generate sufficient left ventricular pressure	65
Fig. 3.21 Mk VIII air-powered diaphragm-type artificial heart	66
Fig. 3.22 Components of the Mk VIII design	67
Fig. 3.23 Diaphragms were made by vulcanizing uncured Silastic on an aluminum mold	67
Fig. 3.24 Function curve for the Mk VIII and Mk IX diaphragm hearts	68
Fig. 3.25 Schematic of Mk IX artificial heart	69
Fig. 3.26 Mk IX heart with dacron arterial and atrial grafts. One air driving tube passes through each side of the chest. This design was too wide to fit in the chest without causing venous compression	70

LIST OF FIGURES AND SOURCES (continued)

	Page
Fig. 3.27 Removable atrial cuffs permitted a more leakproof atrial anastomosis. Flaps were added to facilitate pulling the cuff upwards when connecting the ventricle to the atrium. Tubes are for pressure monitoring and priming	71
Fig. 3.28 Unsuccessful Mk X model designed to reduce the width of both ventricles. Toroidal valves were used	72
Fig. 3.29 Mk XI design had very low pump output	73
Fig. 3.30 Left ventricle of the Mk XII device showing removable atrial sewing cuff	74
Fig. 3.31 The Mk XII model is much lighter and smaller than the previous model Mk IX	74
Fig. 3.32 Function curve for the Mk XII model with higher frequency	75
Fig. 3.33 Calves with Mk XII artificial hearts experienced excellent recovery and survived for up to 33 hours	76
Fig. 3.34 Kay-Shiley, Toroidal and Bjork-Shiley prosthetic heart valves used in the artificial hearts	77
Fig. 4.1 Calves are anesthetized with halothane and oxygen	79
Fig. 4.2 Cardiopulmonary bypass circuit	80
Fig. 4.3 Ventricles are excised and trimmed at the atrio-ventricular groove	81
Fig. 4.4 Posterior remnants of the atria, aorta, and pulmonary artery following resection of the natural heart	82
Fig. 4.5 Prior to insertion the atrial and arterial grafts are pre-clotted with fresh unheparinized blood	83
Fig. 4.6 The atrial cuffs are sutured in place in an inverted position and then turned out ready for connection to the ventricles	84
Fig. 4.7 The left ventricle is lowered into the atrial cuff.	85

LIST OF FIGURES AND SOURCES (continued)

	Page
Fig. 4.8 The atrial cuff is wired in place over its ventricle	85
Fig. 4.9 Both atria are anastomosed before making arterial connections	86
Fig. 4.10 Umbilical tapes are used to tie the natural vessels over the arterial connectors	86
Fig. 4.11 Artificial heart connections complete and pumping begins	87
Fig. 4.12 Implantation of a Mk XII device with no pressure monitoring lines	88
Fig. 4.13 Calf in mobile cage is able to move up and down restrained only by head bars	89
Fig. 4.14 Parenchymal hemorrhage in white matter of the brain from a long survivor. H & E, 100x	105
Fig. 4.15 General edema and focal demyelination in the gray matter of a brain from a long survivor. H & E, 75x	105
Fig. 4.16 Platelet thromboembolus in the brain of a long survivor. H & E, 100x	106
Fig. 4.17 Typical lung from a 33 hour survivor with a sac-type artificial heart showing severe congestion and hemorrhage	107
Fig. 4.18 Lung from a 33 hour survivor with a Mk XII diaphragm-type artificial heart showing less severe congestion	107
Fig. 4.19 Typical lung showing congestion, intra-alveolar hemorrhage, bronchiolar hemorrhage, and sludging in the pulmonary vessels. H & E, 50x	108
Fig. 4.20 Perivascular hemorrhage and alveolar edema seen in a lung from a calf with a Mk IX heart. H & E, 50x	108
Fig. 4.21 Fresh thromboemboli in a lung. H & E, 50x	109
Fig. 4.22 Thromboembolus in a pulmonary artery believed to have formed in the right ventricle	109
Fig. 4.23 Livers from long survivors showed vacuolar degeneration around central veins. H & E, 100x	110

LIST OF FIGURES AND SOURCES (continued)		Page
Fig. 4.24	Some long survivors showed livers with centrilobular necrosis. H & E 100x	111
Fig. 4.25	Acute liver congestion seen in calves suffering from very low cardiac output. H & E, 75x	111
Fig. 4.26	Severely infarcted kidney from a 33 hour survivor with a sac-type heart	112
Fig. 4.27	Kidney from a 33 hour survivor with a Mk XII diaphragm-type heart appeared normal	113
Fig. 4.28	Typical bloodless glomeruli seen in most animals with artificial hearts. H & E, 100x	113
Fig. 4.29	Some atrophic glomeruli showed pyknosis. H & E, 100x	114
Fig. 4.30	Lower nephron nephrosis with degeneration of tubular cells typifies the "shock kidneys" seen in all longer survivors with sac-type hearts. H & E, 100x	114
Fig. 4.31	Congested, hemorrhagic lungs from a control calf living for 24 hours. Lower parts of lower lobes were always more severely affected	116
Fig. 4.32	Focal infarctions in a 24 hour control kidney likely caused by thromboemboli from flushed pressure catheters	117
Fig. 4.33	Causes of death for calves with artificial hearts	118
Fig. 4.34	Survival times and causes of death for calves with total artificial hearts	118
Fig. 4.35	Output pressure waveform from a sac-type artificial heart	125
Fig. 4.36	The Mk IX diaphragm heart produced output pressure waveforms with a very high systolic $\frac{dp}{dt}$	125
Fig. 4.37	The Mk XII heart produced a much reduced $\frac{dp}{dt}$ and a more physiological waveform	126
Fig. 4.38	Output pressure waveform of the natural calf heart	127
Fig. 4.39	Sac-type artificial hearts formed large thrombi in the apexes where flow was reduced	129

LIST OF FIGURES AND SOURCES (continued)		Page
Fig. 4.40	Mk IX diaphragm hearts formed clots around valves and at the peripheral junction between diaphragm and housing	130
Fig. 4.41	Mk XII diaphragm heart also formed thrombi around valves, connectors and diaphragms	131
Fig. 4.42	The cut surface of a lung following acute massive pulmonary edema	135
Fig. 4.43	A possible pathway leading to progressive cardiovascular shock	137
Fig. 4.44	Plasma hemoglobin levels in 22 calves with total replacement artificial hearts and in 4 bypass control calves	141
Fig. 4.45	Plasma hemoglobin levels in 3, 33 hour survivors	144
Fig. 4.46	Platelet counts in 22 calves with total replacement artificial hearts and in 4 bypass control calves	145
Fig. A.1	In vitro hemolysis testing apparatus.	165
Fig. A.2	Increased driving pressure and increased rate increase hemolysis.	167
Fig. B.1	The clotting time of fresh canine blood was measured in samples of pre-biolized natural rubber.	169
Fig. B.2	The clotting time of natural rubber was increased tenfold by prebiolizing.	170
Fig. B.3	Prebiolized natural rubber grafts were tested in vivo.	171
Fig. C.1	Calves were anesthetized and cooled to 20° C in an ice water bath	173
Fig. C.2	Typical body temperature course during heart transplantation with deep hypothermia	174
Fig. C.3	Hemolysis showed no reduction with hypothermia.	175
Fig. C.4	Platelet loss was excessive with hypothermia.	175

CHAPTER I

INTRODUCTION, HISTORICAL REVIEW AND JUSTIFICATION FOR ARTIFICIAL HEART RESEARCH

1.1 Introduction

It is becoming increasingly apparent that the availability of artificial heart devices would offer a mode of therapy for a sizeable percentage of patients dying from heart disease. According to the latest statistics, [1]* ischemic heart disease alone accounted for 48,394 of the 76,664 cardiovascular deaths that occurred in Canada in 1969. Mortality statistics provide only a partial picture of the impact that heart disease has on individuals, families and society as a whole. Morbidity statistics would also have to be considered in assessing the magnitude of the cardiovascular disease problem. Since heart disease is generally progressive, the more patients that are kept alive through the use of drugs, corrective surgery, or heart assist devices, the more that will eventually require total heart replacement.

Over the last 30 years it has been clearly demonstrated that mechanical blood pumps and oxygenators can assume the functions of the heart and lungs for considerable periods of time. The problems confronting the development of a totally implantable artificial heart are far greater than merely miniaturizing these blood pumps and lengthening the feasible pumping time. Some of the

*numbers in brackets indicate references listed on pages 156 to 164.

technical and non-technical problems of development and application of an artificial heart include:

- blood pumps and controls
- blood/materials interface
- energy systems
- physiological effects
- instrumentation
- blood oxygenators
- endogenous heat
- percutaneous leads
- blood flow
- reliability and maintainability
- safety
- patient diagnosis (patient suitability)
- anatomy (space, support, weight)
- facilities, personnel, equipment
- moral and ethical considerations
- legal considerations
- social and psychological factors
- and economics.

The list of problems is by no means short and they will not all be solved by one person or group.

This project has confined itself to the identification of some of the physiological effects and limitations of artificial heart materials, heart design and experimental methods through a series of total heart replacements in experimental animals.

1.2 The Artificial Heart: Historical Events

The first investigator to attempt to implant a mechanical heart inside the body was a Soviet named Demikhov.^[2] In his book^[3] Demikhov described his early experiments:

"In view of the fact that the heart in natural conditions is a living pump we had the idea of trying to replace the heart by a mechanical pump. For this purpose, in 1937, we devised and constructed a compact apparatus, the size of the natural heart, consisting of two adjacent membrane pumps which performed the functions of the ventricles of the heart. The apparatus was placed inside the dog's chest at the site from which the dog's own heart had been removed; the shaft of the apparatus was brought out through the chest wall for attachment to the operating electric motor. After the shaft had been brought out, the chest wall was sutured hermetically...We carried out three experiments at that time, and five more in 1958. When an artificial circulation was maintained for 5 1/2 hours in a dog (without its own heart), all signs of life were observed."

As far as is known, Demikhov has not pursued the work further.

In the United States the first proposal for an artificial blood pump for permanent implantation was introduced by Salisbury in 1957.^[4] In his Presidential Address to the American Society for Artificial Internal Organs he described hydraulically driven, u-shaped, compressible, Silastic ventricles and possible methods to power them. In 1958 Kusserow described the first intra-abdominal pump to supply partial function for the right side of the heart.^[5] Also in 1958, Akutsu and Kolff reported an experiment performed at the Cleveland Clinic which was the first total replacement of a dog's natural heart.^[6] The polyvinyl chloride heart was activated with

air carried by a plastic tube through the chest wall to a reciprocating pump.^[7] With the mechanical pump driving the blood through the dog's circulation, the animal lived for 90 minutes. This was the first of many experiments to be conducted under the direction of Kolff.

Since then, similar investigations have begun not only at other American centers, but also in Argentina,^[8] Canada,^[9] Germany^[10] Great Britain,^[11] Japan,^[12] and the U.S.S.R.^[13]

With the exception of Kolff's first heart, all the early designs from the Cleveland Clinic were electrically driven to avoid the complication of large air tubes crossing the chest wall. These included an electro-magnetic pump designed by Norton^[14] (Fig. 1.1) and a pendulum type designed by Kolff and Globe Industries.^[15,16] (Fig. 1.2)

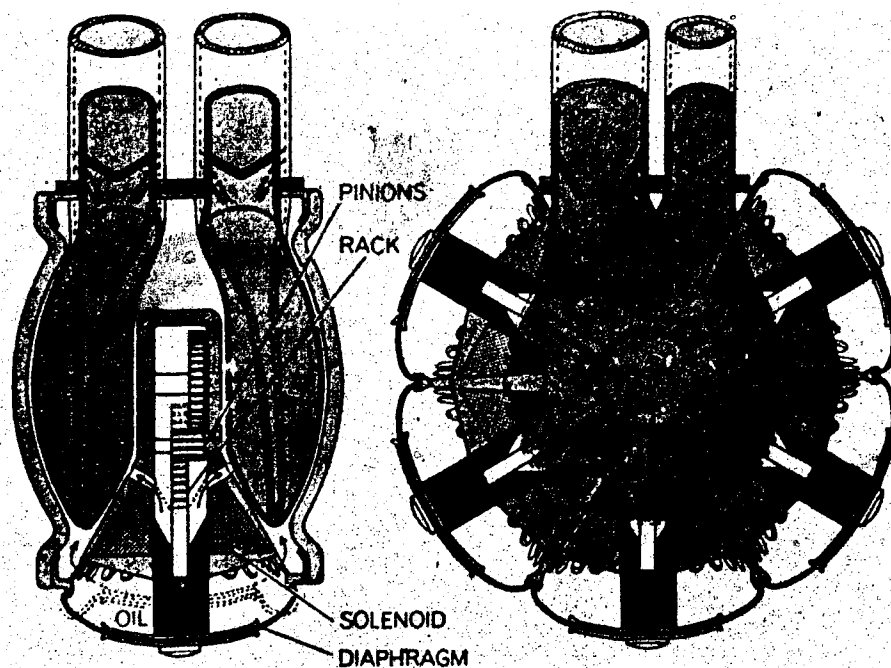

Fig. 1.1 Electromagnetic artificial heart. Solenoids pull diaphragms inward and pressure transferred by hydraulic fluid forces ventricle sacs to contract.

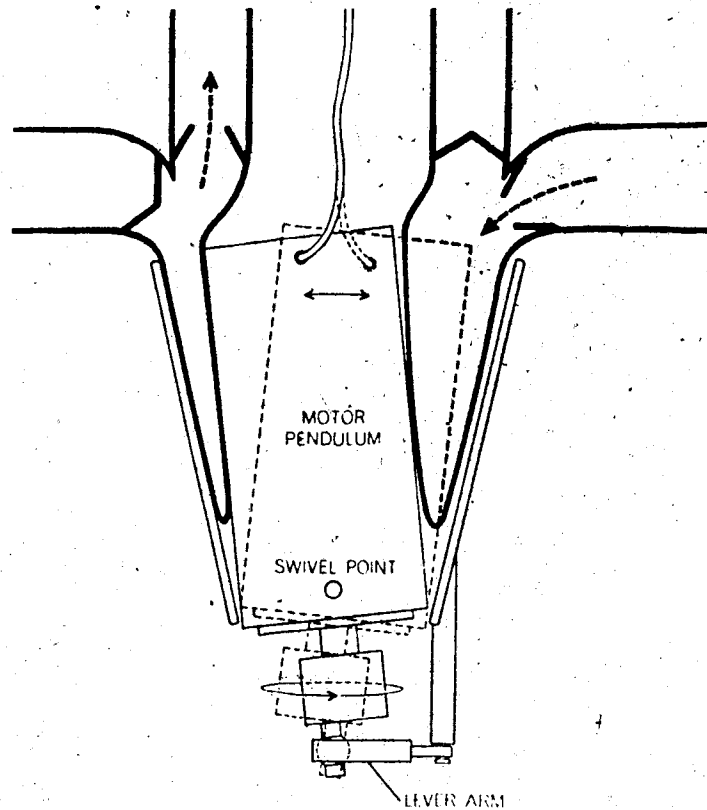

Fig. 1.2 Pendulum artificial heart. Swinging pendulum collapses left and right ventricle sacs.

Both employed ventricle sacs housing the blood which were periodically collapsed by a rosette of solenoids in the electromagnetic type and by a swinging motor-driven pendulum in Kolff's design. Kolff also tried a roller-type pump^[15] employing a peristaltic action, (Fig. 1.3) but it too suffered from the same inadequacies as other electrically driven hearts. They were all disappointingly heavy, weak, inefficient and generated too much heat.

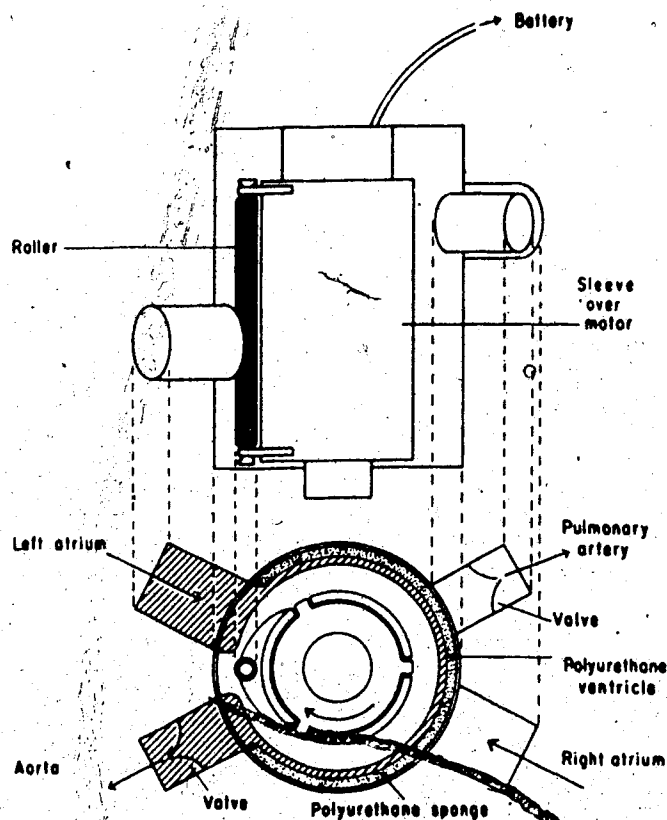

Fig. 1.3. Roller artificial heart has no inlet valves and uses a peristaltic action to pump blood.

By 1959 other researchers were beginning to have some favourable results. Liotta of Cordoba, Argentina, had already developed pumps employing membranes, bellows and rollers, leading to survival times in dogs of 13 hours. [8]

Having temporarily abandoned air-driven hearts because of the necessity for large tubes being put through the chest wall, Kolff and Akutsu returned to compressed air at the encouragement of N.A.S.A. engineers who showed that a tube of only 1/8 inch inside diameter would suffice to transmit the air power. [7] Using extra-corporeal power sources eliminated the then enormous complications

of excessive heat production and insufficient power of the electrically driven devices. The compressed air drive introduced a new principle from which to work: that of the collapsible sac ventricle.^[17] The principle employs resilient rubber or plastic sacs encased in a rigid or semi-rigid housing. (Fig. 1.4)

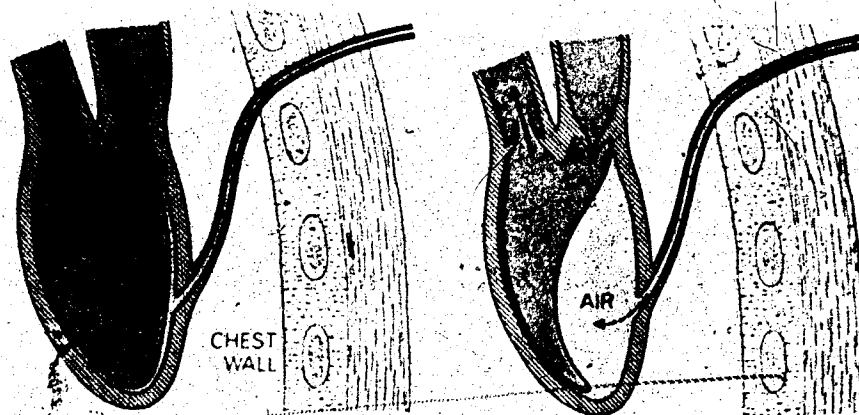

Fig. 1.4 Sac-type artificial heart fills passively during diastole. Systole occurs when compressed air is injected between the flexible sac and the semi-rigid housing.

When air is injected between the sac and the housing the contents of the sac are expelled; the flow being controlled by two one-way check valves. Akutsu and Kolff pioneered this principle and by 1964 were achieving survival times of up to 27 hours in dogs, which ate, drank, and behaved normally in other respects.^[18,19,20,21,22]

(Fig. 1.5)



Fig. 1.5 Sac-type artificial heart used in dogs for up to 27 hours.

These longer survival times were introducing new problems; the animals failed to survive not due to a malfunction of the pumping mechanism, but due to the formation of blood clots which broke loose to form emboli lodging in different parts of the body, blocking the circulation.^[23] This problem focused attention on flow patterns around valves and within the ventricles, and on the development of materials that were less thrombogenic.

About this same time DeBakey and Hall at the Baylor University College of Medicine were developing extra-ventricular (Fig. 1.6) and intra-ventricular (Fig. 1.7) assistors of the air-driven sac-type.^[24,25]

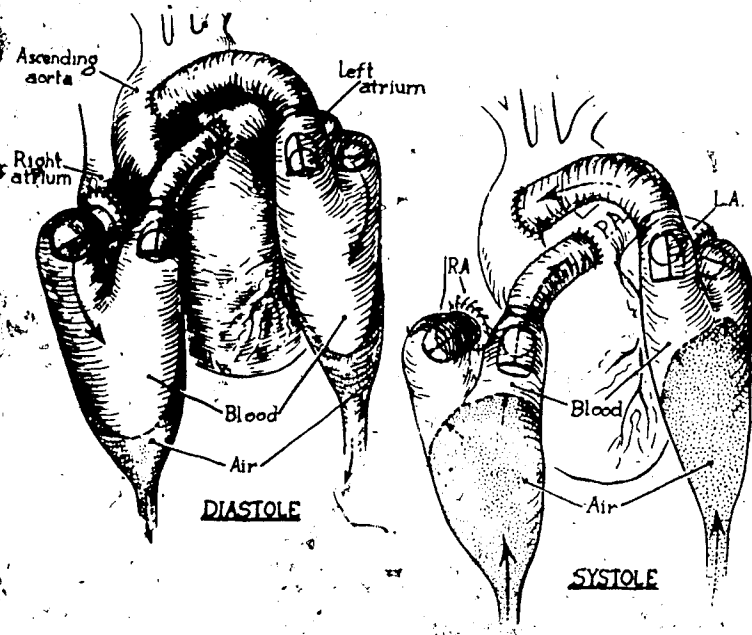

Fig. 1.6 Double bypass pumps used to assist both ventricles by pumping in parallel.



Fig. 1.7 Air-driven intraventricular pumping sleeves did not require removal of the natural heart.

The first of several implantations of an artificial ventricular assist device in a human being took place in July, 1963 under the direction of DeBakey. [26, 27] This type of artificial heart research favouring heart assist and not total replacement continued concurrently.

The early 1960's also saw many other short lived designs. Saxton designed a centrifugal pump which caused severe erythrocyte damage. [28] Hastings developed a hydraulically driven diaphragm pump achieving survivals of 34 hours in dogs. [29] An air driven rolling diaphragm pump designed by Seidel kept dogs alive for up to 20 hours. [17] (Fig. 1.8)

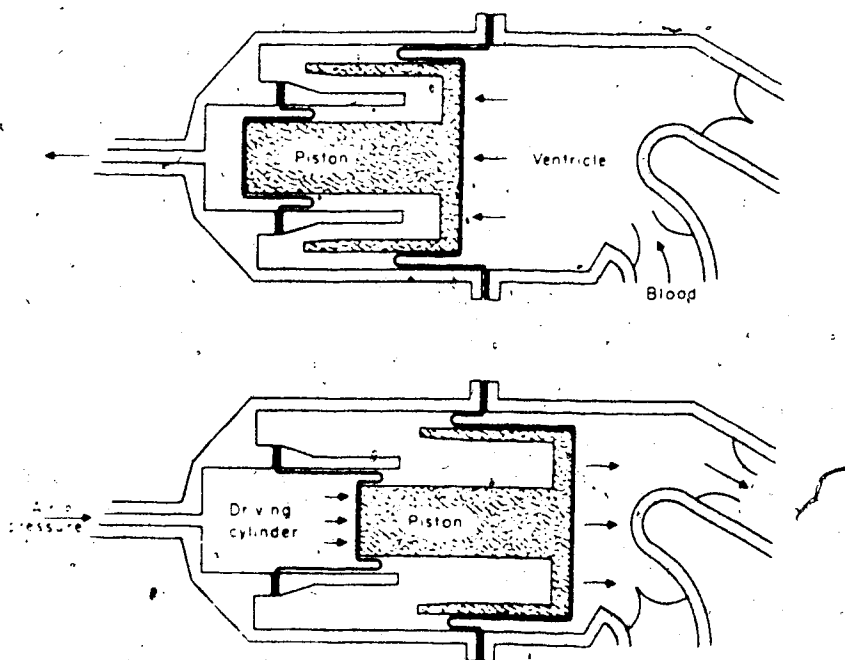

Fig. 1.8 Rolling diaphragm artificial heart is powered by compressed air and the ventricles fill by venous pressure.

In Japan, Atsumi [12, 30] experimented with water-driven bellows-type and motor-driven roller pumps with poor results. An interesting application of bimorphs was introduced by Loehr [31] in his piezoelectric artificial heart but it suffered from inadequate output. Woodward of the United States Army's Harry Diamond Labs developed a pump based on the fluid amplification technique [32,33] (Fig. 1.9) resulting in survival times in animals up to 24 hours. [34]

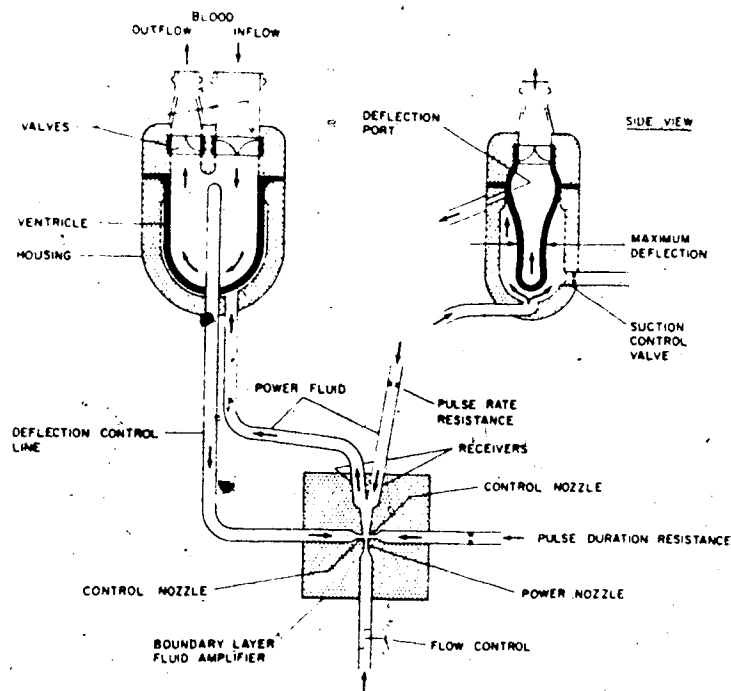

Fig. 1.9 One sac-type heart used a fluid amplifier control mechanism.

Burns and Shumacker [35, 36, 37, 38] of the Indiana University School of Medicine developed an electrohydraulic pump exhibiting apparently favourable results. (Fig. 1.10) Once again, however, the electrically driven hearts were excessive in weight and size causing implantation problems. [39]



Fig. 1.10 Electrohydraulic artificial heart. Both the ventricular and hydraulic units were implanted in the animal's chest and abdomen.

By the mid 1960's compressed air with extracorporeal control devices was becoming well accepted at least as an interim mode of power for total replacement artificial hearts. The air powered pumps were all smaller, lighter, more reliable, and easier to install than electrically driven pumps. The air driven designs also permitted intrinsic control mechanisms based on venous or filling pressure. Such simple control of output could not be realized with any of the positive volume electrically driven pumps.

The control of ventricular outputs; the balance between left and right was becoming a point of major concern. Positive displacement pumps required complicated servomechanisms for control [32, 39, 40, 41, 42] whereas the simpler sac and diaphragm-type air-driven hearts appeared to more or less obey Starling's Law, eliminating the need for external control devices. [6, 34, 41, 43, 44, 45, 46]

Liotta had by this time joined the team of Hall and DeBakey and they began developing a diaphragm-type heart (Fig. 1.11) which could be utilized either as an assist device (Fig. 1.12) or a total replacement heart. [26, 47, 48, 49, 50]

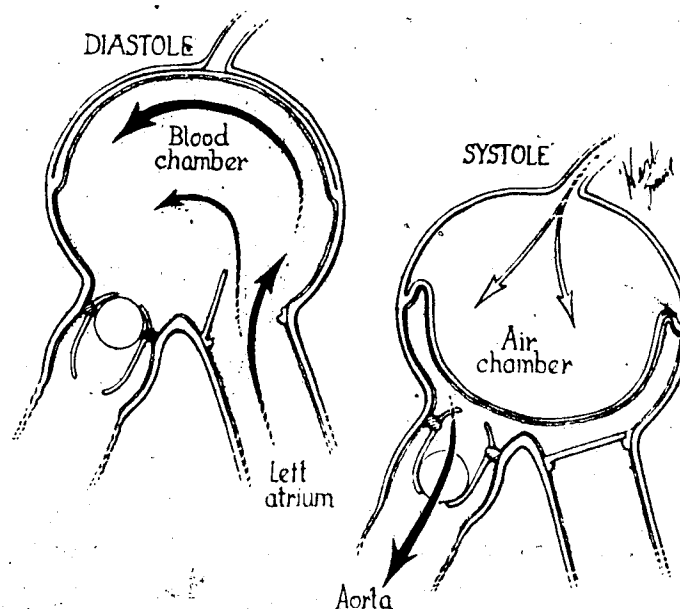

Fig. 1.11 Air-driven diaphragm-type bypass device.

They were also experimenting with linings to ~~improve~~ improve the antithrombotic properties of the blood-diaphragm interface. [48, 51] They lined the inner surfaces of the pumps with nylon or dacron velour which promoted the attachment of a living surface of fibrin helping to eliminate thrombus formation.

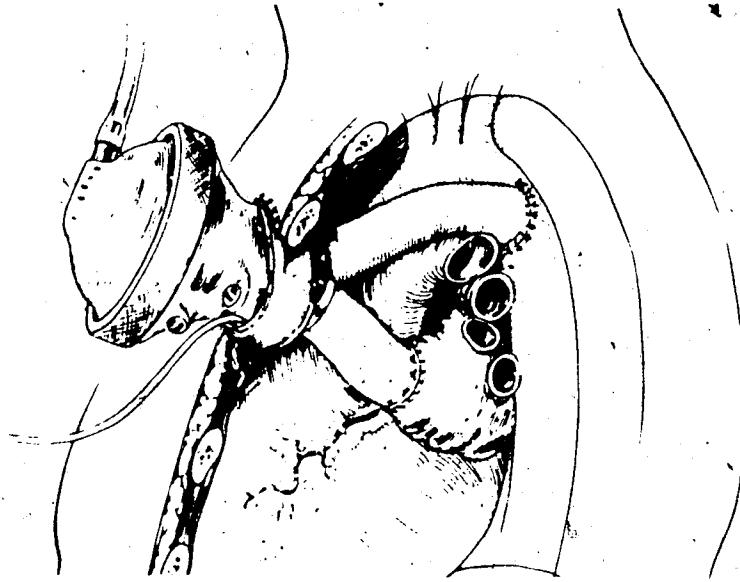

Fig. 1.12 Velour lined bypass device designed for semi-implantation.

A refined prototype of the pump^[52] (Fig. 1.13) was implanted orthotopically in a 47 year old male^[53] by Cooley of Houston, Texas, in the spring of 1969 sustaining his life for 64 hours at which time the patient received a cardiac allograft.

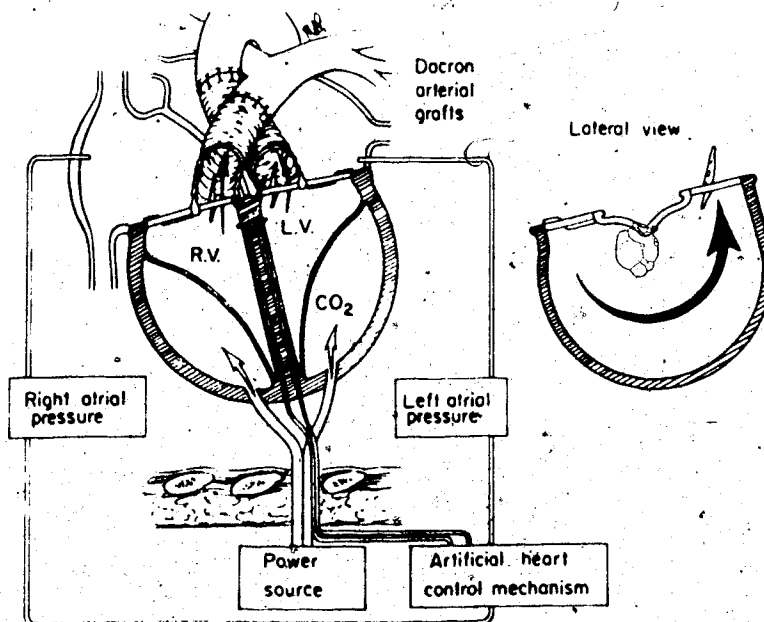

Fig. 1.13 Diaphragm-type orthotopic cardiac prosthesis used in the only total artificial heart replacement in a human being.

This isolated case is an indication of the progress that had occurred in only twelve years since the first suggestion of total replacement hearts at the A.S.A.I.O. meeting in 1957. No further implantations have been performed in humans suggesting that the first case in 1969, however adventuresome, may have been premature.

The past three years have yielded several improved artificial heart designs with extended survival times. Three American groups headed by Akutsu, DeBakey and Kolff have all reported survival times in excess of 100 hours in calves. [54, 55, 56, 57, 58, 59, 60]

Akutsu's design is a biventricular sac-type fabricated of Silastic [61, 62] (Fig. 1.14).



Fig. 1.14 Air-powered biventricular sac-type artificial heart made of Silastic. Calves were kept alive for 247 hours with the device.

Although most of his implantations have taken place in sheep,^[55] more recently, he has reported survival times of up to 247 hours in calves.^[59] They experienced complications of infection and breakage of the device.

DeBakey's group have reported survivals up to 124 hours in calves with a biventricular diaphragm-type design.(Fig. 1.15)

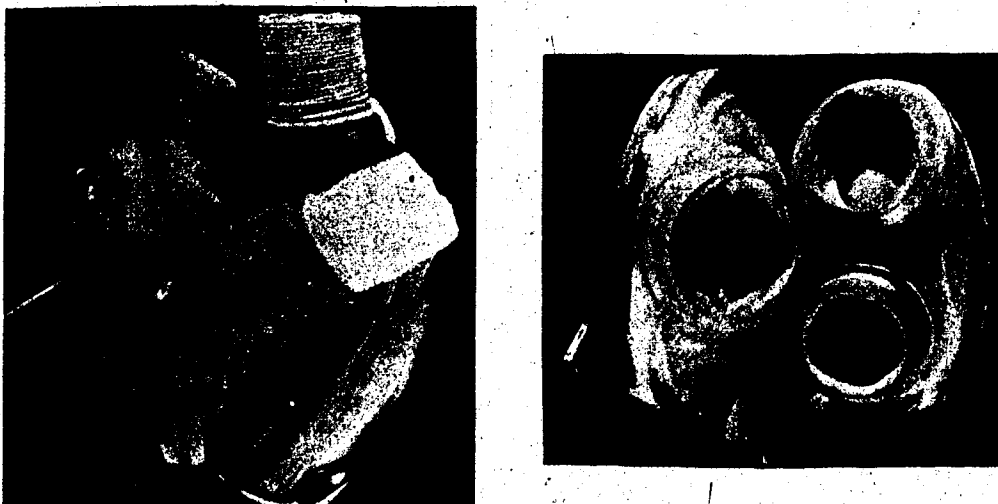

Fig. 1.15 Diaphragm-type design made of Silastic and acrylics. The inside is lined with dacron velour. The heart has pumped for 124 hours in calves.

Their pumps are fabricated of acrylics and silicone rubber, and are lined on the inside with dacron velour. They have cited major problems of blood trauma, clotting, pump design, pump failure and pump control.^[57]

Kolff's group have established a world's record for total artificial heart replacement of 264 hours^[60] in a calf. Their design is a Silastic biventricular device with hemispherical ventricles incorporating diaphragms.^[56, 62](Fig. 1.16)

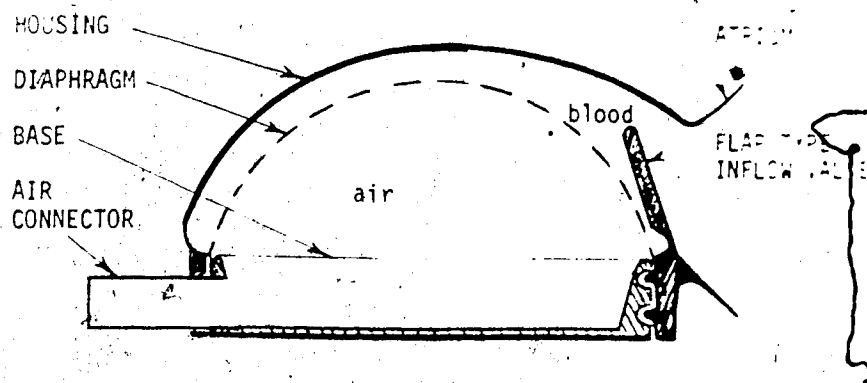

Fig. 1.16 World record survivals of up to 264 hours in calves have been reported with this air-powered silicone rubber artificial heart with hemispherical ventricles.

In some cases their heart has been lined with dacron fibrils^[58] or nylon velour and sometimes seeded with living fibroblasts.^[60] They have reported major problems of disseminated intravascular coagulation, pulmonary insufficiency, renal failure with infarction, infection, ascites, edema and hemolysis.^[58, 60, 64, 65]

These three most successful designs have all been powered by an extracorporeal supply of compressed air utilizing Starling's regulation^[66] to provide a form of inherent regulation of cardiac output^[67, 68] dependent upon venous return alone. Although nuclear powered totally implantable devices have been described^[69, 70, 71, 72] they have been of the assist type and have not been utilized for total heart replacement.

Much of the improvement in survival times and in artificial heart function has been due to simultaneous developments in materials for prostheses, control mechanisms, power supplies, and surgical procedure.

Although the longer survival times have introduced seemingly new problems to be solved,^[55, 56, 57, 58, 73, 74] they are still

intimately associated with inadequacies of heart design, heart materials and heart control.

1.3 Justification for Artificial Heart Research

Heart Disease Mortality Rates

In Canada, more people die from heart disease each year than from any other cause. (Fig. 1.17)

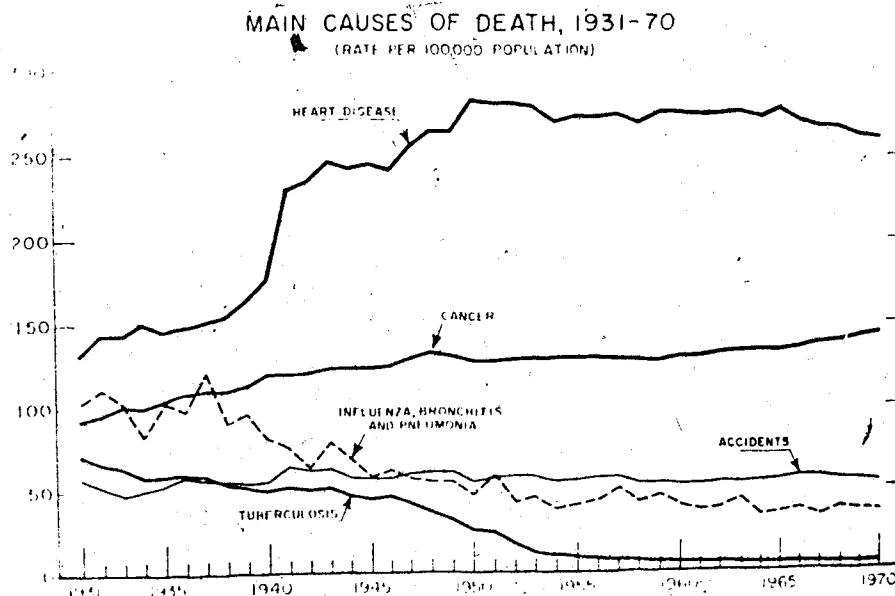

Fig. 1.17 Heart disease is the major cause of death among the Canadian population.

In 1969 for example, 76,664 of the total 154,477 deaths in Canada were attributable to heart disease. [1] These statistics imply that if heart disease goes unchecked one out of every two Canadians can expect to die with it.

Classification of Artificial Heart Devices

Three classifications of artificial heart devices would be required to return all acute and chronic heart disease patients to

a normal life.

Class I. Firstly, an emergency replacement for the myocardial function of the heart would be required. The device would have to be applied within four minutes by lay persons outside a health care institution with a minimum amount of equipment. [75] The purpose of the device is to permit the many patients with cardiac arrests outside hospitals to be transported to a hospital alive. External heart massage with mouth-to-mouth pulmonary resuscitation performed by trained laymen will meet these requirements. The use of this technique by highly skilled personnel in hospitals has demonstrated that it can sustain life up to several hours in the event of a complete cardiac arrest without residual brain damage. [75]

In the event of cardiac arrest during an open-chest surgical procedure the circulation may be maintained in a similar emergency fashion by direct heart massage. Patients whose hearts did not recover completely from the emergency support would require a Class II device.

Class II. A Class II device would be required by those patients having heart disease from which they can recover but whose hearts need support for from a few hours to several days. These devices could be used not only in cases of primary heart disease but also in cases where the heart is a secondary factor as in some respiratory infections and surgical shock. [75]

These devices could be either intra-corporeal or extra-corporeal with bedside power sources and control devices. They would need to replace only partial function of the natural heart.

In the event that the patients own heart did not recover sufficiently during the utilization of the Class II assist device, it could be employed until the patient could be transported to a hospital where a Class III, permanent replacement heart could be obtained and implanted. In a similar manner, the Class II device could be used to maintain the lives of chronic heart disease patients awaiting a permanent replacement.

At present, only intra-aortic balloon pumps are satisfying some of the requirements of a Class II device. They are being employed in several American Hospitals for the treatment of cardiogenic shock for periods up to 120 hours. [9, 76, 77, 78] The pumping duration of these devices is limited by their thromboembolic potential.

Class III. Permanent replacement hearts would be required by all patients suffering acute disease whose hearts could not recover sufficiently during the period of assistance from a Class II device and by those patients with chronic heart failure. The replacement heart would have to be totally implantable within the body and would have to provide the host with enough cardiac output for a normal life. It is reasonable to expect that the new heart should replace the diseased heart within the pericardium.

At present, only the cardiac allograft can provide the mechanical requirements of a Class III device. Heart transplantation is however, burdened by several limiting factors: the procurement of donor organs, the storage and preservation of the tissues, and the homograft response to reject the allograft. [79] The alternative to a transplanted heart is of course an artificial heart.

The Effect of Cardiac Allografts Upon Artificial Heart Research

To some people, the necessity of the artificial heart and the justification for further research is pending upon the as yet undetermined success of the biological heart transplant. We believe that this is not the case. There are two possibilities; the allografting technique will prove to be either widely acceptable or not.

If proved acceptable, an artificial heart could play the important role of sustaining the life of a prospective host while waiting for a donor heart of suitable tissue type and compatibility. This temporary support would aid in donor selection and would protect other vital organs of the body that suffer so greatly during the failing days of the host's native heart. This type of artificial heart would in effect be a sophisticated, long term Class II device.

If allografting proves unacceptable, the usefulness of the total artificial heart would be unquestionable as a device for long survival of patients suffering from irreversible myocardial damage.

Whereas the temporary Class II device could be powered and controlled from a bedside module, the long term device would have to be entirely independent of extracorporeal components. It may be argued that unless an attempt is made at implanting the power and control devices, the problems encountered are not critical enough to justify research. We do not believe this is so. The success of past and present experimental implantations of artificial hearts both with and without implantable power sources are limited to recipient survival times measured in days. Both types of prosthesis are faced with the same basic problem; that of adequately duplicating

the pumping characteristics of the natural heart without causing pathological changes within the host. The existence of this extensive unsolved problem certainly justifies continued artificial heart research utilizing extracorporeal power sources.

Unsolved Problems in the Total Artificial Heart

In his Presidential Address to the American Society for Artificial Internal Organs in 1961 Kirby expressed great optimism in the solution of problems related to the artificial heart.^[80]

"The successful construction and implantation of an artificial internal heart is going to be a reality much sooner than the most optimistic among us believed seven years ago. We have all the know how that is required, from the surgical, physiological, and engineering standpoints. Many details must still be worked out, but these are merely a matter of time and money, in my opinion...With adequate funds, and the concentrated efforts of highly skilled surgeons, physiologists and engineers, it seems almost certain that an artificial heart suitable for implantation in patients could be developed within two to five years."

Almost a full decade later in 1970, Kolff addressed the same society with his views on "Artificial Organs in the Seventies".^[81] Kolff felt that very little improvement was cited in artificial hearts from 1965 to 1970, but that the seventies had a bright future. Unfortunately, the hoped for "adequate funds" suggested by Kirby in 1961 never appeared and Kolff felt that not only the progress of his own group, but also of others was greatly thwarted by the "marginal" contributions of the National Heart Institute. Kolff did predict that an "artificial heart will totally replace the human heart," but

not in the short years that Kirby had predicted. He even suggested that the artificial heart might not be made in his or his contemporaries' time.

It is not so strange that the predicted date for an adequate artificial heart has been set farther into the future. When Kirby spoke, very little was known of the problems that would be associated with total artificial heart replacement. As the survival times have increased over the years, so have the complications. Investigators now realize the complexity of the complications, which we believe may all be related to a small number of basic inadequacies common to all artificial heart designs, materials, and control systems. We shall name these inadequacies "limiting factors."

The Need for Clear Definition of Problems

When this project was begun in 1970 it was apparent that problems associated with total artificial heart replacement in animals were at best loosely defined. Experiments appeared to be performed with an often "trial and error" attitude. In most cases, reports included only animal survival times and samplings of plasma hemoglobin. The determination of "survival" was occasionally a moot point with some experiments being no more than the perfusion of a cadaver. There existed a need for experiments to be performed with a suitable, typical design artificial heart conducted in a systematic manner including extensive biochemical analysis and post-mortem examination to explicitly define the associated problems or limiting factors. From an analysis of these limiting factors a suitable set of design criteria could be offered to investigators embarking upon this field

of research. The identification and analysis of problems related to experimental total artificial heart replacement was the aim of this project.

1.4 Division of Phases

When the project began we believed that for an effective artificial heart program, the project should be divided into three phases.

Phase I was to include basic design considerations of a suitable artificial heart, driving system, and testing apparatus. Materials and fabrication methods would be developed and the basic design heart would be tested in vitro to evaluate its performance characteristics.

Phase II would consist of a number of pilot animal experiments to develop the design configuration for implantation. Suitable species of animals would be chosen, the surgical techniques would be developed and accessories such as cages and monitoring devices would be constructed. It was expected that Phase II would be the longest and would represent many changes in the pump design, manufacture and surgical technique.

Once the artificial heart and implantation technique was standardized, a series of implantations would be performed to evaluate the "limiting factors." The final Phase III would include a systematic study of most biochemical and physiological systems before, during and following support of the experimental animals' circulation with the total artificial heart.

CHAPTER II

PHASE I - PRELIMINARY DESIGN TOTAL ARTIFICIAL HEART, TIMING AND DRIVING DEVICE, AND TESTING EQUIPMENT.

2.1 Preliminary Heart Design

Design Criteria

For the artificial heart to mimic the function of the natural human heart, the following minimum physiological and physical requirements were established:

two separate pumps duplicating the left and right hearts

atrial pressures of 0-16 mm.Hg

output range of 5 to 10 liters per minute from each side

aortic arterial pressure range of 120-180 mm.Hg

pulmonary arterial pressure range of 20-80 mm.Hg

low weight to minimize restraints

a minimum of noise and vibration

a heat output of less than 25 watts

a low degree of red blood cell hemolysis

compatibility with body chemicals

a suitable control mechanism. (Fig. 2.1)

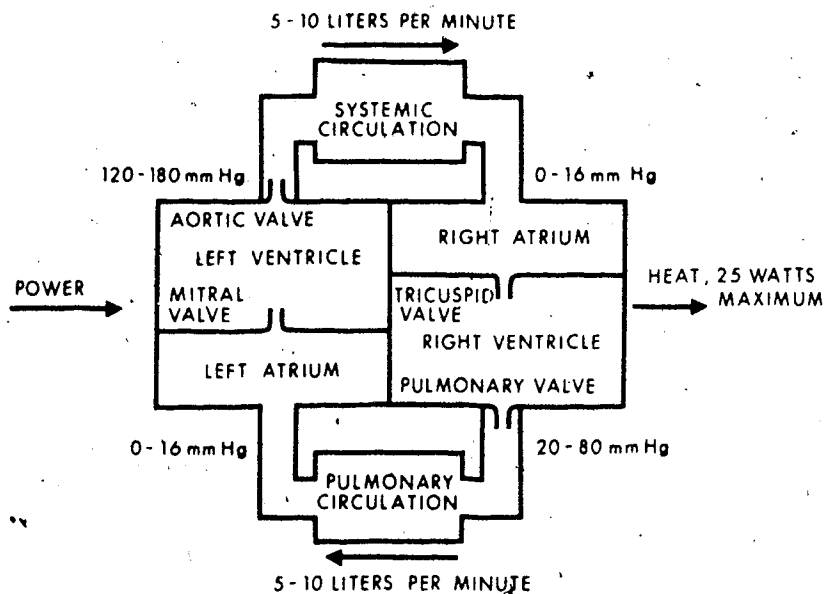

Fig. 2.1 Schematic of artificial heart design criteria.

Control of Output

If the outputs of the two ventricles were not balanced, either the blood vessels in the lungs or those in the rest of the body would be congested with an excess accumulation of blood. In the natural heart, ventricle output is regulated by the principle known as Starling's Law whereby the output of each side of the heart is governed by the degree of filling of the ventricles assuring a balance of flow rates. This type of intrinsic control of output balance appears mandatory for an artificial heart.

It is generally accepted that most if not all control, is done outside the heart. The heart's ability to pump seems affected by many variables including the output pressure load, sympathetic

and parasympathetic nervous regulation, heart rate, intrathoracic pressure and myocardial damage. The amount of blood actually pumped is determined by the demand for blood throughout the body and is reflected as a change in atrial pressure.

The function curves of ventricular output and venous return plotted by Guyton^[82] demonstrate the effect of Starling's Law. (Fig. 2.2)

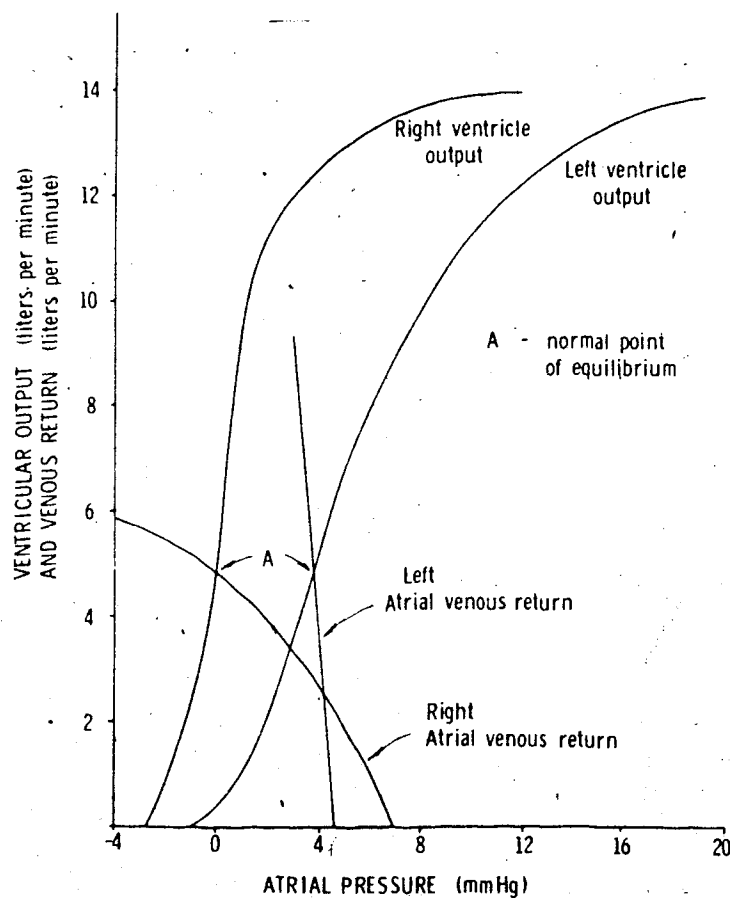

Fig. 2.2 Starling's regulation ensures a balance of output between the left and right ventricles.

The left and right ventricular function curves display a sensitivity of output to filling or atrial pressure. The output of each ventricle is identified by the intersection or so called "equilibrium point" of the ventricle output curve with its respective venous return curve.

The greater the demand for blood, the higher on the ventricle output curve is the equilibrium point. For example, during moderate exercise, 80% of the increase in cardiac output can be attributed to the effect of venous return. (Fig. 2.3)

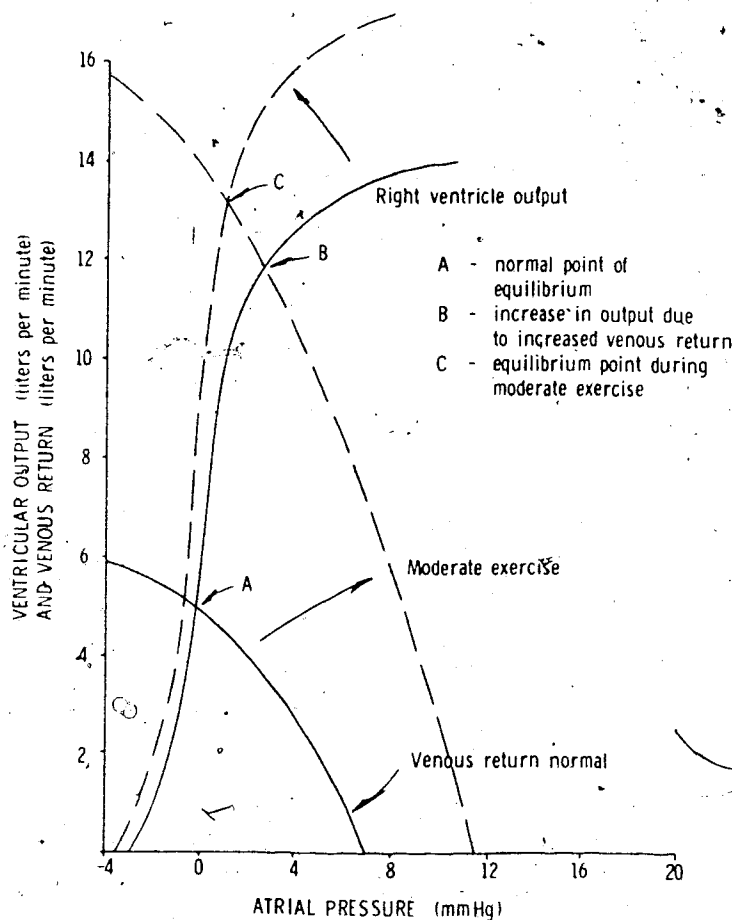

Fig. 2.3 The increase in cardiac output during exercise is mostly due to an increase in venous return.

The equilibrium point moves from point A to point C, from 5 to 13 liters per minute. Clearly, most of the increase in output is due to the greater venous return and only partially due to a change in the shape of the output curve from point B to point C. It appears then that a prosthetic heart controlled by venous pressure alone would satisfactorily accommodate the host with an adequate range of pump output.

Design Principles

The design principle of choice was that of the air-driven collapsible sac-type. The sac-type ventricle appeared to fulfill the minimum design criteria since:

an extracorporeal power source eliminated heat dissipation problems

the lack of internal power source permitted total utilization of the limited space for pumping chambers which could meet the capacity requirement

it appeared to be the most physiological method to pump blood with its relatively gentle action and normal rate

the ventricles could be fabricated easily with a shape similar to that of the natural heart

the weight could be kept to a minimum utilizing light materials

and it would obey Starling's Law, greatly simplifying the external control and driving mechanism required.

Design Details

The first model heart was four-chambered and contained four one-way check valves. (Fig. 2.4) The shape resembled that of the natural heart (Fig. 2.5) consisting of two independent sides for ease of atrial anastomosis. Each side had identical ventricles but different atria. The right side had a completely artificial jumbo atrium providing for direct cannulation to the inferior and superior vena cavae. The left side had a partial jumbo atrium requiring suturing to the left atrial remnant of the resected heart. These atria were designed to form large elastic reservoirs providing

for rapid ventricular filling during diastole without the use of vacuum.

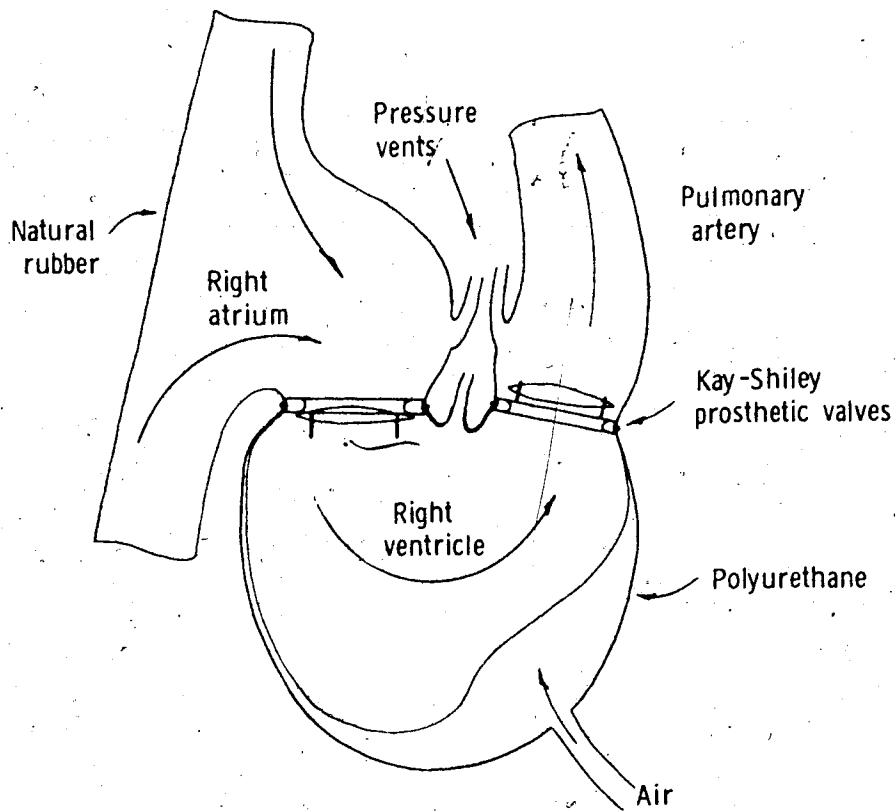

Fig. 2.4 Schematic of the first sac-type artificial heart.

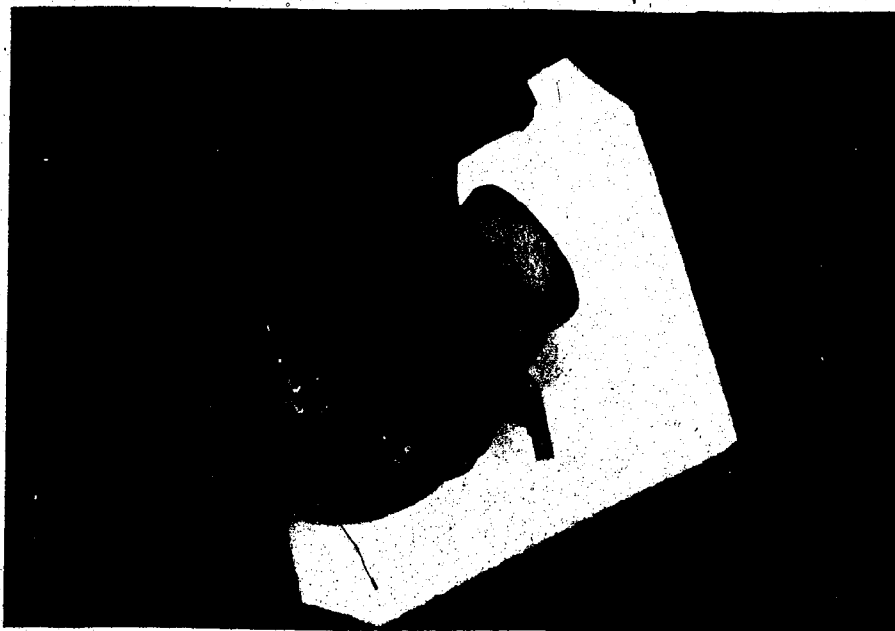

Fig. 2.5 First model artificial heart fabricated of natural rubber and polyurethane.

Vacuum applied to the atria was thought to cause air aspiration at suture lines, and venous collapse in earlier designs of other investigators. The pulmonary and aortic arterial connections provided for simple cannulation into the natural vessels.

The sacs, atria and arteries were made of natural rubber. Commercially available valves were incorporated and the semi-rigid ventricular walls were clear polyurethane. The pumps were fitted with vents into all chambers for pressure monitoring, and tubes into the spaces between sacs and housings to provide ports for the driving air.

The ventricles were considered first. Since both ventricles must pump equal volumes the first requirement was that they should be equal in size. The natural heart possesses ventricles of different shapes but apparently only to accommodate the unequal volumes of muscle in either side so that it appeared simplest to design both ventricles with identical shape as well as equal volume. A very convenient shape was that of one-half of a semi-prolate ellipsoid such that when placed with their flat sides butting, the ventricles assumed a form very similar to that of the natural ventricles involving no sharp corners or obvious clotforming stagnation points. It was thought desirable, as is evidenced by the natural heart, to have a large residual volume in each ventricle to minimize blood forces and to provide a reserve for extra, short term output. A large residual volume was essential in the sac-type heart to reduce high stresses in the ventricle sac and to prevent blood hemolysis owing to the rubbing of opposite sides of a highly evacuated sac. For a mean cardiac output of 5 litres per minute at 72 beats per

minute the stroke volume of each ventricle would be 70 ml. Thus a ventricular volume of about 120 ml. provided for a considerable residual volume of 46%.

The atrial design had to include not only volume and compliance but more critical, the orientation of their inlets to accommodate the vessels to which they would be anastomosed. The simplest atrium is one that is completely artificial and connectable to veins by means of quick cannulation. The right atrium was designed in this manner along with short vena cavae and had an internal volume of 115 ml. By examination of sheep, dog and human hearts in vivo and ex vivo, a suitable orientation of the venous stumps was established. The pulmonary veins are not so easily cannulated so a partial atrium was used for the left side which, when anastomosed to the left atrial remnant, would form a jumbo atrium of volume similar to that of the right atrium.

The pulmonary and aortic arteries were simulated by rubber stumps about 5 cm. long and 2 cm. in diameter. They too were oriented to approximate with the natural vessels.

Materials and Manufacturing Details

In general, artificial heart materials which reside within the body should be biologically inert; [83] non-carcinogenic, non-antigenic, non-electrolytic and non-toxic. [84] Materials in contact with blood should also be non-hemolytic and clot repellent. [83] These requirements were considered in the choosing of materials for the construction of the pump.

Natural rubber is one of the strongest elastic materials.

but had for a long time been believed to be unsuitable for implantation in the living body. It had since been discovered that specially treated pure natural rubber caused little tissue reaction and was compatible with blood.^[83] Polyurethane, the other material used in the pump construction, was known to have excellent qualities for implantation causing no known degradation to the body. Some studies^[85] had indicated that polyurethane loses strength after many months implantation but remained as a very useful plastic for short term applications.

The manufacture of a complete pump involved many stages which shall be discussed in their chronological order. The core of the pump was the rubber sac which formed the ventricle bags, necks, atria and arteries for each side. The sacs were thin and best made by dipping a male form several times into liquid latex. The prototype sac forms were hand carved from blocks of pink dental wax and smoothed with a flame to approximate the desired shape. The impressions of these forms were made in room temperature vulcanizing rubber which produced reusable female molds for casting of male paraffin wax forms. These male forms were the same shape as the prototype but could be customized to accommodate various valve sizes by reducing the neck size. They were next dipped from 4 to 7 times (depending upon the rubber used) into room temperature curing liquid latex. Each successive coating of latex vulcanized completely with the one before producing a smooth uniform sac of about 50 mills thickness. After several days curing the bags were stripped from the dip forms and each fitted with two one-way valves. The valves were fitted in the rubber necks between atria and ventricles and held in

place by a simple wire clamp. A part of the rubber into the circumferential notch found in the valves after removal of suture cuffs. Before applying the polyurethane outer casing the rubber ventricles were dipped in liquid paraffin up to the necks to prevent sticking of the rubber to the polyurethane. The desired thickness of polyurethane was achieved with 8 to 10 brushed on coats taking about 5 days to apply with curing periods between coats. The polyethylene air inlet/outlet ports were added at about the fourth coat. Following several days curing of the polyurethane the pump was complete. (Fig. 2.6)

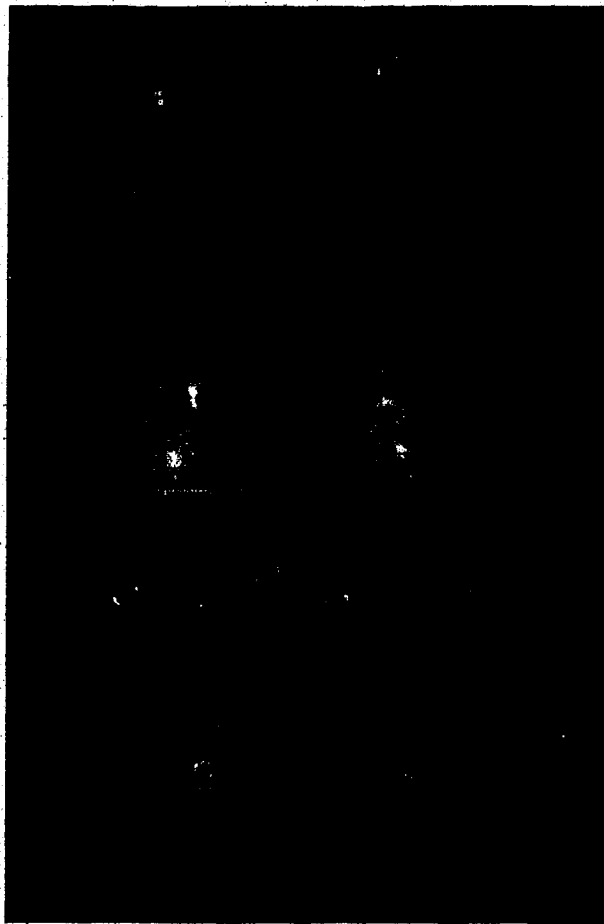

Fig. 2.6 Pump fabrication sequence with wax and rubber molds, rubber sacs, and finished ventricles.

2.2 The Timing and Driving Unit

The timing and driving system must be capable of delivering compressed air of variable pressure to each side of the heart independently, with a variable systolic and diastolic duration. Working pressure may range from 0 to 10 PSI. and diastolic and systolic duration should range from 0 to 1 or more seconds to allow a minimum of 30 strokes per minute. (Fig. 2.7)

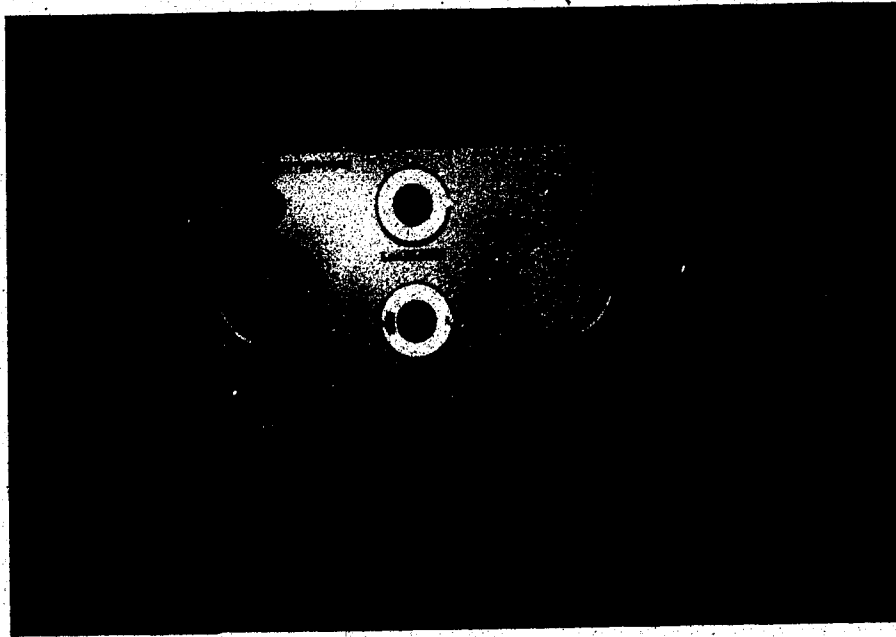

Fig. 2.7 The timing and driving unit.

The system consists of pressure regulators, pressure gauges, three-way air pressure piloted solenoid valves, and a simple vibrator electronic circuit to control the pulses to the solenoid valves. (Fig. 2.8)

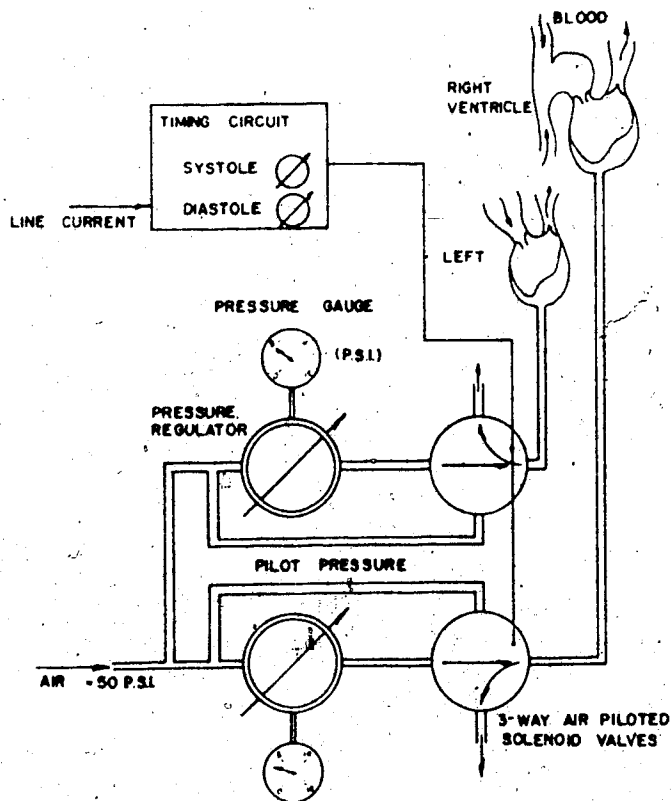

Fig. 2.8 Schematic of timing and driving system.

The regulators are controllable from 0 to 15 P.S.I. The diaphragm gauges register from 0 to 15 P.S.I. and the valves have large 1/4 inch orifices which is important to allow for rapid exhaust of the evacuated ventricles during diastole. The system is designed to accept any source of compressed air supply between 15 and 300 P.S.I. Systole and diastole are each variable from 0 to 2 seconds. (Fig. 2.9)

2.3 The Mock Circulations

The Vital Assists Inc. mock circulations consist of multi-columnar plexiglass tanks capable of producing variable inlet (atrial) and outlet (diastolic) pressures, and to some extent a variable capacitance. The atrial pressure is adjusted by merely adding or removing fluid from the test chamber (Fig. 2.10) allowing a variation from -8 to +24 mm Hg.



Fig. 2.10 A mock circulation unit with the left ventricle pumping.

Diastolic pressure is adjusted by pumping air in or out of vertical chambers which varies the differential in fluid level from one chamber to the next; the total pressure being the summation of all differentials. By employing many columns it is possible to produce a back pressure of 100 mm.Hg in a chamber only 60 cm. high. Flow rate is measured by an orifice meter calibrated to indicate liters per minute. The chambers for right and left sides differ only in the

number of columns; the right side having two columns allowing pressures from 25 to 50 mm.Hg and the left side having four columns allowing pressures from 25 to 100 mm.Hg. Both chambers were designed to fit together allowing a cross-over of outlet pipes from the right to the left side and vice versa. This connects the chambers in series with the right side representing the pulmonary circulation and the left side representing the systemic circulation. (Fig. 2.11) With an interconnected test device such as this the effects of a change in pressure or flow rate on one side can be examined on the other.

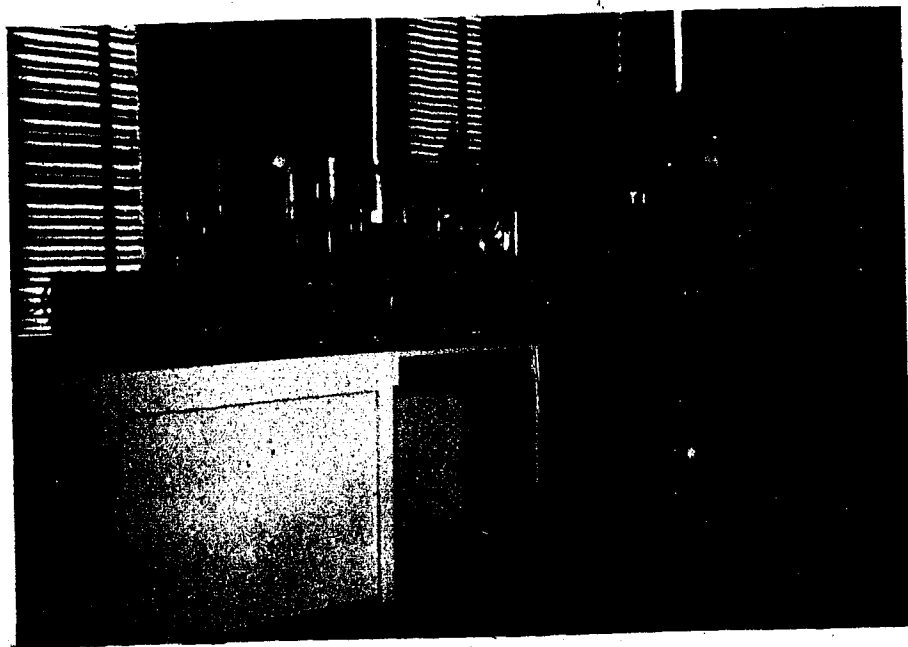

Fig. 2.11 The test bed for in vitro performance tests with left and right mock circulations connected in series.

2.4 In Vitro Performance Characteristics of the Pump

In vitro performance tests were conducted with the timing device, mock circulations, and pressure transducers connected to a chart recorder and oscilloscope.

With a constant frequency application, the durations of diastole and systole are fixed. The stroke volume of the pump is then governed by the degree of filling of the ventricles. The greater the inflow of blood; the more complete is the filling of the ventricle and therefore; the greater is the output.

The pumps produce function curves with characteristics of the natural heart. (Fig. 2.12)

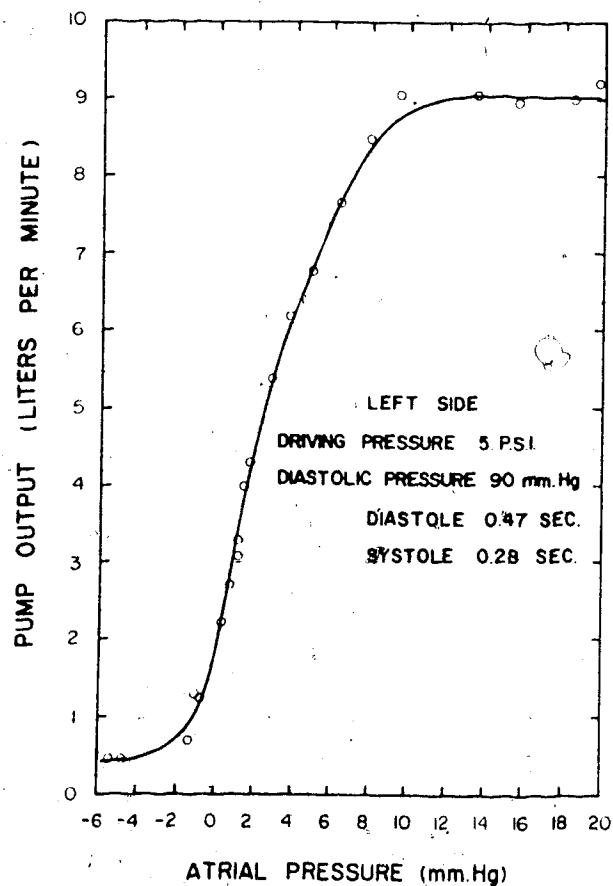

Fig. 2.12 Function curve from a left ventricle showing obedience of Starling's Law.

In this manner, the pump and driving mechanism exhibit an obedience to Starling's Law, insuring a balance of the output of both ventricles. For an example of this mechanism, an increase in atrial pressure in the left side of the mock circulation increases the output of the left ventricle which in turn provides the right ventricle with an increased filling pressure, causing its output to come to equilibrium with that of the left ventricle. The response is rapid and should effect equilibration of ventricular outputs in vivo.

The optimum pump rate is one providing both high sensitivity of output to filling pressure and acceptable maximum output. (Fig. 2.13)

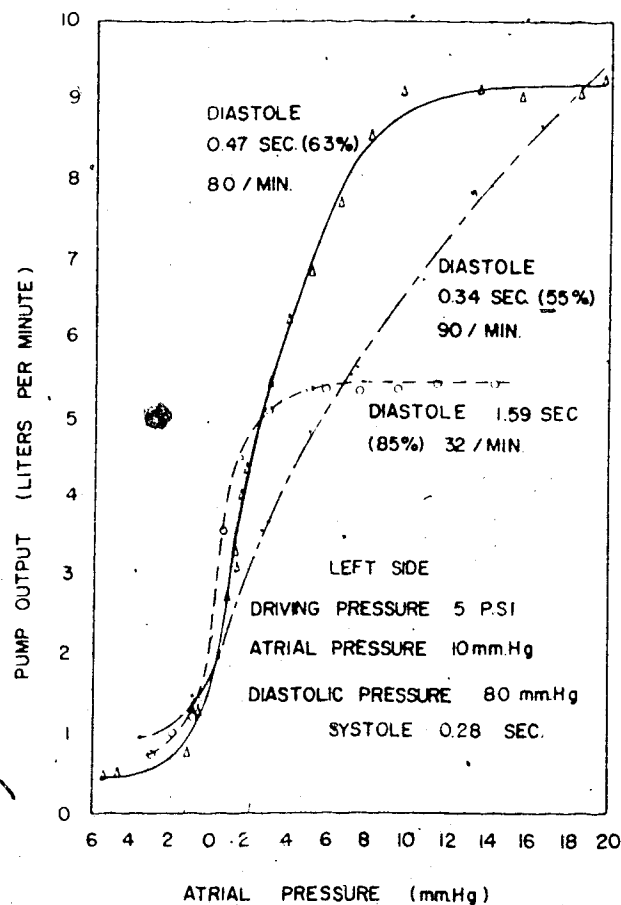

Fig. 2.13 The sensitivity of the function curve changes when the rate is changed. The optimum rate is 80 beats per minute with a diastolic:systolic ratio of about 2:1.

Too slow a rate results in a reduction in output due to idle periods following complete diastole and systole. Too fast a rate allows only partial filling and expulsion of ventricle contents, reducing sensitivity to filling pressure. For these pumps, the optimum rate was 80 beats per minute, with a diastole of 0.47 seconds and a systole of 0.28 seconds (37% of cycle).

The pumps together weigh 230 g., occupy 650 ml. of space and have ventricular volumes of 120 ml. as compared to the average human heart of 300 g., 700 ml., and 115 ml. respectively. The pumps produced no heat and a tolerable level of noise and vibration.

Pressure wave forms measured from the left atrium, ventricle and aortic artery of the pump display features similar to those found in pressure recordings from normal animals. (Fig. 2.14).

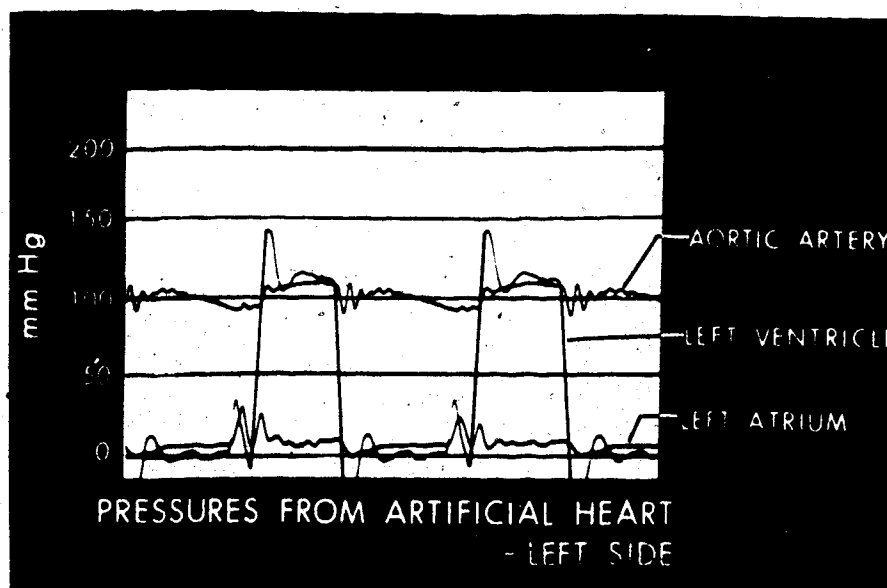

Fig. 2.14 Pressure recordings from the chambers of an artificial heart on the mock circulation.

2.5 Summary

During Phase I, a preliminary design pneumatically driven sac-type artificial heart was fabricated and tested with a suitable timing device and mock circulations. The heart would pump up to 11 liters from each side and demonstrated function curves responding to Starling's Law. The basic design was then ready for modification to facilitate orthotopic transplantation in experimental animals.

CHAPTER III

PHASE II - DEVELOPMENT OF THE PRELIMINARY DESIGN ARTIFICIAL HEART FOR IMPLANTATION IN EXPERIMENTAL ANIMALS

Through continued in vitro testing and pilot implantations, the preliminary design was expected to evolve along with the development of surgical technique, heart materials and fabrication.

In all, twelve different models of artificial heart have been fabricated and tested in vitro. Nine models have been tested in vivo in 43 implantations in dogs, pigs and calves. The following is a brief summary of the design features, fabrication methods, and performance of the developmental models.

3.1 Model Mk II

The first model to be implanted was similar to the preliminary design with the addition of suitable connectors. A double layer nylon velour suturing cuff was stitched to the left atrium with a layer of silicone rubber between the atrium and the cuff. Stainless steel barrels were turned and polished to facilitate connections of the arteries and vena cavae to the natural vessels. Pressure vents were made into both atria and arteries and Kay-Shiley valves were fitted. (Fig. 3.1)



Fig. 3.1 MK II. First implantation model.

There were some detail changes in the fabrication. In vitro endurance testing of the preliminary model led to cracks appearing in the polyurethane outer casings along the flat back, sides and around the valve necks. These areas were strengthened in the Mk II model by a lamination of glass fibre material. The molds were also altered to give slightly more cross-over to the pulmonary and aortic arteries.

In August and September 1970 the biventricular device was implanted in two 30 kg. dogs. The animals were anesthetized with

barbiturates, subjected to a transverse thoracotomy and placed on a bubble-type heart lung bypass via femoral and neck cannulations during the implantation. The dog's heart was excised at the atrio-ventricular groove and the arteries were divided close to the ventricles. The left atrial cuff was sutured to the left atrial remnant and the dog's arteries and vena cavae were tied over the stainless steel connectors with umbilical tape. The pressure monitoring vents were used to prime the hearts with blood which were then activated.

These first two dogs died on the operating table because of various technical problems. Most important of these was the difficulty in approximating the pulmonary arterial connector with the natural vessel and a too rigid left atrial cuff, causing the left ventricle to stand almost on end eventually tearing the left atrial remnant causing air aspiration and blood loss. (Fig. 3.2) The dogs survived for 15 and 90 minutes.



Fig. 3.2 Poor fit in the chest of a 30 kg. dog due to orientation of arterial connectors and stiff atrial cuff.

3.2 Model Mk III

The Mk III design included changes in the vessel orientations and in the atrial suturing cuff. The pulmonary and aortic arteries were made much longer with a greater cross-over and bend to permit the ventricles to lie flatter in the chest. The atrial suturing cuff was made more flexible by eliminating the Silastic filler and was angled more toward the natural vessel. In this model, Toroidal prosthetic valves were fitted. (Fig. 3.3)



Fig. 3.3 Mk III model has longer arteries and a more flexible atrial cuff.

Using a similar implantation procedure the Mk III model was implanted in 4, 30 kg. dogs in November 1970. The modifications improved the fit and the technical application of the pump was satisfactory. (Fig. 3.4)

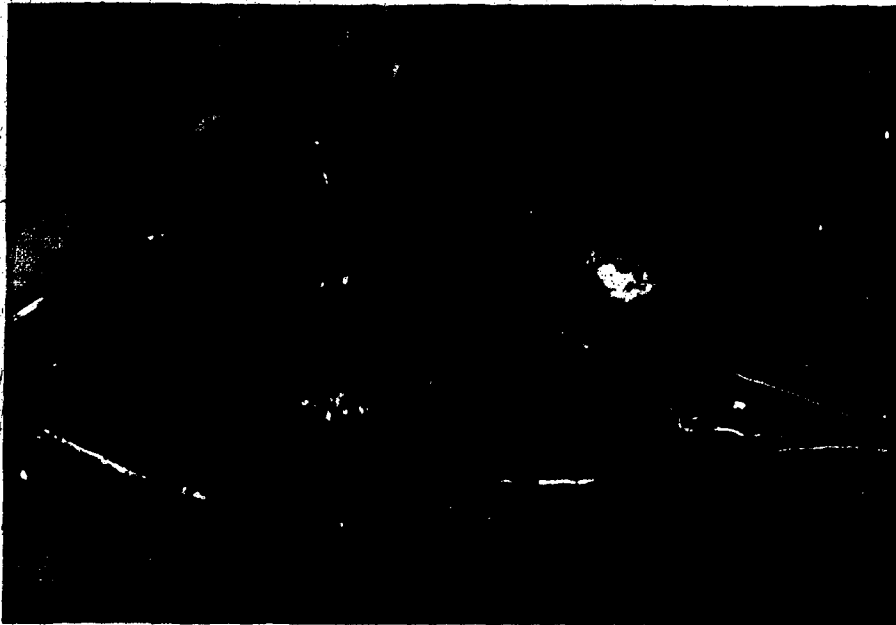

Fig. 3.4 Mk III model in the chest of a 30 kg. dog. Fit was acceptable, but since the animal was too small for the device, the diaphragm had to be split. Dogs had poor recovery and lived up to 6 hours.

Time on the heart-lung machine averaged 95 minutes. Since the pump was designed for human sized animals it was too large to be enclosed within the pericardium and required the splitting of the dog's diaphragm to allow the pump to lie flat in the chest and cause little interference with venous return or respiratory function.

In all four experiments, the artificial hearts maintained blood flow within normal range for from five to six hours. (F

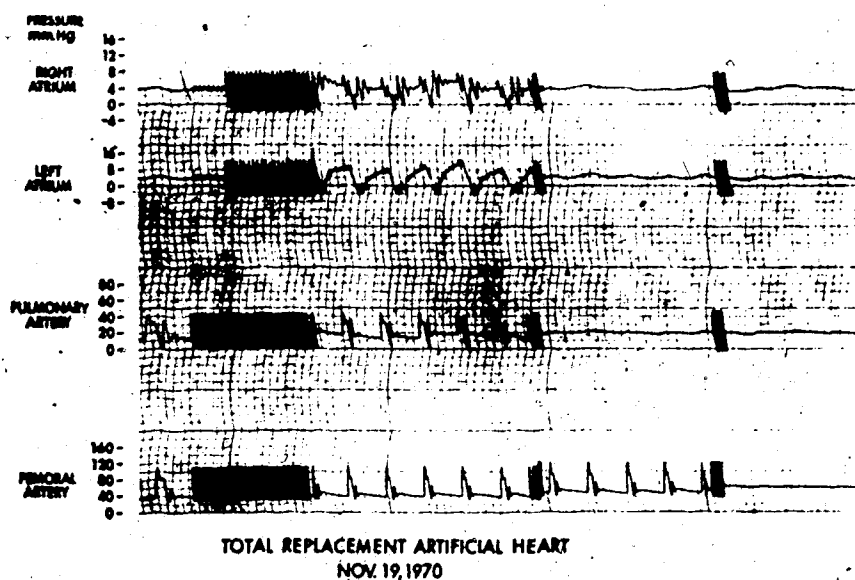

Fig. 3.5 Blood pressure recordings from a 30 kg. dog after 4 hours of pumping with a Mk III device.

To compensate for reduced blood flow rates in the dogs, the pumps were slowed to a rate of 60 beats per minute with a systolic:diastolic ratio of 1:3. The driving pressures were set at about 150 mm.Hg and 75 mm.Hg for the left and right ventricles respectively, and required only occasional minor adjustments to maintain arterial pressures at the desired levels. Aortic flow was estimated at between 2.5 and 3.0 liters per minute. In two of the dogs, blood oxygenation was high and blood pH maintained near normal, whereas in two other dogs, oxygenation and pH fell progressively below normal limits. In all animals there was a great increase in hemolysis as the duration of pumping lengthened. After five hours of pumping average plasma hemoglobin levels were 335 mg. %. A major factor in this was thought to be the fact that blood lost by the animal was collected from the chest by suction and replaced directly. In all animals there was

air embolism, in some cases more severe than in others. This was caused by incomplete evacuation of air during priming and by aspiration of air at the suture line of the left atrial anastomosis. None of the animals recovered from the anesthesia. Only the last two animals displayed signs of activity following three hours of pumping. Both of these dogs showed signs of waking up and one attempted to breathe during a change of ventilator oxygen tanks.

In all four cases atrial pressures began to fall below zero after about four hours of pumping with a corresponding decrease in venous return. Intravenous injection of large volumes of fluids would return the atrial pressures to normal but only for shorter periods of time until the animals were in complete irreversible shock at which time the experiments were terminated.

3.3 Model Mk IV

The fourth model consisted primarily of a change in the method of left atrial anastomosis. Implantations of the previous models all resulted in some degree of air embolism due mostly to aspiration of air at the left atrial suture line. To overcome this problem the Mk IV model was fitted with a large teflon ring which could be tied to a skirt of the animal's left atrial remnant. (Fig. 3.6)

In addition, the air driving tubes were brought away from the ventricle perpendicular to those previous to avoid the necessity of splitting the diaphragm. The pressure monitoring and priming vents were also moved to a higher position to facilitate more complete exhaustion of trapped air in the hearts while priming. (Fig. 3.7)



Fig. 3.6 Mk IV model showing teflon ring for left atrial anastomosis and teflon valve holder in the bicuspid position. Survival times were increased to 9 hours.

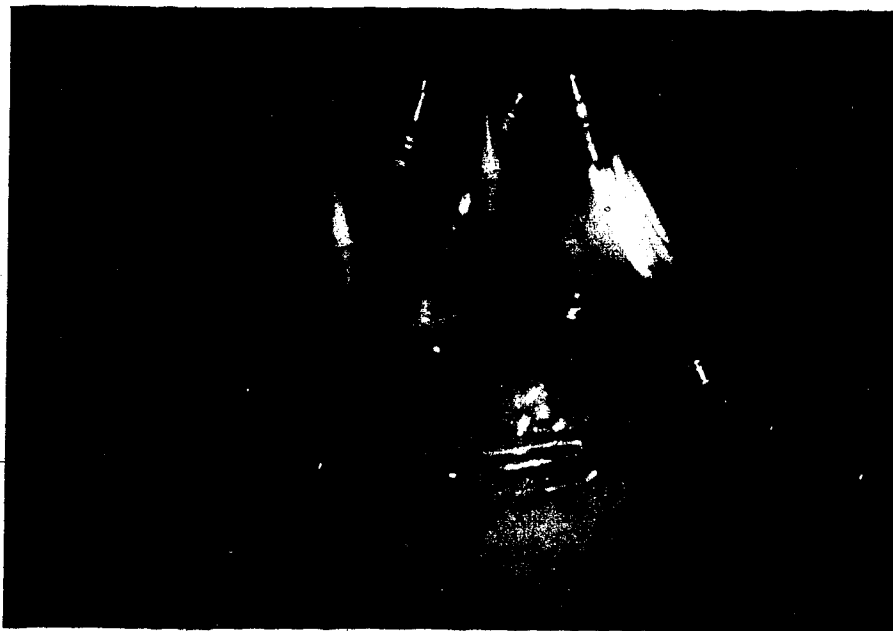

Fig. 3.7 Moving the pressure vents to the tops of the vessels permitted more complete exhaustion of air when priming. New position of the air driving tubes no longer required splitting of the diaphragm.

The method of retaining valves was also changed. The Kay-Shiley and Bjork-Shiley valves were first fitted into teflon retaining rings which were held in place in the rubber sacs with the usual wire clamps.

From February 1971 until August 1971, Mk IV hearts were planted in 4 dogs, 1 pig and 5 calves. These implantations produced many problems and few solutions.

The dogs used in the experiments eventually all proved to be too small for the heart design. The chest could not be closed without compromising venous return. None of the dogs awoke from the anesthesia and all appeared to tolerate the heart-lung bypass poorly.

In an effort to utilize more human sized animals one heart was implanted into a 41 kg. pig. The pig recovered from the anesthesia and survived for 9 hours. The lack of accessible leg and neck blood vessels did however make the pig unsuitable for cardiopulmonary bypass.

The first two calf experiments ended in anesthetic death. The anesthetic agent was then changed from a barbiturate to Fluothane gas. The three successful implantations were complicated with poor bypass flow rates.

The new method of left atrial anastomosis of the Mk IV model did eliminate the severe air aspiration of earlier designs, but the hard teflon atrial ring caused compromise of the pulmonary veins, resulting in poor venous return to the left side and concomitant low cardiac output.

All the animals experienced low blood oxygen tensions,

hematocrits and blood pH. In most cases plasma Hb. levels were in excess of 100 mg. %. The animals were usually sacrificed when diastolic arterial blood pressures approached zero.

In this series of implantations, as before, the animals were kept anticoagulated with Heparin. As a result, post-operative bleeding was usually a major complication..

Although the left atrial tying ring was quick and easy to install, the Mk IV heart was abandoned because of the severe problems of inadequate pulmonary venous return.

3.4 Model Mk V

In an effort to eliminate the problems of poor venous return caused by the previous design the Mk V model included a change in method of left and right atrial anastomosis. Each artificial atrium consisted of a dacron graft and nylon velour suturing cuff. (Fig. 3.8)



Fig. 3.8 With the Mk V model each atrial remnant was sutured to a dacron graft and velour cuff.

Sewing in a cuff on the right atrial remnant permitted the use of an inferior vena cava venous drain via the right atrial appendage which enhanced bypass flow rates. It was also hoped that the softer artificial atria would reduce venous compression.

Since the use of sutured atrial cuffs required the reversal of Heparin anticoagulation with protamine sulphate to prevent bleeding at the suture line, the arterial connectors were also changed to teflon from stainless steel to afford better antithrombogenicity.

The Mk V heart was implanted in 3, 60 kg. calves during November 1971. For the first time, cardiopulmonary bypass flows exceeded 50 cc/kg/min. due to the improved venous drainage. One of the animals recovered fully from the anesthesia (Fig. 3.9) and attempted to stand on several occasions.



Fig. 3.9 One calf lived for 8 hours with a Mk V device until a ventricle cracked. Recovery was good with spontaneous breathing and numerous attempts to stand up.

She could maintain normal blood gas tensions with air-mix assisted respiration and would breathe spontaneously unaided for short periods. The calf died after 8 hours of pumping due to a cracked left ventricle permitting aspiration of air into the left ventricle. Two of the animals died from acute pulmonary alveolar edema resulting from accidental elevated left atrial pressures.

Filling of the ventricles was improved, but as had been seen in earlier experiments, the pumping sacs operated in an end diastolic position with opposing sac walls rubbing each other. The rubbing of the sacs was suspected of causing the high rates of hemolysis as indicated by plasma hemoglobin levels in excess of 100 mg.%.
⑤

The fit of the artificial heart was good permitting easy closure of the chest. The air pressure driving tubes did however cause some difficulty in their positions coming through the midline incision. Occasionally, when in a kneeling position, the calf would crimp the pressure lines.

Although air aspiration at the atrial suture lines was not as prevalent as in the first implantations, postoperative bleeding was still a major concern. Several different styles of suturing cuff were tried to improve the anastomosis, but none were acceptable.

At post-mortem all internal parts of the hearts showed fibrin deposits and clot formation particularly around the valves and on the rubber surface.

3.5 Model Mk VI

The design changes of the Mk VI model were aimed at

reducing both the thromboembolic and hemolizing potential of the device. The molds were changed to incorporate a more spherical shape (Fig. 3.10) of the ventricles which were increased in volume (160 cc.) affording a larger residual volume at end diastole, reducing the possibility of opposing sac walls rubbing and causing excessive hemolysis. (Fig. 3.11) (Appendix A)

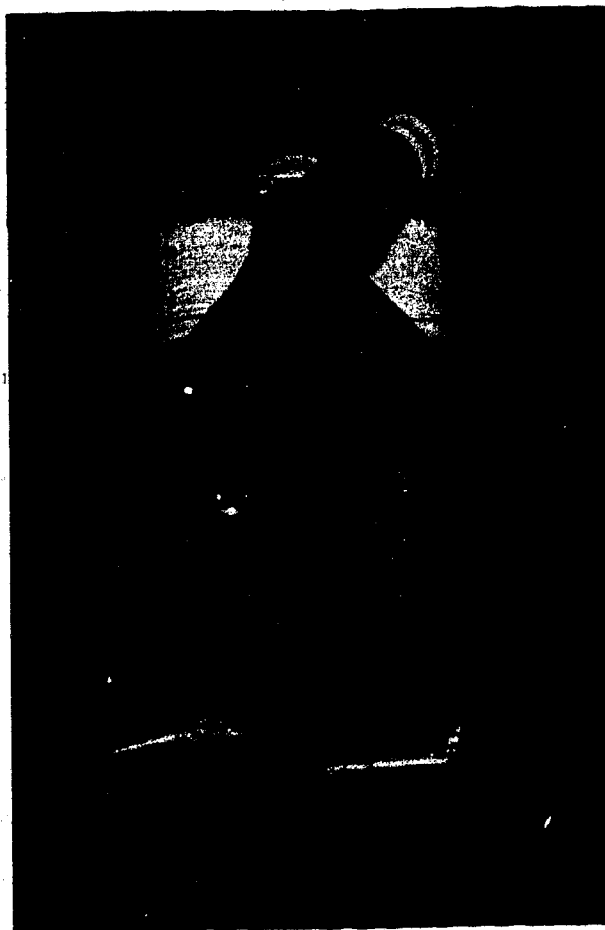

Fig. 3.10 Mk VI model with more spherical ventricles and brass connectors for air driving tubes, which would pass through one side of the heart.

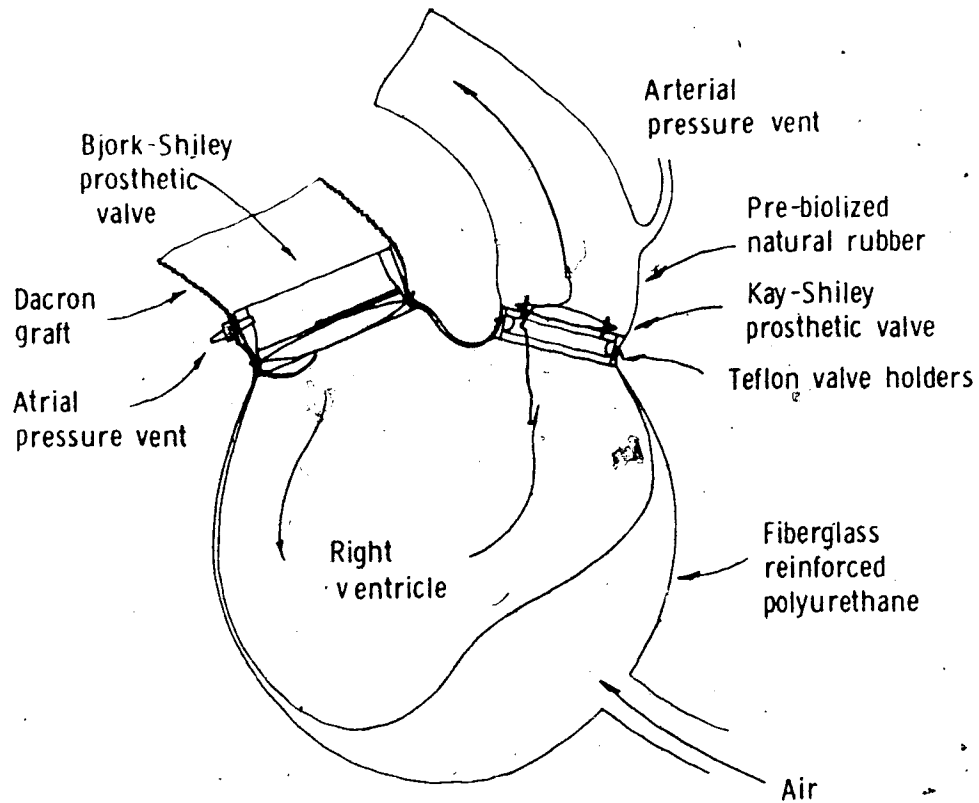

Fig. 3.11 Schematic of the Mk VI model.

New teflon valve holders also served as connectors to the dacron atrial cuffs. (Fig. 3.12)

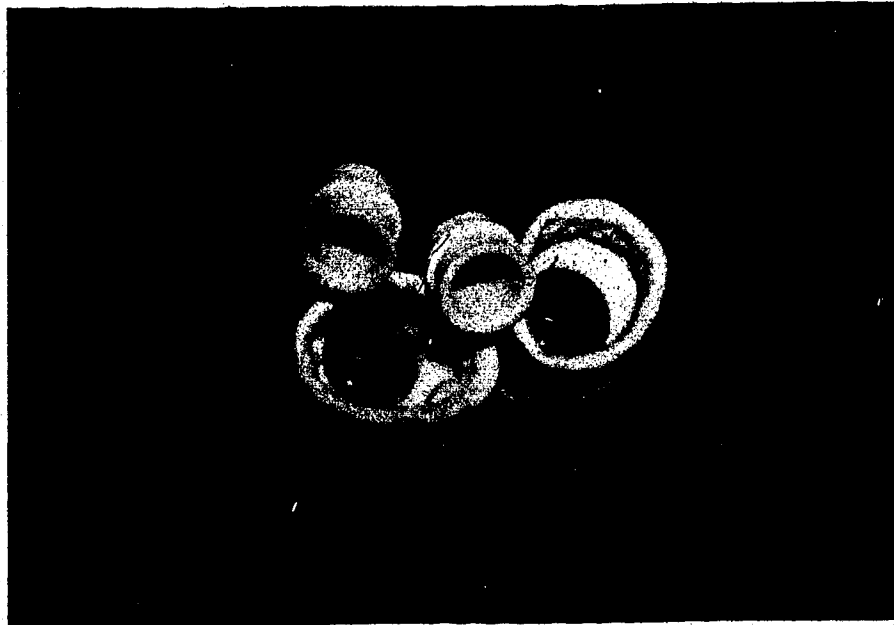

Fig. 3.12 Teflon valve holders used to connect atrial cuffs to the ventricles.

One of the major changes was the use of a special prebiolized natural rubber incorporating bonded Heparin and gelatin on the surface. In vitro the prebiolized rubber proved to be up to 10 times less thrombogenic than natural rubber alone. (Appendix B)

To avoid the complication of crimped air driving tubes, brass air tube connectors were fitted to the hearts allowing the tubes to be passed through one side of the chest instead of through the midline incision.

Since this model was the first to incorporate a change in ventricle volume it was expected to produce a different function curve and maximum output. (Fig. 3.13) The maximum output was increased to 13 liters per minute.

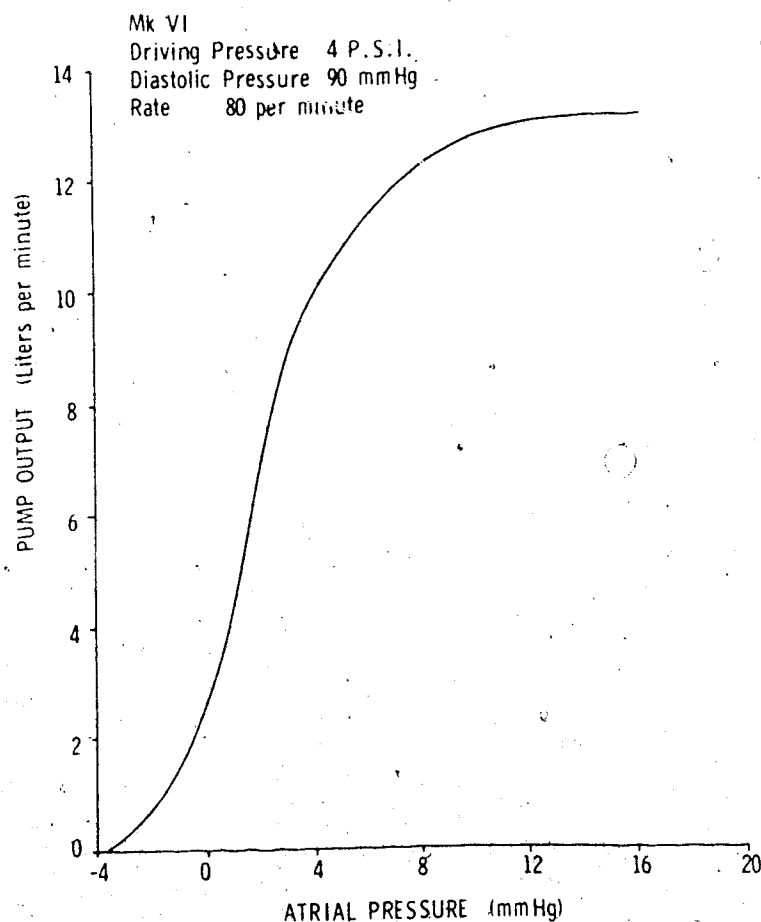

Fig. 3.13 Function curve for the Mk VI artificial heart.

From November 1971 until March 1972 the Mk VI models were implanted in the chests of 8 calves. (Fig. 3.14)



Fig. 3.14 The artificial heart fits well in the chest of an 80 kg. calf.

Survivals ranged from 4 to 33 hours. The four longest survivors were 18, 27, 31 and 33 hours. By that time the surgical procedure was becoming standardized and the longer survival times were focusing attention upon postoperative care. Three implantations were performed under hypothermia without cardiopulmonary bypass. All three calves experiencing this technique were sacrificed due to poor recovery and low cardiac output. (Appendix C)

To facilitate better postoperative control of the animals which would frequently attempt to stand, a specially designed cage was fabricated to support the animal and driving mechanism. (Fig. 3.15) With only head bars restraining the animal longitudinally it was free to move up and down at will. (Fig. 3.16)

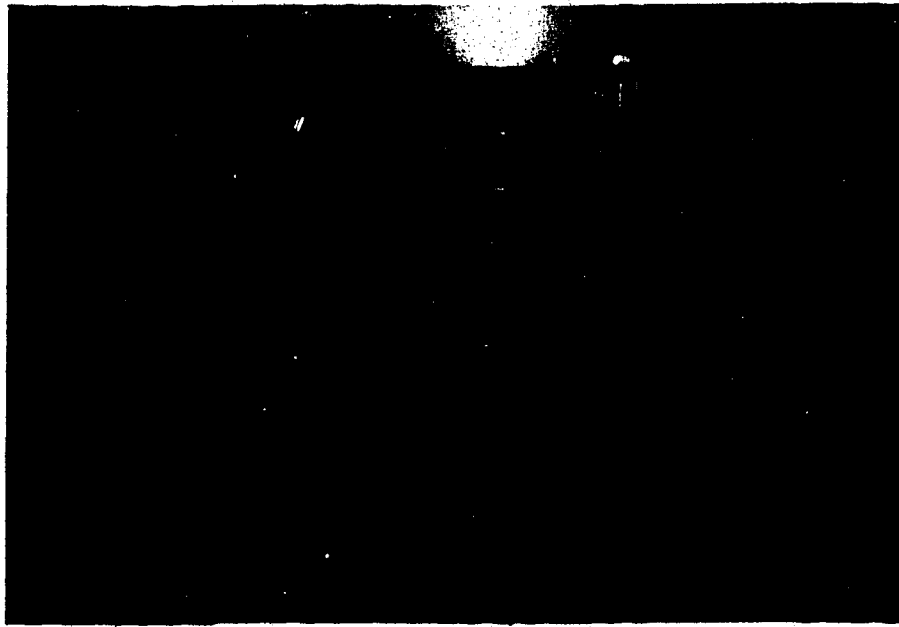

Fig. 3.15 Cage designed to support calf and control mechanism.

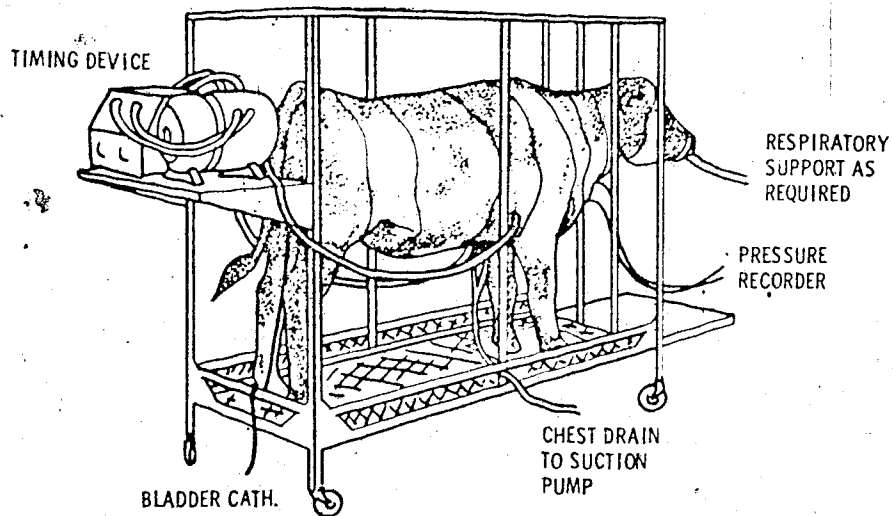

Fig. 3.16 Head restraint bars permit calf to stand up without interference. Calves with Mk VI devices lived for up to 33 hours.

To improve ventricular filling the timing device was modified to utilize slight vacuum during the diastolic phase of pumping. (Fig. 3.17, 3.18)

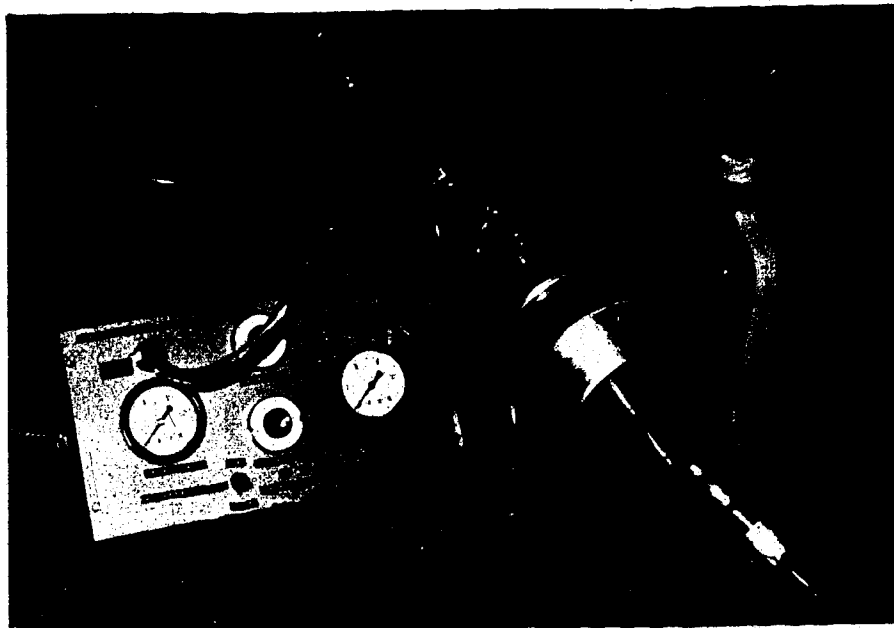

Fig. 3.17 The timing device was modified to utilize slight suction to the ventricles during diastole.

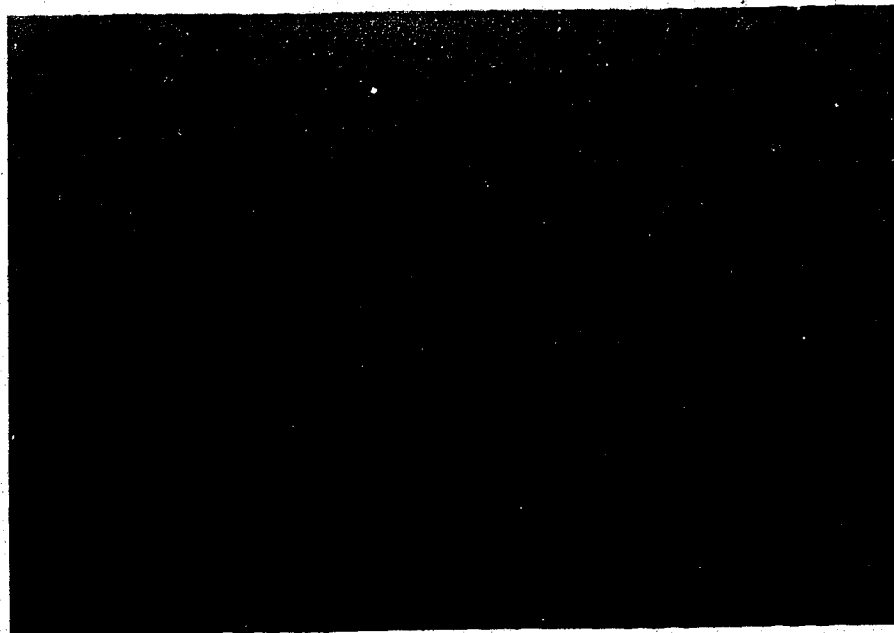

Fig. 3.18 8-10 mm.Hg of suction during diastole reduces atrial pressure by 4 mm.Hg, increases arterial pressure by 15 mm.Hg and increases pump output by improving ventricular filling.

The larger, more spherical ventricles of the Mk VI model lessened the degree of hemolysis and thrombosis but they still remained excessive. The problems with the longer survivors were becoming more of a materials nature. Longer survivors suffered convulsions caused by thrombo-emboli and died from progressive shock. (Fig. 3.19)

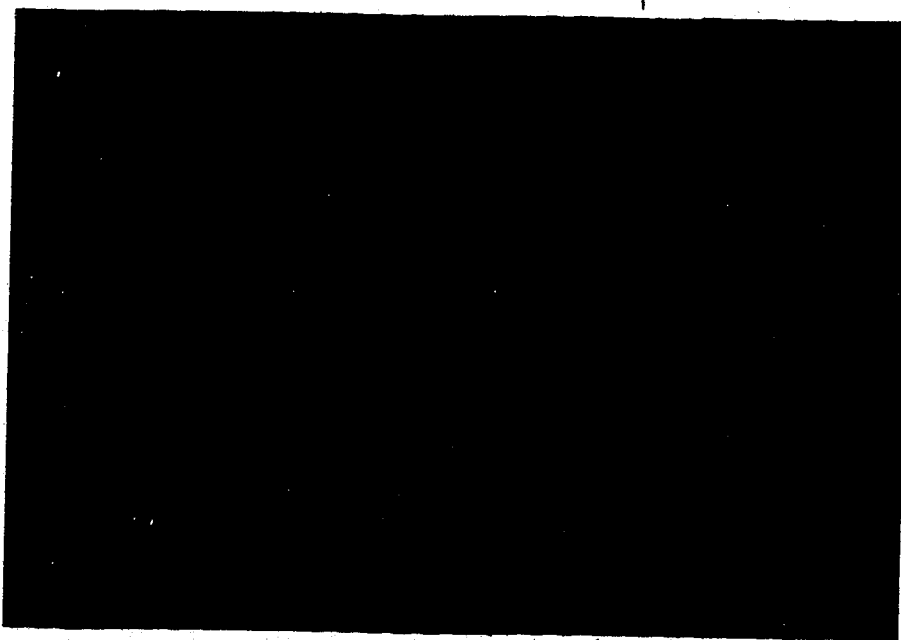

Fig. 3.19 Blood pressures from an 80 kg. calf showing progressive shock after 26 hours pumping with a Mk VI total replacement artificial heart.

The following report suggested that natural rubber was probably not such an ideal material for artificial heart fabrication.

POST-MORTEM EXAMINATION OF MK VI ARTIFICIAL HEART (D. MORRIS)
VENTRICLES #75 (LEFT) AND #76 (RIGHT) EXPERIMENT #7 JAN. 12, 1972

Following 33 hours of continual pumping, both sacs showed evidence of elongation causing wrinkles along the curved surfaces. At first this was thought due to possible "stretching" of the rubber during late systole. Theoretically, this explanation is invalid since the design exposes the sac to a very low tangential stress, thus tangential strains would not be great enough to cause creep or yielding of the rubber. It is more likely that the rubber swells as a result of its hydrophilic property. The rubber characteristically turns a mottled white color and loses its translucency when exposed to water for an extended period. When the ventricles were bisected the sacs protruded beyond the cut polyurethane edge indicating their swollen proportions. As the rubber dehydrated over the course of several days the sacs returned to their original proportions. The casing could be closed with no resulting wrinkles in the sac. Clearly, the expansion of the latex following extended exposure to blood is due to water absorption and not due to mechanical forces.

The sacs showed no evidence of fatigue. Very minor fibrin formation was noted at the unions between valve housings and sacs. A single red blood clot was found in each ventricle. In both left and right ventricles the clots were firmly attached to the sac and encapsulated by a very fine film resembling fibrin. The fibrin-like film extended to an area slightly larger than each clot. Each clot was in the distal apex of the ventricle. The clot in the left ventricle measured 2.5 x 3 cm. with a maximum thickness of 1 mm. The clot in the right ventricle measured 2 x 4.5 cm. of similar thickness.

This location is the most likely since it is an area of low flow and possible stasis. The stasis alone is, however, not the sole cause. It is most likely that the cause of the clot formation is the inadequate antithrombogenicity of the prebiolized natural rubber. Although the clots appeared well anchored to the surface of the sac it is likely that when large enough they would dislodge and become thromboemboli. It is also possible that the clots discovered were not the only ones that had formed during the 33 hours of pumping. These two drawbacks of natural rubber; hydrophilia and thrombogenicity, suggest that the material is not suitable for long term use in the cardiovascular system.

Besides the inadequacies of the natural rubber, there were still basic problems of organ failure, blood damage and poor venous return. Major target organs were the lung, the kidney and the brain.

3.6 Model Mk VII

Before abandoning natural rubber one more design was fabricated in an effort to increase pump output. The Mk VII heart was similar to the Mk VI with the exception that the outer casing was fabricated of natural rubber instead of polyurethane. (Fig. 3.20)

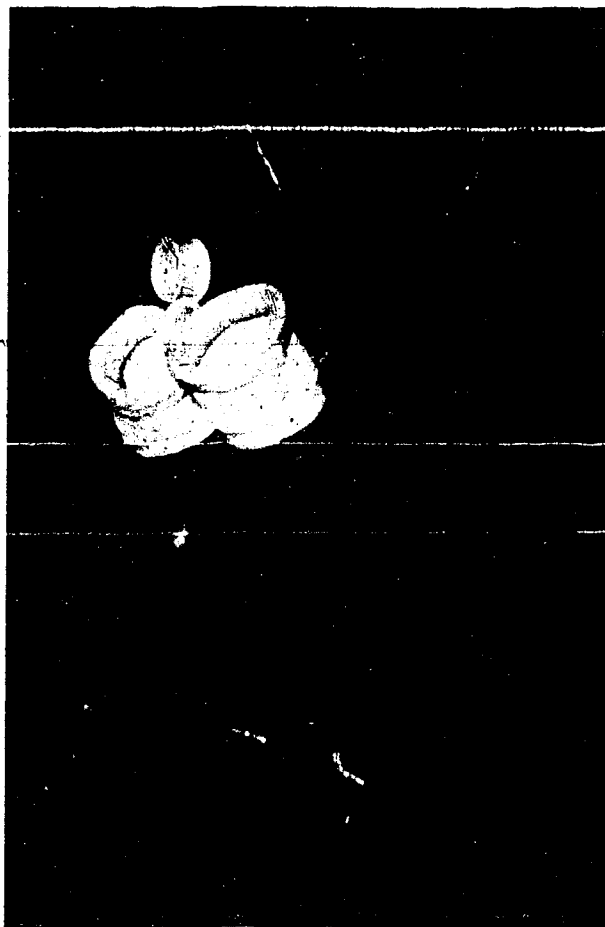

Fig. 3.20 Mk VII design was fabricated entirely from natural rubber but could not generate sufficient left ventricular pressure.

The design featured a flexibility intended to facilitate closing of the chest with less venous compression and to dampen the output pressure waveform. The relatively steep systolic $\frac{dp}{dt}$ of previous designs was suspected of contributing to the predominant pulmonary complications.

The heart was implanted in a 60 kg. calf in March, 1972. The output pressure recordings were damped, but the left ventricle was unable to generate sufficient pressure. The outer chamber was too elastic. The animal was sacrificed after 7 hours of pumping due to inadequate pump output and poor recovery.

3.7 Model Mk VIII

It became apparent that the natural rubber hearts all suffered from several deficiencies. They were:

handmade, requiring lengthy fabrication methods
susceptible to early fatigue failure
thrombogenic
and hemolytic.

The early fatigue potential demanded that hearts could be implanted only once. Up until this time, 86 complete ventricles had been fabricated. The thrombogenicity and the hemolytic potential appeared intrinsic to the material; natural rubber, and to a function of design; stagnation areas and rubbing of opposing sac walls.

Model Mk VIII was a prototype design intended to eliminate these inadequacies. The basic design was an air-driven diaphragm-type. (Fig. 3.21, 3.22)

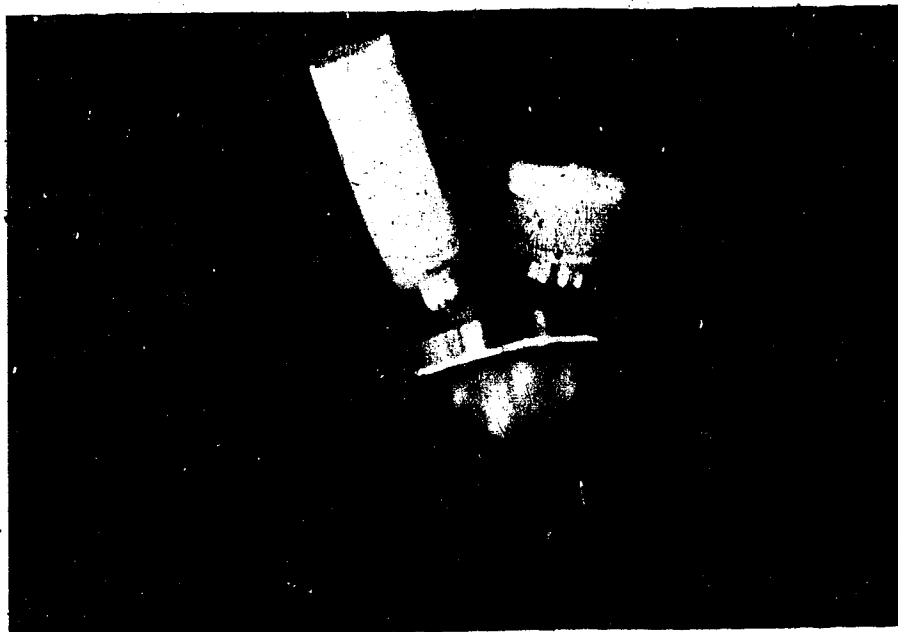

Fig. 3.21 Mk VIII air-powered diaphragm-type artificial heart.



Fig. 3.22 Components of the Mk VIII design.

The diaphragm was formed on an aluminum mold from uncured dacron-reinforced Silastic. (Fig. 3.23)

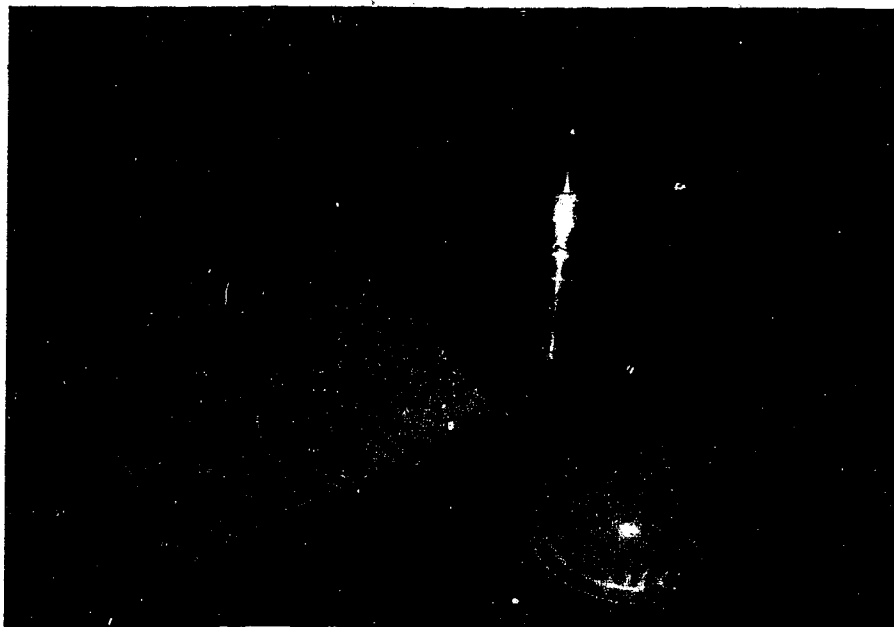

Fig. 3.23 Diaphragms were made by vulcanizing uncured Silastic on an aluminum mold.

The diaphragm passed over center from its plexiglass housing, but would not reach the opposing aluminum chamber housing the valves. The space between the diaphragm and housing at end diastole was designed to eliminate direct crushing of formed elements of the blood and to obviate stagnation areas. The device was fitted with teflon valve holders, a Kay-Shiley outlet valve and a Bjork-Shiley inlet valve.

The heart was tested on the mock circulation producing a stroke volume of 160 cc. and a maximum output of 13 liters per minute. The function curve relating to Starling's Law was dependent upon the thickness of the silastic diaphragm which was eventually established at 0.030". (Fig. 3.24)

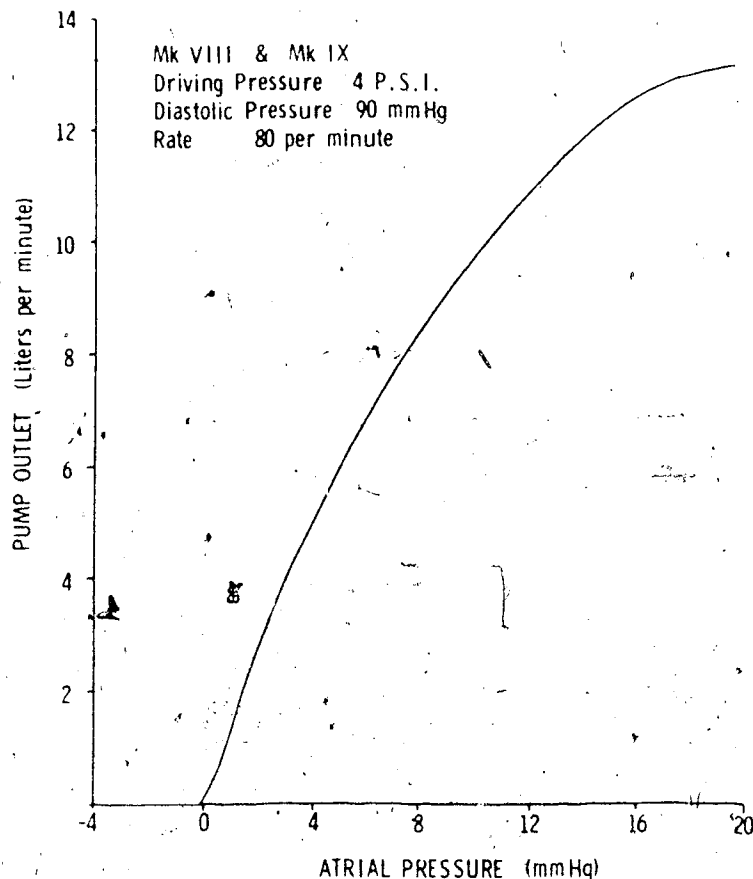

Fig. 3.24 Function curve for the Mk VIII and Mk IX diaphragm hearts.

The ventricle weighed 380 g. To be adapted for implantation it would have to be designed much lighter, more compact and with an anti-thrombogenic lining.

3.8 Model Mk IX

The implantation model of the prototype was fitted with dacron graft and velour atrial suturing cuffs, dacron graft and teflon arterial connectors and was lined inside with a thin coating of Silastic. (Fig. 3.25, 3.26)

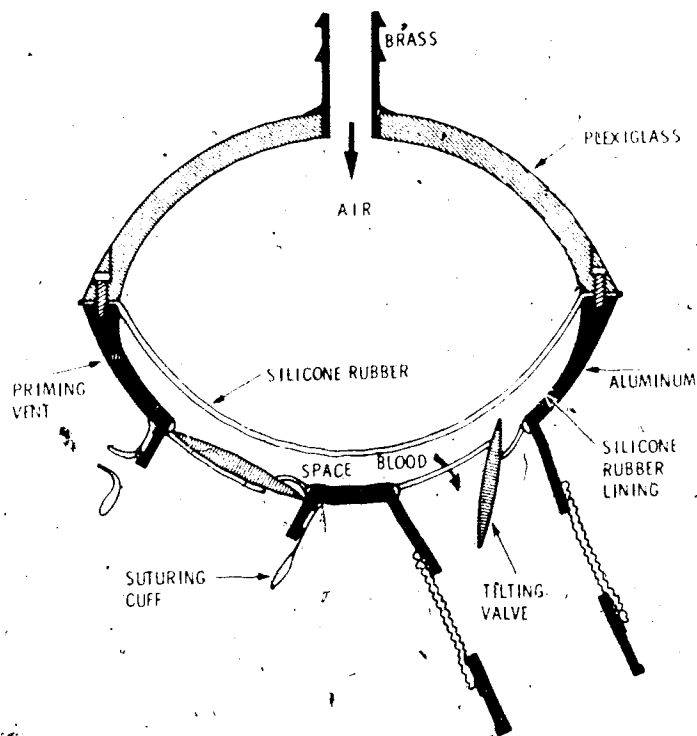

Fig. 3.25 Schematic of Mk IX artificial heart.

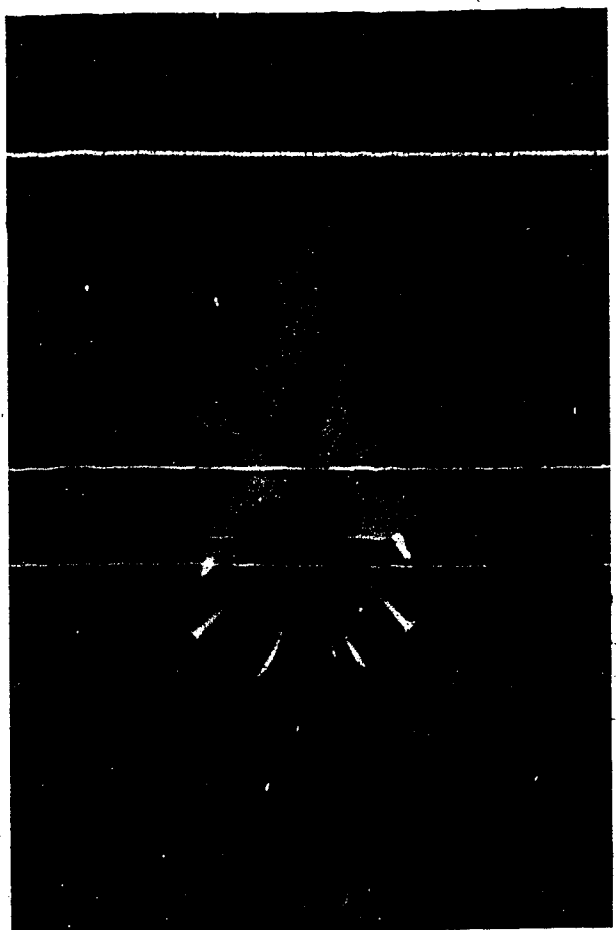

Fig. 3.26 Mk IX heart with dacron arterial and atrial grafts. One air driving tube passes through each side of the chest. This design was too wide to fit in the chest without causing venous compression.

The stroke volume remained at 160 cc. and the optimum rate at 80 beats per minute, but the weight was reduced to 400 g. Twelve small allen screws were used to secure the two halves together instead of the bulky screw ring of the prototype.

The device was implanted in nine calves from June, 1972 until September, 1972. Adequate spontaneous breathing was used as a criterion of survival and most animals were sacrificed by the ninth hour of pumping.

Complications included poor fit, difficulty in approximating the chest incision, venous compression, thrombosis and poor cardiac output.

The last five implantations were conducted utilizing removable atrial cuffs to improve the atrial anastomosis. (Fig. 3.27)

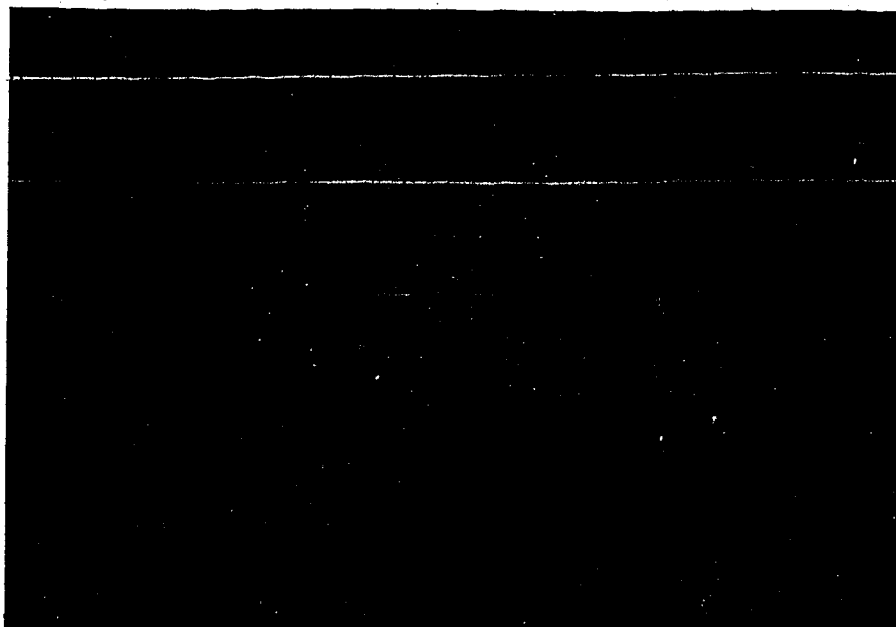

Fig. 3.27 Removable atrial cuffs permitted a more leakproof atrial anastomosis. Flaps were added to facilitate pulling the cuff upwards when connecting the ventricle to the atrium. Tubes are for pressure monitoring and priming.

Bleeding at the atrial suture line had always been a problem. The removable cuff permitted its inversion during suturing providing a more air-tight anastomosis. When returned to its normal position, the cuff was wired to the ventricle. A later model cuff included flaps to pull upon aiding fitting to the ventricle.

3.9 Model Mk X

Although the Mk IX model was more reliable, easier to make,

less thrombogenic and less hemolytic than the rubber hearts, it was too bulky and still produced unphysiological looking arterial pulses.

The Mk X heart was fabricated primarily of Silastic consisting of two concentric hemispheres, one within the other. (Fig. 3.28)

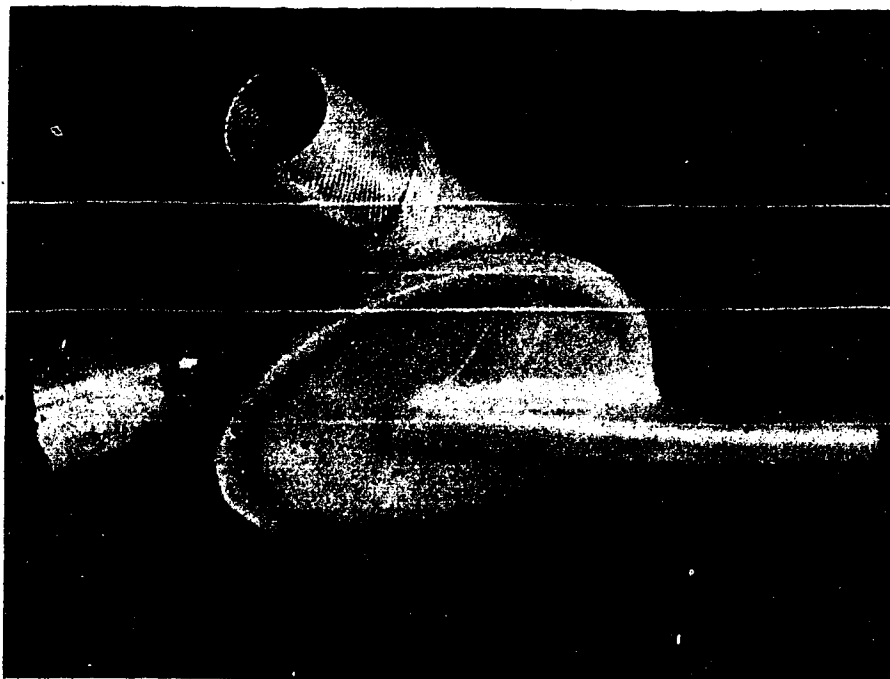

Fig. 3.28 Unsuccessful Mk X model designed to reduce the width of both ventricles. Toroidal valves were used,

When placed together, both sides would be much narrower than previous designs. With only a steel toroidal ring giving rigidity to the base, the output waveform was damped as expected, but the device could not withstand arterial pressures and was abandoned.

3.10 Model Mk-XI

In an attempt to strengthen while retaining the hemispherical shape of the Mk X design, an aluminum base was substituted for the Silastic base. (Fig. 3.29)

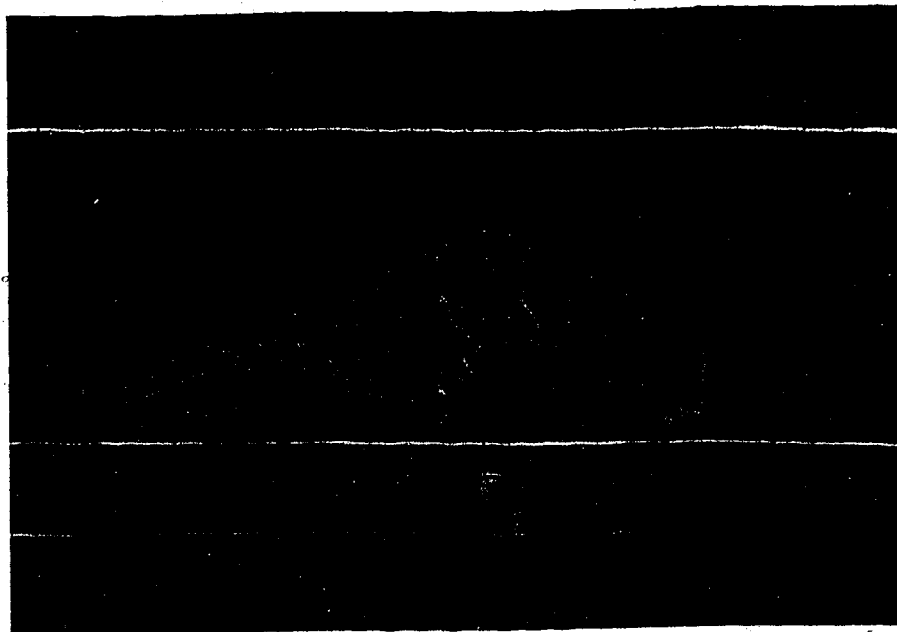

Fig. 3.29 Mk XI design had very low pump output.

The pump produced very low output and required excessively high filling pressures to adequately fill the ventricle. This design was also abandoned.

3.11 Model Mk XII

The Mk XII design was the last to be fabricated and implanted in calves. Many of its features are like the previous Mk IX model except that it is smaller, lighter and less thrombogenic. (Fig. 3.30, 3.31)

By reducing the stroke volume from 160 cc. to 85 cc. the rate could be increased from 80 to 95 beats per minutes. Maximum output was reduced to 8 liters per minute. (Fig. 3.32) The higher rate and smaller stroke volume appeared to flatten the systolic $\frac{dp}{dt}$ in the pulse wave pattern. Outlet and inlet valve holders and arterial connectors

were also lined with Silastic for improved antithrombogenicity. Each ventricle weighs only 135 g.



Fig. 3.30 Left ventricle of the Mk XII device showing removable atrial sewing cuff.



Fig. 3.31 The Mk XII model is much lighter and smaller than the previous model Mk IX.

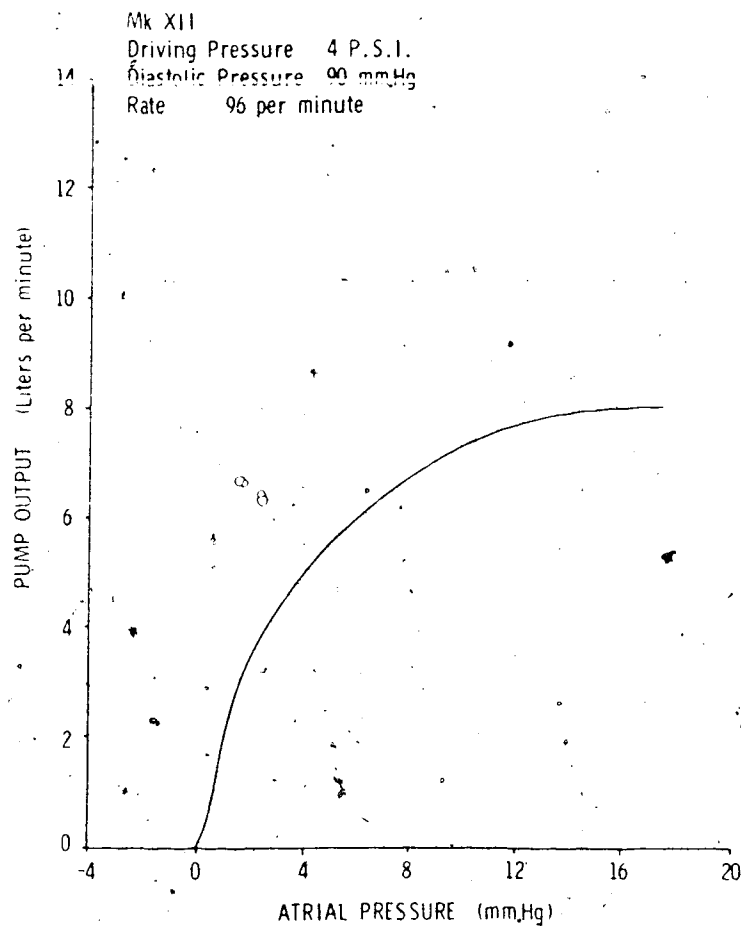

Fig. 3.32 Function curve for the Mk XII model with higher frequency.

The device has been implanted in four calves in September, October and November, 1972 with survivals to 33 hours. For these experiments, no blood pressures were measured from the artificial heart. It was suspected that some thromboemboli in earlier experiments were due to the occasional flushing of clotted pressure lines. Only carotid arterial and central venous pressures were monitored.

Two calves displayed the best postoperative conditions of any animals to date. Both made frequent attempts to stand, managing very erect kneeling positions. (Fig. 3.33)



Fig. 3.33 Calves with Mk XII artificial hearts experienced excellent recovery and survived for up to 33 hours.

One animal suffered a premature death when it kicked the left driving line which became disconnected from the ventricle. The other animal survived 33 hours and suffered a convulsion.

3.12 Artificial Heart Valves

Commercially available prosthetic valves were used in all models of artificial hearts. (Fig. 3.34) In the earlier sac-type hearts Kay-Shiley, Bjork-Shiley and Toroidal valves were used alternately. All these designs are excellent for use in artificial hearts due to their short excursion into the ventricles. In later sac-type models a combination was occasionally used with Bjork-Shiley valves for inlets and Kay-Shiley valves for outlets. The Bjork valves have a very low opening resistance which should assist passive ventricular filling. The Kay valves are very competent

and should also assist passive ventricular filling by preventing arterial reflux.

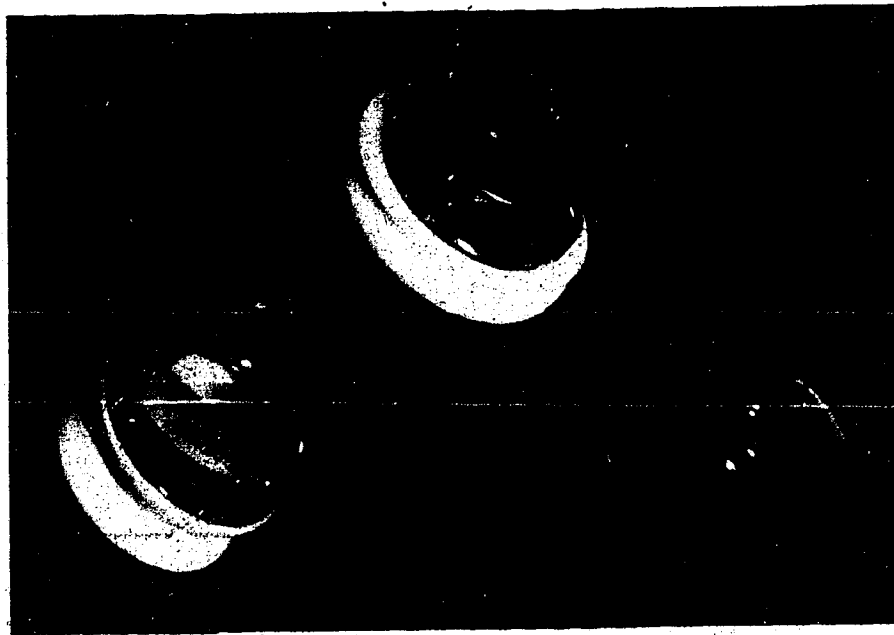

Fig. 3.34 Kay-Shiley, Toroidal and Bjork-Shiley prosthetic heart valves used in the artificial hearts.

In performance, there was little difference between hearts with different valves or combinations of valves. The only significant observation was that the Bjork valves were the least likely to attract thrombus or fibrin formation. The cage of the Kay-Shiley valve appeared to be the most likely site for finding fibrin strands.

In the diaphragm-type hearts, the Bjork-Shiley valves were used exclusively due to their configuration permitting the smallest diameter atrial and arterial connectors. Their flap-type design is also the least occlusive of the three valves.

CHAPTER IV

PHASE III - LIMITING FACTORS

4.1 Introduction

In order to evaluate the limiting factors of total heart replacement a series of the last 22 implantations was considered with the later model sac-type and diaphragm-type hearts. Four control experiments subjecting the animals to cardiopulmonary bypass only were conducted to evaluate pathological effects of the surgical procedure. The experiments were aimed at evaluating pulmonary function, renal function, hematological changes and vascular responses before, during and following total artificial heart replacement.

4.2 Methods

Surgical Procedure

The 22 total replacements were all performed using the same surgical procedure.

Animal and Presurgical Preparation

Calves weighing between 65 and 90 kg, were fasted for 48 hours preoperatively allowing only water and milk to drink to prevent postoperative bloating. Two million units of penicillin were given intramuscularly to the animals every other day for one week prior to each experiment. Blood for transfusion was obtained from a local slaughterhouse and stored in ACD containers (anticoagulant citrate phosphate dextrose solution) to which one million units of penicillin

per liter of blood was added. Trifluopromazine (0.2 mg/kg.) and Atropine (0.02 mg/kg.) were given intramuscularly to the animal for premedication.

Anesthesia

Thirty minutes after premedication anesthesia was induced with halothane. A conical face mask and partial rebreathing system with 2-3% halothane and 7-10 L/min. of oxygen was used. (Fig. 4.1)



Fig. 4.1 Calves are anesthetized with halothane and oxygen.

The animal was then placed on its back on the operating table and an endotracheal tube was inserted. Before the chest was opened, anesthesia was maintained with 0.5-1.5% halothane and spontaneous respiration. Once the chest was opened, the lungs were mechanically ventilated by an Engstrom Respirator Model 200. Tidal volume was set at 750 ml. with a respiratory rate of 18 to 20 times per minute.

Establishment of Cardiopulmonary Bypass

The surgical field was shaved, washed with 3% Hexachlorophene and painted with 10% Providone-Iodine N.F. The left external jugular vein and carotid artery were exposed for later insertion of cardiopulmonary bypass cannulae. The left subscapular artery and vein were exposed, and used for arterial pressure monitoring and for an infusion line. The chest was entered through a midline sternotomy. Umbilical tapes were passed around the superior vena cava, inferior vena cava, azygous vein, hemiazygous vein, pulmonary artery and the aorta. Heparin (4 mg/kg.) was given intravenously prior to insertion of the venous cannulae. A #28 Bardic catheter was inserted into the left external jugular vein and positioned in the superior vena cava. A #40 Bardic catheter was inserted into the inferior vena cava through the right atrial appendage. A #20 Bardic catheter placed in the left common carotid artery was used for arterial inflow.

Either a Bentley or a Travenol adult disposable oxygenator with a Sarns modular pump was used for cardiopulmonary bypass (Fig. 4.2)

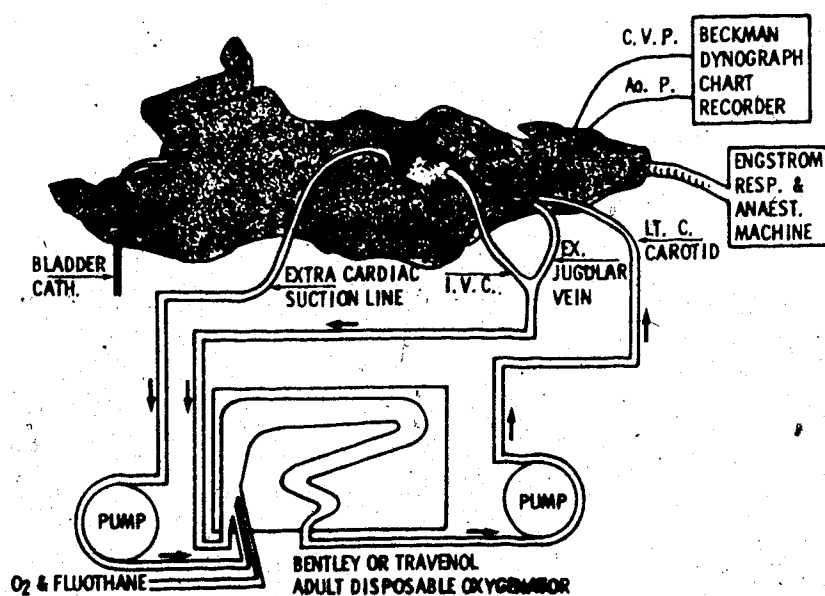

Fig. 4.2 Cardiopulmonary bypass circuit.

The oxygenator and circuit were primed with 1500 to 2000 ml. of either 5% dextrose in water or Ringer's solution for a hemodilution factor of 16 to 21%. Blood flow to and from the heart was interrupted by occluding the vessels with the umbilical tapes passed through Tygon tourniquets. The pump flow rate was usually 50 to 60 ml/kg/min. with about 60 cm. of gravity drainage to the heart-lung machine. Total bypass time was between 60 and 90 minutes. During cardiopulmonary bypass, the lungs were manually inflated with a pressure of 30 cm. H₂O every 10 minutes. Ventilation was reinstated with 100% oxygen about five minutes before the start of artificial heart pumping.

Resection of the Natural Heart

After blood flow to and from the heart was interrupted, the apex of the heart was grasped by a large Kocher's forcep. The left and right ventricles were incised at the apex, and the blood in both ventricles was aspirated. (Fig. 4.3)



Fig. 4.3 Ventricles are excised and trimmed at the atrio-ventricular groove.

Most of the ventricular muscle was quickly excised. The pulmonary artery was resected near the pulmonary valve. The remaining ventricular muscle and fatty tissue was carefully excised along the atrio-ventricular groove. The aorta was then resected near the aortic valve, being careful to gently separate the aorta from the right atrium. (Fig. 4.4) Perforation of the right atrial wall was a major risk.

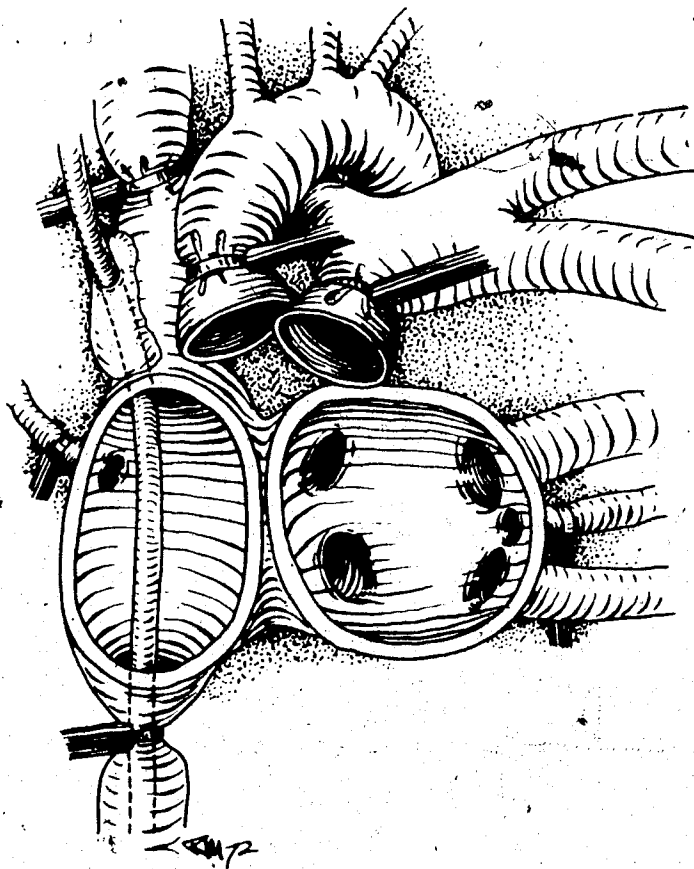

Fig. 4.4 Posterior remnants of the atria, aorta, and pulmonary artery following resection of the natural heart.

Insertion of the Artificial Heart

Before insertion the atrial suturing cuffs and dacron graft arteries were pre-clotted with fresh blood collected prior to heparinization. (Fig. 4.5)

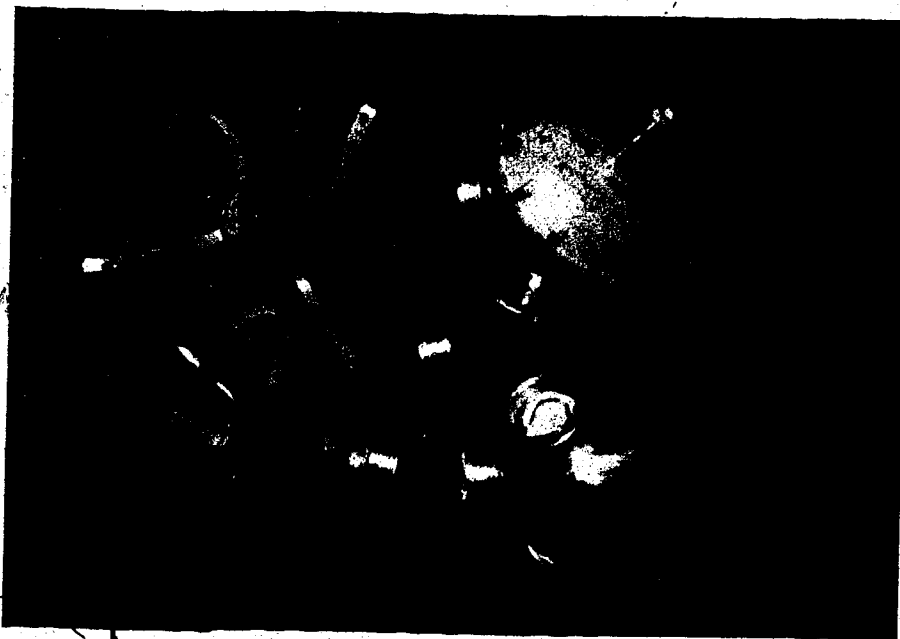

Fig. 4.5 Prior to insertion the atrial and arterial grafts are pre-clotted with fresh unheparinized blood.

The atrial cuffs which were separate from the ventricles were inverted into the atria. The rims of the natural atria and the cuffs were then held together with four or five Allis' forceps and sutured in a continuous manner with 000 Mersiline. After completing the right and then the left anastomosis, four flaps attached to the free edge of each atrial cuff were grasped by Pean's forceps and pulled upward everting the cuffs to a normal position. (Fig. 4.6)

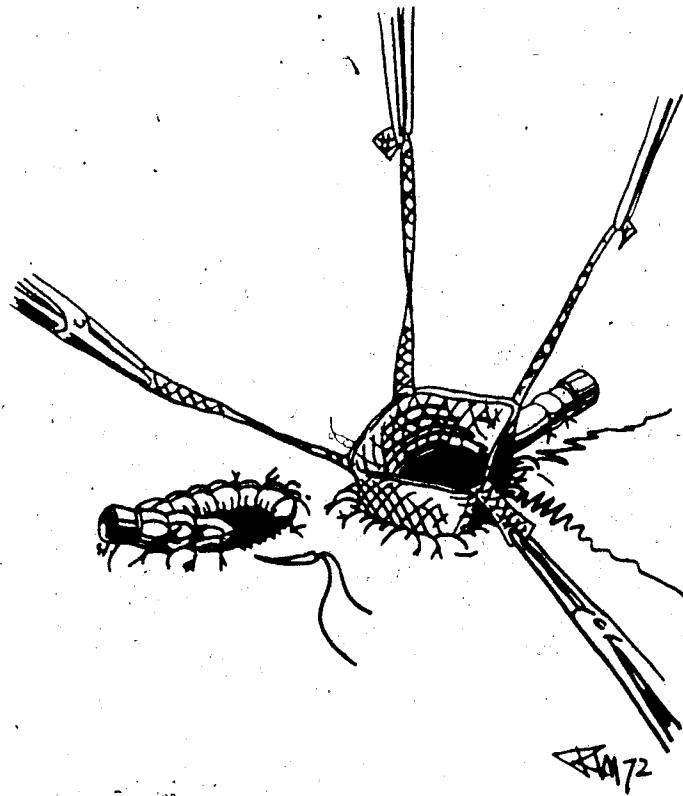

Fig. 4.6 The atrial cuffs are sutured in place in an inverted position and then turned out ready for connection to the ventricles.

Each ventricle and atrium was connected by inserting the ventricle valve supporter into the atrial cuff and wiring them together.

(Fig. 4.7, 4.8) After both ventricles were secured (Fig. 4.9) the artificial and natural aorta were anastomosed by tying the vessels over a rigid aluminum connector (Fig. 4.10) The natural and artificial pulmonary artery were joined in a similar fashion.



Fig. 4.7 The left ventricle is lowered into the atrial cuff.

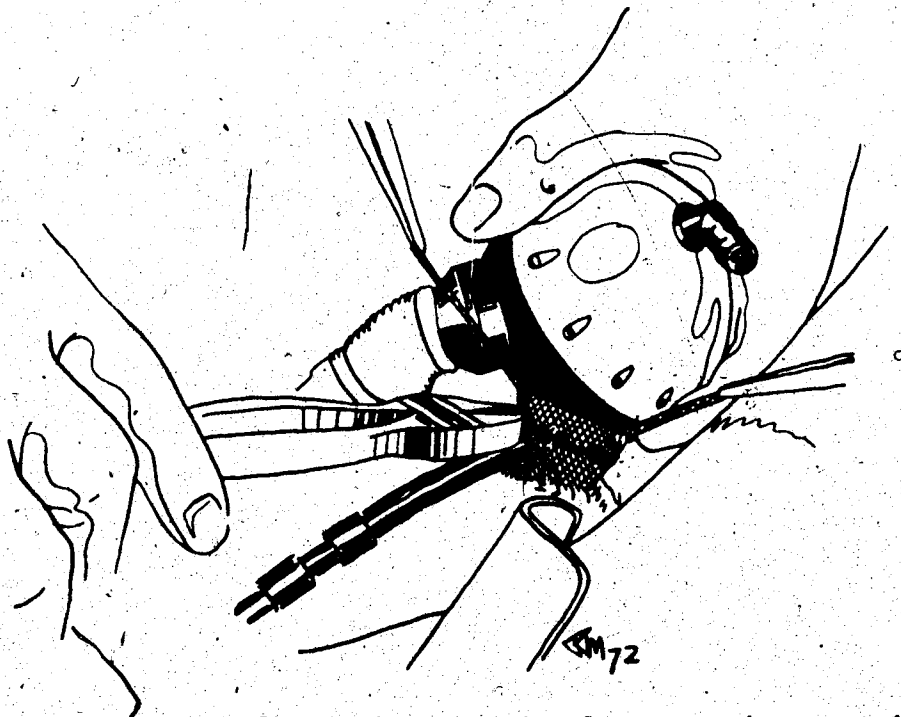

Fig. 4.8 The atrial cuff is wired in place over its ventricle.

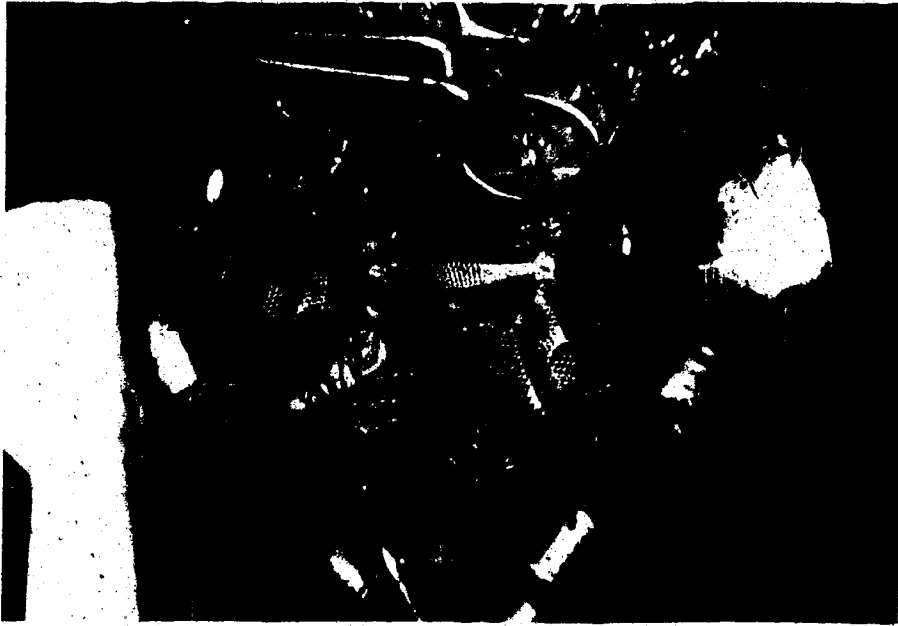

Fig. 4.9 Both atria are anastomosed before making arterial connections.

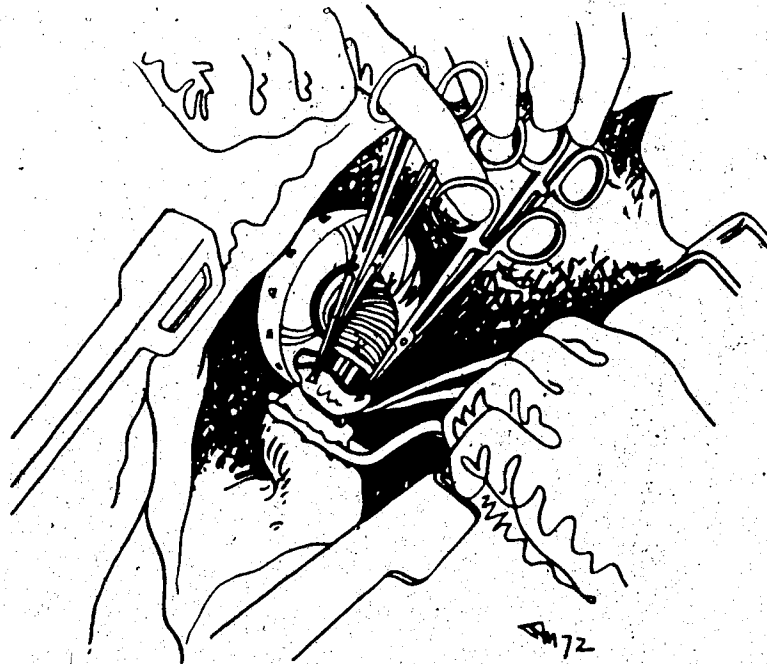

Fig. 4.10 Umbilical tapes are used to tie the natural vessels over the arterial connectors.

The driving lines were passed through stab incisions in the chest wall and one end of each line was attached to the driving system of the artificial heart.

Priming and Pumping with the Artificial Heart

After completing the anastomoses, the lines to the atrial pressure transducers were used for priming the heart with ACD blood.

(Fig. 4.11)

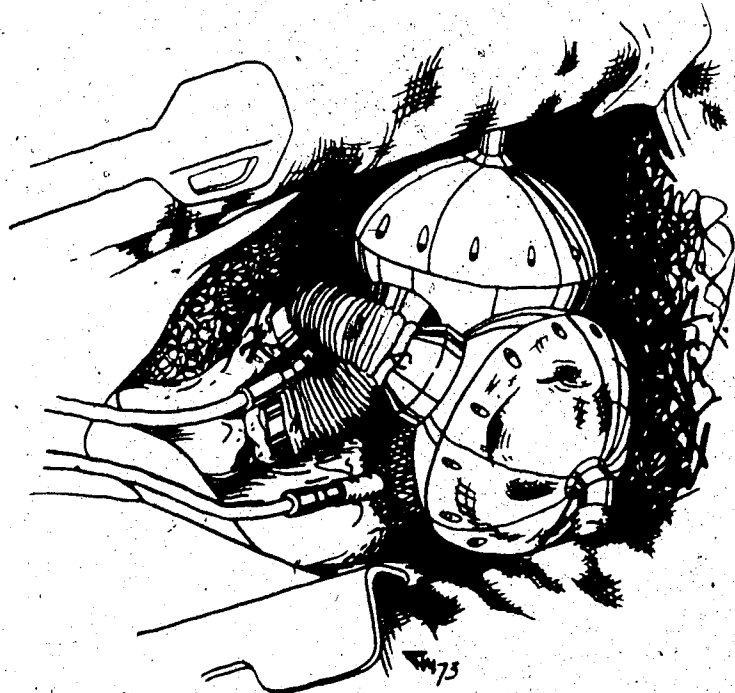

Fig. 4.11 Artificial heart connections complete and pumping begins.

The air vents placed at the top of each artificial ventricle were screwed closed after the artificial heart was completely primed and all air was evacuated. As soon as both ventricles were fully primed, the tourniquets around the veins were released and the aortic clamp removed. The left ventricle was begun at low pressure and slow rate. The pulmonary artery clamp was then gradually released, and the right ventricle was started at a low pressure. The right atrial pressure was maintained above 0 mm.Hg to avoid the aspiration of air through the anastomosis. The superior vena caval catheter was clamped and the pulmonary artery clamp was completely released. The pump pressure and frequency were gradually increased as cardiopulmonary bypass flow

was reduced. Finally, the inferior vena caval catheter was clamped to increase the right atrial pressure. Residual fluid in the cardiopulmonary bypass circuit was gradually infused into the animal until an arterial mean pressure of 70 to 100 mm.Hg could be maintained or the right and left atrial pressures remained above 0 mm.Hg. After the animal's condition was stabilized and further blood administration was unnecessary, the venous and arterial lines of the cardiopulmonary bypass were removed. (Fig. 4.12)

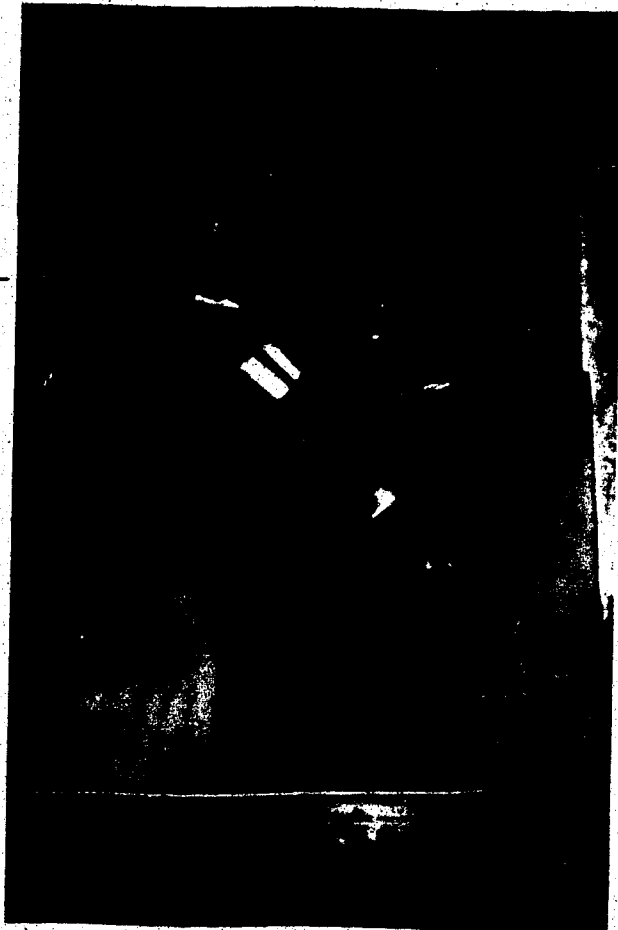

Fig. 4.12 Implantation of a MkXII device with no pressure monitoring lines.

Postsurgical Treatment

Protamine sulphate was given intravenously in a dose of 6 mg/kg. or until the whole blood clotting time returned to between 8 and 12 minutes. Two chest tubes were inserted into the pleural space and connected to chest suction. The sternum was approximated with stainless steel wire sutures and the chest wall was closed in two layers. Intermittent heavy silk sutures were used in the skin, in an area where the sternum could rub on the cage. The animal was transferred to a specially constructed mobile cage in the kneeling position. (Fig. 4.13)

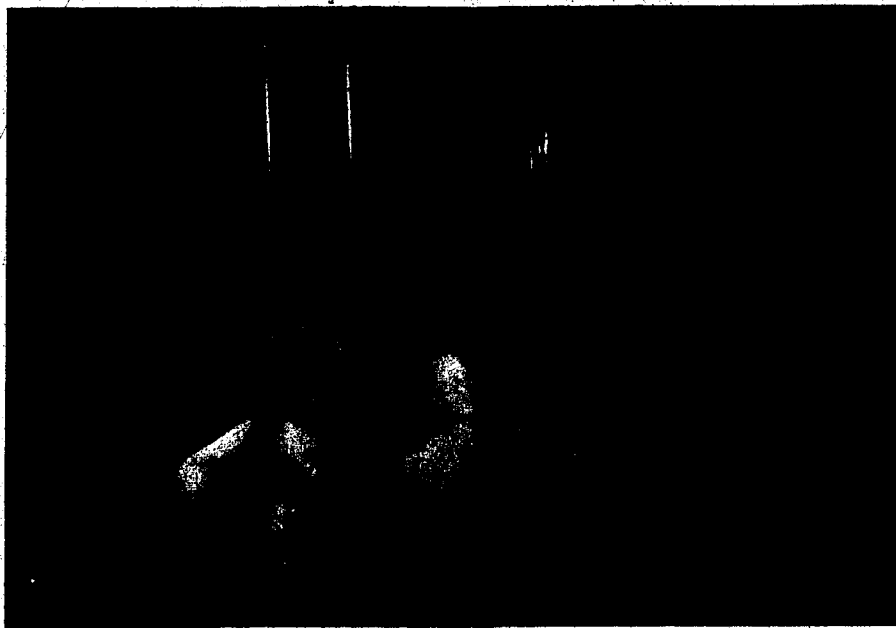

Fig. 4.13 Calf in mobile cage is able to move up and down restrained only by head bars.

Respiratory assistance was continued as necessary to maintain acceptable levels of arterial oxygen saturation. Intravenous fluids and blood were given to the animal as occasion demanded.

The four control experiments included an identical surgical procedure to that used for total heart replacement excluding only the excision of the natural heart and replacement with an artificial device. An average bypass time of 70 minutes was used for the control animals.

Biochemical Analysis

All 26 animals were subjected to the following biochemical tests before cardiopulmonary bypass, immediately after cardiopulmonary bypass and every two hours thereafter: arterial and venous pO_2 , pCO_2 and pH, plasma hemoglobin, hemoglobin, hematocrit, platelet count, W.B.C. count, R.B.C. count, total protein, glucose level, histamine level, and whole blood clotting time. In addition to these routine tests, some of the calves were tested for cardiac output, lactic acid, pyruvic acid, L.D.H., serum electrolytes Na^+ , K^+ , Cl^- , and Ca^{++} , S.G.O.T. albumin/globulin ratio, B.U.N., creatine, bilirubin, prothrombin time, partial thromboplastin time and fibrinogen levels.

4.3 Results and Postoperative Events

The 22 implantations included 9 using natural rubber hearts, 9 using the first model Mk IX diaphragm heart and 4 with the latest Mk XII diaphragm design.

Since the longest survivor reached 33 hours, the controls that survived were sacrificed at 33 hours.

The results will then include three groups with different artificial heart models and one group of controls. Including three groups of heart design will permit not only an evaluation of limiting

factors common to all three designs but will also demonstrate the improvements in results obtained with the newer models.

Animals with artificial hearts followed three distinct patterns of postoperative recovery and behavior.

The first pattern was that followed by animals experiencing death either during surgery or before the chest was closed and the calf was placed in the cage. The usual cause of death was acute pulmonary complications. None of these animals recovered from the anesthesia and all produced large volumes of frothy blood tinged pulmonary edema at which time they were sacrificed.

The second pattern of recovery included those animals that lived for about eight hours postoperatively which were sacrificed due to low cardiac output, metabolic acidosis and secondary deterioration of the lungs. These calves would wake up slowly but would rarely make any attempt to move in the cage. They would often have their eyes open but were disinterested in activities around them and were quite insensitive to touch. Their cardiac output was always very low, being less than 2 liters per minute. Urination was usually nil or very slight. In some cases the animals could breathe spontaneously but would not maintain a satisfactory arterial blood oxygen tension without respiratory support. The experiments were terminated when the calves entered a pattern of irreversible shock with a widening of the pulse pressure, a drop in diastolic blood pressure and a progressive drop in pH and arterial pO_2 .

The third pattern of recovery was followed by those animals surviving for more than 8 hours. These animals would awake from the anesthesia rapidly, would soon lift their heads and would show interest

in activities around them. Within the first few hours they would develop good urination and could breathe spontaneously with at least 400 cc. tidal volume. Cardiac output was at least 4 liters per minute and with the help of a tracheal oxygen supply the calves could maintain blood gases within normal limits. After about eight hours of pumping they would begin chewing, pass feces on occasion and would all make frequent attempts to stand up in the cage. Sometimes they were able to straighten their legs momentarily, but none could maintain a normal standing position. Most commonly, they would hold up their heads looking from side to side in a kneeling position. Without warning these animals would convulse, stretching out their limbs and tightening their neck muscles. Their eyeballs would rotate either upward or downwards or vibrate. The convulsions would last about one minute followed by a general relaxation. In some cases, minor convulsions were followed by more severe convulsions of greater frequency and duration. These animals finally developed metabolic acidosis, progressive diastolic hypotension and deterioration of pulmonary function. Animals that died from a first major convulsion maintained acceptable levels of arterial pO_2 and blood pressure with spontaneous breathing until their deaths.

The four controls followed four different patterns of recovery; the three seen in animals with artificial hearts and one other. One calf died during surgery from acute pulmonary edema. One calf lived for 24 hours and died from metabolic acidosis. Two of the calves survived for 33 hours, one with respiratory support and one without. The animal requiring respiratory support experienced a very poor recovery and convulsions while the other recovered well

and was able to stand unaided until the experiment was terminated.

The following tables summarize the major postoperative events for the 22 total heart transplantations and four bypass controls.

A complete record of three 33 hour experiments; implantations with sac and diaphragm hearts and one control bypass can be seen in

Appendix D.

TABLE I SUMMARY OF 22 TOTAL HEART REPLACEMENTS

EXP. #	1	2	3
SEX	F	M	F
WT. (kg.)	60	60	60
HEART MODEL	MK. V, #63, 64 Sac	MK. V, #65, 66 Sac	MK. V, #65, 66 Sac
BYPASS FLOW (c.c./kg./min.)	35-50	37-44	34-55
BYPASS TIME (min.)	70	85	70
PL. Hb. (mg.%) PRE-OP.	1	3	1
POST-OP. MAX.	111		
POST-OP. MIN.	6		
PLATELETS (x 10 ³ /c.mm.) PRE-OP.	548	300	424
POST-OP. MAX.	178		
POST-OP. MIN.	64	80	
SKIN TO SKIN (min.)	290		
SURVIVAL TIME (hrs.)	6	<1	<1
CAUSE OF DEATH	Cracking of left ventricle	Occluded left air pipe	Acute pulmonary edema
POST-OP. CONDITION	Good urination, attempted to stand	Acute pulmonary congestion	
NOTABLE PATHOLOGY			Pneumonia

SUMMARY OF 22 TOTAL HEART REPLACEMENTS (continued)

EXP. #	4	5	6
SEX	M	M	M
WT. (kg.)	60	48	55
HEART MODEL	MK. VI, #67, 68 Sac	MK. VI, #69, 70 Sac	MK. VII, #73, 74 Sac
BYPASS FLOW (c.c./kg./min.)	50-66	50-80	52-64
BYPASS TIME (min.)	68	64	72
PL. Hb. (mg.%) PRE-OP.	2	2	1
POST-OP. MAX.	37	67	45
POST-OP. MIN.	17	15	23
PLATELETS (x 10 ³ /c.mm.) PRE-OP.		485	850
POST-OP. MAX.	342	266	228
POST-OP. MIN.	228	34	156
SKIN TO SKIN (min.)	240	270	262
SURVIVAL TIME (hrs.)	18	22	7
CAUSE OF DEATH	Convulsion	Convulsion	Sacrifice, low cardiac output
POST-OP. CONDITION	Good urination, attempted to stand	Good urination, attempted to stand	Poor
NOTABLE PATHOLOGY	Lung congestion Cerebral thrombi	Renal infarction, severe lung con- gestion & edema, Cerebral thrombi	Lung hepatization

SUMMARY OF 22 TOTAL HEART REPLACEMENTS (continued)

EXP. #	7	8	9
SEX	M	M	M
WT. (kg.)	55	80	85
HEART MODEL	MK. VI, #75, 76 Sac	MK. VI, #81, 82 Sac	MK. VI, #82, 83 Sac
BYPASS FLOW (c.c./kg./min.)	50-55	50	52
BYPASS TIME (min.)	76	87	64
PL. Hb. (mg.%) PRE-OP.	6	2	22
POST-OP. MAX.	108	46	229
POST-OP. MIN.	12	15	44
PLATELETS (x 10 ³ /c.mm) PRE-OP.	540	656	450
POST-OP. MAX.	230	154	192
POST-OP. MIN.	50	64	92
SKIN TO SKIN (min.)	245	248	
SURVIVAL TIME (hrs.)	33	31	8
CAUSE OF DEATH	Convulsion, Pulmonary edema	Convulsion	Sacrifice
POST-OP. CONDITION	Good urination, attempted to stand	Chewing, good recovery	Poor, low cardiac output
NOTABLE PATHOLOGY	D.I.C., L.N.N. Lung congestion & edema, cerebral hemorrhage	D.I.C., L.N.N. Lung congestion Pulmonary throm- boembolism, cerebral hemorrhage	Pulmonary congestion

SUMMARY OF 22 TOTAL HEART REPLACEMENTS (continued)

EXP. #	13	14	15
SEX	M	F	M
WT. (kg.)	75	70	80
HEART MODEL	MK. IX Diaphragm	MK. IX Diaphragm	MK. IX Diaphragm
BYPASS FLOW (c.c./kg./min.)	50-53	40	50-56
BYPASS TIME (min.)	86	85	89
PL. Hb. (mg.%)			
PRE-OP.	4	3	0
POST-OP. MAX.	40	78	86
POST-OP. MIN.	27	55	54
PLATELETS (x 10 ³ /c.mm.)			
PRE-OP.	766	664	620
POST-OP. MAX.	240	190	42
POST-OP. MIN.	124	144	42
SKIN TO SKIN (min.)	300		260
SURVIVAL TIME (hrs.)	6	4	4
CAUSE OF DEATH	Sacrifice	Sacrifice	Air embolism
POST-OP. CONDITION	Low cardiac output, metabolic acidosis	Chest too small to close	Low cardiac output, poor recovery
NOTABLE PATHOLOGY	Lung edema, Perivascular hemorrhage		Air embolism, liver congestion, lung edema

SUMMARY OF 22 TOTAL HEART REPLACEMENTS (continued)

EXP. #	16	17	18
SEX	M	M	M
WT. (kg.)	82	85	110
HEART MODEL	MK. IX Diaphragm	MK. IX Diaphragm	MK. IX Diaphragm
BYPASS FLOW (c.c./kg./min.)	45-49	60	50
BYPASS TIME (min.)	90	81	68
PL. Hb. (mg.%)			
PRE-OP.	33	22	9
POST-OP. MAX.	39	37	113
POST-OP. MIN.	39	37	46
PLATELETS (x 10 ³ /c.mm.)			
PRE-OP.	610	660	658
POST-OP. MAX.	200		198
POST-OP. MIN.	200		142
SKIN TO SKIN (min.)			270
SURVIVAL TIME (hrs.)	2	1	8
CAUSE OF DEATH	Sacrifice	Sacrifice	Sacrifice
POST-OP. CONDITION	Post-op. bleeding	Poor, anoxic convulsion	Poor recovery, Low C.O., metabolic acidosis
NOTABLE PATHOLOGY		Perivascular hemorrhage	Perivascular hemorrhage, renal infarction, pulmonary edema, thromboembolism

SUMMARY OF 22 TOTAL HEART REPLACEMENTS (continued)

EXP. #	19	20	21
SEX	M	F	F
WT. (kg.)	95	95	92
HEART MODEL	MK. IX Diaphragm	MK. IX Diaphragm	MK. IX Diaphragm
BYPASS FLOW (c.c./kg./min.)	23-53	31-35	54
BYPASS TIME (min.)	68	80	120
PL. Hb. (mg.%)			
PRE-OP.	3	3	
POST-OP. MAX.	40	41	
POST-OP. MIN.	32	17	
PLATELETS (x 10 ³ /c.mm.)			
PRE-OP.	560	448	
POST-OP. MAX.	122	228	
POST-OP. MIN.	100	100	
SKIN TO SKIN (min.)	248	220	325
SURVIVAL TIME (hrs.)	9	9	2
CAUSE OF DEATH	Sacrifice	Sacrifice	Pulmonary edema
POST-OP. CONDITION	Poor recovery, low cardiac output	Poor recovery, low cardiac output, metabolic acidosis	
NOTABLE PATHOLOGY	Pulmonary congestion & edema, perivascular hemorrhage	Perivascular hemorrhage, lung edema	Perivascular hemorrhage, L.N.N.

SUMMARY OF 22 TOTAL HEART REPLACEMENTS (continued)

EXP. #	22	23
SEX	M	M
WT. (kg.)	82	81
HEART MODEL	MK. XII Diaphragm	MK. XII Diaphragm
BYPASS FLOW (c.c./kg./min.)	66	50
BYPASS TIME (min.)	79	66
PL.Hb. (mg.%)		
PRE-OP.	3	4
POST-OP. MAX.	41	56
POST-OP. MIN.	17	28
PLATELETS (x 10 ³ /c.mm.)		
PRE-OP.	610	
POST-OP. MAX.	244	252
POST-OP. MIN.	200	144
SKIN TO SKIN (min.)	275	267
SURVIVAL TIME (hrs.)	8	33
CAUSE OF DEATH	Left air line pulled out of chest	Convulsion
POST-OP. CONDITION	Good urination, attempted to stand, spontaneous breathing	Chewing, standing, excellent
NOTABLE PATHOLOGY	Lung congestion	lung congestion

SUMMARY OF 22 TOTAL HEART REPLACEMENTS (continued)

EXP. #	24	25
SEX	F	F
WT. (kg.)	74	80
HEART MODEL	MK. XII Diaphragm	MK. XII Diaphragm
BYPASS FLOW (c.c./kg./min.)	40-52	50-57
BYPASS TIME (min.)	111	78
PL.Hb.(mg.%) PRE-OP.	2	8
POST-OP. MAX.	42	43
POST-OP. MIN.		1
PLATELETS (x 10 ³ /c.mm.) PRE-OP.	906	328
POST-OP. MAX.		113
POST-OP. MIN.	118	43
SKIN TO SKIN (min.)		235
SURVIVAL TIME (hrs.)	1	10
CAUSE OF DEATH	Acute pulmonary edema	Sacrifice
POST-OP. CONDITION		Metabolic acidosis, low cardiac output
NOTABLE PATHOLOGY	Pulmonary edema, congestion	

TABLE II

SUMMARY OF 4 BYPASS CONTROLS

EXP. #	C-5	C-6
SEX	F	M
WT. (kg.)	78	120
BYPASS FLOW (c.c./kg./min.)	32-41	31-35
BYPASS TIME (min.)	71	70
PL. Hb. (mg.%)		
PRE-OP.	3	5
POST-OP. MAX.	76	18
POST-OP. MIN.	17	18
PLATELETS ($\times 10^3$ /c.mm.)		
PRE-OP.	582	180
POST-OP. MAX.	77	24
POST-OP. MIN.	27	16
SKIN TO SKIN (min.)	240	
SURVIVAL TIME (hrs.)	33	
CAUSE OF DEATH	Sacrifice	Acute pulmonary edema
POST-OP. CONDITION	Poor, Petit mal, convulsion, fever, no urination at end	
NOTABLE PATHOLOGY	Congestion in lower lobes only	Severely congested lungs

SUMMARY OF 4 BYPASS CONTROLS (continued)

EXP. #	C-7	C-8
SEX	M	M
WT. (kg.)	84	62
BYPASS FLOW (c.c./kg./min.)	34-36	35
BYPASS TIME (min.)	70 ⁰	70
PL.Hb. (mg.%)		
PRE-OP.	5	14
POST-OP. MAX.	44	16
POST-OP. MIN.	3	6
PLATELETS (x 10 ³ /c.mm.)		
PRE-OP.	236	508
POST-OP. MAX.	144	179
POST-OP. MIN.	30	40
SKIN TO SKIN (min.)		
SURVIVAL TIME (hrs.)	33	24
CAUSE OF DEATH	Sacrifice	Convulsion
POST-OP. CONDITION	Excellent	Poor, stiff neck
NOTABLE PATHOLOGY	Normal	Infarcted kidney Brain emboli

4.4 Pathological Findings - Artificial Heart

Routinely, the brain, lungs, kidneys, spleen and liver were removed, soaked in formalin for one week and examined for pathological changes following each experiment. Histological specimens were sectioned and prepared with H & E stain.

Brain

Cerebral edema occurred in all animals experiencing a less than normal cardiac output. Long survivors having sac-type hearts showed microscopic parenchymal hemorrhage in the white matter and focal areas of demyelination in the gray matter. Animals surviving up to 9 hours with Mk IX diaphragm hearts showed perivascular hemorrhage. Some of these animals suffering metabolic acidosis also showed macroscopic parenchymal hemorrhage. Long survivors with both sac-type and Mk XII diaphragm hearts and shorter survivors with Mk IX hearts showed both macroscopic and microscopic thromboemboli. In two cases where air aspiration was known to have occurred, air bubbles could be seen in superficial vessels. No hemorrhage was seen in animals with Mk XII diaphragm hearts. (Fig. 4.14, 4.15, 4.16)

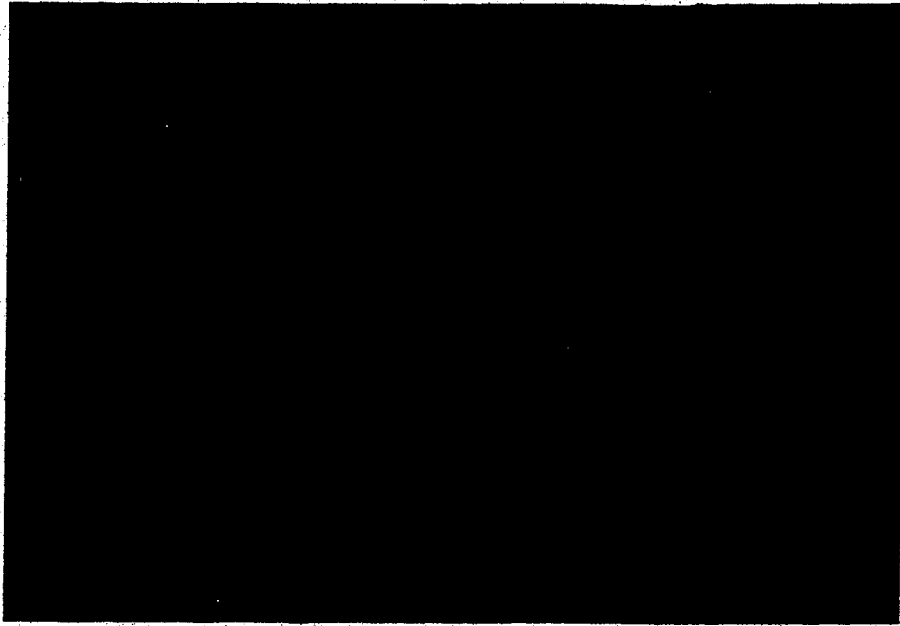

Fig. 4.14 Parenchymal hemorrhage in white matter of the brain from a long survivor. H & E, 100x

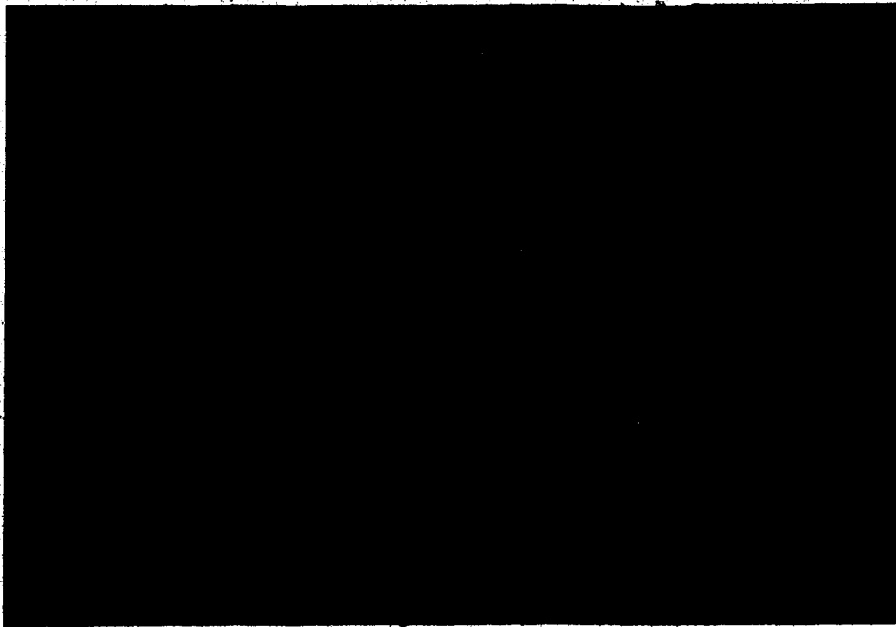

Fig. 4.15 General edema and focal demyelination in the gray matter of a brain from a long survivor. H & E, 75x

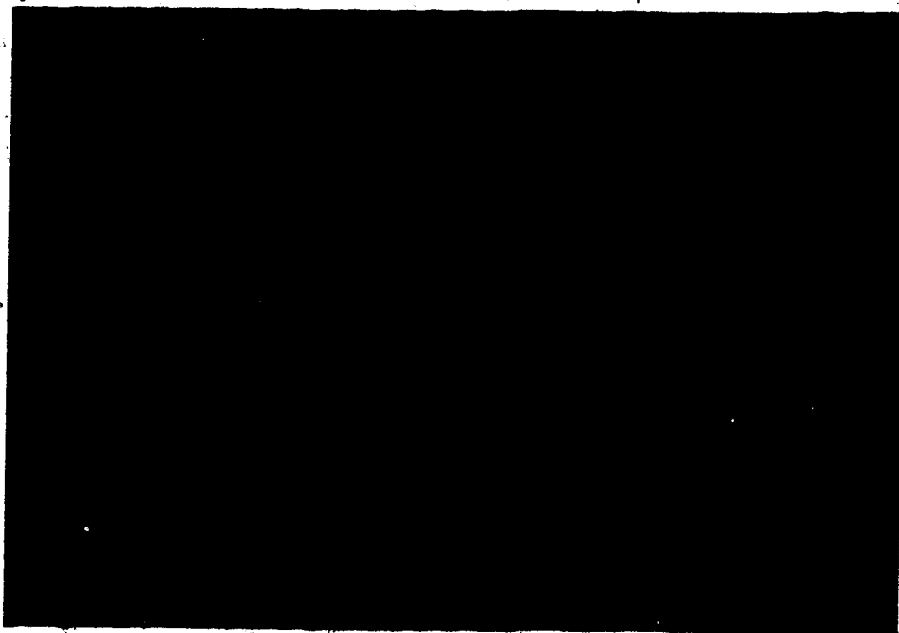

Fig. 4.16 Platelet thromboembolus in the brain of a long survivor
H & E, 100x

Lung

Acute pulmonary congestion, hemorrhage, atelectasis and edema occurred in all animals following a short period of pumping with any artificial heart. There appeared to be no relation between pumping time and lung deterioration. Perivascular hemorrhage was seen only in animals with Mk IX diaphragm hearts. In most cases either thromboemboli, fibrin platelet thrombi and/or air emboli were seen in pulmonary arteries. Intra-alveolar hemorrhage occurred in long survivors. During the winter months, most animals were suffering from a lobar pneumonia exhibiting hepatization and atelectasis of sizeable portions of lung up to 40% of total.

(Fig. 4.17, 4.18, 4.19, 4.20, 4.21, 4.22)



Fig. 4.17 Typical lung from a 33 hour survivor with a sac-type artificial heart showing severe congestion and hemorrhage.



Fig. 4.18 Lung from a 33 hour survivor with a Mk XII diaphragm-type artificial heart showing less severe congestion.

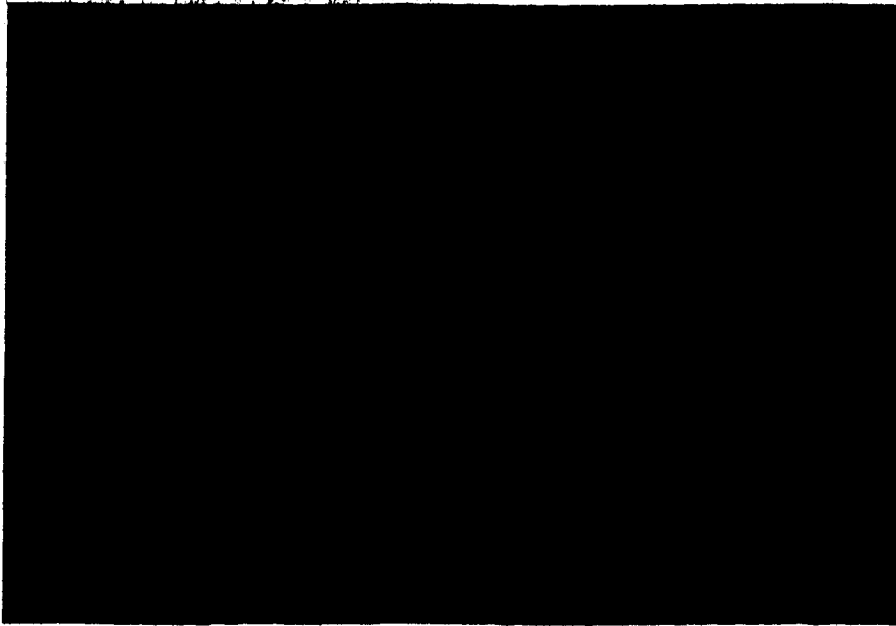

Fig. 4.19 Typical lung showing congestion, intra-alveolar hemorrhage, bronchiolar hemorrhage, and sludging in the pulmonary vessels. H & E, 50x



Fig. 4.20 Perivascular hemorrhage and alveolar edema seen in a lung from a calf with a Mk IX heart. H & E, 50x

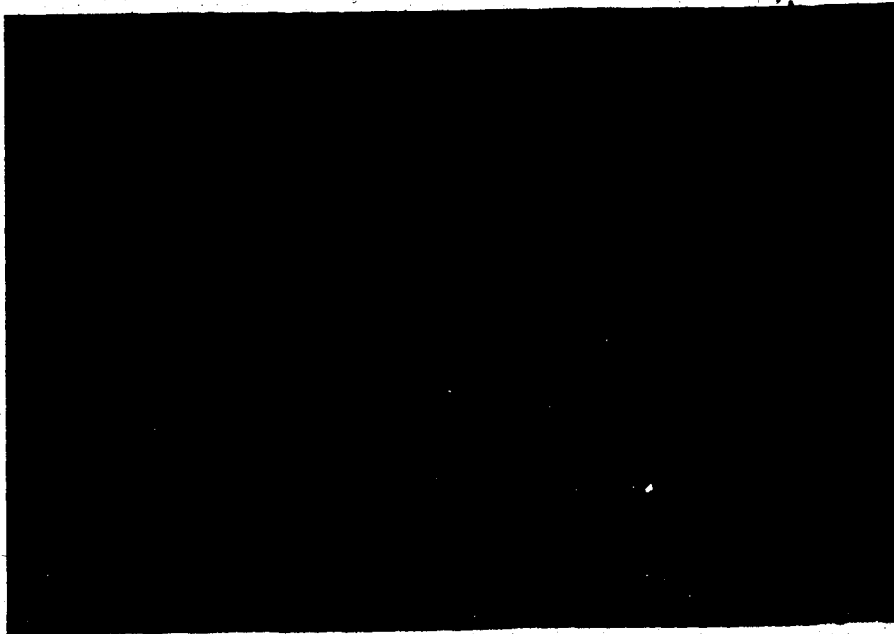

Fig. 4.21 Fresh thromboemboli in a lung. H & E, 50x

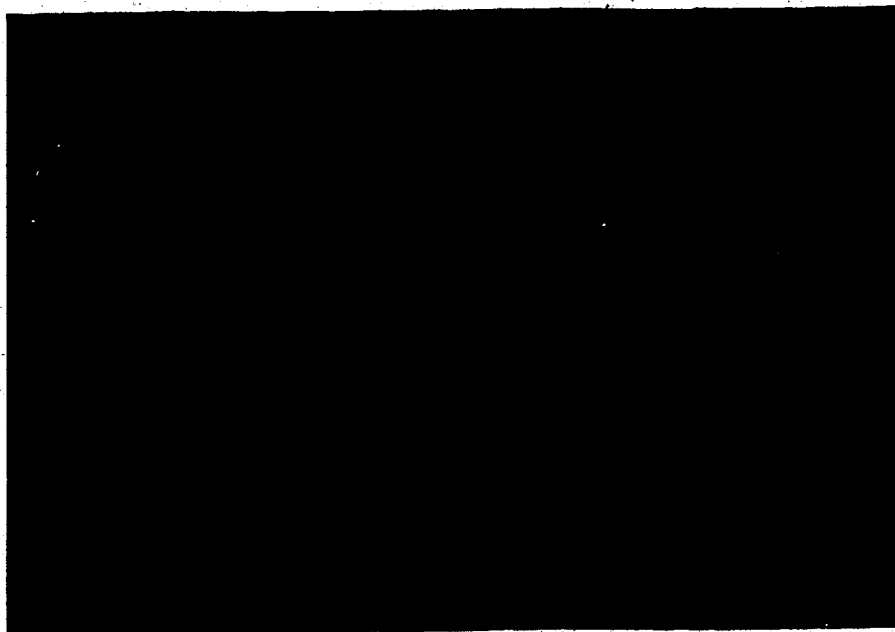

Fig. 4.22 Thromboembolus in a pulmonary artery believed to have formed in the right ventricle.

Liver

All long survivors showed vacuolar degeneration of liver cells around central veins. The animals suffering from very low cardiac output due to a partially obstructed inferior vena cava showed acute congestion. In longer survivors with sac-type hearts there were some mixed thrombi of native formation. (Fig. 4.23, 4.24, 4.25)

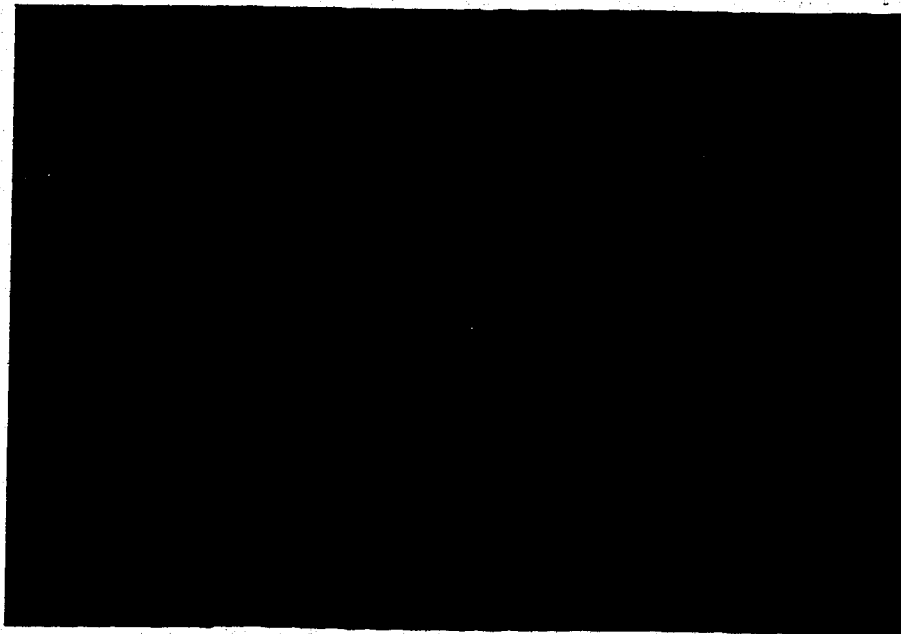

Fig. 4.23 Livers from long survivors showed vacuolar degeneration around central veins. H & E, 100x

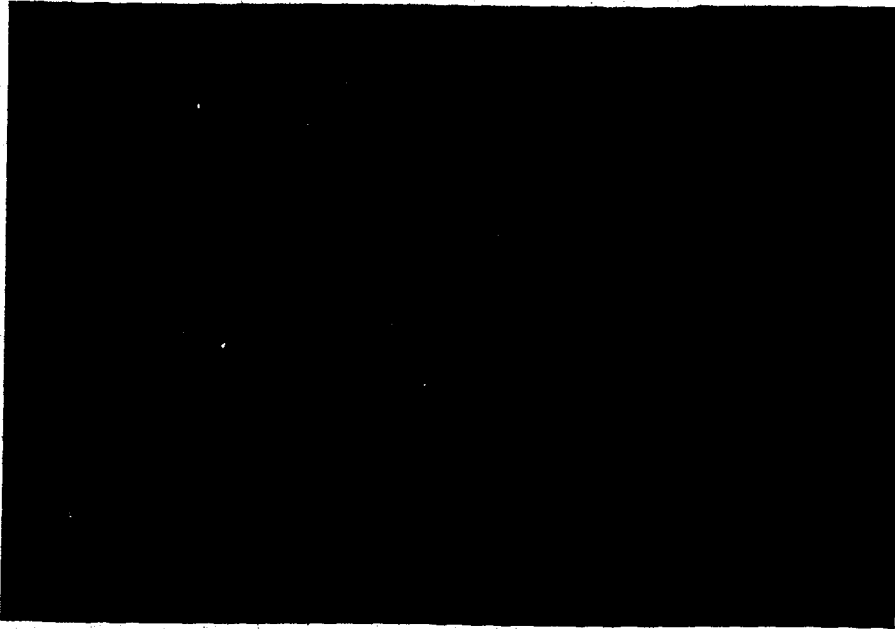

Fig. 4.24 Some long survivors showed livers with centrilobular necrosis. H & E 100x

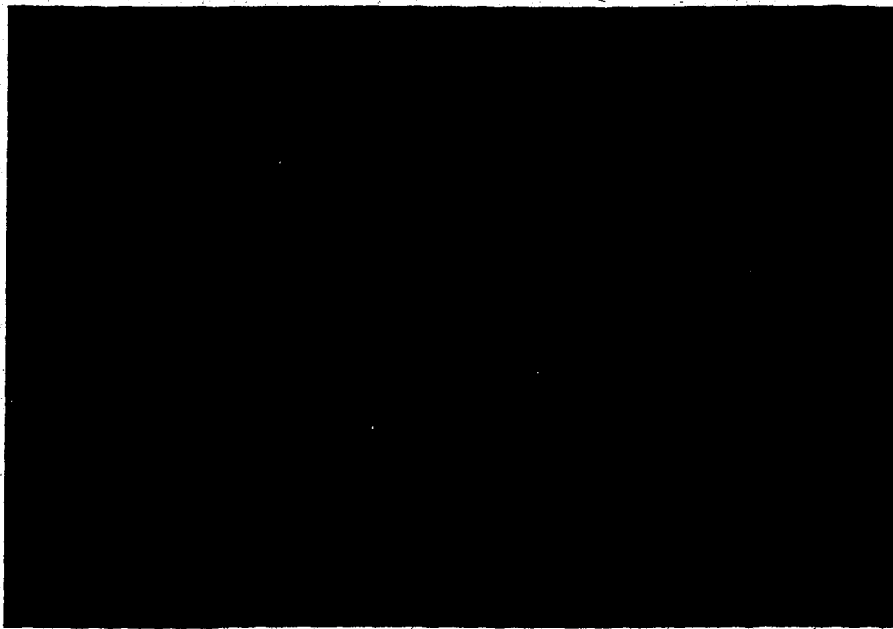

Fig. 4.25 Acute liver congestion seen in calves suffering from very low cardiac output. H & E, 75x

Kidney

In some cases the kidneys had hemorrhagic infarcts. In most cases glomeruli were bloodless. Lower nephron nephrosis or shock kidney was commonly seen, particularly after 30 hours of pumping with sac-type hearts. Thromboemboli were commonly seen in the renal arteries and their branches. (Fig. 4.26, 4.27, 4.28, 4.29, 4.30).



Fig. 4.26 Severely infarcted kidney from a 33 hour survivor with a sac-type heart.

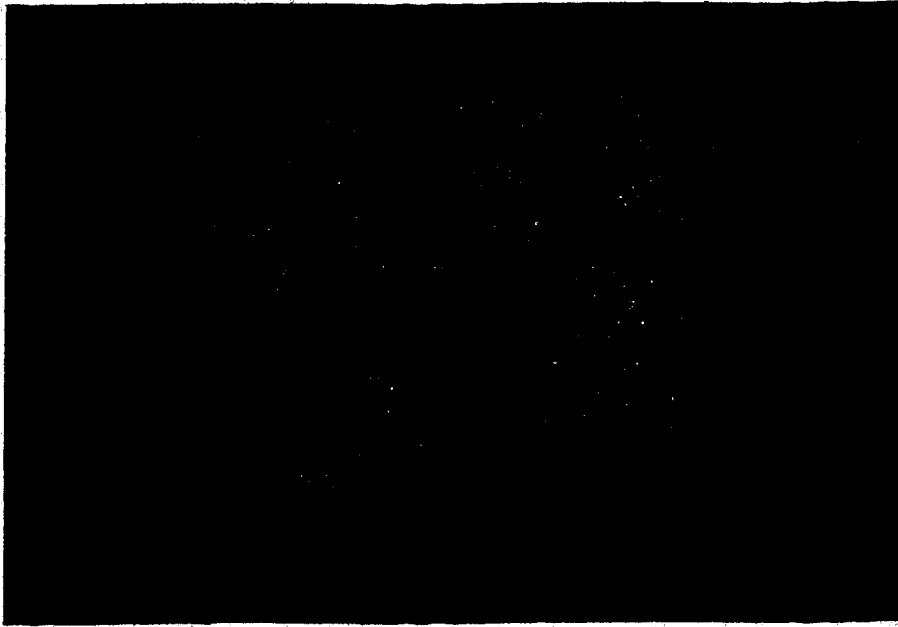

Fig. 4.27 Kidney from a 33 hour survivor with a Mk XII diaphragm-type heart appeared normal.

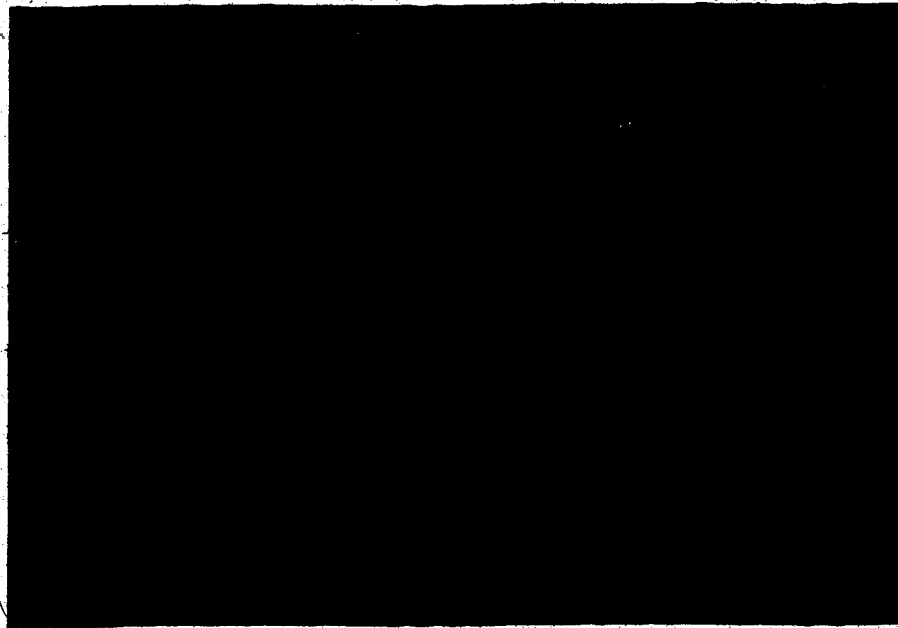

Fig. 4.28 Typical bloodless glomeruli seen in most animals with artificial hearts. H & E, 100x



Fig. 4.29 Some atrophic glomeruli showed pyknosis.
H & E, 100x

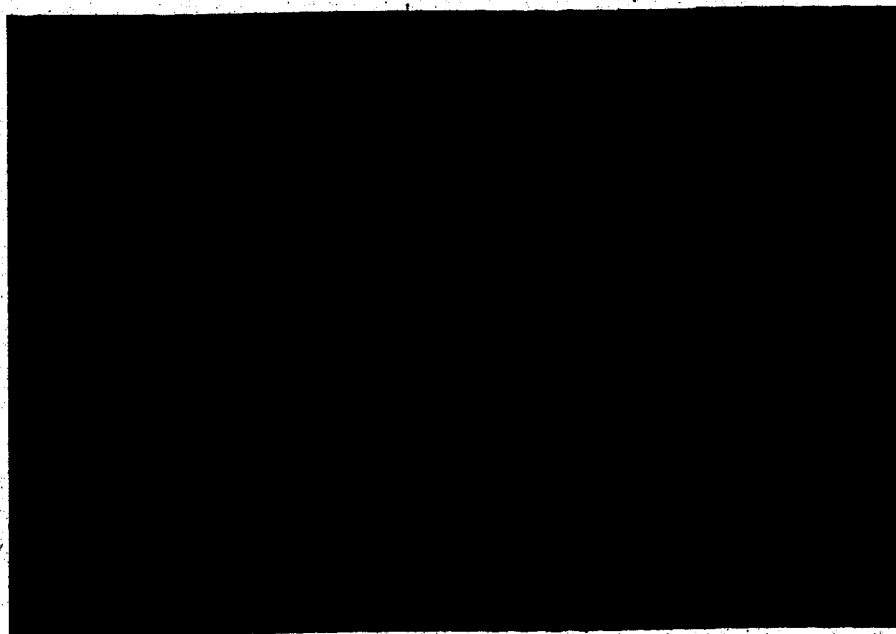

Fig. 4.30 Lower nephron nephrosis with degeneration of tubular
cells typifies the "shock kidneys" seen in all
"longer survivors with sac-type hearts. H & E, 100x

Spleen

Sometimes hemorrhagic spots were seen on the surface of the spleen. Microscopic fibrin nets like those seen in the liver could also be found.

Other Findings

Some hemorrhagic spots occurred on the small intestines and the serosa of the abdominal cavity. Ascites was a common occurrence in experiments where there was a markedly reduced pump output.

In some cases air emboli have been seen in the vessels of the tongue and eyeballs. Rectal bleeding has occurred on rare occasions.

General

In general the pathological findings are consistent with an animal suffering from an irreversible shock death; shocked lungs, shocked kidneys, generalized anoxic cell damage, hemorrhaging and in some long survivors, a disseminated intravascular coagulation. These findings are also consistent with those described for animals dying from the "Artificial Heart Syndrome." [64]

Pathological Findings - Controls

The control calf dying from acute pulmonary edema showed severely congested lungs throughout. The other three calves had lungs showing congestion, edema and hemorrhage in the lower parts of the lower lobes. The middle and upper lobes appeared normal with good alveolar structure.

The calf surviving 24 hours showed many thromboemboli in the

brain, kidneys and liver. The kidneys had focal infarcts.

With the exception of the thromboemboli seen in the 24 hour calf, the kidneys, spleens, livers and brains from all four animals appeared normal. (Fig. 4.31, 4.32)



Fig. 4.31 Congested, hemorrhagic lungs from a control calf living for 24 hours. Lower parts of lower lobes were always more severely affected.



4.32 Focal infarctions in a 24 hour control kidney likely caused by thromboemboli from flushed pressure catheters.

4.5 Causes of Death

Of the 22 animal experiments there were four major causes of death. (Fig. 4.33)

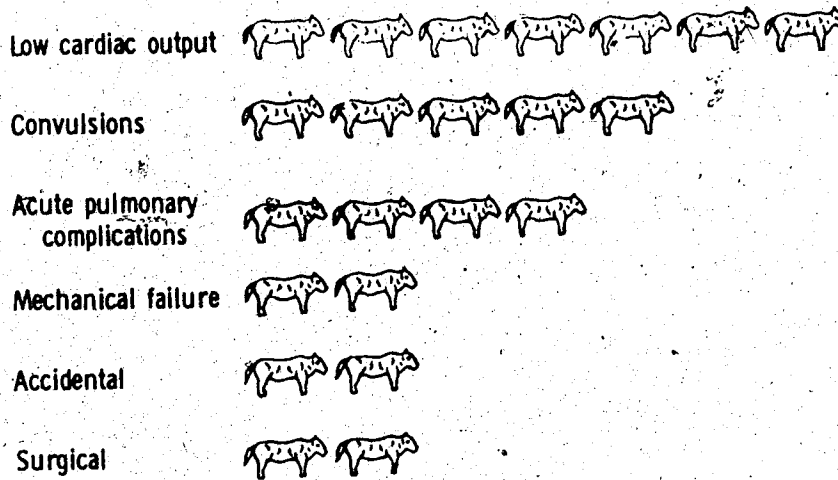

Fig. 4.33 Causes of death for calves with artificial hearts.

There exists a correlation between the causes of death and survival times of animals. (Fig. 4.34)

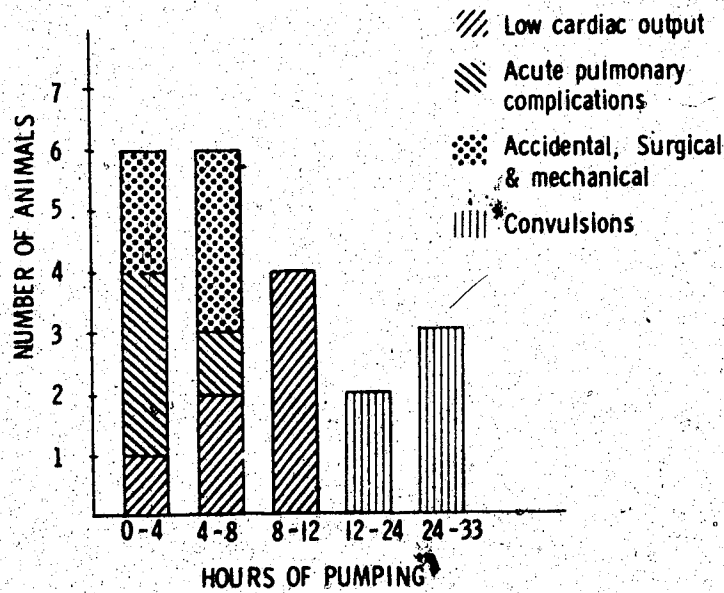

Fig. 4.34 Survival times and causes of death for calves with total artificial hearts.

Most animals dying before 8 hours of pumping succumbed to accidents, mechanical failures and acute pulmonary complications. Low cardiac output caused the deaths of most animals surviving for about 8 hours. All long survivors of more than 12 hours died as a result of convulsions. The average pumping time was 10 hours.

Accidental Deaths

Accidents were responsible for two deaths, one animal with a sac-type heart and one with a diaphragm-type heart.

The first accident during experiment #2 occurred one hour after takeover with the Mk V artificial heart. The air pressure driving line to the left ventricle was crimped for about 30 seconds deactivating the left heart causing a very high left atrial pressure which was soon followed by massive pulmonary edema of several hundred ml.

The second accident occurred during experiment #22 following 8 hours pumping with a Mk XII diaphragm heart. The animal had experienced an excellent recovery and made frequent attempts to stand up. During his last attempt he stood upon the left ventricular air driving line which pulled away from its brass connector fitted to the ventricle producing acute left heart failure. The defect was later found to be in the brass connectors which had been machined slightly smaller than specification allowing the Tygon tubing to pull away.

Surgical Deaths

Two surgical deaths were recorded in which the chest was not closed. The first, experiment #14 was terminated after 4 hours of pumping with a Mk IX diaphragm heart because the animal's chest could

not be closed around the artificial heart. The calf had an unusually small chest cavity.

The second, experiment #16 was terminated after 2 hours pumping due to an irreparable blood leak in the vicinity of the atrial anastomoses.

Mechanical Failures

Mechanical failures, due to breakage of the artificial heart, were responsible for two deaths.

Experiment #1 ended after 7 hours of pumping with a Mk V rubber heart. A crack occurred in the flat side of the left ventricle allowing an immediate massive loss of blood into the chest.

Experiment #15 was terminated after 4 hours of pumping. The Silastic diaphragm of the Mk IX heart pulled in towards the centre causing a leak of compressed air around a screw hole into the blood pumping chamber of the left ventricle, resulting in air embolism.

Accidents, surgical difficulties and mechanical failures caused a combined total of 6 deaths or 28% of all deaths. Their average survival time was 4 1/2 hours.

Acute Pulmonary Complications

Acute pulmonary complications caused the deaths of 4 animals or 18% of all deaths. Two deaths occurred with each type of heart in experiments #3, #9, #21 and #24. In all four cases, the complication was massive pulmonary edema resulting in a tracheal outflow of several hundred ml. of pink frothy fluid. The causes are unconfirmed but suspected of being associated with preoperative pneumonia, long cardio-pulmonary bypass times, high initial pulmonary arterial pressure

and/or transient high left atrial pressures. Animals suffering death from acute pulmonary complication averaged 3 hours survival.

Low Cardiac Output

Low cardiac output was the major cause of death including all animals (32%) and also for the group of animals with diaphragm-type hearts.

Only one of these animals had a sac-type heart which was the all-rubber Mk VII model. The flexible ventricles were unable to provide adequate arterial pressure and flow. All other six animals were fitted with diaphragm hearts. The Mk IX model was large and heavy and caused compression of the inferior vena cava after the chest was closed in five cases. Before closing the chest typical blood pressures were systemic arterial 140/90 mm.Hg and right atrial 2 mm.Hg. Following closure of the chest pressures would drop to 60/20 and -5 mm.Hg. with an ensuing progressive metabolic acidosis. One similar case also occurred using a Mk XII model heart. Measured cardiac output was always very low (1.5 - 3.0 L/min.) when measured by the dye dilution technique. All animals were sacrificed either when diastolic blood pressure fell below 20 mm.Hg, spontaneous breathing stopped or when blood gases indicated an irreversible metabolic acidosis. Average pumping time was 8 hours.

Convulsions

Convulsions caused 23% of all deaths. All 5 long survivors died from convulsions with an average pumping time of 27 hours. Since 4 of the 5 long survivors had sac-type Mk VI hearts it appears as the

dominant cause of death with the sac heart. The other long term survivor was fitted with a Mk XII diaphragm heart.

All five animals showed good recovery and made numerous attempts to stand. Death usually followed soon after one or more major convulsions. The animal would become oblivious to its surroundings, lose spontaneous breathing and experience a progressive loss in diastolic blood pressure.

In all five cases the convulsions were believed due to thromboemboli.

4.6 Limiting Factors

The pathological review and causes of death have led to five major limiting factors of the total replacement artificial heart:

1. low cardiac output
2. thrombosis
3. pulmonary complications
4. hematological changes
5. experimental animals and surgical procedures.

All five limiting factors have contributed to the deaths of the 22 calves with artificial hearts. Each shall be discussed in detail.

1. Low Cardiac Output

There are several factors that have contributed to the low cardiac output recorded in most animals:

venous compression

depressed peripheral vascular response

high pulmonary resistance
output pressure waveform.

Preoperatively the calves had cardiac outputs of six to seven liters per minute measured by the dye dilution technique. Postoperatively those animals dying from a low cardiac output and metabolic acidosis had pump outputs of less than three liters per minute. The longer survivors had pump outputs of from 3 to 5 liters per minute. No animals had postoperative pump outputs equal to the preoperative cardiac output.

Venous Compression

All the heart designs caused some compression of the inferior vena cava. The venous compression would be caused after the chest was closed and could be confirmed by measurements of right atrial pressure and central venous pressure. Normally, these two pressures would be within 1 mm Hg of each other, but when the vena cava was compressed, the right atrial pressure would be about 5 to 7 mm Hg below that of central venous pressure. The Mk IX diaphragm heart caused the most compression due to its extra large displacement and its weight. Whereas the natural heart receives support from the pericardium, the artificial heart was supported only by the anastomoses with the remnants of the natural heart and by the air driving tubes inserted through incisions in the chest wall.

Increased Pulmonary Resistance

In general, the pump output was restricted by the volume of blood that could be pumped through the lungs. Left atrial pressures

were always lower than right atrial pressures. The right ventricle therefore always filled better than did the left. Pulmonary resistance was always very high immediately after cardiopulmonary bypass and subsided in only a few cases. When pulmonary resistance was high, the right ventricular pressure had also to be high, producing a state of pulmonary hypertension. Since a maximum safe pulmonary arterial pressure of 70 mm.Hg had been set there was no other course with which to overcome the pulmonary resistance and increase blood flow through the lungs and thus pump output.

Depressed Peripheral Vascular Response

The venous return to the right side of the heart is dependent upon the circulating blood volume and by the capacitance and resistance of the systemic blood vessels. When the peripheral vascular tone is reduced and blood vessels dilate, their capacitance increases, their resistance decreases and venous pressure is reduced, diminishing venous return. The general dilatation and progressive shock existed in all long survivors. Widening pulse pressures and dropping end diastolic blood pressures were indicative of the condition.

Output Pressure Waveform

It may be that pulmonary vasoconstriction and systemic dilatation are affected by the sometimes unphysiological shape of the output pressure waveform. The Mk IX diaphragm heart was the only heart to produce perivascular hemorrhage in the lung and brain. The shape of its output pressure waveform was less physiological than those seen with the sac-type hearts. (Fig. 4.35)

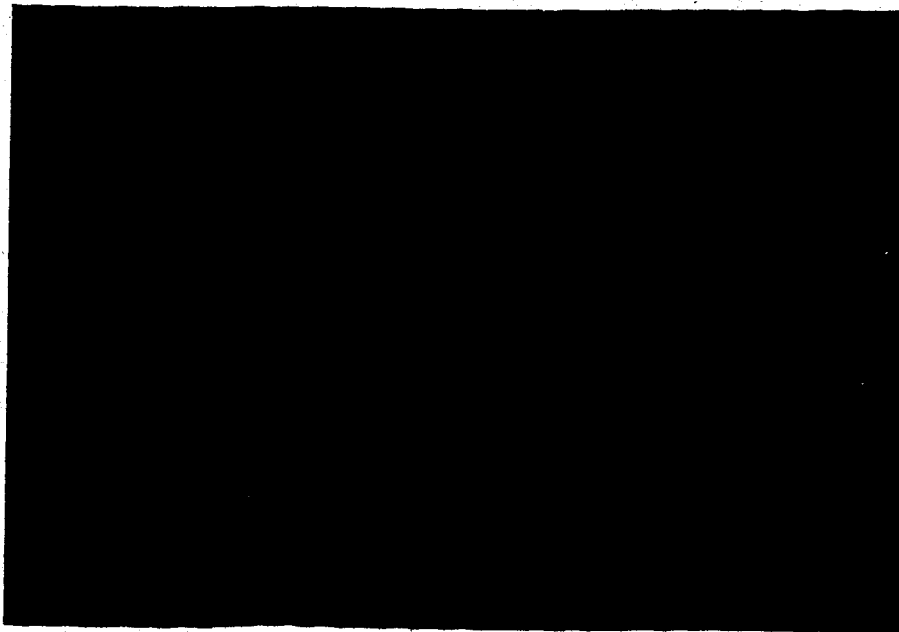

Fig. 4.35 Output pressure waveform from a sac-type artificial heart.

In particular, the systolic $\frac{dp}{dt}$ was very high as was peak systolic pressure. (Fig. 4.36)

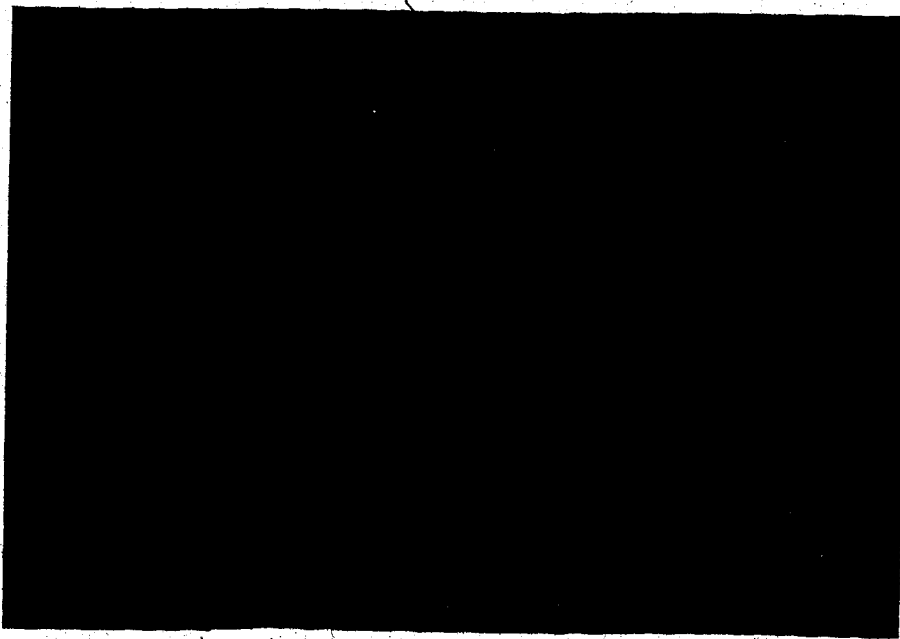

Fig. 4.36 The Mk IX diaphragm heart produced output pressure waveforms with a very high systolic $\frac{dp}{dt}$.

This increase in $\frac{dp}{dt}$ over the sac-type hearts could only have been attributable to the difference in stroke volume which had been increased from 120 cc. for the sac-type to 160 cc. for the Mk IX. The Mk XII heart was designed to reduce the $\frac{dp}{dt}$ by making the maximum stroke volume only 85 cc. The resulting output pressure profile produced by the smaller Mk XII heart is far more physiological, has a greatly reduced $\frac{dp}{dt}$ and increased diastolic pressure which leads to a greater pump output. (Fig. 4.37, 4.38) No perivascular hemorrhage was seen in implantations with the Mk XII device.

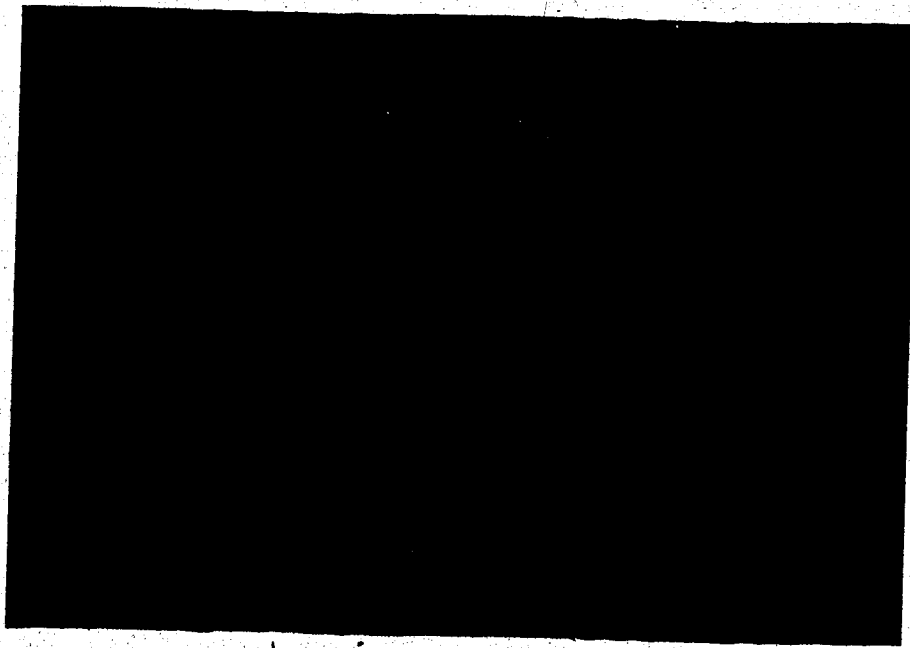

Fig. 4.37 The Mk XII heart produced a much reduced $\frac{dp}{dt}$ and a more physiological waveform.

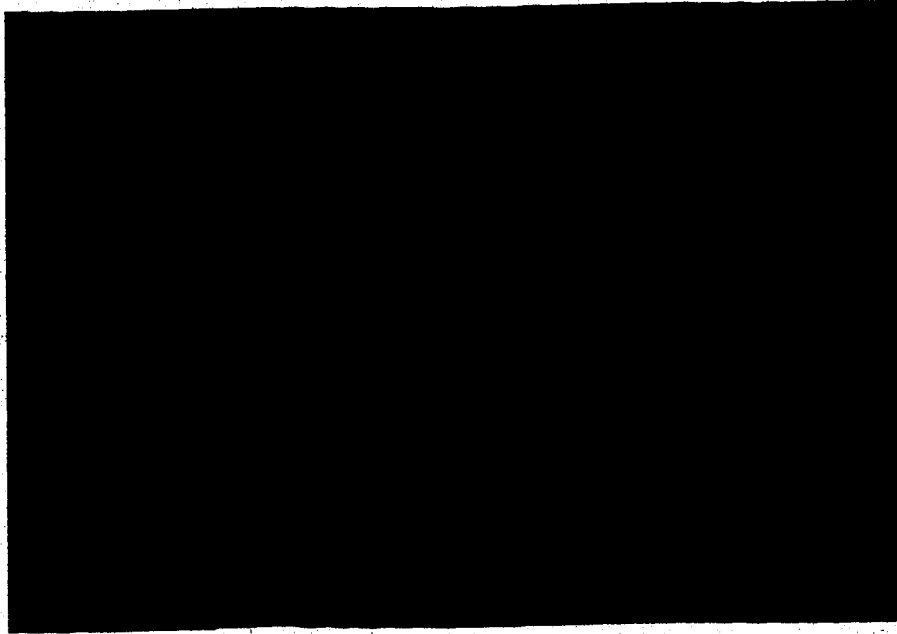

Fig. 4.38 Output pressure waveform of the natural calf heart.

2. Thrombosis

Thrombosis inside the artificial heart has accompanied all experiments where the animal survived more than eight hours with an artificial heart.

It is well recognized in pathology that thrombosis is initiated by the deposition of platelets within blood vessels and that there are three predisposing factors in its pathogenesis: [86, 87, 88]

changes in the local pattern of blood flow

changes in the vessel wall

and changes in the constituents of the blood.

All three predisposing factors are evident in total artificial heart replacement.

Changes in the Local Pattern of Blood Flow

Where laminar flow exists in arteries, white cells are at the

center of flow with the red cells next, followed by the platelets which are separated from the endothelium of the vessel by a thin boundary layer of plasma. If the laminar flow is disrupted, platelets may migrate into the plasma layer and attach themselves to the vessel wall. The disturbance may be an increase of flow velocity, a decrease of flow velocity or stasis.

Artificial ventricles disturb normal blood flow for several reasons. Firstly, each artificial heart usually contains four prosthetic valves. Clinically, prosthetic valves cause abnormal flow patterns and exhibit a thrombotic potential.

Secondly, all artificial hearts pump blood in an unphysiological manner. Whereas the natural heart begins systole progressively, gently squeezing out its load of blood, artificial hearts tend to generate high rates of pressure increase and high ejection velocities. High velocities in turn generate turbulence allowing formed elements of the blood to come in direct contact with the ventricular and arterial walls. Some designs permitting contact of opposing ventricular walls further enhance this direct contact.

Thirdly, most artificial hearts have discontinuities in their inner surfaces at atrial and arterial anastomoses, graft connections and valve placements. These discontinuities give rise to irregularities of flow. In general, prosthetic valves, heart connections and intrinsic flow patterns all cause disturbance of laminar flow causing the deposition of platelets, predisposing to thrombosis.

The sac-type natural rubber hearts formed red blood clots in the distal apex of each ventricle. (Fig. 4.39)



Fig. 4.39 Sac-type artificial hearts formed large thrombi in the apexes where flow was reduced.

The clots were usually about 1 mm. thick, firmly attached to the sac, and encapsulated by a thick fibrin-like material extended over an area slightly larger than each clot. Minor clotting and fibrin formation was usually evident around the valve housings and valve cages.

The ventricle apexes were areas of very low or stagnant flow, particularly when cardiac output was markedly reduced, and the valve locations were areas of disturbed flow; both predisposing factors to thrombosis.

The earlier Mk IX Silastic diaphragm hearts formed clots around the valves and in particular at the peripheral junction between diaphragms and aluminum housings. (Fig. 4.40)

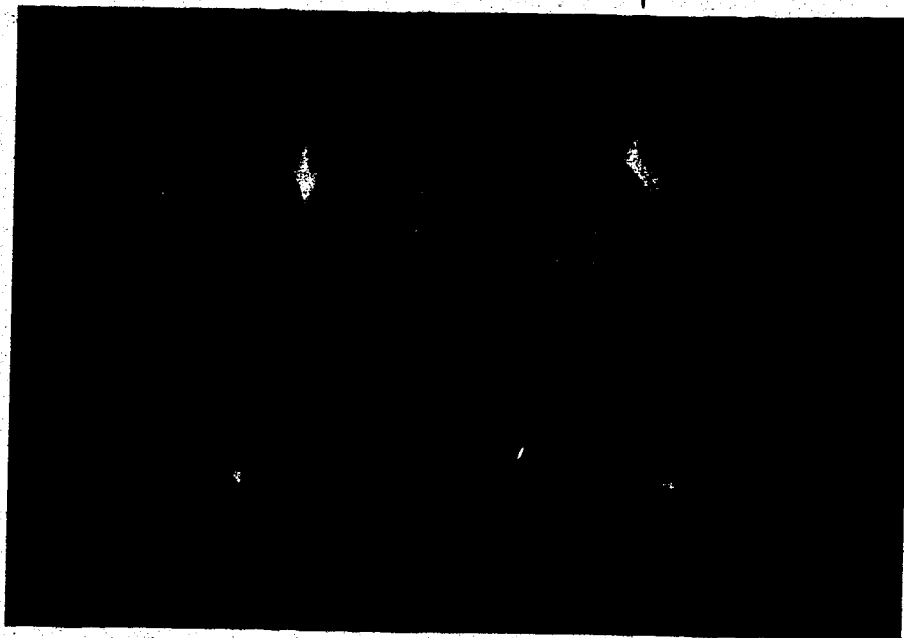

Fig. 4.40 Mk IX diaphragm hearts formed clots around valves and at the peripheral junction between diaphragm and housing.

The junction was an area of reduced flow or no flow predisposing to thrombosis. Usually, there was equal clot formation in the teflon valve holders both proximal to the inlet valves and distal to the outlet valves suggesting that very low flow rates and very high flow rates encourage thrombosis equally.

The later model Mk XII Silastic diaphragm ventricles also formed red clots around the valves, in the outflow connector and at the diaphragm to chamber junctions. (Fig. 4.41)

In general, thrombosis occurred on stationary parts of the hearts rather than on moving parts. Whereas the valve housings and cages, outlet and inlet ports and ventricle housings usually induced clots, the constantly moving sacs, diaphragms and valve discs themselves were always clot free. Because moving surfaces remained clot free does not deny the possibility that small clots or micro-emboli

could be formed on moving surfaces and cast free. The thromboembolism potential of the devices is indicated by the convulsions seen in animals surviving more than eight hours and possibly by the clots occasionally seen in pulmonary arteries.

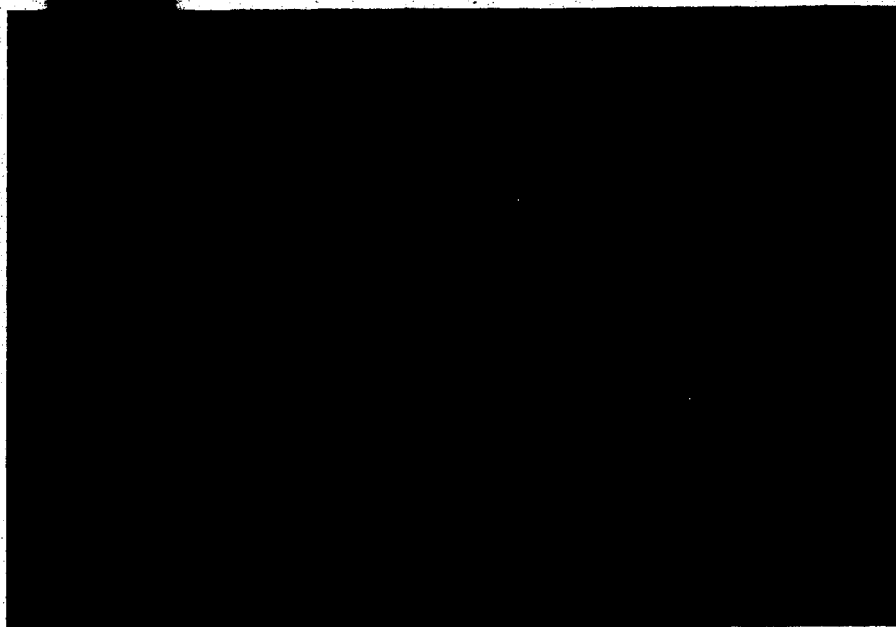

Fig. 4.41 Mk XII diaphragm heart also formed thrombi around valves, connectors and diaphragms.

In the latest artificial hearts, pressure taps into the atria and arteries were eliminated since they would invariably clot and when flushed were sites of potential thromboemboli.

The problem of thrombosis within artificial hearts is quite clearly related not only to chemical surface properties of the material used but also to design and construction of the device. The fact that there is varying severity of thrombus formation depending upon the site within a device made of one particular material indicates the importance of hemodynamic considerations in artificial heart designs.

Changes in the Vessel Wall

The unphysiological surface properties of artificial heart materials is a major cause of thrombosis. Whereas changes in the vessel wall in natural vessels activate platelet deposition by the release of A.D.P. or thrombin, the intrinsic chemical properties of unphysiological materials may encourage thrombosis. The foreign surface properties usually activate the Hageman factor #XII of the intrinsic pathway of thrombosis.

To improve the antithrombogenicity of the sac-type hearts the natural rubber was prebiolized by the bonding of Heparin to the rubber surface with a technique similar to that suggested by Imai.^[89] Even though the prebiolized rubber had an in vitro clotting time ten times that of natural rubber alone, thrombosis within the device was still a problem.

The later diaphragm-type hearts featured an inner surface entirely lined with silicone rubber with exception of the four valves. Although thrombosis was not as severe as seen in the natural rubber hearts, clots were invariably seen in hearts from longer survivors.

Although Silastic hearts often encourage thrombosis, Akutsu^[90] claims that a well prepared Silastic surface is antithrombogenic but that Silastic is fragile and may become contaminated during steps of fabrication processes.

The main opposition to using smooth Silastic or polyurethane surfaces is that there is a possibility that small emboli are formed at the constantly washed surface.^[56, 91] Simple Heparin coating processes have been claimed to reduce the thrombogenicity of many polymers with varying results.^[92, 93, 94, 95, 96] Some investigators

have chosen to make surfaces that encourage fibrin deposits and the formation of a pseudoendothelium. These surfaces are all rough incorporating silicone rubber coated either with short dacron or nylon fibrils [72, 97] or velour cloths. [98] Liotta suggested that a thin coat of blood protein is deposited on all plastics within the blood stream and that it should be anchored. [51] The main drawbacks to the lined surfaces are the increased initial hemolysis [60] and the difficulty in regulating the thickness of the neo-intima. When the pseudointima becomes too thick, there is a danger of the surface being fractured and large pieces of the surface may become separated forming massive thromboemboli. Kolff's record holding experiments have utilized hearts with both smooth and rough surfaces. In all cases the thromboembolic phenomenon was present but to a slightly lessened degree with the fibril surfaces. [60]

Some work has been directed toward surfaces possessing a negative charge to repel the platelet. [99] It has been found however, that not all negatively charged surfaces are antithrombogenic.

In most instances, the antithrombogenicity of artificial heart materials has been affected by the flow condition within the device.

Changes in the Constituents of the Blood

It appears that although changes in the local hemodynamics and changes in the vessel wall may establish conditions which can lead to thrombosis, it does not necessarily develop. There may be a "thrombogenic tendency" in the blood. Experimental evidence in this regard is meagre. There is some suggestion that platelet count,

platelet survival time, presence of unesterified fatty acids or blood viscosity may affect platelet aggregation. During cardiopulmonary bypass and pumping of the artificial heart there are many alterations in platelet activity, platelet count, blood viscosity and other factors which may well contribute to thrombosis as a predisposing factor.

In summary, the thrombogenic potential of the total artificial heart remains a major limiting factor. The thrombosis is most likely a result of fabrication with materials that are not totally antithrombogenic and perhaps more important, hemodynamics within the devices that are unphysiological enhancing clot formation. It is also possible that alterations in blood components during the insertion phase and perfusion phase may contribute to thrombosis.

3. Pulmonary Complications

Pulmonary complications have accompanied all total heart replacements. The complications have been either acute and primary or secondary to other causes. Commonly, post-mortem lungs have all been atelectatic, edematous, hemorrhagic and congested.

The most serious acute pulmonary complication has been massive pulmonary edema. The edema has occurred not only when brought on by detected left heart failure but sometimes when not expected. The cause of the edema is most likely related to lung management during surgery and to accidental elevated left atrial blood pressures. In the two cases where the left ventricle has been accidentally inactivated for several seconds permitting left atrial pressures of more than

25 mm.Hg the flow of blood tinged frothy edema fluid from the endotracheal tube began within minutes. (Fig. 4.42)



Fig. 4.42 The cut surface of a lung following acute massive pulmonary edema.

Left atrial pressure is sometimes difficult to regulate when changing from cardiopulmonary bypass to the artificial heart. In some cases during changeover left atrial pressures have transiently reached 15 or 20 mm.Hg momentarily. Not all of these instances resulted in acute pulmonary edema. The four animals that died following pulmonary edema had other complications. Two of the animals experienced unusually long cardiopulmonary bypass times of 110 minutes and 120 minutes. The other two calves had postoperative pulmonary hypertension with a pulmonary arterial blood pressure of over 70 mm.Hg.

The postoperative pulmonary hypertension was a complication itself in 21 out of the 22 animals. Normal pulmonary arterial pressure measured preoperatively was 15-25 mm.Hg. Five animals were

treated throughout the experiment with a cortico-steroid methylprednisolone. The maximum postoperative pulmonary arterial pressure in the treated group was 50 mm.Hg with an average of 40 mm.Hg. One of the treated animals had a normal pressure of 28 mm.Hg. In the untreated group, three animals recorded pulmonary arterial pressures of over 70 mm.Hg, two of which died from pulmonary edema and one which recovered and died from anoxia. Of the remaining animals with pulmonary hypertension, the maximum average pressure was 50 mm.Hg. In most cases the maximum pressure was reached within minutes after the onset of pumping and usually began to subside within one half hour. All of the five long survivors (18-33 hours) had pressures that had dropped to less than 30 mm.Hg within one hour of pumping. Most other animals remained hypertensive throughout.

Pulmonary arterial pressure is controlled by the driving force of the right ventricle and by the resistance to blood flow in the lungs. If the resistance was high the driving force had to be high to provide a flow through the lungs to the left atrium. Usually the pulmonary resistance was very high when circulation was begun in the lungs. If the resistance became less, the driving pressure could be reduced lowering the pulmonary arterial pressure. Sometimes however, the resistance did not lessen and the flow remained low since the maximum pulmonary arterial pressure was limited to about 70 mm.Hg. The low blood flow through the lungs was often the limiting factor in cardiac output resulting in very low total blood flows. There may be an intimate relationship between the high pulmonary resistance and low cardiac output that results in a double circle of events leading to the progressive cardiovascular shock experienced by

most animals following cardiopulmonary bypass and total artificial heart replacement. (Fig. 4.43)

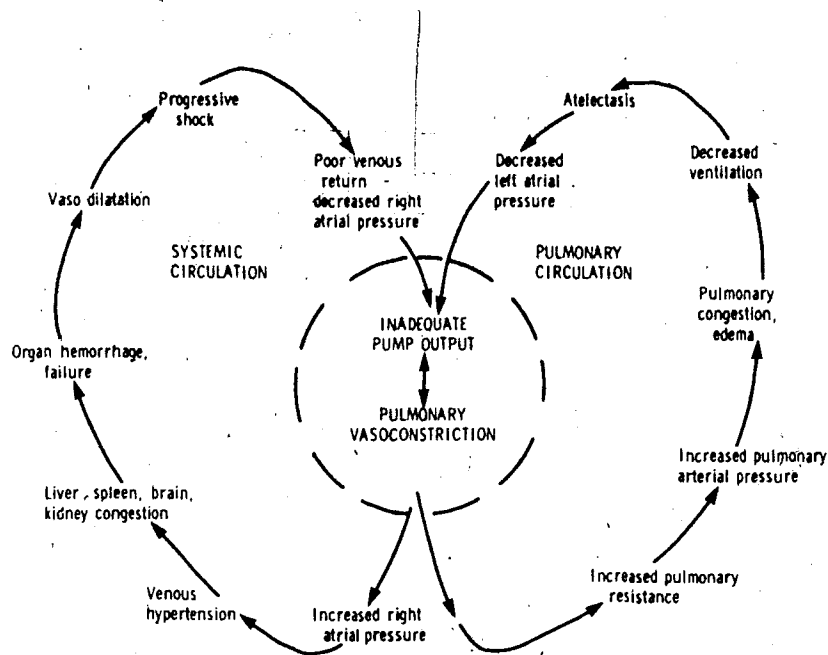

Fig. 4.43 A possible pathway leading to progressive cardiovascular shock.

The reasons for the increase in pulmonary resistance that occurs may be related to the cardiopulmonary bypass but they are unclear.

Cortico-steroids given in large doses are said to act as a vasodilator^[100,101] producing better peripheral tissue perfusion helping to diminish anaerobic metabolism and prevent metabolic acidosis. The use of the steroids in our experiments reduced the level of postoperative pulmonary hypertension and hastened the progress of arterial blood gases to within normal range. The administration of methylprednisolone did not however prevent the long term progressive shock seen also in untreated animals.

Pulmonary complications in calves associated with anesthesia and cardiopulmonary bypass are not unique to animals in this project. Other workers [102, 103, 104] have reported hypoxemia, pulmonary hypertension and other perplexing complications after bypass. The most common explanations for the complication include immaturity of the calf lung, excessive positive pressure ventilation, improper positioning and too rapid a transition from the cardiopulmonary bypass to the artificial heart. Changes in our procedure aimed at lessening some of these causes have made little difference in the incidence of complications.

It has also been suggested [105] that the calf possesses anatomical factors that precipitate pulmonary complications during surgery if the calf is in the supine position. The inferior vena cava is positioned at the middle of the thoracic cavity and in a supine position, the major portion of the lungs are below the level of the vena cava. The most dependent parts are more than 10 cm. below the vena cava. Pathological deterioration of the calf lungs was usually first observed in the dorsal part of the lower lobes during and after cardiopulmonary bypass. It may be possible that the anatomical factors of the calf render acute passive congestion of the dorsal parts of the lower lobes unavoidable, particularly with cardiopulmonary bypass. In addition to high pulmonary arterial pressure, high left atrial pressure, low cardiac output, surgical technique and cardiopulmonary bypass technique, there may be other factors directly contributing to pulmonary complications.

Blood damage from mechanical trauma may result in the release of humoral agents such as serotonin, histamine and epinephrine into

the bloodstream effecting fluid balance in the lung.

Simple mechanical compression of parts of the lung by an oversized artificial heart certainly causes local areas of atelectasis.

Our present day methods of respiratory support are geared to humans and may not suit the calf with its fragile lung. In our experiments we have witnessed far better recoveries in animals that were hand ventilated or so-called "hand-bagged" with a simple anesthesia machine than in animals whose respiratory support was handled entirely by an automatic volume respirator.

There are indications that artificial heart output pressure waveforms may greatly influence the integrity of the lung. There are indications that a high systolic $\frac{dp}{dt}$ in the output pressure profile is more damaging to the lung than is a lower $\frac{dp}{dt}$.

Animals that escaped acute pulmonary edema, accidents or mechanical failures all developed a syndrome of progressive respiratory failure. According to King^[106] the "adult respiratory distress syndrome" also known as "wet lung," "shock lung," "septic lung," "hyostatic pneumonia" and "post traumatic pulmonary insufficiency" in humans, is characterized by, a diminishing pO_2 , a normal or low pCO_2 , increased respiratory rate and minute ventilation, increased dead space ventilation, progressive acid-base derangements, and a falling effective compliance. At post-mortem those lungs have a patchy, liver-like consistency and are heavier than normal as a reflection of their increased water content. Histologically, varying mixtures of interstitial and alveolar edema and hemorrhage, atelectasis, hyaline membrane formation, vascular thrombosis and

infection are seen. Functionally and histologically, calves with total artificial hearts are exhibiting a syndrome of respiratory distress very much like that of the adult respiratory distress syndrome.

Since the pathogenesis of the adult respiratory distress syndrome is unclear, pulmonary complications in calves with total artificial hearts remain a major limiting factor.

4. Hematological Changes

To determine the hematological effects of total heart replacement measurements were taken of Hb., Hct., R.B.C., W.B.C. and platelet count, serum electrolytes, total proteins, glucose, B.U.N., creatine, bilirubin, lactic acid, pyruvic acid and histamine. Clotting times in glass were determined periodically. In a series of five animals partial thromboplastin times, prothrombin times and fibrinogen levels were also measured.

Control samples for the whole blood, hematology and clotting tests were drawn from the carotid artery through a flushed polyethylene tube. The first samples were drawn immediately following cannulation of the neck vessels and prior to opening of the chest. The second whole blood and hematology samples were obtained immediately before conclusion of bypass and the second clotting sample was obtained after bypass and after the neutralization of Heparin with protamine sulphate. Further samples were taken every two hours.

Blood damage includes not only trauma to formed elements of the blood but also to the disturbance of homeostatic functions and mechanisms of the blood.

Red Cell Hemolysis

Red blood cell hemolysis is the best indicator of blood damage. Hemolysis has accompanied all 22 artificial heart implantations. The parameter which best indicates the extent of hemolysis is the plasma hemoglobin which is the free hemoglobin released when red blood cells are destroyed intravascularly. (Fig. 4.44)

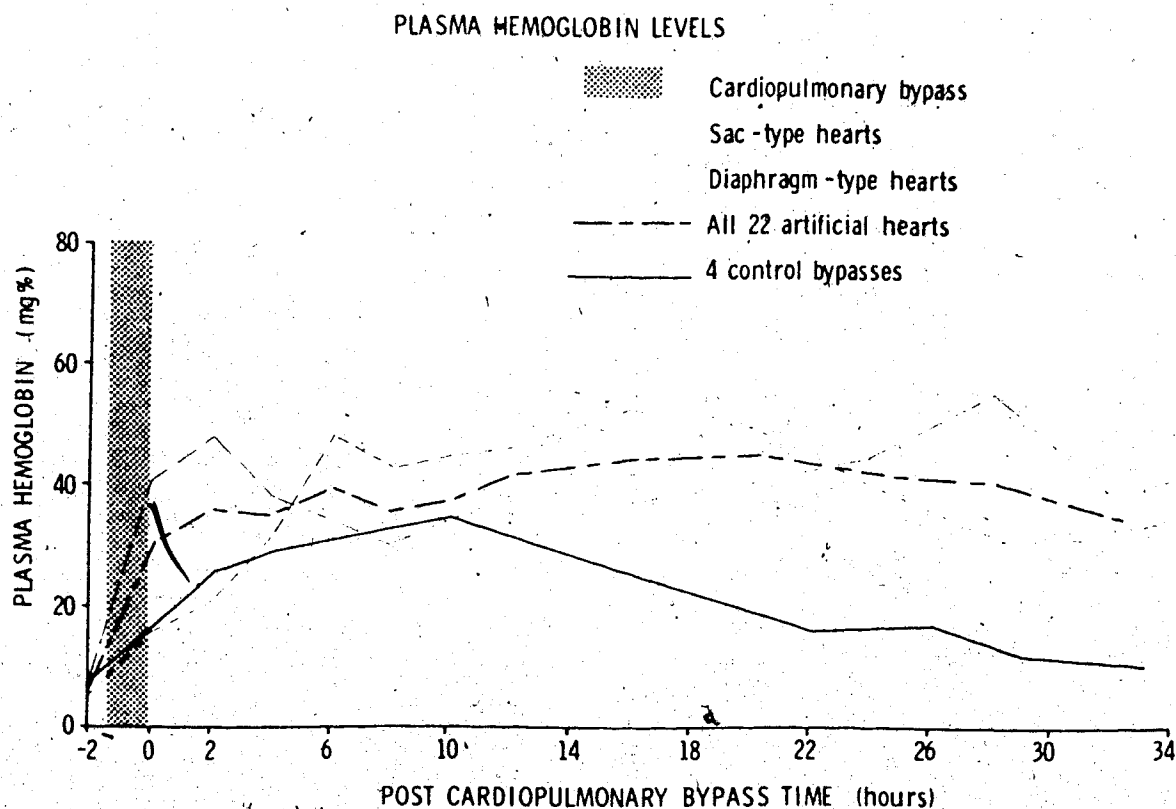

Fig. 4.44 Plasma hemoglobin levels in 22 calves with total replacement artificial hearts and in 4 bypass control calves.

Before operation, the average plasma hemoglobin level for the 26 calves was 8 mg%. Following cardiopulmonary bypass the average level was 32 mg%. The average maximum level, regardless of pumping time was 66 mg%. The highest level reached by any animal was 229 mg%.

in a calf with a sac-type heart after only 3 hours of pumping whose preoperative level was already 22 mg.%. The lowest level recorded was with a sac-type heart after 33 hours of pumping. There was no general pattern followed by all the animals. In some cases the highest level was recorded soon after bypass followed by a gradual decrease and in others, the levels of plasma hemoglobin increased until death. On the average, the level recorded after bypass increased slightly during the first 10 hours, then decreased.

The control animals subjected to cardiopulmonary bypass only also produced varied results. The highest level was 179 mg.% after 20 hours and the lowest level 3 mg.% after 29 hours. The average high was 34 mg.% and the average low was 10 mg.%. On the average, the highest level was reached 10 hours after bypass and showed a general decline thereafter.

Causes of Hemolysis

The hemolysis seen in the implantations was always due to an extrinsic disorder, that of mechanical trauma. During surgery, the cardiopulmonary bypass exposes red blood cells to a large prosthetic surface and to direct mechanical trauma caused by the roller pumps and oxygenator. When circulation was provided by the artificial heart the red cells were exposed to a smaller prosthetic surface and mechanical trauma reduced only to that produced by the device.

Since maximum plasma hemoglobin levels were often seen soon after cardiopulmonary bypass in both implantation and controls it is reasonable to assume that the traumatic effects of the bypass are more severe than those produced by the artificial heart.

If one examines the average hemolysis levels preoperatively at the end of bypass and after 33 hours of pumping it can be seen that during cardiopulmonary bypass the average hemolysis rate is 19 mg./hr. and that during pumping with the artificial hearts, the average hemolysis rate is only 0.16 mg./hr. The same procedure for the control animals yields hemolysis rates of 8 mg./hr. during bypass and 0.18 mg./hr. postoperatively. These figures would indicate that hemolysis caused by cardiopulmonary bypass occurs at a rate up to 119 times greater than that caused with the artificial heart. It is not possible to evaluate the absolute degree of hemolysis caused by the artificial heart measured over only 33 hours. As can be seen from the controls not all postoperative levels had returned to preoperative levels by 33 hours after bypass. In general, however, the control levels after 33 hours were lower than implantation levels after the same period indicating that some hemolysis is likely occurring in the artificial heart.

Comparing the plasma hemoglobin levels recorded in three 33 hour survivors, (Fig. 4.45) one control, one sac-type heart and one diaphragm type heart, the control animal had regained its preoperative level by the 29th hour. At the same time, the animals with artificial hearts still had elevated levels. Although the higher levels may be due to hemolysis within the artificial hearts, it is also possible that the higher levels are due to a reduced cardiac output. A lower kidney blood flow or degenerated kidney function may reduce the kidney's ability to dispose of the hemoglobin in the blood produced by the cardiopulmonary bypass. Quite clearly, the animal with the sac-type device had a rapidly decreasing plasma

hemoglobin level at the time of its death.

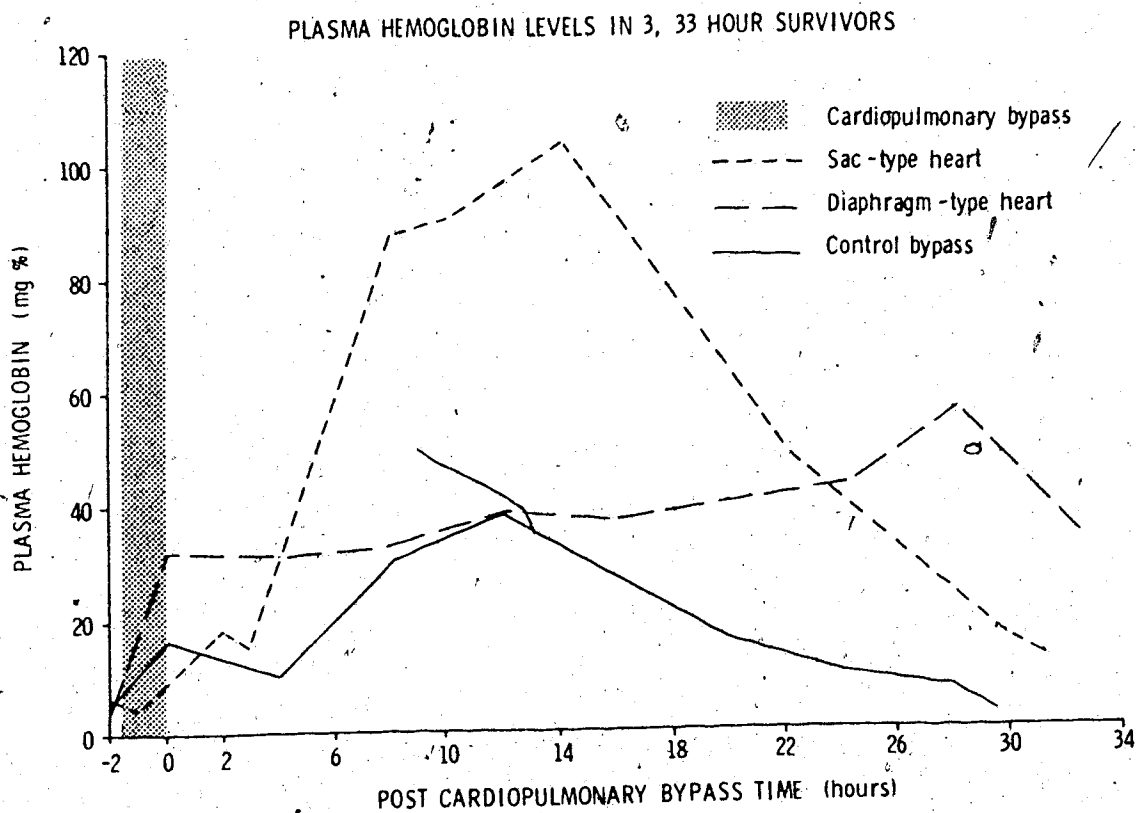

Fig. 4.45 Plasma hemoglobin levels in 3, 33 hour survivors.

There are other factors affecting the measured plasma hemoglobin levels. Some of the longer survivors with sac-type hearts received infusion of several liters of fluids which may have caused a significant hemodilution. The hemodilution would tend to lower the concentration of hemoglobin in the plasma giving a reduced indication of hemolysis. The hemodilution may also have been responsible for the "apparent" anemia seen in some animals with sac-type hearts.

The conclusion is that the artificial hearts likely cause some red cell hemolysis but that the degree of hemolysis may be very slight. 33 hour survivors are not long enough to evaluate this factor

since the animals have by that time not yet overcome the direct effects of surgery and cardiopulmonary bypass.

Platelet Loss

In all animals, either with artificial hearts or controls, there was a large decrease in the platelet count during cardiopulmonary bypass. (Fig. 4.46) There was then a slight increase with the infusion of blood after bypass followed by a gradual decrease throughout the experiment.

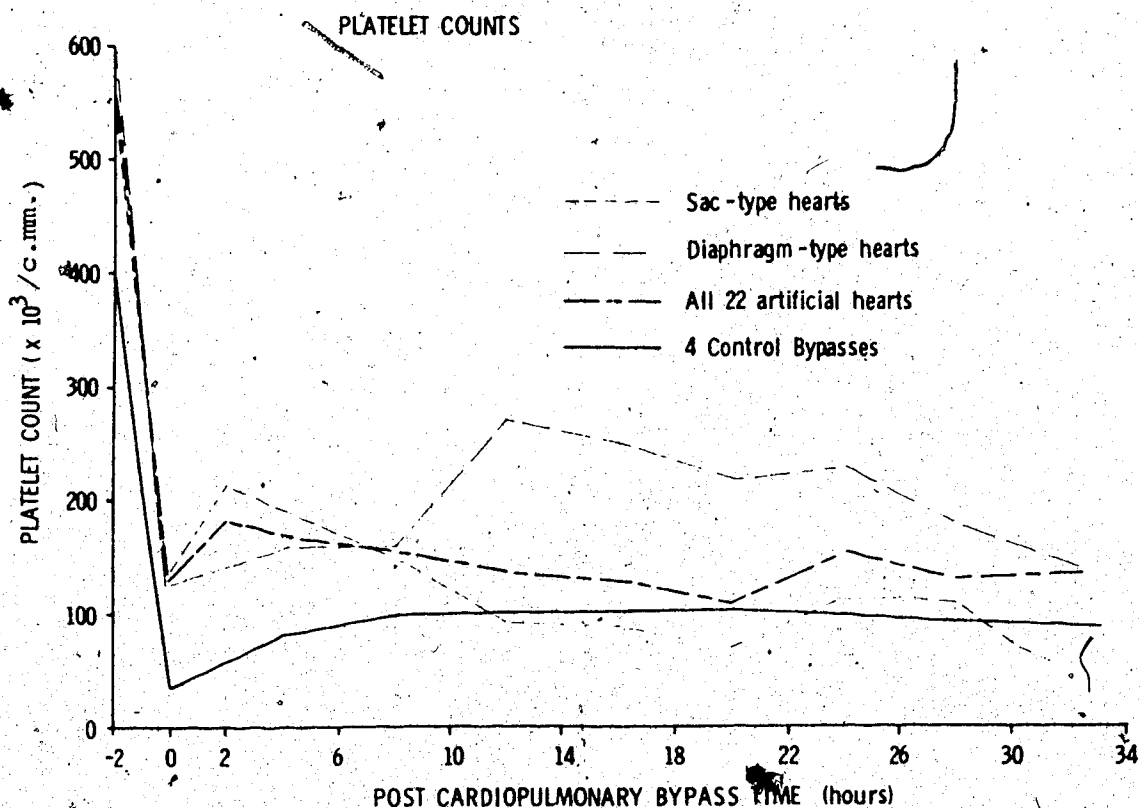

Fig. 4.46 Platelet counts in 22 calves with total replacement artificial hearts and in 4 bypass control calves.

Platelet counts were slightly lower in the control animals through the operative levels. Preoperative levels of artificial hearts ranged from 300,000/c./mm. to

906,000 c./mm. with an average of 583,000. After bypass, the levels ranged from 43,000 to 236,000 averaging 135,000. The preoperative controls counts ranged from 180,000 to 582,000 with an average of 376,000 and post-bypass counts ranged from 17,000 to 55,000 for an average of 36,000.

Causes of Platelet Loss

The great platelet loss seen in all animals may be attributed to the surgical procedure including cardiopulmonary bypass, the quality of blood used for infusions, and in the implantations; activation of platelets by the prosthetic device.

During the surgical procedure the platelets may be either destroyed by direct trauma or activated by foreign surface contact. They may also be destroyed by chemicals from anticoagulants, anesthetics and other drugs. During cardiopulmonary bypass the platelets may either sequester into the external system, be destroyed or aggregate within the system. They may also be destroyed or aggregate within the animal's vascular system or sequester into an extravascular system. It is clear from the control animals that the initial platelet loss which is also the greatest loss must occur before the termination of bypass.

Following bypass the animals received transfusions of blood. Due to the method of collection and the short platelet survival time in bovine blood, there was possibly very few viable platelets in the transfused blood. The slight rise in platelet count following blood transfusions was probably a result of a reduction in the degree of hemodilution.

Following implantation of the artificial heart there was a general decrease in the platelet count above that seen in the control animals. This decrease may be due to the effects of hemodilution, to the further activation or destruction of platelets by the device or by the further aggregation or sequestering of platelets as a result of decreased blood flow rates produced by the artificial heart. Evidence of clotting within the ventricles and of platelet aggregates within other organs would indicate that the artificial heart is activating platelets to some degree. For the control animals platelet loss was 289,000/hr. during bypass and platelet recovery was 1,770/hr. after bypass. For animals with artificial hearts the rate of loss was 350,000/hr. during bypass and a further 1110/hr. during pumping with the device.

The conclusion is that the artificial heart is likely causing platelet loss, but that 33 hours postoperatively is not long enough to quantitatively evaluate the degree of platelet loss attributable to the artificial heart and not to the surgical procedure alone.

Disseminated Intravascular Coagulation

Disseminated intravascular coagulation occurs when the clotting mechanism is activated within circulating blood. This coagulation may be initiated by over 30 different suspected etiological factors [64] of which at least 10 have been seen in the implantations. As D.I.C. proceeds consumption of coagulation factors occurs. The formation of intravascular clots with resulting sludging of capillary blood flow and progressive acidosis yields a state of shock. D.I.C. is character-

ized by a decreased arterial blood pressure, a diastolic hypotension, progressive decrease in fibrinogen, platelets, prothrombin and other clotting factors and an increase in partial thromboplastin time, prothrombin time and clotting time. Capillary sludging produces a diastolic hypotension, low pH and low pO_2 . Fibrin clots are found in the lung, kidney and liver. These changes have been seen in calves with the artificial heart.

Since the most severe blood trauma occurs during cardiopulmonary bypass, it may be an important factor in initiating the D.I.C. The hemolytic anemia leads to tissue anoxia and releases large amounts of thromboplastin into the circulation which is known to cause intravascular clotting. Activated platelets contribute to the coagulation and lysed platelets release vasoactive humoral factors of serotonin and A.D.P. which contribute to arteriolar constriction. Catecholamines and other humoral factors released by operative trauma, stress, and anesthesia further contribute to arteriolar constriction. The sludging of capillary flow which results distal to the constricted arterioles produced anoxic, acidotic blood which is hypercoagulable, leading to intercapillary coagulation. Fibrin clots have occasionally been seen in post-mortem lungs, kidneys and livers.

Lactic acid levels increased sharply after pumping with the artificial heart indicating anoxia and anaerobic respiration at the cellular level. This anoxia and increased lactic acid level contributes to the acidosis seen in animals suffering from a low cardiac output. The low cardiac output must also have contributed to the consumption coagulopathy.

Heparin-protamine sulphate imbalance may also be a factor

in the D.I.C. Clotting times in glass have varied from 7 minutes to infinity but in general, the blood is hypocoagulable with clotting times usually 2 to 3 times normal.

Although all longer surviving calves with artificial hearts exhibited a consumptive coagulopathy of varied degree, fibrin clots were not seen at all autopsies. This does not rule out the existence of a D.I.C. contributing to shock. An active fibrinolytic system may cause clots to be absent at death, [107, 108] the reticulo-endothelial system may clear some of the fibrin or clots may not have been seen because of sampling errors. [108]

It is very likely that a consumptive coagulopathy may contribute to progressive irreversible shock occurring in animals surviving more than 8 hours. It is however, not apparent to what degree the coagulopathy and shock are attributable to the artificial heart alone and not to the surgical procedure.

5. Experimental Animals and Surgical Procedures

The choice of experimental animals has been a problem. Early experiments with dogs were not successful because of the animals' low tolerance of cardiopulmonary bypass and small size. Pigs are difficult to handle, have difficult blood vessels to expose and also do not tolerate cardiopulmonary bypass well. Up until now, calves have been our best choice of animal due to their human-like size and almost year-round availability in Western Canada. Unfortunately, calves also suffer many inadequacies as a model for total heart transplantation.

The four control experiments with cardiopulmonary bypass only for 70 minutes were also struck with complications seen in

the total replacements.

Of the four calves, only one lived 33 hours without respiratory support. One lived 33 hours with ventilation, one died after 24 hours with pulmonary complications and the fourth suffered acute pulmonary edema during surgery. The lung complications were not unlike those seen in the total implantations. The control lungs were all congested, hemorrhagic and edematous in the lower parts of the lower lobes.

The control animals were young (about 3 months) like those that received artificial hearts and all were unable to withstand the insult of the surgery and cardiopulmonary bypass. The immaturity of the calf lungs and their chest anatomy may have contributed to these complications.

The control animals also showed levels of blood damage comparable to those with artificial hearts. It may be that the calves' red blood cells hemolyse easily and that their platelets are quickly activated and traumatized.

Some of the calves used for both controls and implantations have not been healthy. In several cases, they have had lobar pneumonia or ring worm. Sometimes their general health was questionable. Some animals had a glistening, clean coat, bright eyes and good posture while others had a dusty, lice-ridden coat, watery eyes, and poor posture. One calf although healthy in appearance was a runt.

The poor recovery of control animals indicates that either the species of animal is unsuitable for the experiments or that the techniques for surgery and postoperative care are inadequate.

The operative procedure, cardiopulmonary bypass, respiratory

care and postoperative procedures all have evolved from those developed for human beings. It appears that many of these techniques are not suitable for the calf. Calves require a long fasting time (48 hours) to clear their rumens to prevent bloating. To avoid foaming within the extracorporeal circulation the dose of Heparin required is far greater than that required for humans. Pressure catheters clot very quickly in calves sometimes resulting in kidney infarctions when flushed. Hand-bagging the lungs during surgery appears to cause far less pulmonary damage than does an automatic-volume respirator. Calves are also susceptible to pulmonary hypertension following bypass leading to the risk of right heart failure. In two of the control experiments the calves required an Isuprel drip to prevent right heart failure.

Skin to skin time for the implantations averaged 4 hours 23 minutes. When operated on in the supine position this may be too long, predisposing to lung congestion. A larger surgical team (2 surgeons and 2 assistants) would likely reduce the time by one hour which would shorten the duration of mechanical ventilation and help prevent lung congestion.

Cardiopulmonary bypass times averaged 77 minutes. In a previous set of four control animals used to evaluate the effects of bypass on the calf lung bypass times in excess of 75 minutes were found to produce progressive lung deterioration after bypass. Bypass times of less than one hour would likely greatly reduce the degree of pulmonary complications.

In many cases there was considerable postoperative bleeding from the chest. Frequently large volumes of clots were found in the

chest cavity at autopsy.

These examples point out that calves demand surgical techniques and after care different from those developed for human beings. Techniques suitable for a specific species of animal must be developed by trial and error. Many changes and improvements in implantation procedure have occurred concurrently with the development of the artificial heart but the calf still presents many surgical-medical challenges.

These five major limiting factors are presently confronting artificial heart developments. It must be remembered that they are limiting the performance of artificial hearts with external power sources which operate for relatively short periods. As survival times increase, so will the number and magnitude of the limiting factors.

Longer survivals will be complicated with infection, particularly with extracorporeal power sources requiring transcutaneous tubing or wiring. Infection has already been named as the cause of death in animals surviving up to 10 days by Akutsu.^[59]

Longer pumping times will also lead to fatigue of artificial heart materials. Breakage of artificial hearts has been a common problem among some investigators.^[59]

Although utilizing passive atrial filling of the ventricles to achieve a "starling regulation" of pump outputs is at present the simplest and most effective method of heart control, it may not be satisfactory for longer terms of pumping. Kawai^[60] and Akutsu^[59] have both found that longer survival times are producing symptoms of right heart failure with an increasing central venous pressure. Even

a heart with very high output (12 liters/minute) does not prevent this [109] suggesting that other methods of left and right ventricular control may be necessary.

The adoption of internal power sources alone will add another order of magnitude to the problems.

If all the mechanical and surgical-medical problems are solved the limiting factors of the future may well become psychological, moral and economic.

CHAPTER V

CONCLUSIONS AND SUGGESTIONS FOR FURTHER WORK

I have described the results from a three year artificial heart program. A series of 22 total heart replacements was conducted with survivals in calves up to 33 hours. This series has led to the identification of five major limiting factors currently facing artificial heart development:

- low cardiac output
- thrombosis
- pulmonary complications
- hematological changes

and experimental animals and surgical techniques.

There now exists three challenges for researchers pursuing improvements in total artificial heart performance. Two of these are engineering type problems.

Firstly, there must be developed more suitable construction materials for implantable artificial hearts. The most important properties that these new materials will require is that they be totally non-hemolytic and antithrombogenic. They will also have to be non-carcinogenic, non-antigenic, non-electrolytic and non-toxic. Long term implantations will also require materials that are insensitive to body chemicals and have a great resistance to fatigue. A ten year fatigue life would require about 500 million cycles. Some of these material requirements have already been partially met but the ideal material has not yet been developed and presents a tremendous challenge.

Secondly, the new ideal materials will have to be utilized in a more suitable design than exists today. A pumping principle will

have to be developed that more closely mimics the natural heart and produces a more physiological output pressure waveform. The device will have to be light enough and small enough to be contained within the natural pericardium. This requirement is essential to prevent venous compression and interference with pulmonary function. When the importance of all natural heart functions are fully understood the duplication with a mechanical design will likely be the least difficult of the three challenges.

Thirdly, the surgical-medical problems accompanying total heart replacement have prevented the devices from exhibiting their full potential. More ideal experimental animals will have to be found. Certainly, man would be the best experimental animal, but perhaps another species of primate could be utilized. When a suitable animal is found, surgical-medical procedures will have to be developed appropriate for the species. In particular, better methods of respiratory management will have to be investigated.

In the early history of artificial heart replacement engineering problems were superior to surgical-medical problems. Today, the situation is reversed. It will be impossible to design the perfect artificial heart until such time that physiological studies explicitly dictate what are the ideal specifications and design criteria. These specifications are being assembled through the pooled experiences of hundreds of experimenters. We hope that the identification of major complications accompanying total artificial heart replacements in this program will contribute to the eventual solution of some of the barriers to a clinically acceptable device.

REFERENCES

1. The Canada Yearbook, 1972: 262, Published by the Dominion Bureau of Statistics, Ottawa 1972.
2. KOLFF, W.J.: An artificial heart inside the body. Sci Am 213, No. 5: 38-46, 1965.
3. DEMIKHOV, V.P.: Experimental transplantation of vital organs. Consultants Bureau, 1962.
4. SALISBURY, P.F.: Presidential address. Trans Am Soc Artif Intern Organs 3: 37-42, 1957/1958.
5. KUSSEROW, B.K.: Permanently indwelling intracorporeal blood pump to substitute for cardiac function. Trans Am Soc Artif Intern Organs 4: 227-230, 1958/1959.
6. KOLFF, W.J., AKUTSU, T.: Permanent substitutes for valves and hearts. Trans Am Soc Artif Intern Organs 4: 230-232, 1958/1959.
7. AKUTSU, T.: Artificial hearts: available types, BREST, A.N.: Heart Substitutes: 165, Published by Thomas C.C., Springfield U.S.A., 1966.
8. LIOTTA, D., TALIANI, T., GIFFONIELLO, A.H., et al: Artificial heart in the chest: preliminary report. Trans Am Soc Artif Intern Organs 7: 318, 1961.
9. MORRIS, D.T., COUVES, C.M.: Experiences with a sac-type artificial heart. Can Med Assoc J 105: 483-487, 1971.
10. AFFELD, K., BUCHERL, E.S., MOMNHAUPT, R.: An artificial heart implanted in the abdominal wall. Trans Am Soc Artif Intern Organs 17: 464-467, 1971.
11. KNIGHT, C.J., JULIAN, D. G., MacLEOD, N. et al: An artificial heart with independently variable pulse parameters. Trans Am Soc Artif Intern Organs 17: 433-436, 1971.
12. ATSUMI, K., HORI, M., IKEDA, S., et al: Artificial heart incorporated in the chest. Trans Am Soc Artif Intern Organs 9: 292-298, 1963.
13. KOLFF, W.J.: Discussion. Trans Am Soc Artif Intern Organs 15: 251, 1969.
14. KOLFF, W.J., AKUTSU, T., DRYER, B.: Artificial heart in the chest and use of polyurethane for making hearts, valves, and aortas. Trans Am Soc Artif Intern Organs 5: 298, 1959.

15. AKUTSU, T., HOUSTON, C.S., KOLFF, W.J.: Artificial hearts inside the chest, using small electro-motors. *Trans Am Soc Artif Intern Organs* 6: 2 -302, 1960.
16. AKUTSU, T., SEIDEL, W., MIRKOVITCH, V. et al: An electro-motor driven pendulum-type artificial heart inside the chest. *Trans Am Soc Artif Intern Organs* 7: 374-377, 1961.
17. SEIDEL, W., AKUTSU, T., MIRKOVITCH, V. et al: Air-driven artificial hearts inside the chest. *Trans Am Soc Artif Intern Organs* 7: 378-383, 1961.
18. AKUTSU, T., MIRKOVITCH, V., TOPAZ, S.R., et al: Silastic sac-type of artificial heart and its use in calves. *Trans Am Soc Artif Intern Organs* 9: 281-284, 1963.
19. AKUTSU, T., TOPAZ, S.R., MIRKOVITCH, V., et al: Problems in calf lungs immediately after implantation of an artificial heart. *Trans Am Soc Artif Intern Organs* 10: 162-165, 1964.
20. AKUTSU, T., MIRKOVITCH, V., TOPAZ, S.R.: A sac type of artificial heart inside the chest of dogs. *J Thorac Cardiovasc Surg* 47: No. 4, 512-527, 1964.
21. AKUTSU, T., CHAPTAL, P.A., AGRAWAL G. et al: Compact prosthetic total heart. *Trans Am Soc Artif Intern Organs* 12: 288-293, 1966.
22. AKUTSU, T., MIRKOVITCH, V., TOPAZ, S.R. et al: A pneumatically driven sac type of intrathoracic artificial heart. *Circulation* 29: 86-90, 1964.
23. NORTON, S.H., AKUTSU, T., KOLFF, W.J.: Artificial heart with anti-vacuum bellows. *Trans Am Soc Artif Intern Organs* 8: 131-134, 1962.
24. HALL, C.W., AKERS, W.W., O'BANNON, W. et al: Intraventricular artificial heart. *Trans Am Soc Artif Intern Organs* 11: 263-264, 1965.
25. DeBAKEY, M.E., HALL, C.W.: Towards the artificial heart: *New Scientist* 22, 1964.
26. HALL, C.W., LIOTTA, D., SHENLY, W. et al: Development of artificial intrathoracic circulatory pumps. *Am J Surg* 108, 1964.
27. DeBAKEY, M.E., LIOTTA, D., HALL, C.W.: Left-heart bypass using an implantable blood pump. *Mechanical Devices to Assist the Failing Heart*, ch. 18, Published by the National Academy of Sciences - National Research Council, Washington D.C., 1966.

28. SAXTON, G.A., Jr., ANDREWS, C.B.: An ideal heart pump with hydrodynamic characteristics analagous to the mamalian heart. Trans Am Soc Artif Intern Organs 6: 288-290, 1960.
29. HASTINGS, F.W., POTTER, W.H., HOLZER, J.W.: Artificial intra-corporeal heart: Trans Am Soc Artif Intern Organs 7: 323-325, 1960.
30. KIMOTO, S., ATSUMI, K., SAKURAI, Y. et al: Studies on the artificial heart driven with controlled gas pressure device on the pressure generator for general use. Trans Am Soc Artif Intern Organs 10: 66-67, 1964.
31. LOEHR, M.L., KOSCH, W.F. III, SINGER, M. et al: The piezoelectric artificial heart. Trans Am Soc Artif Intern Organs 10: 147-150, 1964.
32. BARILA, T.G., NUNN, D.B., WOODWARD, K.E.: A blood pump powered and controlled by a fluid amplification system. Trans Am Soc Artif Intern Organs 8: 30-34, 1962.
33. CASTANEDA, A., BERNSTEIN, E.F., GLEASON, L. et al: Further in vitro evaluation of the army heart pump. Trans Am Soc Artif Intern Organs 10: 57-62, 1964.
34. WOODWARD, K.E., STRAUB, H., NOSE, Y. et al: An intrathoracic artificial heart controlled by fluid amplifiers. Trans Am Soc Artif Intern Organs 12: 294-300, 1966.
35. BURNS, W.H., LOUBIER, R., BERGSTEDT, R.: The development of an electrohydraulic implantable artificial heart. Trans Am Soc Artif Intern Organs 11: 265-268, 1965.
36. BURNS, W.H., SHUMACKER H.B. Jr.: Implantable mechanical cardiac substitute. J Cardivasc Surg 9, No. 1: 17-21, 1968.
37. BURNS, W.H., LOUBIER, R.J., FARLOW, J.M.: The development of an intrapericardial cardiac replacement. Trans Am Soc Artif Intern Organs 12: 272-274, 1966.
38. BURNS, W.H., SHUMACKER, H.B., LOUBIER, R.J.: The totally implantable mechanical heart - an appraisal of feasibility. Ann Surg 164, No. 3: 445-455, 1966.
39. PIERCE, W.S., BURNEY, R.G., BOYER, M.H. et al: Problems encountered in experiments during the development of our artificial intrathoracic heart. Trans Am Soc Artif Intern Organs 8: 118-122, 1962.
40. HILLER, K.W., SEIDEL, W., KOLFF, W.J.: A servomechanism to drive an artificial heart inside the chest. Trans Am Soc Artif Intern Organs 8: 125-130, 1962.

41. KOLFF, W.J., MILLER, K., SEIDEL, W. et al: Results obtained with artificial hearts driven by the N.A.S.A. servomechanism and the pathologic physiology of artificial hearts. Trans Am Soc Artif Intern Organs 8: 135-139, 1962.
42. BURNEY, R.G., PIERCE, W.S., WILLIAMS, K.R. et al: Studies on an artificial heart controlled by a venous pressure servomechanism. Trans Am Soc Artif Intern Organs 9: 299-303, 1963.
43. HASTINGS, F.W., HOLTER, J.W., POTTER, W.H.: A progress report on the development of a synthetic intracorporeal blood pump. Trans Am Soc Artif Intern Organs 8: 116-117, 1962.
44. NOSE, Y., KOLFF, W.J.: Some experiences with artificial hearts inside the chest, driven with a simple inexpensive servo-system. J Cardiovasc Surg 9, No. 1: 22-30, 1968.
45. NOSE, Y., SARIN, C.L., KLAIN, M. et al: Elimination of some problems encountered in total replacement of the heart with an intrathoracic mechanical pump: venous return. Trans Am Soc Artif Intern Organs 12: 301-309, 1966.
46. WILDEVUUR, C.R.H., MRAVA, G.L., CROSBY, M.J. et al: An artificial heart sensitive to atrial volume. Trans Am Soc Artif Intern Organs 14: 276-282, 1968.
47. LIOTTA, D., HALL, C.W., COOLEY, D.A. et al: Prolonged ventricular bypass with intrathoracic pumps. Trans Am Soc Artif Intern Organs 10: 154-156, 1964.
48. HALL, C.W., LIOTTA, D., DeBAKEY, M.E.: Bioengineering efforts in developing artificial hearts and assistors. Am J Surg 114, No. 1: 24-30, 1967.
49. HALL, C.W., LIOTTA, D., DeBAKEY, M.E.: Artificial heart - present and future. Research in the Service of Man.
50. AKERS, W.W., O'BANNON, W., HALL, C.W. et al: Design and operation of a paracorporeal bypass pump. Trans Am Soc Artif Intern Organs 12: 86-90, 1966.
51. LIOTTA, D., HALL, C.W., VILLANUEVA, A. et al: A pseudoendocardium for implantable blood pumps. Trans Am Soc Artif Intern Organs 12: 129-134, 1966.
52. DeBAKEY, M.E., HALL, C.W., HELLUMS, J.D., et al: Orthotopic cardiac prosthesis: preliminary experiments on animals with biventricular artificial heart. Cardiovascular Research Centre Bulletin: April-June 1969.

53. COOLEY, D.: First human implantation of cardiac prosthesis for staged total replacement of the heart. *Trans Am Soc Artif Intern Organs* 15: 252-263, 1969.
54. KAWAI, J.: Discussion manuscript No. 70. *Trans Am Soc Artif Intern Organs* 17: 446, 1971.
55. TAKANO, H., TAKAGI, H., TURNER, M.D. et al: Problems in total artificial heart. *Trans Am Soc Artif Intern Organs* 17: 449-455, 1971.
56. KWAN-GETT, C.S., BACKMAN, D.K., DONOVAN, F.M. et al: Artificial heart with hemispherical ventricles II and disseminated intravascular coagulation. *Trans Am Soc Artif Intern Organs* 17: 474-481, 1971.
57. ROSS, J.N. Jr., AKERS, W.W., O'BANNON, W. et al: Problems encountered during the development and implantation of the Baylor-Rice orthotopic cardiac prosthesis. *Trans Am Soc Artif Intern Organs* 18: 168-175, 1972.
58. KAWAI, J., DONOVAN, F.M., PETERS, J.L. et al: New problems with the artificial heart and prolonged survival. *Abstracts of the American Society for Artificial Internal Organs* 24, 1972.
59. TAKAGI, H., TAKANO, H., HENSON, E.C. et al: Long-term survivals in total artificial heart and evaluation of our device. *Abstracts of the American Society for Artificial Internal Organs* 1: 51, 1972.
60. KAWAI, J., PETERS, J., DONOVAN, F. et al: Implantation of a total artificial heart in calves under hypothermia with 10 day survival. *J Thorac Cardiovasc Surg* 64, No. 1: 45-60, 1972.
61. AKUTSU, T., TOPAZ, S.R., SEN GUPTA, A. et al: A composite experimental artificial heart. *Surgery* 59, No. 5: 817-820, 1966.
62. AKUTSU, T., TAKAGI, H., TAKANO, H.: Total artificial hearts with built-in valves. *Trans Am Soc Artif Intern Organs* 16: 392-397, 1970.
63. KWAN-GETT, C.S., ZWART, H.H.J., KRALIUS, A.C. et al: A prosthetic heart with hemispherical ventricles designed for low hemolytic action. *Trans Am Soc Artif Intern Organs* 16: 409-415, 1970.
64. DeVRIES, W.C., KWAN-GETT, C.S., KOLFF, W.J.: Consumptive coagulopathy, shock, and the artificial heart. *Trans Am Soc Artif Intern Organs* 16: 29-36, 1970.

65. KWAN-GETT, C.S., OROS, R., NOSE, Y.: Detection of thrombogenic areas in artificial hearts. *Trans Am Soc Artif Intern Organs* 13: 313-316, 1967.
66. NOSE, Y., CROSBY, M., WOODWARD, K. et al: Respect the integrity of the large veins and Starlings Law. *Trans Am Soc Artif Intern Organs* 13: 273-279, 1967.
67. KWAN-GETT, C.S., WU, Y., COLLAN, R. et al: Total replacement artificial heart and driving system with inherent regulation of cardiac output. *Trans Am Soc Artif Intern Organs* 15: 245-250, 1969.
68. KWAN-GETT, C.S., CROSBY, M.J., SCHOENBERG, A. et al: Control systems for artificial hearts. *Trans Am Soc Artif Intern Organs* 14: 284-290, 1968.
69. NORMAN, J.C., COUELLI, V.H., BERNHARD, W.F. et al: An implantable nuclear fuel capsule for an artificial heart. *Trans Am Soc Artif Intern Organs* 14: 204-208, 1968.
70. SANDBERG, G.W. Jr., HUFFMAN, F.N., NORMAN, J.C.: Implantable nuclear power sources for artificial organs: I. physiologic monitoring and pathologic effects. *Trans Am Soc Artif Intern Organs* 14: 172-179, 1970.
71. MOTT, W.E., COLE, D.W. Jr.: Development of a nuclear-powered artificial heart. *Trans Am Soc Artif Intern Organs* 18: 152-156, 1972.
72. LAFARGE, C.G., CARR, J.G., COLEMAN, S.J. et al: Hemodynamic studies during prolonged mechanical circulatory support. *Trans Am Soc Artif Intern Organs* 18: 186, 1972.
73. KLAIN, M., MRAVA, G.L., TAJIMA, K. et al: Can we achieve over 100 hours survival with a total mechanical heart? *Trans Am Soc Artif Intern Organs* 18: 437-444, 1971.
74. HERSHGOLD, E.J., KWAN-GETT, C.S., KAWAI, J. et al: Hemostasis, coagulation and the total artificial heart. *Trans Am Soc Artif Intern Organs* 18: 181-184, 1972.
75. BLUMBERG, M.S. et al: Artificial Heart Devices and Systems: A Conceptual Phase Study. Stanford Research Institute, Menlo Park, California. Published by the U.S. Dept. of Commerce, Washington, D.C.: II-2, 1966.
76. KANTROWITZ, A., KRAKAVER, J., SHERMAN, J.L. Jr.: A permanent mechanical auxiliary ventricle: experimental and clinical experience. *J Cardiovasc Surg* 9: 1, 1968.

77. LEINBACH, R.C., NYILAS, E., CAULFIELD, J.B. et al: Evaluation of hematological effects of intra-aortic balloon assistance in man. *Trans Am Soc Artif Intern Organs* 18: 493-500, 1972.
78. DeLANIA, G.A., NYILAS, E., BERNSTEIN, E.F.: Intra-aortic balloon pumping without heparin. *Trans Am Soc Artif Intern Organs* 18: 501-504, 1972.
79. EICHWALD, E.J.: Prosthesis versus transplant. *Trans Am Soc Artif Intern Organs* 8: 146-149, 1962.
80. KIRBY, C.K.: Presidential address. *Trans Am Soc Artif Intern Organs* 7: 153, 1961.
81. KOLFF, W.J.: Artificial organs in the seventies. *Trans Am Soc Artif Intern Organs* 16: 534-540, 1970.
82. GUYTON, A.C.: *Circulatory Physiology: Cardiac Output and its Regulation*. Published by W. B. Saunders Co., Philadelphia, 1963.
83. NOSE, Y., PHILLIPS, P., KOLFF, W.J.: Problems with materials used in the intrathoracic artificial heart. *Ann NY Acad Sci* 146, No. 1: 271-288, 1968.
84. BREST, A.N.: *Heart Substitutes, Mechanical and Transplant*. Published by Thomas, Springfield, Illinois, 1966.
85. MIRKOVITCH, V., AKUTSU, T., KOLFF, W.J.: Polyurethane aortas in dogs, three year's results. *Trans Am Soc Artif Intern Organs* 8: 79-84, 1962.
86. FLOREY, H.W.: *General Pathology*. Published by W. B. Saunders Co., Philadelphia, 1970.
87. BOYD, W.: *A Textbook of Pathology*. Published by Lea & Febiger, Philadelphia, 1970.
88. ROBBINS, S.L.: *A Textbook of Pathology, Third Edition*. Published by W. B. Saunders Co., Philadelphia, 1967.
89. IMAI, Y., TAJIMA, I., NOSE, Y.: Biolized materials for cardiovascular prosthesis. *Trans Am Soc Artif Intern Organs* 17: 6-9, 1971.
90. AKUTSU, T., TAKAGI, H.: Thrombus formation in implantable blood pumps. *Trans Am Soc Artif Intern Organs* 11: 55-58, 1969.
91. LYMAN, D.J., KWAN-GETT, C.S., ZWART, H.H.J. et al: The development and implantation of a polyurethane hemispherical artificial heart. *Trans Am Soc Artif Intern Organs* 17: 456-463, 1971.

92. LEININGER, R.I., EPSTEIN, M.M., FALB, R.D., et al: Preparation of nonthrombogenic plastic surfaces. *Trans Am Soc Artif Intern Organs* 12: 151-154, 1966.
93. FOURT, L., SCHWARTZ, A.M., QUASIUS, A. et al: Heparin-bearing surfaces and liquid surfaces in relation to blood coagulation. *Trans Am Soc Artif Intern Organs* 12: 155-162, 1966.
94. GRODE, G.A., ANDERSON, S.J., GROTTA, H.M. et al: Nonthrombogenic materials via a simple coating process. *Trans Am Soc Artif Intern Organs* 15: 1-6, 1969.
95. GARDNER, D.L., SHARP, W.V., EWING, K.L. et al: Stability of heparin s³⁵ attached to a modified polyurethane vascular prosthetic. *Trans Am Soc Artif Intern Organs* 15: 7-14, 1969.
96. KUSSEROW, B.K., LARROW, R., NICHOLS, J.: The urokinase-heparin bonded synthetic surface. An approach to the creation of a prosthetic surface possessing composite antithrombogenic and thrombogenic properties. *Trans Am Soc Artif Intern Organs* 17: 1-3, 1971.
97. ROBINSON, T.C., KITRILAKIS, S.S., HARMISON, L.T.: The development of an implanted left ventricular assist device and Rankine cycle power systems. *Trans Am Soc Artif Intern Organs* 16: 165-171, 1970.
98. LIOTTA, D., WIETING, D., HALL, C.W. et al: In vitro and in vivo flow studies in blood pumps. *Trans Am Soc Artif Intern Organs* 13: 280-287, 1967.
99. SAWYER, P.N., KAPLITT, M., AFSHAR, A. et al: A new plastic interface which has antithrombogenic characteristics and appears to mimic the vascular interface. *Trans Am Soc Artif Intern Organs* 12: 183-186, 1966.
100. LILLEHEI, R.C., LONGERBEAM, J.K., BLOCK, J.H. et al: The nature of experimental irreversible shock and its clinical application. *Int Anesthesiol Clin* 2: 297, 1964.
101. SAMBHI, M.P., WEIL, M.H., UNDOJI, V.N. et al: Adreno-corticoids in the management of shock. *Int Anesthesiol Clin* 2: 421, 1964.
102. LARSON, R.E., McGOON, D.C.: Experimental cardiac surgery in calves II. Management for aortic valve surgery. *J Surg Res* 3: 104, 1963.
103. LARSON, R.E., MOFFITT, E.A., McGOON, D.C.: Experimental cardiac surgery in calves. I. Anesthesia. *J Surg Res* 3: 101, 1963.

104. AKUTSU, T., MIRKOVITCH, V., TOPAZ, S.R. et al: Insertion of artificial hearts inside the chest of calves. *Ann Surg* 161: 365, 1965.
105. NOSE, Y., TOPAZ, S., SENGUPTA, A. et al: Artificial hearts inside the pericardial sac in calves. *Trans Am Soc Artif Intern Organs* 11: 255-262, 1965.
106. KING, L.G.: Resume of the adult respiratory distress syndrome. Lecture delivered to U of A medical students, 1972.
107. LASCH, H.G., HERNE, O., HUTH, R. et al: Pathophysiology, clinical manifestations, and therapy of consumptive coagulopathy. *Am J Cardiol* 20: 381, 1967.
108. MARARETTEN, W.: Local tissue damage in disseminated intravascular coagulation. *Am J Cardiol* 20: 185, 1967.
109. DONOVAN: Discussion. *Trans Am Soc Artif Intern Organs* 18: 185, 1972.

APPENDIXES

APPENDIX A

IN VITRO HEMOLYSIS TESTS

Early implantations with sac-type hearts models Mk II, III, IV and V displayed very high hemolysis indicated by plasma hemoglobin levels of up to 335 mg.%. In most cases, the ventricles filled poorly resulting in continual rubbing of opposing sac walls during systole. The mechanical trauma caused by the rubbing was suspected of being the major source of red cell hemolysis.

To confirm our suspicion an in vitro circulation was constructed using one ventricle, a compensation sac to somewhat simulate systemic resistance and a flow meter. (Fig. A.1)

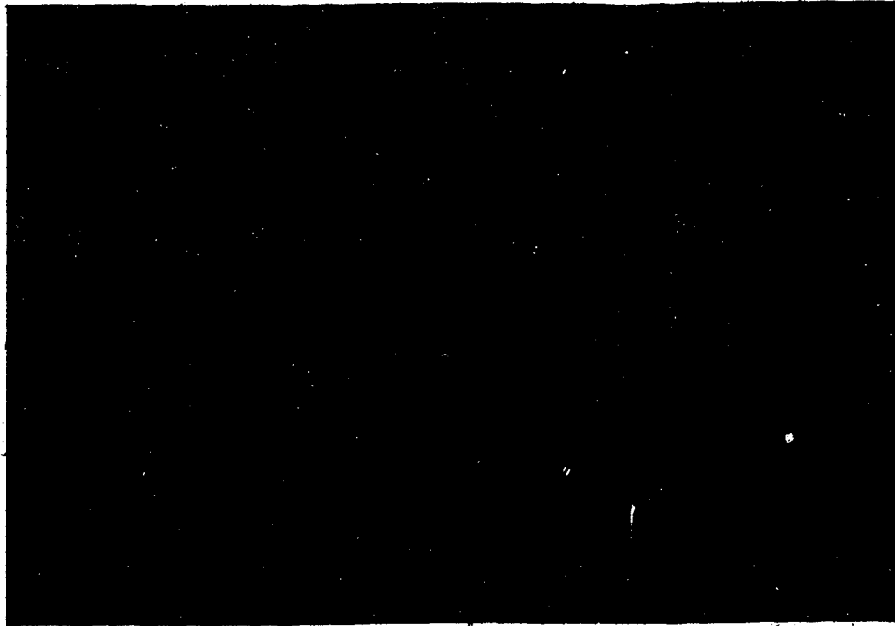

Fig. A.1 In vitro hemolysis testing apparatus.

The device was filled with fresh heparinized or A.C.D. blood, immersed in warm water and connected to the timing device. The priming volume of the circulation was 400 ml.

A series of tests was run using different driving pressures and systolic durations. In this way the ventricle could be controlled to pump with or without rubbing of opposing sac walls.

Hemolysis was evaluated by sampling plasma hemoglobin every 30 minutes. In order to extrapolate the in vitro conditions to in vivo conditions, the following expression was developed to estimate equivalent pumping times:

$$T_{est} = (T_{exp}) \frac{(V_{vivo})}{(V_{exp})} \frac{(F_{exp})}{(F_{vivo})} \frac{(R_{exp})}{(R_{vivo})} (1/2)$$

Where: T_{est} = estimated in vivo pumping time

T_{exp} = experimental pumping time

V_{vivo} = animal blood volume

V_{exp} = priming volume

F_{vivo} = animal blood flow rate

F_{exp} = experimental blood flow rate

R_{vivo} = animal heart rate

R_{exp} = experimental rate

(1/2) accounts for only one ventricle in the mock circulation.

For example, the experimental pumping time from a three hour run was extrapolated to human conditions.

$$T_{est} = (180) \frac{(5)}{(0.32)} \frac{(4.8)}{(5.0)} \frac{(120)}{(75)} (1/2) = 36 \text{ hours.}$$

Therefore, one hour pumping in the in vitro circulation represented about 12 hours of pumping in vivo in an adult human.

By expressing the hemolysis rate as a "hemolysis index" it was possible to compare the indices under different pumping conditions.

$$\text{The hemolysis index} = \frac{\text{experimental hemolysis (gHb)}}{\text{estimated in vivo pumping time (hr.)}}$$

The indices increased with increasing ventricular driving pressure and increasing rate. (Fig. A.2)

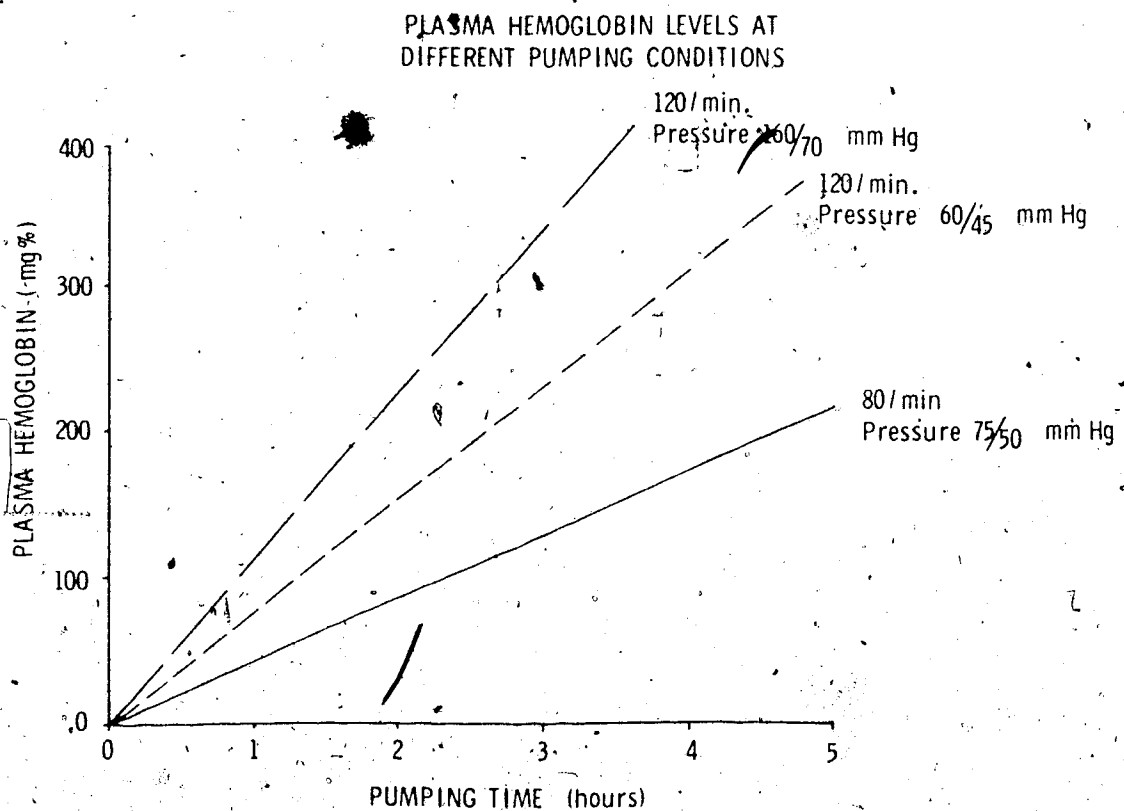

Fig. A.2 Increased driving pressure and increased rate increase hemolysis.

Both higher pressures and higher rates increased the sac rubbing. Although increased driving pressure causes higher shear stress in the blood and greater blood velocity it appeared that the sac rubbing was the major cause of the hemolysis.

When opposing sac walls did not touch, the hemolysis index was as low as 4 g. of hemoglobin per 24 hours of pumping. Since the human body can produce up to 8 g. of hemoglobin every 24 hours, the hemolysis caused by a sac-type device whose opposing walls did not touch might be acceptable.

APPENDIX B

THE DEVELOPMENT OF A PREBIOLIZED NATURAL RUBBER

From the evidence of clot formation within the ventricles of early sac-type hearts it was evident that natural rubber alone was not antithrombogenic. Imai^[89] demonstrated that natural rubber could be made more antithrombogenic by bonding protein to the rubber surface.

In an effort to improve our own rubber we prepared 400 test samples of varying proportions of liquid latex, Heparin and gelatin. Some of the samples were also treated either with heat or cross-linking agents such as formaldehyde, glyoxal and gluteraldehyde. Each sample was filled with 5cc. of fresh blood obtained directly from the carotid artery of an anesthetized dog. (Fig. B.1)

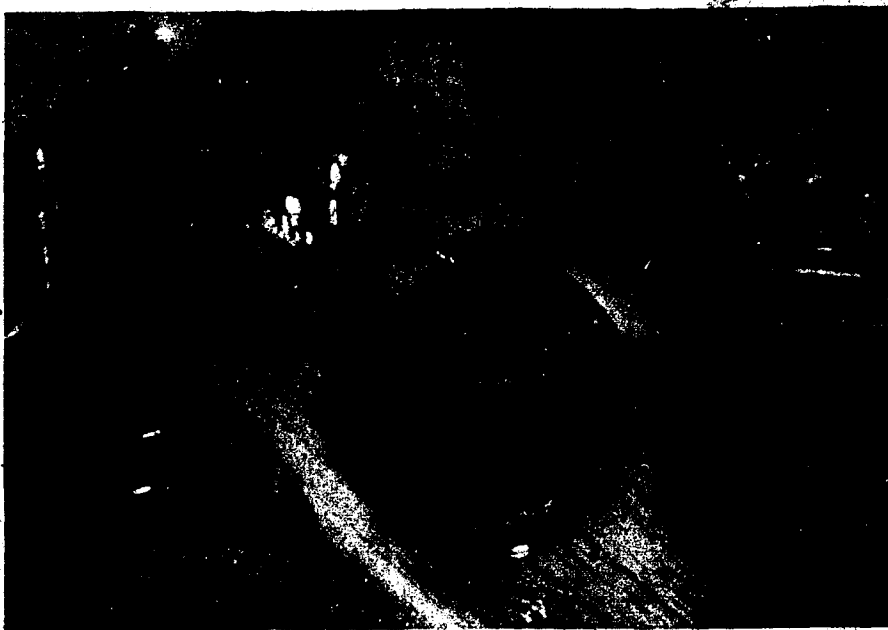

Fig. B.1 The clotting time of fresh canine blood was measured in samples of pre-biolized natural rubber.

The method used to determine the antithrombogenicity of the surfaces was to record the time of formation of the first recognizable fibrin fibres with the sample cups. When fibres were large enough to be picked up by a stainless steel needle, the "clotting time" was recorded. Clotting times were also measured in natural rubber alone and glass by the same method for controls.

Liquid latex with 5% Heparin and 5% gelatin has a clotting time about 4 to 5 times that for natural rubber alone. Higher concentrations of protein weaken the rubber. By heat treating the same sample the clotting time could be increased to 6 times that of natural rubber alone. Further chemical treatment of the sample increased the clotting time to 30 minutes, about 10 times that of natural rubber. (Fig. B.2)

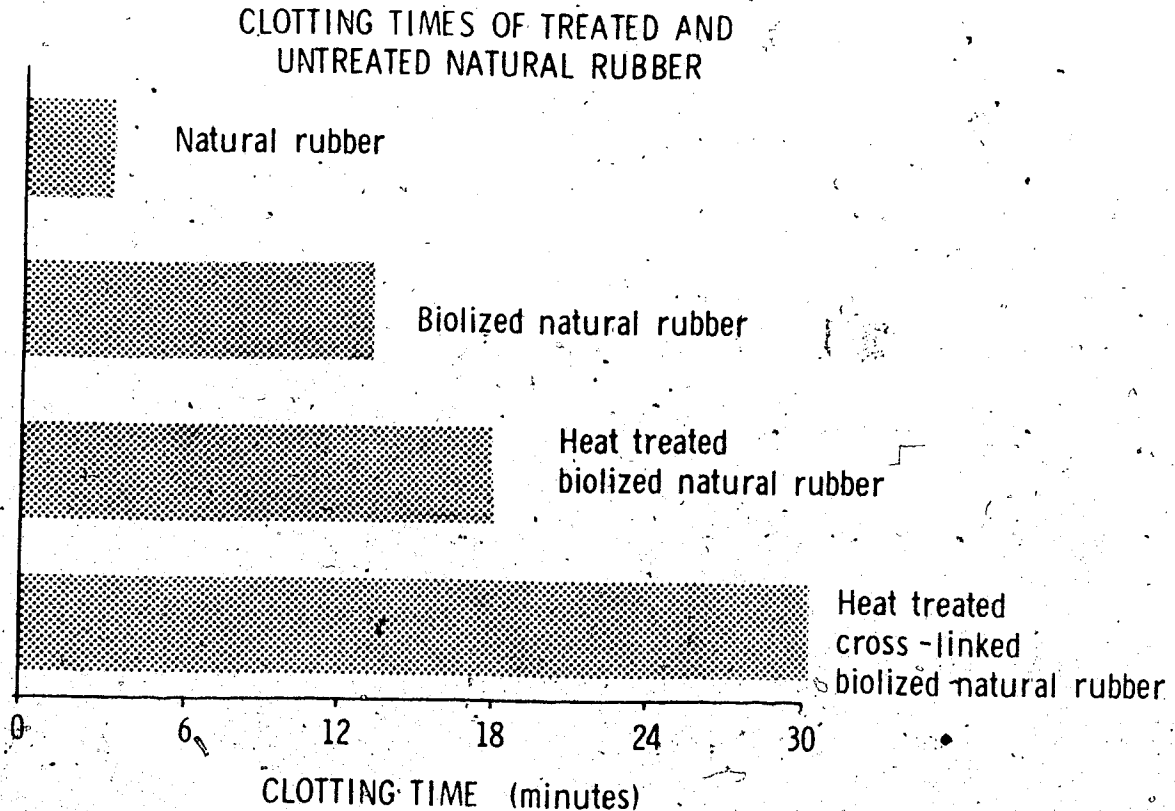

Fig. B.2 The clotting time of natural rubber was increased 10 fold by prebiolizing.

The Lee-White clotting times were 8-9 minutes for natural rubber alone and 60-80 minutes for the heat treated, cross-linked, proteinized latex.

Prebiolized and natural rubber grafts were implanted into the carotid arteries of dogs to compare them under in vivo conditions. (Fig. B.3)



Fig. B.3. Prebiolized natural rubber grafts were tested in vivo.

Pure natural rubber grafts would occlude within 80 minutes while the treated grafts remained patent for 300 to 400 minutes.

The 5-10 fold increase in clotting times was a considerable improvement and the prebiolized rubber was used to fabricate the sacs of the Mk VI and Mk VII hearts.

APPENDIX C

HYPOTHERMIA

We believed that cardiopulmonary bypass may trigger many of the pulmonary complications, blood damage and depressed peripheral vascular response seen in all early implantations. The use of deep hypothermia (19-22° C) would eliminate cardiopulmonary bypass and possibly the accompanying complications.

Three calves received Mk VI sac-type hearts under deep hypothermia with circulatory arrest.

Surgical Procedure Unique to Hypothermia

Thirty minutes after premedication with Trifluopromazine, 0.3 mg/kg., and Atropine, 0.015 mg/kg., halothane was used for induction and intubation. The anesthetic level was maintained at the third stage of anesthesia during cooling. Catheters for arterial and venous pressure monitoring, blood sample and fluid administration were inserted through the femoral vessels. Electrodes for electrocardiogram and electroencephalogram, thermister probes for midesophageal and midrectal temperatures were positioned. The animal was then immersed in a tub with ice and water in the kneeling position. Rheomacrolax 10% low molecular weight dextran, 10 ml/kg., was given intravenously during the cooling period when the rectal temperatures were between 35° and 28° C. At 28° C rectal temperature, Trifluopromazine, 0.3 mg/kg., and Heparin, 1 mg/kg., were given intravenously. After the body temperature fell below 28° C, the animal was ventilated manually and halothane was decreased from 0.3 to 0.5%. Cooling was terminated at

a rectal temperature between 24° and 21° C. (Fig. C.1)



Fig. C.1 Calves were anesthetized and cooled to 20° C in an ice water bath.

The animal was hyperventilated to produce respiratory alkalosis prior to circulatory arrest. After termination of cooling, body temperature usually drifted down to between 18° and 20° C. Circulatory arrest time was approximately 50 minutes. About one minute before beginning artificial heart pumping, the animal was mechanically ventilated at about 4 per minute. After completion of the surgical procedure, the animal was placed in a tub of water at 42° C in the kneeling position. Hyperventilation was employed during rewarming

but correction of acid-base imbalance was generally not necessary. Rewarming was terminated at a rectal temperature between 35° and 37° C. (Fig. C.2)

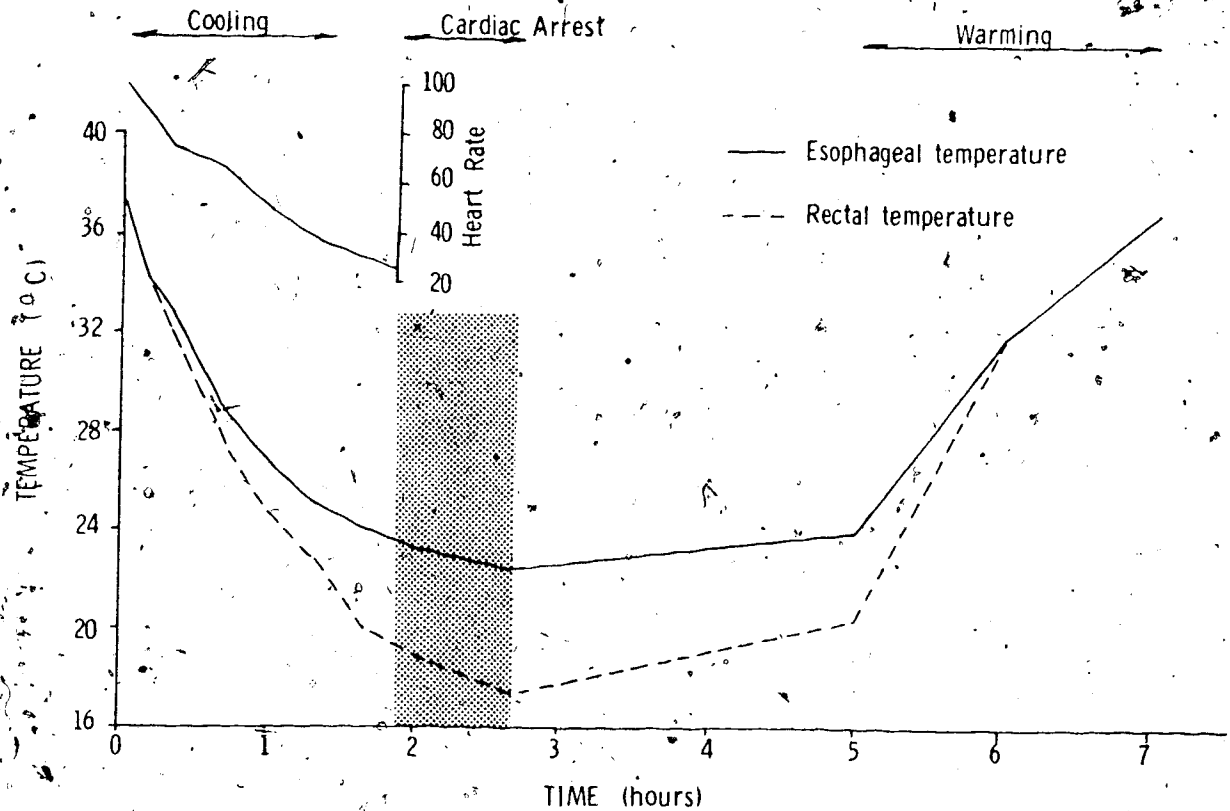

Fig. C.2 Typical body temperature course during heart transplantation with deep hypothermia.

The hypothermia technique was not troublesome as a method of heart replacement. Although the skin to skin time was shorter than with cardiopulmonary bypass, the operation was considerably longer due to periods of cooling and rewarming.

All three animals were sacrificed due to low cardiac output and metabolic acidosis. Postoperative recovery was usually fair with

spontaneous breathing. Average survival time was 9 hours. There was no reduction in blood damage over cardiopulmonary bypass. Plasma hemoglobin levels rose rapidly and platelet count rapidly decreased.

(Fig. C.3., C.4)

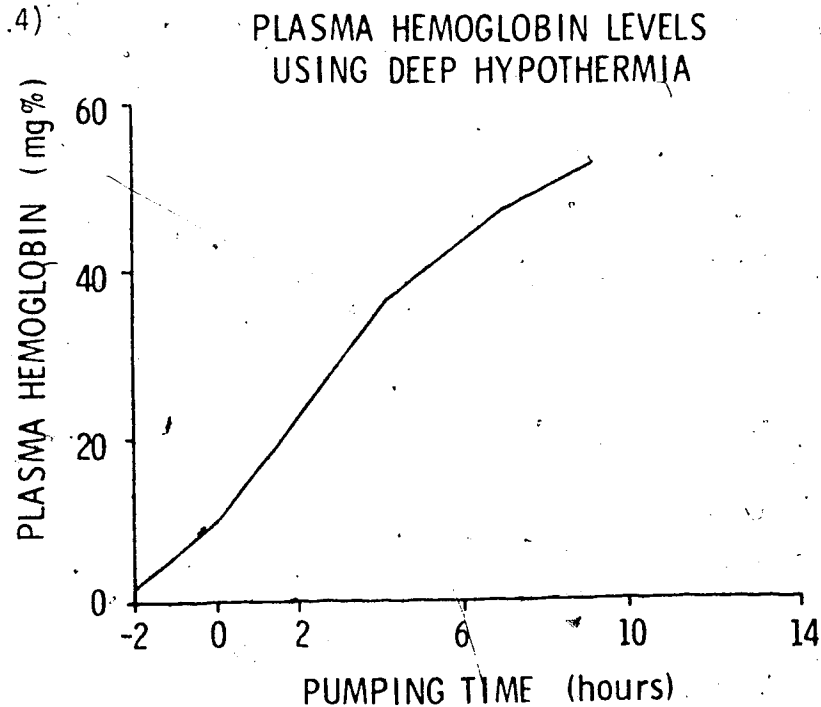

Fig. C.3. Hemolysis showed no reduction with hypothermia.

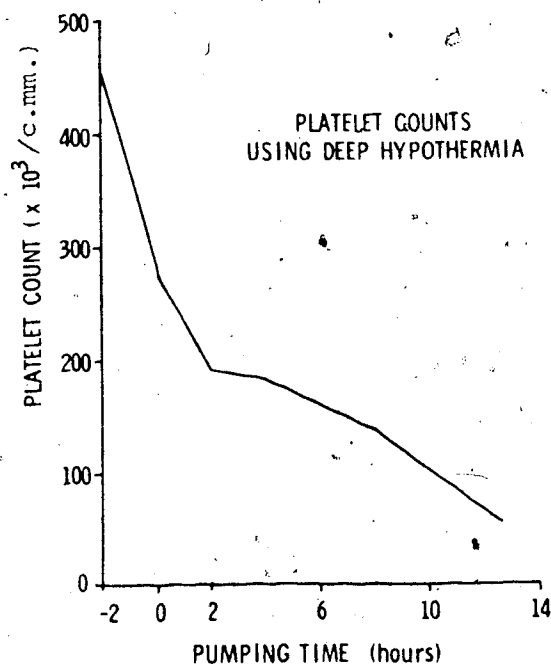

Fig. C.4. Platelet loss was excessive with hypothermia.

At post-mortem, lungs were less congested than seen in previous experiments.

Although the use of hypothermia showed to be an acceptable technique for artificial heart replacement, it did not produce results superior to those experienced using cardiopulmonary bypass.

APPENDIX D

DETAILED SUMMARY OF 3 LONG SURVIVORS

EXPERIMENT #7

CALF SEX: MALE WT.: 55 KG.

PROCEDURE : ARTIFICIAL HEART #75 & #76

MODEL MK-VI

SURVIVAL TIME: 33 HOURS

TABLE III

CHRONOLOGICAL RECORD OF EVENTS

EXPERIMENT #7

8:00 Atropine 1.2 mg. Vesperin 12 mg.
 8:35 Face Mask - Fluothane
 8:57 Intubation
 8:59 Femoral Cutdown
 9:08 Begin first unit of blood with 100 cc. bicarb.
 9:15 Catheterization of bladder attempted - unsuccessful
 9:27 Neck cutdown
 9:33 FA 110/80
 9:35 Begin open chest - lungs appeared slightly scarred (pneumonia?)
 FA 60/40
 9:45 Azygos tied
 9:47 Open pericardium
 9:50 FA 70/50
 9:55 Take 20 cc. blood for pre-clotting cuffs
 18 cc. Heparin given
 10:05 Preparation for bypass
 Used size 26 cannula in neck
 10:10 Atrium clamped
 10:12 Suction on
 10:13 Partial Bypass FA 40 Flow 3 L/min.
 Vena Cavae clamped
 Aorta and PA clamped
 10:14 COMPLETE BYPASS
 10:15 Body temp. 37.5°C
 10:18 Pulmonary artery resected
 10:25 Suturing R. atrial cuff to R. Atrium
 10:35 Give 1 bottle blood with 100 cc. bicarb.
 10:40 Suture left atrium - Cardiac output measured at 6.796 L/min.
 (at 9:30 a.m. before chest open)
 10:53 Artificial heart completely connected - prepare to go on pump
 Aortic pressure 25-30
 10:54 Priming of Pressure lines
 Body Temp. 37°C
 11:27 Superior Vena Cava and Aorta unclamped - Partial Bypass
 11:28 Heart On partial - transfusing blood from bypass unit
 11:30 OFF BYPASS PA-40 LA-5 RA-+7 FA-90/50
 11:34 Blood gas sample taken
 11:40 Given 20 cc. Protamine
 11:43 Given 10 cc. Calcium
 11:50 Calibration of cardiac output - SV - 50.9
 12:15 Given 9 cc. Protamine
 12:25 Begin close chest
 12:45 Blood gas sample taken
 12:50 Give 1 bottle blood with 100 cc. bicarb.
 13:00 Tidal volume - 800 cc. 50/50 air mix
Move to cage top
 14:05 1 amp. Lasix given and 1 amp calcium.
 14:17 100% O₂ on Engstrom Respirator - on for less than one hour
 Vacuum applied to both sides of pump
 14:20 PA-27 LA - 3 RA-3 FA-120/80

14:30 Blood gas sample taken
 15:00 Head up - 3 hours postoperative
 15:15 Body temp 38°C
 15:18 500 cc. Reomacrodex IV.
 16:15 Calibration of cardiac output, 800 cc. blood
 16:30 Tidal volume 500 cc. 50/50 air mixed R.R. 20/min.
 Clotting time more than 60 minutes
 18:00 Blood gas sample taken
 18:48 1 amp. lasix 600,000 penicillin
Moved vigorously - tried to stand up
 19:45 Blood gas sample taken
 20:50 Vesperin 10 mg. intravenous
 22:30 Blood gas sample taken
 00:30 Moved vigorously
 1:00 Vesperin 8 mg. Pressures, Gas examination stable.
 2:00 Systolic and diastolic pressure slowly going down
 Hct. = 18 Hgb. = 5.5
 2:30 Blood gas sample taken
 Body temp. 37.5°C
 Blood transfusion 1000 cc.
 5:00 Pressures and blood gas stable
 Urination 200 cc. Body temp. 37.5°C
 7:00 Bowel movement - firm. Urine output 100 cc.
 Systolic and diastolic pressure going down - 100/60.
 No diarrhea.
 7:30 Vesperin 5 mg. Almost stood up
 9:00 Blood gas sample taken
 Calibration of cardiac output 1 amp. lasix Body temp. 38.5°C
 11:45 10 L. O₂ 4 L. Room Air T.V. 700 cc.
 12:00 Tidal volume 700 cc. 14 L/min. pure O₂ going into shock
 13:50 General condition better. Head lifted up. Gas examination
 very good. Pressures all well. Giving noradrenalin with
 continuous drip from I.V.
 14:00 Blood gas sample taken
 15:25 Major convulsion occurred
 17:00 Femoral Arterial pressure was 100/56 mm Hg.
 Noradrenalin with continuous drip I.V. Lifted head, tried
 to stand several times.
 Cardiac output 3.5 L/min. Stroke volume 36 cc.
 18:00 No urination for last 10 hours.
 18:50 Body temp 38.5°C
 19:30 Systolic and diastolic pressures gradually decreasing.
 20:10 FA 60/20 Blood gas sample taken
 20:15 4 amp. noradrenalin added in 1000 cc. of 5% dextrose.
 20:30 Much liquid from trachea (pulmonary edema)
 20:45 Dead

Total Bypass: 33 hours and 15 minutes

TABLE IV

PERFUSION RECORD

EXPERIMENT #7

Oxygenator: Travenol 6LF

Oxygen Rate: 7 L/min.

Bypass begun 10:15

TIME	FLOW cc/min.	FLOW cc/kg/min.	TEMP. °C.	ARTERIAL PRESSURE mm.Hg
10:15	3000	50	38	40
10:20	3300	55	38	50
10:30	3000	50	38	50
10:45	3000	50	38	45
11:00	3000	50	38	20
11:25	3000	50	37.5	

Bypass stopped 11:30

Total bypass time 75 minutes.

Heparin 18,000 I.U.

Protamine 29 c.c.

Venous Cannulae #26 & #28 Bardic Caval

Arterial Cannula #18 Bardic

Prime 1200 c.c. Lactated Ringers and 5% Dextrose

TABLE V		LIQUID BALANCE RECORD		EXPERIMENT #7	
Time	Blood* cc.	Liquids cc.	Drugs	Loss of Blood cc.	Urine cc.
11:30		500 5% Dextrose			
11:40			10 cc. Calcium 20 cc. Protamine		
12:15			9 cc. Protamine		
12:50	700		100 cc. Bicarb.		
14:05			1 Amp. Lasix		
14:30			10 cc. Calcium		
15:00		100 Lact. Ring.			
15:18		100 Dextran		200	
16:15	500		50 cc. Bicarb.		
17:45		200 Dextran			
18:45			1 Amp. Lasix 600,000 I.U. Penicillin		2000
19:30		1000 5% Dextrose			
20:50			10 mg. Vesprin		
21:30			50 cc. Bicarb.		
22:30			50 cc. Bicarb.		400
1:00			5 mg. Vesprin		
2:00			10 mg. Vesprin		
2:05			600,000 I.U. Penicillin		
2:50	1000		30 mg. Heparin 50 cc. Bicarb.		
5:00		1000 5% Dextrose	40 m Eq. Potassium Chloride 100 cc. Bicarb.		200
7:00					100

LIQUID BALANCE RECORD (Continued)

Time	Blood cc.	Liquids cc.	Drugs	Loss of Blood cc.	Urine cc.
9:00			1 Amp. Lasix		
10:30	700		100 cc. Bicarb.		
12:00	1000		2 Amp. Noradrenalin 100 cc. Bicarb. 300 mg. Solumedrol		
15:00	1000		2 Amp. Noradrenalin 100 cc. Bicarb.		
16:55			250 mg. Solumedrol		
19:45			500 mg. Solumedrol		
19:50			500 mg. Solumedrol		
20:05			70 cc. Bicarb.		
20:15		50 Lact. Ring.	4 Amp. Noradrenalin		
Total	4900	2950		200	2700

*1000 ml. consists of 650 ml. of whole blood, 250 ml. of A.C.D. solution, and 100 ml. of sodium bicarbonate solution.

TABLE VI BLOOD PRESSURES AND FLOW RATES EXPERIMENT #7

Time	Fem. mm. Hg	L.A.	R.A.	P.A.	C.O. L/min.	S.V. cc.	Rate Per min.
9:30					6.8	68	100
11:30	90/50	5	7	40			
11:50					4.4	51	80
12:00	100/40	3	7	30			
13:00	100/50	0	6	35			
14:00	102/65	0	3	28	3.3	38	80
14:20	115/78	2	3	30			
15:00	132/92	-2	0	28			
16:00	120/90	-5	0	22	3.0	35	80
16:35	128/94	-2	7	30	3.4	40	87
16:50	190/92	2	7	30			
17:00	130/92	8	6	32			
17:05	124/88	-2	17	25	3.6	53	68
17:30	130/92	-3	7	29			104
18:30	130/95	-3	13	23			102
19:00	132/98	-2	7	24			90
20:00	138/98	3	5	20			90
21:00	130/90	0	5	18			
22:00	130/90	-1	5	19			
23:00	135/94	0	7	18			
24:00	135/94	0	5	18			
1:00	130/90	0	3	18			
2:00	116/80	0	3	16			
3:00	118/70	2	3	15			
4:00	120/78	5	4	20			
5:00	120/78	5	7	26			
6:00	110/64	3	4	18			96
7:00	105/64	5	6	18			
8:00	105/56	5	5	18			
9:00	110/52	5	5	18	4.5	48	94
10:00	100/50	5	5	17			
11:00	100/50	7	7	20			
12:00	80/20	7	7	18			
13:00	90/46	7	8	30			90
14:00	100/60	7	10	30			
15:00	120/80	5	12	35			
16:00	110/60	2	13	35			
17:00	100/56	6	12	32			
18:00	110/92	2	15	40	3.5	37	94
19:00	100/60	2	13	40			
19:30	80/40	-2	10	45			
20:00	60/20	-7	0	40			
20:35	50/15	-10	0	50			
20:45	24/10	-20	-5	40			

TABLE VII

BLOOD EXAMINATION

EXPERIMENT #7

Time	pH mm. Hg	pO ₂ mm. Hg	pCO ₂ mm. Hg	Hb g. %	Hct %	Platelets /c.mm. x 10 ³	R.B.C. /c.mm. x 10 ⁶	W.B.C. /c.mm.
10:00	A 7.70 V 7.63	250 21	15 22.5	10	30.5	540	7.47	2500
10:30				7.9	23	268	6.09	2500
11:45	A 7.50	310	25					
12:45	A 7.43 V 7.34	365 36	34 45					
13:30	A 7.32 V 7.22	67 22	36.5 48.5	7.2	22	230	5.15	2700
14:30	A 7.42 V 7.33	370 28	29 43	7.2	21	180	4.94	2200
16:30	A 7.43 V 7.28	300 24	35 46	6.7	19	116	4.66	3500
18:00	A 7.42 V 7.30	252 88	32 50					
19:30	A 7.39 V 7.29	245 42	32 53	6.2	18	120	4.14	7100
21:30	A 7.35 V 7.25	280 18	45 58	5.7	16	108	3.84	9100
22:30	A 7.35 V 7.25	285 17	48 62					
23:30	A 7.38 V 7.25	245 30	43 58	5.2	15.5	98	3.53	14000
2:30	A 7.40 V 7.28	252 28	43 60	5.3	15	110	3.59	19000
5:00	A 7.42 V 7.32	240 33	42 52					
7:30	A 7.50 V 7.35	275 90	40 57	7.4	19	82	4.66	7300
9:00	A 7.53 V 7.41	270 32	40 55					
11:30	A 7.50 V 7.41	215 35	48 61					
12:30	A 7.52 V 7.41	415 42	40 54	82	20	156	4.72	1700
14:00	A 7.48 V 7.36	320 35	32 43					
15:00				9	25	62		

BLOOD EXAMINATION (Continued)

Time	pH mm. Hg	pO ₂ mm. Hg	pCO ₂ mm. Hg	Hb g. %	Hct %	Platelets /c.mm. x 10 ³	R.B.C. /c.mm. x 10 ⁶	W.B.C. /c.mm.
17:00	A 7.35 V 7.25	335 45	30 43					
18:00				8.6	26	50		
20:00	A 7.04 V 6.92	55 25	54 79					
20:30	A 7.03	52	60					



TABLE VIII

PLASMA EXAMINATION

EXPERIMENT #7

Time	Pt. Hgb. mg. %	T.P. g. %	A/G	Glucose mg. %
10:00	6	4.3	0.4:1	50
10:45	4	5.4	0.2:1	400
13:30	18	4.5	0.2:1	146
14:30	15	4.4	0.3:1	118
16:30	44	4.9	0.5:1	135
19:30	87	4.9	0.3:1	135
21:30	90	5.2	0.3:1	168
23:30	94	4.2	0.6:1	183
2:30	108	4.0	0.5:1	124
7:30	54	5.3	0.2:1	45
11:30	43	4.2	0.4:1	39
15:00	24	5.9	0.2:1	16
18:00	12	4.4	0.4:1	16

SUMMARY (DR. T. NISHIZAWA)

Upon opening of the mid sternum, the lungs showed pneumonia scar in the upper and lower lobes of both sides. Immediately after the operation, the animal was placed on its knees while still on the table. The animal was placed on mixed air ventilation. Three hours post-operatively the animal raised his head. About six hours after the operation, the animal tried to stand up many times and moved so vigorously that Vesprin had to be given. The general condition was good but the cardiac output was about 60% of pre-operative volume. Twenty four hours post-operatively, both systolic and diastolic pressures were distinctly decreasing. Noradrenalin was given continuously until death. At twenty-eight hours post-operatively, the animal had its first major convulsion without any previous minor convulsion. There was no urination since the twentieth hour post-op. Thirty hours post-operatively the animal was still trying to stand up and lifted its head up, without any difficulty for a few minutes. Thirty hours post-operatively, the arterial pressure gradually decreased, even though noradrenalin was being given. Thirty-three hours post-op. much frothy fluid flowed out through the endotracheal tube.

PATHOLOGY REPORT (DR. T. NISHIZAWA)

Brain

Macroscopic findings: Cerebrospinal fluid was clear. Cortex showed moderate edema. Macroscopic hemorrhage not seen in the gray matter but a lot of small dark spots seen in the white matter.

Microscopic findings: microscopic hemorrhagic foci seen in the superficial cortex. Much edema, chromatosis, and pyknosis were seen throughout the cortex. "Fibrin platelet thrombi" were occasionally seen in the gray matter and mild congestion or sludging was seen in the white matter. The thrombi surely occurred premortum. (They probably did not result from emboli but it was still unclear).

Lung

Macroscopic findings: The right upper and the left lower lobes showed atelectasis, and the other lobes showed congestion and edema. None of the lobes appeared normal. On section, copious frothy fluid flowed out.

Microscopic findings: Severe congestion and intraalveolar edema observed. Pulmonary arteries and veins were dilated, and contained compact masses of RBC's. They also showed "fibrin platelet thrombi".

Kidney

Macroscopic findings: The entire surface was dark red as were the medullary rays and medulla upon bisection.

Microscopic findings: Glomeruli were bloodless and swollen but Bowman's capsule seemed to be normal. Compact masses of RBC's were seen in interstitial fluid separating the convoluted tubules of the medullary

rays. The numbers of nuclei in the cells of the convoluted tubules were decreased and some of these nuclei were swollen. The canals of the convoluted tubules were obstructed by eosin stained material. The canals of the medullary collecting ducts were obstructed by masses of RBC's.

These findings indicate "lower nephron nephrosis".

Liver

Macroscopic findings: slight edema, no hemorrhage. The color of the surface was normal.

Microscopic findings: Liver cells had some vacuolization (not certain whether fat or fluid) pinocytosis was observed in the cells, which might suggest hypoxia. The sinusoid arteries were normal.

Almost all centrilobular veins and some portal veins were dilated and contained fibrin nets with adhering RBC's and mononucleated cells.

These findings may suggest original thrombus formation.

Spleen

Macroscopic findings: Hemorrhagic spots (3 x 3 mm) were spread over the entire surface. The bisections appeared normal.

Microscopic findings: Fibrin nets resembled those seen in vessels of the liver. A few hemorrhagic areas were seen in the outer part of capsules, but not in the parenchyma.

Other

In short, "disseminated intravascular coagulated states" occurred in all microcirculation.

EXPERIMENT #23

CALF SEX: MALE WT.: 81 KG.

PROCEDURE: ARTIFICIAL HEART

MODEL MK XII

SURVIVAL TIME: 33 HOURS

TABLE IX CHRONOLOGICAL RECORD OF EVENTS EXPERIMENT #23

8:25 Premedication - atropine and vesprin
 8:50 Face mask - Intubation
 9:35 Begin neck cutdown for pressure lines
 10:00 110/80 FA
 10:03 I.V. with 5% Dextrose Lact. Ringers started
 10:09 Begin Open Chest
 10:15 Take first blood sample
 10:22 Prepare cannulae for bypass
 10:39 Heparin In
 11:09 PARTIAL BYPASS
 11:10 TOTAL BYPASS
 11:15 Begin excision of heart
 11:20 Blood gas taken Body Temp 35°C
 11:30 R side anastomosis complete (cuff)
 11:40 1 unit blood with 100 cc. bicarb given
 11:42 L side anastomosis complete (cuff)
 12:05 Blood gas - whole heart anastomosed
 12:20 1 amp bicarb to pump
 12:22 FA 60, Filling heart
 12:30 Partial bypass (R) side on
 Clamp venous line - open arterial line (L) side on
 12:30 High pressure (R) side - Bypass OFF Less than 1 min. between
 partial bypass and off bypass

HEART ON 60/20 FA
 Filling nicely, blood gas taken
 12:31 80/30 FA Transfusing from pump
 12:33 100/60 FA
 High P.A. pressure (50-55)
 12:41 FA dropping 70/50 - transient high venous pressure
 12:43 120/60 arterial pressure dropping off slightly
 12:45 Whole Blood sample - 2 amp. Bicarb given
 12:56 2 amps Lasix - Protamine 500 mg and 4 amps cal. Gluconate given
 13:13 1 amp Potassium
 13:25 100 mg. Protamine - Begin Close Chest
 13:52 Chest Closed - Clotting time 14 1/2 minutes.
 13:55 Blood gas
 14:10 Catheterization
 14:35 In Cage - whole blood sample - eye movements good - shivering
 14:55 Lifting head slightly - good eye reflexes
 15:05 BP 120/70 Blood gas taken - Clotting time 8 minutes.
 15:25 Timing machine skip-1-2 beats - good pressures
 16:15 Tidal volume 100-50 cc.
 18:00 Body temp 35°C - poor spontaneous breathing
 On Bird Resp. with 50% of O₂ and 50% of room air
 18:50 Bird Resp. was stopped for two minutes, and the animal began
 to breath spontaneously with 300 cc. of tidal vol.
 20:00 Tried to stand up many times.
 24:00 Body temp 37°C - trying to stand up Tidal vol. 450 cc.
 01:00 Liquid balance was as follows:
 Transfusion of blood was 3300 cc., liquid was 300 cc., loss
 of blood through chest drains was 400 cc. and vol. of urine
 after operation was 2400 cc.

- 6:00 pH was sometimes controlled by sodium bicarb. Arterial pO₂ and pCO₂ were excellent. However, some low cardiac output due to some low venous return was suspected from the point of venous pO₂ levels.
- 10:45 Whole blood clotting time was controlled by administration of calcium gluconate. Clotting time decreased 12 minutes after giving calcium.
- 13:45 Almost stood up - cannot support himself.
- 14:20 One more time almost stood up.
- 15:10 Allowed to breathe with only room air - 10 min. Later arterial pH 7.45
- 15:15 Nasal oxygen 6 l/min. with spont. breathing Tidal Vol. 400-500 cc. From result of blood gas exam the function of gas exchange in lung gradually deteriorating.
- 16:00 Animal stood completely.
- 20:00 Arterial pO₂ was over 100 mm.Hg. with spont. breathing pH was controlled by sodium bicarb. A.P. was 130/70
- 20:10 Muscle fibrillation around forefeet
- Arterial pressure decreased to 110/50 mm.Hg quickly
- 20:23 Convulsion A.P. 100/40 mm.Hg.
On Bird Resp. and then A.P. increased to 120/70 mm.Hg.
- 20:50 Spontaneous breathing - A.P. 120/50 mm.Hg.
- 21:00 Pupillary light reflex was sluggish.
- 21:05 Arterial pressure decreased to 100/40 mm.Hg. and pupillary light reflex was almost absent.
- 21:10 The size of pupil increased and a diastolic pressure was 20 mm.Hg. The Bird Resp. was continued and heart action was not stopped, and then the chest was reopened and explored. Both lower lobes of lung showed some loss of compliance and left upper lobe was stiff due to congestion and hemorrhage. The right upper and middle lobes were moderately stiff.

TABLE X

PERFUSION RECORD

EXPERIMENT #23

Oxygenator: Bentley

Oxygen Rate: 10 L/min.

Bypass begun 11:10

TIME	FLOW cc/min.	FLOW cc/kg/min.	TEMP. °C.	ARTERIAL PRESSURE mm.Hg.
11:10	4680	57	37	45
11:30	2840	35	36	40
12:00	4140	51	38	40
12:20	4380	54	38	75

Bypass stopped 12:15

Total Bypass time 65 minutes

Heparin 45,000 I.U. ✓

Protamine 600 mg.

Venous Cannulae #26 & #28 Bardic Caval

Arterial Cannula #20 Bardic

Prime 1500 c.c. Lactated Ringers and 5% Dextrose

TABLE XI BLOOD PRESSURES AND HEART RATES EXPERIMENT #23

Time	Femoral mm.Hg	C.V.P. mm.Hg	Rate Per min.
12:30	80/40		
13:30	100/40		
14:30	110/50	10	94
16:00	110/70	3	
18:00	130/90	5	
19:00	140/96	-1	
21:00	130/70	-1	94
24:00	120/70	0	
3:00	110/70	-0	
6:00	110/60	+0	
9:00	110/60	-1	94
12:00	120/80	3	
15:00	120/70	2	
18:00	130/70	3	
20:00	130/70	4	94
20:15	120/50		
20:30	100/40		
20:50	120/50		
21:00	110/50		
21:10	80/20	3	

TABLE XII

LIQUID BALANCE RECORD

EXPERIMENT #23

Time	Blood cc.	Liquids cc.	Drugs	Loss of Blood cc.	Urine cc.
12:30	300	100 Bicarb.	20 mg. Lasix		
13:00	1000		500 mg. Protamine 4 amp. Calcium 40 m Eq. Potassium Chloride		
13:25			100 mg. Protamine		
15:15			20 mg. Lasix		600
16:25	1000				550
20:30		50 Bicarb	600,000 I.U. Penicillin		
21:00	1000			200	350
22:30		100 Bicarb.	4 amp. Calcium		
23:30			20 mg. Lasix		
00:30		50 Bicarb		200	300
3:00					500
4:00					100
5:30	1000				
6:30			20 mg. Lasix		
8:00		500 10% Dextrose			
10:30			4 amp. Calcium	600	950
13:00			100 mg. Protamine 40 m Eq. Potassium Chloride 4 amp. Calcium 500 mg. Solumedrol 600,000 I.U. Penicillin		
14:20		300 5% Dextrose			
15:30	400				
16:30		50 Bicarb.			600
18:30		50 Bicarb.	2 amp. Calcium		

LIQUID BALANCE RECORD (Continued).

Time	Blood cc.	Liquids cc.	Drugs	Loss of Blood cc.	Urine cc.
8:00		100 Ringers			600
9:10				100	50
Total	4700	1300		1100	4600

TABLE XIII

WHOLE BLOOD CLOTTING TIMES

EXPERIMENT #23

Time	Clotting Time in Glass (minutes)
1:25	15
3:15	8
8:30	12
10:30	8
10:00	infinite
10:45	12
2:00	10
6:00	18
7:00	10

TABLE XIV

BLOOD EXAMINATION

EXPERIMENT #23

Time	pH mm. Hg	pO ₂ mm. Hg	pCO ₂ mm. Hg	Hb g. %	Hct %	Platelets /c.mm. x 10 ³	R.B.C. /c.mm. x 10 ⁶	W.B.C. /c.mm.
11:45				9.5	29	192	6.92	2800
12:30	A 7.24	200	40					
13:30	A 7.36	39	32					
14:00	A 7.63	250	13					
15:00	A 7.56 V	390 30	12 23	9.7	29	210	7.10	3100
16:00				10.6	31	180	7.60	4100
16:30	A 7.57 V 7.52	340 14	19 31					
18:00	A 7.52 V 7.49	125 14	16 28	10.4	30	180	7.20	4100
19:00	A 7.38 V 7.32	120 30	45 55					
20:00	A 7.33 V 7.32	124 27	42 55					
21:00				9.5	27	240	6.23	11000
22:00	A 7.34 V 7.33	135 20	38 45					
24:00	A 7.34 V 7.28	144 26	35 55	8.6	25	272	5.98	12000
2:00	A 7.34 V 7.33	152 28	36 40					
4:00	A 7.42 V 7.36	130 30	34 38	8.7	25	252	5.95	11700
6:00	A 7.37 V 7.33	153 28	45 55					
8:00	A 7.45 V 7.35	137 26	39 65	10.3	29	222	6.34	11100

BLOOD EXAMINATION (Continued)

Time	pH mm. Hg	pO ₂ mm. Hg	pCO ₂ mm. Hg	Hb g. %	Hct %	Platelets /c. mm. x 10 ³	R.B.C. /c. mm. x 10 ⁶	W.B.C. /c. mm.
10:00	A 7.40 V 7.35	197 24	33 44					
12:00	A 7.45 V 7.39	210 20	31 34	10.2	28	232	6.00	11200
14:00	A 7.41 V 7.36	100 20	34 46					
15:00	A 7.45 V 7.23	45 13	38 55					
16:00	A 7.30 V 7.29	104 16	51 54	9.6	28	180	5.27	12100
18:00	A 7.35 V 7.32	120 17	43 47					
20:00	A 7.38 V 7.37	91 25	42 44	8.3	24	144	4.74	10000

TABLE XV

PLASMA EXAMINATION

EXPERIMENT #23

Time	Pl. Hgb mg. %	T. I. P. g. %	Na ⁺ meq./l.	K ⁺ meq./l.	Cl ⁻ meq./l.	Ca ⁺⁺ meq./l.	L. A. mg. %	P. A. mg. %
10:15	4	6.6	139	4.3	103	10.6	16.0	0.30
11:45	32	4.8	142	4.3	102	9.3	37.0	1.25
15:00	34	5.6	149	3.2	100	10.3	68.8	0.70
16:00	31	5.1	149	2.9	101	9.0	71.0	1.12
18:00	28	5.0	151	2.9	101	9.0	70.4	1.50
21:00	35	5.0	146	3.4	100	10.0	72.1	1.75
24:00	38	5.1	147	3.4	98	10.6	71.4	1.51
4:00	37	5.4	150	3.4	96	10.6	68.8	0.95
8:00	40	5.5	156	3.7	96	10.0	71.4	1.84
12:00	45	4.9	155	3.9	100	8.6	64.8	1.12
16:00	56	5.0	150	4.9	98	7.6	72.7	1.49
20:00	37	5.0	151	8.4	96	8.2	72.7	0.93

SUMMARY (DR. T. NISHIZAWA)

Total oxygenator bypass time was 70 minutes. The lung showed slight congestion immediately after the artificial heart was employed. The arterial pressure was 100/40 mm. Hg and arterial pO_2 was only 39 mm. Hg with Bird Resp. one hour after pumping. However; arterial pO_2 increased to over 200 mm. Hg with Bird Resp. one and one half hours after pumping. Five and one half hours after pumping, the animal was allowed to breathe spontaneously even though the tidal volume was only 100 to 150 ml., because arterial pCO_2 was 14 mm. Hg and pO_2 was 340 mm. Hg on Bird Resp. with 50% O_2 and 50% room air. Ten minutes later, the tidal volume increased to 400 to 450 ml., arterial pO_2 was 120 mm. Hg and pCO_2 was 30 mm. Hg with pH of 7.38. About seven hours after pumping the animal attempted to stand up many times. After 15 hours pumping, the animal was allowed to breathe with only room air. Ten minutes later, arterial pO_2 decreased to 45 from 100 mm. Hg. The levels of pH were controlled every two hours by administration of sodium bicarbonate. After 16 hours pumping, clotting time was also controlled between 10 and 12 minutes by administration of calcium gluconate. The discharge of urine continued until the termination of experiment. About 32 and one half hours after pumping muscle fibrillation around the forefeet occurred. Arterial pressure decreased quickly to 110/50 from 130/50 mm. Hg. Then a major convulsion caused the animal to stop breathing. At this time, the level of plasma calcium was within normal, 8.2 mg%. A thromboembolus could be suspected as the cause of death.

PATHOLOGY REPORT (DR. T. NISHIZAWA)

Brain

Macroscopic findings: Cerebrospinal fluid was clear, and not hemorrhagic. Cortex showed slight edema. Hemorrhage or infarction was not seen in any part of brain. Choroid glomus of the lateral ventricle was slightly congested. Air emboli or thrombi were not seen in vessels.

Microscopic findings: Slight edema, some chromatolysis and pyknosis were seen in the cortex. Hemorrhage, thromboemboli or fibrin platelet thrombi were not seen. There was not any congestion or sludging in vessels.

Lung

Macroscopic findings: About 40% of lower lobe tissue was congested and hemorrhagic, but edema was mild. About 20% of the middle and upper lobe tissue was edematous. On section, a fibrous fibrin embolus was observed at the junction between a large pulmonary artery and a small pulmonary artery. No solid thromboemboli were found. Frothy fluid was observed in only edematous and congested regions.

Microscopic findings: Moderate interlobular edema and subpleural hemorrhage were seen in the congested region. Atelectasis, intra alveolar hemorrhage and edema, and mononuclear cell infiltration were seen in stiff regions. Some small bronchioli contained mononuclear eosin stained material (transudate). Some large bronchioli contained compact masses which consisted of fibrin, RBC's and mononuclear cells. Perivascular hemorrhage, thromboemboli or sludging were not observed.

Liver

Macroscopic findings: Neither congestion nor hemorrhage seen.

Microscopic findings: Liver cells had some vacuolization and pyknosis was seen. Centrilobular veins and portal veins were not dilated. There were no fibrin platelet thrombi.

Kidney

Macroscopic findings: The entire surface was normal. On section neither hemorrhage, infarction nor thrombi were seen.

Microscopic findings: The structures of glomeruli were normal and glomeruli were not bloodless. Some RBC's and proteinous casts were seen in collecting ducts. There were neither thrombi nor infarctions.

Spleen

Macroscopically and microscopically, neither congestion nor hemorrhage seen.

COMMENT:

- 1) Disseminated intravascular coagulation did not occur.
- 2) The findings of lower nephron nephrosis were negligible.
- 3) There was no parenchymal hemorrhage.
- 4) Ascites was negligible.

EXPERIMENT #C-7

CALF SEX: MALE WT.: 84 KG.

PROCEDURE: CONTROL BYPASS

SURVIVAL TIME: 33 HOURS

TABLE XVI CHRONOLOGICAL RECORD OF EVENTS EXPERIMENT C-7

8:25	Atropine 1.8 mg. Vesprin 18 mg.
9:15	Intubation
	After the chest was opened, the animal was ventilated manually.
11:10	Bypass on
12:20	Bypass off
12:30	Isuprel of 1 mg. was continuously infused because of the right heart failure.
14:30	pO ₂ : 46 mm. Hg by Bird respirator delivering 100% O ₂
15:30	pH 7.35 pO ₂ 404 pCO ₂ 38
16:30	The animal was allowed to breathe spontaneously with nasal oxygen of 3L/m. Tidal volume 380 to 450 ml. The systemic arterial pressure was 120/90 mm. Hg without administration of Isuprel.
17:20	Spontaneous breathing without nasal oxygen. An hour later, pH 7.41, pO ₂ 72, pCO ₂ 41
20:50	Removed endotracheal tube.
23:00	Removed the chest tubes.
23:30	The animal stood up without any difficulty.
01:30	The animal walked by itself when it was led upstairs.
10:30	The animal was led downstairs. The body temperature was 36.5°C. It still stood up and walked.
15:20	Animal looked tired and took the kneeling position. pH 7.40 pO ₂ 68 pCO ₂ 44
21:30	Sacrificed at 33 hours after bypass.

TABLE XVII

PERFUSION RECORD

EXPERIMENT C-7

Oxygenator: Travenol 6LF

Oxygen Rate: 6 L./min.

Bypass begun 11:10

TIME	FLOW cc./min.	FLOW cc./kg./min.	TEMP. °C.	ARTERIAL PRESSURE mm.Hg
11:10	3040	36	37.5	
12:00	2265	27		
12:15	2840	34		

Bypass stopped 12:20

Total Bypass time 70 minutes

Heparin 42,000 I.U.

Protamine 600 mg.

Venous Cannulae #26 & #28 Bardic Caval

Arterial Cannula #20 Bardic

Prime 1500 C.C. Lactated Ringers

TABLE XVIII		LIQUID BALANCE RECORD		EXPERIMENT C-7	
Time	Blood cc.	Liquids cc.	Drugs	Loss of Blood cc.	Urine cc.
12:30	1000	200 5% Dextrose	1 mg. Isuprel 40 m Eq. Potassium Chloride		
13:30		1000 5% Dextrose	4 Amp. Calcium Protamine 600 mg. Penicillin 600,000 I.U. 20 mg. Lasix		
15:40	1000				
16:00		1000 Ringers	2 Amp. Calcium	600	2000
19:00	1000		40 m Eq. Potassium Chloride		2600
23:00			Penicillin 600,000 I.U.	50	1200
11:30		2000 5% Dextrose	20 m Eq. Potassium Chloride		
14:00	500	200 Bicarb.	Penicillin 600,000 I.U.		
Total	3500	4400		650	5800

TABLE XIX WHOLE BLOOD CLOTTING TIMES EXPERIMENT C-7

Time	Clotting Time in Glass (minutes)
13:30	18
19:00	8
14:00	8

TABLE XX		BLOOD EXAMINATION					EXPERIMENT C-7		
Time	pH mm.Hg	pO ₂ mm.Hg	pCO ₂ mm.Hg	Hb g.%	Hct %	Platelets /c.mm. x 10 ³	R.B.C. /c.mm. x 10 ⁶	W.B.C. /c.mm.	
10:30				11.0	35	236	7.87	5400	
12:20	A 7.63	306	20	9.4	27	30	6.71	4600	
13:30	A 7.38	32	37	10.0	29	55	6.16	1900	
15:30	A 7.35	404	38	8.5	25	80	5.44	2100	
17:20	A 7.36	120	45						
18:30	A 7.42	74	44	10.1	29	109	5.82	2800	
21:00	A 7.42	60	35						
00:10	A 7.44	60	34	10.0	29	130	5.66	3300	
12:10	A 7.38	62	46	11.3	33	83	6.03	10500	
18:00	A 7.44	77	50	9.2	34	144	6.86	9100	

TABLE XXI		PLASMA EXAMINATION					EXPERIMENT C-7			
Time	Pl.Hgb mg.%	T.P. g%	Na+ m eq/l.	K+ m eq/l.	Cl ⁻ m eq/l.	Ca ⁺⁺ m eq/l.	L.A. mg.%	P.A. mg.%	Hist. mg.%	Glu. mg.%
10:30	5	5.9	147	4.1	100	5.0	5.5	0.32	5.5	38
12:20	17	5.0	141	3.8	47	5.0	24	0.70	4.3	140
13:30	18	5.0	138	2.8	96	4.6	56	1.52	4.5	112
17:20	6	4.3	148	4.4	103		107	2.08	4.8	110
18:30	44	5.4	158	3.6	101		105	2.64	5.0	220
00:10	10	5.4	152	2.9	103	5.4	66	2.34	5.9	89
12:10	11	5.4	147	3.2	98	4.4	51	1.52	3.2	132
18:00	3	5.2	146	2.7	92	4.4	27	2.08	5.5	79

SUMMARY (DR. T. NISHIZAWA)

After bypass, heart beats were observed for 10 minutes. Isuprel was continuously infused with 5% Dextrose. The systemic arterial pressure increased to 110/80 mm. Hg, and the central venous pressure was maintained at the level of 0 ± 2 mm. Hg. At termination of bypass, the dorsal parts of the lower lobes showed passive congestion, but this disappeared after bypass. The Isuprel drip was gradually decreased and stopped after one hour. Four hours after bypass, the animal was allowed to breathe spontaneously, and eight hours after bypass, the endotracheal tube was removed. Before the animal was led upstairs, the chest tubes were removed. Eleven hours after bypass, the animal stood up and walked by itself without any difficulty. The next morning the animal was still able to stand up and walk. In the afternoon, the animal looked tired and took the kneeling position. The arterial pH, pO_2 and pCO_2 were normal. The animal was sacrificed after 33 hours of observation.

PATHOLOGY REPORT (DR. T. NISHIZAWA)

Lung

Macroscopic findings: Approximately 20% of the lower lobes were congested and hemorrhagic, but these deteriorated regions were confined to the lower parts of the lower lobes. The other parts of the lower lobes and the other lobes were in good condition. On section, no thromboemboli were found.

Microscopic findings: In the lower parts of the lower lobes, atelectasis, congestion, intraalveolar and interlobular hemorrhage were seen. However, edema was very slight. The other lobes preserved good structure of alveoli.

Brain, liver, kidney and spleen were normal; no infarction, hemorrhage, congestion, edema or degeneration.

CURRICULUM VITAE

CURRICULUM VITAE

NAME David Thomas Morris

DATE OF BIRTH June 15, 1946

PLACE OF BIRTH London, England

NATIONALITY Naturalized Canadian

POST-SECONDARY EDUCATION AND DEGREES Bachelor of Science (Mechanical Engineering)
University of Alberta, Edmonton, Alberta, 1968

Master of Science (Mechanical Engineering)
University of Alberta, Edmonton, Alberta, 1970

Professional Engineer, The Association of
Professional Engineers, Geologists and
Geophysicists of Alberta, 1971

Doctor of Philosophy (Experimental Surgery),
University of Alberta, Edmonton, Alberta, 1973

ASSISTANTSHIPS AND AWARDS 1968 University of Alberta Graduate Teaching
Assistantship

1969 University of Alberta Graduate Teaching
Assistantship

1969 Medical Research Council Research
Assistantship

1970 The Province of Alberta Graduate Fellowship

1971 Edmonton Civic Employees Chest Fund Research
Fellowship

1972 Edmonton Civic Employees Chest Fund Research
Fellowship

UNDERGRADUATE RESEARCH 1968
"Heart Assist Engine". Director: Dr. G.S.H. Lock,
Professor, Department of Mechanical Engineering,
University of Alberta, Edmonton, Alberta

GRADUATE RESEARCH 1969, 1970
"Performance Characteristics of an Artificial Heart"
Thesis for Master of Science Degree
Directors: Dr. G.S.H. Lock, Professor, Department
of Mechanical Engineering, University
of Alberta

Dr. C.M. Couves, Professor, Department
of Thoracic and Cardiovascular Surgery,
University of Alberta, Edmonton

CURRICULUM VITAE (continued)

1970 - 1973

"The Total Replacement Artificial Heart" and
 "Left and Right Heart Assist Devices"
 Projects being conducted in the Department of
 Surgery and the Surgical-Medical Research Institute,
 University of Alberta

Director: Dr. C.M. Couves, Professor, Department
 of Thoracic and Cardiovascular Surgery,
 University of Alberta, Edmonton

PAPERS
PUBLISHED

1. "Experiences with a sac-type artificial heart."
 D.T. Morris and C.M. Couves, Can Med Assoc J
 Sept. 4, 1971. Vol. 105
2. "A change of heart with rubber"
 D.T. Morris and C.M. Couves, Rubber Developments,
 Vol. 24, No. 2, 1971
3. "Design and performance characteristics of an
 artificial heart." D.T. Morris, T. Nishizawa
 and C.M. Couves, Jap J Thorac Surg, Vol. 26,
 No. 3, 1973
4. "Results of total artificial heart replacement:
 Causes of death and histological examination."
 T. Nishizawa, D.T. Morris and C.M. Couves,
 Therapy in Japan, April 1973

ABSTRACTS
PUBLISHED

"Development of a new prebiolized natural rubber for
 use in cardiovascular prostheses", P. Kolodej, D.T.
 Morris and C.M. Couves. Annals of the Royal College
 of Physicians and Surgeons of Canada, January 1972.

"Performance limitations and design criteria of
 the total replacement artificial heart", D.T. Morris,
 T. Nishizawa and C.M. Couves. Annals of the Royal
 College of Physicians and Surgeons of Canada,
 January 1973.

