



NAME OF AUTHOR/NOM DE L'AUTEUR Fathalla EL-NAHHAS

TITLE OF THESIS/TITRE DE LA THÈSE Field Measurements in Two Tunnels in the  
City of Edmonton.

UNIVERSITY/UNIVERSITÉ University of Alberta

DEGREE FOR WHICH THESIS WAS PRESENTED/  
GRADE POUR LEQUEL CETTE THÈSE FUT PRÉSENTÉE M.Sc

YEAR THIS DEGREE CONFERRED/ANNÉE D'OBTENTION DE CE GRADE Fall 1977

NAME OF SUPERVISOR/NOM DU DIRECTEUR DE THÈSE Dr. S. Thomson

Permission is hereby granted to the NATIONAL LIBRARY OF  
CANADA to microfilm this thesis and to lend or sell copies  
of it.

*L'autorisation est, par la présente, accordée à la BIBLIOTHÈ-  
QUE NATIONALE DU CANADA de microfilmer cette thèse et  
de prêter ou de vendre des exemplaires du film.*

The author reserves other publication rights, and neither the  
thesis nor extensive extracts from it may be printed or other-  
wise reproduced without the author's written permission.

*L'auteur se réserve les autres droits de publication; ni la  
thèse ni de longs extraits de celle-ci ne doivent être imprimés  
ou autrement reproduits sans l'autorisation écrite de l'auteur.*

DATED/DATE Oct 21<sup>st</sup>, 1977 SIGNED/SIGNÉ F EL Nahhas

PERMANENT ADDRESS/RÉSIDENCE FIXÉ 10 Mohamed Shawky St,  
El Monira, Cairo, EGYPT

Ottawa, Canada  
K1A 0N4

## NOTICE

The quality of this microfiche is heavily dependent upon the quality of the original thesis submitted for microfilming. Every effort has been made to ensure the highest quality of reproduction possible.

If pages are missing, contact the university which granted the degree.

Some pages may have indistinct print especially if the original pages were typed with a poor typewriter ribbon or if the university sent us a poor photocopy.

Previously copyrighted materials (journal articles, published tests, etc.) are not filmed.

Reproduction in full or in part of this film is governed by the Canadian Copyright Act, R.S.C. 1970, c. C-30. Please read the authorization forms which accompany this thesis.

**THIS DISSERTATION  
HAS BEEN MICROFILMED  
EXACTLY AS RECEIVED**

## AVIS

La qualité de cette microfiche dépend grandement de la qualité de la thèse soumise au microfilmage. Nous avons tout fait pour assurer une qualité supérieure de reproduction.

S'il manque des pages, veuillez communiquer avec l'université qui a conféré le grade.

La qualité d'impression de certaines pages peut laisser à désirer, surtout si les pages originales ont été dactylographiées à l'aide d'un ruban usé ou si l'université nous a fait parvenir une photocopie de mauvaise qualité.

Les documents qui font déjà l'objet d'un droit d'auteur (articles de revue, examens publiés, etc.) ne sont pas microfilmés.

La reproduction, même partielle, de ce microfilm est soumise à la Loi canadienne sur le droit d'auteur, SRC 1970, c. C-30. Veuillez prendre connaissance des formules d'autorisation qui accompagnent cette thèse.

**LA THÈSE A ÉTÉ  
MICROFILMÉE TELLE QUE  
NOUS L'AVONS REÇUE**

THE UNIVERSITY OF ALBERTA

FIELD MEASUREMENTS IN TWO TUNNELS  
IN THE CITY OF EDMONTON

by



FATHALLA EL-NAHHAS

A THESIS

SUBMITTED TO THE FACULTY OF GRADUATE STUDIES AND RESEARCH  
IN PARTIAL PULFILMENT OF THE REQUIREMENTS FOR THE DEGREE  
OF MASTER OF SCIENCE

DEPARTMENT OF CIVIL ENGINEERING

EDMONTON, ALBERTA

FALL, 197

THE UNIVERSITY OF ALBERTA  
FACULTY OF GRADUATE STUDIES AND RESEARCH

The undersigned certify that they have read, and recommend to the Faculty of Graduate Studies and Research, for acceptance, a thesis entitled "Field Measurements in Two Tunnels in the City of Edmonton" submitted by Fathalla El-Nahhas in partial fulfilment of the requirements for the degree of Master of Science in Civil Engineering.

*S. Thomson*  
.....  
Dr. S. Thomson, Supervisor

*N. Morgenstern*  
.....  
Dr. N. Morgenstern

*B. Stimpson*  
.....  
Dr. B. Stimpson

Date *21 Oct* ..... 1977

## ABSTRACT

The rapid growth of the City of Edmonton made tunneling activity for different purposes (transportation, storm drainage and sanitation) almost continuous. Most of these tunnels have been bored through soft ground (soils and soft rocks).

Two tunnels were selected for the present study. The Whitemud-Creek Tunnel which is 19.83ft. (O.D.) bored through clay-shale for storm drainage with an average overburden cover of 155 ft. and the 170th Street Tunnel which is a sanitation tunnel bored through glacial till (101" O.D.) with an average overburden cover of 70 ft.

The movement and deformation of three ribs in the Whitemud-Creek Tunnel were recorded, using precise surveying and constant tension tape extensometer, over a period of more than four months before the secondary concrete lining was placed. Vertical upward rigid body translation of the ribs was recorded during the first two weeks which is due to the relatively delayed response of invert unloading. This was followed by a downward translation with significant contraction in the diameters due to load-transfer to the ribs at the crown.

Finite element analyses, using the deformed shape of the ribs as a displacement boundary condition, showed that maximum compressive stress in the ribs four months after

placing is 16.63 Ksi, which is 33% of yield stress. This maximum stress represents only 20% of those corresponding to an assumed all-around radial overburden pressure on the lagging. These relatively low stresses are due to deformation of the ground, especially near the crown, before the ribs were installed and yielding of the ground after installation of the overlapping lagging system.

The stiffness of the ground surrounding the tunnel was examined using in-situ pressuremeter testing. A pronounced decrease of the deformation modulus near the tunnel wall after excavation could be attributed to the concentration of tangential stresses accompanied by a relief in the radial stresses due to excavation unloading. The results of another set of tests before placing the secondary concrete lining showed that the stiffness of the ground near the tunnel wall is time-dependent.

Ground surface vertical movement due to boring the 170th Street Tunnel was recorded while the mole was approaching, passing beneath and continuing beyond a set of settlement points. The maximum settlement occurred while the mole was approaching followed by a heave movement when it reached under the settlement points. This behaviour was suggested to be the result of stress changes near the face of this rapidly excavated deep tunnel. The shift of the maximum settlement away from the centre-line of the tunnel was related to the eccentric location of the 170th Street

over the tunnel.

Measurements of earth pressure and lagging deflection in the 170th Street-Tunnel test section could assist the interpretation of measurements of the ribs movement. However, it was concluded that measurements of the ribs movements are the most reliable and economical method to study the behavior of the primary lining.

## ACKNOWLEDGEMENTS

The work reported in this thesis was carried out under the supervision of Professor S. Thomson, Department of Civil Engineering, University of Alberta. The author wishes to express his sincere gratitude to Dr. Thomson for his continual encouragement, guidance and support throughout the period of this study.

Access to the tunnels and the cooperation of the City of Edmonton Water and Sanitation Department are greatly appreciated. In particular, the author wishes to thank Mr. R. Oster, P.Eng. and Mr. G. Emanuel, P.Eng.

The rewarding discussions with Dr. Z. Eisenstein, the invaluable advice of Dr. N. Morgenstern and the comments of Dr. T. Hrudey are gratefully acknowledged.

The author wishes to thank Messrs P. Kaiser, L. Medeiros, E. Evgin and J. Ramotar for their helpful criticism, discussions and assistance.

Many thanks are due to Messrs O. Wood, A. Muir and their staff for their technical assistance during the field work and in preparation of field instrumentations.

The financial support provided by the National Research Council of Canada and the University of Alberta is gratefully acknowledged.

The author wishes to express his most sincere gratitude



to his wife, Nany, for her moral support and continued encouragement.

The excellent job of data entry of Marilyn Butchko at Computing Services is also acknowledged.

TABLE OF CONTENTS

| CHAPTER |   | PAGE |
|---------|---|------|
| I       | INTRODUCTION  |      |
| 1.1     | Literature Review of Soft Ground Tunneling ..         | 1    |
| 1.1.1   | Ground Movement due to Tunneling .....                | 2    |
| 1.1.2   | Design of Tunnel Linings .....                        | 5    |
| 1.1.3   | Finite Element Method .....                           | 7    |
| 1.2     | Scope and Organization of the Thesis .....            | 8    |
| II      | DETAILS OF TWO TUNNELS IN EDMONTON                    |      |
| 2.1     | Introduction .....                                    | 10   |
| 2.2     | Whitemud-Creek Tunnel .....                           | 12   |
| 2.2.1   | General .....   | 12   |
| 2.2.2   | Subsurface Profile .....                              | 12   |
| 2.2.3   | Tunnel Boring Machine .....                           | 14   |
| 2.2.4   | Lining Systems .....                                  | 17   |
| 2.3     | 170th Street Tunnel .....                             | 17   |
| 2.3.1   | General .....   | 17   |
| 2.3.2   | Subsurface Profile .....                              | 19   |
| 2.3.3   | Tunnel Boring Machine .....                           | 22   |
| 2.3.4   | Lining Systems .....                                  | 24   |
| III     | FIELD MEASUREMENTS                                    |      |
| 3.1     | Introduction .....                                    | 26   |
| 3.2     | Field Measurements in the Whitemud-Creek Tunnel ..... | 27   |
| 3.2.1   | Deformation of the Ribs .....                         | 27   |
| 3.2.2   | Level Changes of the Ribs .....                       | 38   |
| 3.2.3   | In-situ Pressuremeter Tests .....                     | 38   |

| CHAPTER   | PAGE |
|---|------|
| 3.3 Field Measurements in the 170th Street Tunnel .....               | 40   |
| 3.3.1 Ground Surface Vertical Movement .....                          | 40   |
| 3.3.2 170th Street Tunnel Test Section .....                          | 44   |
| <br>IV EVALUATION OF THE FIELD MEASUREMENTS                           |      |
| 4.1 Introduction .....  | 55   |
| 4.2 Evaluation of the Measurements in the Whitemud-Creek Tunnel ..... | 56   |
| 4.2.1 Deformation of the Ribs .....                                   | 56   |
| 4.2.2 In-situ Pressuremeter Tests .....                               | 61   |
| 4.2.3 Finite Element Analyses .....                                   | 64   |
| 4.3 Evaluation of the Measurements in the 170th Street Tunnel .....   | 73   |
| 4.3.1 Ground Surface Movements .....                                  | 73   |
| 4.3.2 The 170th Street Tunnel Test Section .                          | 76   |
| <br>V CONCLUSIONS AND RECOMMENDATIONS FOR FURTHER STUDIES             |      |
| 5.1 Conclusions .....   | 77   |
| 5.2 Recommendations for Further Studies .....                         | 80   |
| REFERENCES .....  | 81   |

LIST OF TABLES

| TABLE |   | PAGE |
|-------|---|------|
| 2.1   | Geotechnical Properties of the Clay-shale .....   | 15   |
| 2.2   | Geotechnical Properties of the Glacial Till ..... | 21   |

## LIST OF FIGURES

| FIGURE | PAGE  |
|--------|---|
| 2.1    | General Location of the Tunnels ..... 11                                    |
| 2.2    | Soil Profile along the Whitemud-Creek Tunnel .... 13                        |
| 2.3    | Mole Used in the Whitemud-Creek Tunnel ..... 16                             |
| 2.4    | Details of Linings in the Whitemud-Creek Tunnel . 18                        |
| 2.5    | Soil Profile along the 170th Street Tunnel ..... 20                         |
| 2.6    | Mole and Shield Used in the 170th Street Tunnel . 23                        |
| 2.7    | Primary Lining in the 170th Street Tunnel ..... 25                          |
| 3.1    | Details of the Test Section in the Westmud-Creek Tunnel ..... 28            |
| 3.2    | Constant Tension Extensometer ..... 30                                      |
| 3.3    | Change in Vertical Diameter ..... 31  |
| 3.4    | Change in Horizontal Diameter ..... 32                                      |
| 3.5    | Change in Diagonal Diameter D-L ..... 33                                    |
| 3.6    | Change in Chord L-R ..... 34  |
| 3.7    | Change in Chord D-R ..... 35  |
| 3.8    | Change in Chord D-B ..... 36  |
| 3.9    | Change in Invert Levels ..... 39  |
| 3.10   | Results of In-situ Pressuremeter Tests ..... 42                             |
| 3.11   | General Plan of the Settlement Points over the 170th Street Tunnel ..... 43 |
| 3.12   | Details of a Settlement Point ..... 45                                      |
| 3.13   | Ground Surface Movement over the 170th Street Tunnel ..... 46               |
| 3.14   | Details of the 170th Street Tunnel Test Section . 47                        |
| 3.15   | Change in Horizontal Diameter ..... 49                                      |
| 3.16   | Change in Vertical Diameter ..... 50  |
| 3.17   | Change in Invert Level ..... 51   |

| FIGURE  | PAGE |
|---|------|
| 3.18 Details of a Pressure-cell .....   | 52   |
| 3.19 Measurements of the Pressure-cells .....   | 54   |
| 4.1 Average Diameter and Chord Changes .....  | 57   |
| 4.2 Deformed Shapes of the Ribs .....   | 59   |
| 4.3 Results of the In-situ Pressuremeter Tests in<br>the Whitemud-Creek Tunnel .....          | 63   |
| 4.4 Ground Deformation around Unlined Tunnel .....  | 66   |
| 4.5 Calculated Deformation of the Lining .....  | 68   |
| 4.6 Finite Element Mesh .....   | 69   |
| 4.7 Calculated Stresses in the Ribs Using the<br>Finite Element Method (Feb. 2nd, 1977) ..... | 70   |
| 4.8 Calculated Stresses in the Ribs Using the<br>Finite Element Method (June 1st, 1977) ..... | 72   |
| 4.9 Measured and Calculated Settlement Profile<br>above the 170th Street Tunnel. ....         | 75   |

LIST OF PHOTOGRAPHIC PLATES

PLATE

PAGE

- 1 Measurement of Deformation of the Ribs Using  
the Constant Tension Extensometer ..... 37
- 2 In-situ Pressuremeter Test in the Whitemud  
Creek Tunnel. .... 41

## CHAPTER I

### INTRODUCTION

The interest in the use of underground space for transportation, utilities, storage and mining has been growing rapidly during this decade. Most of the transportation and utility tunnels were bored near the ground surface through soil and soft rock. This increased the need to improve existing design methods of soft ground tunneling. There is also a need to create a body of reliable full scale tunnel measurements for different geological formations and construction methods to verify these improvements and to establish an empirical evaluation when theoretical analyses become rather formidable (Peck, 1969b and Lane, 1975).

#### 1.1 Literature Review of Soft Ground Tunneling

One of the significant contributions to the knowledge of soft ground tunneling was the 'State of-the-Art Report' by Peck (1969 b) which compiled most of the literature published prior to that time and outlined the areas which need improvement.

Among the requirements for a satisfactory tunnel in soft ground, Peck considered the evaluation of ground movements resulting in damage to the surroundings and adequate lining design. The following is a literature review of these two topics extending from Peck's report.



### 1.1.1 Ground Movement due to Tunneling:

The immediate settlement of the ground surface over a tunnel in soft ground is the result of a combination of ground loss occurring from the tunnel face while the mole is advancing, soil movement into the annular space left behind the shield, and to fill the overcutting around the lining. This indicates the dependency of such movement on the construction details and the three dimensional nature of the problem, especially if a large portion of this movement occurs while the mole is passing under the test section.

A reliable estimate of ground surface movements could only be obtained through an empirical evaluation of field measurements. Schmidt (1969) advocated a procedure using the curve fitting of the error function to a cross-section through the settlement trough. Peck (1969 b) presented this procedure with supporting case histories and correlated the width of the settlement trough with the depth of the tunnel for different soils.

Peck (op. cit.) concluded this section of his report about ground movement by stating;

"...The present margin of uncertainty in estimating the consequences of tunneling, even with the best techniques, can not be reduced until many more records of settlements and construction procedures become available for all type of subsurface conditions."

This conclusion showed the importance of field measurements. As a result, many detailed records of ground

surface and subsurface movements have been published.

Kuesel (1972) presented a record of the field performance of soft ground tunnels for the San Francisco Bay Area Rapid Transit System (BART). The ground movement observations included the ground surface settlement in the longitudinal and transverse sections due to driving four tunnels located on two levels. Also, the subsurface horizontal movement was measured by an inclinometer installed midway between two tunnels.

An intensive ground movement instrumentation system was installed in a test section in the tunnels for the Washington Metro. Twenty-two inclinometers and twelve multiple position rod-extensometers were installed to measure the three dimensional pattern of soil displacement around the advancing tunnels. Hansmire and Cording (1972) and Cording (1975) presented the details and the measurements of this test section. More details and interpretations of this test section are given by Butler and Hampton (1975) and Hansmire and Cording (1976).

Attewell and Farmer (1974, 1975) presented a record of ground movements due to tunneling through London Clay. They studied the rate of surface and subsurface vertical movements related to position of the tunnel face and the effect of the rate of the mole advancement on these movements.

Tomlin and Sklucky (1977) presented the records of ground surface and subsurface movements due to tunnel excavation through layers of stiff till and weathered sandstone.

The geotechnical performance of the Edmonton Rapid Transit tunnels was reported by Eisenstein and Thomson (1977).

Successful estimates of the ground surface movements using model tests is limited by the precise modeling of soil properties and construction sequences. However, such tests are useful to examine the mechanics of deformation around tunnels if the soil properties were adequately modelled. The results of plane strain scale models of tunnels in sand and overconsolidated clays were presented by Atkinson et al. (1974, 1977a, 1977b). Abel and Lee (1973) used three dimensional models to study the stress change ahead of an advancing tunnel in rocks.

Heuer (1976) differentiated between the ground settlement due to tunneling, as defined previously in this section, and those resulting from catastrophic ground loss. He gave some details of case histories showing the second type. A similar case of excessive ground loss was reported by Oster (1975) in one of Edmonton's tunnels. He gave alternative solutions to control such losses and the advantages and limitations of each.

The instability of the North Saskatchewan River Bank induced by boring an 8 ft. storm sewer tunnel in the Edmonton area was reported by Thomson and Yacyshyn (1977).

#### 1.1.2 Design of Tunnel Linings:

Peck (1969 b) discussed the behaviour of essentially rigid and essentially flexible linings. The gap between these two extremes was filled by introducing the "flexibility ratio" in the second 'State of-the-Art Report' (Peck et al. 1972). However, Peck stressed in his recommended lining design procedure in the first report that the displacements of the ground while the mole is approaching and passing a certain section will alter the in-situ stresses. That is, the analysis will be unrealistic if it assumes that the lining is embedded in the soil mass before the earth inside is excavated. This includes lining design methods based on conventional active, passive or at-rest-pressure, or even using the modulus of subgrade reaction. Examples of such methods are given by Szechy (1966).

The ground reaction curve concept, as originally presented by Pacher (1964) and used by Rabcewicz (1964), offered a promising procedure for analyzing the interaction between the lining and the surrounding ground. This method takes into account the ground displacements and the corresponding stress change before the lining starts

reacting with the surrounding ground. Theoretical analysis based on this concept are given by Lombardi (1973, 1974).

Ladanyi (1974) derived a closed-form solution of the ground reaction curves for a circular tunnel in a uniform isotropic stress field taking into account the plastic volume dilation and strength decrease with time of the ground mass.

The Austrian Tunneling Method (Rabcewicz et al. 1973, 1974) used the ground reaction concept and field measurements for lining design. This gives the present state of using the ground reaction concept for lining design in rock tunneling.

Peck (1969 b) discussed the use of the ground reaction curves for soft ground tunneling. The limited information of the case histories available up to that time concerning soil displacement near the tunnel face have confined the general use of this concept.

Mathis (1974) used the Anders Bull method for analyzing the internal forces and deflection of the lining. He emphasized the need of field measurements and in-situ testing.

Field measurements and observations of a tunnel in a squeezing rock are given by Brown and Hewson (1976).

Lo and Morton (1976) investigated the stress

concentration around tunnels and its relation to the rock anisotropy. They discussed the lining design using the observed time-dependent displacement of the tunnel wall.

In a review on the lining stresses, Peck (1975) pointed out that the field measurements of diameter changes of the lining with properly evaluated soil and lining properties are presently the most promising procedure to investigate stresses in a tunnel lining.

### 1.1.3 Finite Element Method:

Closed-form solutions of stresses and displacements around lined and unlined underground openings using linear elastic model and simple boundary conditions have been compiled and presented by Poulos and Davis (1974). The extension of these solutions for complicated geometries and boundary conditions using realistic deformation models of the ground was impossible without using the finite element method. The principles of this method and its use in solving many geotechnical problems have been presented by Zienkiewicz (1971), Desai (1971), and Desai and Abel (1972).

Houayx and Ladanyi (1970) used the finite element method to analyze the gravitation stresses and deformation around a soft ground unlined tunnel for three different deformation models.

Results of finite element analyses of shallow tunnels

in soft ground are presented by Peck et al. (1972).

Kulhawy (1974) used linear strain quadrilateral finite elements in modeling the underground incremental excavation. He studied the effect of the number of elements in the mesh and the location of boundary conditions on the computed stresses and displacements.

## 1.2 Scope and Organization of the Thesis:

From the preceding literature review, it was concluded that any reliable analysis of the stresses in the lining and broadening the acceptance of the existing empirical evaluation of the ground surface settlement due to tunneling are dependent mainly on field measurements in tunnels bored in different geological formations using various construction procedures. On the other hand, close observations of linings and in-situ tests are essential to examine the behaviour of lining and the ground around tunnels before any realistic large scale analysis can be performed.

The present tunneling activity in Edmonton presented an opportunity for obtaining field measurements in tunnels bored through the geological formations of the Edmonton area using the construction procedures of the Edmonton Water and Sanitation Construction Branch.

Two tunnels were chosen for the present study. The

first was a 19.83 ft. (O.D.) storm tunnel bored through clay-shale with an average overburden cover of 155 ft. The second was a sanitation tunnel bored through glacial till (8.4 ft., O.D.) with an average overburden cover of 70 ft. Complete details of these two tunnels are presented in Chapter II.

The movement of three ribs in the Whitemud-Creek Tunnel was recorded for more than four months until the secondary concrete lining was placed. The stiffness of the ground near the tunnel was examined using in-situ pressuremeter tests.

Ground surface vertical movement due to boring the 170th Street Tunnel was recorded while the mole was approaching and passing under a set of settlement points. This tunnel was also used for a test section containing measurements of rib movements, pressure cells and deflection of the laggings.

Details of the instruments used and the records of their measurements are given in Chapter III.

Chapter IV contains the evaluation of all the measurements recorded in the tunnels. It also contains the results of finite element analyses of the stresses in the ribs two weeks after their installation and before placing the secondary concrete lining.

The conclusions of this research and recommendations for further studies are given in Chapter V.



## CHAPTER II

### DETAILS OF TWO TUNNELS IN EDMONTON

#### 2.1 Introduction

The construction of Edmonton tunnels for interceptor sewers and storm drains started in 1955 as part of a program to improve the waste treatment of the city (Beaulieu 1972). In 1976, the accumulated tunneling experience was used to construct two tunnels under downtown Edmonton for the Rapid Transit System (Eisenstein and Thomson 1977).

The rapid growth of the City made the tunneling activity for different purposes (transportation, sanitation and storm drainage) almost continuous. Two of these tunnels were chosen for this study.

The first was the Whitemud-Creek Tunnel. As shown in Figure 2.1, it is an extension of the existing storm tunnel under 30th Avenue to drain it into the North Saskatchewan River.

The second, was a sanitation tunnel moled under 170th street. It connects the sewer network under the newly developed Gariepy Area with the existing main sewer interceptor under 79th Avenue (Figure 2.1).

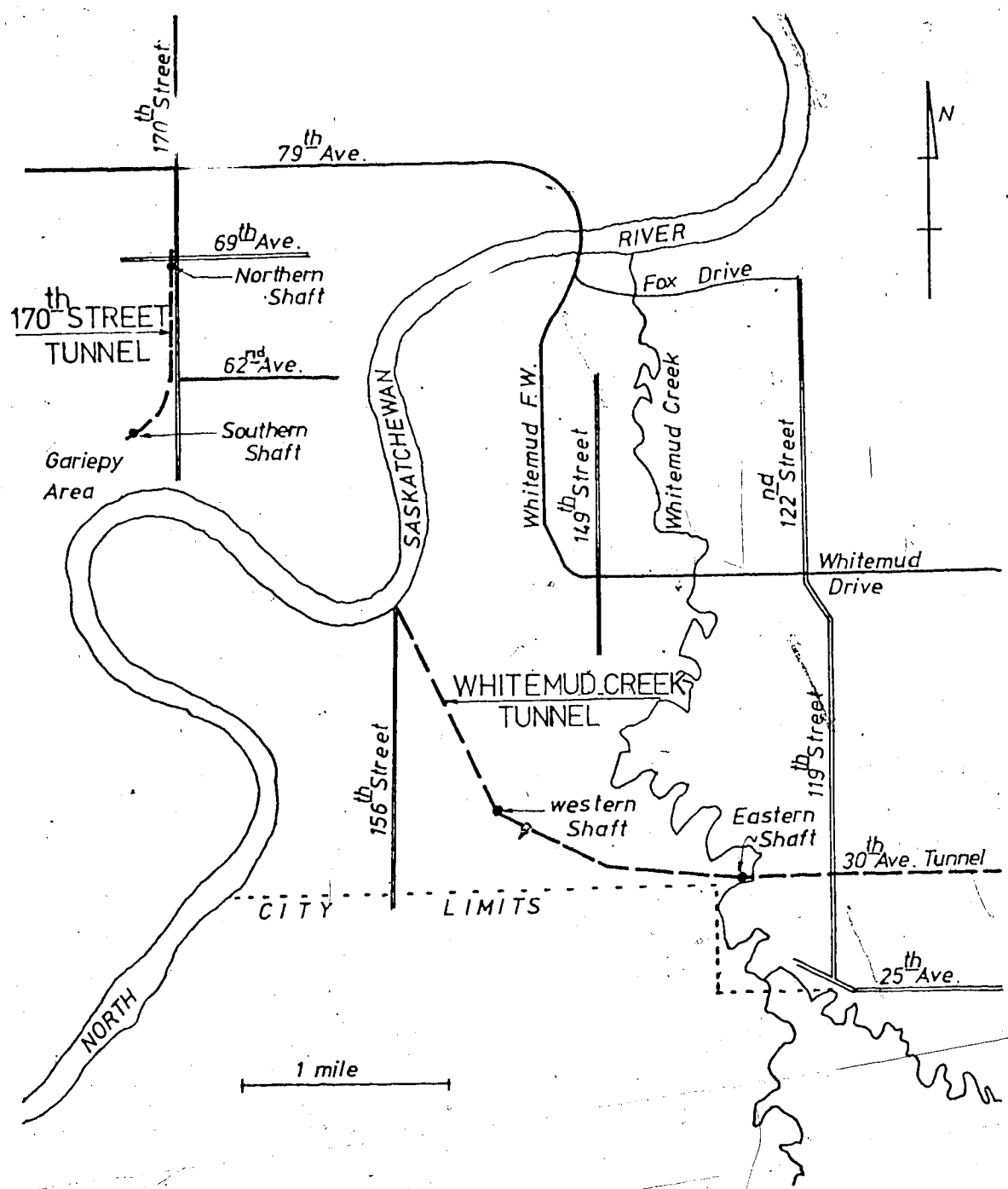

Figure 2.1 General Location of the Tunnels.

## 2.2 Whitemud-Creek Tunnel

### 2.2.1 General

The excavated diameter of the Whitemud Creek Tunnel was 19' 10". It was bored through bedrock which was essentially clay-shale interbedded with layers of sandstone with an average overburden cover of 155 feet.

This tunnel was provided with two 14 ft. (O.D.) construction shafts. The eastern shaft was located in the Whitemud-Creek Valley, while the western shaft was mid-way between the Whitemud Creek and the North Saskatchewan River (Figure 2.1). Small shafts (2'I.D.) were constructed to provide access for power, ventilation, and concrete and to be used as drop holes in the future.

### 2.2.2 Subsurface Profile

The ground profile between the construction shafts is shown in Figure 2.2. The clay-shale cover over the crown of the tunnel varies between 20 and 80 feet thick and is overlain by glacial till, silty-sand and lake sediments. However, test holes near the eastern shaft showed that the clay-shale is overlain by a layer of sands and gravels. This is probably the Saskatchewan Sands and Gravels deposited in the preglacial valley terminating at this location (Kathol and McPherson, 1975 - Figure 27).

This part of the tunnel (between the two shafts) was

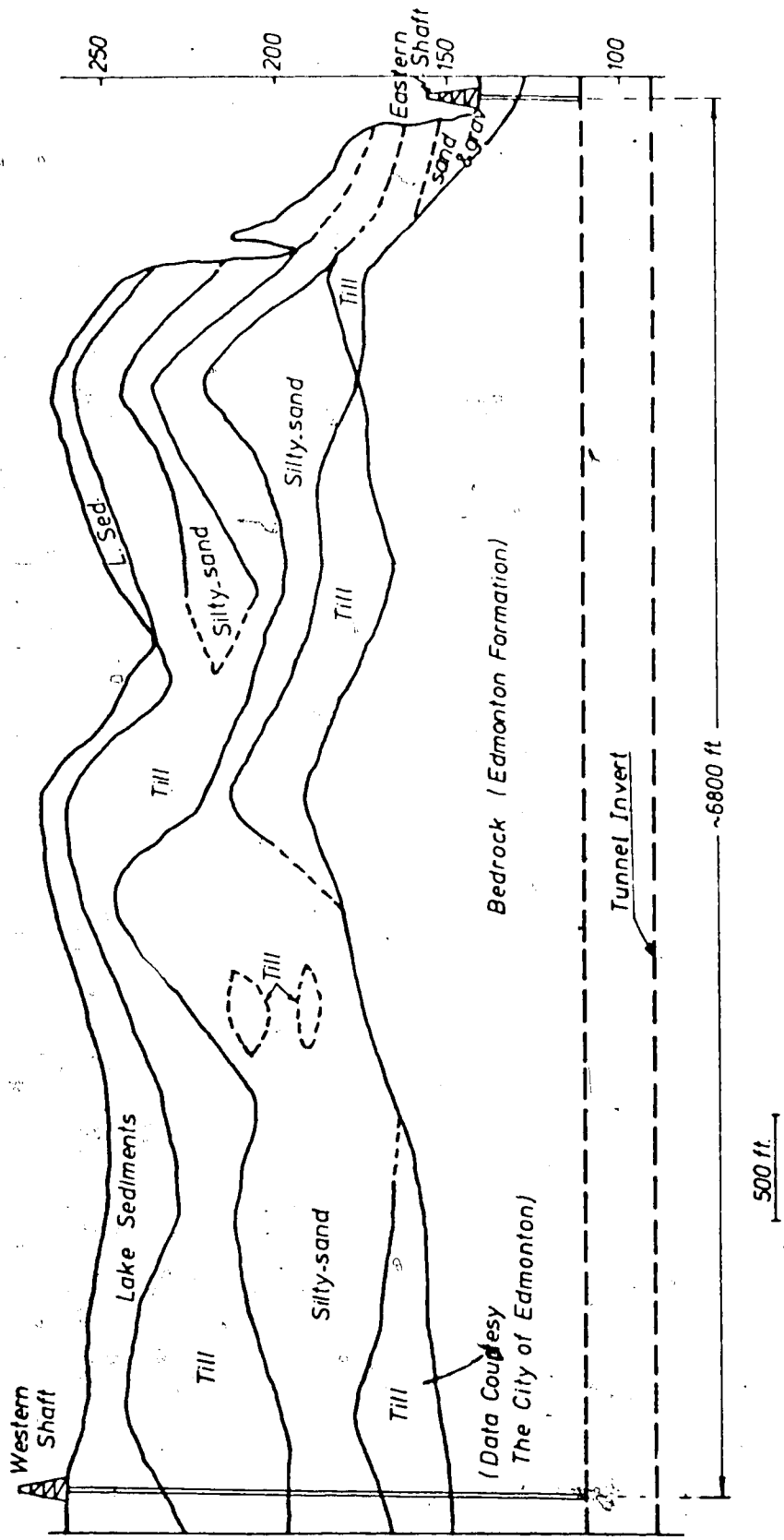

Figure 2.2 Soil Profile along the Whitemud-Creek Tunnel.

almost dry before the secondary concrete lining was placed. However, water seepage was noticeable into the undercut below the shafts and into a zone about 1500 feet east of the western shaft especially after the spring snow-melt. This seepage could be attributed to the relatively thin layer of semi-impermeable clay-shale and the accumulation of a head of water due to the snow-melt above the clay-shale surface.

Table 2.1 shows the geotechnical properties of clay-shale samples collected from the tunnel face. Typical geotechnical properties of the unweathered Upper Cretaceous Edmonton Formation in general are given by Thomson (1970, 1971) and Eigenbrod and Morgenstern (1972).

### 2.2.3 Tunnel Boring Machine

This tunnel was bored by two moles. The first advanced to the west from the eastern shaft and the second advanced in the opposite direction from the western shaft. They reached a section about 3025 feet west of the eastern shaft in January 1977.

The moles had a cutting diameter of 19' 10", by a wheel containing six spokes and a central conical front edge. The face of the mole was provided with a set of carbide teeth.

As shown in Figure 2.3, each mole was provided with four horizontal and two vertical jacks. These jacks were used to advance the mole after a new rib had been placed

Table 2.1:

Geotechnical Properties of the Clay-Shale

|                            |                                 |
|----------------------------|---------------------------------|
| Bulk unit weight           | 135 pcf (2.2 t/m <sup>3</sup> ) |
| Average moisture content   | 15%                             |
| Void ratio (av.)           | 0.44                            |
| Degree of saturation (av.) | 92%                             |
| Liquid limit (av.)         | 111%                            |
| Plastic limit (av.)        | 27.4%                           |
| Grain size (M.I.T.) Clay   | 56%                             |
| Silt                       | 44%                             |

Swelling Pressure:

|                      |          |
|----------------------|----------|
| Horizontal Direction | 0.75 tsf |
| Vertical Direction   | 0.50 tsf |

Permeability: (From consolidation tests)

|                      |   |
|----------------------|---|
| Horizontal Direction | 3.9x10 <sup>-10</sup> cm/sec<br>(1.54x10 <sup>-10</sup> in/sec) |
| Vertical Direction   | 1.7x10 <sup>-11</sup> cm/sec<br>(0.67x10 <sup>-11</sup> in/sec) |

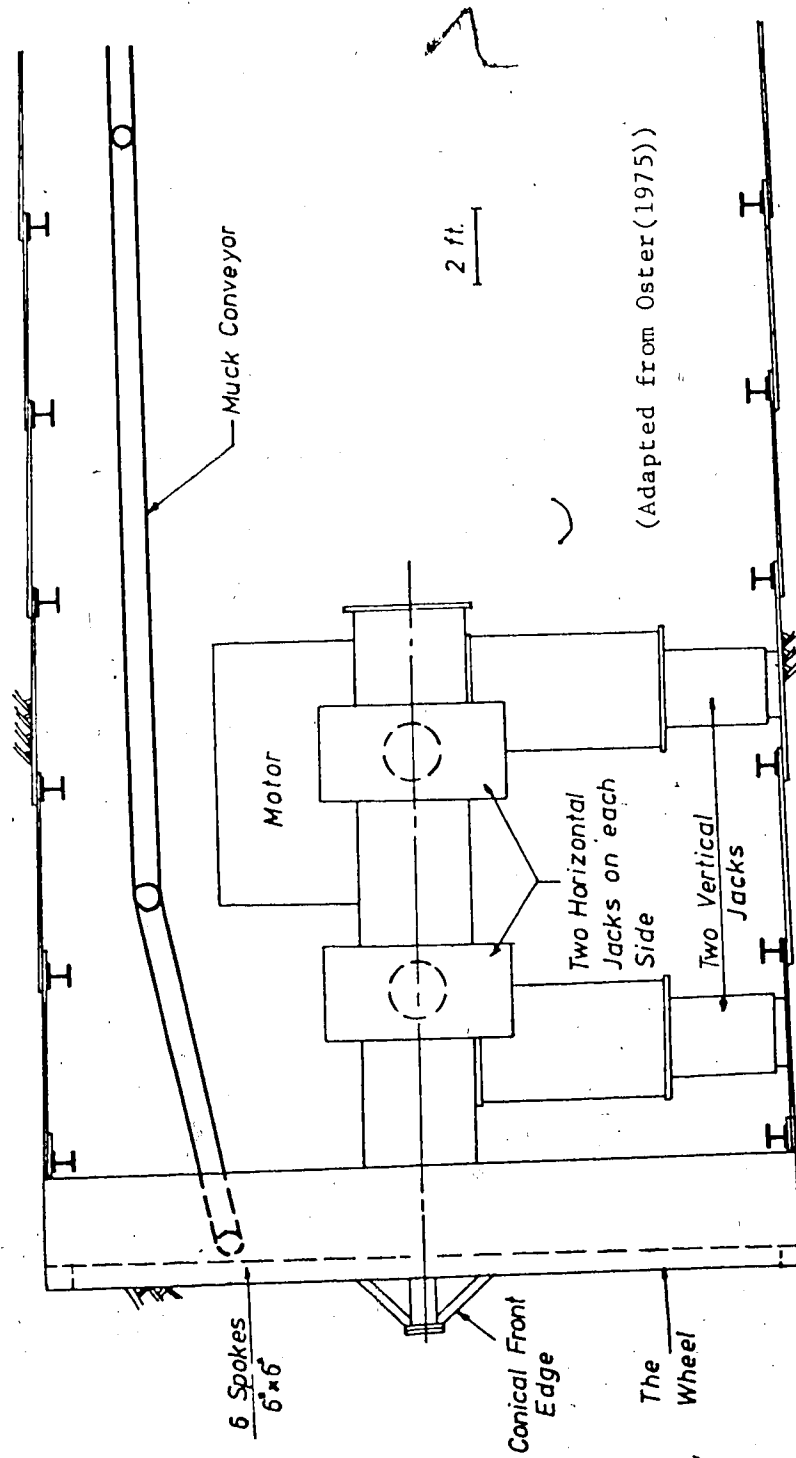

Figure 2.3 Mole Used in the Whitemud-Creek Tunnel.

behind the wheel. The average rate of excavation was 15 ft./day (Emanuel, 1977). The muck was loaded into five cubic yard mine cars by a conveyor. These cars were hauled to the shafts by diesel or electric locomotives.

#### 2.2.4 Lining Systems

The primary lining consisted of (WF 6x25) steel ribs and 2" x 8" spruce lagging. The outside diameter of the ribs was 19' 2". Overlapping system of lagging outside the steel ribs was used as shown in Figure 2.4. This type of lagging has the advantages of simple placement and providing protection to the tunnel crews.

The secondary concrete lining was placed using movable steel-forms to give a finished diameter of 17 feet. The concrete was pumped in steel pipes from the ground surface through the power shafts to fill the space between the lining and the steel-forms. No steel reinforcement was used in this tunnel. However, the steel ribs were left embedded in the secondary concrete lining to act together as a composite structure.

### 2.3 170th Street Tunnel:

#### 2.3.1 General:

This tunnel was constructed to connect the sewer network under the newly developed Garipey area to the existing main sewer interceptor under 79th Avenue (Figure



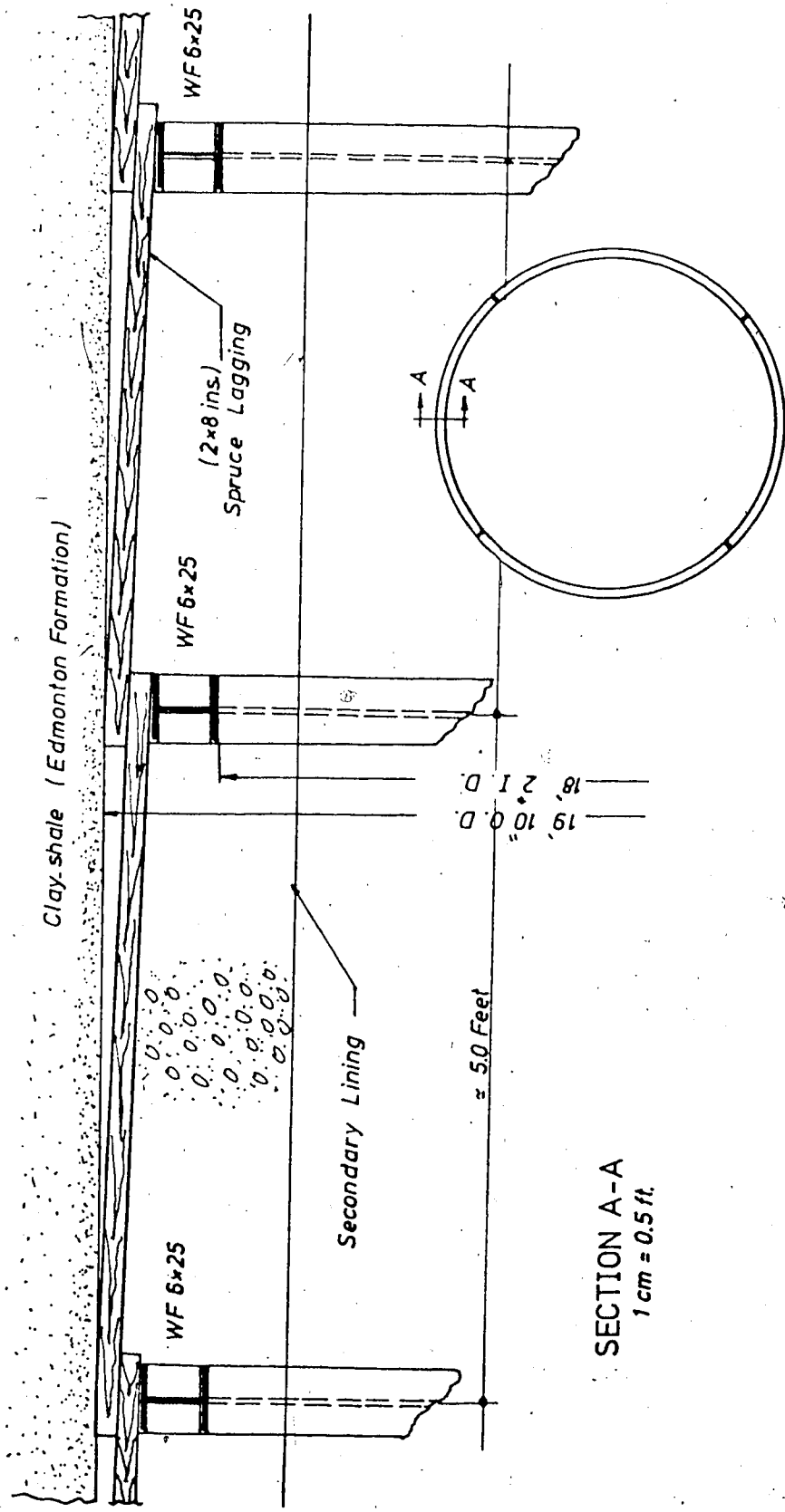

Figure 2.4 Details of the Lining Systems in the Whitemud-Creek Tunnel.

2.1). The excavated diameter of this tunnel was 101 inches and the finished inside diameter was 60 inches with an average overburden cover of 70 feet. The tunnel axis dipped 0.49% towards the northern shaft.

Two vertical construction shafts (14' O.D.) were dug at the southern end and near 69th Avenue (Figure 2.1). The tunnel was provided also with four drop-holes (2' I.D.) which were used for power supply, ventilation during construction and pumping concrete for the secondary lining.

### 2.3.2 Subsurface Profile

The tunnel was bored, starting from the northern shaft, through a layer of glacial till as shown in Figure 2.5. The geotechnical properties of this till are given in Table 2.2, while the properties of the glacial layers in the Edmonton area in general are given by Eisenstien and Thomson (1977). The last 1000 feet was excavated through a silty-sand layer. Tunneling through this layer using the same mole did not cause any problems. This was probably because of the partially saturated nature of this layer and the presence of silt which gave the sand enough cohesion to prevent it from raveling.

Excessive ground loss was reported in one location only, about 500 feet from the northern shaft where a pocket of sand filled with water near the crown caused a flow of sand slurry through the timber lagging.

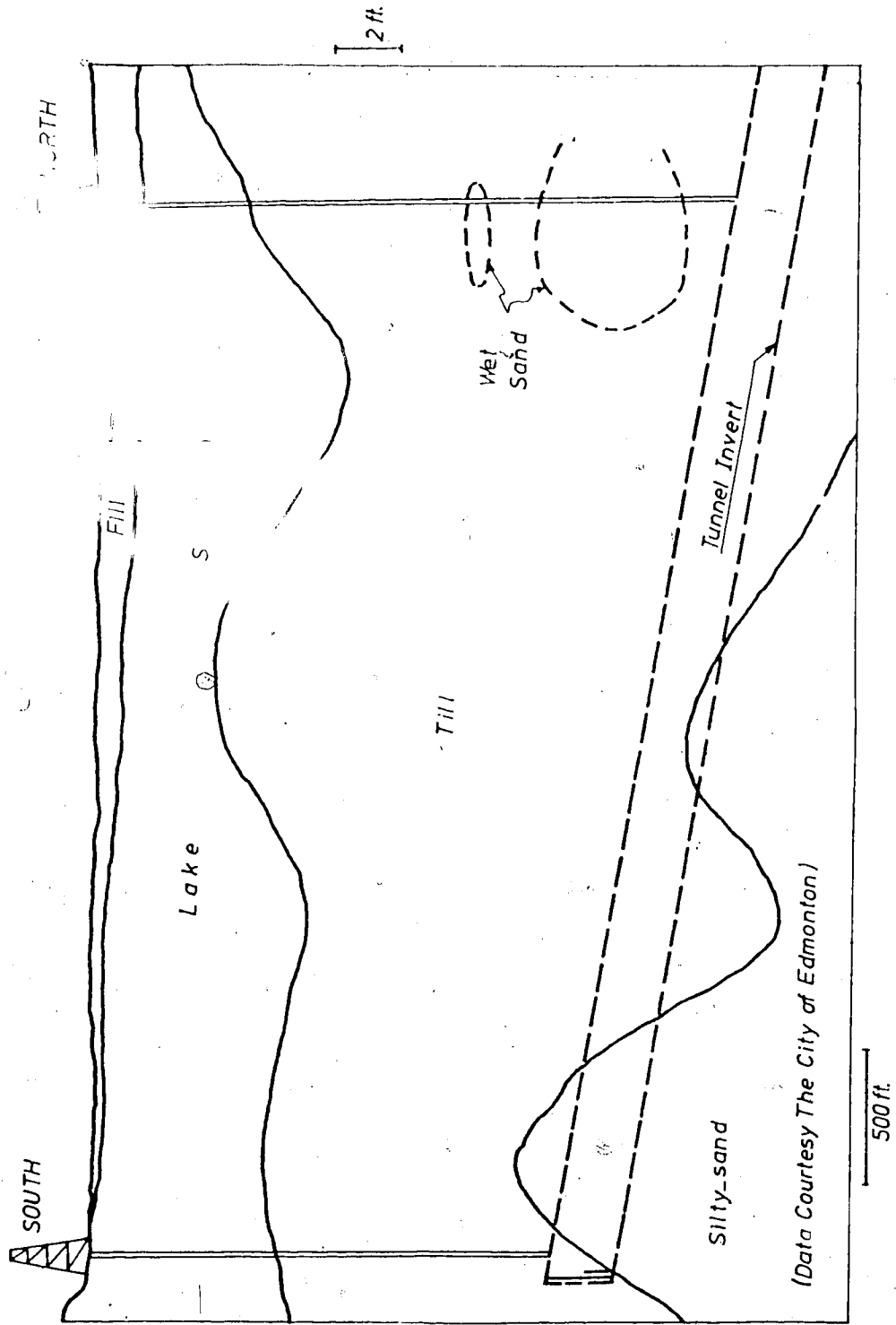

Figure 2.5 Soil Profile along the 170th Street Tunnel.

Table 2.2:

Geotechnical Properties of the Glacial Till:

|   |                                 |
|---|---------------------------------|
| Bulk unit weight                              | 138 pcf (2.2 t/m <sup>3</sup> ) |
| Average moisture content                      | 12.2%                           |
| Void ratio                                    | 0.36                            |
| Degree of saturation                          | 89%                             |
| Liquid limit                                  | 31%                             |
| Plastic limit                                 | 15%                             |
| Grain Size (M.I.T.) Clay                      | 42%                             |
| Silt  | 31%                             |
| Sand  | 27%                             |
| <u>Swelling Pressure</u> Horizontal Direction | 0.25 tsf                        |
| Vertical Direction                            | 0.25 tsf                        |
| <u>Compression Index</u> Horizontal Direction | 0.255                           |
| Vertical Direction                            | 0.09                            |

Large size boulders (up to 3 feet diameter) were reported during excavation. These boulders were mainly sedimentary or igneous rocks with rounded to sub-rounded shapes and smooth surfaces. These rocks delayed the mole advance where their size was larger than the size of the openings in the mole face. Jack-hammers were used to break these boulders before the mole could continue its advance.

### 2.3.3 Tunnel Boring Machine:

One of the City's moles (Lovat 100" O.D.) was used in boring this tunnel. As shown in Figure 2.6, it consisted of: cutting head, oil reservoir area, and the power plant. The mole was connected to a shield having the same outside diameter. The wheel, on the front of the cutting head, was formed of three spokes with a conical edge at its centre. The power plant contained all the operating valves and controlling gauges. A muck conveyor was connecting the cutting head through the power plant to the mine cars.

The mole advanced, while boring, using eight jacks on the circumference of the power plant by jacking against the last placed rib. The average rate of boring by this mole was 90 feet/day working in three shifts. When the mole reached the southern end it was taken out through the prebored southern constructional shaft.

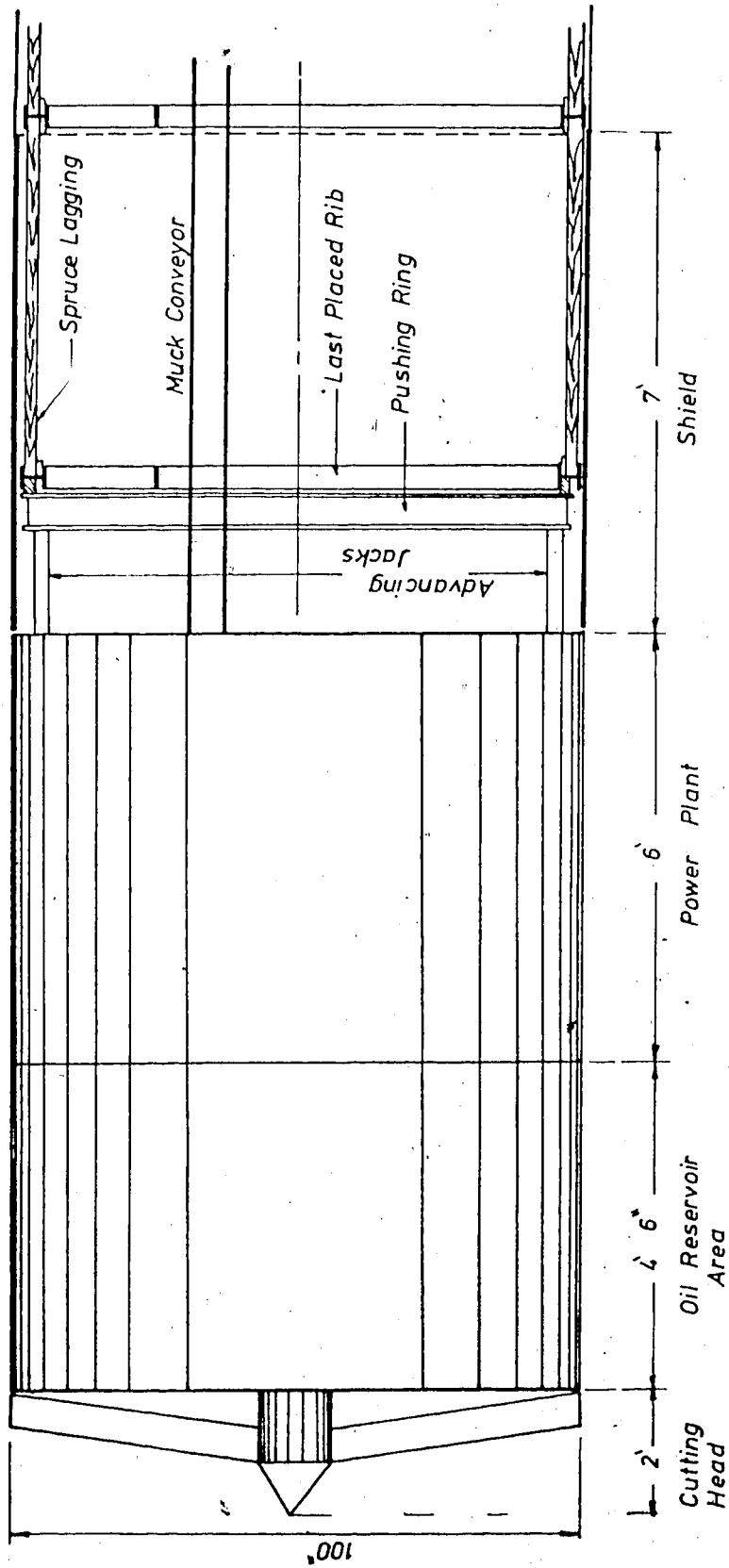

Figure 2.6 Mole and Shield Used in the 170th Street Tunnel.

#### 2.3.4 Lining Systems

As illustrated in Figure 2.7, the primary lining of this tunnel consisted of steel ribs (WF4x13) and timber lagging (2"x8"x5'). The ribs were preformed into rings with average outside diameter of 8.27 feet. Each ring consisted of three segments connected by two bolts in each joint.

After a new rib was placed with untightened joints, a row of laggings was placed between the flanges of this rib and those of the latter rib. Then, the mole started boring again and advanced using its eight jacks. As soon as the shield had advanced past the new rib, the upper joints of this rib were opened using two hydraulic jacks and two 4" spacers (channel section) were placed inside these spaces and the bolts were tightened.

The plain concrete secondary lining was placed starting from the southern shaft ten days after the mole was taken outside of the tunnel. The concrete used for this tunnel was 4000 psi Type V, sulphate resistant. The steel-forms and the procedure used for placing the concrete were similar to those used in the Whitemud-Creek Tunnel. The finished inside diameter of the concrete lining was sixty inches.

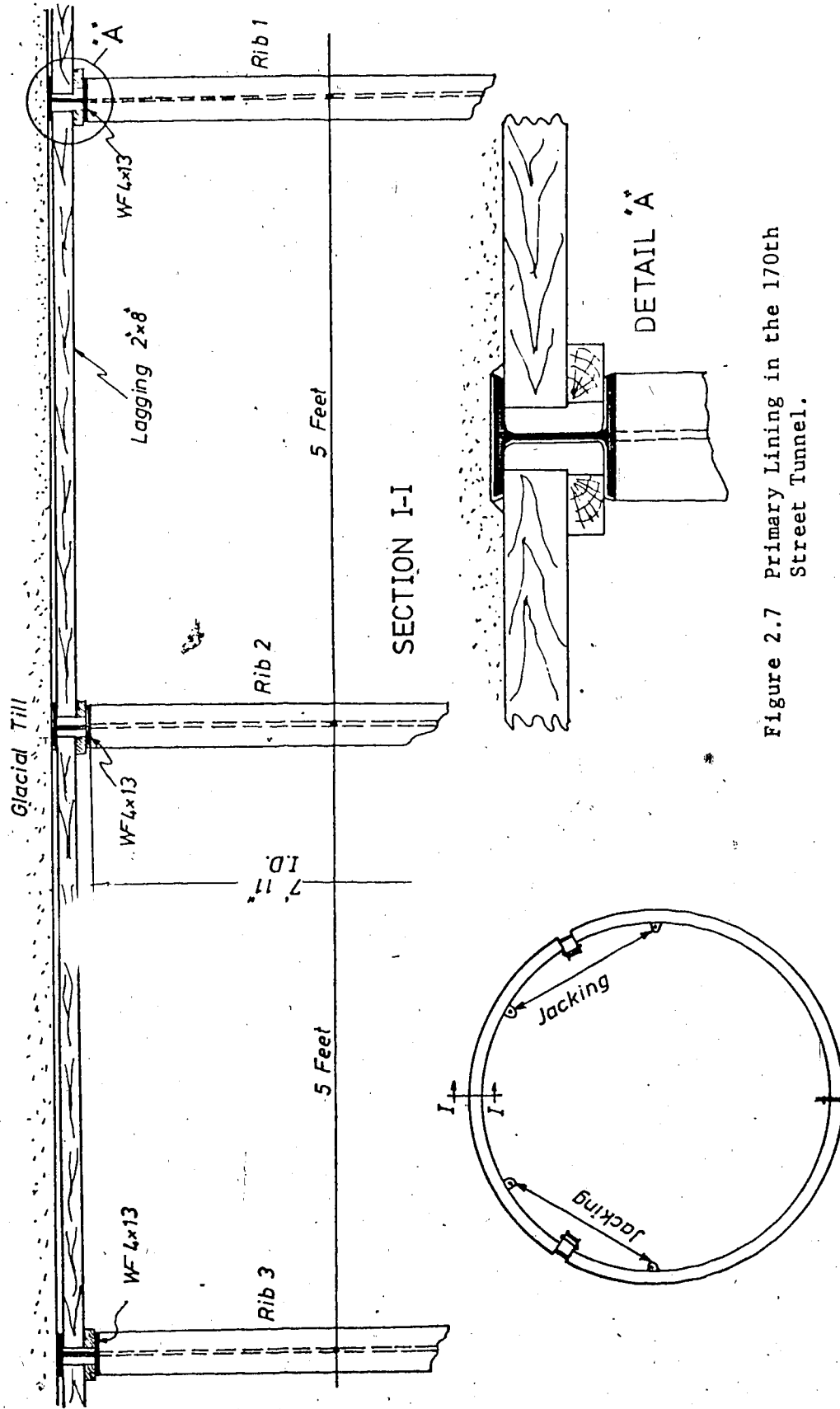

Figure 2.7 Primary Lining in the 170th Street Tunnel.



## CHAPTER III

### FIEL MEASUREMENTS

#### 3.1 Introduction

Field measurements and observational techniques were the basis of applied soil mechanics during the 1940's. At that time, the observational method was adopted by Terzaghi to avoid a conservative design resulting from using an excessive factor of safety and the danger of depending on a general average experience alone (Terzaghi, 1961; Peck, 1969 a). This "Learn-as-you-go" method depended on comparing field measurements with theoretically expected values and modifying the design, if needed, during construction. The Austrian Tunneling Method (Rabcewicz, 1973, 1974) can be considered as a successful application of the observational method for tunneling.

For soft ground tunneling, it was concluded from the literature review given in section 1.1 that any real progress in the design of tunnels is dependent on reliable field measurements for different geological formations and methods of constructions. These measurements are hard to obtain but will validate the new analytical procedures and hence close the gap in our knowledge concerning the behaviour of the ground and the lining, and the interaction between them. On the other hand, these measurements can be used in an empirical procedure whenever theoretical methods fail to give a reliable solution as in the case of ground

surface movement due to tunneling.

In this Chapter, the record of field measurements in the Whitemud-Creek and the 70th Street Tunnels is presented with the details of the instrumentations. Evaluation and analysis of these measurements are presented in Chapter IV.

### 3.2 Field Measurements in the Whitemud-Creek Tunnel:

The test section in this tunnel was located about 3000 feet from the eastern shaft. Deformation measurements of three ribs were started as soon as they were placed and continued for more than four months until the secondary concrete lining was placed. It was recognized that coupling these measurements with level changes of the tunnel invert was essential to calculate the absolute movements of the ribs.

In-situ pressuremeter tests were used to examine the behavior of the ground around the tunnel by determining the deformation modulus in the horizontal and vertical directions.

Figure 3.1 shows the details of this test-section.

#### 3.2.1 Deformation of the Ribs

A special instrument, constant Tension Extensometer, was designed to measure the change of the inside diameters of the ribs with reasonable accuracy ( $\pm 0.01''$ ). As

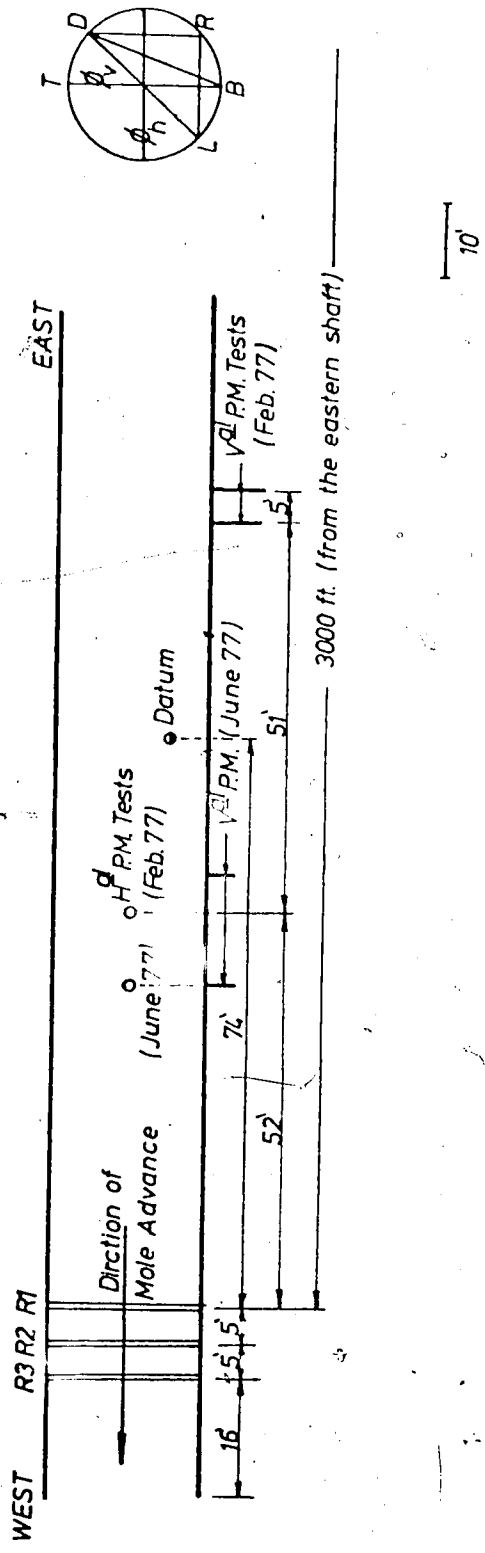

Figure 3.1 Details of the Test Section in the Whitemud-Creek Tunnel.

illustrated in Figure 3.2, the extensometer consisted of a four-inch dial gauge reading to 0.001" with a spring attached to it. The spring was fixed to the dial from one end and free to expand from the other. A hook was provided to the movable end.

A steel Engineering tape, about 20 feet long, and 5/16 inch wide was provided with a hook on one end and a set of holes on the other. The spacing between these holes was four inches which is the range of the dial gauge. The size of the holes was suitable for the hook provided at the movable end of the spring.

The main purpose of providing a spring to the dial was to create a constant tension in the tape which eliminates the sagging effects.

Small eye-bolts were fixed to the inside flange of each abutment at the spring-points, crown, invert and 45° diagonal points. For measurements, the tape was hooked to the eye-bolt on one end and the instrument was hooked to a suitable hole of the tape. A constant tension was applied and released three times, using the spring, and the average of the three corresponding readings of the dial gauge was recorded. The number of the hole to which the instrument was attached was also recorded. The diameters and chords which were chosen for measurements are shown in Figure 3.1. Figures 3.3 to 3.8 contain the record of the change in these measurements with time. Plate 1 shows the use of the constant tension

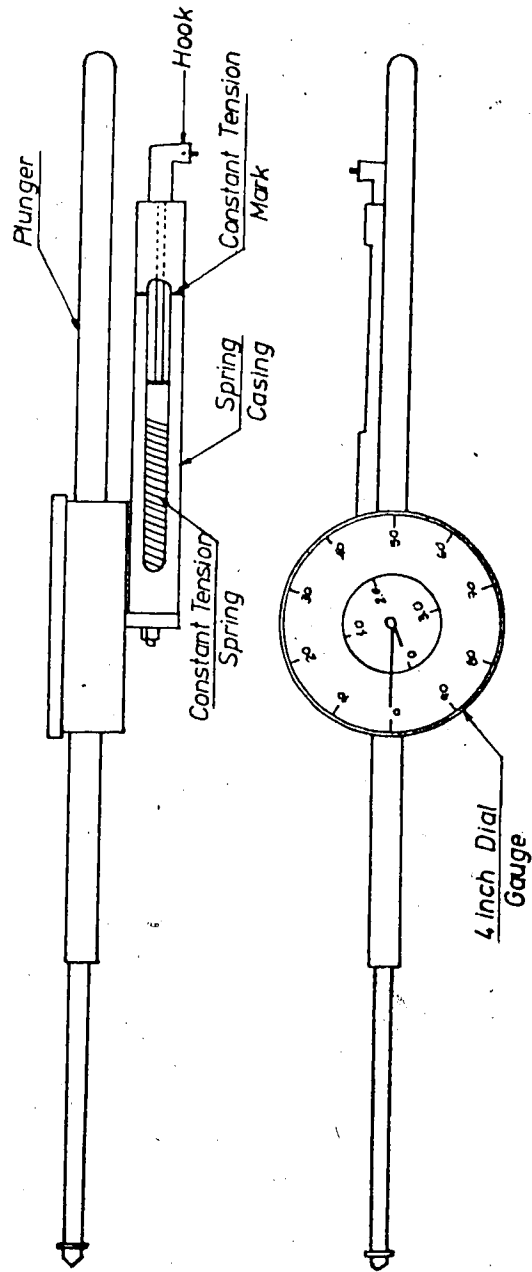

Figure 3.2 Constant Tension Extensometer.

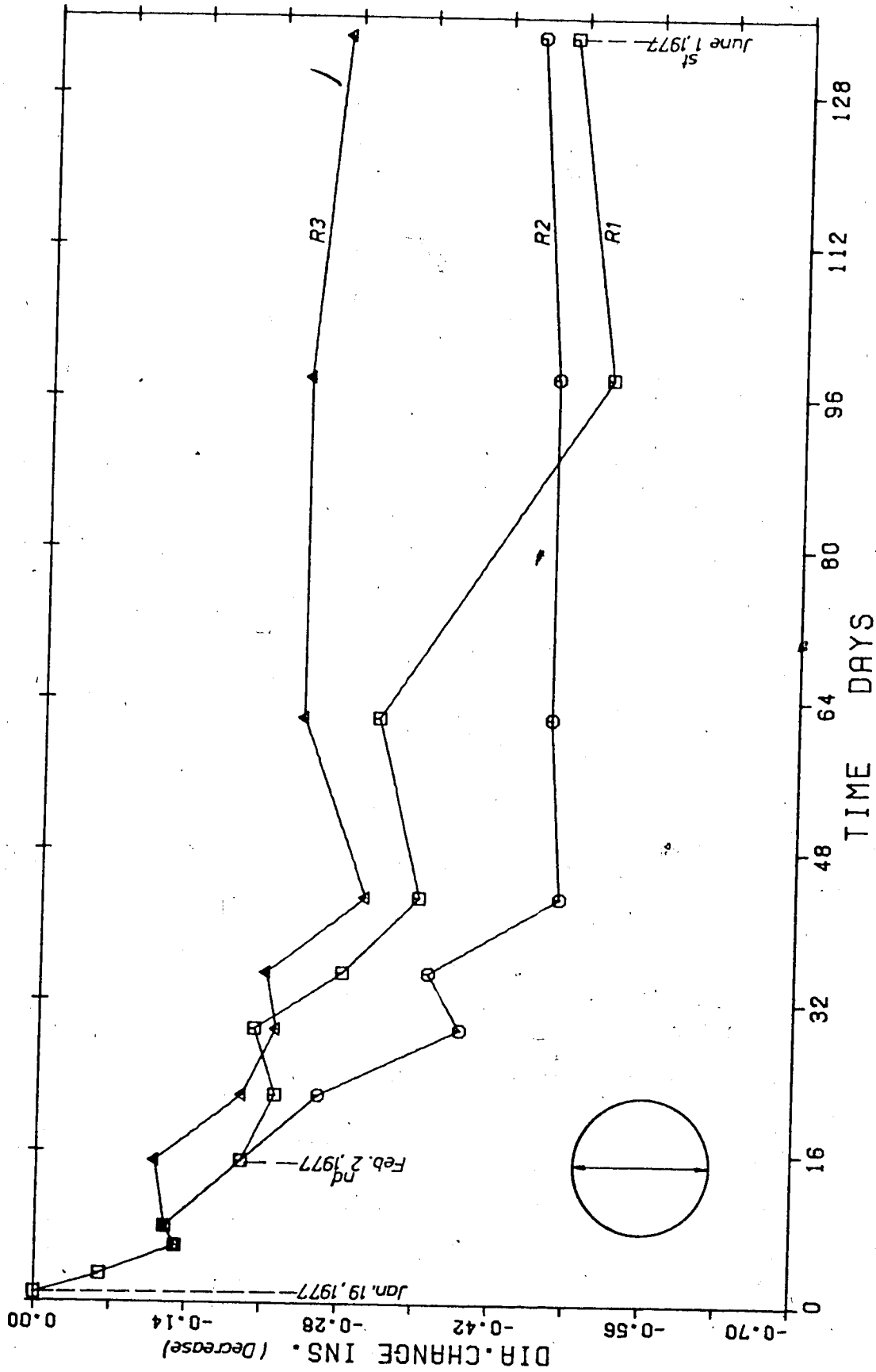

FIGURE 3.3 CHANGE IN VERTICAL DIAMETER

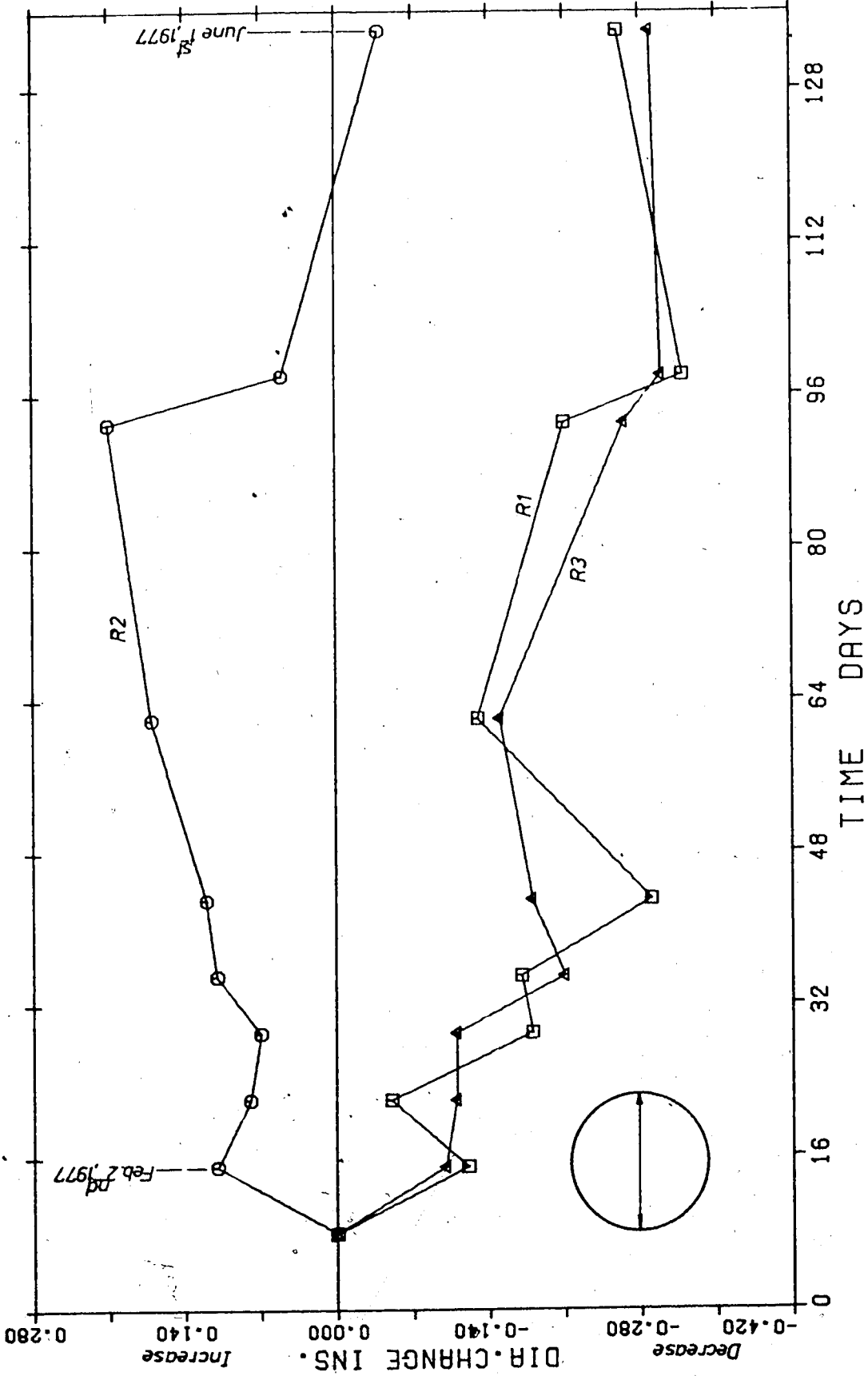

FIGURE 3.4 CHANGE IN HORIZONTAL DIAMETER

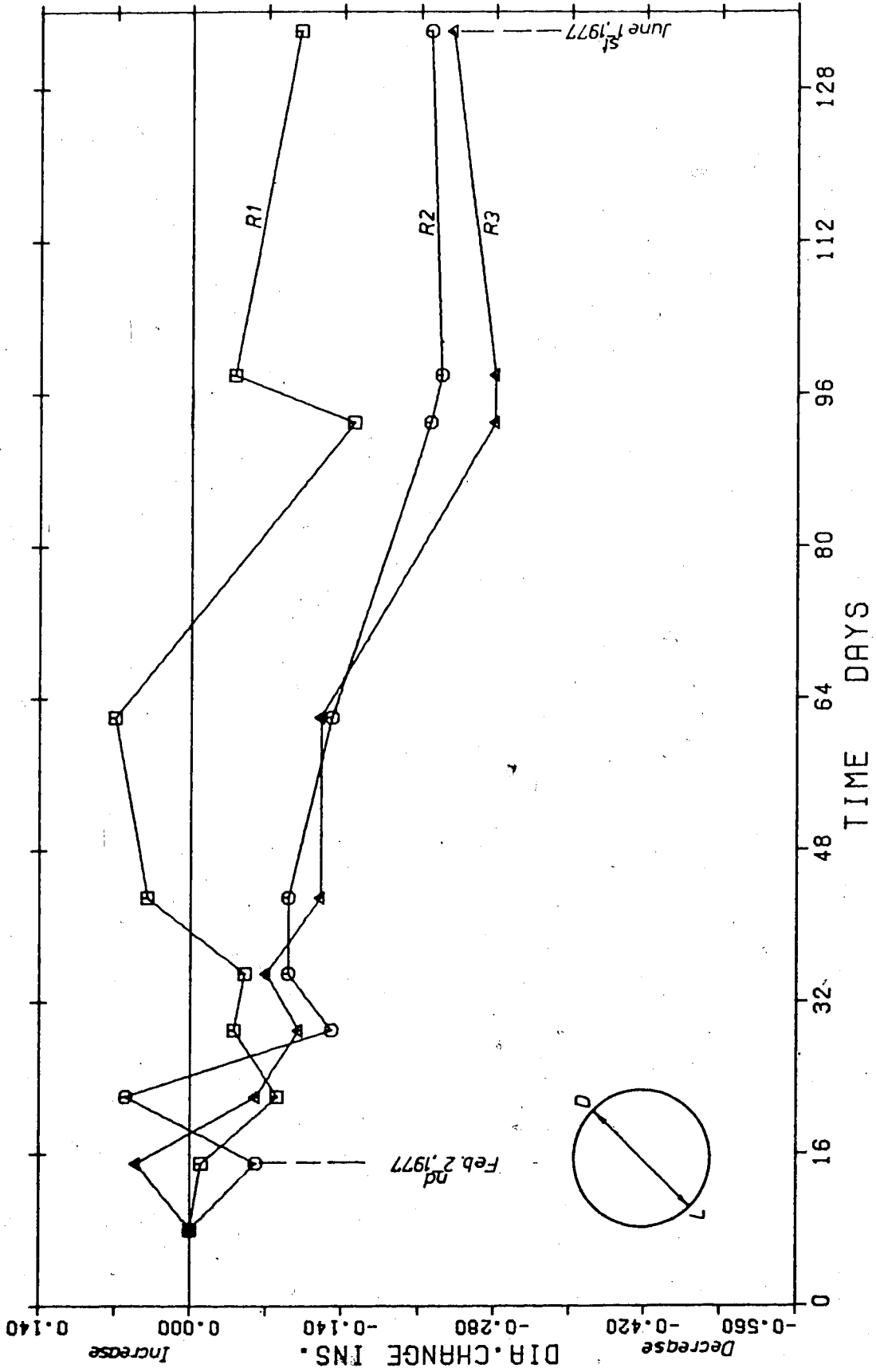

FIGURE 3.5 CHANGE IN DIAMETER D-L



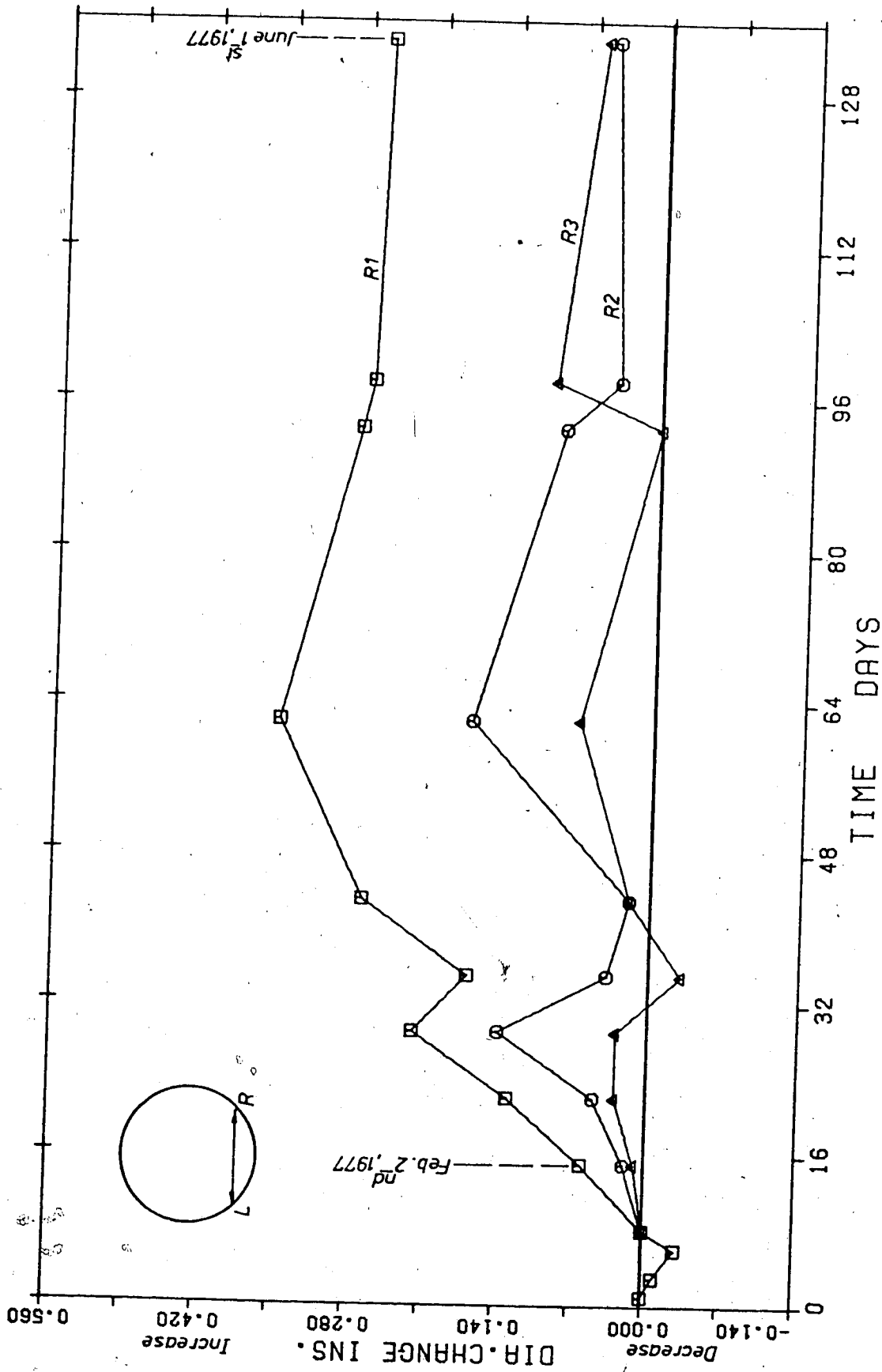

FIGURE 3.6 CHANGE IN CHORD L-R

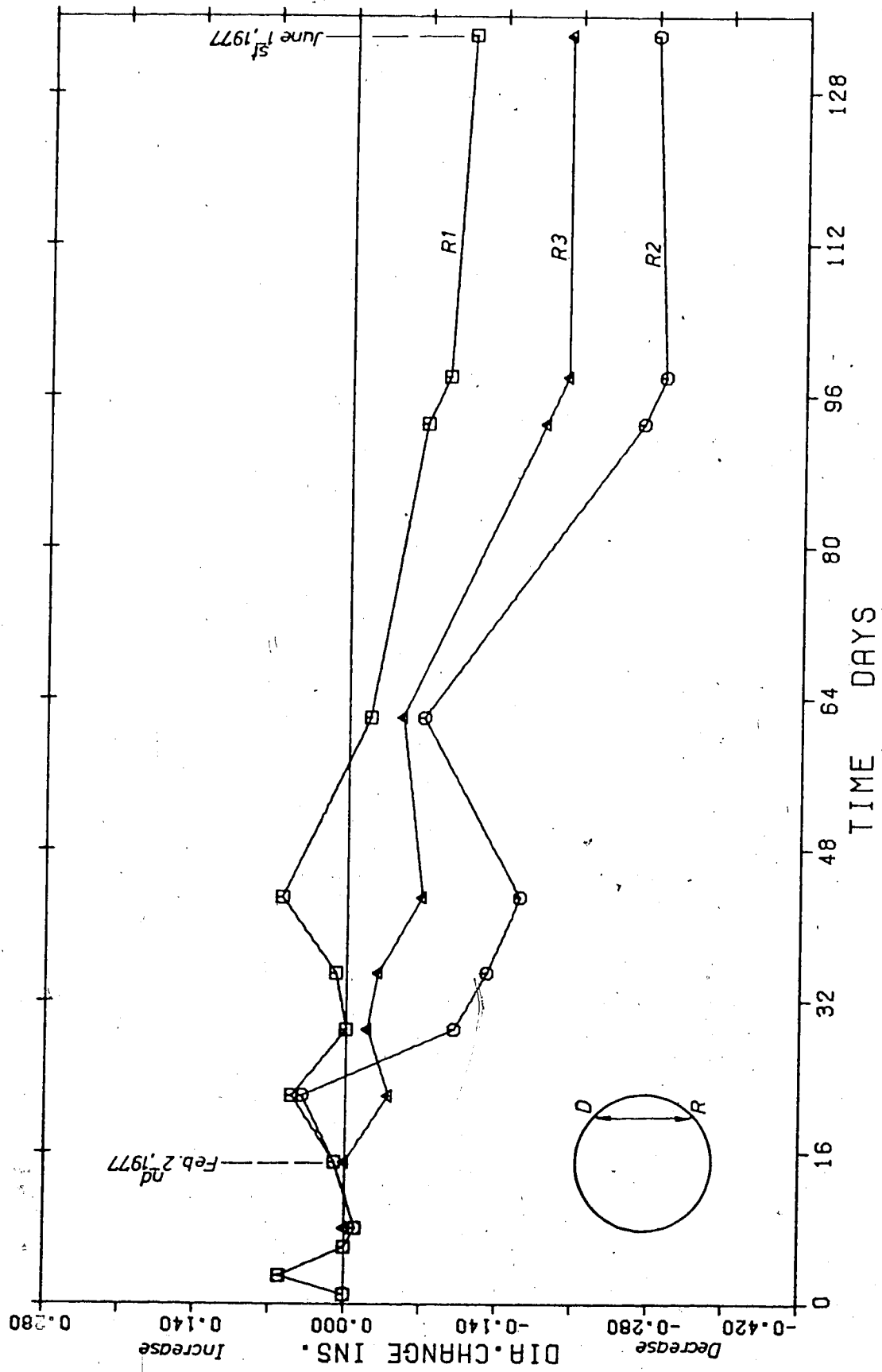

FIGURE 3.7 CHANGE IN CHORD D-R

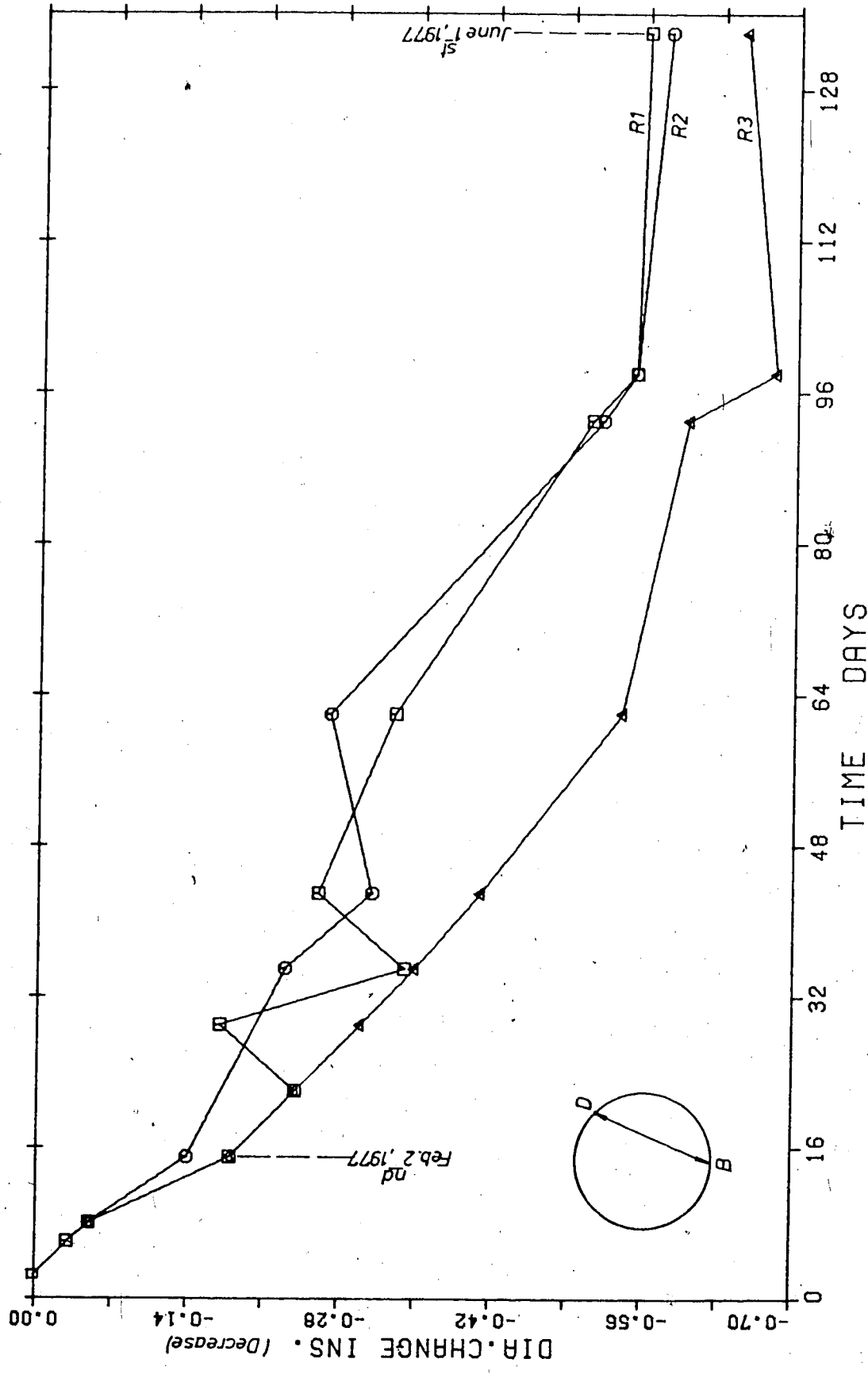

FIGURE 3.8 CHANGE IN CHORD D-B



Plate 1 Measurement of Deformation of the Ribs Using  
the Constant Tension Extensometer.

extensometer for these measurements.

### 3.2.2 Level Changes of the Ribs

The level changes of points L, B and R were recorded for the three ribs. A point 74 feet east of this section was used as a datum. Figure 3.9 shows the absolute level changes of these points with time.

### 3.2.3 In-situ Pressuremeter Tests

Two sets of the in-situ pressuremeter tests were used to determine the clay-shale deformation moduli two weeks after placing the ribs and just before the concrete secondary lining was placed.

For the first set, a five-inch diameter horizontal borehole was drilled near the spring-line. Drilling of this hole, 20 feet long, took about four hours. It was noticeable that the ground is almost homogeneous clay-shale.

Drilling in the vertical direction through the invert was difficult, and drilling through a layer of hard sandstone encountered at about 10 feet below the tunnel invert was almost impossible. Two vertical holes were drilled to this layer which took more than seven hours.

Before the secondary concrete lining was placed a similar set of pressuremeter tests was done to study the change in deformation properties of the surrounding clay

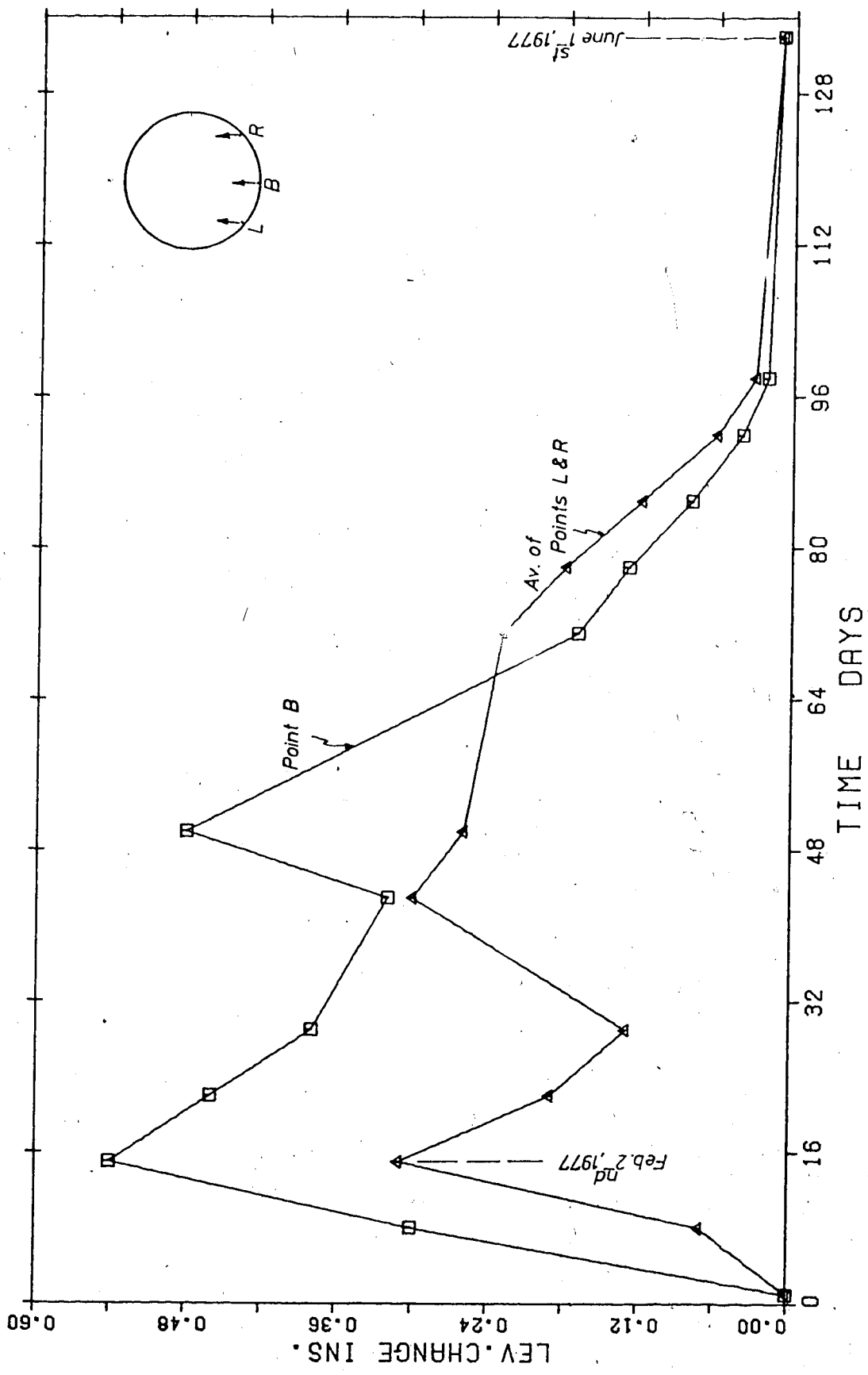

FIGURE 3.9 CHANGE IN INVERT LEVELS

shale with time.

Plate 2 shows the pressuremeter apparatus during testing in the horizontal direction. Details of the pressuremeter apparatus used in these tests are given by Burgess (1976) and the theoretical formulation is given by Gibson and Anderson (1961).

The volume change-pressure curves are given in Figure 3.10, and the final results of the tests with their interpretation are given in section 4.2.2.

### 3.3 Field Measurements in the 170th Street Tunnel

In this tunnel, the ground surface vertical movement was monitored near the intersection of 170th Street and 62nd Avenue. The movement of three ribs and lagging deflections was recorded in a test-section which was also provided with two pressure-cells.

#### 3.3.1 Ground Surface Vertical Movement

Thirteen settlement points were placed near the intersection of 170th Street and 62nd Avenue as shown in Figure 3.11. This location facilitated placing the settlement points on both sides above the tunnel axis and away from the construction activity in the Gariepy area.

The points were placed, during the first week of March, with their discs at 4.5 feet below the ground surface (see

U



Plate 2 In-situ Pressuremeter Test in the  
Whitemud-Creek Tunnel.



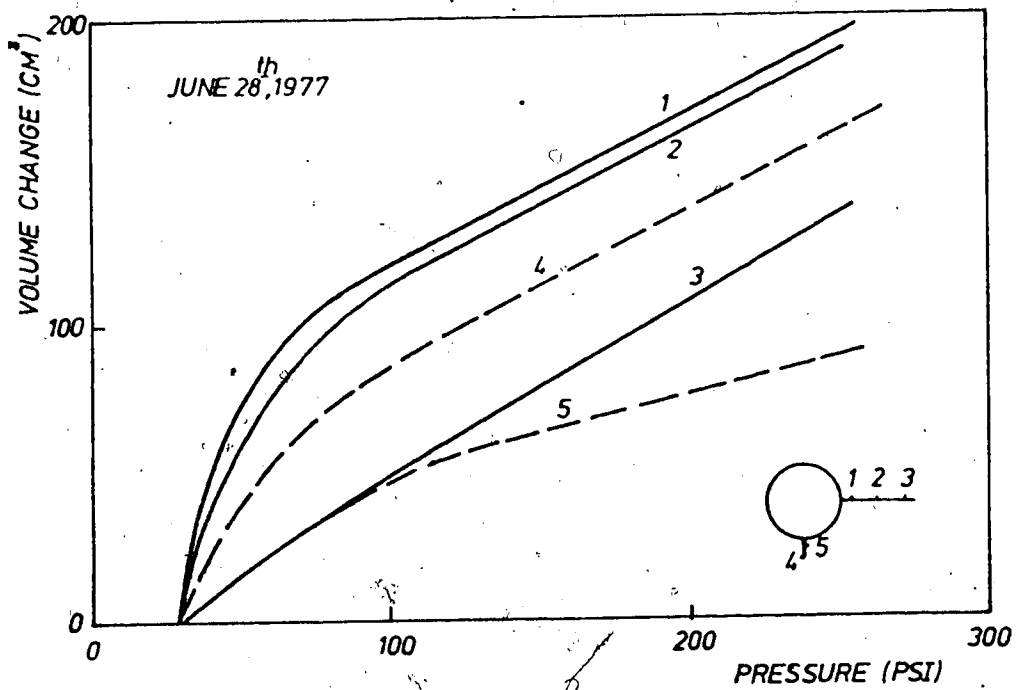
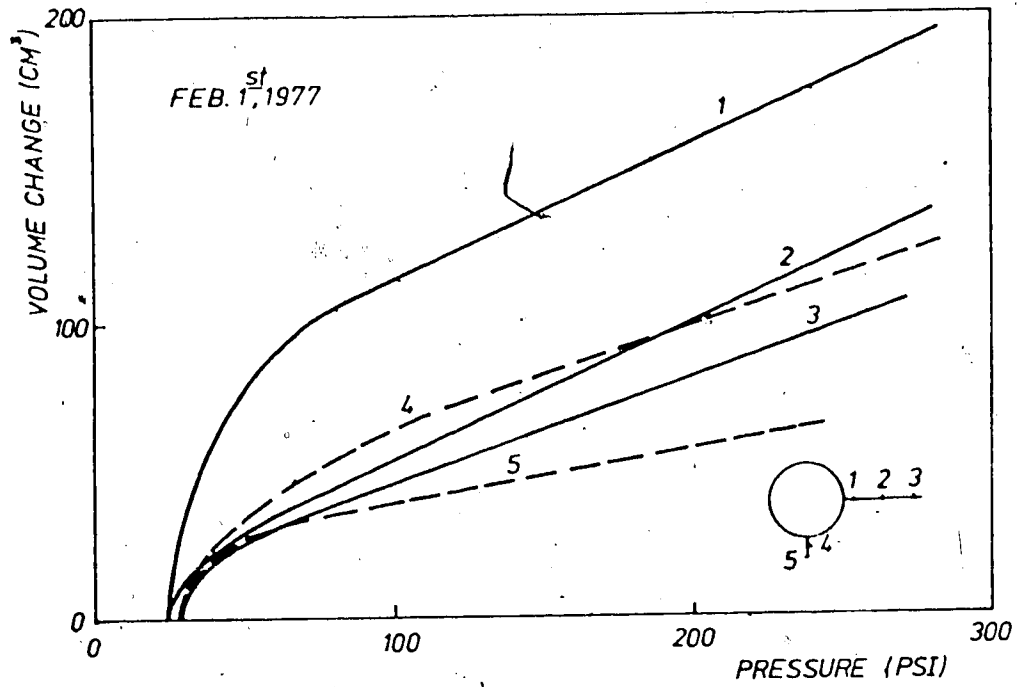

Figure 3.10 Results of In-situ Pressuremeter Tests.

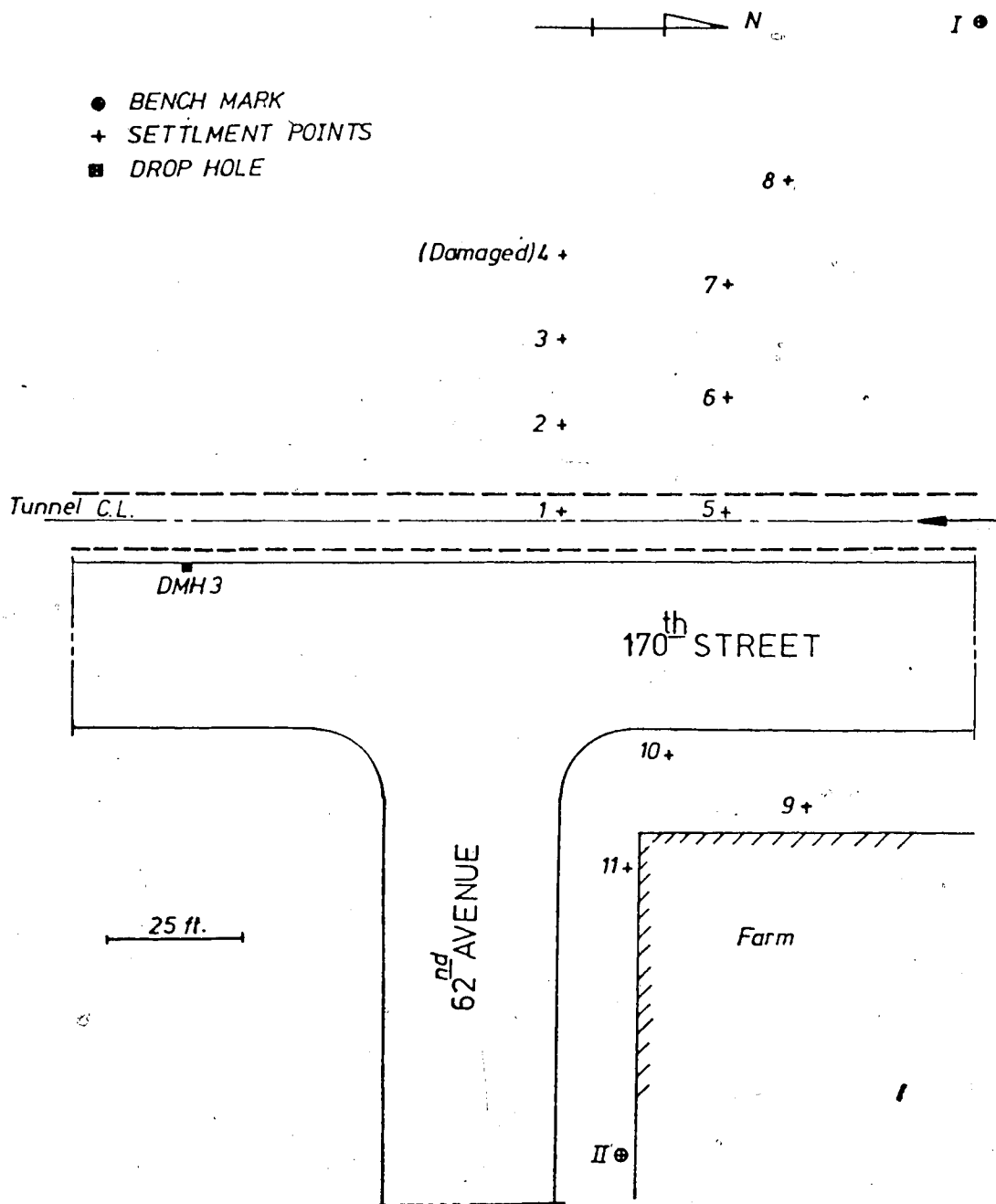

Figure 3.11 General Plan of the Settlement Points over the 170th Street Tunnel.

Figure 3.12) to avoid the frost effect which was three feet deep at this location. Two of these points, I and II, were placed at a horizontal distance of more than 80 feet from the tunnel centre-line; to be used as bench-marks on both sides. Thus, the effect of temperature changes and the variation of water conditions near the ground surface during the spring snow-melt could be excluded. Cooke level was used for the surface level survey with an accuracy of  $\pm 0.005$  ft.

Figure 3.13 shows a complete record of vertical movement of the ground surface at these points. Most of the points showed the same trend of movement with a maximum settlement when the mole was at about 75 feet before reaching under point 5. This was followed by a sudden heave when the mole was under the points followed by a gradual settlement which stabilized after two weeks.

### 3.3.2 170th Street-Tunnel Test Section

The measurements in this test section (see Figure 3.14) consisted of deformation measurements of three ribs, the level change of their inverts, the earth pressure on the laggings, and lagging deflection.

The measurements started as soon as the shield cleared the test section and after the upper joints were wedged. This monitoring was continued for two months until the secondary concrete lining was placed.

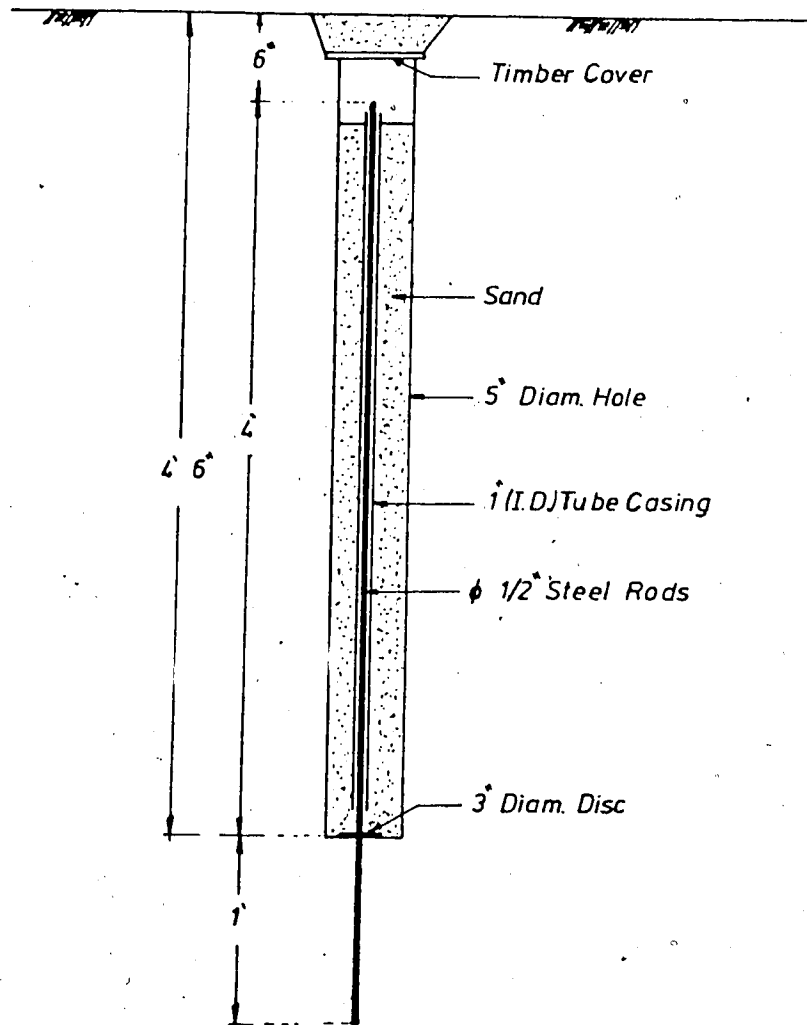

Figure 3.12 Details of a Settlement Point.

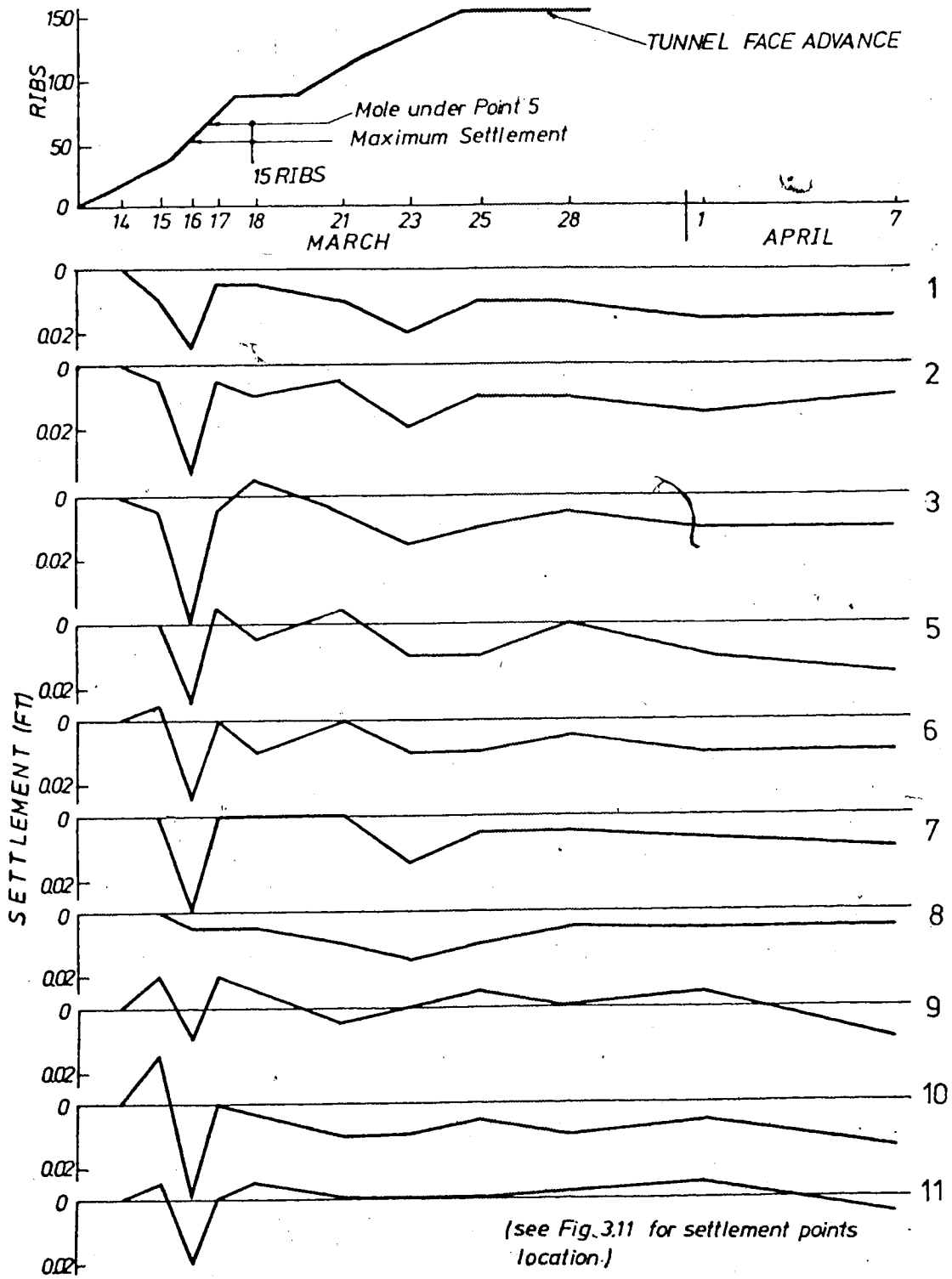

Figure 3.13 Ground Surface Movement over the 170th Street Tunnel.

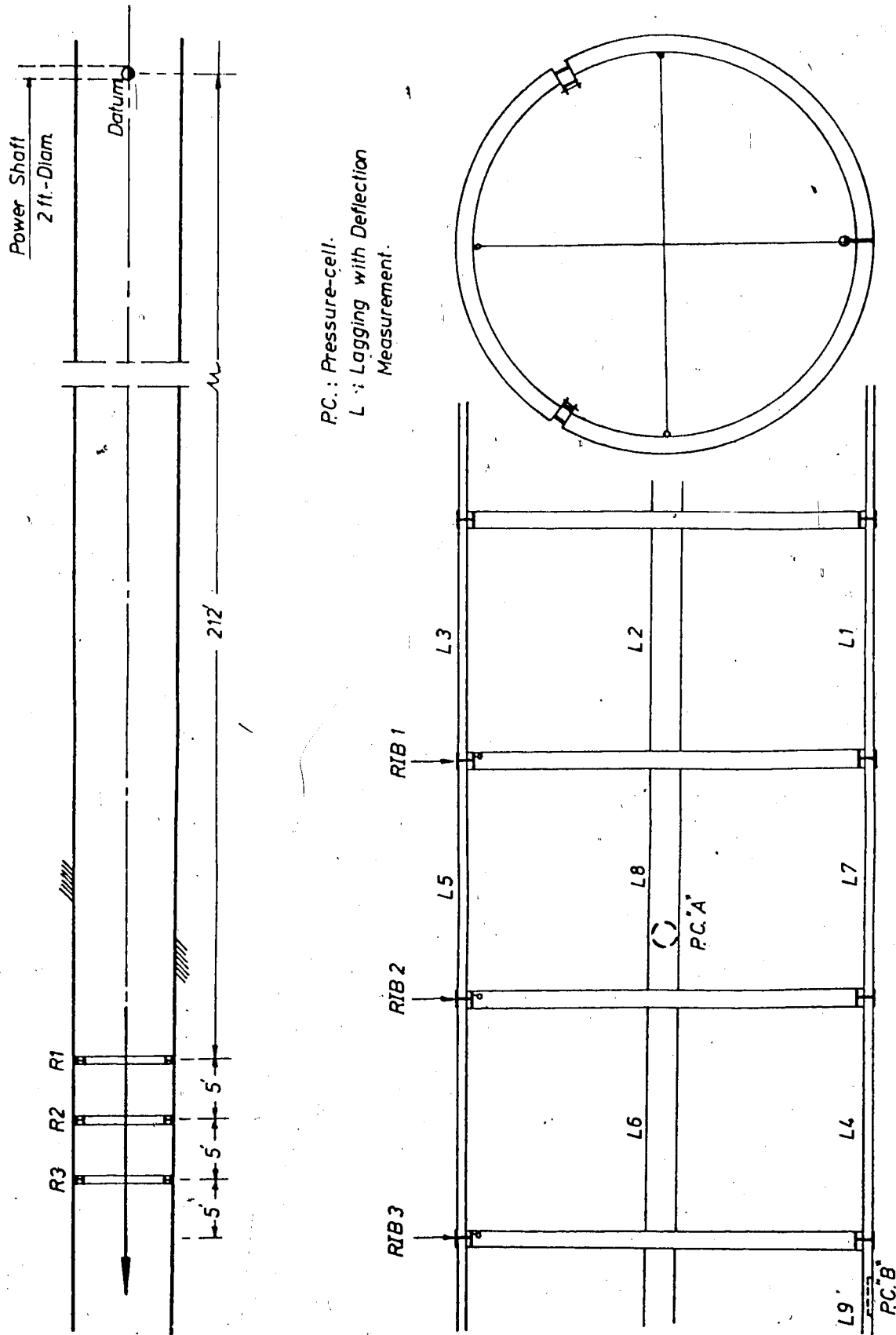

Figure 3.14 Details of the 170th Street Tunnel Test Section.

The excavated diameter of this tunnel was 101 inches while the outside diameters of the ribs were 98 inches and 100 inches in the horizontal and vertical directions respectively. Since the ribs lie on the bottom of the excavated space, a gap of 1 inch at the crown and 1.5 inches at the spring-line existed.

On examining 100 ribs which has been placed before the test section, it was noticed that this space was completely filled within two weeks. Moreover, lagging deflection of more than 0.5 inches in some sections was not uncommon, especially in sections near the northern shaft where excavation started. As a result of these observations, monitoring the closure of this gap was essential in order to simplify the interpretation of the other measurements.

The deformation of the ribs was measured by the same procedure used in the Whitemud-Creek Tunnel (see section 3.2.1). Records of the change in the vertical and horizontal diameters are given in Figures 3.15 and 3.16.

Figure 3.17 shows the change in the invert level of the ribs. Heave movement was recorded during the first week after installing the ribs, and was followed by a gradual settlement.

Two pressure-cells were installed on the outside surface of the lagging. The details of a pressure-cell are shown in Figure 3.18. A preliminary calculation of the

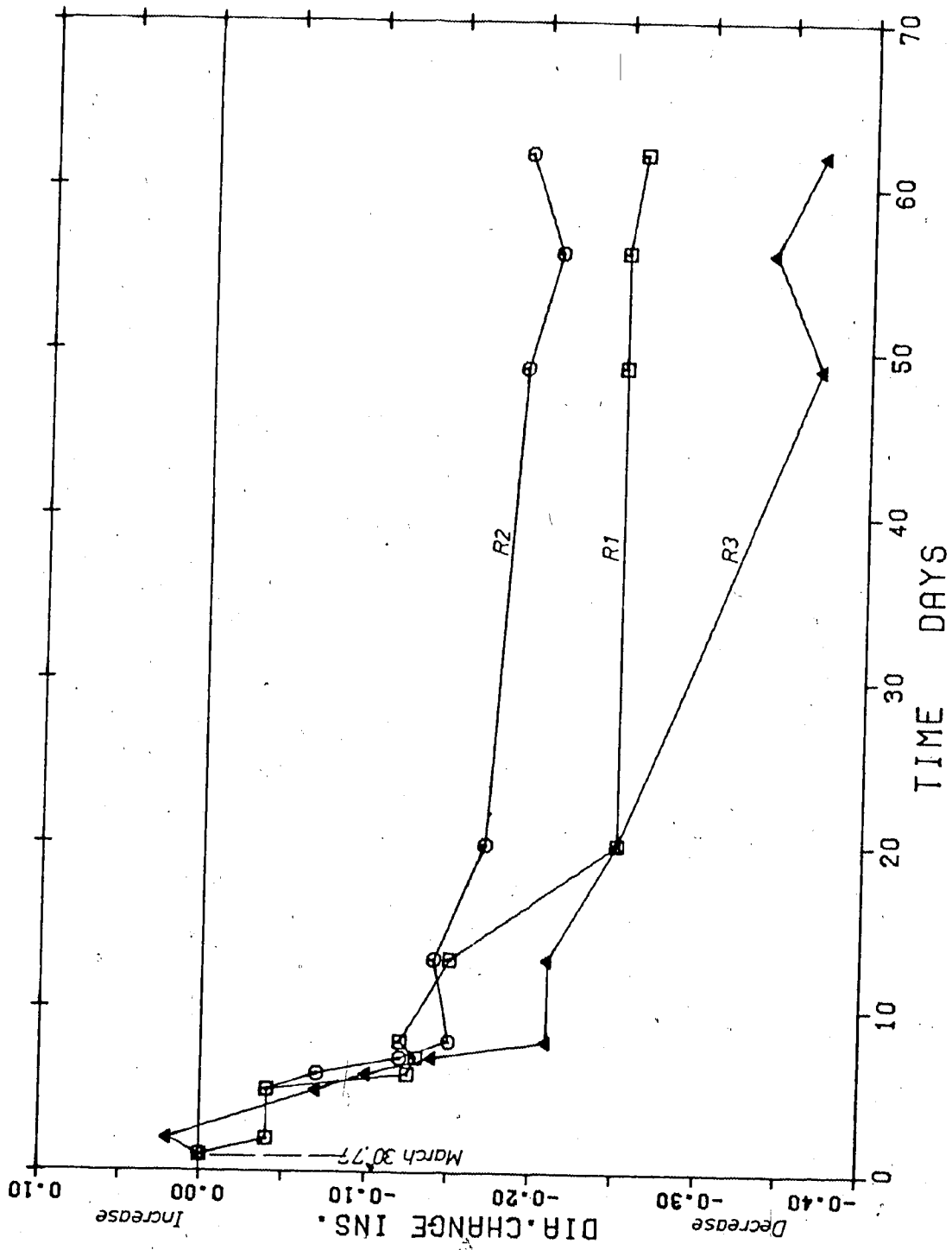

FIGURE 3.15 CHANGE IN HORIZONTAL DIAMETER



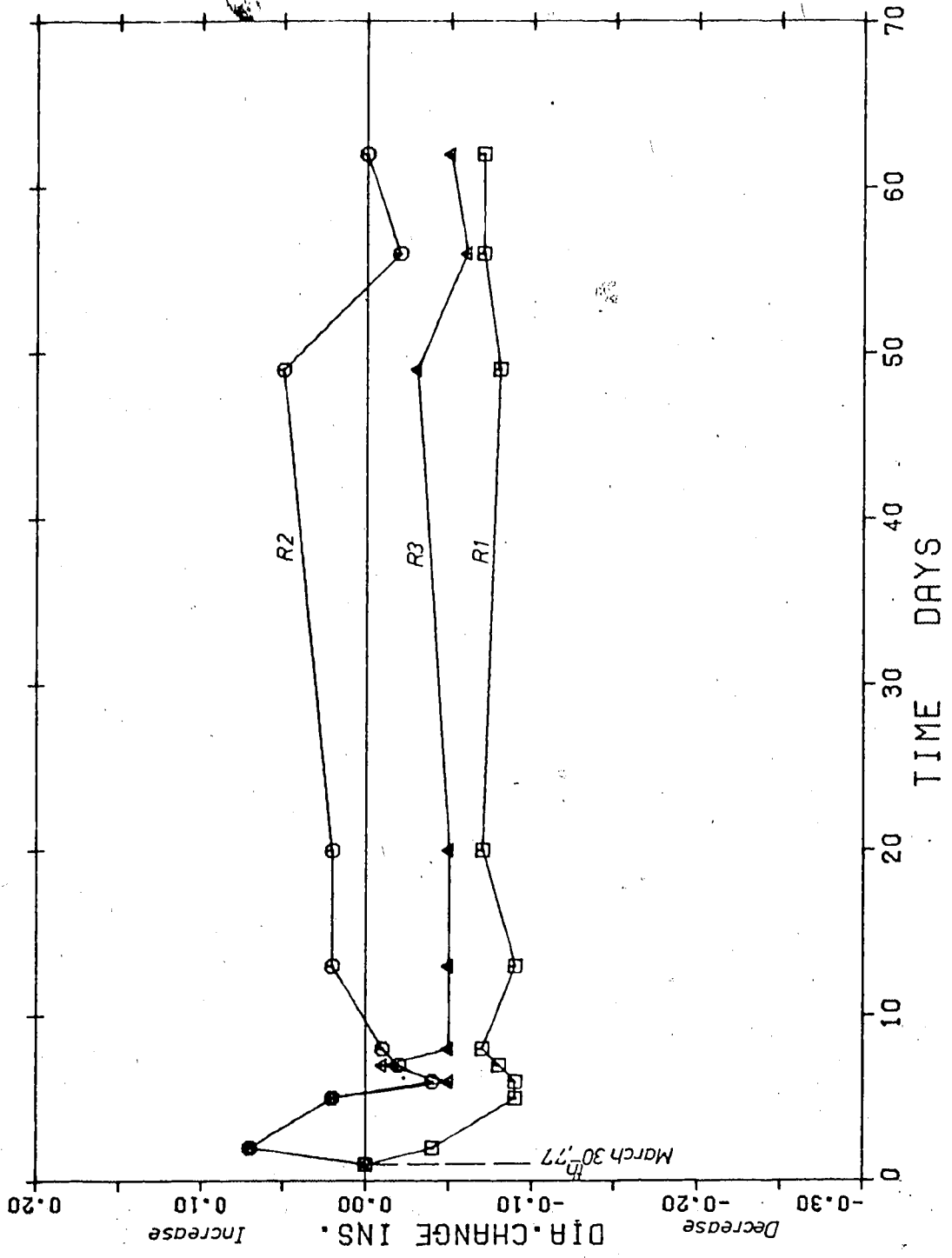

FIGURE 3.16 CHANGE IN VERTICAL DIAMETER

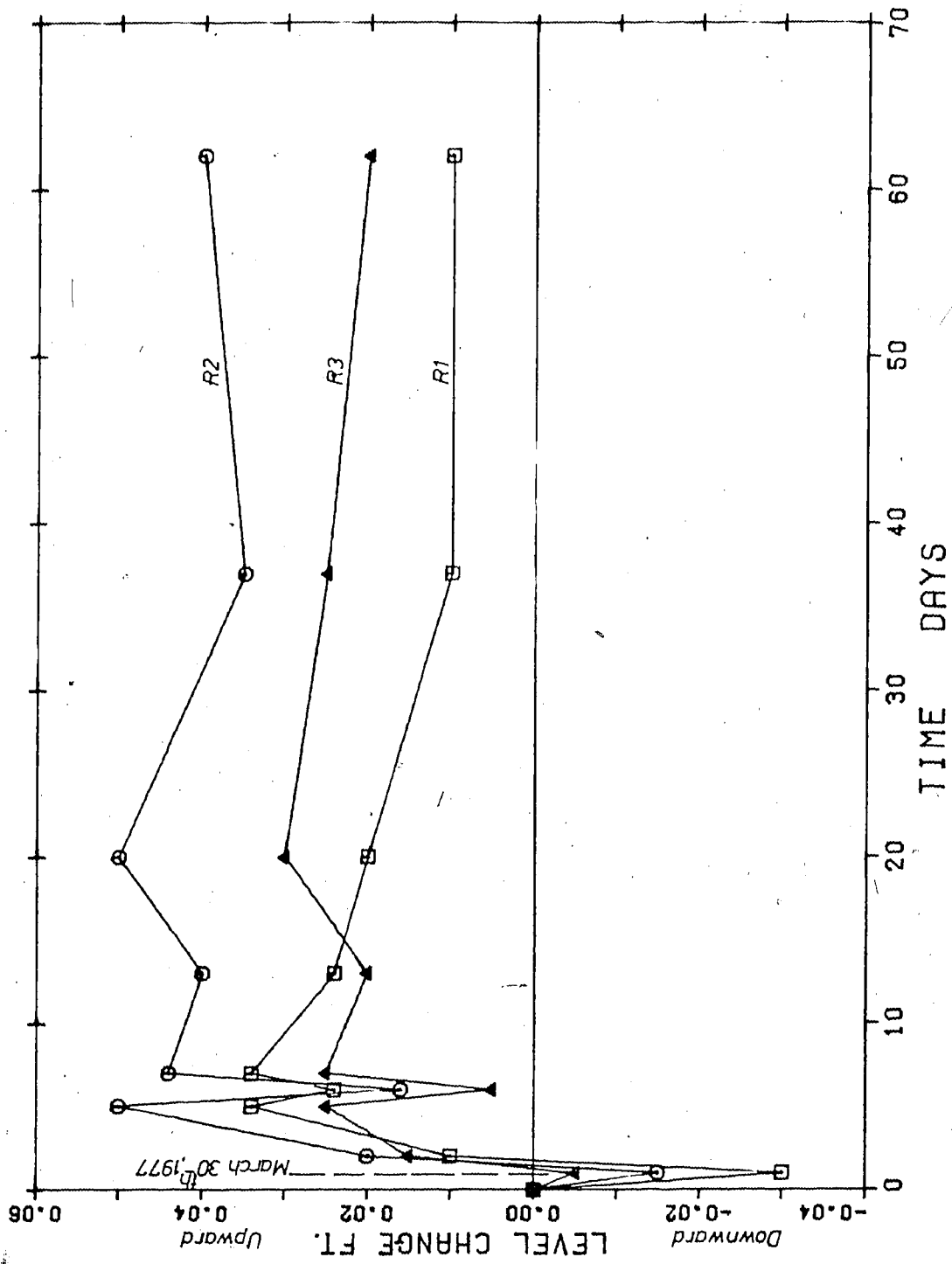

FIGURE 3.17 CHANGE IN INVERT LEVEL

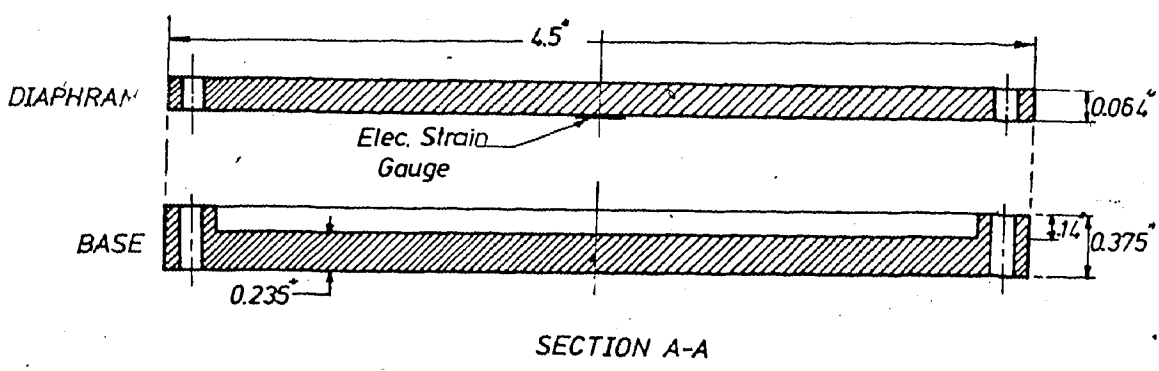
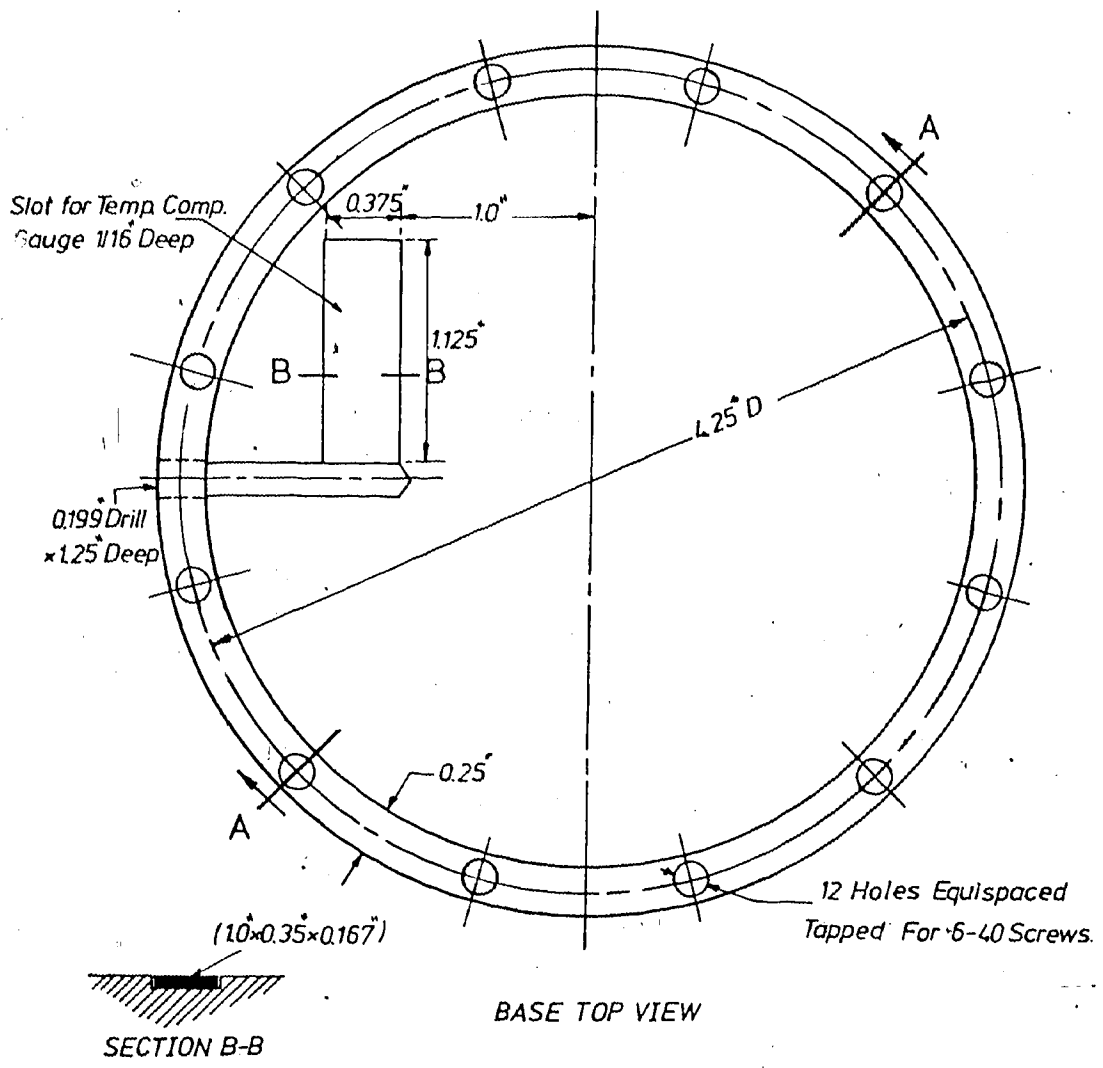

Figure 3.18 Details of a Pressure-cell.

pressure distribution on the lagging, acting as a beam on elastic supports, showed that the calculated pressure on points at one third of the span will be equal to the average pressure acting on the lagging. Thus, the pressure-cells were placed at this location. The laggings which were provided with pressure-cells were shortened by 1 inch to avoid the effect of the advancement jacking on the pressure-cells.

The pressure-cell measurements are given in Figure 3.19. The maximum pressure recorded at the spring-line (P.C. A) was about 5% of the overburden pressure at this level. However, the pressure-cell which was placed at the invert (P.C. B) recorded a lower value. On the other hand, the maximum deflection of the lagging at the spring-line was 0.1 inch. Six inches of water and oil at the tunnel invert caused the discontinuation of lagging deflection measurements at the tunnel invert.

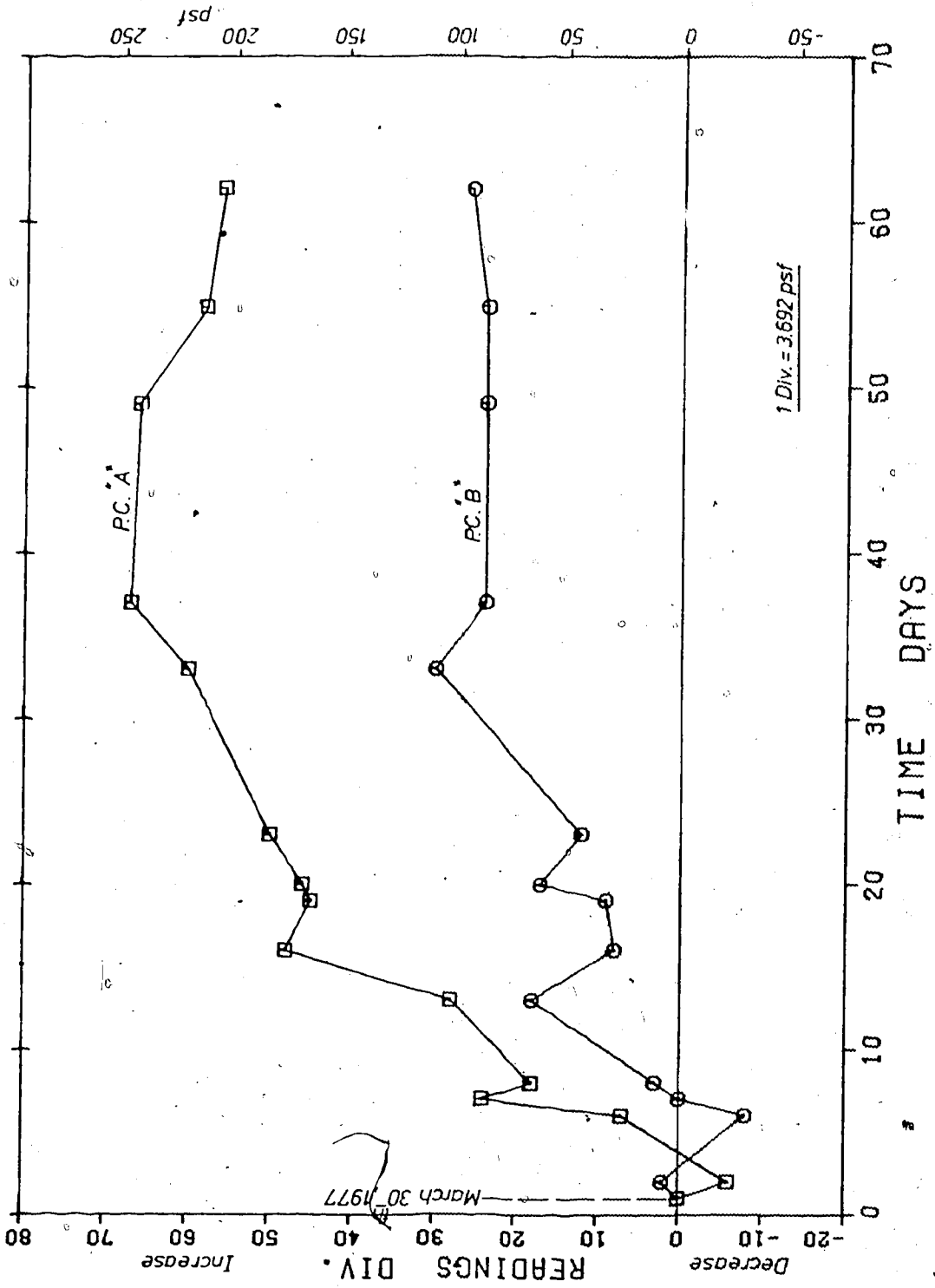

FIGURE 3.19 MEASUREMENTS OF THE PRESSURE-CELLS

## EVALUATION OF THE FIELD MEASUREMENTS

1 Introduction

The need for tunnel experimentation and reliable field measurements has been recognized as shown in Chapter I. However, the value of these records is limited by their detailed interpretation and analysis. The evaluation of the records should correlate these measurements with the ground condition and construction details, and with similar field experiments and existing hypothesis.

A comparison of measurements and analytical results or the use of field measurements in an empirical evaluation will verify the analytical methods or extend the use of the empirical evaluation for tunnels having similar construction procedures and subsurface conditions.

This Chapter contains the evaluation of the measurement records of the Whitemud-Creek and the 170th Street Tunnels.

The finite element method was used to analyze the ground deformation around an unlined tunnel, and the displacement of lining using different finite element meshes. Consequently, the deformed shapes of the ribs in the Whitemud-Creek Tunnel (two weeks after their installation (Feb. 2nd, 1977) and before placing the secondary concrete lining (June 1st, 1977)) were used as displacement boundary

conditions to calculate the corresponding stresses in the steel ribs.

Ground surface movement measurements of the 170th Street Tunnel are compared with empirical values and the anticipated trend. The test section measurements in this tunnel are interpreted and discussed in this Chapter.

#### 4.2 Evaluation of the Measurements in the Whitemud-Creek Tunnel:

##### 4.2.1 Deformation of the Ribs

The instrument used for these measurements, which is shown in Figure 3.2, incorporates a dial gauge reading to 0.001". A fluctuation of  $\pm 0.01"$  was noticeable during the initial readings, but no improvements on the instrument were needed since this was sufficiently accurate for the ensuing analysis. However, the average of three readings was recorded for each measurement to minimize the effect of this fluctuation.

The measurements this tunnel, given in Figures 3.3 to 3.8, showed a general consistency in the trend of the changes of the three ribs for each diameter or chord. In most cases, the average change in the three ribs was considered. However, the change in the horizontal diameter of Rib 2 was excluded because of its inconsistency with the change in the other two ribs. This was probably due to loosening of the eye-bolt. Figure 4.1 shows the average

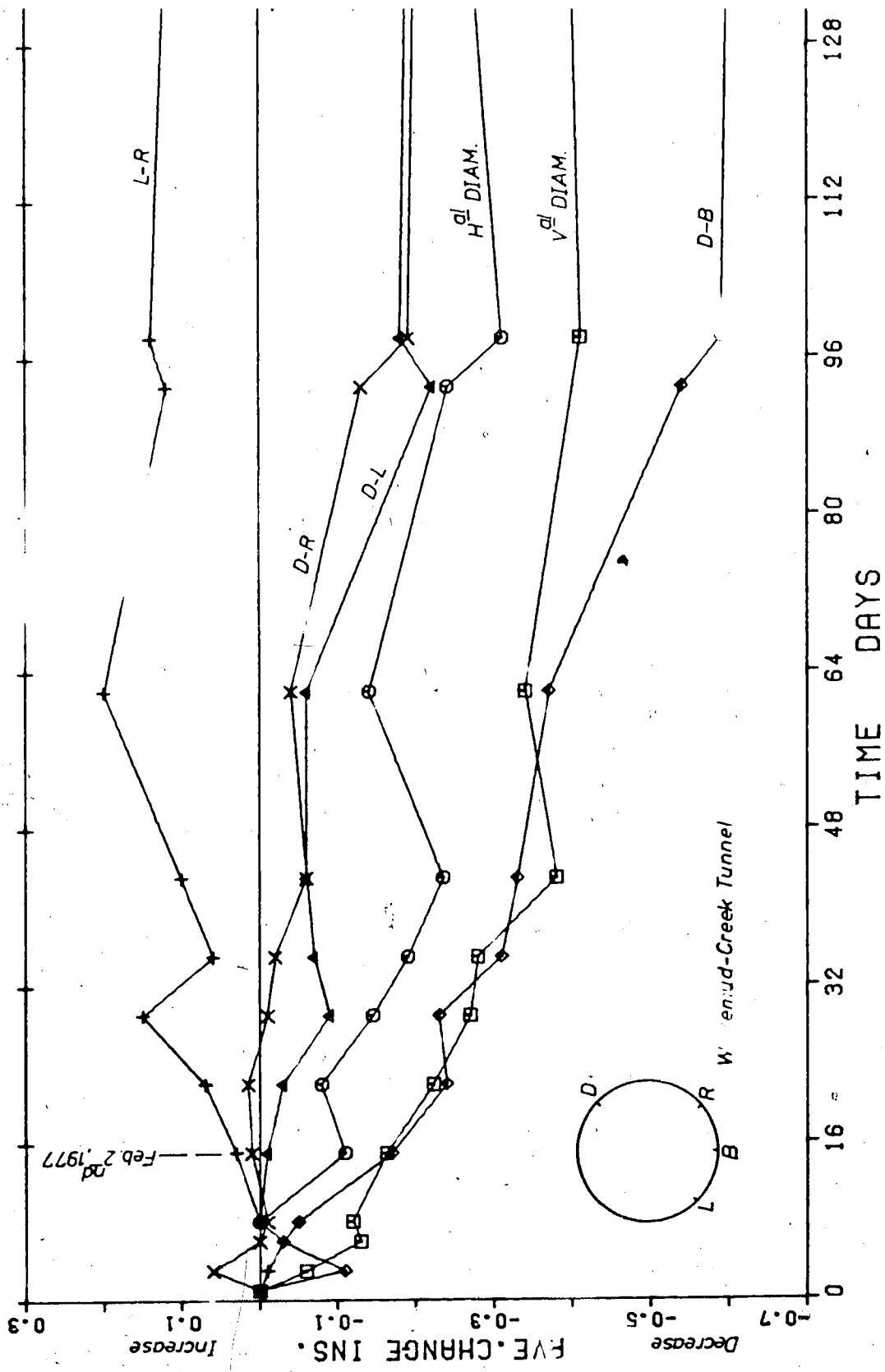

FIGURE 4.1 AVE. DIAMETER AND CHORD CHANGES



ribs. The difference between the average values and the observed measurements of the three ribs shows the effect of manually placing and wedging the lagging outside the ribs.

The vertical movement of points R, L and B, (see Figure 3.1) was recorded by leveling relative to a datum point 74 feet east of Rib 1. It was found that the analytical modification of these measurements to include the level change of this datum with time is the most reliable method since using a remote datum would require impractically long surveying with larger error.

Using the average diameter and chord changes shown in Figure 4.1 and the average level changes shown in Figure 3.9, the deformed shape of the ribs could be drawn for different dates as shown in Figure 4.2.

After two weeks (Feb. 2nd), a heave movement of the ribs and a very small contraction of the rib diameters were observed. This could be attributed to the unloading rebound of the clay-shale mass at the invert. However, there was no distinct indication that the interaction between the ribs and the surrounding ground had started. This delay in the soil-rib interaction could be attributed to the overlapping lagging system used in this tunnel which allows radial yield in the free ground over the distance between the ribs (see Figure 2.4). Such an interpretation can be supported by comparing the diameter changes of Garrison-Darrell tunnels given

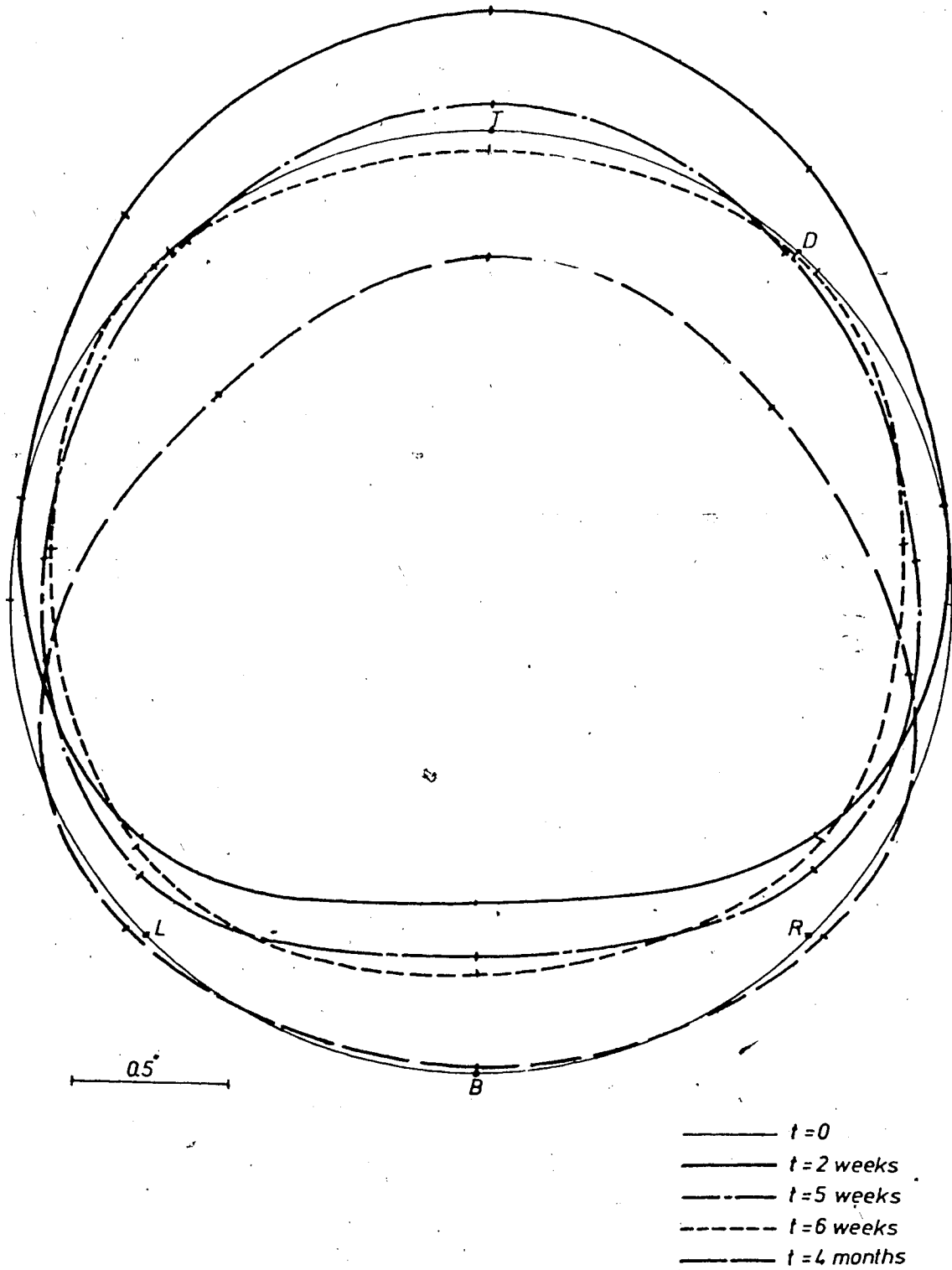

Figure 4.2 Deformed Shapes of the Ribs.

by Burke (1957). He presented the field measurements of diameter changes in different test sections of these tunnels where the ground yield was allowed in some sections and restricted in the others.

The unexpected upward rib movement at the crown is probably due to ground loosening in response to the immediate unloading at the crown before the ribs were placed. Field observations and measurements given by Matheson (1970), Hansmire and Cording (1972) and Lo and Morton (1976) showed this immediate response at the crown which resulted in loosening or local failures at the tunnel roofs. As a result, only the relatively delayed unloading rebound at the invert had affected rib movement and the loosening of the ground at the crown enabled the upward movement at the ribs at the crown.

During the following three weeks, downward movement of the ribs was reported with a pronounced decrease in the diameters and chords indicating the start of interaction and load transfer to the ribs.

Another heave displacement was recorded for points R and L during the fifth week, and for point B during the sixth week which was accompanied by a slight release in the diameter deformation. This behaviour was probably due to stress redistribution in the clay-shale mass around the lining as a result of the interaction.

The deformation of the ribs reached an equilibrium state after about three months (April 1977). All the measurements showed contraction, with a maximum of 0.6 inches occurring in chord D-B. However, an expansion of less than 0.12 inches was recorded for chord R-L.

In general, the measurements in this tunnel showed that the displacement of the primary lining was comprised of two components:

Firstly, a rigid body translation which is either heave, due to the relatively delayed unloading response of the invert and the redistribution of stresses in the ground around the tunnel, or settlement due to load-transfer to the ribs at the crown.

Secondly, deformation of the ribs, mostly contraction in diameters, due to their interaction with the surrounding ground.

#### 4.2.2 In-situ Pressuremeter Tests

There is an accumulated experience for determining the properties of natural soils in Edmonton, and Western Canada in general (De Jong 1971; Eisenstein and Morrison 1973; Burgess and Eisenstein 1977). These studies showed that the in-situ pressuremeter test could be used successfully to measure the modulus of instantaneous deformation. Reasonable agreement between the results of analyses using

this modulus and deformation field measurements were reported while the use of a laboratory determined moduli overestimated these deformations by at least ten times.

For tunnels, Hudson and Stephen (1975) discussed the importance of using in-situ tests for determining Young's Modulus. They showed that for the chalk mass at Chinnor, the in-situ stiffness was less than 10% of that obtained from laboratory tests on intact samples. The estimate of the large scale moduli of any bedded rock in two principal directions before making a large scale analysis was suggested by Ladanyi (1977) in order to obtain realistic results.

The results of the pressuremeter tests in the Whitemud-Creek Tunnel are given in Figure 4.3. The moduli obtained by the pressuremeter in the horizontal direction, two weeks after placing the primary lining, tend to decrease near the tunnel surface. This could explain the difference between the theoretical and observed movements around tunnels reported by Judd and Perloff (1971). This shows also that even for intact soft-rocks such as clay-shale a drop in the stiffness around the tunnel walls is expected.

On the other hand, it is interesting to compare the values of the modulus (Figure 4.3) with the highest laboratory modulus of 14.8 Ksi reported by DeJong and Morgenstern (1973). This difference shows the effect of sampling disturbance and the importance of in-situ testing.

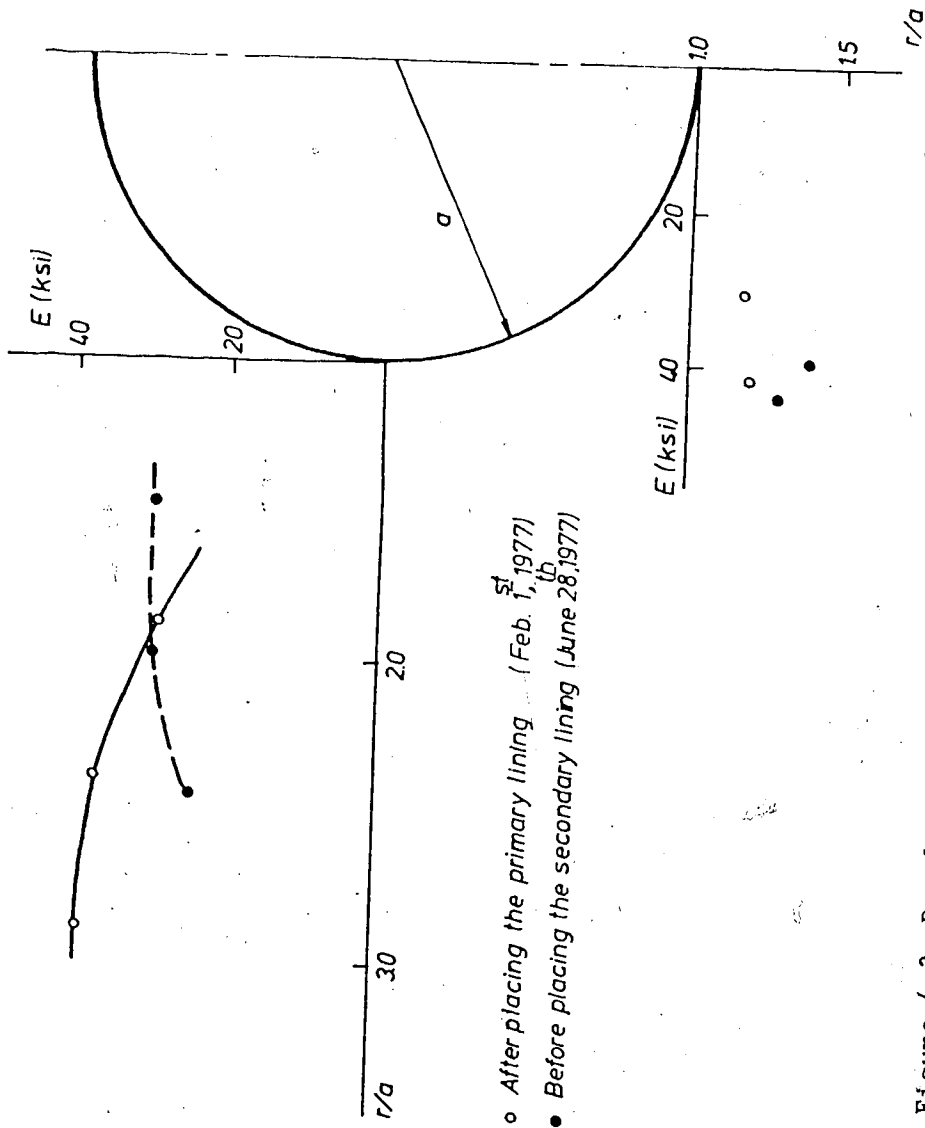

Figure 4.3 Results of the In-situ Pressuremeter Tests in the Whitemud-Creek Tunnel.

The average of the moduli had dropped from 35 Ksi for the first set of horizontal tests to 28 Ksi for the second set. The second set of tests showed a rather constant value of the modulus near the tunnel.

In the vertical direction, the average of the first set of tests was 36 Ksi which increased to 41.5 Ksi during the second set of tests. Only five feet below the tunnel invert could be tested since a layer of hard sandstone prevented drilling to deeper depths.

The average values of moduli in the first set of tests, 35 Ksi in horizontal direction and 36 Ksi in the vertical, shows almost equal values. However, the difference between these values became more pronounced in the second set of tests.

The change in the modulus around the tunnel during the period between the two sets of testing is due to the time-dependent behaviour of the clay-shale and the corresponding stress redistribution.

#### 4.2.3 Finite Element Analyses

Using the finite element method, the effects of softening zone and  $K_0$  on the deformation around unlined tunnel were studied. Also, deformations of the lining idealized by three different meshes were compared. Subsequently, stresses in the primary lining were analyzed

using the deformed shapes of the ribs as displacement boundary conditions.

Constant strain triangle elements with plane strain linear elastic model were used for the analysis. The number of elements was increased to allow modeling of the linear stress field in the ribs and the stress concentration in the surrounding ground.

a) Deformation around Unlined Tunnel

Two methods of excavation simulation were tried, turn on gravity before and after excavation and stress reversal approach (Judd and Perloff 1971; Kulhawy 1974). The results of the two methods were identical when  $K_0 = \nu / (1 - \nu)$  (where  $\nu$ : Poisson's Ratio). Stress reversal approach was used for the rest of the analyses in this section.

Figure 4.4 shows the calculated deformation of the ground around an excavated unlined tunnel for  $K_0 = 0.67$  and 1.0. It shows also, the effect of softening of a ring 40 ft. (O.D.) having a deformation modulus 50% of the clay-shale modulus.

From these results, it could be concluded that the effect of softening near the tunnel on the displacement of the ground due to excavation has the same importance, and is possibly more important than the effect of varying  $K_0$  from 0.67 to 1.0.



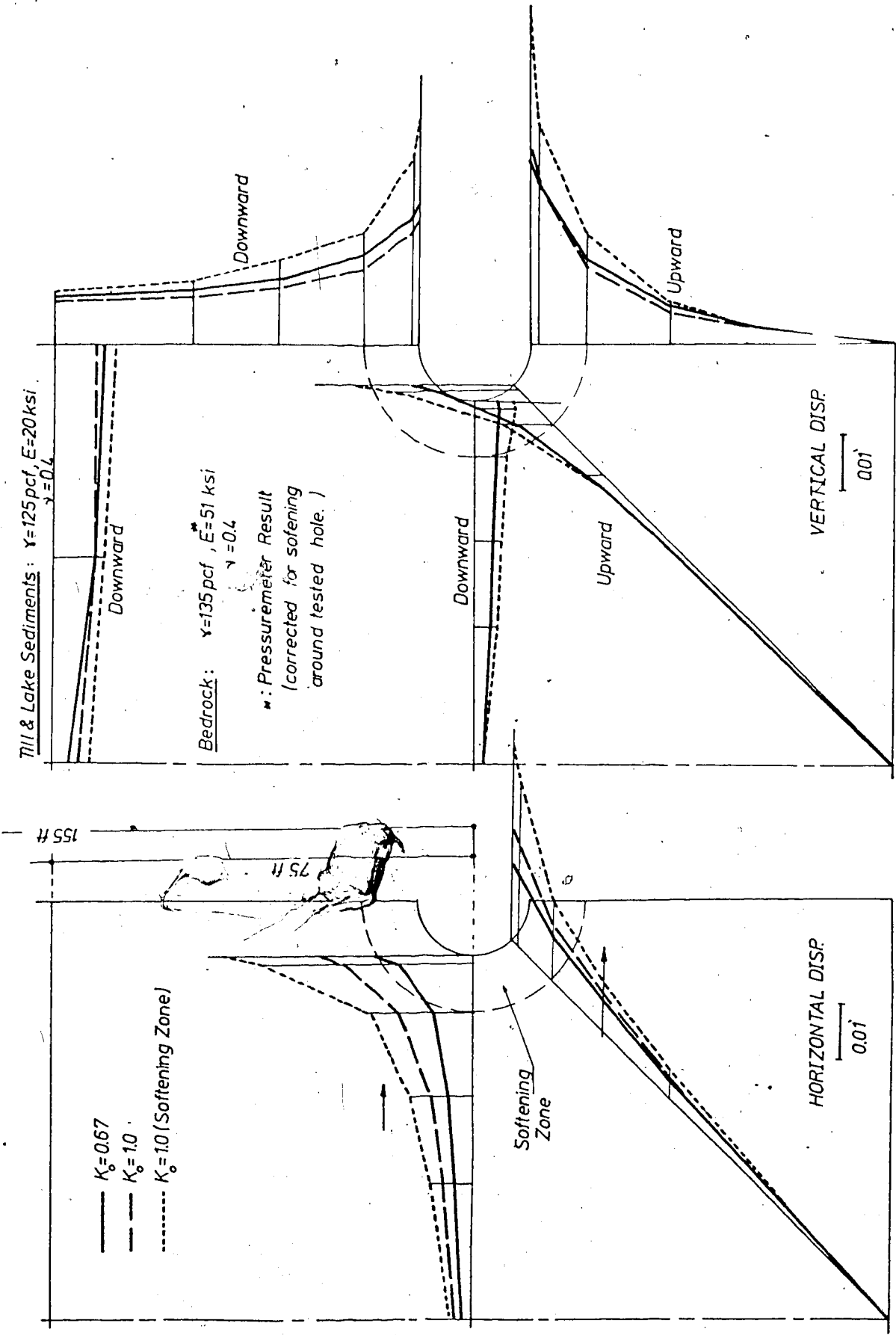

Figure 4.4 Ground Deformation around Unlined Tunnel.

b) Deformation of the lining

Three finite element models were used to examine the convergence of displacement due to a set of nodal loads. The number of elements was varied in both the radial and tangential directions. As shown in Figure 4.5, mesh No. 3 shows reasonable convergence to model the ring curvature and the linear stress field in the lining. This mesh was used to model the lining in the interaction problem.

c) Stresses in the Lining Using Field Measurements

The finite element mesh shown in Figure 4.6 was used to calculate the stresses in the primary lining due to deformation and movement of the ribs. It was recognized that while the actual problem is of a three dimensional nature, it could be approximated by a plane strain condition for the ground elements and plane stress for the lining. The finite element mesh consisted of 244 nodal points and 422 elements. About 45% of these elements were used to model the lining. The measured deformed shape of the ribs was used as a displacement boundary condition to calculate the stresses in the lining.

Figure 4.7 shows the calculated stresses in the ribs two weeks after their placement. The sections examined showed a maximum tangential compressive stress of 9.667 Ksi. The results also showed higher stress values at the bottom segment while stresses in the other segments were very low,

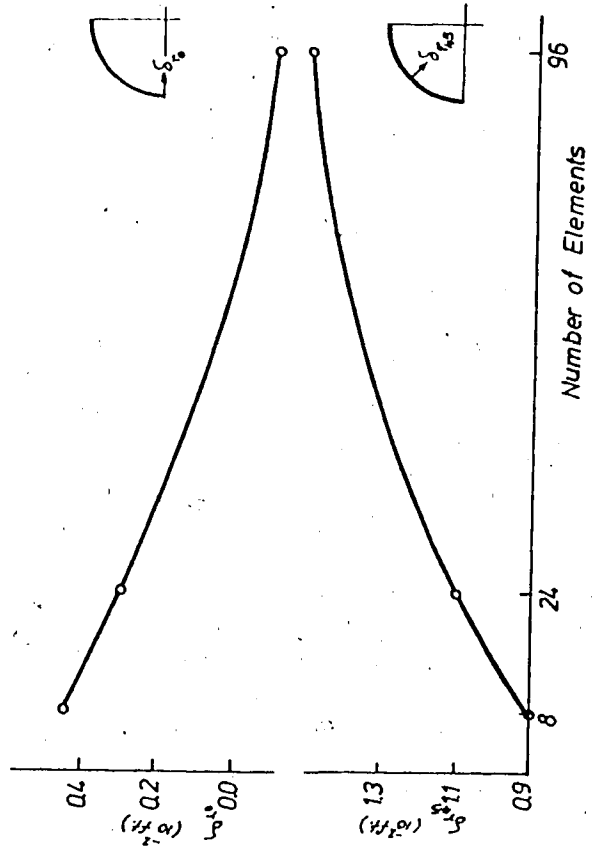
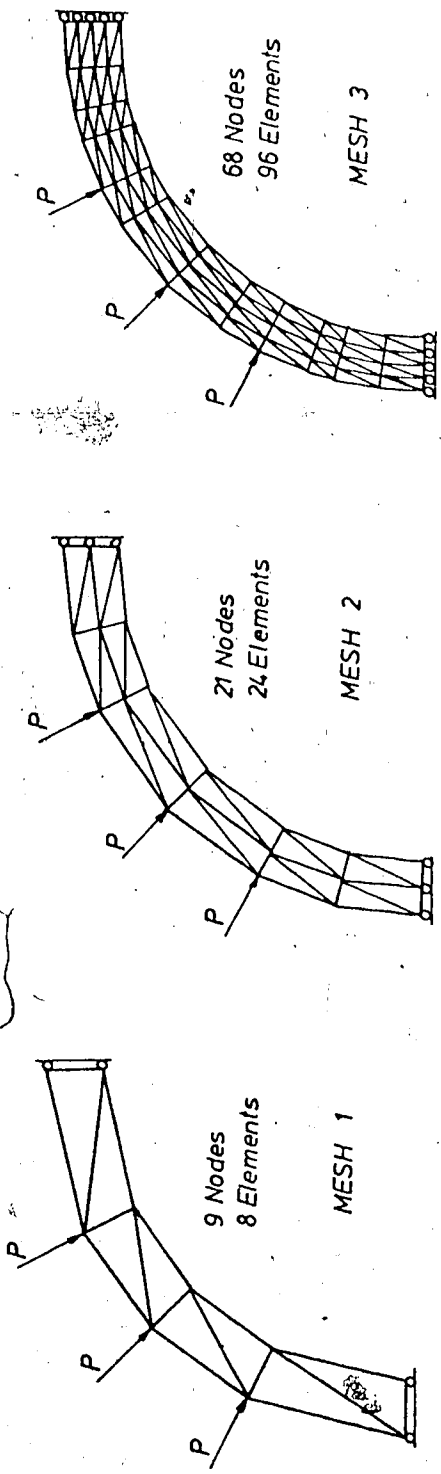

Figure 4.5 Calculated Deformation of the Lining.

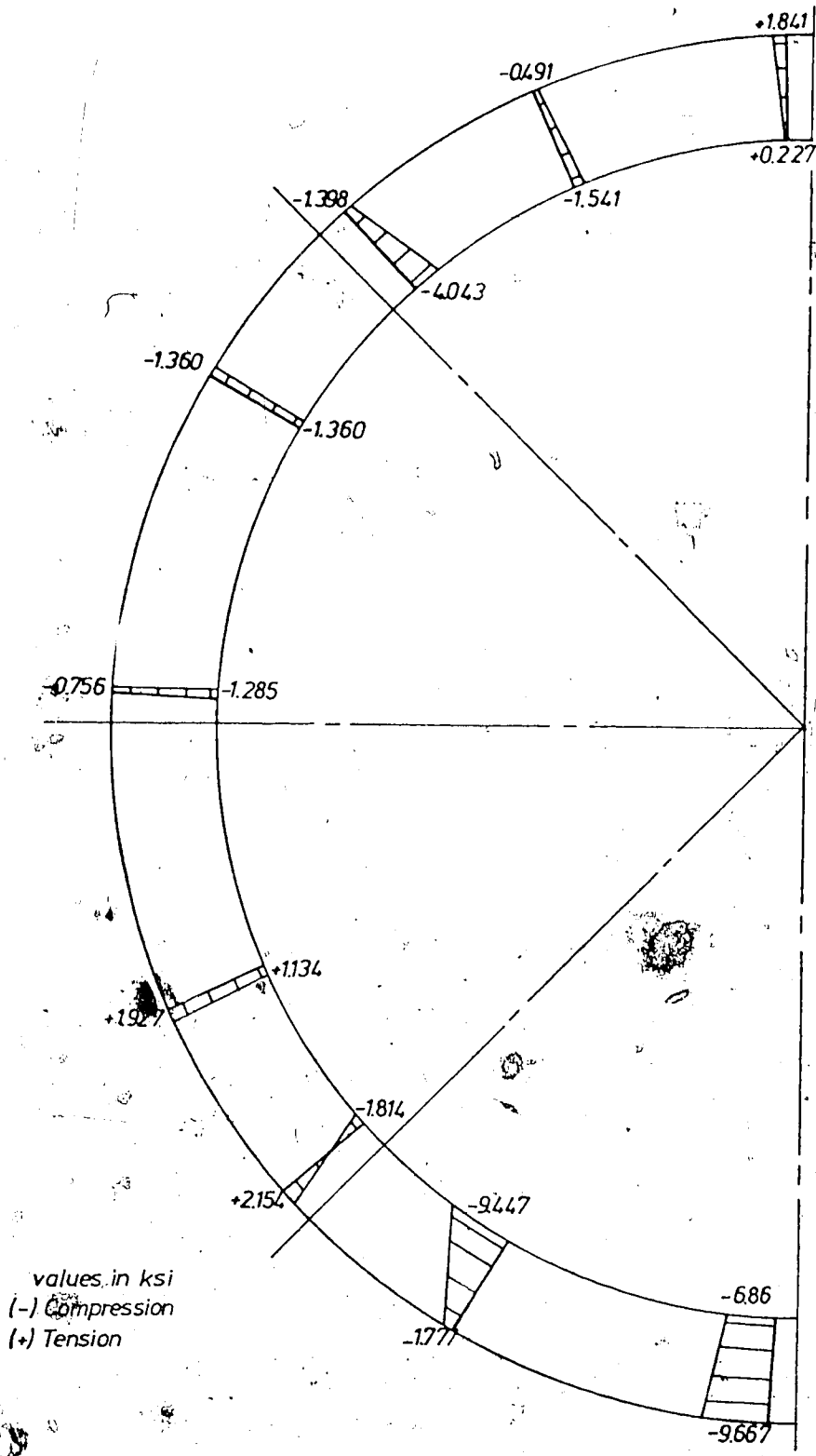

Figure 4.7 Calculated Stresses in the Ribs Using the Finite Element Method. (Feb. 2nd, 1977)

For this kind of analysis, using the field measurements as displacement boundary conditions, the softening of the clay-shale around the tunnel resulted in a very small change in the lining stresses. However, this change is expected to be more pronounced if stress reversal simulation (Kulhawy, 1974) was used. It should be noted that the measured movements of the ribs include the effect of this softening zone internally.

Figure 4.8 shows the calculated stresses in the ribs on June 1st, 1977. The stresses in the bottom segment had dropped, while a substantial increase in compressive stresses were reported in the other segments. The maximum compressive stress in these sections was 16.63 Ksi, which is about 33% of the yield stress (assuming,  $f_y=50$  Ksi). This maximum stress represents only 20% of those corresponding to all-around radial overburden pressure on the lining.

These relatively low stresses are the result of deformation of the ground mass near the tunnel face during excavation and the ground yield occurring due to the use of the overlapping lagging system.

In the Rapid Transit tunnels in Edmonton, higher stresses in the ribs were reported (Kulak, 1977) which correspond to an all-around radial pressure of about 80% of the overburden stress. This difference is probably due to

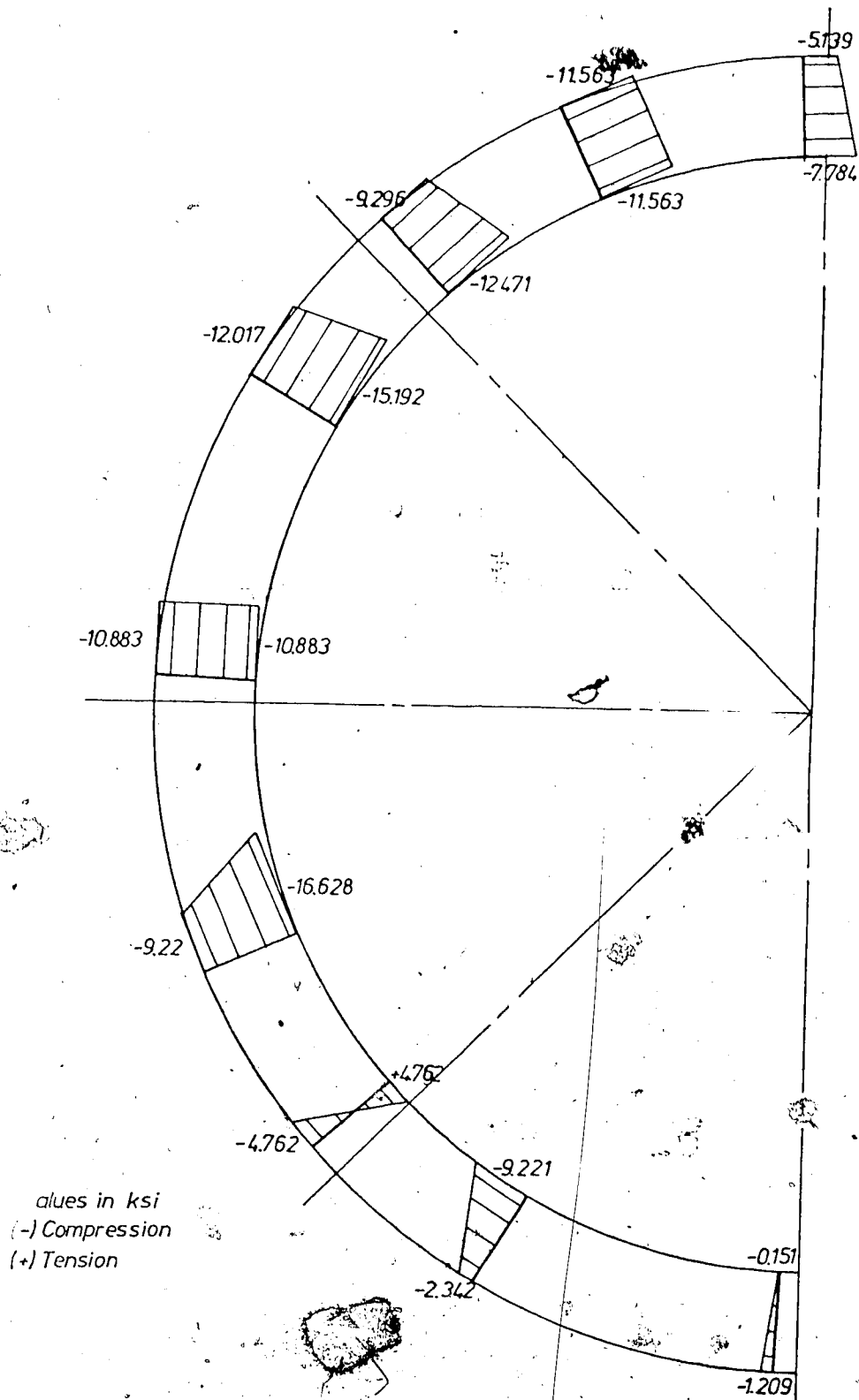

Figure 4.8 Calculated Stresses in the Ribs Using the Finite Element Method (June 1st, 1977)

the different lining jacking systems. The systems used in the Rapid Transit tunnels (Eisenstien and Thomson, 1977) eliminate the space outside the lining allowing only very small yield of the till. On the other hand, the higher strength of the clay-shale is a main factor in this difference.

#### 4.3 Evaluation of the Measurements in the 170th Street Tunnel

##### 4.3.1 Ground Surface Movements

Ground surface movements were recorded, as shown in the previous chapter, while the mole was approaching, passing under and passing beyond the settlement points located at the intersection of 170th Street and 62nd Avenue. Using the records given in Figure 3.14, the maximum settlement of the ground surface due to tunneling on March 16th was drawn as shown in Figure 4.9.

For this tunnel (see Figure 4.9)

$$z=70 \text{ ft.} \quad R=4.17 \text{ ft.} \quad z/zR=8.4$$

From the chart given by Peck (1969-b) -page 242

$$i/r=3.5 \quad i=20.43 \text{ ft}$$

where  $i$ =expected horizontal distance from the tunnel centre-line to point of the maximum curvature on settlement trough.

Assuming that the volume of the settlement trough as 4% of the volume of the excavated tunnel, the ground surface settlement profile was estimated using the probability

Comparing the ground surface movement measurements with the expected and estimated movements, the following was noted:

While the maximum settlement was expected to occur above the centre-line of the tunnel when the mole was passing under the settlement points, the measurements showed a shift of this maximum settlement about 30 feet to the west (see Figure 4.9) which was recorded when the mole had 75 feet to go before reaching a section under the surface points. This was followed by a sudden heave and a gradual small settlement.

The shift of the maximum settlement location to the west was probably due to the effect of compacted ground under 170th Street on ground movement near the surface. Similar ground heave movement when the mole was approaching the settlement points was reported for the Edmonton Rapid Transit tunnels (Eisenstein and Thomson, 1977), where the ground conditions and construction method were similar. However, the rapid rate of boring (av. 90ft/day) and the greater depth of the 170th Street Tunnel could be the reasons for the early occurrence of the maximum settlement. The greater depth of this tunnel increased the zone around the tunnel face affected by stress change. The rapid advance of the mole resulted in the incompressible behaviour of this zone. Bartlett and Bubbers (1970) suggested a model for the



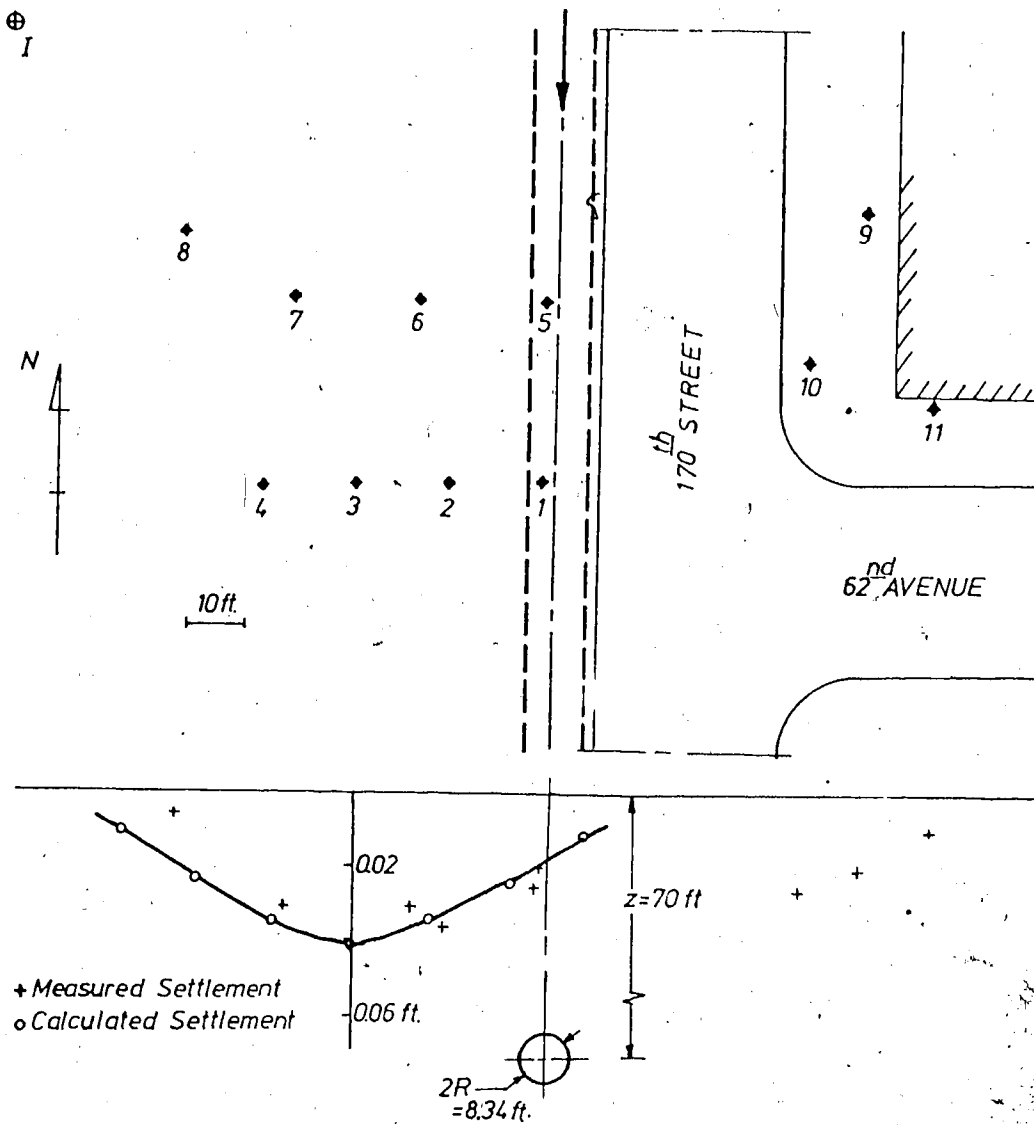

Figure 4.9 Measured and Calculated Settlement Profile above the 170th Street Tunnel.

ground movement pattern ahead of a tunnel shield in an incompressible material.

#### 4.3.2 The 170th Street Tunnel Test Section

Different measurements were tried in this test section. The details are given in the previous chapter.

The general trend of the invert movement was faster but similar to that recorded for the Whitemud-Creek Tunnel. The equilibrium state of the deformation measurements was reached in less than a month with an average contraction in the horizontal and vertical diameters of 0.3 and 0.05 inches respectively.

The low values measured by the pressure cells, 5% of the overburden pressure, could be attributed to the radial of the excavated till to fill the space outside the lining. The higher values of pressure at the spring-line explains the larger contraction in the horizontal diameters.

The measurements recorded for the lagging deflection did not give a sufficient basis for establishing a relationship between the pressure-cells and the lagging deflection.

CHAPTER V  
CONCLUSIONS AND RECOMMENDATIONS FOR  
FURTHER STUDIES

5.1 Conclusions

Field measurements are of great value to show the behaviour of full scale tunnels and to verify the analytical methods; or to be used in an empirical evaluation when analytical methods are unreliable.

From the evaluation of the field measurements in the Whitemud-Creek and 170th Street Tunnels the following are concluded:

1. The movement of the primary lining in these tunnels was comprised of two components:

Firstly, a rigid body translation which is either heave, due to the relatively delayed unloading response of the invert and the redistribution of stresses in the ground around the tunnel, or settlement due to load-transfer to the ribs at the crown.

Secondly, deformation of the ribs, mostly contraction in diameters, due to their interaction with the surrounding ground.

2. The instantaneous nature of the displacement and the loosening of the ground at the crown of the Whitemud-Creek Tunnel, near the tunnel face prior to the installation of a

new ribs, are postulated to be the cause of the pure rigid body heave of the ribs without any significant deformation during the first two weeks after its placement.

3. A pronounced decrease of the ground stiffness near the tunnel wall after excavation could be attributed to the concentration of tangential stresses accompanied by relief in the radial stresses due to unloading by excavation. The results of a finite element analysis showed that neglecting the effect of this softening will underestimate the ground deformation around the tunnel. Such effect is more pronounced than that due to changing  $K_0$  from 0.67 to 1.0

4. In-situ pressuremeter tests two weeks after excavation showed similar average values of the mass deformation moduli in the horizontal and vertical directions. On the other hand, the results of the second set of tests, performed before placing the secondary concrete lining, showed that the deformation modulus of the ground near the tunnel is time-dependent.

5. Finite element analysis, using the deformed shape of the ribs as a displacement boundary condition, showed that the maximum compressive stress in the ribs four months after placing is 16.63 Ksi. This is 33% of the yield stress or 20% of rib stresses due to an assumed all-around radial pressure equal to the overburden pressure at the tunnel spring-line. This agrees with the remarks given by Peck (1975) that the evaluation of the lining stresses considering the lining

embedded inside the ground before excavation is unrealistic due to the ground deformation occurring at the tunnel head and before the primary lining is installed.

6. From different measurements used in the two tunnels, deformation of the ribs is the most reliable field measurement to study the behaviour of primary lining while the in-situ pressuremeter test enabled examination of the behaviour of the surrounding ground.

7. From the measurements of the ground surface movement above the 170th Street Tunnel, it was concluded that the stress changes ahead of a rapidly advancing deep tunnel in glacial till may result in the early occurrence of the maximum settlement of the ground surface followed by a heave movement when the mole reaches under the settlement points. Time-dependent deformations and those due to ground movement into the annular overcutting space will result in a gradual small settlement.

8. The maximum ground surface settlement due to boring a tunnel in soil conditions and using construction procedures similar to those of the 170th Street Tunnel can be estimated by assuming that the volume of the settlement trough is 4% of the tunnel volume and approximating the trough by the probability function. However, shifting of the maximum settlement due to some surface conditions, such as a street or a building, may be expected.

## 5.2 Recommendations For Further Studies

1. The two tunnels studied in this thesis are relatively deep. Similar instrumentation programs for shallower tunnels in similar subsurface conditions and using the same construction procedures would be valuable.
2. The measurement records and the in-situ testing of the Whitemud-Creek Tunnel showed that the behaviour of surrounding clay-shale is time-dependent. On the other hand, the growing evidence of a softening zone around the tunnels and observations of large displacements at the tunnel crown showed the inelastic nature of this behaviour. These properties must be included in any analysis in order to get a satisfactory comparison between analytical results and tunnel field measurements.
3. Three dimensional analytical and model testing of the deformation behaviour around tunnel heading and the corresponding ground surface movement in these types of material is also recommended.
4. The relatively low stresses in the ribs and the small ground surface settlement reported in this study support, geotechnically, the economical need for studying lining techniques which allow continuous advancement of the mole and to replace the present primary and secondary lining.

## REFERENCES

- Abel, A. F. and Lee, P.T. (1973), "Stress changes ahead of an advancing tunnel," *Inter. Journal of Rock Mechanics and Mining Sciences*, Vol. 10, No. 6, pp. 673-697.
- Atkinson, J.H., Cairncross, A.M. and James, R.G. (1974), "Model tests on shallow tunnels in sand and clay", *Tunnels and Tunnelling*, Vol. 6, No. 3, pp. 28-32.
- Atkinson, J.H., Potts, D.M. and Schofield, A.N. (1977 a), "Centrifugal model tests on shallow tunnels in sand," *Tunnels and Tunnelling*, Vol. 9, No. 1, pp. 59-64.
- Atkinson, J.H. and Potts, D.M. (1977 b), "Subsidence above shallow tunnels in soft ground," *Journal of the Geotechnical Eng. Division, ASCE*, Vol. 103, No. GT4, pp. 307-325.
- Attewell, P.B. and Farmer, I.W. (1974), "Ground deformations resulting from shield tunneling in London Clay", *Canadian Geotechnical Journal*, Vol. 11, No. 3, pp. 380-395.
- Attewell, P.B. and Farmer, I.W. (1975), "Ground settlement above shield driven tunnels in clay", *Tunnels and Tunnelling*, Vol. 7, No. 1, pp. 58-62.
- Bartlett, J.V. and Bubbers, L. (1970), "Surface movements caused by bored tunnelling", *Proc. Conf. on Subway Construction, Budapest*, pp. 513-539
- Beaulieu, A.C. (1972), "Tunneling experiences, City of Edmonton, Alberta, Canada", *Proc. of the First North American Rapid Excavation and Tunneling Conf., AIME*, Vol. 2, pp. 933-964.
- Brown, C.F.P. and Hewson, F.I. (1976), "Rock squeeze at Thorold tunnel", *Canadian Geotechnical Journal*, Vol. 13, No. 2, pp. 111-126.
- Burgess, N. (1976), "The University of Alberta pressuremeter", M.Sc. Thesis, Dept. of Civil Eng., University of Alberta, Edmonton, Alberta.
- Burgess, N. and Eisenstein Z. (1977), "The application of pressuremeter test results in deformation analysis", *Canadian Geotechnical Journal*, Vol. 14, No. 1, pp. 64-75.
- Burke, H. (1957), "Garrison Dam tunnel test section investigation", *Journal of Soil Mechanics and Foundations Division, ASCE*, Vol. 83, pp. 1438.1-1438.50.

## REFERENCES

- Abel, A. F. and Lee, P.T. (1973), "Stress changes ahead of an advancing tunnel," *Inter. Journal of Rock Mechanics and Mining Sciences*, Vol. 10, No. 6, pp. 673-697.
- Atkinson, J.H., Cairncross, A.M. and James, R.G. (1974), "Model tests on shallow tunnels in sand and clay", *Tunnels and Tunnelling*, Vol. 6, No. 3, pp. 28-32.
- Atkinson, J.H., Potts, D.M. and Schofield, A.N. (1977 a), "Centrifugal model tests on shallow tunnels in sand," *Tunnels and Tunnelling*, Vol. 9, No. 1, pp. 59-64.
- Atkinson, J.H. and Potts, D.M. (1977 b), "Subsidence above shallow tunnels in soft ground," *Journal of the Geotechnical Eng. Division, ASCE*, Vol. 103, No. GT4, pp. 307-325.
- Attewell, P.B. and Farmer, I.W. (1974), "Ground deformations resulting from shield tunneling in London Clay", *Canadian Geotechnical Journal*, Vol. 11, No. 3, pp. 380-395.
- Attewell, P.B. and Farmer, I.W. (1975), "Ground settlement above shield driven tunnels in clay", *Tunnels and Tunnelling*, Vol. 7, No. 1, pp. 58-62.
- Bartlett, J.V. and Bubbers, L. (1970), "Surface movements caused by bored tunnelling", *Proc. Conf. on Subway Construction, Budapest*, pp. 513-539
- Beaulieu, A.C. (1972), "Tunneling experiences, City of Edmonton, Alberta, Canada", *Proc. of the First North American Rapid Excavation and Tunneling Conf., AIME*, Vol. 2, pp. 933-964.
- Brown, C.F.P. and Hewson, F.I. (1976), "Rock squeeze at Thorold tunnel", *Canadian Geotechnical Journal*, Vol. 13, No. 2, pp. 111-126.
- Burgess, N. (1976), "The University of Alberta pressuremeter", M.Sc. Thesis, Dept. of Civil Eng., University of Alberta, Edmonton, Alberta.
- Burgess, N. and Eisenstein Z. (1977), "The application of pressuremeter test results in deformation analysis", *Canadian Geotechnical Journal*, Vol. 14, No. 1, pp. 64-75.
- Burke, H. (1957), "Garrison Dam tunnel test section investigation", *Journal of Soil Mechanics and Foundations Division, ASCE*, Vol. 83, pp. 1438.1-1438.50.



- Butler, R.A. and Hampton, D. (1975), "Subsidence over soft ground tunnel," Journal of the Geotechnical Engineering Division, ASCE, Vol. 101, No. GT1, pp. 35-49.
- Cording, E.S. (1975), "Measurement of Displacements in Tunnels", Proc. of the 2nd. Inter. Cong. of the Inter. Association of Engineering Geology, Vol. 1, V11-PC-3.
- De Jong, J. (1971), "Foundation displacements of multistory structures," Ph.D. Thesis Dept. of Civil Eng., University of Alberta, Edmonton, Alberta.
- De Jong, J. and Morgenstern, N. R. (1973), "Heave and settlement of two tall building foundations in Edmonton, Alberta", Canadian Geotechnical Journal, Vol. 10, No. 2, pp. 261-281.
- Desai, C.S. (1971), "Applications of the finite element method in geotechnical engineering", Proc. of the symposium held at Vicksburg, Mississippi.
- Desai, C.S. and Abel, J.F. (1972), "Introduction to the Finite element method", Van Nostrand Reinhold Co., New York.
- Eigenbrod, K.D. and Morgenstern, N.R. (1972), "A slide in Cretaceous bedrock, Devon, Alberta", Geotechnical Practice for stability in Open Pit Mining, C.O. Brawner and V. Milligan, pp. 223-238.
- Eisenstein, Z. and Morrison, N.A. (1973), "Prediction of foundation deformations in Edmonton using an in-situ pressure probe", Canadian Geotechnical Journal, Vol. 10, No. 2, pp. 193-210.
- Eisenstein, Z. and Thomson, S. (1977), "Geotechnical performance of a tunnel in till", Proc. of 30th the Canadian Geotechnical Conf., Saskatoon, Saskatchewan.
- Emanuel, G. (1977), Personal Communication.
- Gibson, R.E. and Anderson, W.F. (1961), "In-situ measurement of soil properties with the pressuremeter", Civil Engineering and Public Works Review, London, Vol. 56, pp. 615-620.
- Hansmire, W.H. and Cording, E.J. (1972), "Performance of a soft ground tunnel on the Washington Metro", Proc. of the 1st North American Rapid Excavation and Tunneling Conf., Vol. 1, pp. 371-389.

- Hansmire, W.H. and Cording, E.J. (1976), "Discussion on Bulter and Hampton paper", Journal of the Geotechnical Engineering Divison, ASCE, Vol. 102, No. GT3, pp. 259-261.
- Heuer, R.E. (1976), "Catastrophic ground loss in soft ground tunnels", Proc. of the 3rd North American Rapid Excavation and Tunneling Conf., pp. 278-295.
- Hoyaux, B. and Ladanyi, B. (1970), "Gravitational stress field around a tunnel in soft ground", Canadian Geotechnical Journal, Vol. 7, No. 1, pp. 54-61.
- Hudson, J.A. and Priest, S. (1975), "Instrumentation and Monitoring" Tunnels and Tunnelling, Vol. 7, No. 5, pp. 64-70.
- Ju, W.R. and Perloff, W.H. (1971), "Predicted and measured displacements for tunnels", Symposium on Underground Rock Chambers, ASCE, pp. 487-514.
- Kathol, C.P. and MacPherson, R.A. (1975), "Urban geology of Edmonton", Alberta Research Council, Bulletin 32, Fig. 27.
- Kuesel, T.R. (1972), "Soft ground tunnels for Bart project", Proc. of the 1st. North American Rapid Excavation and Tunneling Conf., Vol. 1, pp. 287-313.
- Kulak, G. (1977), Personal Communication
- Kulhawy, F.H. (1974), "Finite element modeling criteria for underground openings in rock", Inter. Journal of Rock Mechanics and Mining Science, Vol. 11, pp. 465-472.
- Ladanyi, B. (1974), "Use of the long-term strength concept in the determination of ground pressure on tunnel linings", Proc. of the 3rd Inter. Cong. on Rock Mechanics, Vol. 2B, pp. 1150-1156.
- Ladanyi, B. (1977), "Tunnels in bedded rock with high horizontal stresses: Discussion", Canadian Geotechnical Journal, Vol. 14, No. 1, pp. 152-153.
- Lane, K.S. (1975), "Field test sections save cost in tunnel support", Report from Underground Construction Research Council, ASCE.
- Lo, K.Y. and Morton, J.D. (1976), "Tunnels in bedded rock with high horizontal stresses", Canadian Geotechnical Journal, Vol. 13, No. 3, pp. 216-230.

- Lombardi, G. (1973), "Dimensioning of tunnel linings - with regards to construction procedure", *Tunnels and Tunnelling*, Vol. 5, No. 4, pp. 340-351.
- Lombardi, G. (1974), "Rock mechanics problem at St. Golthard", In German, *Rock Mechanics*, Supplement No. 3, pp. 113-130.
- Mathis, C. (1974), "Tunnel design in the City of Edmonton", M.Sc. Thesis, Dept. of Civil Eng., University of Alberta, Edmonton, Alberta.
- Matheson, D.S. (1970), "A Tunnel roof failure in Till", *Technical Note, Canadian Geotechnical Journal*, Vol. 7, No. 3, pp. 313-317.
- Oster, R. T. (1975), "Construction of storm tunnel in Edmonton. A summary report", *Tunnels and Declines*, Report No. DS-75-9, Canada Centre for Mineral and Energy Technology, pp. 17-43.
- Pacher, F. (1964), "Measurements of deformation in a test gallery as a means of investigating the behaviour of the rock mass and of specifying lining requirements", *Rock Mechanics and Engineering Geology*, Supplement I, pp. 149-161.
- Peck, R. B. (1969 a), "Advantages and limitations of the observational method in applied soil mechanics", *Ninth Rankine Lecture, Geotechnique*, Vol. 19, No. 2, pp. 171-187.
- Peck, R.B. (1969 b), "Deep Excavations and Tunneling in soft ground", *State of-the-Art Report, Proc. of the 7th Inter. Conf. on Soil Mechanics and Foundations*, Vol. 3, pp. 311-376.
- Peck, R. B. (1975), "Lateral Pressures Related to Large Diameter Pipes, Piles, Tunnels and Caissons, Dayton Section of ASCE, Dayton, Ohio.
- Peck, R.B., Hendron, A.J. and Mohr, B. (1972), "State of-the-Art of soft ground tunneling", *Proc. of the 1st North American Rapid Excavation and Tunneling Conf.*, Vol. 1, pp. 259-286.
- Poulos, H.G. and Davis, E.H. (1974), "Elastic solutions for soil and rock mechanics", *John Wiley, New York.*
- Rabcevic, L.V. (1964), "The New Austrian Tunneling Method", *Water Power*, Vol. 16; pp. 453-457 and pp. 511-515, Vol. 17; pp. 19-24.

- Rabcewicz, L.V. and Golser, J. (1973), "Principles of dimensioning the supporting system for the New Austrian Tunnelling Method", *Water Power*, Vol. 25, pp. 88-93 and 235
- Rabcewicz, L.V. and Golser, J. (1974), "Application of the NATM to the Underground works at Tarbela", *Water Power*, Vol. 26, pp. 314-321 and pp. 330-335.
- Schmidt, B. (1969), "Settlement and ground movements associated with tunneling in Soil", Ph. D. Thesis, University of Illinois, Urbana.
- Szechy, K. (1966), "The art of tunnelling", Published by Akademiai Kiado, Budapest, 892 pp.
- Terzaghi, K. (1961), "Past and future of applied soil mechanics", *Journal of the Boston Society of Civil Engineers*, Vol. 68, pp. 110-139.
- Thomson, S. (1970), "Riverbank stability at the University of Alberta, Edmonton", *Canadian Geotechnical Journal*, Vol. 7, pp. 157-168.
- Thomson, S. (1971), "The Lesueur landslide, a failure in Upper Cretaceous clayshale", *Proc. of the Ninth Conf. on Engineering Geology and Soil Mechanics*, Boise, Idaho, pp. 257-287.
- Thomson, S. and Yacyshyn, R. (1977), "Slopes instability in the City of Edmonton", *Canadian Geotechnical Journal*, Vol. 14, No. 1, pp. 1-16.
- Tomlin, N. and Sklucky, T. (1977), "Ground deformation around a tunnel excavation in Bunter sandstone", *Proc. of a Conf. on Rock Engineering*, The University of Newcastle upon Tyne, England, pp. 623-640.
- Zienkiewicz, O.C. (1971), "The finite element method in Engineering science", McGraw-Hill, New York.