

27689

NATIONAL LIBRARY
OTTAWA



BIBLIOTHÈQUE NATIONALE
OTTAWA

NAME OF AUTHOR..... John J. LITTLE.....

TITLE OF THESIS... A Mathematical and Cognitive
analysis of Children's behavior
in spatial problems.....

UNIVERSITY..... ALBERTA.....

DEGREE FOR WHICH THESIS WAS PRESENTED..... Ph.D.....

YEAR THIS DEGREE GRANTED..... 1976.....

Permission is hereby granted to THE NATIONAL LIBRARY
OF CANADA to microfilm this thesis and to lend or sell copies
of the film.

The author reserves other publication rights, and
neither the thesis nor extensive extracts from it may be
printed or otherwise reproduced without the author's
written permission.

(Signed)..... J. J. Little.....

PERMANENT ADDRESS
9 Thompson St
Asmidale 2300
NSW AUSTRALIA

DATED..... February 13, 1976.....

INFORMATION TO USERS

THIS DISSERTATION HAS BEEN
MICROFILMED EXACTLY AS RECEIVED

This copy was produced from a microfiche copy of the original document. The quality of the copy is heavily dependent upon the quality of the original thesis submitted for microfilming. Every effort has been made to ensure the highest quality of reproduction possible.

PLEASE NOTE: Some pages may have indistinct print. Filmed as received.

Canadian Theses Division
Cataloguing Branch
National Library of Canada
Ottawa, Canada KIA 0N4

AVIS AUX USAGERS

LA THESE A ETE MICROFILMEE
TELLE QUE NOUS L'AVONS RECUE

Cette copie a été faite à partir d'une microfiche du document original. La qualité de la copie dépend grandement de la qualité de la thèse soumise pour le microfilmage. Nous avons tout fait pour assurer une qualité supérieure de reproduction.

NOTA BENE: La qualité d'impression de certaines pages peut laisser à désirer. Microfilmée telle que nous l'avons reçue.

Division des thèses canadiennes
Direction du catalogage
Bibliothèque nationale du Canada
Ottawa, Canada KIA 0N4

THE UNIVERSITY OF ALBERTA

A MATHEMATICAL AND COGNITIVE ANALYSIS OF CHILDREN'S
BEHAVIOR IN SPATIAL PROBLEMS

by

JOHN JEFFREY LITTLE



A THESIS

SUBMITTED TO THE FACULTY OF GRADUATE STUDIES AND RESEARCH
IN PARTIAL FULFILMENT OF THE REQUIREMENTS FOR THE DEGREE
OF DOCTOR OF PHILOSOPHY

DEPARTMENT OF ELEMENTARY EDUCATION

EDMONTON, ALBERTA

SPRING, 1976

THE UNIVERSITY OF ALBERTA
FACULTY OF GRADUATE STUDIES AND RESEARCH

The undersigned certify that they have read, and recommend to the Faculty of Graduate Studies and Research, for acceptance, a thesis entitled A Mathematical and Cognitive Analysis of Children's Behavior in Spatial Problems submitted by John Jeffrey Little in partial fulfilment of the requirements for the degree of Doctor of Philosophy.

R. D. Turner
.....
Supervisor

J. Stearns.....

K. A. Neufeld.....

Thomas E. Kiersey.....

Al R. Osborn
.....
External Examiner

Date *February 10, 1976*.....

ABSTRACT

Effective experiences which help guide children's exploration and discovery processes, and prepare them to solve problems connected with their physical environment are considered to be important components in the elementary school curriculum. Further knowledge, however, is needed on how young children behave in problem-solving situations of a mathematical nature, particularly in the area of spatial relations.

The purposes of this study were to collect the behaviors exhibited by a sample of children, aged 3 to 8 years, while they engaged in four problems involving spatial relationships, and to analyse and classify these behaviors. The problems were (i) the fold-out shapes, (ii) the projected shapes, (iii) the object reflections, and (iv) the mirror reflections problems.

The behaviors of the children as they solved these problems were recorded on half inch videotape. Sixty children were given problems (i) and (iii), 30 of whom were given the mathematically equivalent but physically different problems (ii) and (iv). Each child was interviewed individually and randomly allotted a set of problem situations which included from one to four spatial problems according to a predetermined schedule.

Each problem generated a wide range of behaviors in each age group. The behaviors observed included visual, motor activity, predictive, verifying, transforming, aiming, assembling and verbal behaviors. The problems had been devised to comply with a set of criteria for good problems, and it was found that almost all children readily sought solutions to them, using the materials which had been

constructed for these problems. Furthermore, it was found that children, when presented with a problem involving the manipulation of materials, wanted to make an immediate start on the problem, and resisted moves which did not take them directly to a solution.

Protocols provided for interviewer assistance when needed, and this took the form of visual and verbal feedback or cues. The level of solution to the problems was found to be a function of a child's perceptual exploration, motor activity and interpretation of available data. Also, when acquired knowledge was consistent with the requirements of the problem, children used this knowledge to solve new problems presented to them. Although it was observed that children's problem-solving procedures became more systematic as they gained experience, specific motor activities such as aligning the edges of components in an assembly were exhibited by all children, and notions of the projected straight line were displayed by children as young as three years.

Spontaneous verbalizations were generated by the problems and the materials. These took a functional form by which the children sought further information, monitored their actions, commented on the materials, adapted the problem to suit themselves, and indicated that the problem had been solved.

ACKNOWLEDGEMENTS

The author wishes to record his appreciation to all whose time and efforts have contributed to this study:

To Dr. L. D. Nelson, chairman of the supervisory committee, whose interest in children's problem solving inspired the research project, of which this study is a part;

To Dr. T. Kieren, Dr. J. Kirkpatrick, Dr. K. A. Neufeld, Dr. L. L. Stevin, and to Dr. A. R. Osborne, for their encouragement and comments;

To my colleagues and friends, staff and fellow graduate students in Canada and overseas, whose confidence and buoyant support helped to bring this study to completion;

To the staff of the Audiovisual Media Centre, University of Alberta, for photographs of the Projected Shapes Problem, the Object Reflections Problem and the Mirror Reflections Problem;

To my wife Helen, and sons Roderick and Jeffrey, for their patience, encouragement, and very practical cooperation which made this enterprise possible.

The research project, "The Nature and Development of Problem-Solving Behavior in Early Childhood" directed by Dr. L. D. Nelson with co-investigator Dr. D. Sawada, which provided the data on which this study is based, was supported by a Canada Council Research Grant No. 579-0488.

TABLE OF CONTENTS

CHAPTER	PAGE
I. MATHEMATICAL PROCESSES AT THE EARLY CHILDHOOD LEVEL	1
PROGRAMS FOR MATHEMATICS LEARNING	2
PROBLEM SOLVING IN EARLY CHILDHOOD	4
STATEMENT OF THE PROBLEM	6
THE SETTING OF THE PROBLEM	7
DELIMITATIONS OF THE STUDY	8
LIMITATIONS OF THE STUDY	8
DEFINITIONS	9
SIGNIFICANCE OF THE STUDY	10
OUTLINE OF THE STUDY	12
II. DESIGN OF THE INVESTIGATION	13
CRITERIA FOR GOOD PROBLEMS	13
THE PROBLEMS	14
1. The Fold-Out Shapes Problems	14
2. The Projected Shapes	17
3. The Object Reflection	19
4. The Mirror Reflection	20
THE GEOMETRY OF THE PROBLEMS	21
1. The Fold-Out Shapes	22
2. The Projected Shapes	31
3. The Mirror Reflection Problem	37
4. The Object Reflection Problem	42
THE LONGITUDINAL STUDY	44

CHAPTER	PAGE
THE PILOT STUDY	44
THE SAMPLING PROCEDURES	45
THE INTERVIEWS	47
RECORDING THE BEHAVIORS	48
ANALYSIS OF THE BEHAVIORS	48
VALIDITY AND RELIABILITY	49
DATA ANALYSIS	54
III. RESULTS OF THE INVESTIGATION	55
I. THE SHAPES PROBLEMS	56
The Cube - Problems A-D	56
The Results	60
Predictions	68
The Cube - Problems E and F	70
The Predictions	70
The Verifications	76
Modifications to Shapes E and F	79
The Folding Sequences	81
Summary for the Cube	88
The Tetrahedron	90
Assembling the Tetrahedron - Problem G	91
Verification of the Shape	92
Results of the Construction	94
The Predictions - Problems H and J	95
The Verifications	99
Summary for the Tetrahedron Problems	101

CHAPTER	PAGE
The Dodecahedron - Problem K	103
Unfolding the Dodecahedron	104
Prediction	104
Reconstruction Behaviors	104
Solutions to the Problem	107
Summary for the Dodecahedron	110
VERBALIZATIONS	111
Categories of Verbalization	112
Summary for Verbalization	120
THE PROJECTED SHAPES PROBLEM	121
A. The Plane Shapes Wire Models	122
Prediction for Shapes (i)-(iv)	123
The Results	124
(i) The Ellipse	125
(ii) The Parallelogram	128
(iii) The Equilateral Triangle	130
(iv) The Straight Line	131
Summary for Projected Shapes Problems (i)-(iv)	132
B. The Three-Dimensional Wire Models	134
Predictions for Shapes (v)-(x)	135
The Results	137
Shape (v)	137
Shape (vi)	139
Shape (vii)	141
Shape (viii)	141

CHAPTER	PAGE
Shape (ix)	143
Shape (x)	146
Some Observations on Visual Behaviors	148
Verbalizations	151
Time Taken for Problems	156
Summary for Projected Shapes (v)-(x)	156
II. THE REFLECTION PROBLEMS	158
Object Reflection Problems	158
Predictive Behaviors	158
Results	162
Verbalizations	163
Visual Behaviors	170
Aiming the Shooter	172
Summary for the Object Reflection Problems	177
The Mirror Reflection Problems	179
One Reflection Problem	180
Predictions - Problem I	180
Two Reflections Problem	183
Predictions - Problem II	184
Verbalizations	184
Visual Behaviors	188
Summary for the Mirror Reflection Problems	189
INVESTIGATOR RELIABILITY	190
CONCLUDING REMARKS	191

IV. SUMMARY, THE OBSERVED PROBLEM-SOLVING BEHAVIORS, THE CRITERIA OF GOOD PROBLEMS, IMPLICATIONS FOR FURTHER RESEARCH AND CONCLUDING REMARKS	184
SUMMARY OF THE INVESTIGATION	194
I. The Fold-Out Shapes Problem	195
The Cube	195
The Tetrahedron	198
The Dodecahedron	201
II. The Projected Shapes Problems	203
III. The Object Reflections Problems	208
IV. The Mirror Reflections Problems	212
Verbalizations	215
THE OBSERVED PROBLEM-SOLVING BEHAVIORS	218
THE CRITERIA FOR GOOD PROBLEMS	237
IMPLICATIONS FOR FURTHER RESEARCH	238
CONCLUDING REMARKS	239
BIBLIOGRAPHY	241
APPENDIX A. PROTOCOLS	249
APPENDIX B. CODE USED FOR RECORDING DATA FROM VIDEOTAPE	257
APPENDIX C. SAMPLE OF ASSIGNMENTS OF SIX SQUARES	260
APPENDIX D. ILLUSTRATIONS OF PROBLEM-SOLVING SITUATIONS TAKEN FROM THE VIDEOTAPE RECORDER	263
APPENDIX E. SAMPLE OF RECORD SHEETS	266
APPENDIX F. ALLOCATION OF PROBLEM SHEETS TO SUBJECTS FOR EACH AGE GROUP	272

LIST OF TABLES

TABLE	PAGE
1. Distribution of Frequencies for Order of Presentation of Fold-Out Shapes A-F	20
2. Distribution of Solution Categories for Shape A	21
3. Distribution of Solution Categories for Shape B	22
4. Distribution of Solution Categories for Shape C	23
5. Distribution of Solution Categories for Shape D	24
6. Percentage of Subjects in Each Solution Category for Problems A, B, C, D	27
7. Frequency in Each Age Group of Subjects Varying Their Prediction for Shapes E and F	77
8. Distribution of Structured and Unstructured Verifications of Predictions for Shapes E and F	78
9. Distribution of Frequency of Form of Modification to Shape E or F	79
10. Frequency Distribution of Folding Sequences for Shape A	80
11. Frequency Distribution of Folding Sequences for Shape B	81
12. Frequency Distribution of Folding Sequences for Shape C	82
13. Frequency Distribution of Folding Sequences for Shape D	83
14. Distribution of Categories of Judgments and Verifications	84
15. Distribution of Categories of Judgments and Verifications	85
16. Distribution of Categories of Judgments and Verifications	86
17. Distribution of Categories of Judgments and Verifications	87
18. Frequency Distribution of Categories of Judgments and Verifications	88

TABLE

PAGE

19.	Distribution of Solution Categories for the Dodecahedron	109
20.	Distribution of Subjects in Verbalization Categories for Fold-out Shapes Problems	113
21.	Distribution of Categories of Verbalization for Fold-out Shape Problems for Each Age Group	118
22.	Distribution of the Number of Verbalization Categories for Each Age Group in the Fold-out Shapes Problems	119
23.	Distribution of Solution Categories for the Ellipse	126
24.	Distribution of Orientations of Ellipse	127
25.	Distribution of Solution Categories for the Parallelogram	129
26.	Distribution of Orientations of the Parallelogram	130
27.	Distribution of Solution Categories for the Straight Line	133
28.	Distribution of Predictions of Models for Projected Shapes (v)-(x)	136
29.	Distribution of Solution Categories for Projected Shape (v)	138
30.	Distribution of Solution Categories for Projected Shape (vi)	140
31.	Distribution of Solution Categories for Projected Shape (vii)	142
32.	Distribution of Solution Categories for Projected Shape (viii)	144
33.	Distribution of Solution Categories for Projected Shape (ix)	145
34.	Distribution of Solution Categories for Projected Shape (x)	147
35.	Distribution of Categories of Visual Behavior for Projected Shape (v) Problem	151

TABLE	PAGE
36. Distribution of Subjects in Verbalization Categories for Projected Shapes Problem	153
37. Distribution of Categories of Verbalization for Projected Shapes Problems for Each Age Group	155
38. Predictive Behaviors of All Subjects for Object Reflection Problem	160
39. Distribution of Positive Predictions in the Object Reflection Problems	161
40. Distribution of Problems Attempted for Each Age Group	162
41. Distribution of Categories of Solution for Object Reflection Problem (55 Shots)	164
42. Distribution of Subjects in Verbalization Categories for Object Reflection Problem	166
43. Distribution of Verbalization Categories for Each Age Group in the Object Reflection Problem	168
44. Distribution of the Number of Verbalization Categories for Each Age Group in the Object Reflection Problem	169
45. Range of Visual Behaviors Shown by Subjects Tipping Bear Two and Three Times for Each Success	171
46. Number of Subjects with Particular Aiming Positions	173
47. Distribution of Subjects in Positions for Aiming in the Object Reflection Problem	174
48. Frequent Behaviors Displayed in the Object Reflection Problem	176
49. Distribution of Solution Categories for Mirror Reflection Problem - One Reflection	182
50. Distribution of Solution Categories for Mirror Reflection Problem - Two Reflections	185
51. Distribution of Subjects in Verbalization Categories for the Mirror Reflection Problem	187

TABLE

PAGE

52. Investigator-Observer Coefficients of Agreement for Fold-out Shapes Problem	192
--	-----

LIST OF FIGURES

FIGURE	PAGE
1. Parallel Projection with Parallel Planes	32
2. Central Projection with Parallel Planes	32
3. Parallel Projection with Oblique Planes	34
4. Central Projection with Oblique Planes	34
5. Prediction Responses for Shapes A, B, C and D	69
6. Prediction Responses for Shapes E and F	71
7. Percentage of Prediction Responses for Fold-out Shapes Problems	73
8. Percentage of Prediction Responses for Shapes E and F	75
9. Percentage of Prediction Responses for Shapes H and J	97
10. Sample of Category I Solutions - Projected Shapes Problems	149

CHAPTER I

MATHEMATICAL PROCESSES AT THE EARLY CHILDHOOD LEVEL

The importance of effective experiences for introducing and teaching topics in elementary school mathematics is reflected in recent literature on mathematics education (Almy, 1975; Nelson & Liedtke, 1972, 1974; Schminke, Maertens & Arnold, 1972; Mathematics in Primary Schools, 1969). Experience with the physical environment has been a common factor in all learning theories (Piaget, 1970, p. 719). However Piaget has added a third dimension to the kinds of experience commonly noted, exercise and physical experience, namely logico-mathematical experience, or "the significant logical achievements of the child in dealing with his physical environment (Hilgard & Bower, 1975, p. 320)."

Schminke et al have indicated that for early childhood experiences to be effective they should

- (i) draw on the child's previous experiences,
- (ii) help the child to use prior knowledge to organise further experiences into mathematical concepts;
- (iii) lead the child to operate on these concepts, thereby forming abstract axioms of mathematics (Schminke, Maertens & Arnold, 1972, p. 5).

Furthermore these experiences should help to guide children's exploration and discovery processes, help them to become flexible in their thinking of class properties, help to fix their mental and manipulation skills and lead them to apply these processes and skills in attacking mathematical problems (Nelson & Liedtke, 1974).

Play and structured learning situations have been characteristics of many early childhood programs (Almy, 1975). To give some indication of the wide variety of processes performed by children, effective experiences have included the following:

- a. in Number: sorting, classifying, grouping, measuring, counting, comparing, estimating, ordering,
- b. in Geometry: folding, modelling, sliding, rotating, flapping, projecting, aiming, coordinating.

These lists, although not exhaustive, provide some evidence of the wealth of effective mathematical experiences which may be incorporated in programs for developing early childhood mathematics.

PROGRAMS FOR MATHEMATICS LEARNING

Many early childhood programs have developed from the pedagogical theories of Pestalozzi and Froebel, and in recent years some have been influenced by the learning theories of Bruner, Dienes, Gagné and Piaget (Almy, 1975). The philosophies of the Montessori school, the DISTAR program of Engelmann and Carnine (1970), and the Piagetian based curriculum of Kamii (1971) have been reported in the following terms.

The Montessori program was designed to place major emphasis on individual instruction through self-correcting materials (Weber, 1969), and was based on "a prepared environment" around which mathematical experiences were arranged (Orem, 1971; Standing, 1962). The teacher's role, what the child was to learn or do, and the complexity of the task were clearly laid out in the lesson plans which were

3

drawn around a "teach teaching, not correcting philosophy (Chow & Elmore, 1973)."

The highly structured DISTAR program of Engelmann and Carnine (1970) was based on the task analysis approach of Gagné (1970) and his theory of the hierarchical nature of the learning process. This program was language oriented, and was characterized by a patterned drill. It relied predominantly on association or rote learning (Osborne & Nibbelink, 1975).

A preschool curriculum based on the Piagetian theory of cognitive development was initiated by Kamii (1971). Outlining the objectives of teaching in such a school, Kamii wrote:

The objectives in a Piagetian school are (a) to structure the child's knowledge of the properties of familiar objects, and (b) to give him a repertoire of actions he can perform to explore the physical nature of unfamiliar objects (1971, p. 310).

Referring to the development of spatial concepts, she wrote:

The teaching of spatial concepts is achieved in the larger context of the structuring of space ' (1) from the self-to-object level to the object-to-object level, (2) from the topological space to euclidean space, and (3) from the sensory-motor level to the representational level (Kamii, 1971, p. 304).'

Although these and other developing programs have been evaluated (Junge, 1975; Suydam, 1974), an alternative approach to mathematics education, namely the problem-solving approach, has not been adequately investigated (Kilpatrick, 1969). Polya (1945, 1967) has done much to formulate techniques for teaching problem solving. He, like Dewey (1933), placed great emphasis on a 'stages' approach to problem solving, and advocated a heuristic process in teaching mathematics. Kleinsmuntz (1966) surveyed the fields of research,

method, and theory in problem solving from the behaviorists to the information processors. Problem-solving abilities, problem-solving structure and content and processes have also been surveyed (Riedesel, 1969; Stievater, 1971).

These investigations have been associated, almost without exception, with verbal problem solving. On the other hand, a field which has not been adequately investigated is that of nonverbal problem solving. Nelson (1975) and Little (1974) have reported exploratory studies in children's behaviors displayed in nonverbal problem-solving situations associated with the mathematical processes of division. However, if a problem-solving model is to prove a suitable alternative for arranging mathematical experiences for children, more precise information is needed about how young children behave in particular problem settings.

PROBLEM SOLVING IN EARLY CHILDHOOD

Henderson and Pingry (1953) described the importance of problem solving in this way:

. . . life is not simple and unchanging. Rather it is changing so rapidly that about all we can predict is that things will be different in the future. In such a world the ability to adjust and to solve one's problems is of paramount importance (p. 233).

Research into the nature of the problem-solving process has been reported (Suydam, 1974; Stievater, 1971; Riedesel, 1969). Some of the variables which have been highly correlated with mathematical achievement or problem-solving ability included vocabulary, retention of details, perception of relationships, integration of dispersed

ideas, reading comprehension, and rate of comprehension (Dodson, 1972).

The inability of young children (3-5 years) to read, and their "limited representational ability (Piaget & Inhelder, 1967)" have been difficulties associated with mathematical problem solving in this age group. To avoid these difficulties a nonverbal problem-solving model has been suggested by Nelson and Sawada (1974), and a number of associated problem-solving situations have been developed by them.

In a description of the role of problem solving in the elementary school, Cohen and Johnson (1967) have pointed out that:

A true problem (often called a "good problem") in mathematics can be thought of as a novel situation for the individual who is called upon to solve it. The path of the goal is blocked and the individual's fixed patterns of behavior are not sufficient for removing the block. Hence, deliberation must take place. In this deliberation we can note many different kinds of behaviors that might be exhibited by the problem solver (p. 261).

Further research into problem-solving behaviors has been advocated (Little, 1974). Referring to the lack of research in this field, Kilpatrick (1969) wrote:

Much has been said lately about the need for large scale complex studies in mathematics education, but the researcher who chooses to investigate problem solving in mathematics is probably best advised to undertake clinical studies of individual subjects . . . because our ignorance in this area demands clinical studies as precursors to larger efforts (p. 531).

Geometry has been an area of the mathematics curriculum which has been regarded traditionally as a vehicle for developing problem-solving skills and strategies. At a conference devoted to Piagetian cognitive-development research and mathematics education (Rosenopf et al, 1971), the perception of children and their

understanding of geometrical ideas was discussed. On this subject Dodwell (1971) concluded:

There is no extensive literature in the Piagetian tradition on geometry and concepts to review, no hotly debated issues at either the theoretical or the experimental level on which to make judgements. To a remarkable degree this field has been neglected . . . (p. 186).

Dodwell emphasised the need for research of this type in order to throw further light on those intellectual functions associated with "geometrical imagination and understanding (1971, p. 187)."

STATEMENT OF THE PROBLEM

The need (a) for further research in nonverbal problem solving expressed by Kilpatrick (1969) and (b) for further information on children's understanding of geometrical ideas prompted this investigation.

The main problems addressed in this study were:

- A. To collect the behaviors exhibited by a sample of children (aged 3-8 years), while they were engaged in solving four spatial relationships problems, namely:
 - (i) the fold-out shapes problem,
 - (ii) the projected shapes problem,
 - (iii) the object reflections problem, and
 - (iv) the mirror reflections problem.
- B. To analyse and classify these behaviors.

THE SETTING OF THE PROBLEM

Nonverbal problem-solving behaviors of young children have become a focus of attention in mathematics education research within the Department of Elementary Education at the University of Alberta.

Nelson (1974) wrote:

... the central purpose of any mathematical instruction at the early childhood level is to help the child see order and meaning in situations and events which occur in his everyday activities. It is important that the child gains control over such situations and events, and that he learns to change or modify them so that they more nearly suit his own needs and purposes (p. 1).

Working from this standpoint, and supported by a Canada Council research grant, Nelson and Savada (1974) developed a set of twelve problem-solving situations and the physical apparatus for presenting them to young children. These twelve problems consisted of six pairs, having different physical structures but involving the same or related mathematical structures.

The domain of the study by Nelson and Savada (1974) was to:

- a. Identify, select and refine criteria for the specifications and construction of mathematical problems which can be used effectively to study the behavior of children aged three to eight years.
- b. Construct, on the basis of these criteria, a selection of problem situations.
- c. Engage children, under carefully controlled conditions, to interact with the problem situations.
- d. Observe, record and categorize the behaviors manifested by the children in interacting with the problem situations.

- e. Trace the scope and sequence of problem-solving behaviors over the age range.

DELIMITATIONS OF THE STUDY

1. Only those behaviors spontaneously generated by the specific problems were examined.
2. Problem-solving behaviors were studied in reference to a particular group of children.
3. Although children's attitudes, general motivation, and innate ability are acknowledged to affect their problem-solving behaviors, these attributes were considered to be peripheral to this study.

LIMITATIONS OF THIS STUDY

1. The unfamiliar setting in which the investigation took place, the presence of several adults in the room, and the movement of such strong distractors as a videotape camera and recording equipment may have affected the performance of the subjects.
2. The spatial problems selected for this study may have restricted the range of problem-solving behaviors displayed by the subjects.
3. The responses observed were characteristic only of the set of subjects involved in this project.
4. The amount of time allowed the subjects of this study due to the interviewing schedule and the amount of tape available for recording may have restricted their performance.

DEFINITIONS

Euclidean Space. This is space which is characterized by perception of angles, distances, proportions and parallels, and operations within a coordinate system.

Projective Space. This is space characterized by the ability to view an object or diagram in relation to a point of view other than that of the observer.

Topological Space. This is space which is characterized by the attention given to proximity, order, separation and enclosure of an object or its representation. It does not consider Euclidean or projective aspects of an object.

Proximity. This is the relationship between two components of a plane drawing which concerns their nearness to each other.

Closure. A curve is closed when it has no end points.

Problem. The apparatus and the accompanying verbal statement or demonstration which were designed to stimulate some reaction from the child.

Problem Situation. All aspects of the apparatus designed for a problem.

Problem-Solving Behavior. Any act or reaction which the problem stimulates in the child.

SIGNIFICANCE OF THE STUDY

The nature of problem solving and the development of strategies for problem solving have been documented. Gagné has defined problem solving as "an inferred change in human capacity resulting

in the acquisition of a generalizable rule novel to the individual, and applicable to the solution of a class of problems (Carpur, 1966, p. 132)." Dewey (1933), Polya (1945) and Newell and Simon (1973) have all made substantial contributions to the literature on problem solving particularly with reference to the "stages theory," the "heuristic method" and the "information processing approach." Referring to the Dutch educator van Hiele, Hirsny (1973) states:

The development which leads to a higher geometric level proceeds basically under the influence of learning, and therefore depends on the content and method of instruction (p. 7).

Van Hiele, who has influenced Russian thought on mathematics curricula (Hirsny, 1973), postulated levels of development in geometry. These levels were not dependent on motivation, but proceeded in discontinuous leaps in the learning curve, and were consistent with the abrupt changes and plateaus reported in developmental studies. These levels were also characteristic of the action of instrumental conceptualization advocated by Bruner (1960) who states:

the heart of the educational process consists of providing aids and dialogues for translating experiences into more powerful systems of notation and ordering (p. 21).

A general consensus has been established regarding the role of concrete materials in the development of problem solving and the understanding of geometric postulates in young children. However, more precise indications need to be obtained about the young children behave in particular problem-solving activities and how they perceive the problem. Gagné and White (1968) reported the use of the "thinking aloud" technique used by Larkin (1967) in their

children's thought processes when solving problems. However, in a study where boys 14-15 years old were required to verbalize during practice, Gagné and Smith found that verbalizing had the effect of making children think of new reasons for their moves.

The method of observation devised for this study offers distinct advantages. The behaviors of children in problem-solving situations can be recorded with high reliability. Having been authentically preserved, these behaviors may be subjected to a variety of analytical procedures. Thus the research technique of using a videotape recording has important implications in the field of education studies.

What children think as they pursue a mathematical problem is of great interest to educators. Although the behavior exhibited by children does not allow the observer to know precisely what they are thinking, it is possible to interpret their problem-solving strategies. Illumination on children's perception of a problem may also be derived from spontaneous verbal statements made during their attempts to solve that problem.

A study of the behavior of children can also enable the researcher to identify those variables which influence a child's activities and thought processes. In this way factors which facilitate problem solving in young children may be determined.

This study may also be of some importance in guiding those interested in developing problems based on real life situations. It may further identify appropriate problem-solving settings for young children. Newell and Simon (1972) comment:

A theory of the psychology of problem solving requires not only good task analysis, but also an inventory of possible problem-solving mechanisms from which one can surmise what actual mechanisms are being used by humans (p. 6).

OUTLINE OF THE STUDY

The following chapter contains a detailed explanation of the research design underlying this study. It describes the four problems investigated, and the mathematical basis of each problem. The methodological procedures involved in the sampling procedures, data collection and data analysis are also explained.

Chapter Three reports the findings of the study.

Chapter Four concludes with a summary of the discussion of the findings, conclusions and implications of the study, and recommendations for further research.

CHAPTER II

DESIGN OF THE INVESTIGATION

The purpose of this study was to

- A. Collect the behaviors exhibited by the sample of children while they were engaged in solving
 - (i) the fold-out shapes problem
 - (ii) the projected shapes problem
 - (iii) the reflected objects problem
 - (iv) the mirror reflection problem.
- B. Analyse and classify these behaviors.

This chapter provides details of the problems, the mathematical background of these problems, the means by which the subjects were selected, the presentation of the problems, the method employed for collection of the data and the method by which the data were analysed and verified.

CRITERIA FOR GOOD PROBLEMS

Before a set of problems suitable for the basis of a research project are constructed or selected, some theoretical framework or a set of specifications is necessary to establish the appropriateness of certain problems for that task. Nelson and Kirkpatrick (1975) formulated a number of criteria for the identification of a "good"

problem. These were taken into consideration in the construction of the four problems selected for this study.

The criteria of Nelson and Kirkpatrick (1975) were:

1. The problem should be of significance mathematically.
2. The situation in which the problem occurs should involve real objects.

The problem situation should capture the interest of the child.

4. The problem should require the child himself to move, transform or modify the materials.
5. The problem should offer opportunities for different levels of solution.
6. The problem situation should have many physical embodiments.
7. The child should be convinced that he can solve the problem, and he should know when he has a solution for it (pp. 71-72).

The materials, tasks, and mathematics of the four spatial relations problems will be discussed in the next section.

THE PROBLEMS

1. The Fold-Out Shapes Problem

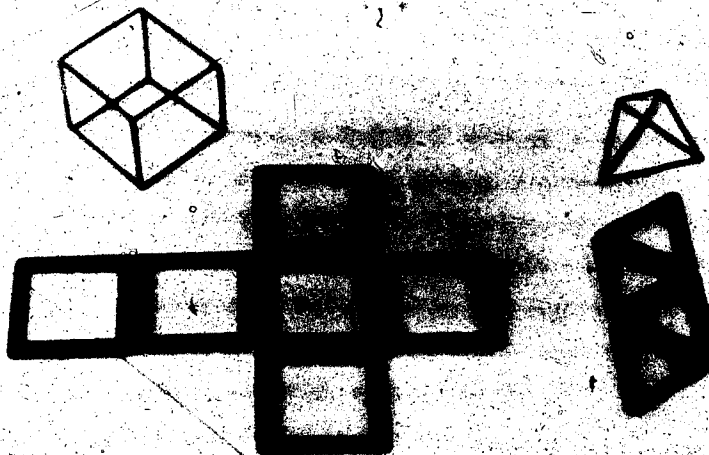

six squares, four equilateral triangles and twelve regular pentagons, each of side 10 cm, were fabricated from plexiglas 3.2 mm thick. Alternate edges were fitted with strips of rough and smooth Velcro material, thus providing a means for hinging the various shapes. The six squares may be used to form a cube, the four equilateral triangles tetrahedron, and the twelve regular pentagons may be attached to form a dodecahedron or a twelve sided regular polyhedron. The following problems were presented to each subject.

(a) The Cube

A completed cube was placed on a low table in front of a child, who was encouraged to handle it and give it a nuzz. The child was then instructed to unfold the cube so that all the squares would be flat on the table. The child was then asked to fold up the cube again. The interviewer then informed the child that after the squares had been laid out in different ways, he would be asked to make a box from each layout by folding up the squares. The box was unfolded and the following arrangements were presented in turn to the child.

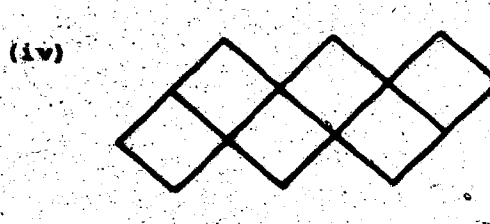
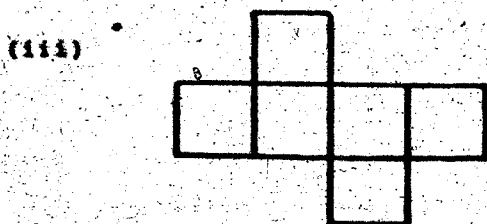
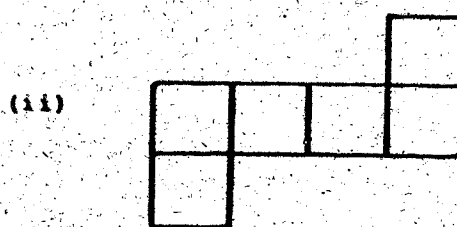
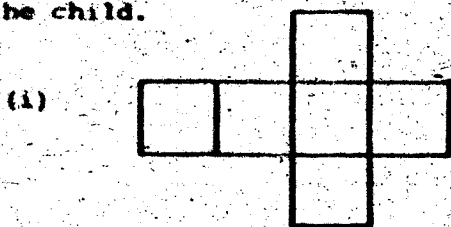

... of the table. The child was encouraged to guess whether or not he would be able to make a box from a particular arrangement before he actually folded up the squares. When he had completed these activities, the following arrangement was then presented and the child asked to predict whether or not he could make a box by folding the squares.

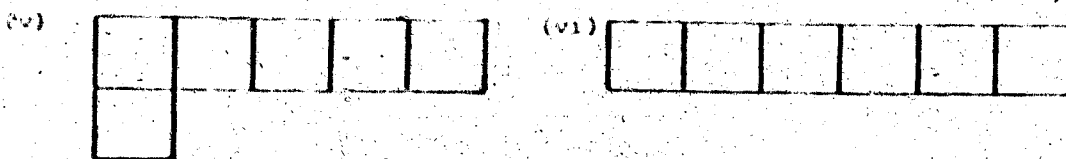

Whatever the answer, the child was asked to verify his choice. The squares were then refolded as in (v) and (vi), and the child asked how he would rearrange the squares so that he could make a box with them. The child was given no assistance with this operation. On completion of the task, the materials were removed from the table.

(b) The Tetrahedron

Four separate Plexiglas equilateral triangles were placed on the table in front of the child. He was asked if he could attach the pieces together in such a way that he would be able to fold them into a box. A wire framed tetrahedron of the same dimensions was available for inspection. If the child failed to make the figure he was given assistance.

The triangles were then laid out in the following arrangements and the child asked if he could make boxes from them.

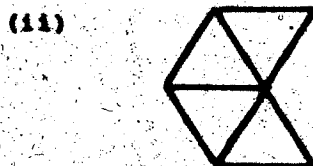

After making his prediction the child was asked to verify his choice. No assistance was given to the child. When he had completed this task the materials were moved from the table.

(c) The Dodecahedron

A completed dodecahedron was placed before the child, who was encouraged to handle the shape, to name it and then dismantle it. When he had unfolded all the sides of the dodecahedron, he was then asked to reassemble it. No assistance, other than holding pieces in place, was given to the child. No wire framed model was available for inspection. (See Appendix for protocol.)

2. The Projected Shapes



A 35 mm slide projector was used to project a beam of light onto a gray screen. A set of three plane wire shapes, a circle, of diameter 10 cm, a rectangle 30 cm x 10 cm, and an equilateral triangle

... a set of shapes...
 ... presented, a rectangular parallelepiped...
 ... the first set of wire frames (a), (b), (c), ...
 ... following figures which were displayed individually on cards:

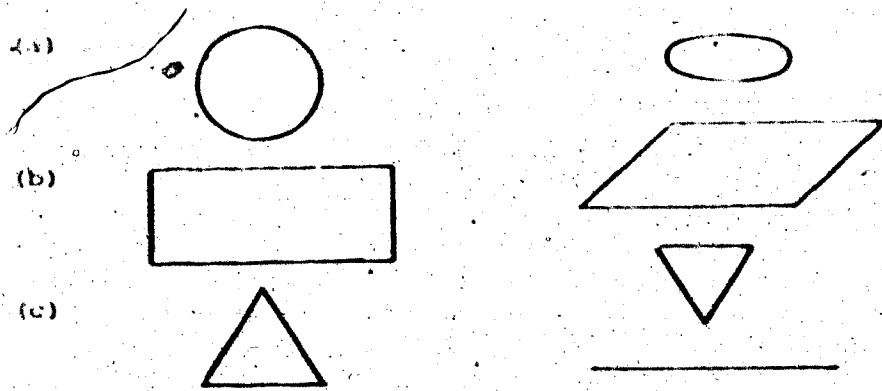

Shapes (d), (e), (f), illustrated below, were then presented together and the subject asked to choose a shape and make a shadow to match the figures in the second column which were displayed on individual cards.

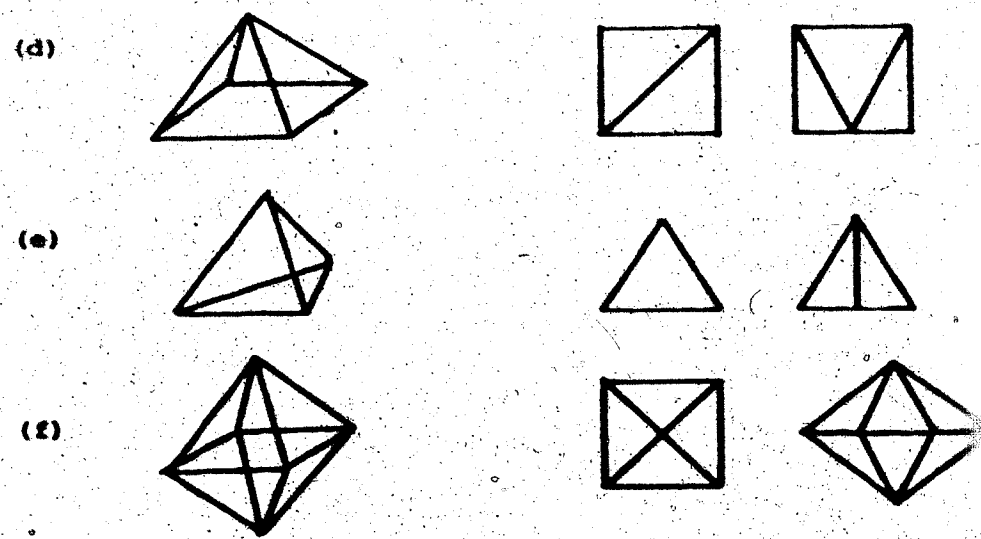

(See Appendix for protocol.)

3. The Object Reflection

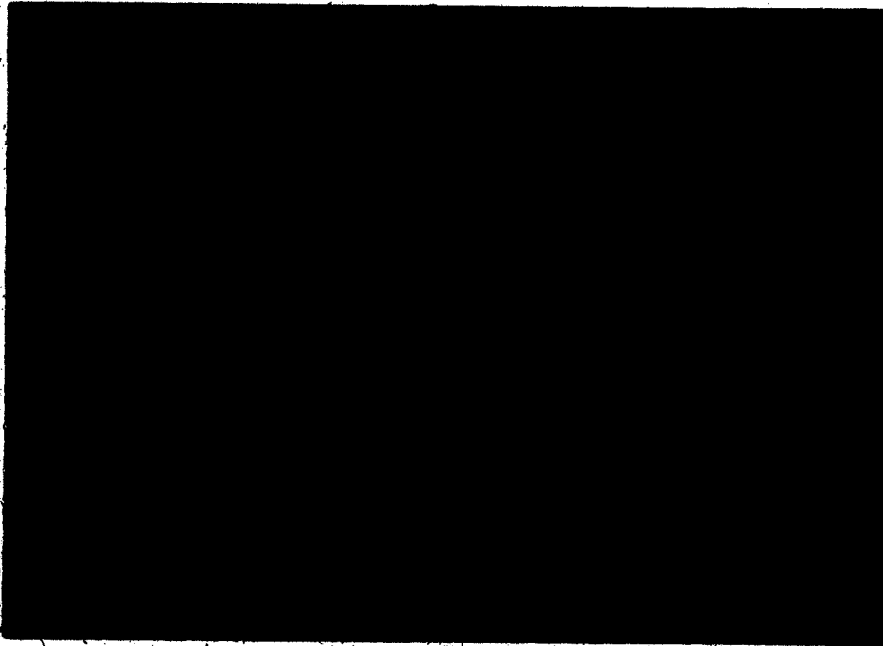

The apparatus consisted of a board 105 cm x 75 cm surrounded by walls 5 cm high. The walls were covered with a layer of sheet rubber. A spring loaded shooter capable of projecting a steel ball 1.5 cm in diameter could be located and rotated in one corner of the board by fitting the pivot into one of ten holes drilled in the board. A plastic bear was used as a target. The subject was instructed to tip the bear over by aiming directly at the bear. He was then asked to tip the bear over by bouncing the steel ball off one wall, and wooden blocks were placed strategically to prevent a direct aim. Later he was asked to bounce the ball off two walls and tip the bear over. (See Appendix for protocol.)



4. The Mirror Reflection

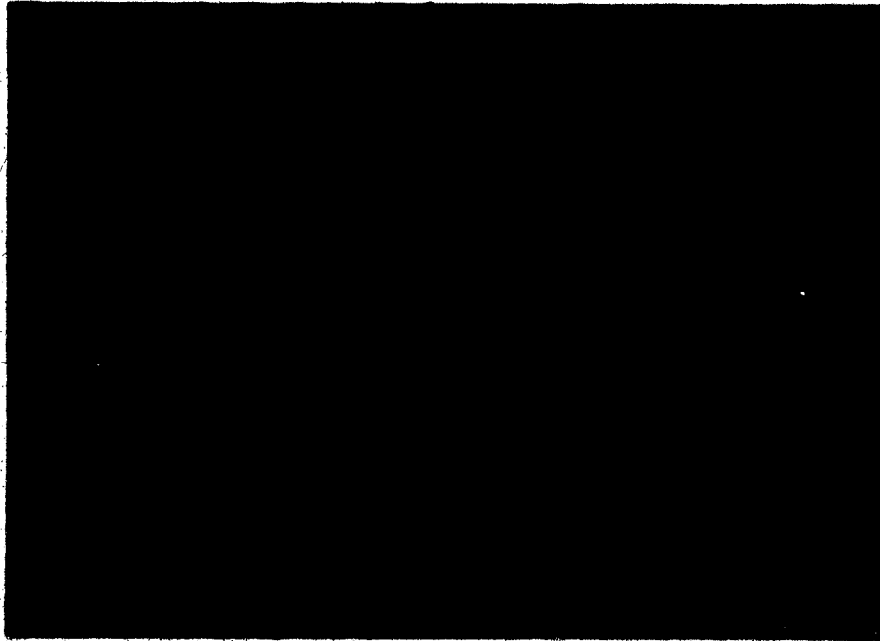

The apparatus for this problem consisted of a board 105 cm x 75 cm surrounded by walls 5 cm high, the inner surface being covered by plane glass mirrors. A high intensity pointer flashlight was fitted to a base which moved in a slot cut in the board and which was able to rotate about a point. The target consisted of an upright strip of cardboard on which representations of four animals, an elephant, a lion, a bear and a deer, were drawn. The subject was instructed to shine the light on a succession of animals, in a given order, first by shining the light directly onto the cardboard strip, then by reflecting the light off one of the mirrors, and later by reflecting the light off two of the mirrors. (See Appendix for protocol.)

THE GEOMETRY OF THE PROBLEMS

The behaviors displayed and the strategies used by the subjects in solving each of the problems listed above were the focus of this study. Each of these problems will now be considered in terms of its mathematical basis.

It should be noted that Coxeter (1963) has defined a polyhedron in the following way:

A polyhedron P is a connected, unbounded, two-dimensional manifold formed by a finite set of non-re-entrant, simply connected plane polygons (p. 14).

In an original exposition of the mathematics of orientable polyhedra with regular faces, Stewart (1970) describes the surface (manifold) of a polyhedron thus:

A connected, unbounded two-dimensional manifold is a finite set of polygonal regions, arranged so that each edge of each region is matched with exactly one other edge of the same or another region and vertices are matched only as required by the matching of edges (p. 9).

By restricting the matching of edges and vertices the definition guarantees homogeneity, and since the edges are matched in pairs, this leaves no edge free. In this sense the surface is unbounded. These definitions will be seen to be significant in the analytical solutions of the problems.

1. The Solid Figures

(a) The Cube

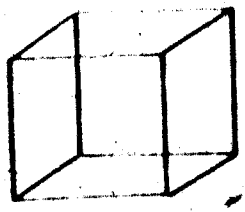

This member of the class of regular polyhedra is the most commonly recognised and probably the easiest solid for children to study. It is characterized by six congruent square faces, and the dihedral angles are also congruent; hence its regularity. Each of the dihedral angles is a right angle. This is another characteristic which makes it easily identified and constructed.

The six square faces of this three dimensional solid may be mapped onto the two dimensional plane by rotations of 90° or multiples of 90° about the edges of the solid. In this way the cube may be "unfolded" to form a net of the solid. Any such arrangement will of necessity (by the principle of reversibility) fold up into a cube. Some common arrangements which fold up into the cube are:

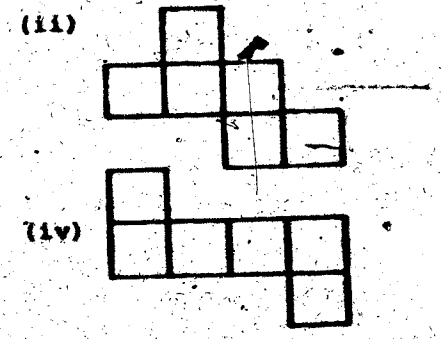
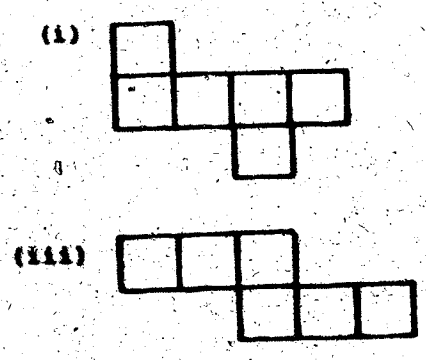

Some of the arrangements which do not fold up are as follows.

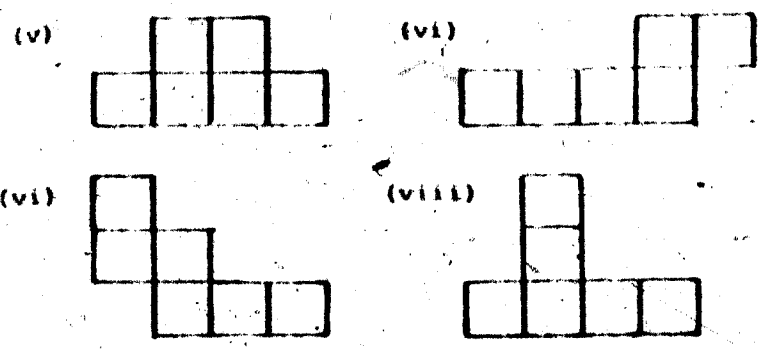

Methods of Solving the Problem

(i) By Folding

This direct method does not require much more than an attempt at folding up adjacent sides in most cases. Even the most unlikely looking case (iii) above soon shows evidence of foldability once two sides have been lifted. Attempts at folding could be described as systematic or haphazard.

(ii) By Observation

The child who matches the faces of the 2-dimensional figure with the three dimensional model can set up a correspondence which will lead him to a decision.

(iii) By Analysis

Some children will quickly learn from experience, that when a row of four squares has one square above and one square below it, that this will fold up no matter what the disposition of these two squares is, provided that they coincide with the edges of other squares.

Again, children would learn that any arrangement of four

squares with a common vertex such as that illustrated.

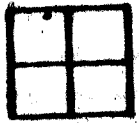

within any arrangement precludes the possibility of this being a fold-up arrangement.

(iv) By Mapping

A study of the cube will show that three planes intersect at each vertex. Hence a mapping of congruent sides could prove to be another method. Again, each vertex of a square face coincides with a vertex or corner of the solid. Thus a mapping which links sets of three vertices of squares which are compatible would lead to a recognition of foldability. A rather simple principle of superposition holds in this case, namely, that if two adjacent or different squares have a common point, then on folding, the other endpoints will coincide. Thus for the figure to fold completely, it is necessary that there be eight sets of these coincident points.

The following diagram illustrates this principle:

A, B, C, and D already meet the requirements. $G \neq H$ and $J \neq H$, thus forming a different confluence of vertices to form a vertex of the net. At F two points coincide, the third member of the trio being E.

To illustrate a case where no fold up can result in a cube,

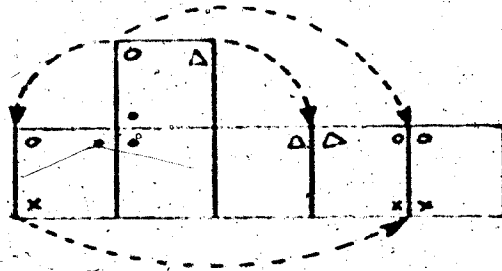

obviously there are some points which are left unmatched, but not only this, there are some points which exceed the required three of confluent points.

(b) The Tetrahedron

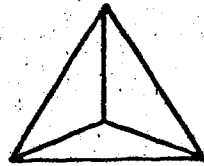

This regular solid is surrounded by four equilateral triangles.

It is a triangular pyramid with all dihedral angles equal to 60° .

The faces of the tetrahedron fold out to form a net in only two ways, namely

(i)

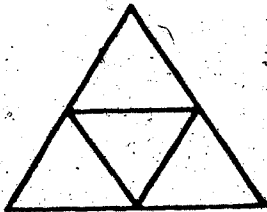

and (ii)



Each vertex of the tetrahedron consists of three incident vertices of the triangular faces. In the first figure

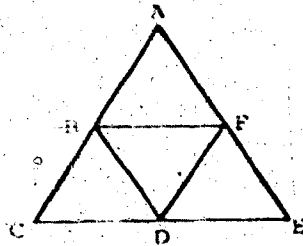

points B, D, F already satisfy this requirement. Points A, C, and E must therefore map onto one point, namely the remaining unaccounted for vertex of the solid.

In the second figure

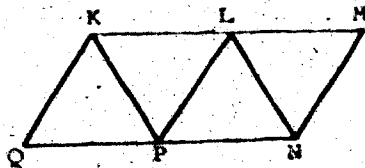

L and P name three coincident points. K with only two coincident points needs a third point to meet the requirements for foldability. The only vertex available to satisfy K is M. A similar argument shows that Q would need to map onto N. Thus the mapping rule for folding this arrangement is K and $Q \rightarrow N$.

The arrangement of the four triangles

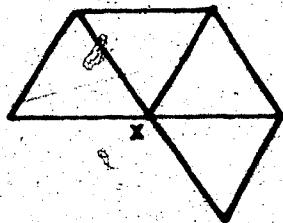

... X ... 4 coincident points. Some very simple arithmetic of observation alone would then indicate that X cannot be a vertex of the tetrahedron.

Methods: Solving the Problem

(i) Folding

A trial approach will lead to a decision as to whether a given arrangement of the triangles will fold up into the tetrahedron. This may not be quite as frustrating as with the cube problem.

(ii) By Observation

A comparison of the network with the wire frame model could lead to a decision. The first network given

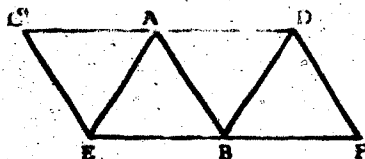

is not an obvious case, since the dihedral angles are not as easy to recognise as those of the cube, for example. However A and B could be recognised as vertices of the tetrahedron since they are the coincidences of three triangle vertices. C and D, both adjacent to A will coincide on folding the triangle, while E and F will also coincide. Thus four sets of "triple" points are formed resulting in a complete fold-up of the net.

(iii) By Analysis

The basis of this method has already been considered in the

introduction to this solid. Each vertex is the point of coincidence of three intersecting faces of the tetrahedron. It is thus a matter of recognising these points of the network which already satisfy this condition, and then finding those points which can be matched to meet this condition.

The second arrangement, with all four triangles sharing a common vertical point, is easier to fold visually. Quite apart from having the aforementioned overabundance of coincident points, the sides fold to form a square based pyramid. It is necessary therefore, for a child to recognise that a square based pyramid differs from a triangular pyramid, to realise that this format will not fold up into a tetrahedron.

On the other hand, children who recognise that the tetrahedron has three side faces could be expected to note the presence of the additional side and predict that the arrangement would not form a tetrahedron.

(c) The Dodecahedron

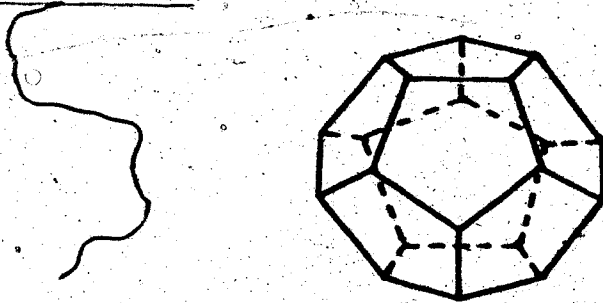

This regular polyhedron has twelve pentagonal faces, twenty vertices and thirty edges. Whereas the cube and tetrahedron unfold into a small number of nets, the dodecahedron can be unfolded into

many nets all of which are complicated in appearance. As is the case with the two previous solids, each edge of a pentagon joins with an edge of another pentagon to form an edge of the solid, and each vertex joins with a vertex of two other faces to form a vertex of the solid.

Methods of Solving the Problem

(i) By Folding

This is the most difficult of the three solids to visualize. The method of dismantling the solid has some bearing on the difficulty of the problem.

If the dodecahedron is simply unfolded to form a net, the reversibility of the system could suggest the possibility of refolding the faces, and lead to a correct prediction for this problem. The real difficulty in this case is that of knowing where to start folding or which pieces to start raising. If two adjacent pentagons are raised and joined, the problem is simplified, since the solid immediately begins to take shape. If sides are raised which do not join, no such reinforcement occurs and a modified strategy has to be introduced.

(ii) By Observation

Since a frame or model of the solid is not available in this problem, a subject requires a good mental image of the dodecahedron if he is to recognise the relationship of the arrangement of pentagons to the completed solid. In the particular case of the net shown below the relationship may be easily recognised, since

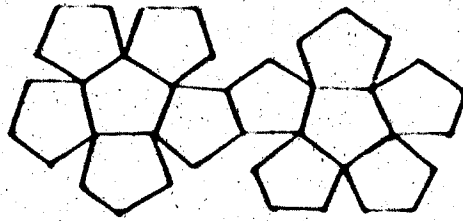

Each half of the network forms a recognizable part of the solid.

(iii) By Analysis

This method demands a high level of thought and understanding of the dodecahedron. The method has already been presented, and an illustration will indicate the process. Dotted lines in the figure below display how sets of coincident vertices may be identified. When this process is continued round the figure without interruption of the pattern, the foldability of the net is verified.

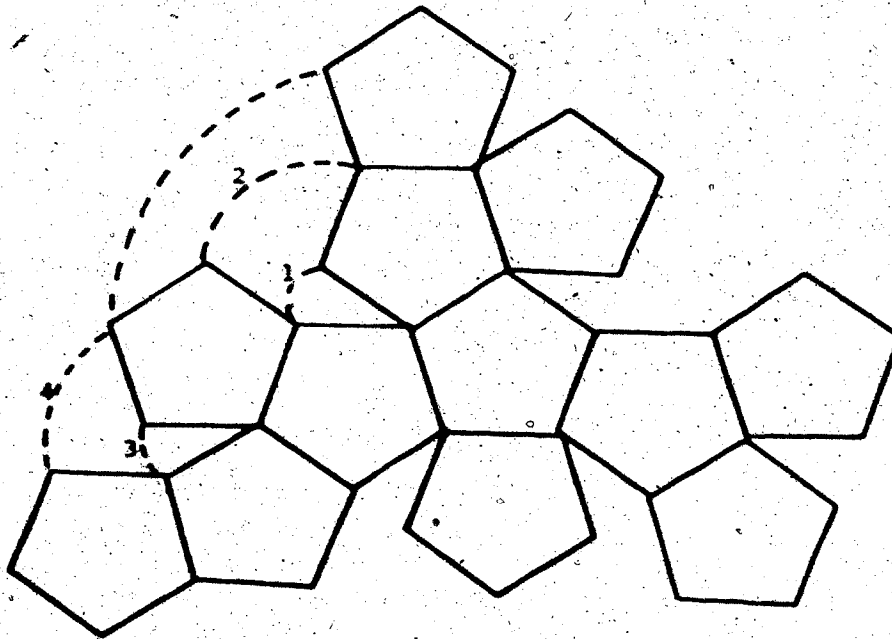

This method could lead to effective and efficient fold up procedures.

(iv) By Construction

If all faces of the dodecahedron are detached, then construction of the solid may begin by

- (a) forming a net and trying to fold it, or
- (b) assembling the solid by building the faces around the base.

The net formed in method (a) may not fold, and this introduces confusion into the problem. Method (b) is efficient if the subject adds new faces to join with two others. This leads to completion of the bottom half of the solid. This procedure may be duplicated and the two halves linked together, or the subject may continue to build up on the bottom half.

2. The Projected Shapes

Projective geometry is the study of the properties of shapes which remain invariant under certain transformations. These transformations are illustrated best by diagram (e.g. Unified Modern Mathematics, 1973, pp. 17-31). Figures 1 and 2 illustrate transformations which could be identified as euclidean. The properties which remain invariant under such transformations are:

- 1. openness (or closedness) of curves
- 2. interior, exterior, boundary points
- 3. linear order, cyclic order
- 4. connectedness
- 5. straightness of lines
- 6. convexity of figures
- 7. parallelism of lines

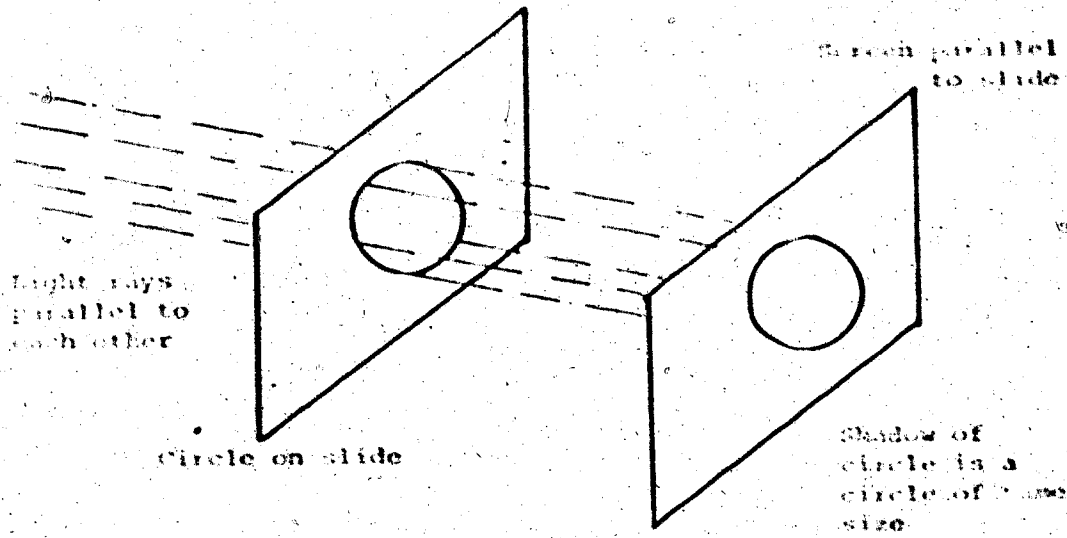

Figure 1

Parallel Projection with Parallel Planes

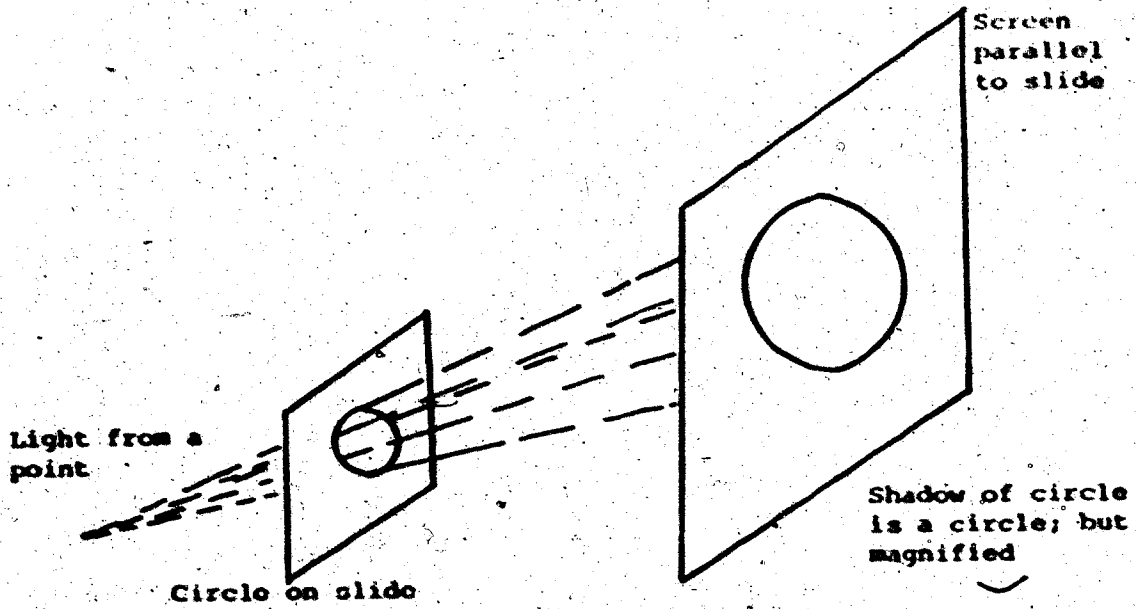

Figure 2

Central Projection with Parallel Planes

- 8. ratios of distances
- 9. measure of angles
- 10. length.

In figures 3 and 4 the above transformations are further transformed by tilting the screen. However the duality of the situation means that the same results would occur if the screen remained fixed and the circle on the slide (or the wire frame in this case) is tilted. Figure 3 illustrates an affine transformation, under which properties 1 through 8 above are preserved, or remain invariant. Under a projective transformation, only properties 1 to 6 remain invariant. Thus a euclidean transformation is an affine transformation, but not vice versa.

The prime purpose of the task was to observe whether children could predict the shape which would cast a particular shadow when a beam of light from a slide projector was used. The distance between object and shadow was between 30 cm and 75 cm, whereas the distance between projector and screen was approximately 150 cm. The resulting magnification was only slight.

The wire frames form two sets of closed figures, namely simple closed and complex closed figures. An analysis of the shapes formed by these will therefore be recorded in two parts.

(a) The Simple Closed Figure

The circle, rectangle and triangle are topologically equivalent, each being a simple closed curve. Selection of the circle to produce the ellipse could be made on the basis that both shapes are bounded by curves. It could also involve an intuitive notion that a

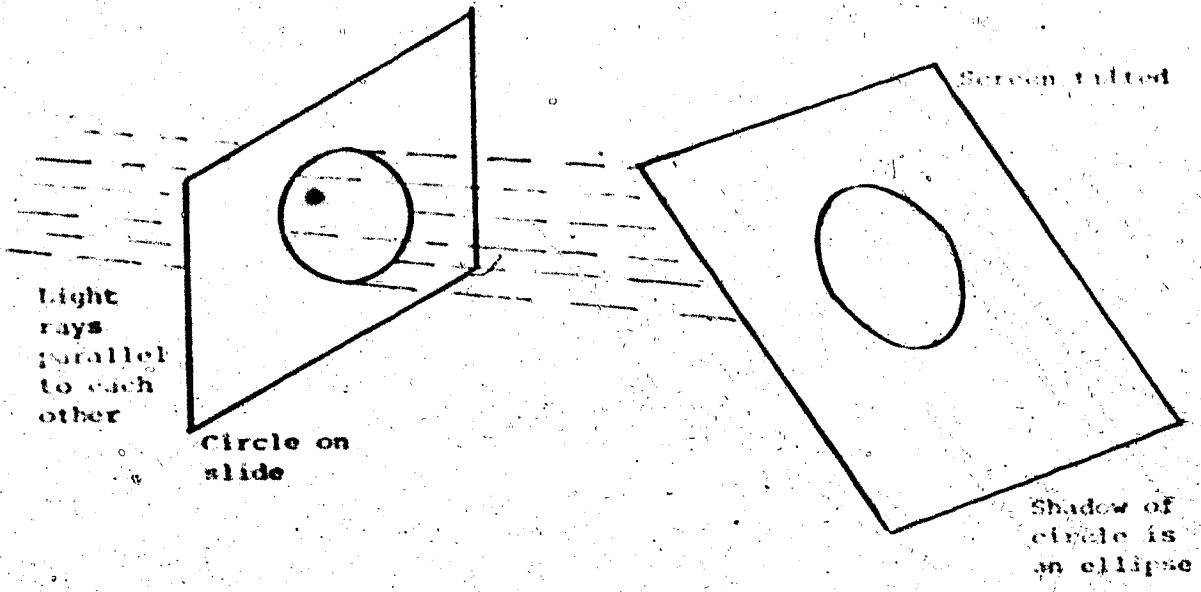

Figure 3
Parallel Projection with Oblique Planes

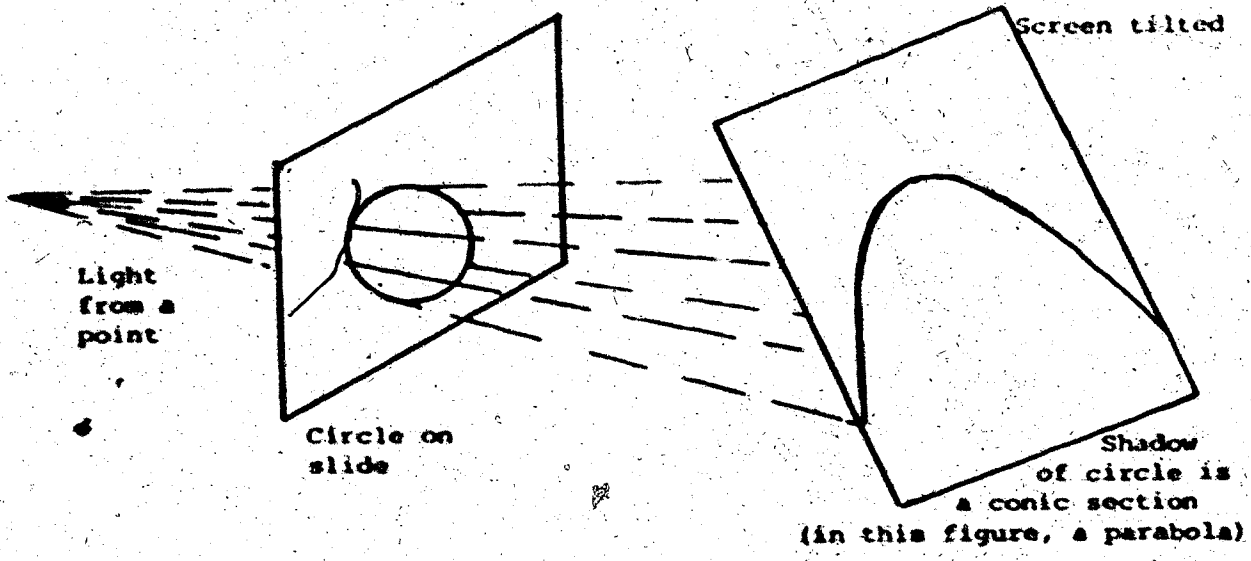

Figure 4
Central Projection with Oblique Planes

straight edge would not produce a curved shadow, although the converse of this intuitive notion would be incorrect.

The formation of a straight line from the rectangle could be anticipated by the dominant perceptual feature of the longer sides of the rectangle. However, in some cases it could be that a child would project the shadow of the rectangle and identify the line required with one side only of the rectangle, ignoring the remaining three sides.

Methods of Solving the Problem

Methods appropriate to each shape are listed in Summary 1, page 36.

(b) The Complex Closed Figures

When the card displayed a diagram with a square as the boundary, the solid selected should have a square as one of its features. This restricts the choice to either the square pyramid or the octahedron. The selection of one of these would then be suggested by the simplicity or complexity of the interior of the diagram.







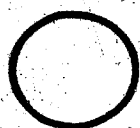

The choice of the triangular pyramid as the means of constructing the first two diagrams would tend to suggest that the subject is concentrating on the interior of the diagram and not the diagram as a whole.

Methods of Solving the Problem

There are numerous simple and complex procedures, and the following statements simply identify some expected methods.

Summary I

Methods of Solving the Simple Closed Figure Problem

Given Frames	Required Shape	Discussion of Required Operations	Transformation
	<p>1. </p>	<p>To obtain this shape the circle should be tilted about a horizontal axis parallel to the screen.</p>	<p>Projective - affine</p>
	<p>2. </p>	<p>This shape is formed by a rotation of the rectangle about a vertical axis from a position parallel to the screen, followed by a slight rotation about a horizontal axis.</p>	<p>Projective - affine</p>
	<p>3. </p>	<p>The equilateral triangle is used to produce this figure - direct projection.</p>	<p>Euclidean</p>
	<p>4. </p>	<p>Each of the given frames will produce this straight line when the plane of the frame is horizontal.</p>	<p>Euclidean</p>

1. Superposition

The subject would hold the wire frame so that the shadow cast falls on the card illustrating the shape to be made. Manipulation of the selected frame would indicate an effort to produce the desired shape.

2. Manipulation

The frame which appears to resemble most closely the given shape is selected and the shadow formed by holding the frame in the beam of light compared with the given shape. If the shadow cast does not match the given shape the subject may do one or more of the following:

- (i) transform the shadow by some manipulation of the frame - rotation about a horizontal, a vertical or an oblique plane, etc.
- (ii) replace the wire frame with another
- (iii) withdraw from the problem.













Methods appropriate to each of the individual problems are listed in Summary 2, page 38.

3. The Mirror Reflection Problem

When a ray of light is reflected from a smooth, flat (i.e. plane) surface, experiment shows that the angle of the incident ray I , is equal to the angle of the reflected ray I' . It is customary to measure these angles from a line perpendicular (normal) to the plane of the mirror (Huyghens, 1697, p. 5). This law of reflection was generalized by Snell to include reflecting and refraction of

SUMMARY 2

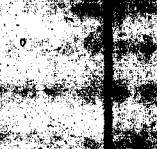
Methods of Solving the Complex Problems

Object	Resulting Shape	Discussion of Required Operations	Transformation
		The square pyramid should be held with two adjacent oblique sides parallel to the light beam.	Projective - affine
		To project this shape, the square pyramid should be held with one oblique face horizontal.	Projective - affine
		This is formed when the base of the triangular pyramid is horizontal and two oblique edges parallel to the light beam.	Projective - affine
		The tetrahedron forms this shape when the base is horizontal and one edge of the base is perpendicular to the light beam.	Projective - affine
		The square pyramid held with the square base perpendicular to the light beam.	Projective - affine
		The cube should be held with one axis vertical and the other axis oblique to the beam of light.	Projective - affine

light in media of different refractive indices. Thus Snell's law is simplified to the form

$$n \sin I - n' \sin I' = 0$$

where n and n' are the respective refractive indices. This law also is consistent with Fermat's principle which states that the optical path of a ray is at a stationary value, that is, the length of the optical path between an object and its image is a minimum.

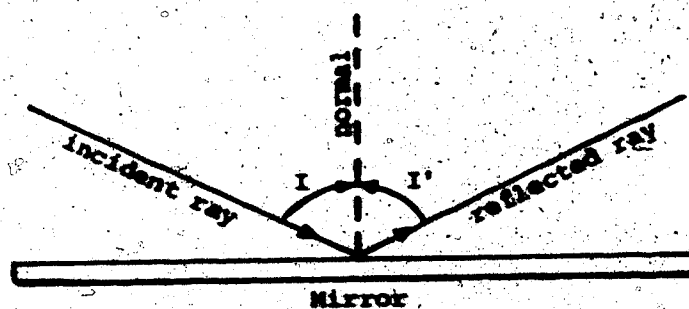

The image of an object observed in a mirror is in fact a virtual image, appearing to be behind the mirror, and at a distance from the mirror equal to that of the object in front of the mirror. The following diagram illustrates this fact.

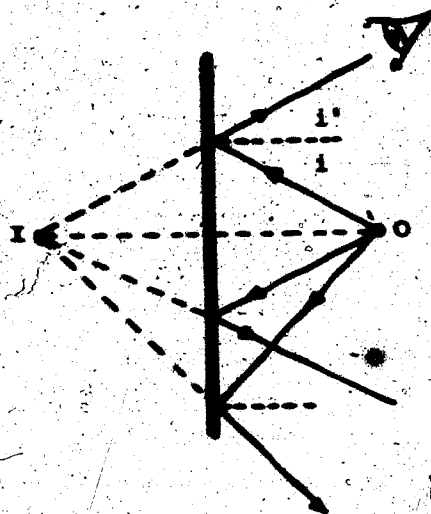

The solid lines represent the real rays. The dotted lines represent the rays which appear to emanate from the image I.

When two mirrors are placed at an angle to each other, the object and all its images lie on a circle, the centre of which is the point of intersection of the two mirrors.

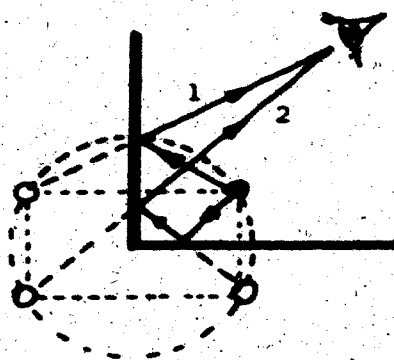

When the two mirrors are at 90° as shown in this diagram, three virtual images are formed. Path 1 shows the path of a ray from the object to the eye which makes one reflection, while path-2 is that of a ray which makes two reflections between the object and the eye.

The problems involving reflection of light from a mirror will be considered in two separate cases.

Case I. Light Ray Making One Reflection

A minor modification to the above theory is required to meet the facts of the situation. A light source projects a ray of light which is reflected from the mirror. The task requires the subject to rotate the light source until such time as the light illumines an object (in this case a silhouette of an animal). Since

the light source is to be rotated, a schematic diagram of the situation will indicate the strategy required to move the spotlight in one direction or another.

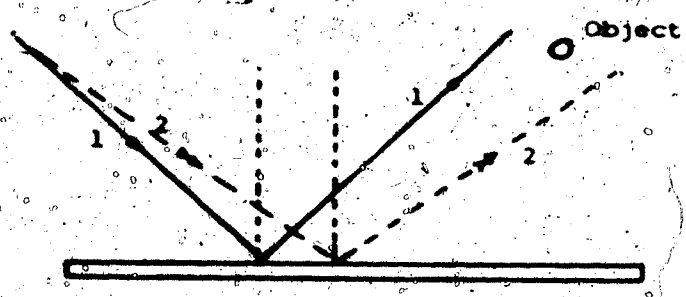

From this diagram it can be seen that a rotation of the light source towards the object results in the reflected light ray moving towards the object.

Case II. Light Ray Making Two Reflections

The task is similar to that of case I, except that the ray of light is required to reflect off two surfaces before illuminating the object. The next diagram illustrates the strategy required to solve this problem.

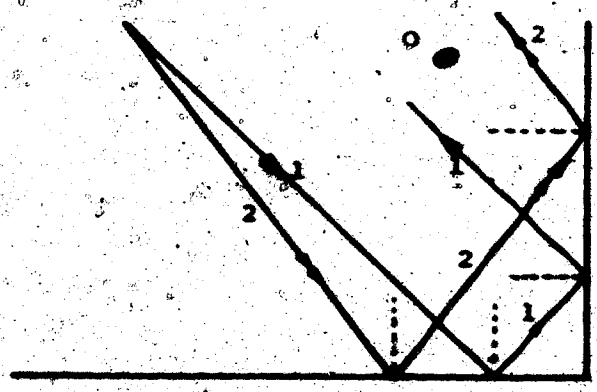

It can be seen that a rotation of the light source towards the object causes the reflected light ray to move in the opposite sense to that illustrated in Case I.

Summary

The situations in which the subjects found themselves may be summarised in the next diagram.

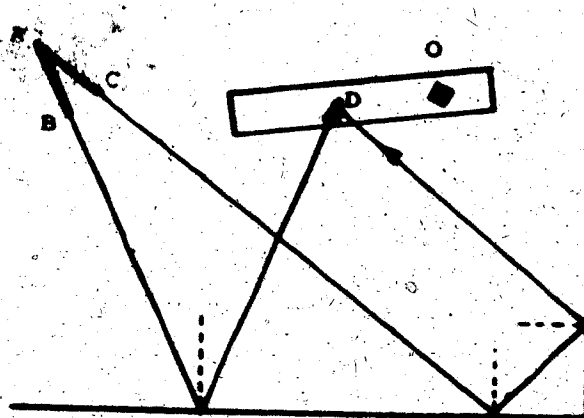

Thus, to move the spotlight D to O after one reflection, the light source AB has to be rotated in an anticlockwise direction. To move the spotlight D to O after two reflections, the light source AC has to be rotated in a clockwise direction.

4. The Object Reflection Problem

The principles outlined above for the reflection of a light ray off one or two mirrors apply in exactly the same way to the reflection of a steel ball propelled towards a rubber wall and bouncing off one or two rubber walls. The strategies indicated for changing the direction of the light source in order to effect a change in the position of the spotlight are identical with those

required to direct the steel ball towards a target, for the corresponding number of reflections. Thus the Object Reflection problems and the Mirror Reflections problems should be regarded as multiple embodiments of the same fundamental principles. As the number of reflections of the light beam increases, the intensity of the spotlight decreases. Similarly, the more bounces made by the steel ball, the slower the velocity of the ball.

Methods of Solving the Reflection Problems

Since the physical principles are the same for the mirror reflection and the object reflection tasks, their solutions will be considered together. In each case the subject has the opportunity to receive immediate feedback or reinforcement of the correctness or otherwise of his actions.

Thus, the rotations of the shooter in the object reflections task and the corresponding paths of the ball are such that information may be received by the subject which leads to a more accurate aim of the problem solver. Of course this only applies if the feedback is adequately processed by the subject. On the other hand, if the information received by the visual senses is not processed, that is, it is not meaningful to the subject, then he may arrive at a solution by a process of random actions.

The light beam can also convey information to the problem-solver in that the movement of the spotlight can be immediately related to the rotation of the shooter. A subject obtains immediate reinforcement of the results of his action, and can make a rapid change of plans before the first action is completed.

Whereas the object reflections task consists of a number of separate, discrete shots, the mirror reflection task involves a number of actions of a continuous nature providing for more rapid and accurate rectification of solution tasks.

THE LONGITUDINAL STUDY

The study of Nelson and Savada (1974) was designed to extend over two summer sessions. In the first of these, the children were to attempt to solve six problems, comprising four different problems and the equivalent problems to two of these. In the second session the following year, each child would encounter the problems equivalent to those met in the first session. A schedule of the allocation of problems within each age group may be found in Appendix F.

THE PILOT STUDY

During the months of May and June 1974 a number of children within the age range 3-8 years were recruited through the assistance of university staff and graduate students. The purposes of this pilot study were to:

1. find the most satisfactory form of the problem protocols.
2. develop management skills within the studio which had been set up for the project.
3. develop team skills with camera crew, videotape recorder operator, and ancillary staff for moving the problem materials.
4. identify the most suitable positions for the two cameras

so that the data collected on videotape was maximised and relevant.

5. determine some idea of the time required by the children to solve the problems presented.
6. ensure that the problems met some of the criteria of 'good' problems.

The pilot study served all these purposes. It was decided that, for reasons of expediency, the interviewer could intervene if the child either failed to make any response or continued to make responses which were unproductive. This was necessary in order to limit the time for each child to one hour; and to accommodate to the amount of videotape available for the project.

In the early deliberations on the project it was intended that 72 subjects would each be required to do eight problems, six different problems and the equivalent problems to two of these. However, it became obvious quite soon during the pilot study that such a number of problems was beyond the capacity of both the children and the available time. Thus this number of problems was reduced to four different and two equivalent problems.

THE SAMPLING PROCEDURES

A total of 600 notices were distributed to parents of children in grades one, two or three in five elementary schools and two day-care centres close to the University. These notices invited parents to permit their children, ages 3 to 8 years, to participate in a problem-solving research program planned for the summer of

1974 and 1975. Fifteen children from each age level, making a total of 90, were deemed a sufficient number to satisfy the requirements of both the cross-sectional and the longitudinal studies. The age range 3-8 years was selected as appropriate since this would likely include some children whose ability to solve the problems was minimal, and yet would also include some who could display considerable mastery of the necessary skills.

Except for the 3 year olds, sufficient numbers of children were volunteered by their parents to allow selection of the children by random sampling. A table of random numbers was used to make the selection. Because an insufficient number of three year olds resulted from the advertising, the remainder of the 15 needed were obtained by personal requests.

The allocation of sets of problems to the children within each age group was randomized by the procedures adopted. These sets were numbered 1-15 according to their occurrence in the systematic table used to construct the sets. The parents of the children selected for the project were contacted by telephone in the order in which their applications were received, and a schedule of appointments was thus compiled. The first appointment was made for June 24, and the final interview was held on July 23, 1974.

For each age group a child received a problem set based on his order in the interview schedule. Thus, for 4 year olds, the first child to be interviewed was presented with problem set #1, the second child with problem set #2, etc.. (See Appendix F.)

THE INTERVIEWS

The interviews were scheduled so that a maximum of five children would be encountered in one day. There were three sessions in the morning and two in the afternoon. Special care was taken to interview the three year old subjects in the mornings to avoid the effects of fatigue.

When the child arrived for his interview efforts were made to make him feel at ease. If the child appeared reluctant to participate, he was introduced to one of the problems which would not be met by him in his program. This proved to be a useful strategy in the small number of cases where it was implemented.

Two interviewers shared the task of presenting the problems to the children. Dr. L. D. Nelson was one of these interviewers, the other Mrs. M. Mallet.

At the completion of each problem the materials were moved from the table by the ancillary staff, and replaced by materials for the next problem. The children did not appear to find the presence of these people or the movement of the materials to and from the table of a distracting nature.

The child was allowed a brief time before each problem in which to become acquainted with the materials. Indeed the protocols provided for an introductory exercise to enable the child to discover something about the materials used in the problem-solving tasks.

RECORDING THE BEHAVIORS

The apparatus for each problem was placed on a low table so that a child could either sit on a chair or stand up while he solved the problem. During the solution two videotape cameras were used to record the behaviors of the child. The deployment of these cameras was such that for most positions taken up by the child, it was possible to capture his actions on tape. A split image device made it possible to record simultaneously the actions observable from different directions. Sony video cameras were used to record the behaviors on new format 1/2 inch magnetic tape using a Javelin Videotape Recorder. A total of 54 one hour tapes were used to record the full project.

Two videotape cameras were situated so that it was possible to record a wide range of behaviors. A microphone was suspended from the ceiling so that verbalizations by subject and interviewer could be recorded. This was preferred over the use of lapel microphones to reduce the distractions present in the room. There were many times however, when the child's verbalizations were inaudible, or indistinct because of other sounds present at that time.

ANALYSIS OF THE BEHAVIORS

The purposes of the study included listing a catalogue of behaviors generated by these four problem-solving situations. It was necessary therefore to note carefully those behaviors displayed by the children. Many hours were spent previewing the tapes prior to the actual transcription of the behaviors to determine which were

significant for this study and to devise a code for the transcription.

The code constructed for this purpose enabled a record to be made of frequently and rapidly occurring behaviors for future analysis. Some of these behaviors, such as verbalizations, were sufficiently common for the same coding to be used in the analysis of a number of different problems. In others the behaviors were of a physical nature which required unique notations or full descriptions.

In devising a coding system for this transcription task, attention was given to the need for a system which could be used by other investigators, and indeed, by others not necessarily skilled in the particular research techniques developed through acquaintance with this project. Thus a code which employed symbols with obvious connotations was evolved and may be found in Appendix B.

VALIDITY AND RELIABILITY

In their study of the growth of the child's conception of space, Piaget and Inhelder (1956) investigated the ability of children to envisage the results of unfolding a cube and a tetrahedron and also a cylinder and a cone. Children were asked to draw the shape each solid would assume "if we open it out flat on the table (p. 274)." Classification of the subjects into stages of development hinged on two major criteria, namely, children's ability to draw objects from their imagination, and their ability to be able to discriminate between the intact and the developed solid. The ages of the children observed by Piaget in these studies ranged from five to sixteen years.

Earlier, more fundamental studies into children's coordination

of perspectives and the projection of shadows cast by a pencil (a straight line) and a disc (a circle) were also reported by Piaget and Inhelder (1956, p. 200). In a later publication (1958) the Geneva researchers described the results of their study of children's conception of the equality of angles of incidence and reflection.

The Piagetian origin of the basis of the problems investigated in this study is acknowledged. However the materials devised for the fold-out shapes problems provide tangible representations of the solids. Thus the limitations imposed by the lack of motor and coordination skills needed by children to draw their representations are avoided. These problems required children to discriminate between shapes which would fold up and those which would not fold up to a solid.

The problems of this study were also designed by Nelson and Saeeda (1974) to conform with the criteria for "good" problems which were proposed by Nelson and Kirkpatrick (1975).

An explicit statement of the procedures used in obtaining a written form of the data was necessary to provide a basis for evaluating the data collection and the reliability of the records made.

In this study the behaviors of children in problem-solving situations was the subject of observation. The analysis of these behaviors depended on the accurate recording of these behaviors by the Videotape Recorder and the reliable transcriptions of these onto paper. Kerlinger (1973) states: "A simple aspect of the validity of observation measures is their predictive power. Do they depict any relevant criteria dependably? (p. 539)." A measure of the validity

of the observations measured in this study will be more readily attained through the longitudinal project of Nelson and Sawada (1976), when the behavior of the sample of subjects involved in the summer sessions of 1975 are compared with those of the present sample.

Referring to the difficulties inherent in recording data on videotape, Nelson and Sawada (1975) referred to (i) the behaviors exhibited by children in the interview situations and (ii) the limitations imposed by the TV camera. They wrote:

The behavior of children when a camera is trained on them may not always be the same as it would be without the camera. Also there is a necessity to introduce extra people and apparatus into the situation which may distract the child. Fortunately . . . the problems were attractive enough to most children that such distractions were minimal. Another difficulty is that the behaviors have to occur in a relatively small space (p. 36).

The advantages accruing from the storage of data on videotape were also listed by Nelson and Sawada (1975). Particular reference was made to reliability in the interpretation of data and the retrieval of data. They commented:

One doesn't run into the same problem of reliability in the interpretation of the data as is usual with other methods of observation. If there is a question, one can always return to the actual event simply by running the tape through again (p. 36).

There have been a large number of observation instruments developed to record the interaction between pupils and teachers in instructional situations. Technical difficulties associated with these have been discussed by McNeil and Popham (1973). None of these instruments seem to have much application in the study reported here.

On the other hand, reliability is usually defined as agreement among observers (Kerlinger, 1973, p. 340), and may be usually assessed by correlating the observations of two or more observers, or by the percentage of agreement between observers.

For the purpose of this study two other observers were enlisted, one a master's and the other a doctoral candidate. Percentages of agreement were calculated between the investigator and these two observers. A random sample of subjects from the eye groups was chosen, the task being the fold-out shapes problem. Before these observers commenced their transcriptions, observations were recorded on one subject. These observations were discussed with the investigator and a comparison made with the records made by him. Sources of disagreement were identified, and clarifications of terms used in the coding system supplied to them indicated a basic agreement existed as to what was being coded.

The procedures adopted for recording the data on the tapes will be discussed for each individual problem.

The fold-out shapes problem consisted of ten separate tasks, six associated with the cube, three with the tetrahedron, and one with the dodecahedron. An analysis sheet listing each of these and its appropriate diagram was drawn up. This allowed for a record of the behaviors of each subject to be made. Each task was viewed completely at least three times, attention being paid to (1) the order in which each piece was transferred, (2) the manipulations used in making these transcriptions, and (3) the manipulations which occurred during these manipulations. An analysis sheet was prepared

as possible sections of tapes were replayed. The time taken to complete a transcription of this problem was seldom less than 75 minutes, and was usually in excess of this time.

A similar procedure was adopted for each of the other problems. With the projected shapes problem, the time taken to reach a solution, the shape selected, the final shape formed and its disposition required at least two viewings. Then manipulations, eye movements and verbalizations demanded at least another viewing. The remainder of the analysis sheet was then completed.

With the object reflections problem, separate viewings yielded data on the time taken for each shot, the manipulations made and results of each shot, and the verbalizations occurring throughout the procedures required three viewings, interspersed with frequent stops and refunds.

The difficulties inherent in the mirror reflections problem demanded very patient and close viewing. Since the action had to be recorded in a semi-darkened room it was not always possible to identify all the behaviors of the subject, and sometimes reliance had to be placed on the verbal interaction and reactions of both subject and interviewer as to the result of a particular action.

An explicit statement of the procedures used in obtaining a written form of the data was necessary to provide a basis for evaluating the data collection and the reliability of the records made.

DATA ANALYSIS

The data gathered for this study consisted of

- (i) the physical manipulation of individual subjects while they were involved with four spatial relationships problems,
- (ii) their verbalizations during the process of solving these problems, and
- (iii) the times taken for specific tasks to be completed and for specific behaviors to take place.

The information stored on 54 one-hour videotapes was used to develop a written, coded, transcript of the above behaviors. Comparisons were made by tabulation of intra-group and intergroup behaviors and performances on each of the four problems. Comparisons of performances and behaviors of individual subjects solving two or more problems were also investigated.

Chapter III

RESULTS OF THE INVESTIGATION

The problems which were investigated consisted of two pairs of related tasks. The fold-out shapes problem was given to sixty subjects, 30 of whom were also given the projected shapes problem. These problems involved transformations of two and three dimensional shapes. Another group of 60 subjects were given the object reflection problem and 30 of these also attempted the mirror reflection problem. These two problems involved different embodiments of the same problem, namely, the path traced out by a moving object under one and under two reflections.

The results of the investigation will report on the following questions:

1. Can children 3-8 years of age perform the tasks involved in these problems? If so what developmental differences are observable?
2. Was a pattern of prediction behaviors observable with this sample?
3. What behaviors were exhibited by the subjects during the solutions to these problems?
4. Was there any evidence that the subjects perceived some logic in the folding procedures? If so what did it indicate?

I. THE SHAPES PROBLEMS

The Cube - Problems A-D

The fold-out shapes problem consisted of a series of separate problems. A subject was required to:

- Predict if a given layout of squares would fold to a cube.
- try to verify his prediction.
- if it did not fold to a cube, to perform a transformation on the layout which would result in a fold-up.
- assemble a set of four equilateral triangles into a tetrahedron.
- predict if two layouts of four triangles would fold into a tetrahedron.
- dismantle a dodecahedron, predict if it will fold back into a dodecahedron and then assemble it.

The first tasks involved four layouts of six squares. These forms, A, B, C and D, all folded to a cube. Tasks 5 and 6, with shapes E and F did not fold to a cube. Shapes A-D were:

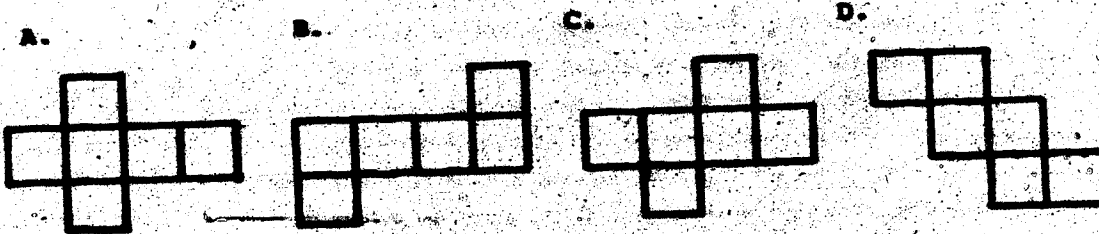

Shape C was representative of forms where the side squares were offset and was presented in three formats. The frequencies of presentation for these formats of shape C are shown beside each diagram:

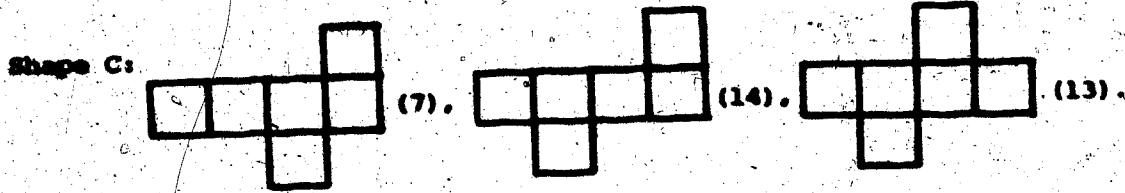

Each subject was handed a 10 cm cube made from squares of Plexiglas held together by strips of Velcro, and was asked to unfold it. On completion of this the subject was asked to fold it back to its original shape. A wire frame model of a cube of the same dimensions was placed on the table to remind the subject of the original shape. The frame was drawn to the subject's attention initially, but few gave obvious indications that they were carefully inspecting it. One 3-year-old pointed to the frame, one 4-year-old picked it up and held it to his face and looked at the interviewer through it, and another 4-year-old tried to fold a shape around the frame. Two 5-year-olds, three 6-year-olds and a 7-year-old studied the frame during their fold-up activities. However, the position of the frame with reference to the fold-out shape was such that it could have been within a subject's span of vision and visible without any obvious eye movements being made.

The number of problems presented varied from subject to subject. For example, if a subject showed no comprehension of the tasks, the interviewer curtailed the number of problems given. This was the case with two 3-year-olds who were each given two problems, after which the remaining problems related to the cube were abandoned. Another 3-year-old frequently looked around and enquired for her mother and brother. She was given problem A, then problems E and F. The record for one 4-year-old began as he was about to attempt

problem D, after which he continued with problems E and F.

Other subjects who demonstrated an understanding of the problems and displayed some control of the apparatus had the number of problems A-D curtailed. A 7-year-old boy was first presented with shape D and predicted that it would not fold up. After demonstration by the interviewer that it would, he was then given problems E and F. The remaining subjects completed at least two of the problems A-D prior to proceeding with E and F.

When the preliminary exercise resulted in the formation of one of the shapes A-D, that shape was not always presented again to that subject. This occurred 12 times in all. Partly as a result of this, the order of presentation of the problems A-F varied from subject to subject. The number of subjects to whom the shapes were given is listed in parentheses beside each problem: A (53), B (48), C (34), D (50), E (57) and F (57). Table 1 indicates the frequency with which each problem was presented in a particular order, i.e. as a preliminary exercise, as first problem, or second problem, and so on.

Thus 49 subjects encountered shape A either as a preliminary exercise or a first problem, and three were given this shape as their second. One subject met shape A as his third problem. Shape B was presented as either second or third problem with only two exceptions, when it was the first problem. Shape C was also encountered, generally, as either second or third problem. Shape D was met in one of the positions preliminary to 5th, with the general position being 6th. In three cases, E and F occurred as second and third problems

TABLE 1
DISTRIBUTION OF FREQUENCIES FOR ORDER OF PRESENTATION
OF FOLD-OUT SHAPES A-F

Shape	Order of Presentation						
	Prelim.	1st	2nd	3rd	4th	5th	6th
A	8	41	3	1			
B		2	26	20			
C	3	2	18	11			
D	1	3	10	8	27	1	
E			3	15	12	26	1
F				3	16	12	26

respectively, but in the main they occurred as problems 5 and 6. Altogether, two subjects were given two problems, three were given three problems, 16 encountered four problems, 12 had only five problems, while 27 were given all six problems. The subjects in each age group who completed two, three . . . six problems are listed in Appendix F.

The Results

The following results are based on the numbers of subjects who were presented with the individual problems. During the fold-up activities subjects needed assistance from the interviewer. This assistance took these forms:

- a. support, during which the interviewer held up squares which the subject had already raised,
- b. verbal cues, by which the interviewer suggested that a side (or sides) be raised, or suggested that parts be pushed together,
- c. nonverbal cues by which the interviewer rotated the assembly to facilitate the solution, or raised one (or more) sides.

The interviewer usually told the subject to ask if he/she required assistance such as a. This occurred when the squares raised did not meet and remain upright. Such support released a subject's hand to enable him to pursue his solution to the problem.

The number of assists given a subject was the basis for devising the following categories of solution for shapes A to D.

- I. S does not fold up shape.
- II. S folds up shape with more than one cue.
- III. S folds up shape with only one cue.
- IV. S folds up shape with support only from E.
- V. S folds up shape with no assistance.

Table 2 shows the distribution of boys and girls in each age group 3-6 years and their solution categories for shape A. Almost three-fourths (74%) of subjects (N = 53) from all age groups were able to fold this shape without any assistance. The interviewer helped 9% by holding up squares which had been raised by them. Verbal and nonverbal cues which resulted in squares being raised and partially completed parts of the box brought together were supplied to 11% of subjects. One 3-year-old who had folded the squares one on top of the other to form a pile or stack was helped to complete the box as a joint effort by subject and interviewer. A 6-year-old persisted with the piling behavior despite the interviewer's cues.

Table 3 presents the distribution of subjects and their solution categories for shape B. More than half (60%) of subjects (N = 48) folded this shape without assistance. Of the subjects listed in category I, a three year old sat and looked around the room without attempting to raise a square, while another three year old detached a square, superimposed it on another, and then proceeded to form an open box. Two boys, four and six years of age, and a five year old girl folded the squares through 180° to form piles of squares. Another five year old girl removed a square and modified the shape to

TABLE 3
 DISTRIBUTION OF SOLUTION CATEGORIES
 FOR SHAPE B
 (N = 48)

Categories of Solution

V	N P	N	N P	N P	N P	N P	N P
IV	N	N	N P				
III				N P		N P	
II		P	N P			P	
I	N P	N	P	N			
	3	4	5	6	7	8	

N: Boy
 P: Girl

a row of five squares with one on a side (shape E). After verifying that this would not fold she made another modification to shape A which she then folded to a box. One or more cues were required by 19% of the subjects given this problem.

The distribution of subjects in the solution categories for shape C is shown in Table 4. Of the subjects (N = 34) who formed this shape, 65% did not require any assistance. Squares were once more folded to form piles by a three year old boy, and a three year old girl folded the squares from each end to form "a wallet." Another three year old boy detached a square and reformed shape A which he then proceeded to fold into a box.

Shape D was folded without assistance by more than half the subjects (N = 50). Table 5 shows the distribution of subjects for this problem, with 60% in category V. The percentage of subjects who needed the interviewer to support raised squares with shape D was double that for any of the shapes A, B or C. This occurred because subjects who raised one square of the layout tended to leave that square and begin raising squares at the other end of the layout. One seven year old boy predicted that shape D would not fold up, but did not verify his prediction.

The percentage of subjects in each solution category for the four fold-out shape problems is listed in Table 6. Solutions classified in categories IV and V did not require any cues or assistance from the interviewer, and therefore were considered to be adequate solutions. The percentages of subjects shown in Table 6 clearly indicate that a majority of the children in this sample was

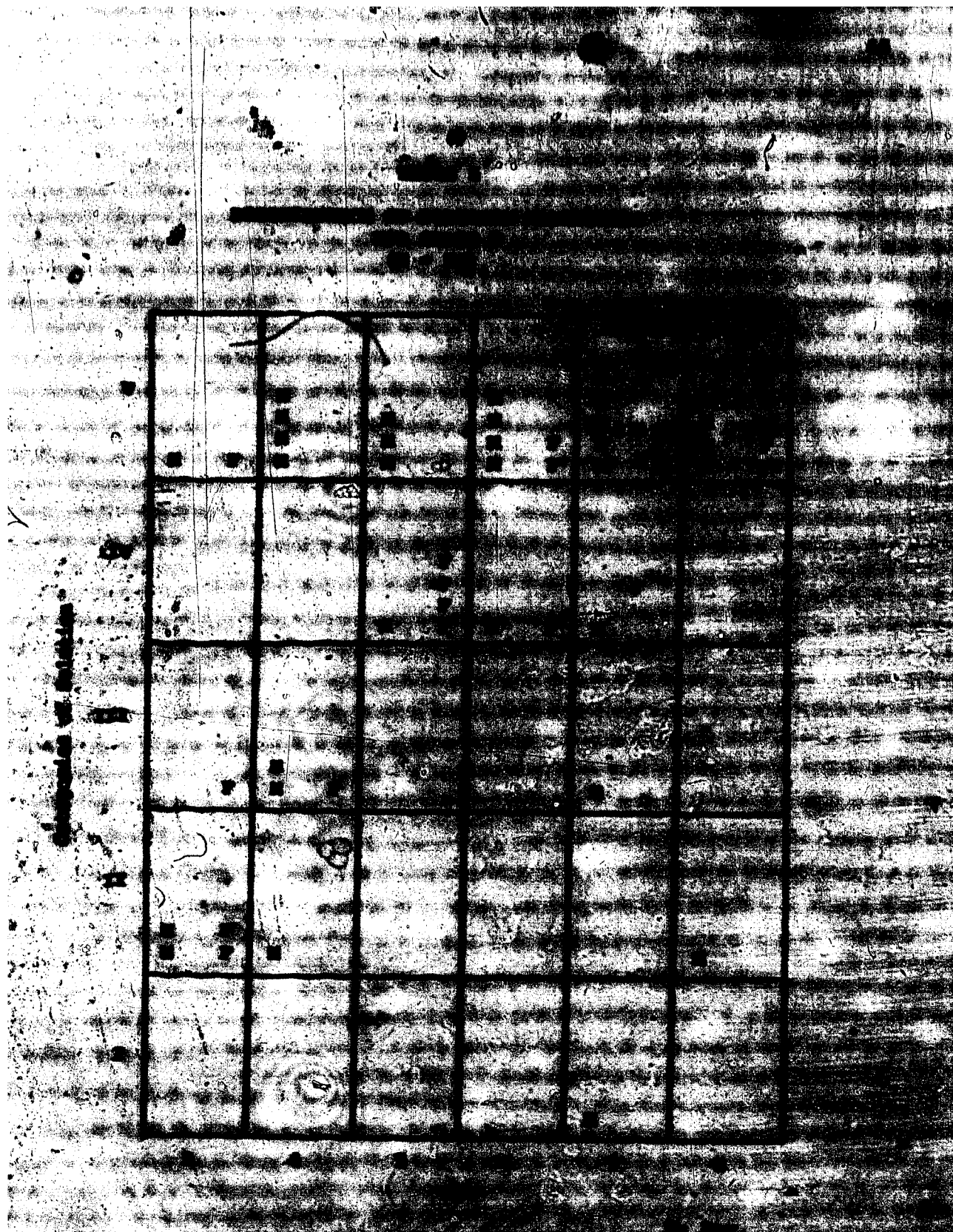

TABLE 6
PERCENTAGE OF SUBJECTS IN EACH SOLUTION CATEGORY
FOR PROBLEMS A, B, C, D

Shape	Category of Solution				
	I	II	III	IV	V
A	1.9	11.3	3.8	9.4	73.6
B	12.5	10.4	8.3	8.3	60.4
C	5.9	17.6	5.9	5.9	64.7
D	2.0	12.0	10.0	16.0	60.0

able to do these problems.

Predictions

The protocols for these problems provided for each subject to be asked to predict whether or not the given shape would fold up into a box. The question "Can you fold this up into a box?" was occasionally replaced by "and what about this one?" once the subject was familiar with the interview procedures. In sixteen instances the subject was not asked to predict, but instead was asked to "see if you can fold this one up into a box." Subjects responded to the question with verbal and nonverbal replies which were categorized as 'YES,' or 'NO' or 'NO REPLY.' The latter response was received from 39% of subjects who were given problems A, B, C and D.

Prediction responses for shapes A-D are illustrated in Figure 5. The correct prediction 'YES' was given by more than 39% of subjects in each age group, and exceeded 50% for six and eight year olds. The following patterns appear in the graph for shapes A, B, C, D.

1. The frequency of 'NO REPLY' responses decreases as the age increases from four to eight years.
2. The 'YES' responses exceed the 'NO' responses at each age level by at least 30%, except for the five and seven year olds, where the excess was 9% and 11% respectively.
3. The highest percentages of correct responses occur for the six and eight year olds.
4. The low percentages of 'NO' responses for three and four year olds is offset by the higher percentages of 'NO REPLY'.

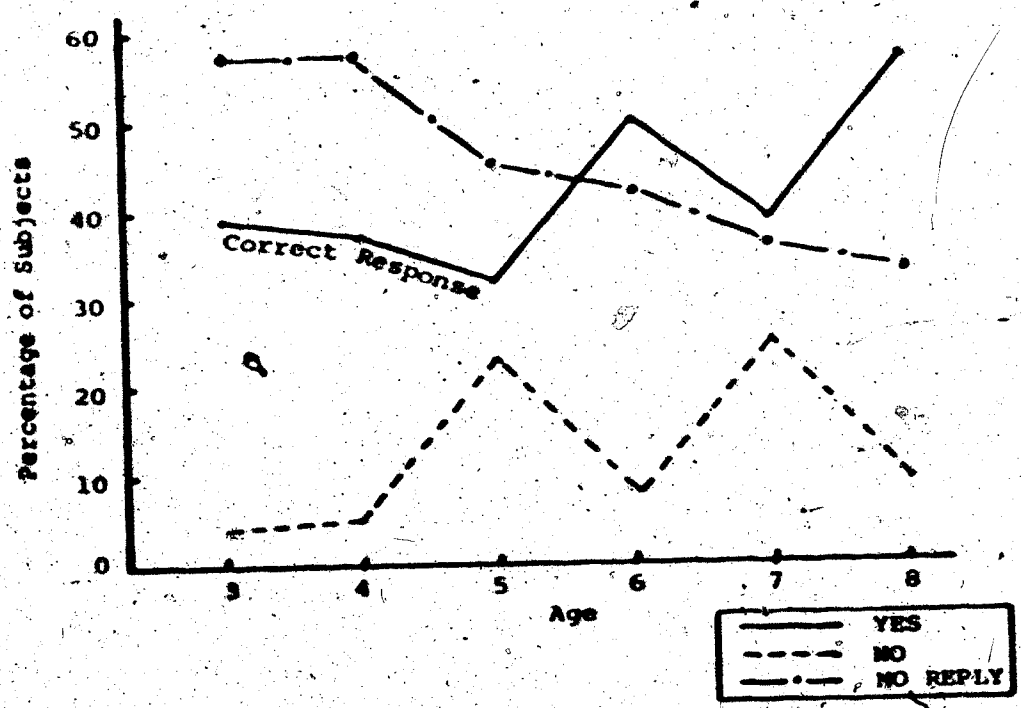

FIGURE 5

PREDICTION RESPONSES FOR SHAPES A, B, C AND D

responses at these age levels.

The Cube - Problems E and F

After experience with shapes A-D, 57 subjects were then presented with shape E and shape F. The layouts for these were:

E



F



Shape E was presented in three different forms, all of which consisted of five squares in a row with another attached at the side. These formats and the frequency of their occurrence (in parentheses) are indicated below:



The analysis of the behaviors of subjects with these two shapes will be in terms of their predictions about the foldability of the shapes, and the modifications performed on the shapes to obtain a layout which will fold up.

The Predictions

Whereas the shapes A-D all folded into a cube, neither E nor F were foldable. On the presentation of each shape subjects were asked "Can you fold this shape up into a box?" A total of 20 subjects did not respond to this question about shape E, and 21 subjects failed to respond about shape F. Eleven subjects were not asked to predict for shapes E or F.

The percentage of subjects at each age level with response categories 'YES,' 'NO' and 'NO REPLY' for shapes E and F are shown in Figure 6.

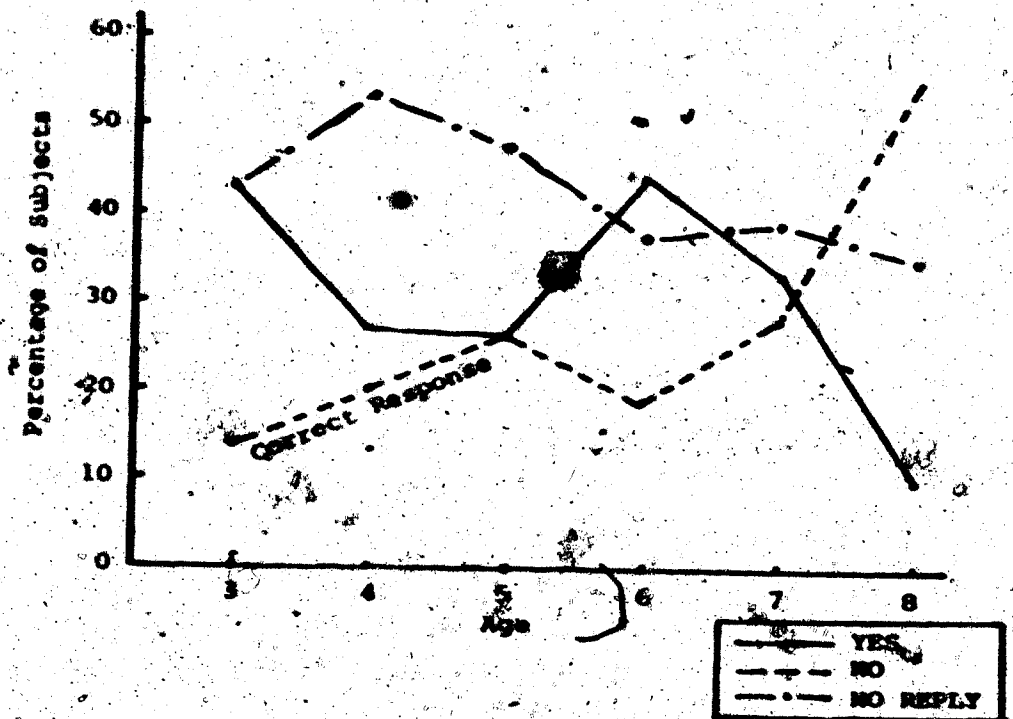

FIGURE 6
PREDICTION RESPONSES FOR SHAPES E AND F

Correct prediction responses were obtained by less than 30% of subjects at all age levels except eight years, where 55% predicted that shapes E and F would not fold. Patterns which appear in the graph for shapes E and F are as follows:

1. The percentage of 'NO REPLY' responses decreases as age increases from four to eight years.

2. The percentage of incorrect 'YES' predictions exceeds that of the 'NO' predictions at all age levels except eight years.
3. The percentage differences between the 'YES' and 'NO' responses displayed at each age level are less for shapes E and F than they are for shapes A-D (c.f. Figure 5).
4. Except for subjects age six years, the percentage of correct prediction responses increases with increase in age.

A comparison of the percentage of prediction responses for each category in shapes A-D and E-F is presented in Figure 7. The close relationship between the 'NO REPLY' responses for subjects four to eight years is illustrated in Figure 7a. Apart from the three-year olds, who showed a greater tendency to make a prediction about shapes E and F, subjects in the other age levels showed only minor variations in the 'NO REPLY' response for these two sets of problems.

The 'YES' responses for shapes E and F followed the same pattern as those for shapes A-D for all subjects except the eight year olds. Figure 7b shows that subjects tended to make the same predictions for shapes E-F as were made for shapes A-D, although the frequencies were approximately 5% less for the five, six and seven year olds. Only at age eight do the subjects show a marked recognition of the different nature of the two sets of shapes.

The differences in the 'NO' responses (c.f. Figure 7c) for age levels 4-7 years are not as consistent as they are for the 'YES' responses. This is accounted for by the variations, shown in

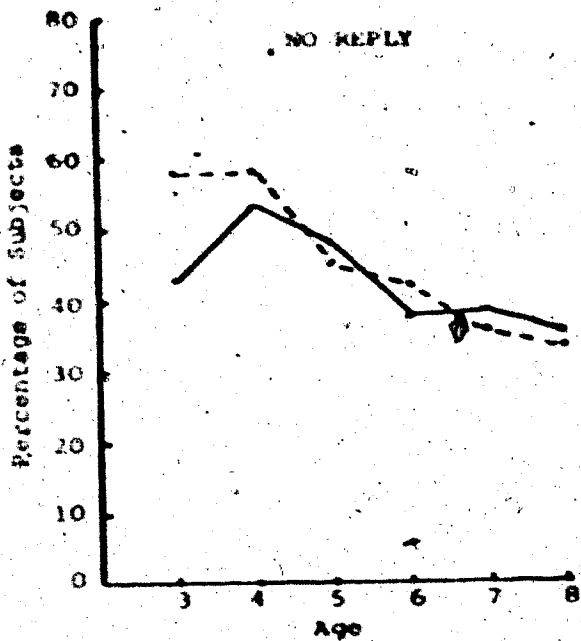

(a)

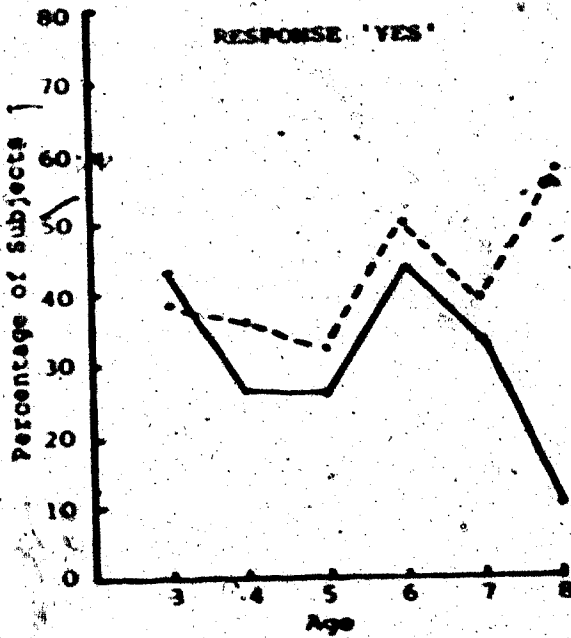

(b)

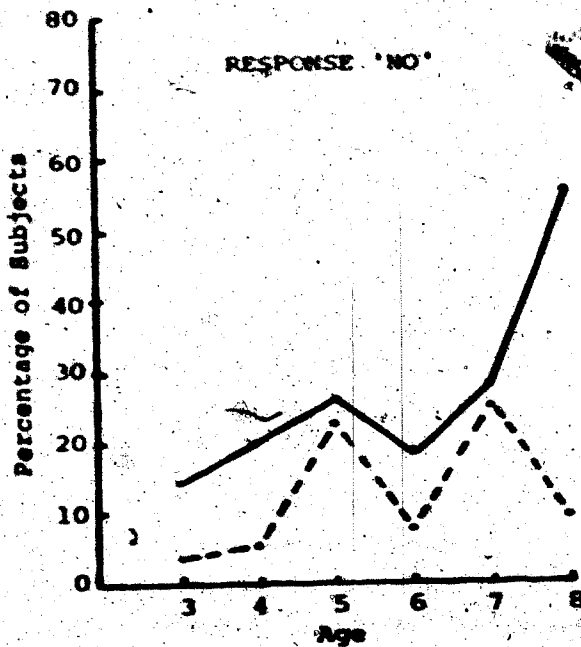

(c)

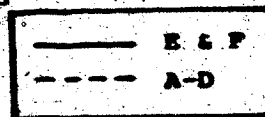

FIGURE 7

PERCENTAGE OF PREDICTION RESPONSES FOR FOLD-OUT SHAPE PROBLEMS

Figure 7a. of the 'NO REPLY' responses. The percentage of 'NO' predictions was greater at all age levels for shapes E and F.

In Figure 8 a comparison is made between the prediction performances of the sample for shape E and shape F. The broken line, of Figure 8a shows that three year olds gave the same percentage of 'NO REPLY' responses for both shapes. However the responses for F were less than those for E at the four, seven and eight year levels respectively. This means that a greater percentage of these age groups made predictions, correct or incorrect, for shape F than was the case for E. The five and six year olds, on the other hand, made 25% more 'NO REPLY' responses for the second problem than for the first, and as a consequence made fewer predictions about shape F than they made for shape E.

As indicated in Figure 8b, fewer incorrect predictions about shape F were made by all age groups than were made for shape E. Less than 30% of subjects at all age levels incorrectly predicted for shape F compared with more than 40% at all age levels (except eight years) who predicted incorrectly for shape E. The highest percentage of incorrect predictions came from the six year olds for shape E, and from the three year olds for shape F.

The percentage of correct predictions for both shapes are compared in Figure 8c. An increase of at least 30% in correct predictions at all age levels occurred for shape F, with the greatest increases (55%) occurring at the seven and eight year levels.

Trends shown in Figure 7 indicate that a mental set had been established through the experiences with shapes A-D which led

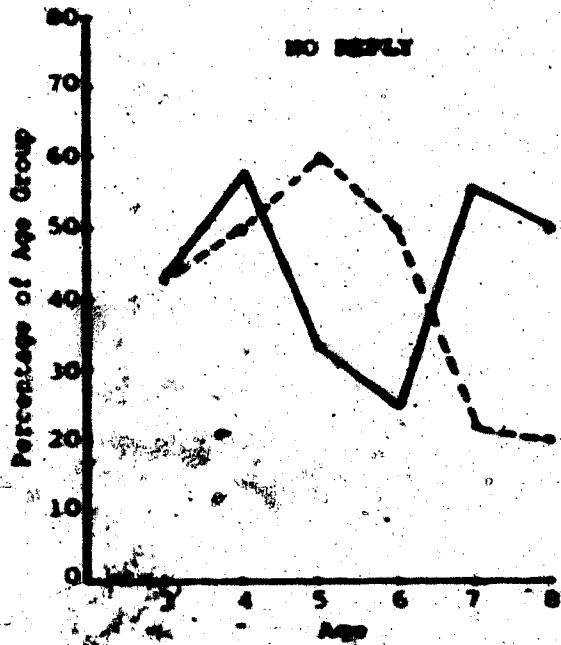

(a)

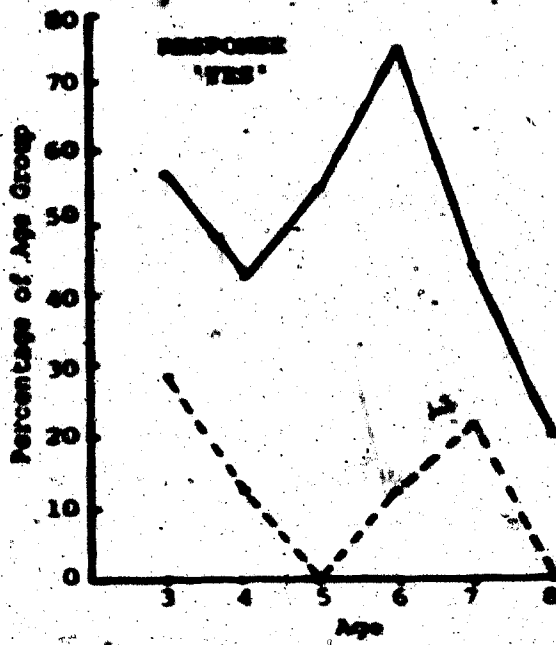

(b)

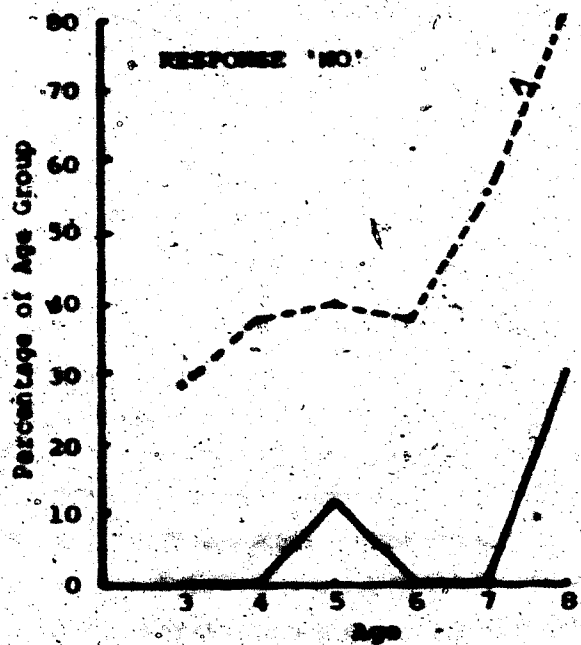

(c)

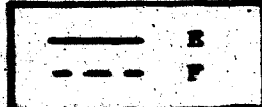

FIGURE 8

PERCENTAGE OF PREDICTION RESPONSES FOR SHAPES E AND F

subjects to expect that shape E would fold into a box. Figure 8 indicates that, except at the eight year level, this set is still present (but to a lesser degree) after one experience with a shape which did not fold. After the experience with shape E the eight year olds made fewer 'NO REPLY' responses, fewer incorrect responses, and as reported above, substantially more (55%) correct predictions for shape F than they did for shape E. It would appear then that the set was extinguished for the eight year olds.

However, the logic of the actual layouts should not be overlooked. Shape E was not very different from shapes A, B or C, since it had a square adjoining a row of squares. Shape F, on the other hand, consisted of a single row of six squares with no adjoining side squares, and from this viewpoint may be perceived to be less likely to fold than shape E, even without the experience with shape E. Thus the increase in the percentage of correct predictions for shape F may be due to one or both of two reasons, namely an extinction of a set established by experience with shapes A-D which did fold followed by shape E which did not fold, or simply the logic associated with the actual layout of shape F.

The Verifications

After subjects had been asked to predict if a shape would fold up the interviewer suggested that they verify their predictions. Some subjects, having made preliminary manipulations with the fold-out shapes, then changed their prediction, or if they had made no reply, then indicated that it would not fold. The number of subjects in each age group who changed their prediction about shapes E and F

is shown in Table 7.

TABLE 7
FREQUENCY IN EACH AGE GROUP OF SUBJECTS VARYING
THEIR PREDICTION FOR SHAPES E AND F

Shape	Age Groups					
	3	4	5	6	7	8
E	4	2	5	4	5	5
F	2	2	5	2	2	1

With the exception of the four and five year olds, there were fewer subjects in each age group who varied their response for shape F than there were for shape E. The smaller number of [redacted] for the seven and eight year olds was due partly to the decrease in the number of incorrect predictions for shape F and the smaller number of those who did not reply. Since 60% of five year olds had made no reply to the request for a prediction about shape F and none had predicted incorrectly, the prediction variations shown in the table came from subjects in the former group. The highest percentage of incorrect predictions for shape F came from the three year olds.

Six eight year olds and one five year old predicted correctly for both problems E and F, while 29 subjects who incorrectly predicted for E gave a correct prediction for shape F. Five subjects made incorrect predictions for both shapes. These consisted of two three year olds, one four year old and two seven year olds.

All subjects except those who predicted 'NO' were asked to

try to fold the shapes into a box. Twenty-three subjects folded the squares of shape E to form an open sided box with a square appended to one edge or superimposed on another square. These children knew the box was incomplete and indicated by word or gesture what was wrong with it. When children went as far as they could in forming the box and indicated that they could not complete the folding, the process was termed to be "structured." Trial and error efforts characterized by random folding and unfolding and which did not seem to reveal to the child what was wrong were called "unstructured" for the classification scheme shown in Table 8.

TABLE 8

DISTRIBUTION OF STRUCTURED AND UNSTRUCTURED VERIFICATIONS
OF PREDICTIONS FOR SHAPES E AND F

Shape	Type	Age Group					
		3	4	5	6	7	8
E	Structured	3	4	4	2	3	7
	Unstructured	4	6	6	7	7	3
F	Structured	6	8	8	5	5	4
	Unstructured	1	1	2	2	1	-

Verifications for shape E were predominantly "unstructured" except for the eight year olds. The verifications for shape F however, were predominantly "structured" for all age levels. This also suggests that the experience with shape E or perception of the logic

of the shape F format, or both, assisted subjects to identify shape F as unfoldable.

Modifications to Shapes E and F

Subjects were also asked to modify shapes E and F to a shape which would fold up. The interviewer asked each subject to identify a square (or squares) which interfered with the fold-up process and asked him to move the square(s) to a position which would permit the shape to fold up. These transformations generally resulted in the formation of one or other of the shapes originally presented, namely A, B, or C. Table 9 presents the frequencies with which shapes E and F were modified to shape A, B or C.

TABLE 9
DISTRIBUTION OF FREQUENCY OF FORM OF
MODIFICATION TO SHAPES E OR F

Shape	Modified Shape	Age Group					
		3	4	5	6	7	8
E	A	1	2	6	1	5	5
	B						2
	C		2	3		3	1
F	A	2	4	2	4	5	5
	B		1	3	1	2	1
	C		3	4	1	1	4

Of the 74 subjects who modified shapes E and F to one of the three fold-out shapes A, B and C, a total of 17 subjects made initial transformations which would not fold up, and then proceeded to make

correct modifications. Subjects not classified as such were not asked to make modifications. In 14 of the 21 cases (66.7%) the subjects did not make any modifications. In 7 of the 21 cases (33.3%) the subjects did make modifications. In 6 of the 7 cases (85.7%) the subjects made modifications to the squares in pairs (2 for E, 2 for F), or the problem was not presented (2 for E, 3 for F).

More than half (57%) of subjects who made successful modifications to shapes E and F transformed these shapes to the A format, and almost one third (30%) modified their shapes to C. Shape E was formed only twice as a modification to E since the side square occurred at the end of the format in only 20% of the presentations of this shape. Thus, in most instances of shape E, transformations to shape E would have necessitated moving two squares, whereas shapes A and C could be formed by moving only one square. Shape F modifications required two squares to be moved. Both shapes E and C occurred more frequently as a result of the transformations carried out.

With only one exception, subjects of all ages were able to correctly align the edges of squares when one corner of one square was directly above the corner of another square. The exception, a five year old girl, pointed both the squares so that they overlapped with two other squares. In the illustration she held this layout into a cube. A correct change to shape A layout by this subject was not observed.

The Folding Sequences

As each subject proceeded to form the box numerals were recorded in the squares corresponding to the order in which they were raised. Sequences varied from simple to complicated, and depended on whether or not the procedure brought adjacent squares into contact, thereby establishing some stable structure.

A. The sequences for shape A appeared as distinct groupings which are indicated by dotted lines in the diagrams below.

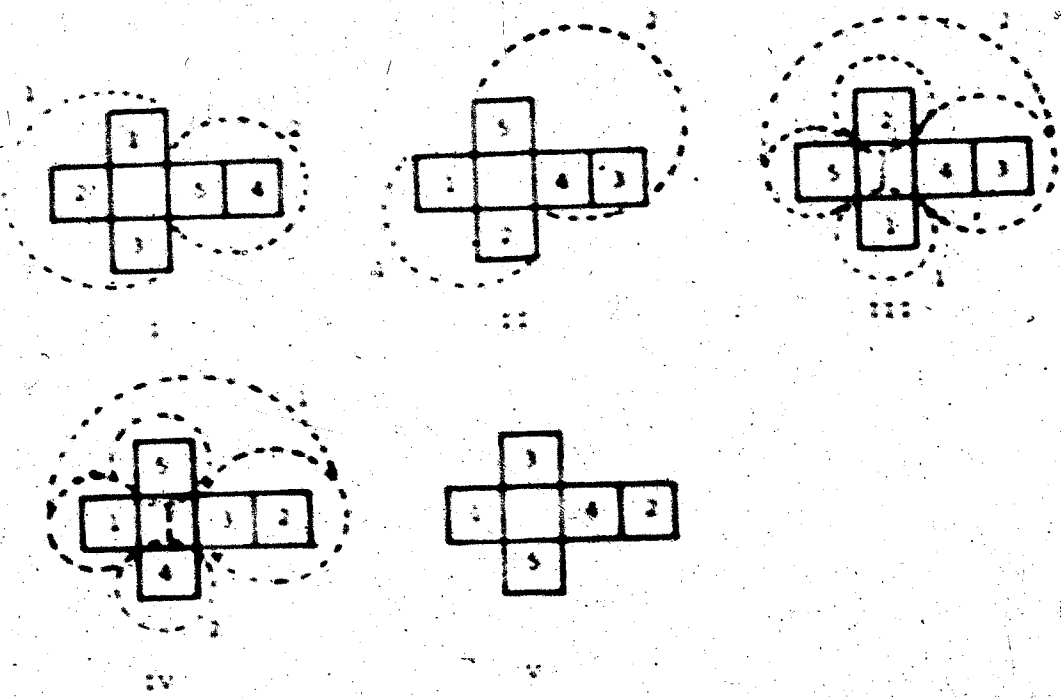

The squares in group 1 were raised first, followed by the squares in group 2.

In sequence I the raising of squares 1, 2 and 3 formed the outline of the box which enabled subjects to perceive the remaining steps required to complete the box. This also applied in sequence IV, but the latter required more manual dexterity to bring squares 1 and

2 together.

In sequence II the squares were raised in an anticlockwise order. By raising squares 1 and 2, subjects completed half the box. The last square to be raised was the one furthest away from the subject.

The two side squares of the A format were raised first in sequence III. Since this did not produce a stable structure it was usually necessary for the interviewer to hold one of the upright squares while the subject raised another square to join with them. This same disadvantage applied to sequence V which might best be described as a random procedure.

Subjects using sequences I, II and IV started by partially completing the box and therefore got earlier visual feedback than those using sequences III and V. Distribution of frequencies for the various sequences is shown in Table 10.

TABLE 10
FREQUENCY DISTRIBUTION OF FOLDING SEQUENCES FOR SHAPE A

Age Level	Folding Sequence				
	I	II	III	IV	V
3	1	5		1	2
4	5	2			1
5	3	5	1		1
6	7	1		1	1
7	5			1	1
8	6		2	1	

More than one half (51%) of the subjects employed Sequence I. Although this group included all age levels, this sequence was used in the main by the older subjects. Three and five year olds most frequently used the ad hoc sequence II. The random sequence V was used by 11% of the subjects, mainly three to five year olds. Thus the older subjects tended to identify an organized, structured approach to the folding of shape A while the younger subjects frequently showed less insight in their construction.

B. The sequences used to fold shape B also appeared in groupings of squares as shown below.

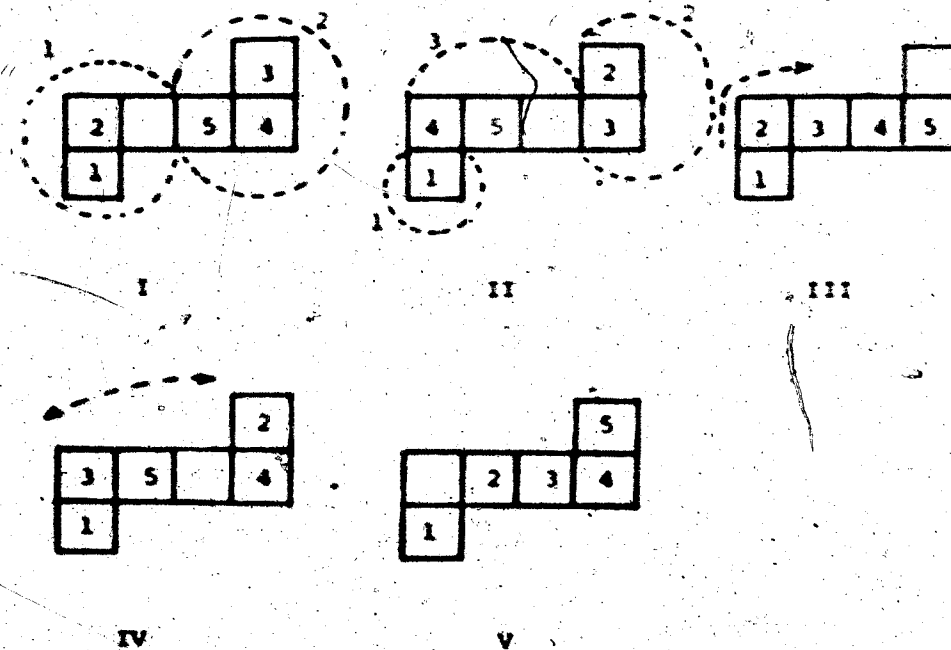

In sequence I two halves of the box were effectively assembled. By simply lifting one of these the box was completed. Sequence II showed some initial confusion, but after group 2 squares were completely raised the outline of the box was more

obvious. Sequence III was a simple rolling action which started at one end and continued until the box was complete.

Subjects who used sequence IV raised squares alternately from each end, and like sequence I led to the formation of two half boxes. Sequence V was the most complicated, in which squares in the middle of the row were raised before the end squares. This necessitated lifting half of the format over the assembled section, and appeared a somewhat clumsy procedure.

The distribution of the folding procedures for shape B are shown in Table II.

TABLE II
FREQUENCY DISTRIBUTION OF FOLDING SEQUENCES FOR SHAPE B

Age Level	Folding Sequence				
	I	II	III	IV	V
3	2	1		2	
4	2	2	1		
5	3	2		2	
6	5	1	1		
7	5	1		2	1
8	8			1	

More than half (60%) of the subjects who folded shape B employed sequence I. These subjects used a systematic folding procedure, and were, in the main, subjects aged six to eight years. Sequences II and IV, which were mainly used by three to five year olds, entailed working with both ends of the array. The rolling action of

sequence III was employed by one four year old and one six year old. The cumbersome sequence V was used by a seven year old.

C. There were fewer folding sequences for shape C than there were for shapes A and B. Since shape C was presented in three different forms these groupings represent general patterns. They took the following forms.

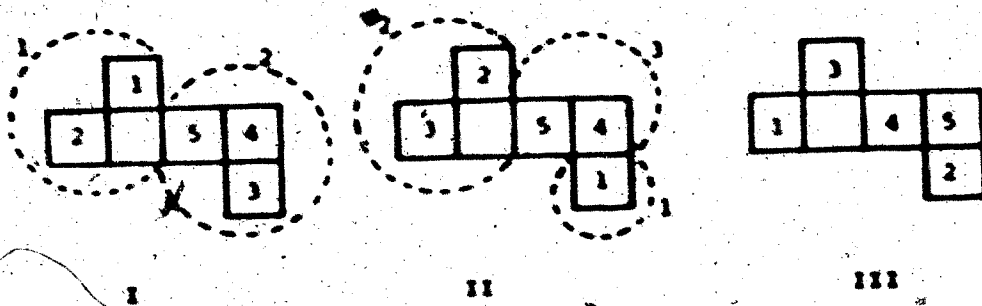

In sequence I subjects formed two half boxes which were then folded together to complete the box. Subjects who displayed sequence II moves employed three distinct clusters of movements. The first square to be moved was that closest to the subject, who then moved to the square furthest away. Although the end result was the same as for sequence I, namely the closing of the two half boxes, sequence II was used less frequently than the first sequence described. Sequence III was characteristic of a random elevation of squares which produced the box. The distribution of frequencies for these fold-up sequences for shape C is shown in Table 12.

Thirty-four subjects were presented with this format. Two of these folded the squares to form piles, and a three year old modified the layout to shape A before forming the box. Sequence I was employed by 71% of the subjects who were given this shape.

TABLE 12
 FREQUENCY DISTRIBUTION OF FOLDING SEQUENCES FOR SHAPE C

Age Level	Folding Sequence		
	I	II	III
3	9		
4	1		2
5	7		1
6	5	2	1
7	3	1	1
8	6		1

Thus almost three-quarters of this group of subjects used a procedure in which one half of the box was completed before any other squares were raised.

D. The following sequences were used to fold up shape D.

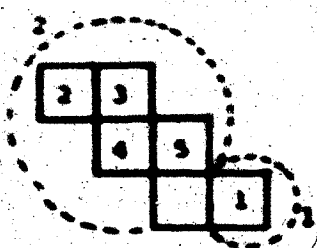

I

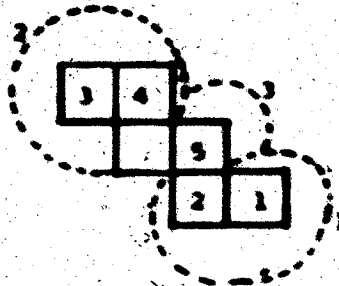

II

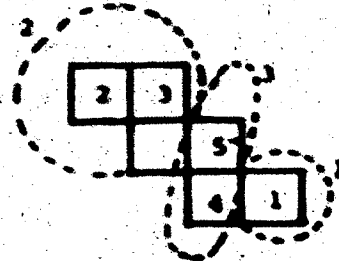

III

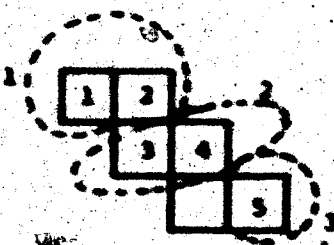

IV

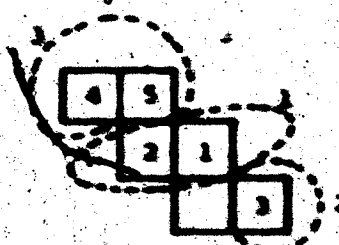

V

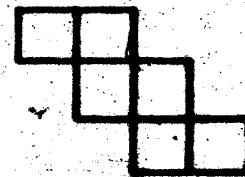

VI

In sequence I the square closest to the subject was the first to be raised. The next step was to raise the back squares. Two and sometimes three squares were held together in the vertical plane before being moved to their final position. Sequence II, like the efficient fold-up procedures of shapes A and B resulted in the formation of two half boxes which joined as a result of a single lifting action. Sequence III also resulted in closing two half boxes but the construction was more confused when compared with sequence II. A rolling action similar to that seen with the previous shapes also occurred with shape D and was labelled sequence IV. Subjects initially raised squares in the middle of the layout in sequence V. This led to some cumbersome folding procedures which were not evident in the previous sequences. Sequence VI was a random folding of squares. The frequency distribution of folding sequences for shape D is shown in Table 13.

TABLE 13
FREQUENCY DISTRIBUTION OF FOLDING SEQUENCES FOR SHAPE D

Age Level	Folding Sequence					
	I	II	III	IV	V	VI
3		1	2			2
4	2	2	3	1		
5	2		5	1	1	
6	1		3	3	1	
7	3		2	4		
8	1	3	1	2	1	1

A greater variety of folding procedures were used for this shape by each age group than with any of the previous shapes. Approximately one-third of the subjects, drawn from all age groups, employed sequence III. Eight year olds used the complete range of sequences, although five of these employed the more efficient sequences II and IV to construct their cubes. However, the distribution of sequences for the oldest subjects contrasts distinctly with those for the previous shapes. In fact, the dispersed nature of the frequencies at all age levels indicates that shape D was not present an easily identifiable fold-up procedure. There were three subjects, two 1-year-olds and one 8-year-old whose folding of the box could best be described as random. Once again the folding of two adjacent squares resulted in the formation of a half cube. Four of the sequences listed above had this movement as their first or second stage of the fold-up procedure, which possibly accounts for the large number of subjects who required no help from the interviewer to complete folding up shape D.

Summary for the Cube

1. Subjects three to eight years were able to fold shapes A, B, C and D. Although three to five year olds tended to require more interviewer assistance than the older subjects, shapes A, B, C and D were folded without assistance by 70% or more of the subjects.
2. There were subjects in all age groups who needed verbal or nonverbal cues from the interviewer in order to complete the folding of the shapes.
3. Shape A was folded more easily by more subjects than the

other shapes.

4. Subjects employed a variety of folding sequences for each of the four shapes A-D.

5. Certain folding sequences were used more frequently than others. Generally, these were characterized by better visual feedback and were more frequently used by the older subjects.

6. Younger subjects tended to use sequences where squares were raised from both ends in close succession, whereas older children tended to complete the folding at one end prior to folding at the other end of the layout.

7. Two 3-year-olds and one 6-year-old persisted with a stacking or piling behavior.

8. With the exception of the three year olds, the pattern of the 'NO REPLY' responses for shapes E and F was consistent with that for the shapes A-D. As the age of subjects increased the percentage of this response decreased.

9. Experience with up to four consecutive instances of shapes which did fold induced a "set", which led subjects aged three to seven years to predict that shape E would fold up to a box.

10. A single experience with a shape which did not fold up led to the extinction of this set in subjects at all age levels. The greatest effect was observed with seven and eight year olds. The correct predictions for shape F from subjects in these age groups were substantially higher than for shape E.

11. Five and six year old subjects made fewer predictions, correct or incorrect, about the foldability of shape F than they

did for shape 7.

12. When asked to do so, all subjects modified shapes E and F in order to obtain a layout which would fold to a cube. More than one half the subjects transformed E and F to shape A as their modification. No one transformed these shapes to shape D.

13. All subjects who were asked to verify their predictions proceeded to fold the shape.

14. In verifying their predictions for shape E, more subjects at each age level used an unstructured procedure than used a structured procedure. The reverse was the case for shape F. This may have been due to the extinction of the set mentioned above, or to a "logic" associated with shape F.

15. With the exception of one 5-year-old, subjects of all ages were able to join the edges of squares which were moved to new positions with sufficient accuracy to permit folding the transformed layouts.

The Tetrahedron

This problem consisted of three parts. In the first, problem G, subjects were given four triangles and asked to construct a tetrahedron. In the other problems, H and I, subjects were required to predict if two formats, made from four equilateral triangles, would fold into a box, illustrated by a wire frame. The formats for problems H and I are illustrated below.

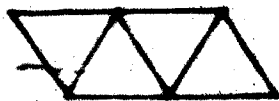

H



I

Assembling the Tetrahedron - Problem C

Four equilateral triangles (10 cm side) made of plastic with Velcro edges were placed separately on the table and each subject was asked to make a box. A wire frame of a tetrahedron was used to illustrate the shape of the box to be constructed. (Problem C)

Analysis of the behaviors exhibited by the subjects as they attempted to form this regular solid resulted in the following categories of solution.

- I. Subject does not form a pyramidal shape.
- II. Subject forms a square pyramid.
- III. Subject forms a tetrahedron with assistance from E.
- IV. Subject forms a triangular pyramid, then adds the fourth triangle to close the box.
- V. Subject builds three sides around a base, or forms a net which folds up to a tetrahedron.

In the preliminary exercise to the previous problem subjects were given the cube already folded up as well as a wire model of the solid. In this case subjects were required to perceive the solid through the wire frame only. Initially, subjects who picked up triangles from the table had some difficulty in the alignment of edges, since the Velcro edges impeded adjusting the position of one triangle relative to the other. This difficulty was not so evident when the triangles were held on the table and greater control of movement was possible.

No case occurred where the box could not be formed because

the edges of the triangle were out of alignment. The distribution of categories of assembling the tetrahedron is presented in Table 14.

Building schemes which resulted in difficulty or failure included the following:

- a. standing two triangles in a line and perpendicular to the table
- b. standing two triangles perpendicular to each other and to the table
- c. forming a net in the form of shape J
- d. forming a stack or pile of triangles.

Schemes which resulted in success were just as varied. Those included:

- e. using the frame as a reference and joining two triangles along an oblique edge
- f. taking one triangle as base, joining the other triangles to the base and bringing their apices together
- g. forming a net in the form of shape H or an equilateral triangle
- h. joining three triangles to form a triangular pyramid, cupping this in one hand and inverting to add the fourth triangle.

Verification of the Shape

When the subjects had formed a shape, they were asked to verify the construction by comparison with the frame. Verification was made (I) by standing the shape and the frame side by side, (II) by inserting the shape into the frame from the side, or

TABLE 14

DISTRIBUTION OF CATEGORIES OF ASSEMBLING
THE TETRAMERON
(N = 59)

Categories of Assembling

I	F	N N N N N F	N F N F	N N N N	N N N N N N	N N N F N F
II	N			N F		F
III	N	N N N N	N F N F	N	N N N N N F	N F
IV			F	N F		
V		N N N N N N				

N: Boy
F: Girl

(iii) by placing the frame on top of the shape. If a square pyramid was constructed, a comparison was made with the frame which led to recognition of the error. The interviewer then demonstrated the formation of the tetrahedron.

Results of the Construction

As shown in Table 14, nearly one half (46%) of subjects formed the tetrahedron without assistance from the interviewer. Two subjects, a three- and a four-year-old formed a row of triangles which they folded up into a box. Two 4-year-olds, two 6-year-olds and one 8-year-old formed a triangular pyramid by holding the triangles in their hands and proceeded to complete the tetrahedron. Twenty subjects built three walls around the triangular base and closed the top vertices to complete the box.

The problem was not presented to one 3-year-old. Two 3-year-olds folded the triangles into a stack, one 3-year-old formed shape J and could not proceed, two 3-year-olds formed part of shape H and abandoned the problem while another 3-year-old would not attempt the problem. Of the four year olds, two formed shape J formats and did not proceed, while the other formed a row of triangles perpendicular to the table. One 5-year-old and one 6-year-old also formed shape J formats, one 6-year-old simply pushed the triangles into the wire frame and one 7-year-old collapsed the triangles and declared that it could not be done. In all 22% of the subjects did not form a pyramidal shape. Two-thirds (approximately) of these were three and four year olds.

The protocol for this problem required that the subject

should observe the assembled tetrahedron before proceeding to problems H and J. The interviewer demonstrated one of the methods of construction for this shape to those subjects listed in categories I and II (N = 10).

The Predictions - Problems H and J

The shapes H and J were then presented in turn to each subject who was asked if the shape would fold up into a box similar to that illustrated by the wire frame. The subject was then asked to verify the prediction, or if no reply was given, to try to fold the box.

The frequency of each prediction response is recorded in Table 15. In each of these problems three 3-year-olds and one 4-year-old were not asked to predict. The problem was presented in the form "See if you can fold this into a box like that." Data for both problems was not recorded for one 5-year-old when the videotape reel had to be changed. The task was abandoned with one 6-year-old who persisted with detaching the triangles from the format.

Graphs for the percentages of 'YES' predictions and the 'NO REPLY' responses for shapes H and J are shown in Figure 9a and Figure 9b respectively. The three and six year olds had not made any 'YES' predictions for the foldability of shape H. However it did fold to a tetrahedron and this fact may have influenced some subjects in these age groups (33% and 22% respectively) to predict 'YES' for shape J. Subjects in the four, seven and eight year age groups made approximately the same percentage of 'YES' predictions in both problems. Whereas 22% of five year olds predicted correctly for shape H, none of this group predicted 'YES' for shape J.

TABLE 15
 DISTRIBUTION OF PREDICTION RESPONSES
 FOR SHAPES H AND J

Problem	Age	Prediction				
		Yes	No	NR	NA	
H	3			6	3	
	4			8	2	
	5	2		7		
	6		1	9		
	7	4		6		
	8	3	1	6		
	J	3	3		3	3
		4			9	1
5				9		
6		2	2	6		
7		3		7		
8		3	4	3		

NR: No verbal reply
 NA: Not asked.

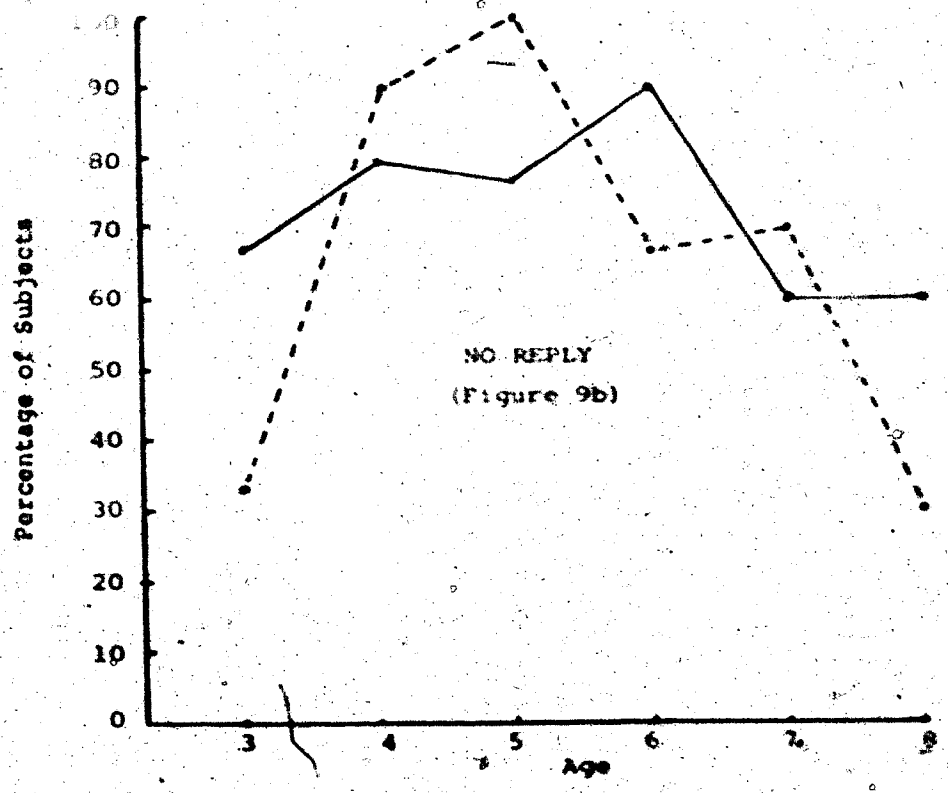
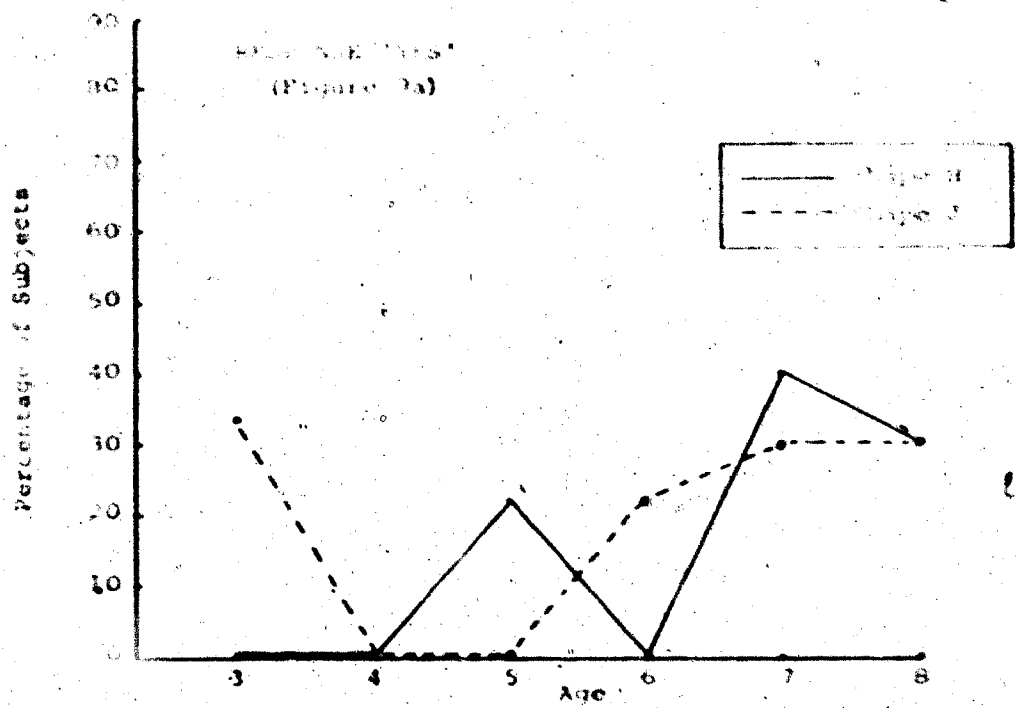

FIGURE 9
PERCENTAGE OF PREDICTION RESPONSES FOR SHAPES H AND J

Percentages of subjects in the four to seven year old groups who made 'NO REPLY' responses remained high (60% or more) for both problems. This may have been due to several reasons. First, they had just completed between four and six problems involving the square, so that the shapes were different. Furthermore they had experienced up to four consecutive shapes which did fold up and then two which did not. There may have been a natural tendency to exercise caution which resulted in them making no prediction. Then the unusual nature of the tetrahedron, a shape which would not be common to children of this age range, possibly proved difficult to perceive from the layout of the shapes H and J. Thus some subjects may have made a prediction if given more time to think about the problem.

The only marked changes in the 'NO REPLY' responses were due to the three year olds making an increase of 33% in the 'YES' predictions when they came to problem J and the eight year olds who made an increase of 30% in the correct 'NO' prediction for the second problem. Approximately 60% of subjects for both shape H and for shape J reserved their responses to this question until they had manipulated the material.

Exploratory investigations with these shapes fell into two general categories. In the first, subjects made brief folds and gave a quick decision. When the initial folding did not lead to a solution, manipulations were complicated, and involved folding, unfolding and refolding the triangles.

The Verifications

The categories of subjects' behavior while manipulating shape H were:

- I. Subject did not fold up the shape.
- II. Interviewer demonstrated and subject copied the fold-up procedure.
- III. Subject folds up tetrahedron with assistance.
- IV. Subject folds up tetrahedron with verbal cues.
- V. Subject folds up tetrahedron without any assistance.

The results for shape H are tabulated in Table 16. Category V solutions were obtained from all age groups and totalled 70% of subjects. The simplest strategy observed to yield a solution was to raise one triangle and attach one edge of this to an edge of the adjacent triangle. This procedure immediately formed an open triangular pyramid, and the tetrahedron was formed with one further fold. Another successful strategy appeared when the extreme triangles were raised simultaneously (or in turn), and the whole array folded about the middle join.

Shape J was a more difficult task since it required a subject to make a modification after recognizing that the shape would not fold. A further set of categories was necessary for this problem.

They were:

- I. Subject identified the square pyramid as a solution.
- II. Subject verified shape not tetrahedron with cues from E.
 - a. Did not restructure.
 - b. E assisted subject to restructure tetrahedron.

TABLE 16
 DISTRIBUTION OF SOLUTION CATEGORIES
 FOR SHAPE N
 (N = 59)

	M	F	M	F	M	F	M
	M	F	M	F	M	F	M
IV	M	F			M	F	
III			M	F		F	
II		F					
I	M	F	M	F	M	F	
	3	4	5	6	7	8	

M: Boy
 F: Girl

- III. Subject verified shape not tetrahedron. Was not asked to restructure.
- IV. Subject verified that shape not tetrahedron with cues from E. Restructured to form tetrahedron.
- V. Subject verified that shape not tetrahedron without cues. Restructured to form tetrahedron.

The results of the investigations with shape J are listed in Table 17. The problem associated with shape J proved to be a difficult one for many subjects. Two subjects reconstructed shape H and folded to form the tetrahedron. Three subjects formed a triangular pyramid with a flap which, after detaching, was placed in the appropriate position to close the box. Seven subjects removed one triangle and joined it to the middle triangle to form a large equilateral triangle which was then folded to complete the tetrahedron.

Procedures which did not resolve the problem included the following:

- a. folding the triangles completely to form a pile,
- b. folding over the two extreme triangles to form a rhombus, and
- c. detaching one triangle and rearranging the triangles to form the same shape.

Summary for the Tetrahedron Problems

- 1. Subjects from all age groups were able to assemble the tetrahedron without assistance given four separate triangles.
- 2. More than one half (60%) of three year olds were unable

TABLE 17
 DISTRIBUTION OF SOLUTION CATEGORIES
 FOR SHAPE J
 (N = 58)

Categories of Solution	V		M				M M	M	F F F
	IV			F F	M		M M		
	III					F F F F	M M M	M M M	F F F
	II		Fa Fa	Nb Na	Na		Nb Nb	Fb Nb	Fb
	I		F F F	M M	M	P	M		
		3	4	5	6	7	8		

M: Boy
 F: Girl

to form a pyramidal shape with the given triangles

1. Subjects displayed a variety of procedures for forming a tetrahedron with the given materials

4. Many subjects found it difficult to visualize how the triangles would fit together simply by viewing the frame.

5. Nine subjects correctly predicted that shape H would fold. Four 8-year-olds and one 6-year-old correctly predicted that shape J would not fold.

6. More than 70% of subjects refrained from predicting about the foldability of shape H. More than 60% of subjects made no prediction for shape J.

7. Seventy percent of subjects from all age groups were able to fold shape H without any assistance from the interviewer.

8. Twenty-one percent of subjects, ages four to eight years, were able to verify that shape J would not form a tetrahedron and restructured the shape to form a tetrahedron.

9. Nineteen percent of subjects, half of whom were three years old, identified the square pyramid as the same shape as the wire framed tetrahedron.

The Dodecahedron - Problem X

Subjects were shown the dodecahedron and asked to unfold the shape and then fold it back to its original form. Whereas in the previous problems a wire model of the shape was available, no such aid was provided with the dodecahedron.

Unfolding the Dodecahedron

Two methods were used to dismantle this shape, namely detaching the faces and unfolding the shape. The protocol for this problem did not specify the exact statement to be used when introducing this problem. Thirty-three subjects were informed that the shape was to be rebuilt before they dismantled the dodecahedron and 24 after they dismantled it. The pentagonal faces of the shape were completely detached by 34 subjects, and unfolded and laid out flat on the table by 26 subjects.

It was thought that the temporal sequence of instruction may have influenced subjects to use a particular method to dismantle the dodecahedron. To test this hypothesis a chi square test of significance was carried out on the data for each age group. No significant relationship was evident from the results.

Prediction

Altogether 32 subjects were asked to predict if they could put the shape together again, 24 were not asked to predict, but simply to "see if you can put the shape together again." No videotape record on prediction was available for the remaining four subjects. Of those asked to predict, approximately one half made no reply. Of the nine subjects predicting 'YES,' three were 5-year-olds and three were 8-year-olds. Six subjects predicted 'NO,' one half of them being 3-year-olds.

Reconstruction Behaviors

A. Subjects who unfolded the dodecahedron used one of three

general strategies to rebuild the shape. The first was to refold the layout. This method was used by 11 subjects aged 4 to 8 years. The method usually entailed lifting up a section of the layout, comprising two, three or four pieces, to join up with faces of the shape which were already in position. The interviewer provided support when necessary to prevent some of these pieces from collapsing or adjusted joints to make the assembly more stable. One subject employed a rolling action to bring adjacent faces of the shape into juxtaposition, a method which was appropriate for the format he had obtained.

A second method, used by six subjects aged 1, 4, 5, 6 and 8 years, began as a folding-up process. However, inappropriate selection led to pieces being raised which would not meet and attempts to join incompatible edges. These subjects then detached parts of the layout and added individual pieces to the part already assembled.

Six subjects aged 3 to 7 years had detached two or three pieces before unfolding the remainder of the shape. When laid out the pentagons were attached in small groups. These subjects folded up one of these groups and then added single or double pieces to complete the shape. This was the third reconstruction strategy used by subjects.

Of the remaining subjects, one detached all pieces, formed a partial layout, folded this and then added the remaining pieces to complete the shape; a 3-year-old detached all pieces and stacked them into piles, while the third readjusted the layout into an unfoldable format, and could not join the faces of the shape. The interviewer abandoned the task with this subject.

B. Three fold-up strategies were used by those who detached all

faces of the shape. These consisted of (i) forming a net or layout, and folding it up, (ii) forming a partial net, folding this and then building onto it, and (iii) starting with a base and building up the walls around this base. In addition to these, three other behaviors were observed. A 3-year-old formed a layout of 10 pentagons, pointed to these inconsistently and counted aloud to 11, after which she turned around and approached the interviewer. The 6-year-old who had persisted with the piling behavior with the squares and triangles, continued with this pattern after he had detached all the faces of the dodecahedron. A 7-year-old formed a layout which could not be folded up. After several attempts to join pieces had failed the interviewer abandoned the problem.

The frequency distributions of fold-up behaviors for subjects who detached all pieces of the dodecahedron are shown in Table 10.

TABLE 10

FREQUENCY DISTRIBUTION FOR METHODS OF RECONSTRUCTING
DODECAHEDRON AFTER DETACHING ALL FACES

Age Level	Formed net & folded up	Formed partial net. Folded/rebuilt	Built up around base	Other
3	1		2	2
4	1		4	
5	1	2	1	
6		2	4	1
7		2	4	1
8		1	5	

More than one half (59%) of those who detached all faces of this shape built up the five faces around a pentagonal base as the starting point of the reconstruction of the shape. Having completed this structure, the shape was completed by adding an individual pentagon. In two instances, two halves were completed and then joined to form the dodecahedron. The 4-year-old who formed a net discovered that, on folding, some of the edges would not join together. Four faces were detached and added individually to the assembly. The 3- and 5-year-olds also had similar problems, and minor adjustments were performed before the shapes were completed.

When a pentagon was being added, it was frequently necessary for the interviewer to reorient it so that a satisfactory matching of edges was effected. After initial demonstrations by the interviewer subjects took notice of the dispositions of the Velcro edges and rotated the pentagons until an appropriate match was obtained.

Solutions to the Problem

As in the case of the previous fold-out shape problems, a range of solutions for the reconstruction of the dodecahedron was observed. These solution categories were determined by the behaviors of the subjects which frequently necessitated verbal and nonverbal cues being given by the interviewer, as well as physical support to hold unattached faces of the shape. Cues such as "Shall we start folding?" and "How about if we start with this," were employed to stimulate activity when a subject appeared tentative. Nonverbal cues which included raising a piece to join with another and fitting a face to part of the assembly, provided visual feedback to subjects

who, in most cases, responded by continuing the construction of the shape. Categories of solution for Problem K were as follows.

- I. Subject does not respond, or builds piles of pentagons. E abandons problem.
- II. Subject requires such encouragement to begin, and makes only a minor contribution to the assembly.
- III. E monitors the assembly which is a joint effort by E and subject.
- IV. Subject constructs shape with two physical assists, verbal cues and support from E.
- V. Subject constructs shape with verbal cues from E.
- VI. Subject constructs shape without assistance. E supports faces when needed.

The behaviors which placed subjects in category I have been described previously. In each case the problem was abandoned without a dodecahedron being formed. Two 3-year-olds and a 4-year-old were very slow to respond to the task. To encourage these subjects to participate, the interviewer initiated joins and made suggestions about appropriate positions for the placement of the next piece. These subjects were placed in category II. The frequency distribution of subjects in the solution categories is shown in Table 19.

The sample was dichotomized into two classes of solution according to the amount of assistance given to complete the dodecahedron. Thus a solution in categories I-III was classified as a Partial or No Solution. A solution in categories IV-VI was classified as an Adequate Solution. From this point of view 60% of 3- and 4-year-olds

TABLE 19
DISTRIBUTION OF SOLUTION CATEGORIES
FOR THE DODECAHEDRON

Categories of Solution	VI	N		N F	N	N N	N N	F F F F
	V		F N		F F N	N F	N N F	N N
	IV	N F	N N	N F	N F	N	N N	
	III		F N F	N F	N		F	
	II	N F	N					
	I	N F	N			N	N	
		3	4	5	6	7	8	

Age

Partial or No Solution

N: Boy
F: Girl

found the dodecahedron problem too difficult, while 80% of 5-, 6- and 7-year-olds had adequate solutions. All 8-year-olds reconstructed the dodecahedron with adequate solutions.

With the exception of those in category 2, all subjects who added individual pentagons showed an awareness of the need to match the Velcro edges. This necessitated the rejection of certain pieces when a match could not be made and the substitution of another piece with a combination of compatible edges. Subjects in all age levels demonstrated this ability.

A 3-year-old who had assembled three pentagons indicated immediate feedback by identifying her structure when she said, "That's the same—a box—made a little box." She continued on to complete the dodecahedron. A 6-year-old who had detached five pieces from the shape looked around and enquired, "Isn't there a metal thing?". On being told that a wire frame was not provided for this problem he suggested that he begin rebuilding from that stage. However the shape was completely dismantled and rebuilt without any assistance.

Summary for the Dodecahedron

1. Children 1 to 8 years old were capable of dismantling and rebuilding the dodecahedron. However, this problem appeared too difficult for the majority of 3- and 4-year-olds.
2. Dismantling strategies which were used by most age groups took the form of detaching all pieces of the dodecahedron, unfolding the shape or a combination of these.
3. Children rebuilt the dodecahedron by refolding the layout or by building up the faces around a base.

4. When the shape was dismantled by detaching all pieces, the most frequent method of reconstruction was to rebuild the faces around a pentagonal base.

5. Children in all age groups recognized the need to attach pieces with matching Velcro edges, and reoriented pieces to obtain a suitable matching.

6. Children in all age groups were given verbal cues by the interviewer to facilitate the construction. This occurred more frequently with 3- to 6-year-olds, who also required more physical assistance than the 7- and 8-year-olds. This assistance took various forms, namely demonstrations of joining pentagons, help in selecting suitable edges to join, and support of pieces attached by only one edge.

7. The dodecahedron required greater hand-eye coordination skills than the problems involving the cube and the tetrahedron. To facilitate satisfactory conjunctions of the pentagons, the interviewer provided more assistance than was needed in the previous problems.

8. The dodecahedron problem differentiated the 8-year-olds from the other age groups more so than the problems of the cube and the tetrahedron.

VERBALIZATIONS

The behaviors previously analysed were accompanied by verbal behaviors which varied from subject to subject. Verbalizations were made spontaneously and in response to questions and statements by the interviewer. For the purpose of this report only those verbalizations

which occurred spontaneously during the solution of a problem will be considered.

Categories of Verbalization

Verbalizations were closely related to the tasks, and took the form of questions for the purpose of clarification, interpretation of the tasks, direction of the actions, comments on the materials and the tasks, and statements of an imaginative nature. However, eight subjects made no spontaneous verbalizations, and responded to the interviewer's questions in a reserved manner. These comprised two 3-year-olds, three 4-year-olds, two 5-year-olds and one 6-year-old.

Six categories of verbalizations were observed during the analysis of the videotapes. These were:

- a. Question directed at E.
- b. Monitoring of action.
- c. Problem making or rule changing.
- d. Comments on the materials or the task.
- e. Expression of interest or surprise.
- f. Indications that task was completed.

The frequency distribution of subjects in these verbalization categories is shown in Table 20.

Questions which were directed at the interviewer varied. A 3-year-old asked "where's the game?" A 4-year-old boy enquired "isn't there a — metal thing?" and an 8-year-old girl asked "isn't there supposed to be a picture?" These subjects were looking for a wire frame of a dodecahedron similar to the visual aids provided for the cube and tetrahedron problems. Another 3-year-old held a stack

TABLE 20
 DISTRIBUTION OF SUBJECTS IN VERBALIZATION CATEGORIES
 FOR FOLD-OUT SHAPES PROBLEMS

Categories of Verbalization	f	M M M	F F F	M M M M	M M M F	M M F	M M F	M M M	M M M	F F F
	e	M M	F F	M M M	M M M F	M F	M F	M M	M M	F F
	d	M M M	F F F	M M M M	M M M F	M F F	M M F F	M M M F	M M M	F F F
	c	M	F F F	M M M	M	F	F			
	b	M M	F F F	M M M	M M M F	M F	M M	M M	M M	F F
	a	M	F F	M	M M F	M F	M F	M M	M M	F F
	0	M	F F	M						
	3	4	5	6	7	8				

M: Boy
 F: Girl

of triangles against the wire frame of the tetrahedron and said "Is that the same?" A 3-year-old girl picked up the frame of the cube and asked "What's this one?" while another 3-year-old girl asked "Does it go over like this?" as she added another pentagonal face to the assembly.

Statements of a regulatory nature occurred during the solutions to the fold-out shapes problems. These verbalizations were closely related to the tasks and took the form of monitoring actions. For example, one 3-year-old, having detached a square from shape E, asked himself "Where shall I put this one?" and answered himself by adding "Oh, way up here!" and moved the square to a new position. Another 3-year-old monitored his actions by saying "and now the back," and later "and this one up," as he raised squares to form a cube. An 8-year-old punctuated her assembly of the dodecahedron with frequent comments such as "like this, maybe . . . no . . . it would, wouldn't it? . . . this side like this . . . I think this one sticks here, . . . no, that won't fit!" A 4-year-old boy, while raising squares in F, monitored his actions with "take them over here," and later said "I'll move one over here" and then "and this one" as he adjusted the squares to form a layout which would fold. As he rotated the layout for problem A, a 3-year-old pondered "I wonder if this one works," and then raised the square necessary to complete the problem.

Problem making or rule changing occurred most frequently with 3- and 4-year-olds, and not at all with 7- and 8-year-olds. For example, "I'll pass them to you" and "now it's your turn" indicated strategies used by two 3-year-olds to solve a problem. A 4-year-old

recognised that shape E would not fold when the shape was presented. When asked if it could be folded up he replied "YES" and immediately added "but I can tear this piece off, then I can easily make a box." Another 4-year-old confidently stated "I can make something" when presented with a shape that would not fold, and added "I can make a box, a different box." Another 3-year-old girl, after trying to fold shape F into a box, said "I can make it like that" and turned her assembly on its side, forming four walls with no lid and no base. In this way the subject indicated that the shape could not be folded up into the required cube.

Comments on the task and the materials were the most frequently occurring verbalizations, and were made by subjects in all age groups. Statements varied in length and perception. A 3-year-old tried to fold shape E and said "I can't. It's too long." Talking about the same problem another 3-year-old said "That is hard—the two sides won't stay up." A 5-year-old girl identified a folding problem by saying "now, there's something really wrong here." Another 5-year-old referred to the way Velcro attached itself to clothing by saying "You have to be careful." Comments from 7-year-olds concerning the transformations needed to form a fold-up shape included ". . . but I'll have to take this one off," "I don't think this will work," and "one thing I know—it's not easy." An 8-year-old was inspecting the frame of the tetrahedron when he said "if there were one more line there it would be a pyramid," and later as he dismantled the dodecahedron he said "you can actually tell which is which" and rotated a pentagon. Another 8-year-old observed that two pentagons were coming apart during

the assembly and commented "It's coming apart." As he apologized for the poor fit of some of the joins he made adjustments and they completed the task. Four 8-year-olds referred to inadequate or badly fitting joins in connection with the cube and the dodecahedron. Other comments about the task by 8-year-olds included "I'm making a good job of this," and "I don't think I can do it."

Expressions of interest were evoked by the materials. Interest was shown when the materials were related to objects in the child's environment. Subjects 3, 5 and 8 years old referred to arrangements of shape F as "a house." The result of piling squares was described by a 3-year-old as "a wallet." The tetrahedron was referred to as "a tent" by a 4-year-old and shape I led to an assembly which was described as "an Egyptian pyramid" by an 8-year-old. Shapes formed with triangles by 3-year-olds were referred to as "a car" and "a boat." Another 3-year-old said "This could be a car parking lot sometimes" as she detached all the pieces of the dodecahedron. A 5-year-old who was able to dismantle the dodecahedron commented "I'm going to rip out my windows," and another 5-year-old said "I could make a door" as he closed one of the faces of the cube. Descriptions of the half-assembled dodecahedron included "it looks like a hat" by a 4-year-old, and "This looks like a fish bowl" by an 8-year-old.

The appearance of the dodecahedron evoked facial and verbal expressions of surprise. Three and 4-year-olds smiled, while comments such as: "Ay-yi-yi," "that's a beauty," "wow" and "Oh boy" were made by 5- to 8-year-olds.

Verbalizations in category f, namely, indication of task

completion was made by subjects in all age groups. Their expressions generally took the form of "There," or "I did it." An 8-year-old said "I think that might do it—there" as he placed the last polygon in the dodecahedron. A 3-year-old girl completed her assembly of the tetrahedron with the statement "Yes—that's the same shape," and pushed her pile of triangles into the wire frame.

The frequency distribution of categories of verbalization for subjects in each age group is shown in Table II. This table shows the kind of spontaneous verbalizations made by each subject. Among the 3-year-olds, one boy and one girl made no verbalizations. Their responses to questions directed by the interviewer were limited to "YES," "NO," or no reply. Two 4-year-old girls and a 4-year-old boy made no spontaneous verbalizations. Their responses to the interviewer's questions were brief, namely "YES" or "NO," or they made no reply at all. One 3-year-old girl and a 4-year-old boy made no spontaneous verbalizations. Their evoked responses to questions were also brief. All 3- and 4-year-old subjects made at least one kind of verbalization.

Verbalizations by subjects in the fold-out shapes problem were classified into six categories. The number of subjects in each age group with a specific number of verbalization categories is shown in Table II.

There were eight subjects who made no spontaneous verbalizations. Verbalizations in all six categories were made by a 3-year-old, and in five categories by three 3-year-olds, three 4-year-olds, four 3-year-olds, and three 4-year-olds. These subjects spoke more freely

TABLE 71

DISTRIBUTION OF CATEGORIES OF VERBALIZATION FOR FOLD-OUT
SMART PROBLEMS FOR EACH AGE GROUP

	a	b	c	d	e	f
1	M	M	M	M	M	M
2	M	M	M	M	M	M
3	M	M	M	M	M	M
4	M	M	M	M	M	M
5	M	M	M	M	M	M
6	M	M	M	M	M	M
7	M	M	M	M	M	M
8	M	M	M	M	M	M

	a	b	c	d	e	f
4	M	M	M	M	M	M
5	M	M	M	M	M	M
6	M	M	M	M	M	M
7	M	M	M	M	M	M
8	M	M	M	M	M	M

	a	b	c	d	e	f
5	M	M	M	M	M	M
6	M	M	M	M	M	M
7	M	M	M	M	M	M
8	M	M	M	M	M	M

	a	b	c	d	e	f
6	M	M	M	M	M	M
7	M	M	M	M	M	M
8	M	M	M	M	M	M

	a	b	c	d	e	f
7	M	M	M	M	M	M
8	M	M	M	M	M	M

	a	b	c	d	e	f
8	M	M	M	M	M	M
9	M	M	M	M	M	M
10	M	M	M	M	M	M
11	M	M	M	M	M	M
12	M	M	M	M	M	M
13	M	M	M	M	M	M
14	M	M	M	M	M	M
15	M	M	M	M	M	M

a: Question directed at S
 b: Monitoring action
 c: Problem/rule change
 d: Comment about material/task
 e: Expression of interest/surprise
 f: Completion of task

M: Boy
 F: Girl

TABLE 22

DISTRIBUTION OF THE NUMBER OF VERBALIZATION CATEGORIES
FOR EACH AGE GROUP IN THE FOLD-OUT SHAPES PROBLEMS

Age	Number of Verbalization Categories Used					
	6	5	4	3	2	1
3	1	3	2	1	1	
4		3	1		3	
5		4	2		1	2
6			2	4	2	2
7			1	2	2	3
8		3		4		3

as they attempted to solve the problems. The 7-year-old subjects had the least number of verbalization categories. Seven year olds also monitored their actions less frequently than subjects in the other age groups. There were subjects in all age groups who conversed freely with the interviewer and subjects in each age group whose responses to questions from the interviewer were minimal.

Summary for Verbalization

1. A variety of spontaneous verbalizations were produced by the subjects when solving the fold-out shapes problems.

2. Verbalizations were task related, involving questions about the task or the material, monitoring actions during the solution, rule changing, comments about the task or the materials, expressions of interest and surprise, and indications that the task was completed.

3. No spontaneous verbalizations were made by the following: two 3-year-olds, three 4-year-olds, two 5-year-olds, one 6-year-old.

4. There were more subjects in age groups 1, 3 and 8 years with a greater range of categories of verbalization than there were in age groups 4, 6 and 7 years.

5. There were fewer 4- and 7-year-olds who asked questions about the task or the materials.

6. A greater number of subjects monitored their actions in the 1, 3 and 8 year groups than in the 4-, 6- and 7-year-olds.

7. Rule changing or problem making behaviors occurred mainly in the 3- and 4-year-olds. Subjects over 6 years of age did not

want to change the rules.

8. Comments on the materials and the task was the most frequently occurring category in all age groups.

9. The least number of subjects who made statements showing interest in the task or the materials occurred in the 6- and 7-year-olds.

10. With the exception of the 6- and 7-year-olds, more than one half the subjects in each age group gave some indication that they had completed the task.

11. Verbalizations in all six categories occurred with one 3-year-old girl. Five categories of verbalization were used by three 3-year-olds, three 4-year-olds, four 5-year-olds and three 6-year-olds.

12. The largest number of categories of verbalization used by 6- and 7-year-olds was four. One half of the 7-year-olds verbalized in only one category.

13. Subjects in all age groups gave verbal indications of interest in the fold-out shape problems.

THE PROJECTED SHAPES PROBLEM

This problem consisted of 10 separate tasks each of which involved the projection onto a screen of the shadow cast by a wire model. Each subject was asked to choose a wire model which would

cast a shadow matching a diagram presented on a card, and then to form that shadow.

Of the 60 subjects who were presented with the fold-out shapes problem, 30 were given the projected shapes problem. Whereas the first of these was concerned with the transformation of a two-dimensional net into a three-dimensional solid, the second required a subject to transform a two or three-dimensional model into a two-dimensional figure.

The results will be presented in two parts, the first involving those problems where the shadows were cast by the circle, rectangle and triangle, and the second part dealing with those problems where the shadows were cast by the square pyramid, the tetrahedron and the octahedron.

The interviewer demonstrated how to throw shadows onto a screen using a hand and then one of the wire models. The subject was then asked to make these shadows, and to observe the effect on the shadows produced by moving the hand and the wire model. The tasks were then presented in a fixed sequence.

A. The Plane Shapes Wire Models

The models had the following shapes.

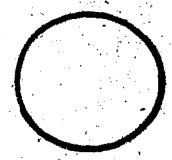

A

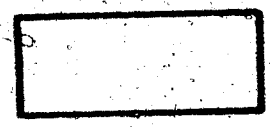

B

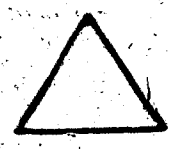

C

The shapes which were drawn on separate cards had the following

forms.

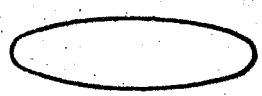

(i)



(ii)



(iii)



(iv)

Prediction for Shapes (i)-(iv)

These shapes were drawn on cards and presented individually to each subject, who was asked to choose the appropriate wire model. Eleven subjects were given a choice from six models, the plane models and the three-dimensional models. The remaining 19 subjects selected from the plane models.

The circle was selected as the appropriate model to cast an elliptical shadow by 25 subjects. No record was available of the predictions made by one 7- and one 8-year-old. Two 3-year-olds chose model C, the triangle, and were then given model A by the interviewer, while a 7-year-old selected model B and later C before being cued to use model A.

The rectangle was the model appropriate for the production of shape (ii), and was selected by 28 subjects. One 3-year-old and one 6-year-old chose C. The former was offered model B, but the 6-year-old proceeded to experiment with models E and F before selecting B.

Shape (iii) was produced by using model C. This was selected

by 19 subjects, with one 3-year-old trying model A before finally selecting C.

It was possible to produce shape (iv), the straight line, with each of the models A, B, and C. This problem was not given to one 3-year-old. The interviewer suggested to seven subjects that a particular frame be used, and therefore they were not considered to make a choice. Models A and B were selected by six subjects and model C by 8 subjects. Two subjects, one 4- and one 7-year-old, selected from the three-dimensional models, before being cued to use the circle by the interviewer.

The selection of appropriate wire models for producing the shapes (i)-(iv) was not a difficult task for this sample of subjects. From a total of 108 predictions, only six were inappropriate. The acute angles of the triangle and the parallelogram were similar in size. The two subjects who selected model C to cast a shadow of a parallelogram may have been concentrating on one part instead of the whole of the figure.

The Results

In each of these problems subjects looked at the figure to be produced and then turned to the table and viewed the wire models. Following the selection of a wire model, subjects cast shadows by holding the frame in the beam of light. The 3- and 4-year-olds in particular had to be prompted to hold their hands away from their bodies so that the shadows could be observed.

Assistance in producing the required shadow was given by the interviewer. Verbal cues such as "Turn it around," "Hold it down in

the corner" and "Try using this one" were noted. When a subject was close to producing the required shape but did not seem to recognize the appropriate move, the interviewer assisted by turning the subject's hand, or actually demonstrated how the shape was formed.

The solutions for each of the projected shapes problems were categorized as follows.

- I. Subject did not make the correct shadow. Task abandoned.
- II. Subject made shadow after demonstration.
- III. Subject made shadow with manual assistance from E.
- IV. Subject made shadow with verbal cues only.
- V. Subject made shadow without assistance.

(i) The Ellipse

The distribution of categories of solution for the ellipse (shape (i)) is shown in Table 23. The 3-year-old in category I chose the triangular model after a long pause, and then responded to the cue from the interviewer to use the circle. However, he did not make any shadow, sucked the wire model and gazed around the room. Another 3-year-old also selected the triangle which was replaced by the circle. This was rotated to form a 'straight line' shadow. The interviewer turned this subject's hand, and together they produced both a vertically and a horizontally oriented ellipse. Demonstrations were given to two 4-year-olds and a 7-year-old, who then replicated the interviewer's actions.

Subjects held the circular wire model in a variety of ways. When suspended from the top, a rotation about a vertical axis was easily produced. If it was gripped at the side, a rotation about a

TABLE

DISTRIBUTION OF SOLUTION CATEGORIES FOR THE PILLAGE

Solution Categories	I						
	II		M			M	
	III	M		M			F
	IV	M		F			
	V		M		F	M	F
	3	4	5	6	7	8	

M: Boy
F: Girl

horizontal axis was possible. In Table 24, where these orientations of the ellipse have been described as horizontal, vertical and oblique, the distribution of orientations for the 27 subjects is shown.

TABLE 24
DISTRIBUTION OF ORIENTATIONS OF ELLIPSE

Age	Orientation of Ellipse		
	Horizontal	Vertical	Oblique
3	1	1	
4	2	2	1
5	4	1	
6	2	1	
7	1		1
8	2	1	1

The shape displayed on the card had its major axis horizontally oriented. One half of the subjects produced an elliptical shadow whose orientation was similar to that displayed on the card. Subjects who formed an ellipse which was vertically oriented and then changed to a horizontal form at the interviewer's suggestion included two 3-year-olds and three 6-year-olds. Two girls, aged 5 and 8 years, transformed their ellipses without any cues.

Rotation of the wire model within its own plane was a behavior which occurred with subjects 3 to 5 years old when the interviewer suggested that the model be "turned around." This behavior carried over into later problems.

(iii) The Parallelogram

When the wire rectangle was held in a vertical plane, a rectangular shadow was formed. It was necessary to adjust the model to lie in an oblique plane for a parallelogram to be projected on the screen. For this reason solutions which consisted of rectangles oriented horizontally, vertically or obliquely were listed in category I. The solution categories for the ellipse were employed to classify the responses for this problem. Their distribution is reported in Table 25.

When the rectangular model was supported by one of its short sides and this was held vertically or obliquely, it was difficult to control the adjustments. A 6-year-old girl experienced this difficulty, but reached a satisfactory solution after a demonstration by the interviewer. This subject is reported in category II. There were no subjects who received manual assistance from the interviewer. For this reason category III was omitted from Table 25.

Two 3-year-olds and one 4-year-old were successful in projecting parallelograms without interviewer assistance, and matched the performance of all the 7- and 8-year-olds who had category V solutions.

In four cases, one 6-year-old and three 8-year-olds, the horizontally oriented shadow was produced in a reflected form, that is, with the shorter sides sloping in the opposite direction to that in the figure. These were accepted as solutions. One 8-year-old subject recognized this and tried to obtain the given form. This was not achieved until assistance was provided by the interviewer.

The parallelogram was produced with a variety of orientations which have been classified as horizontal, vertical and oblique according

TABLE 25
DISTRIBUTION OF SOLUTION CATEGORIES
FOR THE PARALLELOGRAM

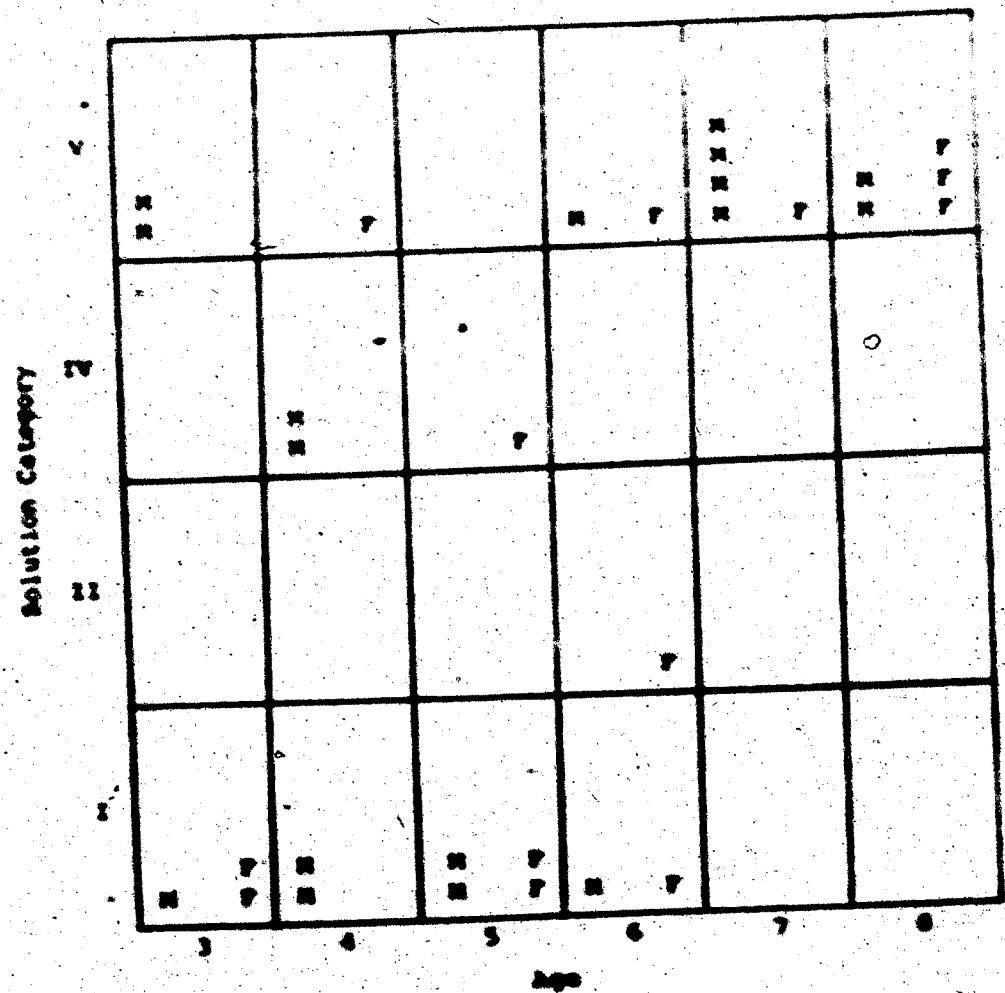

M. Boy
F. Girl

to the direction of the longer sides. Table 16 shows the distribution of these orientations in the solutions to this problem.

TABLE 16
DISTRIBUTION OF ORIENTATIONS OF THE PARALLELOGRAM

Age	Orientation of Parallelogram		
	Horizontal	Vertical	Oblique
1		1	1
4	1	1	1
5	1		
6	1		
7	1		1
8	1		1

The 7- and 8-year-olds formed equal numbers of horizontally and obliquely oriented parallelograms.

(111) The Equilateral Triangle

There were only two instances in which subjects either failed to select the correct model or had difficulty in forming a shadow which closely resembled the given figure. The first of these, a 3-year-old girl, selected the wire circle which she carried to the screen and superimposed over the diagram. Asked if that would make the same shape she replied "Yes." The subject was prompted to choose another model, whereupon she selected the triangle and tried to carry it to the screen, presumably to superimpose it on the diagram as she had done previously. The interviewer proceeded with the next problem.

The second case was a 4-year-old boy who had difficulty reproducing an equilateral triangle although he was able to form a scalene triangle on the screen. The interviewer adjusted this subject's hand so that the required shape was produced. All subjects except two had category V solutions. The 4- and 5-year-olds had category I and II solutions respectively. A solution category table has been included.

iv. The Straight Line

A shadow in the form of a straight line was produced by holding one of the three models in a horizontal plane. Solutions which did not involve assistance from the interviewer were obtained by 18 subjects. The circle was selected by one 6- and one 7-year-old, and three 8-year-olds. The rectangle was employed by two 6-, four 7- and two 8-year-olds, while the triangle was chosen by a 4-year-old, two 5- and two 6-year olds. Approximately one half of this group projected the straight line using the wire rectangle.

The longer sides of the rectangle constituted a prominent feature of this model. This possibly attracted the attention of some subjects who were scanning the wire models in search of a straight piece of wire. A 3-year-old subject simply produced a shadow of a rectangle as his solution. A 5-year-old obscured two sides of the triangular model by holding it in both hands and projected the shadow of the remaining side to superimpose it on the figure of the straight line.

The square pyramid and the octahedron were selected by a 4-year-old and a 7-year-old respectively. In the case of the first subject the interviewer demonstrated a solution, while a verbal cue was sufficient to help the second subject arrive at a solution.

The frequency distribution of solution categories for the

projected shape (iv) is shown in Table 27. This task differentiated the 6- to 8-year-olds from the younger subjects more than the previous tasks. Whereas 70% of subjects aged 3 to 5 years had solutions in categories I or III, 100% of the 6-, 7- and 8-year old subjects had solutions in categories IV or V. Two 3-year-olds projected a circle and a 4-year-old listed in category I projected an obliquely oriented ellipse.

The orientation of the shadows cast by subjects listed in categories IV and V was predominantly horizontal. Oblique lines were formed by two subjects 7 and 8 years of age. Two subjects, aged 4 and 5 years, projected vertical lines, and 14 subjects formed horizontal lines.

Summary for Projected Shapes Problems (i)-(iv)

1. Subjects in all age groups were able to accurately predict which models would project shapes (i), (ii) and (iii).
2. Verbal cues and manual assistance were required by most 3- to 6-year-olds to arrive at a solution to problems (i), (ii) and (iii).
3. With no enforcements, all subjects found shape (iii), the equilateral triangle, the easiest shape to project.
4. One third of the subjects accepted the rectangle as a solution to the problem of projecting a parallelogram.
5. All 6-, 7- and 8-year-olds obtained a solution to problem (iv) without assistance. Thirty percent of subjects aged 3 or 4 years projected the straight line with only verbal cues from the interviewer.
6. The majority of subjects who projected the ellipses and

the straight line oriented their solutions to match the orientation in the given diagram.

B. The Three-Dimensional Wire Models

In the remaining projected shapes problems (v) to (ix) subjects were required to project shadows cast by a square pyramid, a tetrahedron and an octahedron. Illustrations of the shadows were drawn on cards and displayed on the projection screen. The diagrams were complex, involved superposition of shadows, and demanded more perception and manipulative control than the previous problems.

The wire models had the following shapes.

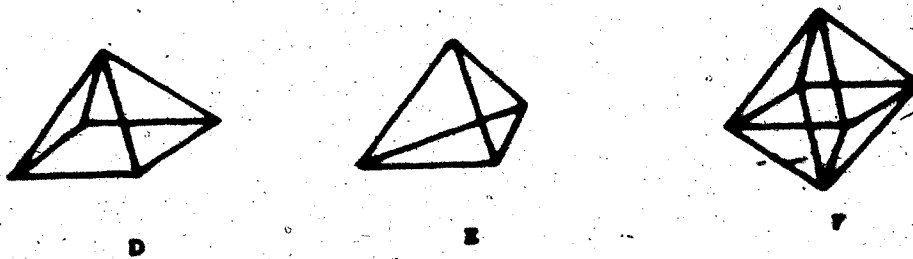

The six shapes which were to be produced on the screen were:

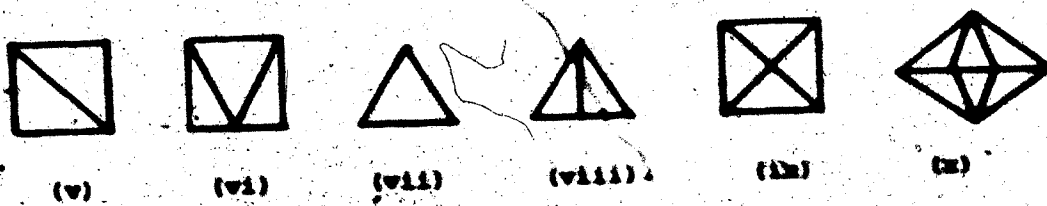

Each of these shapes may be projected by using one of the models D, E or F, and involves the superposition of two or more lines. The results for each of these problems will be presented separately, using the same categories of solution as those which classified behaviors in problems (i)-(iv).

Predictions for Shapes (v)-(x)

Those models initially selected without any cues from the interviewer were considered to be predictions, although in 12 instances subjects appeared to be sampling the models in a random fashion.

Seven subjects were given a choice from 6 models. These subjects were as follows: one 4-year-old, three 6-year-olds, two 7-year-olds and one 8-year-old. As a result of this, one 4-year-old, two 6-year-olds and one 7-year-old duplicated a choice which had been made in problem (iii).

The problem was abandoned with three 3-year-olds. Of these, one was asked to project shape (v), a second was asked to project shapes (v) and (vi), and the third was not given any of these shapes to project. A fourth 3-year-old was not given shapes (vii) and (viii). A 5-year-old girl could not be persuaded to engage in these problems, although she did choose model C for problem (vii). In the remaining problems this subject pushed the shapes around on the table, and the tasks were abandoned. Finally, no record was made of an 8-year-old's solutions to problems (vii) and (x). A total of 121 predictions were made, of which 87 were correct.

The distribution of predictions for projected shapes (v)-(x) is shown in Table 28. One-third of the predictions for shape (v) were correct. These were made by subjects aged 5 to 8 years. Approximately one half of the predictions for shape (vi) were correct. These were made by subjects aged 4, 6, 7 and 8 years. All predictions for shape (vii) were correct. More than 90% of the predictions for shape (viii) were correct, although only one of the three subjects who chose model D

TABLE 28
DISTRIBUTION OF PREDICTIONS OF MODELS FOR PROJECTED SHAPES (V)-(X)

Shape	Model	Age Group					
		3	4	5	6	7	8
(v)				1	1	4	1
		1	1		1		1
		1	2	2	2	1	3
(vi)			1		1	3	1
		1	1		2	1	1
		1		1			
(vii)			1			1	
		1	2	5	3	3	4
(viii)		1	1	1			
			1	4	4	4	4
			1			1	
(ix)		1	1		3	5	2
							1
		1	1	4	1		1
(x)		1		1			1
		1		2	5	5	2

* Appropriate Model

actually produced shape (viii). With one exception, all predictions for shape (ix) were correct, while more than 85% of the predictions for shape (x) were also correct.

The proportions of correct predictions for shapes (v) and (vi) were small. These problems were the first of the complex type, and the alternative models for these problems were strong distractors. The correct model for shape (vii) was readily identified, although this shape was also produced with model D by the two subjects who chose it. The high proportion of subjects selecting model F for shape (x) may have been due to subjects associating the greater number of lines in the figure with the number of edges of the octohedron.

The Results

The categories of solution for these projected shapes problems are the same as those used to classify solutions to problems (i)-(iv), namely:

- I. Subject did not make the correct shadow. Task abandoned.
- II. Subject made shadow after demonstration.
- III. Subject made shadow with manual assistance from E.
- IV. Subject made shadow with verbal cues only.
- V. Subject made shadow without assistance.

The results for problems (v)-(x) will be discussed in seriatim.

Shape (v)

The distribution of categories of solution is shown in Table 29. This problem was not presented to one 3-year-old for whom demonstrations were necessary in the earlier problems. Another 3-year-old

stacked the frames and did not attempt to solve the problem. A 4-year-old became excited as the interviewer assisted him to bring about the coincidence of lines. This subject insisted on completing the remainder of this problem without help. In contrast, another 4-year-old continued to play with the frames after a solution had been demonstrated, and did not complete the task.

All subjects 3-6 years old had difficulty in obtaining coincidence of lines with this problem. Two 4-year-olds, one 5- and one 6-year-old reached a solution with assistance, and two 6-year-olds projected the shape after a demonstration by the interviewer.

The 7- and 8-year-olds displayed greater control in their movement of the model. The majority of these subjects obtained solutions with minimal or no assistance from the interviewer.

The diagonal in the figure was an oblique line. Orientation of the projected shadows varied. The diagonal was made horizontal by one 4-year-old, one 5- and one 7-year-old. Vertical diagonals were produced by one 6- and one 8-year-old, while oblique diagonals were produced by one 4- and one 6-year-old, three 7-year-olds and four 8-year-olds. In four cases the direction of the oblique diagonals was reversed.

Shape (vi)

The distribution of solution categories is shown in Table 30. This problem was not presented to two 3-year-olds and one 4-year-old. With three exceptions, all subjects 3 to 6 years of age found this shape too difficult to reproduce. Only the 7- and 8-year-olds and one 3-year-old demonstrated the manipulative skills necessary to

TABLE 30
 DISTRIBUTION OF SOLUTION CATEGORIES
 FOR PROJECTIVE SHAPE (VI)

Category of Solution	V					M M	F	M
	IV	M				M		M F F
	III				F	F		
	II				M	F	M	F
	I	M F	M M M	M F	M F	M F		
		3	4	5	6	7	8	

M: Boy
 F: Girl

produce this shape. Two subjects who were given all six models from which to choose, selected model C, the equilateral triangle. These subjects apparently were attracted to the triangle which appeared in the interior of the figure. One of these subjects responded to cues and substituted model D. However the required shape was not produced by this subject.

Three 5-year-old and two 8-year-old subjects formed correct shapes with oblique orientations. Another subject, aged 7 years, projected a shadow which was a 90° rotation of the required shape. This was identified by the subject who made the adjustments necessary to rectify the orientation of the shadow.

Shape (vii)

Projected shape (vii), the equilateral triangle, was readily identified with model E, the tetrahedron. The distribution of categories of solution for this shape is shown in Table II. The problem was not presented to four 3-year-olds and one 8-year-old. Five subjects in category I were unable to adjust the orientation of the model necessary to bring the sides into coincidence, although they had selected the correct model for this task. Successful solutions by a 4-year-old and a 7-year-old were obtained by employing model D. Two solutions were obliquely oriented with respect to the given figure, and another solution was a 180° rotation of this shape.

Shape (viii)

This problem was not presented to four 3-year-olds and one 4-year-old girl. The distribution of solution categories for shape

TABLE 11
 DISTRIBUTION OF SOLUTION CATEGORIES
 FOR PROJECTED SHAPE (VII)

Category of Solution

V		N	N	N	F	N	F	N	F
IV		N				N			
III	N		N	F					
II				F					
I		N	F	N	F				
	3	4	5	6	7	8			

N: Boy
 F: Girl

(viii) is shown in Table 32. Since the interviewer did not provide any manual assistance, there were no solutions in category III, and this section was omitted from the table. Approximately 20% of the subjects did not obtain coincidence of the lines at the base of the shadow. These subjects were listed in category I. The shadow projected by one 5-year-old girl was approaching coincidence when she concluded her activity. After a demonstration by the interviewer a 6-year-old projected the required shape.

Verbal cues assisted one 3-, one 7- and two 8-year-olds to achieve coincidence of the base lines. A solution without assistance was obtained by 60% of the subjects aged 4-8 years. Model D was used by one subject to project this shape, while the two subjects who selected model F produced solutions when given the correct model.

An oblique orientation of this shape was projected by the 3-year-old, one 6-, one 7-year-old and two 8-year-olds. By holding the tetrahedron at one of its vertices, subjects were able to exercise good control over the rotation of the model and to obtain correct orientation.

Shapes (vii) and (viii) were produced unaided (category V solution) by subjects 4-8 years in marked contrast with the results for shapes (v) and (vi), where only 7- and 8-year-olds were able to achieve this.

Shape (ix)

The distribution of categories of solution for shape (ix) is shown in Table 33. This problem was not presented to three 3-year-olds and one 4-year-old.

TABLE 32
 DISTRIBUTION OF SOLUTION CATEGORIES
 FOR PROJECTED ESCAPE (VIII)

Category of Solution	V		M M M M			M M M M		M M M M
	IV							
	III	M						F F
	I			M M	F F		F F	
		3	4	5	6	7	8	

M: Boy
 F: Girl

TABLE 3)

DISTRIBUTION OF SOLUTION CATEGORIES
FOR PROJECTED SHAPE (12)

Category of Solution	V				M M M M	M F M F
	IV	F			M	
	III				F	
	II				M F	F
	I					
		3	4	5	6	7

M: Boy
F: Girl

This problem sharply differentiated the 7- and 8-year-olds from the rest of the subjects. One-third of the sample of children were able to produce a solution with either assistance or demonstration from the interviewer.

Obliquely oriented solutions were made by one 5-, one 7- and one 8-year-old subject. The orientation of shape (ix) was identified by one 7-year-old who referred to the 'X' in the figure.

Model D was preferred by subjects 6-8 years for this problem. It was possible that some had encountered this shape while solving the shape (v) and shape (vi) problems. One 7-year-old commented "I had that before," as the card for this problem was presented to him. A 4-year-old who selected from six models available to him, chose model C. This subject replicated the solution demonstrated by the interviewer.

Shape (x)

As shown in Table 34, 60% of the sample obtained category V solutions, that is, they produced the shape without interviewer assistance. These subjects were evenly distributed over the age range 4-8 years. Only one 3-year-old was unable to obtain coincidence of shadows. The other 3-year-old could not obtain a solution since she had selected model D, and did not attempt to try the other models available. One-third of the sample, ages 4-7 years, required interviewer assistance or demonstration before a solution was obtained.

Whereas the 4- and 5-year-old subjects with category V solutions made several turns before reaching the required shape, the 7- and 8-year-olds, with greater control of movement, obtained

TABLE 34
 DISTRIBUTION OF SOLUTION CATEGORIES
 FOR PROJECTED SHAPE (X)

Category of Solution	V		N N N	N P	N P	N P	N P
	IV					N	
	III			N P	P P	N	
	II		N		P		
	I						
		3	4	5	6	7	8

N: Boy
 P: Girl

solutions with a minimum of effort.

Obliquely oriented shapes were projected by two 8-year-olds, two 7- and two 8-year-olds, and two 7-year-olds formed shapes which were 90° rotations of the given shape.

Examples of some of the configurations which were obtained for shapes (v)-(ix) are illustrated in Figure 10. These were the best shadows cast by subjects for whom further manipulation led to a less satisfactory solution. In some cases more control of movement and hand-eye coordination could have led to a minor adjustment needed to reach the required shape. In other cases the wrong model was selected for the task.

Some Observations on Visual Behaviors

Eye movements of subjects were observed during the solution of the projected shapes problem. All subjects initially looked at the card displaying the given shape when it was presented to them. Their attention was then drawn to the wire models assembled on the table. Some subjects glanced occasionally at the card prior to selecting a model. It may be surmised that these subjects were comparing characteristics of the model with features of the given shape in order to identify the most appropriate model to use for the task.

These eye movements which occurred after a subject had commenced forming shadows on the screen were of some interest. These visual behaviors tended to fall into the following categories.

- A. Concentrated on shadow.
- B. Looked at shadow with infrequent glances at the card.
- C. Alternating glances at model and shadow.

GIVEN

PRODUCED

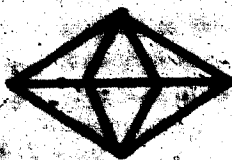

FORMS OF OBJECTS I SECTION - PRODUCED SHAPES FIGURES

D. Alternating glances at shadow and card.

The pattern of visual behaviors was not constant for a particular subject, since their behaviors changed from shape to shape. For this reason a numerical analysis of these behaviors was not performed. The different categories of visual behavior shown above appeared to be indicative of functional thinking. For example, a subject who retained a mental picture of the shape to be projected, and was able to make adjustments to the position of the model without looking at it was displaying a category A behavior. Subjects who reinforced their mental pictures of the shape to be formed by looking at the card at irregular intervals were displaying category B behaviors. Category C behavior allowed a subject to note the correspondence between movements of the model and changes in the shadow projected on the screen. Category D behaviors enabled subjects to monitor the changes produced in the shadow, and thus determine whether the strategy employed was leading towards the required shape.

The visual behaviors of subjects for the projected shape (v) problem are shown in Table 15. Categories A-D listed above were used, and behaviors which did not fall into these were denoted as OTHER. For example, one 3-year-old looked from the shadow to the model and then to the card. This behavior was repeated and was a combination of categories C and D. The other 3-year-old and the 4-year-old glanced around the room and did not focus attention on the problem.

The most frequently observed visual behavior for this problem was category A, concentration on the shadow. However, it should be

noted that category B behaviors may have gone undetected when the shadow was projected in close proximity to the display area.

TABLE 35

DISTRIBUTION OF CATEGORIES OF VISUAL BEHAVIOR
FOR PROJECTED SHAPE (V) PROBLEM

Category of Behavior	Age Groups					
	3	4	5	6	7	8
I	2	2	5	3	3	5
II					1	
III		2		2	1	
IV						
Other	2	1				

Verbalizations

The projected shapes problem generated similar spontaneous verbalizations to those that were observed in the fold-out shapes problem. However, subjects appeared to be more absorbed in the projection tasks than in the fold-out tasks. Verbal indications that the task had been completed were given by seven subjects and there were no instances where subjects attempted to change the rule or make other problems.

The categories used for classifying the verbalizations for both the fold-out shapes problems and the projected shapes problems are listed below.

- a. Question directed at E.
- b. Monitoring of action.

- c. Problem making or rule changing.
- d. Comments on the materials or the tasks.
- e. Expressions of interest or surprise.
- f. Indication that task was completed.

The distribution of subjects in these categories is shown in Table 16.

Questions were directed at the interviewer by subjects in all age groups. The questions related to the materials and the shadows. For example, a 3-year-old formed a shadow and asked: "Will that one do?" "How do you put this one together?" was asked by another 3-year-old as she picked up the square pyramid. The coincidence of lines on the screen prompted a 5-year-old to ask, "How do you make them shadows?" and added later on, "Well, tell me where the lines have gone." The question "What happens if you do it like this?" from a 6-year-old could be described as rhetorical, since the answer was projected on the screen. When asked to form an ellipse, an 8-year-old said as she picked up model A, "How do I make it oval?—Stretch it?" Responses evoked by the interviewer's questions were limited to 'YES' or 'NO.'

Statements were classified in category b if they described or accompanied a behavior. These statements were distinguished from category d statements by their function, namely, a regulation of the behavior. Instances of this type of verbalization were as follows. "There," as a 6-year-old turned the model and watched the shadow changing. "I'll try this one" came from a 5-year-old as she picked up model D. A 4-year-old reached out to superimpose his shadow on the card, and as he did so, said "Down there."

There was no evidence of rule changing or of problem making by this sample of subjects.

Statements about the material and the task were made more frequently than statements in the other categories. Responses to the problem of projecting a straight line included "We don't have one" from a 3-year-old, "I can't do that" from a 4-year-old, "None will do that . . . none of them is a straight line" from a 5-year-old, and "O dear, it's a straight line" from an 8-year-old.

Category e verbalizations were made by three subjects. Shadows were described by a 4-year-old as "a boat," and by two 5-year-olds as "like a bagpipe" and "like a kite."

Verbalizations which indicated that the task had been completed were very brief. The 3-year-olds emphasized their solutions by saying "Like that, see?" and "See." The 5-, 6- and 7-year-olds concluded their problem solving with "There," while the 8-year-old turned to the interviewer and said "Hey—I did it—I did it."

The frequency distribution of categories of verbalization for subjects in each age group is shown in Table J7. The kinds of spontaneous verbalizations made by each of the 18 subjects are shown in this table. Subjects generally did not exhibit the variety of verbalizations as shown on page 113 for the fold-out shapes problems. One 5-year-old had five categories of verbalizations, while two subjects, ages 1 and 8 years, had verbalizations in four categories. There did not appear to be any pattern of verbalization displayed in this task.

TABLE 37

DISTRIBUTION OF CATEGORIES OF VERBALIZATION FOR PROJECTED SHAPES PROBLEMS FOR EACH AGE GROUP

Age	a	b	c	d	e	f
3	M					
3	M					
3	M					
3	P					
3	P					
4	M					
4	M					
4	M					
4	M					
4	P					
5	M					
5	M					
5	P					
5	P					
5	P					
6	P					
6	P					
7	M					
7	M					
7	M					
7	M					
7	P					
8	M					
8	M					
8	P					
8	P					
8	P					

a: Questions directed at E c: Problem/rule change e: Expression of interest/surprise M: Boy
 b: Monitoring action d: Comment about material/task f: Completion of task P: Girl

Time Taken for Problems

The times taken by subjects to complete each problem were measured, and the mean time for each age group with each problem was calculated. No patterns emerged of a relationship between age and the time taken to complete the problems. However, problem (iii), the projection of the equilateral triangle had the least mean time of 7.0 seconds, with a range of 3-14 seconds for the whole sample. Problem (v), the projection of a square with one diagonal, had the greatest mean time of 49.6 seconds and a range of 15-125 seconds.

Summary for Projected Shapes (v)-(x)

1. Subjects made predictions by choosing those models which seemed appropriate for projecting the given shape. Correct predictions for problems (v) and (vi) were made by approximately 33% and 50% respectively of the subjects. The ages of these children ranged from 6-8 years.

2. All subjects except one 3-year-old predicted correctly for problem (vii), the triangle. Correct predictions for problems (viii)-(x) were made by more than 85% of all subjects.

3. Subjects 5-8 years of age were more consistent predictors of the correct models for problems (vii)-(x) than the 3- to 4-year-olds.

4. Those problems with triangular boundaries, namely (vii) and (viii), were solved by approximately 75% of the subjects 4-8 years old.

5. Problem (x) with triangular components, was solved by more than 70% of subjects 4-8 years old, and by one of the 3-year-olds.

6. Problems (v), (vi) and (ix), with square boundaries, were solved by the majority of 7- and 8-year-olds without assistance, or with verbal cues.

7. The 4- to 8-year-olds who solved problem (x) without assistance were evenly distributed over the age range.

8. The 6- to 8-year-old subjects in general showed better control in adjusting the position of the models than the 3- to 5-year-olds.

9. Subjects verbalized spontaneously while they interacted with the materials. The most frequent verbalizations concerned the materials and the tasks.

10. No attempts were made to change the rules for to create new problems with the projected shapes.

11. Fewer subjects indicated verbally that they had completed the task, than was the case with the fold-out shapes problems.

12. The range of categories of verbalization used by individual subjects was less than that for the fold-out shapes problems.

13. Subjects appeared to concentrate on the task rather than talk during the projected shapes problems. This may have been due to the necessity to focus on a screen 50-70 cm away from their hands.

14. The projected shapes problems did not generate as many categories of verbalization as the fold-out shapes problems. There were no instances of rule or problem changing, and with the exception of one 4-year-old and two 5-year-olds, there were no expressions of interest or surprise evoked by this problem.

II. THE REFLECTION PROBLEMS

Object Reflection Problems

Four separate tasks were given to sixty subjects in this investigation. Each task required a steel ball to be released from a shooter in an attempt to tip over a toy bear. In the first two problems the ball was required to make one bounce off the rubber wall before tipping the bear. Two bounces were required prior to tipping over the bear in the second two problems. The subjects were required to manipulate the materials and to make direct shots at the bear before performing the four tasks.

The purpose of this problem was to investigate the predictive behaviors of children aged 3-8 years in situations where the laws of reflection were involved. The predictive behaviors of these children were measured in terms of the adjustments made to the direction of the shooter. The results of the subjects' efforts in releasing the steel ball and their verbalizations for each of the problems are also recorded.

Predictive Behaviors

There were two transformations which could be performed in this problem. The shooter could be rotated about a pivot and the shooter could have its pivotal axis translated, that is the pivot point could be moved to another hole. One or both of these transformations were used by subjects in their attempts to aim the shooter to tip the bear under the stated conditions. Translations of the shooter were not employed as frequently as rotations.

Subjects were permitted at least five attempts at solving the task. Each attempt was rated 'positive' or 'negative' in the following way. When the initial aim was such that the ball approached the bear under the prescribed condition, it was rated 'positive'. The same rating was given when a rotation of the shooter took the path of the ball towards the bear. When the ball was released directly at the bear or in a direction perpendicular to a wall, or away from the bear, the attempt was rated 'negative'. A negative rating was also given when no change was made to the direction of the shooter. Each problem attempted by a subject was then scored '+' or '-' according to whichever sign was predominant in the first five shots.

The prediction behaviors for this sample of 60 subjects are shown in Table 18. The results for one 1-year-old were not recorded due to a malfunction in the recording system. Other spaces in the table indicate that the problem was abandoned for that subject. If an excess of '+' signs in the results of a subject is an indication of successful prediction, then approximately 25% of the sample displayed some understanding of the strategies needed to improve the direction of the shooter.

Table 19 shows the distribution of number of problems with positive predictions for each age group. With the exception of two 4-year-olds whose scores exceeded those of the 5- and 6-year-olds, and two 7-year-olds, who scored better than the 8-year-olds, there is a definite pattern of development in predictive ability with age shown in this table.

TABLE 38
 PREDICTION BEHAVIORS BY ALL SUBJECTS FOR
 OBJECT REFLECTION PROBLEM

Age Group	Problem	Subject									
		1	2	3	4	5	6	7	8	9	10
3	I	-	-	-	-	-	-	-	-	+	-
	II	-	-	-	-	-	+	-	-	-	-
	III	-	-	-	-	-	-	-	-	-	-
	IV	-	-	-	-	-	-	-	-	-	-
4	I	-	+	-	+	+	+	-	+	+	-
	II	-	-	+	-	+	-	+	-	+	+
	III	-	-	-	-	+	-	-	-	+	-
	IV	-	-	-	-	-	-	-	-	+	-
5	I	+	+	+	-	+	+	-	-	-	-
	II	-	-	-	-	-	-	-	-	-	-
	III	+	-	-	-	-	-	-	-	-	+
	IV	-	+	-	-	+	-	-	-	-	-
6	I	-	-	-	+	-	-	-	+	-	+
	II	+	-	-	+	-	+	+	-	-	-
	III	-	-	-	-	-	-	-	-	-	-
	IV	-	-	-	-	-	-	-	-	-	-
7	I	+	-	+	+	+	+	+	+	+	+
	II	-	-	-	+	-	+	+	-	+	+
	III	-	-	-	+	+	+	-	+	-	+
	IV	-	-	-	+	+	+	+	+	-	-
8	I	+	+	+	+	+	+	-	-	+	+
	II	-	+	+	+	-	+	-	-	+	+
	III	-	+	+	+	-	-	+	-	-	+
	IV	+	-	+	-	-	-	-	-	-	-

+ : Three or more correct predictions in the problem.

- : Less than three correct predictions in the problem.

TABLE 39
 DISTRIBUTION OF POSITIVE PREDICTIONS
 IN THE OBJECT REFLECTION PROBLEMS

Age Group	Number of Correct Predictions				
	4	3	2	1	0
3				2	7
4	1	1		7	1
5			3	3	4
6			1	5	4
7	2	4	1	2	1
8		4	3	2	1

Results

The distribution of subjects and the number of problems attempted is shown in Table 40.

TABLE 40
DISTRIBUTION OF PROBLEMS ATTEMPTED FOR EACH AGE GROUP

Age Groups	Number of Problems Attempted		
	4	3	2
3	2	2	5
4	2	5	3
5	6	2	2
6	2	5	3
7	9	1	-
8	7	3	-

The fourth problem was not attempted in the case of one 7-year-old and three 8-year-olds. These subjects did not display a comprehension of the strategies needed for improving their aim, and did not respond to the assistance provided by the interviewer.

A subject's purpose in each of these activities was to tip over the bear. On that basis the following list of categories was used to classify the solutions of subjects solving this problem.

- I. Subject does not tip the bear in any problem.
- II. Subject tips the bear in one problem.
- III. Subject tips the bear in two problems.
- IV. Subject tips the bear in three problems.
- V. Subject tips the bear in four problems.

The distribution of subjects in the solution categories is shown in Table 41. There were no subjects who tipped over the bear in each of the four problems in five or fewer attempts. Three tips were scored by 5% of the sample. These were aged 7 and 8 years. A total of 13% scored two or three tips, and almost 40% did not tip the bear once in the prescribed number of shots. There was one 3-year-old among those who scored twice. However, more than 85% of subjects scored in one attempt or did not score at all.

A number of subjects were permitted to operate the shooter more than five times. An analysis of the results for these subjects showed that two 7-year-olds and one 8-year-old scored four times in 10 or fewer attempts, and approximately one-fourth of the subjects scored three or more tips under these conditions. On this occasion only 17% of the sample remained scoreless.

Verbalizations

A wide range of spontaneous verbalizations was evoked by the object reflection problems. The same categories used to classify the verbalizations in the projected shapes problems were used to analyze the verbal behaviors of the 60 subjects in this problem. These were:

- a. Question directed at E.
- b. Monitoring of action.
- c. Problem making or rule changing.
- d. Comments on the materials or the tasks.
- e. Expressions of interest or surprise.
- f. Indication that task was completed.

The majority of subjects in each age group spoke to the

TABLE 4)
 DISTRIBUTION OF CATEGORIES OF SOLUTION
 FOR OBJECT REFLECTION PROBLEM (55 SHOTS)

IV					M M	M
III	M				M	M F
II	F F	M F M F	M F M F	M F M F	M F M F	M M M M M F
I	M F M F	M F M F	M F M F	M F M F	M F M F	F F
	3	4	5	6	7	8

M: Boy
 F: Girl

interviewer or to themselves during the solving of these problems, and a variety of comments within any one category was noted. Questions directed at the interviewer were, in the main, asked to clarify interpretations of the problem, to determine how such a problem may be changed, and to seek information. For example, a 6-year-old asked, "That wall?", a 7-year-old tested the interviewer with "What if I bounce through those blocks?" and "What if I make it in one bounce?" while a 3-year-old enquired, "Shall I pull it hard?"

Thus, statements which monitored a subject's action (category b) included, "I'm going to shoot from here," and "I'll move it this way" and "I'm going to try this one."

Statements from all age groups related this problem to real-life situations. A 3-year-old girl remarked "Then I'll put it in this hole (nearest to the bear) right here so I can kill it," and an 8-year-old boy said, "Now we'll make a firing squad against this wall."

Statements about the material or the task were most common as in the previous problems. A 5-year-old commented, "Say! I didn't do that well!" and a 6-year-old said, "I think that's easy." An 8-year-old commented, "I hope it is put out of its misery!" Another 8-year-old indicated that he had attained the goal by calling out "Bullseye" and a 5-year-old said "I got it."

The frequency distribution of subjects in each age group and their categories of verbalization is shown in Table 42. Statements or expressions which indicated the completion of the task formed the category with the least number of subjects. In each of the problems the interviewer frequently indicated success by exclaiming "you did

TABLE 42

DISTRIBUTION OF SUBJECTS IN VERBALIZATION CATEGORIES FOR OBJECT REFLECTION PROBLEM

Categories of Verbalization

	F		M M	M F M	M M
	M F	M F	M M M	M	M M M F
	M M F	M M F	M M M F	M M F F	M M M F
	M F F	M F	M M	M M F	M
	F F	M M M	M M M F	M M F F	M M F F
	M F		M M M F	M M F	M M F

3 4 5 6 7 8

Age

M: Boy
F: Girl

it." This did not stop a 5- and a 7-year-old from concluding the problem with expressions such as "I got it."

Comments about the task and about the materials were made frequently by subjects in each age group. These included "I think that's hard" from a 7-year-old and "I just wanted it to go like that" from a 6-year-old.

The reality which subjects brought into the situation has already been mentioned. An illustration of this verbal behavior occurred when a 5-year-old, addressing the ball, said "Watch where you are going!" When this subject had difficulty getting the ball into the shooter he added "It would like not to get in there."

Table 43 illustrates the range of verbalizations used by each subject for the object reflections problems. One 5-year-old boy used expressions in all six categories while another 5-year-old and a 6-year-old employed five categories. With the exception of 3- and 6-year-olds, boys employed a wider variety of verbalization categories than the girls. As the age level increased more subjects used expressions to monitor their actions. Only the 8-year-olds did not make any rule changes for this problem.

The distribution of the number of verbalization categories for each age group is shown in Table 44. Of the sixty subjects in this investigation, 13 used only one category of spontaneous verbalization, 10 used two, 9 used three, and 8 used four categories in their verbalizing. One-half of the 4-year-olds used only one category of verbalization.

TABLE 4)
 DISTRIBUTION OF VERBALIZATION CATEGORIES FOR EACH AGE GROUP
 IN THE OBJECT REFLECTION PROBLEM

3	a	b	c	d	e	f
M		X				
M						
M						
M						
F						
F						
F						
F						
F						
F						

4	a	b	c	d	e	f
M						
M						
M						
M						
M						
F						
F						
F						
F						
F						

5	a	b	c	d	e	f
M						
M						
M						
M						
F						
F						
F						
F						
F						
F						

6	a	b	c	d	e	f
M						
M						
M						
M						
M						
F						
F						
F						
F						
F						

7	a	b	c	d	e	f
M						
M						
M						
M						
M						
M						
F						
F						
F						
F						

8	a	b	c	d	e	f
M						
M						
M						
M						
M						
F						
F						
F						
F						
F						

a. Question directed at E c. Problem/rule change e. Expression of interest/surprise
 b. Monitoring action d. Comment about material/task f. Completion of task
 0 No record M: Boy F: Girl

TABLE 44
DISTRIBUTION OF THE NUMBER OF VERBALIZATION CATEGORIES
FOR EACH AGE GROUP IN THE OBJECT REFLECTION TEST

Age	Number of Verbalization Categories Used				
	5	4	3	2	1
3		1	2	2	2
4		1	1	1	3
5	1	1	1	1	2
6		1	2	1	2
7		2	2	3	1
8		1	3	2	3

Visual Behaviors

The sequence of initial visual behaviors was partly determined by the instructions given for each problem. The interviewer stressed the fact that the ball was to be released in such a direction that it would tip over the bear after bouncing off one (or two) wall(s). As the problem was explained the interviewer would reach over and touch the wall from which the ball was to rebound. In each case the subject's eyes followed the interviewer's hand as it moved from the shooter to the wall and then on to the bear.

All subjects followed the path of the ball after it had been released to determine the results of their actions. The behaviors of particular interest occurred prior to the releasing of the ball.

Individual behaviors observed were:

- I. S looks at the shooter.
- II. S looks at the wall(s).
- III. S looks at the bear.
- IV. S looks at E's hand pointing.
- V. S looks at S's finger tracing path of ball.
- VI. Some combination of the above.

The visual behaviors prior to releasing the ball of those subjects who were successful in tipping the bear two or three times were analysed to determine any common elements. The range of visual behaviors for each success are shown in Table 45.

These subjects centred their attention on the shooter at some stage of the aiming procedure. Two 7-year-olds and one 8-year-old (subjects C, D and G) used this strategy almost exclusively.

TABLE 45

RANGE OF VISUAL BEHAVIORS SHOWN BY SUBJECTS TIPPING BEAR
TWO AND THREE TIMES FOR EACH SUCCESS

Age	Subject		Range of Behaviors
3	A	(1)	I - II, I
		(11)	II - III, I
7	B	(1)	I - II - III
		(11)	II - I - II, I - II
		(111)	II - I - II, I - II
	C	(1)	I, I - II, I - III - I
		(11)	I
		(111)	I
	D	(1)	II I - II
		(11)	I
8	E	(1)	II - I, II, I - II - I
		(11)	II - III, I - II - III, I - II, II
		(111)	I - II
	F	(1)	II, I - II
		(11)	I - III - I - III, I, I - II
	G	(1)	I
		(11)	II - I

together with a close study of the path of the ball. These subjects adjusted the direction of the shooter in terms of the proximity of the ball's path and the bear.

The above subjects displayed some eye movements which included two or three categories of visual behavior. These included category II, looking at the wall, as part of their aiming procedure. Two of the three subjects who had three successes (B and E) displayed more variety in their eye movements, with particular attention to the wall. All subjects in the sample watched the path of the shooter to the bear, but those listed above appeared to use this visual feedback to greater advantage than the other subjects.

Two visual behaviors thus appeared common to the subjects listed above, namely:

1. a study of the point of impact of the ball with the wall, or the intended point of impact (category II combined with others), and
2. corrections to the direction of the shooter based on the observed path of the ball (category I).

Furthermore, the three 8-year-olds and two 7-year-olds bent over to sight along the barrel of the shooter as part of their aiming strategy. Although 75% of subjects 5 to 8 years centrated on the shooter as a frequent behavior, those listed above appeared to identify those changes in direction of the shooter which were required to bring the path of the ball closer to the bear.

Aiming the Shooter

Different methods were used by subjects attempting to aim the shooter so that the ball would tip over the bear. One half of

TABLE 47
 DISTRIBUTION OF SUBJECTS IN POSITIONS FOR AIMING IN THE
 OBJECT REFLECTION PROBLEM

					M	F
IV		M			M†	F
III		M	M		M M*	M M* F*
II					M M M† M*	M M M* F
I					M F*	F*
	3	4	5	6	7	8

* , † : Subject in 2 or 3 categories

M: Boy
 F: Girl

subjects brought their eyes to the level of the shooter and close to it. At the same time they were in a position to control the direction of the shooter and aim simultaneously. The nine subjects who stooped down to aim were able to adjust the position of the shooter. The five subjects who aimed by leaning back and the seven who stood side-on were not able to exercise the same control as those in category II and III and those who sat down.

One 8-year-old girl adopted three of these positions but did not tip the bear once. Four boys and one girl employed two of these stances in their attempts to aim the shooter carefully. These subjects scored on five occasions.

Of the 29 subjects in these categories, three 8-year-olds, one 7-year-old, one 6-year-old and two 5-year-olds were girls. Thus, this aiming behavior was exhibited in the main by boys.

Subjects who leaned over to aim tipped the bear on 15 occasions, those who stooped on eight occasions, and those who leaned back on five occasions. Those who stood side-on failed to score. Thus the procedure of bending over to aim the shooter proved, on a pro rata basis, to be the most successful.

Subjects were informed that the shooter could be aimed by rotating it in a pivot hole or by moving it to another hole. This later strategy was employed by 22 subjects from all age groups. The distribution of subjects who moved the shooter is shown in Table 48.

The instructions given to each subject emphasized that the ball had to hit the wall first and then tip the bear. It was observed that 17 subjects projected the ball directly at the wall on at least

TABLE 48
FREQUENT BEHAVIORS DISPLAYED IN THE
OBJECT REFLECTION PROBLEM

Behavior	Number of Subjects in Each Age Group					
	3	4	5	6	7	8
Moved shooter to different holes	4	3	3	4	4	4
Pointed shooter direct at wall	1	5	4	4	1	2
Pointed shooter direct at bear	8	2	3	4	1	1

one occasion, and one 4-year-old continued with this behavior. The other subjects responded either to the visual feedback from the direction of the ball or to the verbal cues which were given by the interviewer and changed the direction of the shooter.

Pointing the shooter directly at the bear or at the blocks which were placed between the bear and the shooter was a strategy employed by 19 subjects distributed over the age range as shown in Table 48. Three-year-olds were slow to accept the idea of bouncing the ball off the wall, and reverted to the direct approach when they did not succeed in tipping the bear after projecting the ball towards the wall. This behavior was also displayed by 6-year-olds, but less frequently in the other age groups. One 3-year-old, unable to successfully tip the bear by using the shooter, pushed the blocks away and directed the ball at the bear with her hand. A 4-year-old solved her problem by moving the bear to a more accessible position after a succession of failures.

Subjects 7 and 8 years of age displayed better comprehension of the problems and persevered with the rules more than the younger subjects.

Summary for the Object Reflection Problem

1. Subjects in all age groups showed keen interest in the tasks, although the 3-year-olds appeared to be more intent on tipping over the bear than with working out the procedure to be followed.
2. The 3-year-olds, with the exception of two subjects, did not display any consistent problem-solving strategies. In a result six subjects did not score a hit. The subjects who did succeed after

two problems in the case of five 3-year-olds, and after three problems with two from this age group.

3. Subjects 4, 5 and 6 years old displayed more ability than the 3-year-olds to modify the direction of the shooter in order to improve their aim. More than 50% of subjects in these age groups scored one hit.

4. Two or more tips were scored by three subjects in each of the 7- and 8-year-old groups, and 50% scored one tip. These age groups displayed better prediction behaviors than the younger children, although problem IV was abandoned in the case of one 7-year-old and three 8-year-olds.

5. Eye movements varied from subject to subject as they aimed the shooter. These visual behaviors involved one or more of the following: (1) S looks at the shooter, (2) S looks at the wall, (3) S looks at the bear, (4) S looks at E's finger tracing the path required.

6. All subjects visually followed the path of the ball after it had been projected.

7. Subjects aimed the shooter from a standing position, by bending over and sighting along the barrel or by stooping down.

8. Approximately one-third of the subjects distributed equally over the age range, moved the shooter to different holes as a means of improving their aim. This was a successful strategy for the 7- and 8-year-olds, but the 3-year-olds were attempting to find a better position to aim directly at the bear.

9. The shooter was aimed at right angles to the wall by

10% of subjects, only two of whom were over 6 years of age. By so doing, these subjects indicated low comprehension of the reflection properties inherent in this problem.

10. The majority of 3-year-olds reverted to aiming the shooter directly at the bear when they did not succeed in the bouncing task.

11. The object reflection problems evoked spontaneous verbalizations in all categories from subjects in all age groups. Those which occurred most frequently were comments on the materials and the task.

12. Statements by subjects in all age groups related the tasks to real life situations.

13. Fewer categories of verbalization were employed by individual subjects than occurred with the fold-out shapes problem. Relatively few subjects in each age group gave indications that the task was completed. Few subjects 3 to 6 years asked questions of the interviewer. The number of subjects who made comments on the task and the materials was also less than for the fold-out shapes problem.

The Mirror Reflection Problems

The introductory exercises in this problem permitted a subject to become familiar with the material, which consisted of a flashlight pointer, a board of the same dimensions as those of the object reflection problem but having walls mounted with plane mirrors instead of rubber. A target screen with silhouettes of four animals, an elephant (E), a lion (L), a bear (B) and a deer (D) was situated on the board. A flashlight was pivoted so that the spotlight could be moved from one animal to another. Each subject was required to move the

flashlight so that the transformations D - E and L - B were performed. Once a subject had completed sufficient direct illumination exercises to indicate that he could move the flashlight successfully, two reflected light problems were introduced. The behaviors of subjects solving these two problems were recorded and analyzed in a manner similar to that employed in the previous object reflection problem.

One Reflection Problem

The first problem required the spotlight to be moved from the deer to the elephant (D - E) with one reflection from the mirror. The interviewer then set the spotlight on the lion and informed the subject that the light was about to be switched off and he would be asked to move the flashlight so that the spotlight would be on the bear after one reflection off the mirror. After the subject had moved the flashlight, the light was switched on and his prediction confirmed or his strategy corrected.

Predictions - Problem 1

Thirty subjects were required to make two predictions in this problem. The first was made with the flashlight switched on. All subjects were asked to rotate the flashlight in such a way that the spotlight moved from the deer to the elephant. The second prediction was made with the flashlight turned to the lion and then switched off. Subjects were asked to turn the flashlight so that the spotlight would be on the bear when the flashlight was switched on.

Five solution categories were used for classifying the results.

They are as follows.

- I. Problem abandoned.
- II. Incorrect prediction followed by incorrect prediction.
- III. Correct prediction followed by incorrect prediction.
- IV. Incorrect prediction followed by correct prediction.
- V. Correct prediction followed by correct prediction.

The interviewer endeavoured to help each subject become aware of the light path from the flashlight to target, first by pointing out the direction in which the flashlight was pointed, and by tracing with a finger the path of the light beam. The effect of placing a hand in the path of the light beam was also demonstrated.

The distribution of solution categories for this problem is shown in Table 49. Two 3-year-olds were classified in category I when the problem had to be abandoned due to lack of comprehension of the task. These subjects pointed the flashlight at the mirror opposite where they were seated, and made no attempt to put the spotlight on the target. Three 3-year-olds were able to rotate the light correctly when switched on. However, when the light was switched off for the second prediction, two of these subjects turned the flashlight to point directly at the target. The third 3-year-old rotated the flashlight in the wrong direction, and appeared to be aiming the back of the flashlight at the target. These subjects were recorded in category III. Seven subjects were presented with the first prediction task but not the second. Four of these made correct predictions and were recorded in category III with an asterisk. Three made incorrect first predictions and were recorded in category II. In the case of

TABLE 49

DISTRIBUTION OF SOLUTION CATEGORIES FOR MIRROR REFLECTION PROBLEMS - ONE REFLECTION

Category of Solution

*Special prediction not required

M: Boy
F: Girl

the 3-year-olds, the interviewer continued to give further experiences of the one bounce problem and did not present the second prediction problem to these subjects. The light was not switched off for the second problem with the 4-year-olds. He made a correct rotation the second time. Two 5-year-olds listed in category III, who made incorrect predictions when the light was turned off, were observed to be holding the flashlight so that the beam was pointing to the target. It may be surmised that these subjects were confused with the flashlight was employed in an unusual way.

Nine subjects, including one 3- and one 4-year-old, were able to make two correct predictions. Three subjects, aged 6, 7 and 8 years, were able to correctly predict the rotation when the light was turned off, after having incorrectly predicted in the first case.

This problem appeared to be confusing to the majority of subjects under 7 years of age.

Two Reflections Problem

As in the previous problem, subjects were asked to make two predictions. The interviewer arranged the flashlight so that the spotlight reflected onto the bear off two mirrors. Subjects were asked to predict which way the flashlight should be turned so that the spotlight moved to the elephant, and to indicate their prediction by making the transformation.

After the interviewer had set the spotlight on the lion with two reflections, the flashlight was switched off. Subjects were then asked to predict the rotation necessary for the spotlight to move to the bear and to perform that rotation.

Predictions - Problem II

The procedures for this problem were identical with those of problem I. The light was reflected off two mirrors onto the target. Subjects were again asked to make two predictions, the first with the light switched on and the second with the light switched off. The categories of solution for problem I were used to classify the prediction behaviors in this problem. The results are shown in Table 50.

The problem was abandoned with four 3-year-olds and one 4-year-old. Two of these subjects continued to aim the flashlight directly at the target and the other two had not comprehended problem I and were not presented with this problem.

Twenty percent of the subjects (from 4 to 8 years) were observed to predict correctly in both cases, and 17% were able to predict the second relation correctly after failing in the first prediction. There were four subjects to whom the second prediction task was not presented. These were recorded in category III (with an asterisk), having made a correct first prediction.

The distribution of subjects in categories IV and V includes subjects from all age groups. Indeed, the distribution of solutions in each category is remarkably uniform if the 3-year-olds are omitted.

Verbalizations

The mirror reflection problems evoked fewer spontaneous verbalizations than any of the previous problems although the subjects spoke more often. This problem necessitated a great deal of questioning by the interviewer to ensure that the subjects understood the

TABLE 50

DISTRIBUTION OF SOLUTION CATEGORIES FOR MIRROR REFLECTION PROBLEM - TWO REFLECTIONS

Category of Solution	4					
	3					
	2					
	1					
	0					
		3	2	1	0	
	3	4	5	6	7	8

*Second prediction not requested

B: Boy
G: Girl

task. Thus each action was accompanied by a question and this was usually associated with the task or the material. Thus an opportunity to talk about the material was provided and this would have reduced the number of task/material oriented statements made by the subjects.

Each step in the problem was carefully presented, and this would have contributed to the smaller number of questions directed at the interviewer.

Categories of verbalizations used to classify the verbal expressions of subjects in the previous object reflection problem, and used for this problem, were:

- a. Question directed at S.
- b. Monitoring of action.
- c. Problem making or rule changing.
- d. Comments on the materials or the tasks.
- e. Expressions of interest or surprise.
- f. Indication that task was completed.

The distribution of subjects in each age group and their categories of verbalization are shown in Table 51.

Questions asked by the subjects included, "Which way will it turn?" and "Can you move it?" Monitoring statements occurred such as, "Okay, now I'm gonna turn it onto the elephant," and "Let's see, here's one, —and two." One subject commented on the faint spotlight. He said "That's a very bright light." Comments on the materials included, "The bear is kind of small, so I can't get onto him," and another said, "My dad has a flashlight and this is just like a flashlight."

One subject expressed a wish to change the problem or rule.

TABLE 51

DISTRIBUTION OF SUBJECTS IN VERBALIZATION CATEGORIES FOR THE MIRROR REFLECTION PROBLEM

Verbalization Category

Age 3 4 5 6 7 8
M: 24
F: 21

although one 6-year-old boy exclaimed "I want to see the door," when the spotlight was on the elephant.

This problem, like the projected shapes problem, evoked fewer spontaneous verbalizations than either the fold-out shapes or the object reflections problems.

Visual Behaviors

It was necessary to reduce the amount of light in the room so that the spotlight could be seen on the target. Eye movements were directed to the flashlight and the target except when subjects were prompted by the interviewer to locate the light beam. In those instances subjects used their hands to block the light or moved their heads until they saw the light reflected in the mirror. In this way they were able to locate the points of incidence and trace out the path of the beam of light.

Visual behaviors, when the flashlight was turned off and a prediction was required, took a pattern similar to those in the object reflections task. These behaviors were:

- I. S looks at the flashlight.
- II. S looks at the target.
- III. S looks at the mirror.
- IV. S follows an imagined or partially illuminated path of light.

Identification of many eye movements were made difficult by the light conditions necessitated by the problem. Furthermore, much of the visual behavior was in response to directions and assistance given by the interviewer. However, certain behaviors were observed

to occur frequently.

Looking at the flashlight (I) and at the target (II) were the most frequently observed behaviors for all subjects. Other eye movements which occurred less frequently were as follows.

(i) Looking from flashlight to target (I - II) was observed with four 3-year-olds, two 4-year-olds, all 5-year-olds, one 6-year-old, three 7-year-olds and three 8-year-olds.

(ii) Looking from target to flashlight to target (II - I - II) was observed with one 3-year-old, two 4-year-olds, three 5-year-olds, two 6-year-olds, three 7-year-olds and one 8-year-old.

(iii) Looking from flashlight to mirror to target (I - III - II) was observed in two 3-year-olds, one 4-year-old, three 5-year-olds, three 6-year-olds, two 7-year-olds and two 8-year-olds.

Although specific aiming behaviors were not a factor in this problem, observers commented that the boys in this sample maneuvered the flashlight with greater control than the girls.

Summary for the Mirror Reflection Problem

1. During the introductory exercises, all subjects in all age groups were able to maneuver the flashlight to make the spotlight move correctly from target to target. Movement under direct illumination did not present any problem.

2. Three-year-olds were confused with the ONE reflection problem. Although three were able to predict the correct position when the light was switched on they were unable to do so when the light was switched off. These subjects turned the flashlight to point directly at the target.

3. The majority of 7- and 8-year-olds were able to make two predictions, or if the first was incorrect, they were able to predict correctly in the second problem.

4. The TWO reflection problem was abandoned in the case of four 3-year-olds. The remaining 3-year-old was able to make a correct second prediction in the problem.

5. One subject from the age groups 4, 7 and 8 years and two 5-year-olds were able to make two correct predictions.

6. Subjects in categories III, IV and V were reasonably well distributed over the age range 4-8 years. No age group appeared to perform at a level superior to the others.

7. Although the 7- and 8-year-olds appeared to find the TWO reflection problem more difficult than the ONE reflection problem, the majority of 5-year-olds had solutions in categories IV and V.

INVESTIGATOR RELIABILITY

A reliability check was performed by two graduate students one of whom was a doctoral candidate. One subject from each of the age groups was selected by random sampling. The judges viewed the tapes independently, and used the same coding system devised for this study. The order in which the subject's videotape records were viewed was also randomly selected and the judges used the same order to transcribe the data from the tapes. The judges selected the fold-out shapes problem for the reliability evaluation, limiting the problem to three behaviors involving the cube. Thus, the data collected by the investigator on the six problems associated with the cube were

compared with those of the two judges. The time taken by the judges to analyze the data for one subject ranged from thirty minutes to more than two hours. After each judge had analyzed the data for one subject, a consultation was held with the investigator during which agreements and disagreements between the coded data sheets were discussed.

Arrington's method for obtaining a measure of reliability of observations between observers (Scott, 1933, p. 67) yielded percentage agreements as shown in Table 52. A mean percentage agreement of .925 was established for the whole sample of behavior records evaluated.

CONCLUDING REMARKS

The four problems were successful in generating problem-solving behaviors in this sample of 3- to 8-year-olds. All age groups were able to manipulate the materials devised for the four problems. The fold-out shapes material and the object reflections material provided the subjects with tangible products of their manipulations and more manipulative control was demonstrated in these problems.

The problems presented a variety of kinds of predictions. The 'fold-out shapes' required a subject to predict whether an arrangement would fold into a cube. The 'projected shapes' required a subject to select a model which would make a particular shadow. The object reflections and the mirror reflections tasks both required a subject to predict the direction of a rotation required to make a given transformation. All provided the subject with the opportunity to verify his predictions.

TABLE 52
 INVESTIGATOR-OBSERVER COEFFICIENTS OF
 AGREEMENT FOR FOLD-OUT SHAPES PROBLEM

Subject	Coefficient of Agreement	
	Investigator vs Observer 1	Investigator vs Observer 2
1	.882	.892
2	.927	.907
3	.942	.970
4	.949	.928
5	.967	.949
6	.899	.896

Mean Coefficient
 of Agreement = .925

Subjects displayed a variety of 'fold-up' behaviors which were identified in a set of sequences. Physical behaviors were not so easily catalogued in the other problems.

Verbalizations occurred in all problems. However, verbalizations were much fewer and less diverse in the two problems that employed a light beam. This was possibly due to the intangible nature of the products of the transformation and to the degree of concentration needed to gain effective control. The projected shapes problem required more hand-eye coordination than the other problems.

The projected shape and the mirror reflection problems generated fewer rule change verbalizations than their equivalent problems.

Subjects in all age groups were able to manifest success in varying degrees in all problems and this was evident in both sexes. However, the degree of success attained in the object reflections problem was less evidenced than in the others.

In the reflection problems, the 7- and 8-year-old boys displayed a higher percentage of success than the girls with the object reflections, whereas the reverse was the case with the mirror reflections.

The object reflections problem evoked verbalizations indicating some aspect of reality. The other problems did not do this to the same degree. The fold-out shapes and the object reflections tasks generated expressions of interest and surprise. Only in a very small number of subjects was it necessary to abandon problems due to lack of interest on the subject's part.

Chapter IV

SUMMARY, THE OBSERVED PROBLEM-SOLVING BEHAVIORS; THE CRITERIA OF GOOD PROBLEMS, IMPLICATIONS FOR FURTHER RESEARCH AND CONCLUDING REMARKS

This final chapter contains an overview of the study and a summary of its findings. The general problem-solving behaviors which were observed are then discussed with respect to literature on the subject and other research findings. The criteria for good problems are discussed with respect to the findings and the chapter concludes with implications for further research.

SUMMARY OF THE INVESTIGATION

The purposes of this investigation were:

A. To collect the behaviors exhibited by a sample of children, aged 3-8 years, while they were engaged in solving four spatial relationship problems. These problems were:

- (i) the fold-out shapes problem,
- (ii) the projected shapes problem,
- (iii) the object reflections problem, and
- (iv) the mirror reflections problem.

B. To analyse and classify these behaviors.

The behaviors of the children as they solved these problems were recorded on half inch videotape. These videotapes became the data source for this investigation. No information of a demographic nature was obtained for this sample of children.

The problems were presented to each child individually by an interviewer who remained present for the duration of each task. The

interviewer was available to answer questions, to support materials which had been raised by a child, and to provide verbal and other help when these were needed. In this way an effort was made to facilitate the activities of each child.

I. The Fold-Out Shapes Problem

The Cube

As the fold-out shapes problems were presented, a typical response of the 3- and 4-year-olds was an attempt to fold up the shapes. There was a general resistance to the suggestion that they make a prediction about the foldability of the layout before they started folding. Although the interviewer reminded those who resisted making a prediction that they were to predict before folding, about half the 3- and 4-year-olds still failed to make any prediction at all, and were permitted to proceed with the folding process. The proportion of those who would not make a prediction changed only slightly from shape A to shape F. Shapes A-F are shown on pages 15-16.

A small proportion of 3- and 4-year-olds predicted that shape A would fold into a cube. Approximately the same proportion said it would not. While there was a general decrease in the proportion predicting that shapes B, C, D and E would not fold, there was a corresponding increase in the proportion of those who seemed confident that these shapes would fold. Those who thought that shapes B, C and D would fold were correct, but were wrong for shape E which could not be folded into a cube. The proportion of those who thought that shape F would fold decreased and there was a corresponding increase in the

proportion of those who predicted that shape F would not fold.

The 5- and 6-year-olds also showed a tendency to start folding before a prediction was made when the fold-out shapes problems were introduced. They too were reminded by the interviewer that a prediction should be made before they folded the layout. A little less than one-half of the children in these age groups still would not make any prediction for shapes A, B and C, even though they experienced a sequence of shapes which they were able to fold up into cubes. For shape D the proportion of 5- and 6-year-olds who made no prediction increased. When shapes E and F were introduced, the proportions who failed to respond were the same as for shapes A, B and C.

Approximately one-half of the 5- and 6-year-olds predicted that shapes A to E would fold into cubes, while a relatively small proportion of these age groups predicted that these shapes would not fold. After observing that shape E would not fold, the proportion of 5- and 6-year-olds who thought that shape F would fold decreased sharply, and there was a corresponding increase in the proportion of these age groups who predicted that shape F would not fold.

A slightly smaller proportion of 7- and 8-year-olds than that of the 5- and 6-year-olds would not make any prediction about shapes A, B and C, while more than half of these age groups thought that these shapes would fold into cubes. In all cases children observed that these shapes did fold up. However there was an increase in the proportion of 7- and 8-year-olds who did not make any prediction when shapes D and E were presented. This was accompanied by a decrease in the proportion of those who predicted that shapes D and E would fold, and

a slight increase in the proportion of those who thought that they could not fold. When these 7- and 8-year-olds were asked to predict if shape 7 would fold almost all indicated that it would not fold.

A comparison of the results for the two sets of problems, the foldable and the unfoldable shapes, showed that as the age level increased the proportion of those who would not predict decreased in both sets, and in each age group the proportion of those who thought that the unfoldable shapes would fold was slightly less than that which predicted that the foldable shapes would fold. The one exception was the group of 8-year-olds, the majority of whom recognized that the second set contained unfoldable shapes.

All children were asked to fold up the first four shapes, and the fold-up procedures varied from child to child. Generally the younger children tended to use unstructured folding patterns such as raising and lowering squares, raising squares on opposite sides or at opposite ends which did not immediately result in joins being made. These children were helped by the interviewer who supported squares which had already been raised. Other children who did not seek this support used their arms and bodies to keep these squares upright while they attended to other squares on the layout.

The 6- to 8-year-olds generally used structured sequences when forming their cubes. There were also a few 4- and 5-year-olds who constructed their cubes with well organized sequences. In this way a complete fold up occurred or two half-bones were formed which needed one simple rotation for the cube to be completed. The majority of children completed folding the first four hemispheres, most of the

older ones without any assistance, some of the younger ones with cues and assistance from the interviewer.

Shapes E and F would not fold up. Those who thought that these shapes would not fold were not asked to verify this although a few older ones did. The children who predicted that they would fold or who would not predict, were asked to verify their predictions or to explore the possibility of the shapes folding up. The majority of 3- to 7-year-olds made several attempts to fold shape E, trying a variety of joins and rotations before deciding that it would not fold. The 6-year-olds took little time or effort to reach this conclusion. When shape F was introduced the majority of children in all age groups made only brief attempts to fold it before indicating that it would not fold because the array was "too long" or because there were "no side pieces."

When asked to modify shapes E and F so that they would fold up, the majority of children transformed these to shapes A and C, although a small proportion initially formed some other unfoldable shape.

The Tetrahedron

Children were given four equilateral triangles and asked to make a box which looked like the wire frame which had been placed on the table. They were reminded that the Velcro edges had to be matched properly if the joins were to be firm. Some of the 3- and 4-year-olds appeared uncertain as to where they should begin, and in these cases the interviewer demonstrated how to join two triangles. When the triangles were brought together on the table there was no

difficulty is aligning the edges. However, some difficulty was experienced in aligning edges when the triangles were held in the air, and some younger children had to make two or three attempts before they made a satisfactory join.

The four triangles were joined in several ways. The 3-year-olds tended to form layouts which they were unable to fold into any kind of a pyramid, and the interviewer then demonstrated one of the methods. Almost one-half of the 4- to 6-year-olds initially formed square pyramids, but were able to modify these to complete the tetrahedron either with no help at all, or with a minimum of cues and assistance. This shape was also constructed by joining triangles to the three sides of a base and bringing the top vertices together. Many of the older children stood the triangles at right angles to the base of the table, a procedure which interfered with the solution of the problem. Others placed the bases of the upright triangles either perpendicular or parallel to each other, and even in line with each other. Only when they stood the triangles obliquely were the children successful in completing the tetrahedron. Approximately half the children, including one 3-year-old, folded this shape without assistance. However this ability was clearly age related.

Many children verified that the shape they had formed was similar to the wire model by placing them side by side, or by fitting the model over their construction. This latter method made the comparison very simple and most of the older children were quick to identify the differences in shape when they fitted a square pyramid over the wire model.

Only a few children could make predictions about the foldability of shape N, and those were 5-, 6-, 7- and 8-year-olds. The 3- and 4-year-olds would not predict but immediately started to fold. When shape J was presented some of the 8-year-olds could recognize that it would not fold. However the predictions of other age groups changed very little from shape N to shape J except for the 3-year-olds, some of whom incorrectly thought that shape J would fold, having observed that shape N folded.

Two-thirds of the children in all age groups were able to fold shape N into a tetrahedron without any assistance. One method used frequently was to hold the end triangle upright and then raise one of the inner triangles to bring the adjoining edges together to make the required joins. Another method was to rotate the triangles successively from one end until all the joins had been made and the tetrahedron completed. The tendency to try to arrange the triangles perpendicular to each other rather than oblique to each other appeared to interfere with the solving of the problem.

The arrangement of triangles around a common vertex which constituted shape J readily folded into a square pyramid, and this was the only solution presented by the majority of the children. One in five children, aged between 3 and 6 years, could not distinguish between the square pyramid and the wire model, while the majority indicated that they were different, but made no attempt to modify the shape. A few of the older children joined the first triangle to the third, forming a triangular pyramid with a triangular flap on one of the slant edges. This piece was removed and placed in its correct

position. The remainder removed one of the triangles from the layout, moved it to a position which formed a large equilateral triangle layout, and proceeded to raise the three sides to complete the tetrahedron.

The Dodecahedron

When the dodecahedron was presented, most children showed immediate interest and wanted to handle it. When they were asked to take it apart so that it would lie flat on the table, there were two dismantling procedures. A little more than a half of the children carefully detached each pentagon and arranged them so that some of them touched. The remainder unfolded the shape and flattened out the arrangement of pentagons, rejoining any which became detached in the process. When they were asked whether they thought the shape could be reassembled there was the same reluctance to predict as was shown in the previous fold-up problems.

In this problem the interviewers gave sufficient help to enable subjects to reassemble the dodecahedron. A great deal of assistance had to be given to some 3-, 4- and 5-year-olds, but the majority of 6-, 7- and 8-year-olds were able to assemble the shape with verbal cues or no assistance at all. As in the previous problems, there were notable exceptions to these solution levels. For example, one 3-year-old was able to reconstruct the dodecahedron with no assistance, and one 4-year-old piled the pentagons one on top of the other.

Children from all age groups who assembled the detached pentagons began by selecting one pentagon and attaching others to its edges, keeping the whole array flat. When these peripheral pentagons were raised and joined, the bottom half of the dodecahedron was formed.

where added the pentagons in the raised position, and obtained the same result. In both cases reorientation of pentagons had to be made to ensure that the Velcro edges matched. Subsequently further pentagons were added to the upper structure and the shape completed. Some of the older children had difficulty getting these pieces to fit. This occurred when upper pentagons were directed outwards instead of being oblique inwards. Some children who initially detached all the pentagons formed complete or partial nets before they started to fold. Generally there were sufficient pentagons which joined to form a partial fold up, but assistance was needed to reorientate the other pentagons to obtain Velcro edges which were compatible. Young children in particular ran their fingers over the Velcro to confirm by touch the nature of the surface.

The fold-up behaviors of those who had unfolded the dodecahedron varied. Younger children tended to work from both ends of the layout simultaneously, raising and lowering pentagons, and needed assistance to raise pieces which would join to form a stable structure. Frequently pentagons were raised to a vertical position and this interfered with these children recognizing the oblique form needed to make adjacent faces join. Raising all pentagons at one end of a layout and joining the remainder of the array to this assembly was the simplest method of folding up the dodecahedron.

The 6-, 7- and 8-year-olds who attempted to raise several pieces at a time were more successful than the younger ones who attempted this. In these cases the interviewer provided support by ensuring that the Velcro edges were joined firmly, and by helping to

prevent sections from collapsing. The strategy of raising three or four pieces was more successful when these were close to the child than when they were at the back of the array. Younger children also attempted to fit a pentagon at the top before sufficient side support had been established. The ability to assemble the dodecahedron without assistance was definitely age related, with the majority of 8-year-olds requiring no assistance from the interviewer.

II. The Projected Shapes Problems

The projected shapes problems were introduced by demonstrating how shadows could be produced on a screen by placing a hand in the beam of light. Children were encouraged to make their own shadows, and then to pick up wire models and make shadows with these. The models were rotated and interchanged so that a variety of shapes were observed. The 3- and 4-year-olds were helped to observe the effects of moving the models. The older children responded to the interviewer's suggestions to change the position of the models. Thus an opportunity was provided for children to observe that projected shapes or shadows could be changed by hand movements, and could be simple or complex depending on the orientation of the model.

In the previous problems children formed tangible stable solids, and controlled the formation of these shapes by manipulating parts of the shapes and by using visual perception. The ten projected shapes problems however, required children to project shadows which matched shapes drawn on cards. To do this an appropriate wire model had to be selected and orientated in a beam of light supplied by a projector. An important difference between this and the fold-out

shapes problems was the dynamic and complicated nature of the shadows which changed in structure and complexity with each hand movement.

The majority of children in all age groups were able to choose the correct wire model for projecting the ellipse, the parallelogram and the triangle. However, children 3 to 6 years needed assistance and cues from the interviewer to orientate the circle in order to produce the ellipse. Most of these children appeared content to hold up the model, and produce some shadow. The 3-year-olds in particular held the model between themselves and the screen, and the interviewer had to hold out their arms so that shadows could be cast on the screen. The majority of 7- and 8-year-olds however, were able to produce the ellipse unaided.

One-half of the 3- to 6-year-olds simply projected the rectangle when a shadow in the shape of a parallelogram was required. When the wire rectangle was suspended in a vertical plane, a rectangular shadow was produced. However, it was necessary to hold this model in a plane oblique to both vertical and horizontal planes in order to form a shadow in the shape of a parallelogram. All 7- and 8-year-olds were able to accomplish this without assistance. With few exceptions, the younger children either needed cues to produce the parallelogram or made a rectangular shadow which they thought was a solution.

The projection of the triangle did not present any problem. All children were able to select the triangular model and suspend this to produce the equilateral triangle.

The projection of a straight line was the first problem in

which shadows had to coincide, and 3- to 5-year-olds found this problem difficult. The immediate reaction by most children when the problem was presented was to look at the models on the table. After a brief study of these models they said it could not be done. The interviewer encouraged them to try one of the models available. The majority of 3-year-olds did not appear to understand the idea of making shadows coincide and did not make this shape. Children 4 to 5 years projected the straight line with assistance, cues or demonstration by the interviewer, while all 6-, 7- and 8-year-olds produced this shape without assistance or with verbal cues alone.

The orientation of the projected shadows did not seem to be important to the 3- to 5-year-olds. These children identified the shapes they had produced whether they were oriented horizontally (shown on the card), vertically or obliquely. Children in all age groups projected the ellipse with a vertical orientation. This was the form produced by most of the 3-year-olds, while older children responded to the interviewer's assistance and cues to reorient the ellipse to match the illustration. The majority of 7- and 8-year-olds did not require any assistance or cues.



The parallelogram was oriented obliquely by half the 7- and 8-year-olds who were generally more concerned with the production of the shape of a parallelogram than the others who simply formed a rectangle. In most cases, the orientation of the straight line was horizontal.

The younger children tended to alternate their attention between the model and the shadow. The older children appeared to be able to manipulate the model while looking at the screen. By

doing this they appeared to exercise greater control over the changes to the shadow, and to observe the effects of adjustments made on the model. This was an important consideration in this problem, for there were occasions when a solution was reached but the child was looking at the model at that moment, and by the time they looked at the screen the shadow had changed. When the interviewer drew their attention to this fact, the majority of these children, including the 8-year-olds, were unable to reverse the movement of the model.

The shapes projected by the plane wire models without any assistance from the interviewer were, with very few exceptions, produced by children aged 6, 7 and 8 year.

Three wire models, a square pyramid, a tetrahedron, and an octahedron, were used for projecting the six complex shapes (v) (x). These shapes were formed by superimposing shadows, a task which had already been found difficult for most of the younger children. These problems were abandoned for most of the 3-year-olds. Even some older children appeared to be puzzled by the disappearance of shadows, a phenomenon which they observed during the introductory exercises.

Shapes (v) and (vi),  and , had square boundaries. The majority of children had great difficulty in selecting the correct model, and in projecting these shapes after they had been told which shape they should use. These two shapes were produced without assistance or with cues only, by 7- and 8-year-olds, while the majority of children 3 to 6 years were unable to project these shapes. Only a few 4- to 6-year-olds were able to produce these shapes with assistance.

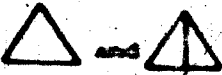
Shapes (vii) and (viii).  had triangular boundaries, and these children had no difficulty in selecting the correct model for projecting both shapes. The majority of children aged 4 to 8 years were successful in projecting these shapes without assistance. Relatively few were able to control the orientation of the tetrahedron so that complete coincidence occurred. The 6-, 7- and 8-year-olds were able to project these shapes with little or no assistance.

Shape (ix). , also had a square boundary. Two of the three models were appropriate for projecting this shape and these children had no difficulty in choosing one of these. However, only the 7- and 8-year-olds, together with one 3-year-old and one 6-year-old, were able to project this shape without assistance. A small number of 3- to 6-year-olds were unable to form both diagonals in this diagram. Approximately one-third of the children, mainly 4- to 7-year-olds, required either demonstration, assistance or verbal cues before they were able to achieve the required coincidence.

The tenth shape, , was the most complex in appearance. The correct model was selected by all except three children. When questioned as to why they had selected that shape, some said that it had more lines than the other shapes, and others indicated that it was the only shape which had not been used for any of the previous problems. The 3-year-olds were not able to obtain the horizontal coincidence which was needed to match the diagram, while almost one-third of those aged 4 to 7 years were given assistance to obtain a solution. More than one-half of the children aged 4 to 8 years

were able to produce this shape unaided.

Three of these six shapes proved to be more difficult than the others for the majority of children to project. These were the shapes with square boundaries. Two of these required the square base to be held in an oblique plane. Although the majority of children concentrated on the screen, the movements of the 3- to 5-year-olds appeared to be more random than those of the older children. When these younger children appeared to be approaching a solution, they were encouraged to continue with that move or rotation by the interviewer, but almost invariably they were not able to maintain that strategy and they resumed with a complex shape which did not resemble the diagram they were trying to copy. The 7- and 8-year-olds generally made a systematic study of the shadows cast when the model had a particular orientation, and were able to identify when a rotation of the model was leading towards the required shape.

Very few children commented on the orientation of the shadow when it differed from that of the diagram. The most frequent variation occurred with shape (v) when more than half of the shadows formed were reflections in the vertical plane of the given diagram. Shape (x) was presented in an oblique or vertical orientation by a very small number of children, and in each case the child identified the shape as a solution.

III. The Object Reflections Problems

As an introduction to these problems children were asked to tip over a toy bear by releasing a steel ball from a shooter. During these initial exercises the shooter was aimed directly at the bear.

and each time the bear was tipped over it was moved to a different position on the board. In this way the children became acquainted with the two methods by which the shooter could be moved, namely, rotation about one of ten pivot holes in the board, and translation from one pivot hole to another. It was during these direct-aim experiences that children first exhibited particular aiming behaviors such as stooping down to sight along the shooter, or bending over and lining up the bear with the barrel of the shooter.

There were four reflection problems. In the first and second problems, children were asked to aim the shooter so that the ball would make one bounce off a wall before tipping over the bear. In the third and fourth problems, the shooter was to be aimed so that the ball made two bounces before tipping the bear.

Children in all age groups immediately became involved in the task, although the 3-year-olds appeared to be more intent on the game aspect than they were in following the directions of the interviewer. At least five attempts were given each child to try to tip over the bear in each problem.

Most children, including 7- and 8-year-olds, found it difficult to tip over the bear. Three year-olds generally aimed the shooter directly at the bear, even though wooden blocks were placed in between the shooter and the bear. When reminded by the interviewer that the ball had to bounce off the wall first these 3-year-olds aimed the shooter perpendicular to the wall, although the interviewer had touched that part of the wall which was midway between the shooter and the bear when emphasizing the path that the ball should take to

reach the bear. When this attempt was observed to fail to tip over the bear, these children resumed aiming the shooter in the direction of the bear, or moved the shooter to a different pivot hold in an attempt to get a better direct sighting on the bear. When the blocks interfered with their success the tendency among these children was to move the blocks or move around the board and push the ball at the bear with their hands.

Aiming behaviors which appeared during the introductory exercises reappeared during these problems, but were used consistently by only a few of these children. These consisted of bending over, stooping down or leaning back to sight along the shooter, while the others aimed the shooter from an erect standing position. Although all children followed the path of the ball once it was released, few appeared to use the proximity of this path to the bear as a guide to adjusting the aim of the shooter. Those who did and those who lined up the shooter with reference to some point on the rubber wall by bending down to look along the barrel had the greatest number of successes in tipping over the bear.

Although boys and girls aged 7 and 8 years showed similar aiming behaviors, the boys were more successful in tipping the bear. In general, those who took careful aim were more successful in tipping the bear than those who did not.

Moving the shooter from one hole to another was another strategy which children 5 to 8 years used to improve the direction of the path traced by the ball. However, only 7- and 8-year-olds used this with some success. A difficulty associated with this

strategy arose from the fact that when the pivot point was moved, information gained from previous aimings was no longer relevant, and aiming procedures started all over again.

Over one-third of the children aimed the ball at right angles to a wall at some stage of the problem. This included half the 5- and 6-year-olds. This procedure was identified as unproductive by the majority of children, and may have resulted from instructions such as "You have to hit this wall first before you tip the bear." Children's responses varied when asked where they expected the ball to go. A 3-year-old pointed directly at the bear, and a few children made sweeping arcs with their hands, moving from shooter to wall to bear. Some 7- and 8-year-olds, when asked the same question, used their fingers to trace on the board a straight line path from the shooter to the wall and then to the bear. However, it was not clear from their movements if they thought that the angles of incidence and reflection were meant to be equal. One 8-year-old did indicate this equality by using his hands to form these angles, with his fingertips touching at the anticipated point of impact of the ball and the wall.

Children 3 to 6 years of age did not respond consistently to the visual information provided by the path of the moving ball or to the cues and assistance given by the interviewer. As a result of this, one-third of the 3- to 6-year-olds did not proceed beyond the second one-bounce problem. The majority of 7- and 8-year-olds however, interpreted the feedback and, because of this, were able to make correct predictions on the direction in which the shooter had to be rotated to make the path of the ball move towards the bear.

Altogether one-half of the children aged 3 to 8 years were presented with all four problems.

Success in tipping over the bear was difficult to achieve, and only a small number of children aged 7 and 8 years were able to tip the bear two or three times. Approximately one-half of the children aged 3 to 8 years tipped over the bear once, and one-third, mainly 3- and 4-year-olds, did not tip the bear at all.

Those children who tipped the bear two or three times appeared to concentrate their attention on some point on the wall, and to pay particular attention to the path of the ball as it passed the bear. Furthermore, they took careful aim by bending over the shooter and sighting along the barrel.

The two-bounce problems were more difficult than the one-bounce problems. The attempts to solve the two-bounce problems were terminated after the first of them for approximately one-third of the children aged 4 to 8 years because they did not respond to cues and assistance provided by the interviewer. Of the children who completed all four problems, about one-half had less successful prediction records for the two-bounce problems than they had for the one-bounce problems.

IV. The Mirror Reflection Problems

The silhouettes of four animals, an elephant, a lion, a bear and a deer were drawn on a target screen and placed on a board with mirrored walls. It was possible to illuminate these animals individually by rotating a flashlight about a pivot point. Children in the age groups 3 to 8 years immediately responded to this material by

turning the spotlight from animal to animal as directed by the interviewer. The flashlight was pointed directly at the target animal, and children had no difficulty in choosing the correct rotation needed to move the light to each designated target.

The interviewer next turned the flashlight so that the spotlight was on the deer after one reflection off a mirror. Children were asked to turn the flashlight so that the spot moved from the deer to the elephant. Two-thirds of the 10 children in this study were able to move the flashlight without hesitation in the correct direction, and this action was reported as a correct prediction. The other third consisted of those 3-year-olds who did not appear to understand the task, and others who briefly turned the flashlight in the wrong direction and immediately reversed the movement to bring the spot to the correct position.

The spotlight was moved to the lion, after a single reflection off one mirror, and the light switched off. The next task was to turn the flashlight so that the spot would be on the bear when the light was switched on. The important thing in this case was the direction of rotation. Almost one-half of those who had predicted correctly with the light on were not able to move the flashlight in the correct direction with the light off or were not asked to do this task. A small number of 6-, 7- and 8-year-olds who had moved the spotlight in the wrong direction when it was switched on, moved the flashlight correctly for the second prediction without hesitation, while almost a third of the children, mainly 7- and 8-year-olds, made the correct move under both conditions.

The sequence of moves of the spotlight described above were repeated with the light reflected from two mirrors, and children were asked to make the same predictions. The first problem was abandoned for four 3-year-olds and one 4-year-old. Only a small number of children aged 3 to 6 years were able to make two correct rotations for this problem. More than one-half of those who made a prediction error when the light was switched on, including one 3-year-old, were able to move the flashlight in the correct direction when the light was switched off. However, two-thirds of those who made a correct first prediction were unable to make a correct prediction with the switch off, or were not asked to do so.

Whereas the one-reflection problem appeared more difficult for the 3- to 4-year-olds, the two-reflection problem proved difficult for all age groups. Every effort was made by the interviewer to help the children understand the problem. The path traced out by the light from its source to the mirrors and then to the target was identified by placing a hand in the beam of light and by having the children show where they thought the light beam was situated. Clearly, the younger children found it difficult to adjust to a situation where the flashlight was required to light up an object by an indirect method and the two-reflection problem was not understood by two-thirds of these children.

The visual behaviors in these problems were associated with observations of the movement of the spotlight. Children concentrated on the flashlight and the target screen. Those who were asked to find the place on the mirror where the light was reflected either placed

their hands in the path of the light beam or leapt over to find the reflection of the light source in the mirror. In most cases the interviewer had to help children locate the spotlight after the second prediction of each problem. This was necessary because children generally moved the flashlight too far, and when the light was switched on the spotlight was beyond the intended target.

Verbalizations

While the children set about the task of solving the four sets of problems, the majority of them talked freely to the interviewer or to themselves. These spontaneous verbalizations were classified into six categories according to the purpose of the children's talking. These were (a) questions directed at the interviewer, (b) monitoring of actions, (c) problem making or rule changing, (d) comments on the materials or the task, (e) expressions of interest or surprise, and (f) indications that the task was completed.

Approximately one-third of the children asked questions of the interviewer in the fold-out shapes, the projected shapes and the object reflection problems, and slightly less than this fraction in the final problem. Children asked questions to make sure they understood the problem and to determine which actions or moves were permissible. In the fold-out shapes problems approximately the same number of children in each age group asked questions. More 7- and 8-year-olds than any other age group asked questions in the object reflection problems, and these were seeking clarification of the rules. Although the proportions of children asking questions in the projected shapes and the mirror reflection problems were less than half those for the other two

problems, the majority of questions asked came from the older children. In the projected shapes problems the questions were related to how shadows were formed and how they disappeared while those in the mirror reflections were related to the movement of the flashlight.

Some children talked to themselves as they solved the problems. Some of this talk took the form of describing what they were doing or what they were about to do, and was classified as monitoring their actions. The number of children from all age groups who exhibited this behavior in the fold-out shapes problems and the object reflections problems was twice the number of those in the projected shapes and the mirror reflection problems. The distributions of frequencies for this category were similar to those for the first category. Thus the numbers were approximately evenly distributed over the age range for the fold-out shapes and the object reflections. However, the majority of monitoring comments in the projected shapes problems came from the 3- to 4-year-olds, and for the mirror reflections problems from the 3- and 4-year-olds.

Almost one-half the children aged 3 to 7 years wanted to change the rules in the object reflections problems. This took the form of trying to move the bear or move the blocks of wood, or push the ball instead of releasing it from the chamber. A small number of children wanted to change the rules in the fold-out shapes problems, most of whom were 3- and 4-year-olds. Rule changes took the form of telling the interviewer to take a turn at folding, or deciding to make a different kind of lam. No 4-year-olds suggested changing the problem or rules. In contrast with this behavior for these problems, no

child suggested a change of rules for the projected shapes or the mirror reflection problems.

Comments about the task ~~and~~ the materials were made by the majority of children in all age groups in the fold-out shapes problems and by one-half in all age groups for the object reflections and the projected shapes problems. Few of the younger children spoke at all in the mirror reflections problems. Comments made reference to the difficulty or ease of the task, the way in which the Velcro joined the pieces of Plexiglas or attached itself to the cover on the table, the difficulty of operating the projector, the apparent lack of a suitable wire model for projecting a straight line, the size of the target in the mirror reflection problem, and so on.

Children related some of the shapes made in the first problem to objects in their environment such as a house, a boat, a car, a pyramid, a kite, and the like. The dodecahedron, because of its unusual shape, caused some expressions of surprise when it was introduced. Slightly less than half the children in all age groups made these kinds of comments for the fold-out shapes, and about half this number in the object reflections problems. The number of such comments for the projected shapes and the mirror reflections problems was negligible.

Statements or expressions indicating that the task was complete were made by more children in all age groups for the fold-out shapes problems than for all the other problems. There are probably two reasons for this. The folding up of the cube appeared to give great satisfaction to all who completed each task. In the

projected shapes and the object and mirror reflections problems, the interviewer indicated that a solution had been reached and complimented those who successfully completed each task.

The fold-out shapes and the object reflections problems evoked considerably more verbalizations in all categories than the projected shapes and the mirror reflections problems. The former problems required a great deal of action and appeared as games to the majority of children. The other problems which involved the projection of a beam of light, and which used situations requiring concentration on a screen, elicited comparatively few verbalizations.

THE OBSERVED PROBLEM-SOLVING BEHAVIORS

The following behaviors in the four spatial problems investigated appear to be characteristic of children in the age range 3-8 years.

1. Children readily seek solutions to problems which are constructed in accordance with the criteria for 'good' problems (Nelson & Kirpatrick, 1974).

For example, the fold-out shapes which were presented to children were developed surfaces of the cube and the tetrahedron and three arrangements which would not fold. Children were asked to predict on the solvability of these shapes, a task which was similar to the polymino problems of Golomb (1965), although they differed in mode of presentation. When asked to fold these shapes, the children did so and a variety of solution levels was observed. In particular, children from 3 to 8 years of age were able to fold up these shapes.

and form cubes, tetrahedrons and dodecahedrons without any assistance from the interviewer. Furthermore, modifications were made which transformed these shapes into foldable forms.

The performance of the children in this study may be compared with the results described by Piaget and Inhelder (1967) for the development of the cube and the tetrahedron. Children up to 12 years were asked to draw their perception of the unfolded solids. Analysis revealed that the task was beyond the capability of children below 4 years (Stage I), while children 4-6 years (Stage II) tended to draw their developed surfaces identical with the intact solid. It was not until 7-9 years (Stage IIIA) that children showed a progressive understanding of the task depicting intermediate phases between the solid and its developed surface. By Stage IIIB for the cube and Stage IV for the tetrahedron (up to 12 years) children displayed a clear understanding of the shapes to be formed (Piaget & Inhelder, 1967, pp. 273-295). However, the development of the cube, for example, required not only the ability to draw but also the ability to visualize, through imagery, the succession of actions which would lead to the required shape.

That the task presented to the children in this study was the inverse of the Piagetian problem should not be overlooked. More important however, was the mode of presentation which circumvented children's drawing ability, and provided a more appropriate means of representation for children in the age range investigated.

In the projected shapes problems, children were required to choose the wire model they thought appropriate to project a given

shape, and then to form that shape. The selection for the first three shapes did not prove to be a difficult task. The curvilinear nature of the ellipse must have prompted the choice of the circle, while the rectangle and the triangle were equally well identified as the most appropriate models for producing the parallelogram and the triangle. Half the children were given assistance to rotate the circle in order to form the ellipse and the majority of 3- to 6-year-olds reproduced the rectangle as a representation of the parallelogram. The triangle was simply formed by holding the model in a vertical plane. A model suitable for forming a straight line was not at first recognised by the younger children, but after interviewer assistance with one of the models, those who were asked to try other models quickly produced a solution.

The remainder of the projected shapes problems were quite different from the Piagetian tasks. Children generally had no difficulty in identifying a correct solution when they formed one.

In their study of how children perceived the shadows cast by (i) a circular disc, (ii) a cardboard rectangle and (iii) a pencil, as these were moved about in space, the Genevans found that there were four distinct stages. Below 4 years (Stage I) children were unable to draw any semblance of a geometrical shape and lacked any understanding of pictorial perspective. From 4-7 years (Stage II) the distinction between different viewpoints was totally or partially absent. The object was represented as the subject saw it. Just as Stage II was marked with gradual changes, so Stage III (7-9 years) was characterised by a distinction between different points of view, followed by

improved quantification of the size of the representations of the shadows cast (Piaget & Inhelder, 1967, ch. 6).

In the two examples listed above the use of appropriate materials showed that children aged 3-8 years were able to perform transformations from two to three dimensions, to select appropriate models for forming geometric shapes, and to project these shapes.

2. When presented with a problem involving manipulation of materials, children want to make an immediate start on the solution. They resist any move which does not take them directly to a solution.

Although children were asked to predict if a shape would fold up into a box, their immediate reaction was to attempt to fold up the shape. Even after the question was repeated many aged 3-6 years did not express an opinion. In trying to predict if a shape will fold up into a box, a child has to form an anticipatory image of the results of a number of transformations. This, according to Piaget (1970), involves "operative aspects of thought (p. 14)," which only begin to function at the concrete operations level. It would appear then, that children less than 7-8 years, in general, have not developed cognitively enough to make reliable predictions about the foldability of the shape. This would help to explain the resistance shown by such a large proportion of 3- to 6-year-olds to predict for the shapes presented early in the sequence. Osgood (1964, p. 189) refers to research which indicates that subjects reflect in their expectancies about consecutive stimuli the sequential dependencies built into the series, although possibly unaware that any dependencies exist. This approach to cognition would explain the expectancy shown by children

in all age groups except 8 years that the first unfoldable shape would fold up, having experienced four consecutive cases where the shape did fold up.

In the object reflections problems children were primarily concerned with tipping the bear. The 'game' aspect of the problem maintained the interest of all children, although the younger ones changed the rules when they failed to achieve success. The role of the rebound was not understood by the 3-year-olds who continued to aim directly at the bear, even though obstacles were placed in the way. The failure to tip the bear by rebounding the ball off a wall led many children, including some of the older ones, to revert finally to aim directly at the bear. This reversion to a behavior which had previously resulted in success was also reported by Strutz (1966) who observed that in a choice situation, children 4-6 years tended to accommodate to that behavior which yielded the most frequent successful event.

The idea of illuminating an object by reflecting light off a mirror was beyond the experience of these children, and was not understood by most of the younger ones. These children wanted to aim the flashlight directly at the target, an experience they had practiced prior to the presentation of the problem and a behavior which was consistent with the normal use of a flashlight. Although the interviewer endeavoured to acquaint the children with the path of the light beam, the 3- to 6-year-olds did not adapt easily to the situations.

1. The level of solution to a problem is a function of perceptual exploration, motor activity, and interpretation of available feedback.

The reconstruction of the dodecahedron is one example of this behavior. It was quite clearly demonstrated that as the age level increased children became less dependent on the interviewer for cues and manual assistance. However there were exceptions, and a few younger children recognized specific figural characteristics of the shape at early stages of the solution. Those 3-year-olds for whom this and other fold-out problems were abandoned failed to exercise adequate exploration. Piaget and Inhelder (1967) described this lack of ability to decentrate as "a general deficiency in perceptual activity (p. 24)," which was partially overcome in some cases by the interviewer injecting one of the determinants of learning readiness, namely motivation (Gagné, 1970, p. 279).

Since such fundamental processes as perception, learning and motivation interact to produce predictive behavior, and up to 7 or 8 years of age images are fairly static, the performances of the children in this study were surprising. The number of 3-, 4- and 5-year-olds who predicted correctly for the first fold-up shapes problems may have done so, not on their perception of the layout but for some other reason. For example, they had already experienced the unfolding and refolding of the box. On the other hand, the 8-year-old who pointed to different squares and subvocalized as he pointed with his finger before making a prediction, was engaged in anticipatory representation, a stage beyond the reproductory representation of the preoperational

level.

In the projected shapes problems, children 5-6 years of age were more active than the 3- and 4-year-olds in exploring the possible shapes produced with the models, and yet lacked the motor skills necessary to construct shapes which required the model to be held obliquely. The 7- and 8-year-olds succeeded in their endeavours, for their capacity to decentrate and their motor skills had both developed sufficiently. Zaporozhets (1970) stated it this way:

The increasing effectiveness of solving various sensory problems depends upon the development of children's perceptual activity, that is, upon the degree to which they acquire more perfect means of acquainting themselves with the objects they perceive (p. 647).

Although all children followed the trajectory of the ball in the object reflections problems, the younger children generally concentrated their attention on the shooter before releasing the spring loaded plunger. The visual activity of those 7- and 8-year-olds who tipped the bear more than once included surveys of the complete path from the shooter to the bear, with alternate eye movements between the shooter and some point on the rebounding wall. This perceptual activity and the ability to identify significant stimuli is consistent with findings reported by Wilton and Boersma (1972), that normal children who successfully transformed stimuli were much more active in visually exploring the display area than those who did not.

Piaget's theory of cognitive development and, in particular, his studies of the child's conception of space are relevant to this study. The child's cognitive processes are seen by Piaget to develop through three periods, namely (i) sensori-motor (0-2 years), (ii) concrete operations (2-12 years), and (iii) formal operations

(12 years-adult). The concrete operations period was subdivided into three stages. I Preconceptual (2-4 years), II Intuitive (4-7 years), and III Concrete operations (7-11 years), with Stages I and II being described as preoperational. According to Piaget the behavior of children in Stage I is characterized by a lack of adequate exploration, and Hunt (1961) noted that a child in this stage was highly dependent upon perceptual mechanisms for his information about a particular object. Thus a child in this stage is influenced by the immediate attributes of an object on which he is centered. The capabilities of children in the other stages have been described by Berlyne (1957) in the following way:

Children at the intuitive-thought stage vary conditions haphazardly, and observe what happens in particular cases without deriving any general principles. At the concrete-operations stage one factor at a time is varied, and its effects are duly noted. Not before the formal-operations stage does the child plan truly scientific investigations varying the factors in all possible combinations and in systematic order (p. 319).

A distinction is also drawn by Piaget and Inhelder (1967) between perceptual space and representational space.

Perception is the knowledge of objects resulting from a direct contact with them. As against this, representation or imagination involves the evocation of objects in their absence, or, when it runs parallel to perception, in their presence (p. 17)..

Both visual perception and haptic perception help to provide information about perceptual space since visual exploration and the actions of tactile exploration can evoke a mental image, and thus contribute to both perception and representation.

Studies by Lovell (1959), Page (1959), Dodwell (1963), and Laurendeau and Pinard (1970) have replicated Piaget's investigations of the child's conception of space, and generally speaking their

findings vary little from those of Piaget. Katy (1970) and Martin (1973) have suggested however, that Piaget's interpretation of topological concepts is not always mathematical, and dispute his assertion that topological concepts develop prior to Euclidean concepts.

The concept of topological equivalence was found by Bass (1970) to develop about the age of 8 years, but is preceded by notions of enclosure and order which develop earlier. In studying the effects of transformational geometry on the spatial abilities of children in second and third grade, Williford (1972) found that:

The experimental subjects did learn to execute manual procedures to produce transformation images, but they did not learn to mentally perform transformations from one state to another. In terms of Piaget's theory, the subjects did not exhibit operations on imagery. Instead they were able to fashion reproductive images based upon the perception of the original figures and upon manipulative techniques, rather than produce anticipatory images resulting from operative thought (p. 269).

4. The use of appropriate physical materials enable children in all age groups to solve problems when the materials are used in a manner consistent with the requirements of the problem.

Considering only those cases where the cube was formed without assistance from the investigator, children in all age groups were successful, not only in folding up the shape, but also in making the transformations needed to change the unfoldable shapes into foldable forms. The proportion of 3-, 4- and 5-year-olds who were in this category was higher than the Piagetian findings would lead us to expect. The effects of the nature of the materials should not be overlooked. The squares could be rotated about an edge with ease, firm joins could be effected, and action with real objects was

involved.

That the older children employed simpler folding sequences than the majority of the younger ones was possibly due to a maturational factor, but this was consonant with the statement by Bruner (1970):

There is a structure in action and a structure in knowing. Action must be affected by the nature of the perceptual organization, and, in turn, that perception must be programmed by the requirements of action (p. 81).

Bruner (1964) suggested three different systems of representation for information acquisition, namely the enactive or representation through action, the ikonic or representation through imagery, and the symbolic, or representation through symbols. The hexonino problems would be classified as requiring enactive representations, while the construction of the tetrahedron would involve partly enactive and partly ikonic representation, since a wire model was available as an illustration of the structure. The construction of the dodecahedron without the presence of a model would involve firstly enactive, and then later on ikonic representation, enactive since the process involved the physical manipulation of materials, and ikonic, because the construction evoked images, both complete and incomplete, of the original dodecahedron.

Furth and Wachs (1974) referred to three body and sense thinking processes which can be applied to a manipulative or graphic task. These processes are described as (1) movement thinking, (2) hand thinking, and (3) visual thinking. Through these senses a child is able to draw an object, construct a design and successfully match similar figures.

Information received through the senses from the environment must be processed, decoded, encoded and integrated with body knowledge if it is to be meaningful to the individual (p. 179).

The spatial problems of this study provided ample opportunity for these forms of thinking. In those cases where the information was not meaningful, either some information was not being processed effectively, or the child did not fully comprehend the problem. Whereas children aged 3-7 years employed unstructured attempts to verify that the fifth fold-out shape would not fold up, their efforts to verify the same result for the sixth shape were more structured and executed with confidence. Furthermore, when they modified these shapes into foldable forms, these children transformed them to one of the known foldable shapes.

In the mirror reflection problems there was evidence that some learning was taking place, particularly in the two reflection problems, when children who had made an incorrect rotation of the flashlight when it was switched on, were then able to make a correct rotation of the flashlight when it was switched off. This problem differed from the object reflections task in that there was little opportunity for children to learn from their experiences. In the object reflections problem, children had 5 or more efforts to achieve their goal and as a result, there was more visual feedback available to them. The mirror reflections problem gave the child one chance to respond and this was either correct or incorrect. There was also less opportunity for interviewer feedback in the mirror reflections problem.

For some children, aiming the shooter at the wall and aiming the flashlight at the mirror interfered with their problem solving. They wanted to aim directly at the object.

As children gain experience their problem-solving procedures become more systematic.

For example, in the projected shapes problems over half the children were given assistance to form the ellipse. The majority of whom were 3-4 years. This same age group formed a rectangular shape for the parallelogram, and made no attempt to explore other possible ways of holding the model. The 5- to 6-year-olds maneuvered their selected models to produce the straight line with minimal or no assistance from the interviewer, in contrast with the younger children.

The remainder of the projected shapes problems were quite different from the Piagetian tasks. The level of solution of them was, in the main, age dependent, with the 7- and 8-year-olds showing ability to form the required shape with verbal cues or no assistance at all. Of these six shapes to be formed, three had square boundaries, and therefore the most difficult for the younger children to produce. These children had difficulty in selecting an appropriate wire model in the first place, and, when given the correct model, made haphazard explorations, and generally resisted interviewer assistance. These problems proved to be too difficult for the 3-year-olds.

Two of the shapes with square boundaries were formed by holding the wire in an oblique line, a process which the older children were able to perform more easily than the younger ones. Most children concentrated on the screen. However the younger children found it difficult to adjust the orientation of the wire model without glancing at it, whereas the older children could. From this point of view, it

would have been an improvement to have the screen close to the child.

When children raised the extremities of the hemispheres and the tetrahedron to the vertical position, the perceptual feedback was minimal and misleading. This behavior was also noted by Piaget and Inhelder (1957, p. 60) with reference to the development of perceptual or sensorimotor activity. In the case of the tetrahedron and the dodecahedron, raising triangles or pentagons to an upright position did not establish a correct relationship, and this 'noise' interfered with the child's recognition of any visual information which could have evoked an image of the required shape.

4. Children display a variety of verbalization behaviors as they solve problems.

Spontaneous verbalizations were evoked by all four problems. However the proportion of children in each age group that verbalized in the fold-out shapes and in the object reflections problems considerably exceeded that for each of the projected shapes and mirror reflections problems. In the first pair of problems children were able to exercise greater control over their actions than they had in the second pair.

Other factors which may have contributed to this difference in verbal behaviors were:

- a greater perceptual concentration required to observe (i) changes in the shadows formed and (ii) the path of the light beam,
- the amount of detailed instruction or cuing given by the interviewer in the second pair of problems reduced the

frequency of questions and reactions to the problem situations, and

— the tasks and materials did not foster verbalization.

Of particular note was the fact that 7- and 8-year-olds made the least number of rule changes. These children were at the beginning of the concrete operations stage and were prepared to accept the problems as presented. Furthermore, no rule changes were expressed verbally by children of any age group for the projected shapes and the mirror reflections problems. Conjectures have been advanced above which would possibly account for this fact. The lack of indications that the mirror reflections task was complete was partly due to the fact that the interviewer commented on the success or failure, or that the subject was more interested in locating the position of the spotlight.

The categories used to classify the children's verbalizations were consistent with models or functions of children's language reported by Halliday (1970) and Tough (1971). These children were using (i) the interpretative function when they sought information or made comments on the task or the materials, (ii) the self-maintaining or regulatory function when they changed a rule or indicated that the task had been completed, (iii) the directive function when they monitored their actions, and (iv) the projective function when they made a prediction or expressed interest or surprise.

The spontaneous verbalizations which have been examined have been of a purposive or functional nature, and have been described by

Piaget (1955) as egocentric speech which atrophied with age. Vygotsky (1962) observed that there was an increase in the speech-for-self of a child in a problem-solving situation which he interpreted as the child's means of directing and planning his behavior. Klein (1964) studied the speech-for-self of young children in problem-solving situations who were isolated from any other person. He found that the proportion of task oriented self speech increased with age, and that children who exhibited speech-for-self did not perform any better in problem-solving situations than children who did not.

In this study it was found that children verbalized spontaneously in problem-solving situations as well as responding to questions and statements made by the interviewer. These verbalizations varied according to the nature of the materials used, and that within each age group there was a variety of the number of verbalization categories used.

7. Children align edges of components in an assembly and adopt specific solving behaviors without any prompting.

The attention shown by all but one child to the alignment of edges when joining squares, triangles and pentagons without prompting by the interviewer indicated an awareness of one-to-one correspondence, and the way in which objects fit together. The matching of various edges was referred to by the interviewer, and children maintained a classificatory behavior through the ten fold-up shape problems. In the case of the cube, once two edges were correctly matched, that the remaining edges would join with adjacent edges was assumed. However, the general appearance of the imbeddedness and the fact that the

joining of a pentagon to a partial assembly required the classification of at least four separate Velcro edges would account for the fact that the majority of children were given assistance by the interviewer to reassemble the shape, and that the amount of assistance given decreased with increase in age level.

In the object reflections problems many children from 3-8 years employed 'line-of-sight' methods to aim the shooter at the bear. Some maintained the use of this aiming behavior when the problems required the ball to rebound off the walls by aiming the shooter at some point on the wall. Piaget and Inhelder (1967) have observed that the arrangement of a set of objects in a straight line is achieved by using a 'line-of-sight' or by aiming occurs in children about 7 years of age (Stage III). They related this to the development of a child's ability to discriminate between and then coordinate several points of view.

The observation of this aiming behavior at ages considerably less than those reported in the Geneva study may well be attributed to the nature of the materials used. The situations used in the Geneva study required children to form a straight line of posts (toothpicks) between two points on a plane, with rectilinear or circular diagrams as distractors (Piaget & Inhelder, 1967, p. 157). Laurendeau and Pizard (1970) in a thorough study of the child's concept of the projective straight line found that approximately one-half of the 8-year-olds were unable to construct straight lines oblique to perceptual distractors twice in two trials. Thus a distinction has been established between perceptual and representational space in

children. In the present study the problem resembled a game situation which employed aiming behaviors, a situation to which children related and responded.

When asked to produce a straight line in the projected shapes problems children looked for a model in the form of a straight line. Although prompted to use one of the three models available, none of the 3- to 5-year-olds were able to project the straight line without assistance. The orientation of the shadows did not appear to be an important criterion to some who formed the required shape, an observation which was also noted by Piaget and Inhelder (1971, p. 121). Children 3 to 8 in this study identified a shape as correct whether it was oriented horizontally, vertically or obliquely if it had the necessary structure, even though the stimulus was always oriented horizontally. One 7-year-old indicated that his diagonal in one problem was sloping in a direction opposite to that required, and proceeded to transform his shadow to the correct orientation. Others who had formed their shapes with vertical or oblique orientations transformed their shadow to the horizontal form when asked to do so by the interviewer.

Piaget and Inhelder (1971) noted children's lack of concern for orientation, attributing it to "the automatic perceptual corrections involved in the constancy of forms and the perceptual recognition of forms in various positions (p. 123)." Studies by Ghent (1961), Mohlwill and Wiener (1964) have shown that children as young as 4-5 years of age have little difficulty on the average in discriminating stimuli on the basis of their spatial orientation, provided the task

requires a response to this cue. However, very young children (3 years) failed to respond to the orientation of stimuli—that is, they may have responded to specific salient cues in objects which would allow them to recognize those objects in any orientation.

8. Children show varying degrees of understanding of the paths of incidence and reflection in object and mirror reflections.

Recognition that the trajectory of the ball in the object reflections problems consisted of rectilinear segments was shown by those 7- and 8-year-olds who were asked to show where the ball would travel. A similar result was given in the case of the mirror reflections problem. However younger children, when asked to show where the ball would travel described an arc which went from the shooter to the bear.

A similar result was observed by Piaget and Inhelder (1958), who studied the child's concept of the equality of the angles of incidence and reflection through the use of apparatus in the form of a billiard game (pp. 3-19). Balls were rebounded from a wall and children were asked to aim for a target which was moved from one target to another. Subjects were asked to report on their observations, since the Genevans were studying the development of propositional logic in children. They found that up to 6-7 years (Stage I) children were primarily concerned with practical success or failure. A distinction was made between simple goal-directed behavior and a child's actions which accompanied "an awareness of the techniques and combinations of his own behavior (p. 6)." It was this latter behavior which was termed concrete operations. Evidence of this was

observed in 7- to 10-year-olds (Stages IIA and IIB) with a developing awareness of the rectilinear nature of the path of the ball. However, discovery of the equality of the angles of incidence and reflection occurred only at Stage IIIA (11-14 years) and was formulated at Stage IIIB (14-15 years).

Children in this study were not questioned to determine their understanding of the relationship between the angles of incidence and reflection. Only in a few cases could one infer that 7- and 8-year-olds intuitively thought that this relationship existed.

9. Within each age group there is a wide range of behaviors exhibited.

For example, in the fold-out shapes problems, the solutions of the 3- to 5-year-olds ranged over all the solution categories. In particular, children in this age group assembled the tetrahedron without assistance and the dodecahedron with minimal or no assistance. Folding procedures varied considerably but nevertheless the tasks were successfully completed. Solution categories for the 6- to 8-year-olds in this last fold-out shape problem were as diverse as those of the younger children.

Although the solutions to the projected shapes problems differentiated between the younger and older children, there were instances in several of these problems where exceptions occurred. For example, those who produced the last projected shape without assistance were evenly distributed over the age range 4-8 years.

The variety of aiming procedures in the object reflection problems of the 3- to 6-year-olds was almost equal to that of the 7- and 8-year-olds, but there were fewer children in the younger group

who used them. In the second part of the mirror reflections problem the performances of the 4- and 5-year-olds were not inferior to those of the 6- to 8-year-olds, although the problem was abandoned for all but one of the 3-year-olds.

Thus, given the appropriate problem-solving situations, children will attempt to solve these problems and will display a range of problem-solving behaviors.

THE CRITERIA FOR GOOD PROBLEMS

The twelve problems of the cross-sectional project were devised to conform with a set of criteria for the construction of 'good' problems listed by Nelson and Kirkpatrick (1975, pp. 71-72). The results obtained from the study of the four spatial relations tasks indicate that when problems are constructed according to these criteria, that children will react favourably to them, and will display a variety of problem-solving behaviors.

The mathematical significance of the problems has already been established. However, the reality of the situation or the use of real objects can sometimes produce unexpected reactions. For example the youngest children were unable to use the flashlight in the manner prescribed by the mirror reflections problems because, in general usage, a flashlight is pointed directly at the object to be illuminated.

A factor which played a major part in the success experienced by the subjects in this investigation was the visual feedback which was an integral part of the materials used in these spatial problems.

Thus, in the fold-out shapes, when two or three adjacent pieces had been fitted together, characteristic features of the completed solid became visible, and in most cases this assisted children to proceed with the assembly. With respect to learning theory, Hilgard and Bower (1974) note that "cognitive feedback confirms current knowledge and corrects faulty learning (p. 616)." This equally applies to these problem-solving situations. The result of a move can be assessed and the strategy maintained or modified as a result of this feedback. Different levels of solution can result from the various ways the visual or verbal feedback is interpreted. Lack of sufficient exploration can also limit the visual clues available to the problem solver.

The limitations listed above in no way detract from the usefulness of the criteria as a guideline for constructing problems appropriate for solution by young children. Rather they contribute to the variety of behaviors displayed and the levels of solutions appropriate to different age groups.

IMPLICATIONS FOR FURTHER RESEARCH

This study has examined behaviors of children aged 3-8 years while solving spatial problems. Each of the results found needs to be checked with further research. These problems constitute a fraction of the cross-sectional aspect of the Nelson and Swada (1974) project. Before any recommendations for further study can be made, these results should be integrated and compared with the findings of the other eight problems of this project.

One of the concerns prior to the commencement of the project

was that children would not react to the problem situations or display problem-solving behaviors. This concern was unfounded because children did respond, and generally approached the tasks given them with interest. As a result of this, protocols which had been left flexible in the cross-sectional study, were modified for the longitudinal study.

The distinct advantages which accrue from the use of the videotape recording of data have been referred to by Nelson and Saeeda (1975), namely, (i) permanency of the record, (ii) completeness of the record and (iii) reliability of the interpretation. A further advantage is derived from the check on protocols used. However, the disadvantages should not be overlooked. Because the recording captures all behaviors the investigator has the task of sorting the relevant data from the irrelevant. The transcription from tape to paper is a lengthy process. This could possibly be alleviated by having the tapes modified so that behaviors of children solving the same problem were all recorded on the same tape.

The order of presentation of the tasks in each of the problems was fixed. It was therefore not possible to determine the extent to which children's solutions for the first tasks influenced their behavior in subsequent problems. Further research needs to be conducted in which the order of presentation of problems is systematically varied. This would provide information on the extent to which learning is taking place and contributing to success in later problems.

CONCLUDING REMARKS

Each of the four spatial relations problems produced a variety of problem-solving behaviors from those children aged 3-8 years who participated in the project. These problems were designed to satisfy a set of criteria for good problems. The materials constructed for these problems proved attractive to the majority of the children, and provided multiple embodiments of the mathematical principles selected as stimuli to generate problem-solving behaviors at various levels.

Protocols for these problems proved to be unnecessarily flexible for the problems and the problem-solving situations generally proved to be self motivating. A characteristic of these problems and the method used for recording the data are reflected in this statement:

Mathematical thinking will need the sort of investigation which catches the constructive process while it is still going on (Dienes, 1960, p. 41).

The results of the full cross-sectional and longitudinal studies of which these problems constitute a part will need to be known before the full implications for the practising teacher will become apparent. The present study however, provides some evidence that simple geometrical transformations can be introduced to children at an early age in a manner which, with further refinements, could lead to an intuitive informal understanding of spatial relationships.

BIBLIOGRAPHY

BIBLIOGRAPHY

- Alvy, M. The early childhood educator at work. New York: McGraw-Hill, 1975.
- Bass, M. G. The topological understanding of children in kindergarten, first, and second grades. Unpublished doctoral dissertation. Columbia University, 1970.
- Berlyne, D. E. Recent developments in Piaget's work, 1957. In E. J. C. Harper et al (Eds.). The cognitive processes: Readings. Englewood Cliffs, N.J.: Prentice-Hall, 1964.
- Bott, M. M. Method in social studies in young children. Toronto: University of Toronto Press, 1967.
- Bruner, J. S. On knowing: Essays for the left hand. Cambridge, Mass.: Harvard University Press, 1964.
- Bruner, J. S. Some theorems of instruction illustrated with reference to mathematics. In Theories of learning and instruction. The sixty-third Yearbook of the National Society for the Study of Education. Chicago: University of Chicago Press, 1964.
- Bruner, J. S. Toward a theory of instruction. Cambridge, Mass.: Harvard University Press, 1966.
- Bruner, J. S. Constructive cognition. Contemporary Psychology, 1970, 15, 61-63.
- Chou, S., & Simro, P. Early childhood information unit. New York: Educational Products Information Exchange, 1973.
- Cohen, L. S., & Johnson, D. C. Some thoughts about problem solving. The Arithmetic Teacher, 1967, 14, 261-267.
- Coxeter, H. S. H. Regular polyhedra (2nd ed.). New York: Macmillan, 1963.
- Dewey, J. How we think. Boston: Heath, 1933.
- Glenn, E. P. Mathematics in the primary school. New York: St. Martin's Press, 1968.
- Glenn, E. P. Approach to primary mathematics. London: Hutchinson, 1967.
- Glenn, E. P. Building of mathematics (4th ed.). London: Hutchinson, 1971.

- Dodson, J. W. Characteristics of successful insightful problem solvers. National Longitudinal Study of Mathematical Abilities Report No. 11. School Mathematics Study Group, Stanford University, 1972.
- Dodwell, P. C. Children's understanding of spatial concepts. Canadian Journal of Psychology, 1963, 17, 141-161.
- Dodwell, P. C. Children's perception and their understanding of geometrical ideas. In M. F. Rosskopf, L. P. Steffe & S. Tebeck (Eds.), Piagetian cognitive-development research and mathematical education. Boston, Va.: National Council of Teachers of Mathematics, 1971.
- Dunker, K. On problem solving (1945). In P. C. Mason & P. M. Johnson-Laird (Eds.), Thinking and reasoning. Harmondsworth, Middlesex: Penguin, 1968.
- Engelman, S., & Carnine, D. Teacher's guide: DISTAR arithmetic, I & II. Chicago: Science Research Associates, 1970.
- Esty, E. T. An investigation of children's concepts of certain aspects of topology. Unpublished doctoral dissertation, Harvard University, 1970.
- Furth, H. G., & Wachs, H. Thinking goes to school: Piaget's theory in practice. New York: Oxford University Press, 1974.
- Gagné, R. M. Human problem solving: Internal and external events. In B. Kleinmuntz (Ed.), Problem solving: Research method and theory. New York: John Wiley, 1966.
- Gagné, R. M. The conditions of learning (2nd ed.). New York: Holt, Rinehart and Winston, 1970.
- Gagné, R. M., & Smith, E. C. A study of the effects of verbalization on problem solving. Journal of Experimental Psychology, 1932, 1, 19-27.
- Ghent, L. Effect of orientation of geometric forms by retarded children. Child Development, 1964, 35, 1127-1136.
- Golomb, S. W. Polyominoes. New York: Charles Scribner, 1965.
- Halliday, M. A. K. Explorations in the functions of language. London: Edward Arnold, 1973.
- Henderson, K. B., & Pingry, R. E. Problem-solving in mathematics. In The learning of mathematics: Its theory and practice. Twenty-first Yearbook of the National Council of Teachers of Mathematics. Washington, D.C.: National Council of Teachers of Mathematics, 1953.

- Milgard, E. R., & Bower, G. M. Theories of learning (4th ed.). Englewood Cliffs, N.J.: Prentice-Hall, 1975.
- Munt, J. M. Intelligence and experience. New York: Ronald Press, 1961.
- Inhelder, B., & Piaget, J. The growth of logical thinking from childhood to adolescence. New York: Basic Books, 1958.
- Junge, C. W. et al. Mathematics for young children. A paper presented at a National Leadership Conference on Mathematics for Early Childhood. Washington, D.C.: National Council of Teachers of Mathematics and Association for Childhood Education International, 1975.
- Kami, C. Evaluation of learning in preschool education: Socio-emotional, perceptual-motor, cognitive development. In B. S. Bloom, J. T. Hastings & G. F. Madaus (Eds.), Handbook on formative and summative evaluation of student learning. New York: McGraw Hill, 1971.
- Kerlinger, F. N. Foundations of behavioral research (2nd ed.). New York: Holt, Rinehart and Winston, 1973.
- Kilpatrick, J. Problem solving in mathematics. Review of Educational Research, 1969, 39, 523-534.
- Klein, W. L. An investigation of the spontaneous speech of children during problem-solving. Unpublished doctoral dissertation, University of Rochester, 1964.
- Kleinsmuntz, B. (Ed.). Problem solving: Research, method, and theory. New York: Wiley, 1966.
- Laurendeau, M., & Pinard, A. The development of the concept of space in the child. New York: International Universities Press, 1970.
- Little, J. J. Nonverbal problem-solving behaviors of boys in grades one, two and three. Unpublished master's thesis, University of Alberta, 1974.
- Longhurst, R. S. Geometrical and physical optics. London: Longmans, 1967.
- Lovell, K. A follow-up study of some aspects of the work of Piaget and Inhelder on the child's conception of space. British Journal of Educational Psychology, 1959, 29, 104-117.
- Martin, J. L. An analysis of Piaget's topological tasks from a mathematical point of view. Paper presented at the 1973 Annual Meeting of the National Council of Teachers of Mathematics.

Mathematics in Primary Schools. Curriculum Bulletin No. 1. London: Her Majesty's Stationary Office, 1969.

McNeil, J. D., & Popham, W. J. The assessment of teacher competence. In R. M. W. Travers (Ed.), Second handbook of research on teaching. Chicago: Rand McNally, 1973.

Nelson, L. D. Problem solving in early childhood. Paper presented at the meeting of the International Commission for Mathematics Instruction and the Japan Society for Mathematical Education, Tokyo, November, 1974.

Nelson, L. D. Problem solving in early childhood mathematics. A paper presented at a National Leadership Conference on Mathematics for Early Childhood, Washington, D.C., National Council of Teachers of Mathematics and Association for Childhood Education International, 1975.

Nelson, L. D., & Kirkpatrick, J. Problem solving. In Mathematics learning in early childhood. Thirty-seventh Yearbook of the National Council of Teachers of Mathematics. Washington, D.C.: National Council of Teachers of Mathematics, 1975.

Nelson, L. D., & Liedtke, W. Mathematical experiences in early childhood. Toronto: Encyclopaedia Britannica Publications, 1972.

Nelson, L. D., & Liedtke, W. Mathematical experiences: Primary division. Toronto: Encyclopaedia Britannica Publications, 1974.

Nelson, L. D., & Smuda, D. Nature and development of problem solving behavior in early childhood. Canada Council Project. Progress Report. Research Grant 73-0000. Edmonton: University of Alberta, 1974.

Nelson, L. D., & Smuda, D. Studying problem solving behavior in young children—Some methodological considerations. Journal of Educational Research, 1975, 21, 20-22.

Novell, A., & Simon, H. A. Human problem-solving. Englewood Cliffs, N.J.: Prentice-Hall, 1972.

Oberste, A. E., & Hibelick, W. E. Directions of curricular change. In Mathematics learning in early childhood. Thirty-seventh Yearbook of the National Council of Teachers of Mathematics. Washington, D.C.: National Council of Teachers of Mathematics, 1975.

Ogden, C. F. A behavioristic analysis of perception and language as cognitive phenomena. In R. J. C. Harper et al (Eds.), The sensitive organism: Studies. Englewood Cliffs, N.J.: Prentice-Hall, 1966.

Pago, E. J. Depth perception. Educational Review, 1969, 11, 115-124.

Piaget, J. Genetic epistemology. Translated by E. Boshworth. New York: Columbia University Press, 1970.

Piaget, J. Science of education and the psychology of the child. New York: Orion Press, 1970.

Piaget, J., & Inhelder, B. The child's conception of space. Translated by F. G. Langham & J. L. Kanner. New York: W. W. Norton, 1957.

Piaget, J., & Inhelder, B. Number in the child. London: Routledge & Kegan Paul, 1971.

Polya, G. How to solve it. Princeton: Princeton University Press, 1945.

Richard, C. A. Problem solving: Some suggestions from research. The Arithmetic Teacher, 1969, 16, 24-28.

Rothenberg, M. P., et al. (Eds.). Education cognitive development research and mathematical education. Boston, Va.: National Council of Teachers of Mathematics, 1971.

Schwartz, C. W., Hartman, H., & Arnold, W. Teaching the child mathematician. Lincoln, Ill.: Boyden Press, 1973.

Steinberg, L. L. Erica Eusebia: Her life and work. New York: Harper & Row, 1963.

Stewart, D. H. Mathematics across the curricula. Chicago: Langhott, 1970.

Thompson, L. L. A comprehensive bibliography of books on creativity and problem-solving. Journal of Creative Behavior, 1971, 1, 100-107.

Wallas, G. W. Principles of psychology of ideas and the creative mind. Journal of Creative Behavior, 1971, 1, 108-117.

Wallas, G. W. Principles of psychology of ideas and the creative mind. Journal of Creative Behavior, 1971, 1, 118-127.

Wallas, G. W. Principles of psychology of ideas and the creative mind. Journal of Creative Behavior, 1971, 1, 128-137.

Wallas, G. W. Principles of psychology of ideas and the creative mind. Journal of Creative Behavior, 1971, 1, 138-147.

Wallas, G. W. Principles of psychology of ideas and the creative mind. Journal of Creative Behavior, 1971, 1, 148-157.

Wallas, G. W. Principles of psychology of ideas and the creative mind. Journal of Creative Behavior, 1971, 1, 158-167.

- Vygotsky, L. S. Thought and language. Cambridge, Mass.: The M.I.T. Press, 1962.
- Weber, E. The kindergarten: Its encounter with educational thought in America. New York: Teachers' College Press, 1969.
- Williford, H. J. A study of transformational geometry instruction in the primary grades. Journal for Research in Mathematics Education, 1972, 3, 260-271.
- Wilton, K. M., & Boersma, P. J. Eye movements, surprise reactions and cognitive development. Rotterdam: Rotterdam University Press, 1974.
- Wirsup, I. On breakthroughs in the psychology of learning and teaching geometry. Paper presented at the National Leadership Conference on Mathematics for Early Childhood, Washington, D.C., January, 1975.
- Mohiwill, J. P., & Wiener, M. Discrimination of form orientation in young children. Child Development, 1964, 35, 1113-1125.
- Zaporozhets, A. V. The development of perception in the preschool child. In Five Monographs of the Society for Research in Child Development, Cognitive development in children. Chicago: University of Chicago Press, 1970.

APPENDICES

APPENDIX A

PROTOCOLS

1. **Fold-out Shapes**
2. **Projected Shapes**
3. **Object Reflection**
4. **Mirror Reflection**

FOLD-OUT SHAPES

The cube is placed on a low table in front of the child. He is encouraged to handle the cube and is asked to give it a name. He is then instructed to unfold the cube so that all the squares will lie flat on the table. If the child separates each square from the others, the squares are joined together into an arrangement which can easily be folded again to make a box. If the child simply unfolds the box, the configuration is not altered in any way. In either case, the child is asked to fold up the cube again. If he has difficulty fitting the squares together, he is shown how the 'rough' side will cling to the 'smooth' side.

The child is then told that the squares will be laid out in different ways and he will be asked to make a box from a particular layout of the squares. The box is unfolded and the squares are laid out in the following arrangements:

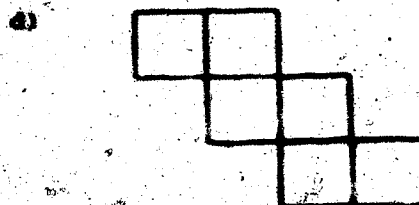
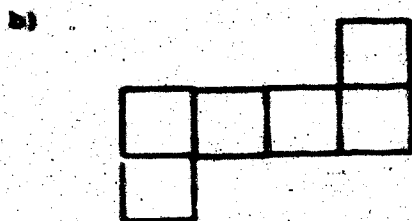
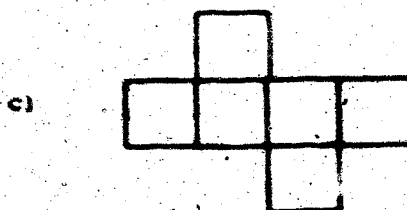
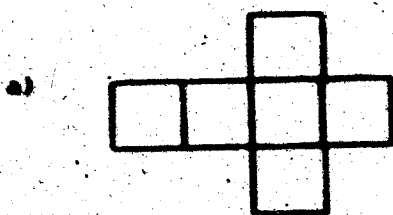

The child is encouraged to guess whether or not he will be able to make a box from a particular arrangement before he actually folds up

the squares. When he has completed these activities, the child is then presented with the following arrangements and asked to guess if he can make boxes by just folding:

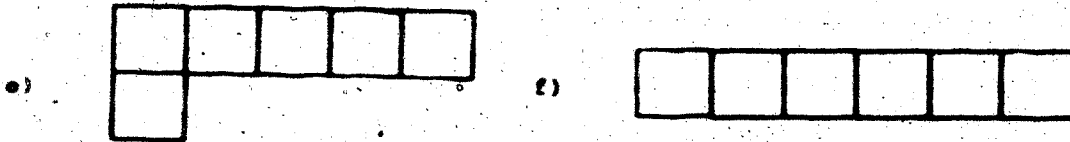

In any case he is asked to verify his choice. The squares are laid out as in e) and f) above and the child is asked how he would re-arrange the squares so that he can make a box with them. The child is given no assistance with this operation. When he has completed the task, the cube is removed from the table.

Four separate triangles of a tetrahedron are placed in front of the child. He is asked if he can attach the pieces together in such a way that he will be able to fold them into a box (tetrahedron). If the child fails to make the figure he is given assistance.

The triangles are then laid out in the following ways and the child is asked if he can make boxes from them.

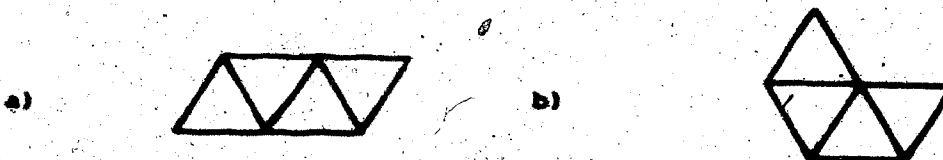

Again, he is asked 'Can you make a box from this arrangement?' before he actually folds the pieces. No assistance is given to the child. When he has completed this task, the tetrahedron is removed.

The dodecahedron is placed before the child. He is encouraged to handle the figure, to name it and then to dismantle it. When he has folded out all the sides of the dodecahedron, he is asked to

reassemble the figure. No assistance, other than holding pieces in place, is given to the child.

PROJECTED SHAPES

A high intensity lamp is placed on a low table so that the light shines directly on a screen, set in front of the table. The child stands beside the screen or sits on the table beside the lamp.

The child is shown how he can throw shadows against the screen with his hands. He is then given one of the shapes and is asked to see what kinds of shadows he can make with it. He is encouraged to understand that as he moves the apparatus, the shadow will change shape. A diagram of a certain shape is presented to him on a white card and he is asked if he can create a shadow identical to the diagram with the apparatus he has been given.

The following shapes (column 1) are used in this activity; and the child is required to produce the figures in column 2.

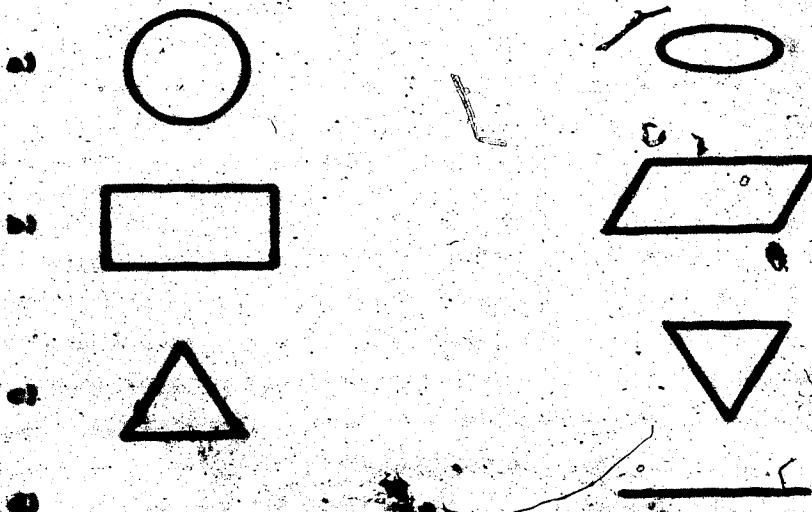

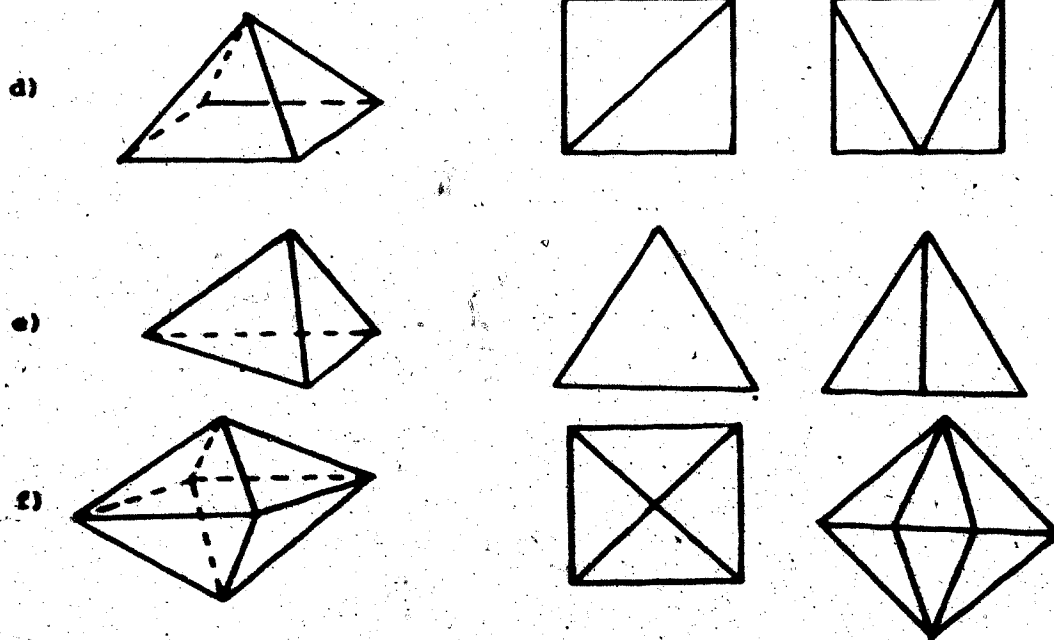

Shapes a), b) and c) are introduced together. The child is asked to make shadows of the figures shown above (column 2). He is then asked which shape(s) he would use to create a shadow of a straight line. He is encouraged to demonstrate how this shadow can be made. Figures d), e) and f) are presented together and the child is asked which shape he would use to produce the shadow designs shown in column 1.

OBJECT REFLECTION

The apparatus is placed on a low table so that the child can stand over it. The shooter is fixed in one of the holes drilled to accommodate it. The plastic bear is placed at some distance from the shooter and the child is shown how to operate and aim the shooter to knock down the bear. The bear is placed in two other positions and the child is permitted to shoot twice at the bear in each position. He is told that he is free to fix the shooter in any of the holes he wishes, before taking a shot.

Now the bear is moved to a new position and a house is placed between the shooter and the bear. The child is told that he must now hit the bear without moving the house away and by bouncing the shot from one of the sides. He is, however, free to move the shooter into any of the holes drilled for it. He is permitted to keep shooting until he hits the bear or until he has shot five times. The bear is moved to another position and the instructions repeated. He is again permitted to shoot until he hits the bear or has shot five times.

Two additional houses are introduced and placed around the bear in such a way that the shot will have to bounce off two sides before it can hit the bear. The child is again given a maximum of five tries.

Finally, the bear is put in a new position and the preceding activity repeated.

MIRROR REFLECTION

The apparatus is placed on a low table so that the child can stand over it. The light source, fixed in the groove but to accommodate it, can be positioned anywhere along the groove. The target with illustrations of an elephant, a lion, a bear, and a deer is placed some distance from the light source and the child is shown how to make the light shine on an animal picture. No reflection is involved in this test. The child is then shown how to adjust the light to make it shine on the deer picture using one reflection. The child is then asked to adjust the light so that it shines on the elephant.

The light is reflected once to shine on the lion. The light source is now turned off and the child is asked to adjust it so that when it is turned on it will shine on the bear. He can then check his solution and make any necessary adjustments.

Now the child is shown how to reflect the light twice to shine on the deer. He is asked to adjust the light so that it reflects twice to hit the elephant. Then the light is reflected twice onto the lion. It is turned off and the child is asked to adjust it so that it hits the bear using two reflections.

APPENDIX B

CODE USED FOR RECORDING DATA FROM VIDEOTAPE

CODE FOR RECORDING DATA ON FOLD-OUT SHAPES
AND PROJECTED SHAPES

E ₁	Question by E/gesture.	V ₁	S asks for clarification/ Repeat question.
E ₂	Prompt by E.	V ₂	Repeats question to self.
E ₃	Praise by E.	V ₃	Expression on task/ materials.
E ₄	Encouragement by E.	V ₄	Grunts.
E _{6P}	"What seems to be the problem?"	V ₄	Grunts.
E _{6S}	"What square is the problem?"	V ₅	Irrelevant statements.
E _{6M}	"Can you move a piece?"	V ₆	Expression of surprise.
E ₇	"Go ahead and have a go." See what happens.	V ₇	"I don't know."
E ₈	Discusses materials.	V ₈	"OK."
E _{8S}	"Is that the same shape?"	Y	Nod for yes.
E _{8M}	"Tell me when you think you can."	V _Y	Verbal yes.
F _S	Pause and search.	N	Shake head for no.
F	Pause.	V _N	Verbal no.
F _L	Pause, looks at assembly.	L-R	Shift from left hand to right.
F _{LP}	Pause, looks at model.	T _R	Touches with right hand.
Rot _H	Rotates horizontally.	M _E	Matches edges.
Rot _V	Rotates in vertical.		
P	Puts down last mentioned piece.		
L	Lifts piece 1 with left hand.		



Order in which
squares are raised.

CODE FOR RECORDING DATA ON REFLECTION PROBLEMS

- | | | | |
|----------------|---|----------------|---|
| E ₁ | Instruction to shoot. | V ₁ | Asks question
clarify/repeat question. |
| E ₂ | Prompt (turn shooter). | V ₂ | Subvoiced/repeats E's question. |
| E ₃ | Praise by E. | V ₃ | On task/unusual. |
| E ₄ | Encouragement by E. | V ₄ | No. |
| E ₅ | Irrelevant statement. | V ₅ | Yes. |
| E ₆ | "Show me with your finger
where you want the ball
to go." | | |
-
- Correct move (rot.)
 - Wrong move (rot.)
 - Correct move but moves
on firing.
 - Move of shooter to new hole.
- L Look.
- L-S Looks from shooter to bear.
- S₁ Sights along shooter.
- S Hit.
- O Miss.
- 1 Move to adjacent hole
- 2 Move to next to adjacent hole.
- R₁ Resets to shoot direct.
- R₂ Reverses rotation to shoot
at wall.

APPENDIX C

SAMPLES OF ARRANGEMENTS OF SIX SQUARES

1. The Complete Set of Hexaminoes
(Arrangements of Six Squares)
which will Fold Up into a Cube
2. Some of the 24 Hexaminoes
(Arrangements of Six Squares)
which will not Fold Up into a Cube

HEXOMINOS WHICH WILL FOLD UP INTO A CUBE

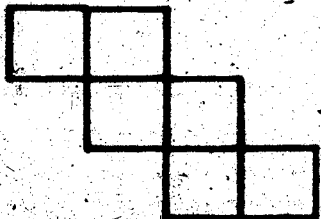
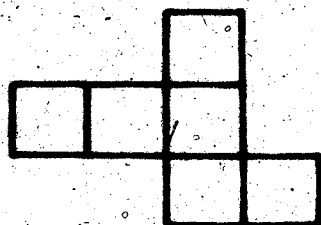
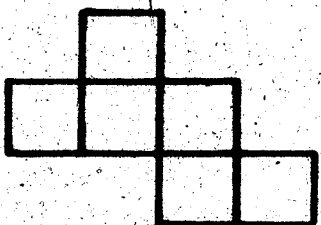
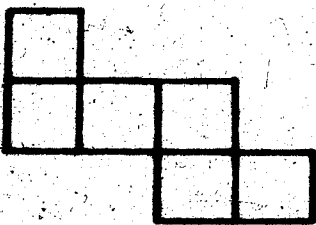
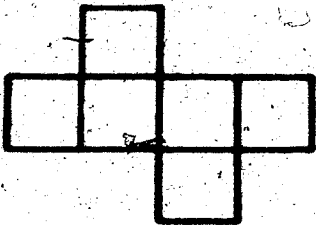
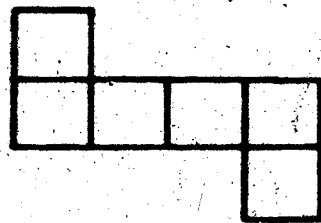
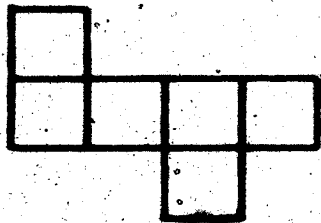
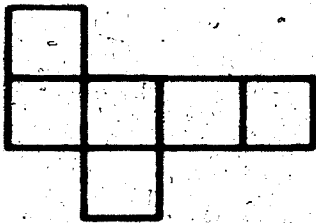
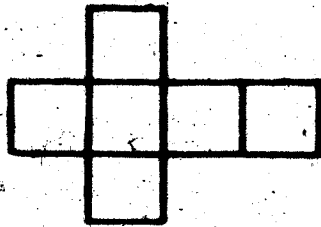
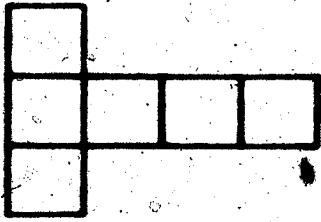

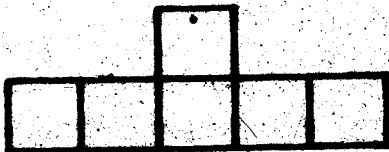
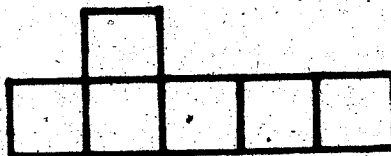
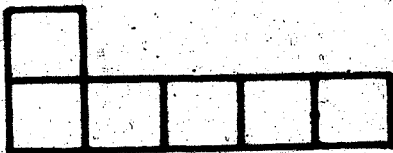
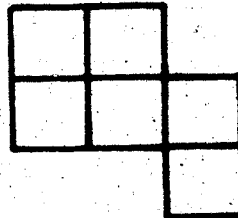
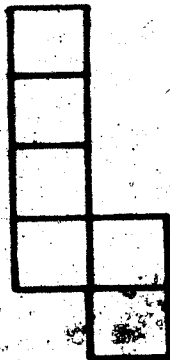
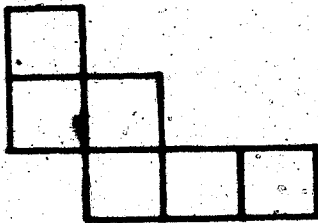
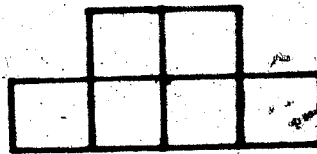
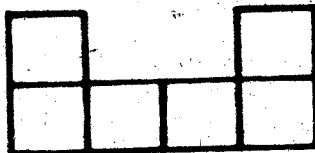
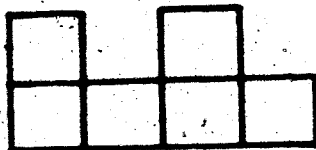
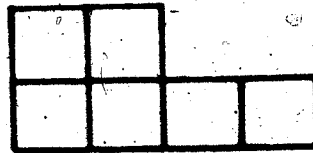
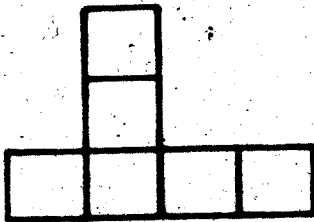
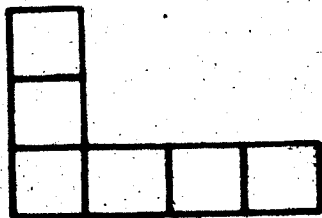
HEXOMINOS WHICH WILL NOT FOLD UP INTO A CUBE

APPENDIX D

ILLUSTRATIONS OF PROBLEM-SOLVING SITUATIONS
TAKEN FROM THE VIDEOTAPE RECORDER

1. The Folding of Shape F
2. Forming the Tetrahedron.
3. Constructing the Dodecahedron
4. The Object Reflections Task



1. Folding Shape P



2. Forming the Tetrahedron



3. Constructing the Dodecahedron

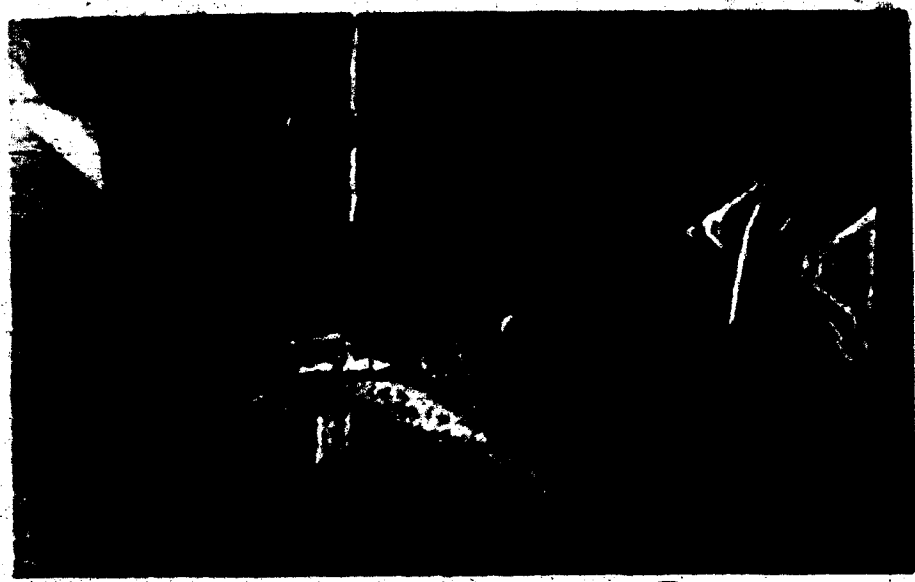

4. The Object Reflections Task

APPENDIX

SAMPLE OF PROBLEMS

1. Fold-out Shapes Problem
2. Projected Shapes Problem
3. Object Reflection Problem
4. Mirror Reflection Problem

NAME 6

CA 5-11

TABE 55

FOLD-OUT SHAPES

TABE 9

TETRAHEDRON: $E_1: V_1$ (4 faces). Pick up 3 Δ , P, L, V_1 , join edges. Hole -
INITIAL ASSEMBLY $E_2: V_2$ (about edges), P, L, V_1 , hole other 3 - L.

Add 2nd cube and rotate, check edges, $\uparrow \Delta$, insert one piece in
 pocket V_1 (about edges) $E_3: E_2, S$ fits from one of V_1 (flaps sticky)

①



$E_1: L, R, V_1$ (I know you can't make it with 2, right?)
 β but don't join edges. Pick up 2 more but don't
 join them. V_2 (about edges), P, L, V_1 , at the moment it
 fits. S separates. V_2 (I think I can). Close with R. E_3

②



$E_1: V_5, R, L, S, P, S, \beta, V$ (undistinguished), V_4
 E separates, E_6, P, V_4, E_5, V_4 E separates.

DODICAHEDRON

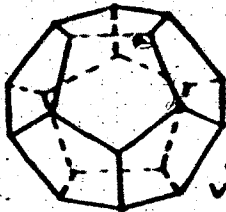

V_6, E_1 (break apart, put together again), E detaches
 1 part. S places it in hole. S separates remainder
 attempt to fit. detaches part at X and changes mind.
 V_2, V_3 (about detached piece) $E_1: V_1$ (can't put this
 one in (holds single part). E (leaves that for a minute
 and see what you can do with the others).
 V_3 (I can't make this thing fit).

R, L, V_3 (about face)
 $V_1, V_2, 4/5/6/7/8$
 E (32) hole that for you and like 1/2/3) 4-8,
 S joins 9 to 3, 10 detaches, \uparrow 4-8, E_4 .
 V_3 (to self) V_3 (I stick there) and bring
 4/5/6/7/8 into place in one move. Join
 1 to 8 and E helps. $V_4: R, L$, and
 closes with 7. V_3 (I made a small
 one). E_3, S picks up 11, inserts
 and adds to top. V_3 (about
 edges) E_3 .

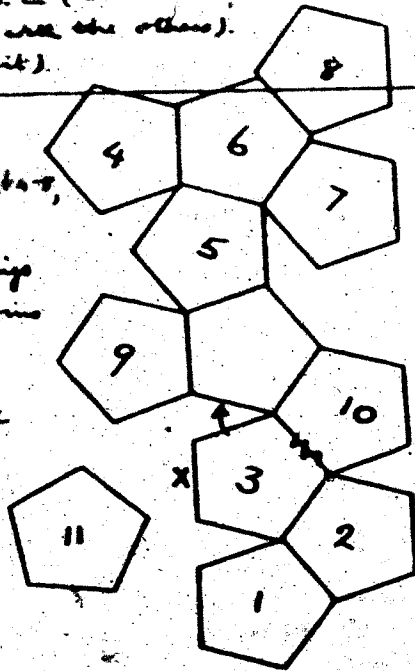

PROJECTED SHAPES

TAPE 7A

TASK 5

CA 7-9

NAME C

NAME	DIAGRAM	SIDES	INNOVATION	SHAPE	SHADOW	NUMBER OF FRONTS	MANIPULATIONS	VIEW MOVES	FRONT VIEW	LEFT SIDE VIEW	CHOICE	REMARKS
1		No				3	front view	front view	R	front	a	front shown with only one view
2		.				3	front view	front view	B	front	b	front shown with only one view
3		.				3	front view	front view	R	front	c	No difficulty found
4		.				3	front view	front view	B	front	d	No problem: only one view
5		.				3	front view	front view	B	front	e	front view: getting 1 view
6		.				3	front view	front view	B	front	f	front view: getting 1 view
7		.				3	front view	front view	B	front	g	front view: getting 1 view
8		.				3	front view	front view	B	front	h	front view: getting 1 view
9		.				3	front view	front view	B	front	i	front view: getting 1 view
10		.				3	front view	front view	B	front	j	front view: getting 1 view
11		.				3	front view	front view	B	front	k	front view: getting 1 view
12		.				3	front view	front view	B	front	l	front view: getting 1 view

NAME S TAPE 1-1 OBJECT REFLECTION
 CR 54 TAPE 4

DIRECT		1	2	3	4	5
1		$E_1 V_1 \ 0$	$E_2 E_3 V_2 \ 0$	$E_4 \ 0 \ 0$	$V_2 \ + \ H$	E_5
2		V_2 found across the wire				E_5 along whole
3		E_2 more and more of				FPB
4		E_2 more & other wire has been checked				
SOURCE		1	2	3	4	5
1		$E_1 V_1 V_2 \ 0$	$+ \ 0$	$V_2 E_3 \ + \ 0$	$+ \ H$	V_2
2		V_2 is roughly there				LS - LFP, at wire. LFP at wire. LSA - W
3		V_2 - bridge				FPB
4		$E_1 V_1 E_2 \ 0$	$V_2 E_3 \ + \ 0$	$E_4 V_2 \ + \ 0$	$V_2 \ + \ 0$	$0 \ 0 \ 0 \ 0 \ + \ H \ V_2$
5		V_2 is back & stay the same. 5 more or less for the position				
6		same & a little.				LS - S - S - S. LSA - W. FPB. LSA - W. FPB.
SOURCES		1	2	3	4	5
1		$E_1 V_1 \ - \ 0$	$V_2 \ + \ 0$	$E_3 \ + \ H$	$E_4 V_2$	
2		LS - W - B - S - S. LFP, LSA. FPB.				
3		$E_1 \ - \ 0$	$- \ 0$	$+ \ 0$	$E_4 \ + \ 0$	$- \ 0 \ + \ 0 \ + \ 0 \ + \ 0$
4		Kept at a rapid operation process with minimal				
5		$+ \ 0$	$+ \ H$			
6		alterations.				

E. L. B. D.

TAPE 8-6

WISDOM REFLECTION

CA 8-7

TASK 6

NAME

I NO REFLECTION

Sets on D					
R + G E	R + G E	R + G L	R + G B		

E discusses reflection.
 E₁ can you tell me what's happening to the light?
 V₃ is reflecting
 E₂ when is the glass off vertical is reflecting?
 S points to far mirror (1) E₁. R+ but too far - request E₃

II ONE REFLECTION

Sets on D			Sets on L	
R + G E			R + G B	

(1) E₁: R+ but too far adjust after light is written on
 EGM. SR+ E₃.

(2) E₁. R - resulting in single bounce to elephant. E₂ (how many bounces?) V₃ (one). E₁ repeated. S Rot + slightly. E₂ (do you get to shine over here first. S not further, then returns. E₂ (but turning it that way E helps S to turn to correct position. E₃

III TWO REFLECTIONS

Sets on D			Sets on L	
R + G E			R + G B	

(1) E sets light on B and switches off. E₁. R+ the mirror moves adjustment then further + rot. E₂ and switches on light. E₃. EGM S moves light to B. E₂ how many bounces does the light make - show me where it is going? V₃ to there, and there and there. S fits to each mirror and screen. E₃.

APPENDIX F

ALLOCATION OF PROBLEM SETS TO SUBJECTS
FOR EACH AGE GROUP

**ALLOCATION OF PROBLEMS TO SUBJECTS
FOR EACH AGE GROUP**

Subject	Problem			
	1	2	3	4
1			x	
2				
3	x	x		
4			x	
5	x		x	x
6	x	x		
7			x	x
8	x	x	x	
9	x			
10	x	x	x	x
11			x	x
12	x		x	
13	x			
14	x		x	x
15	x	x	x	

1. Fold-out Shapes Problem
2. Projected Shapes Problem
3. Object Reflections Problem
4. Mirror Reflections Problem

ALLOCATION OF PROBLEM SETS TO SUBJECTS
FOR EACH AGE GROUP

Problem Set	Problems Given					
01	1	7	5	3	2	4
02	5	3	1	9	6	2
03	3	11	1	5	12	2
04	3	9	7	1	10	2
05	1	7	3	11	2	8
06	9	1	3	11	4	12
07	7	9	1	5	8	6
08	11	7	5	1	12	6
09	1	5	11	9	6	10
010	9	1	11	7	12	8
011	5	3	9	7	4	8
012	11	5	7	3	6	4
013	9	3	5	11	10	4
014	7	11	9	3	8	10
015	5	11	9	7	12	10

1. Cargo groups problem
2. Animal groups problem
3. Parking lot problem
4. Theatre grid problem
5. Linear sequence problem
6. Circular sequence problem
7. Object reflection problem
8. Mirror reflection problem
9. Factor platform problem
10. Factor board problem
11. Fold-up shapes problem
12. Projected shapes problem

* Problems in this study.