

INFORMATION TO USERS

This manuscript has been reproduced from the microfilm master. UMI films the text directly from the original or copy submitted. Thus, some thesis and dissertation copies are in typewriter face, while others may be from any type of computer printer.

The quality of this reproduction is dependent upon the quality of the copy submitted. Broken or indistinct print, colored or poor quality illustrations and photographs, print bleedthrough, substandard margins, and improper alignment can adversely affect reproduction.

In the unlikely event that the author did not send UMI a complete manuscript and there are missing pages, these will be noted. Also, if unauthorized copyright material had to be removed, a note will indicate the deletion.

Oversize materials (e.g., maps, drawings, charts) are reproduced by sectioning the original, beginning at the upper left-hand corner and continuing from left to right in equal sections with small overlaps. Each original is also photographed in one exposure and is included in reduced form at the back of the book.

Photographs included in the original manuscript have been reproduced xerographically in this copy. Higher quality 6" x 9" black and white photographic prints are available for any photographs or illustrations appearing in this copy for an additional charge. Contact UMI directly to order.

UMI

A Bell & Howell Information Company
300 North Zeeb Road, Ann Arbor MI 48106-1346 USA
313/761-4700 800/521-0600



University of Alberta

Frequency and Time-domain Techniques For Control Loop
Performance Assessment

by

Anand Vishnubhotla



A thesis
submitted to the Faculty of Graduate Studies and Research
in partial fulfillment of the requirements for the degree of

Master of Science

in

Process Control

Department of Chemical and Materials Engineering

Edmonton, Alberta

Fall 1997



National Library
of Canada

Acquisitions and
Bibliographic Services

395 Wellington Street
Ottawa ON K1A 0N4
Canada

Bibliothèque nationale
du Canada

Acquisitions et
services bibliographiques

395, rue Wellington
Ottawa ON K1A 0N4
Canada

Your file *Votre référence*

Our file *Notre référence*

The author has granted a non-exclusive licence allowing the National Library of Canada to reproduce, loan, distribute or sell copies of this thesis in microform, paper or electronic formats.

The author retains ownership of the copyright in this thesis. Neither the thesis nor substantial extracts from it may be printed or otherwise reproduced without the author's permission.

L'auteur a accordé une licence non exclusive permettant à la Bibliothèque nationale du Canada de reproduire, prêter, distribuer ou vendre des copies de cette thèse sous la forme de microfiche/film, de reproduction sur papier ou sur format électronique.

L'auteur conserve la propriété du droit d'auteur qui protège cette thèse. Ni la thèse ni des extraits substantiels de celle-ci ne doivent être imprimés ou autrement reproduits sans son autorisation.

0-612-22686-7

University of Alberta
Library Release Form

Name of Author: **Anand Vishnubhotla**
Title of Thesis: **Frequency and Time-domain Techniques For
Control Loop Performance Assessment**
Degree: **Master of Science**
Year this degree granted: **1997**

Permission is hereby granted to the **University of Alberta Library** to reproduce single copies of this thesis and to lend or sell such copies for private, scholarly or scientific research purposes only.

The author reserves all other publication and other rights in association with the copyright in the thesis, and except as hereinbefore provided neither the thesis nor any substantial portion thereof may be printed or otherwise reproduced in any material form whatever without the author's prior written permission.

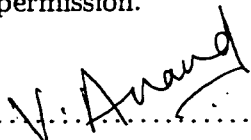
.....

(Student's signature)

Anand Vishnubhotla
Department of Chemical Engineering
University of Alberta
Edmonton, Alberta
Canada T6G 2G6

Date : *May 22, 1997* .
.....

University of Alberta
Faculty of Graduate Studies and Research

The undersigned certify that they have read, and recommend to the Faculty of Graduate Studies and Research for acceptance, a thesis entitled **Frequency and Time-domain Techniques For Control Loop Performance Assessment** submitted by **Anand Vishnubhotla** in partial fulfillment of the requirements for the degree of **Master of Science in Process Control**.

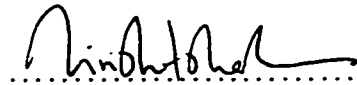

Prof. S.L. Shah (Supervisor)

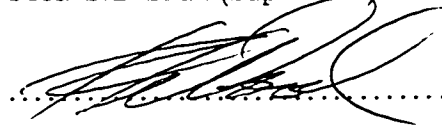

Prof. R.K. Wood



Prof. M. Meng (External examiner)

Date : May 21, 1997

To My Parents and Sister

Abstract

The preferred mode of control and automation in the chemical process industry is via distributed control systems(DCS) that typically consist of hundreds of control loops working simultaneously to achieve reliable and efficient process operation. In such conditions control loop performance assessment is extremely important because it helps the process control engineer monitor these control loops to ensure that they operate at optimum conditions.

The key idea in performance assessment is to have a benchmark against which the existing controller performance can be evaluated. The minimum variance benchmark represents one such benchmark and gives the theoretical best achievable output variance. It can be estimated by simple time series analysis of closed-loop operating data. In a typical process there are both measured and unmeasured disturbances. Analysis of variance of the closed-loop output is shown to provide an estimate of the relative contribution from these measured and unmeasured disturbances to the overall output variance. This analysis also provides the incentive for implementing feedforward control of the measured disturbances.

Spectral analysis of routine operating data complements the time domain performance assessment techniques. An insight into controller tuning guidelines is obtained by

comparing the actual output spectrum with the minimum variance benchmark spectrum. A method of determining whether the existing controller is over-tuned or under-tuned is obtained and this can then lead to guidelines to adjust various tuning parameters.

The techniques for control loop performance assessment as presented here were evaluated on three computer-interfaced pilot-scale processes and two industrial closed loop data sets from Shell USA and Cominco Inc.

Acknowledgments

I would like to thank my supervisor Dr. Sirish Shah for his excellent and enthusiastic guidance during the entire course of my M.Sc program. He influenced me greatly not only as at the technical level but also as at a personal level. He was a true 'friend, philosopher and guide'. I was extremely fortunate in pursuing my graduate research under his guidance.

I would also like to thank Dr. Grant Fisher who always emphasized on the practical aspects of process control. I also thank him for making sure that the computer process control group always had the state-of-the-art software and hardware which was very helpful during the course of my research. I would like to thank Dr. Biao Huang for his valuable suggestions and help during the entire course of my research. I had many interesting discussions with him on the area of control loop performance assessment. I am indebted to Dr. Lanre Badmus for helping me with some of the experimental setups. I would like to thank Dr. Reg Wood and Dr. Fraser Forbes for their feedback on my research.

It has been a wonderful experience working in the computer process control group at the U of A. The group consists of people with broad range of research interests and always has been a great place to discuss new research ideas. Many thanks to my student

colleagues: Dr. Lakshminarayanan, Hiroyuki Fujii, Kamrunahar, Amy Yiu, Rohit, Arun. Dr. Munawar Saudagar, Aseema, Dr. Pranob Banerjee, Dr. Danyang Liu, Dr. Kent Qi, Daniel, Lisa, Dayadeep (Misha), Sirajul Khan, Li, Ricky Leung, Chee Wong, Albert Chiu. There are many other persons outside the group who made my stay here enjoyable. In particular, I would like to thank Bob Barton and Kevin Dorma for helping me in the DACS center. I would also like to thank Walter and Richard for their help in the CPC lab.

Finally, I would like to thank my parents and sister for their constant support, love and affection.

Contents

1	Introduction	1
1.1	Control Loop Performance Assessment: A brief overview	1
1.2	Organization of the thesis	4
2	Feedback and Feedforward Control Loop Performance Assessment	5
2.1	Introduction	5
2.2	Performance analysis using minimum variance feedback control as a benchmark	6
2.2.1	Simulation example	8
2.2.2	Experimental study	10
2.3	Performance assessment using minimum variance FF and FB control as the benchmark	14
2.3.1	Steps involved in performance assessment	15
2.3.2	Screening the measured disturbances for their potential for im- plementing FF control	15
2.3.3	Analysis of variance	16
2.3.4	Experimental study	19
2.4	Conclusion	23
3	Spectral Techniques in Performance Assessment	24
3.1	Introduction	24

3.2	Signal processing in frequency domain	25
3.2.1	Discrete Fourier transform	25
3.2.2	Power spectrum	26
3.2.3	Frequency response of a transfer function	27
3.3	Controller tuning	29
3.3.1	Introduction	29
3.3.2	Simulation example	31
3.3.3	User specified closed loop response	32
3.4	Experimental results	39
3.4.1	Single tank pilot-scale process	39
3.4.2	The light bulb experiment	42
3.5	Conclusions	44
4	Industrial Case Studies	46
4.1	Introduction	46
4.2	Shell Industrial Case Study	47
4.2.1	Problems to be considered	47
4.2.2	Column 1	49
4.2.3	Column 2	55
4.2.4	Column 3	66
4.2.5	Concluding remarks	69
4.3	Cominco Industrial Case Study	73
4.3.1	Performance analysis	73
4.3.2	Benefits analysis	82
4.3.3	Principal components analysis	87
4.3.4	Concluding Remarks	89

5	Conclusions	90
5.1	Contributions of this thesis	91
5.2	Future Work	92
A	Steps Involved In Performance Assessment	96
B	Laboratory Scale Performance Monitoring Using LabVIEW	100
B.1	Introduction	100
B.2	System configuration	101
B.3	Main features	102

List of Tables

2.1	Analysis of variance	17
2.2	Analysis of variance (single tank pilot-scale process)	23
4.1	Analysis of variance on Column 1	55
4.2	Analysis of variance on Column 2 (data set 1)	62
4.3	Analysis of variance on Column 2 (data set 2)	63
4.4	Analysis of variance on Column 2 (data set 3)	64
4.5	Analysis of variance on Column 3	70
4.6	Comparison of performance for different controller Settings	72
4.7	Analysis of variance (Stage 2 pH control)	81
4.8	Effect of increase in performance on stage 2 output variance	82
4.9	Analysis of variance (Stage 1 pH control)	86
4.10	Analysis of variance using PCA (Stage 2 pH control)	89

List of Figures

2.1	<i>Block diagram of a typical single input single output feedback control system</i>	7
2.2	<i>Simulation example: Process output</i>	9
2.3	<i>Simplified schematic of the two-tank pilot-scale process</i>	11
2.4	<i>Open loop identification test: Process output and input</i>	11
2.5	<i>Residual analysis of the identified open loop model</i>	12
2.6	<i>Cross-correlation between process input and output (Open loop test)</i>	12
2.7	<i>Predicted output (-.-) versus measured output (—)</i>	13
2.8	<i>Contribution to output variance from various sources of disturbances</i>	18
2.9	<i>Schematic of single tank pilot scale process</i>	20
2.10	<i>Single tank pilot scale process: Process output (Water level in tank 1); Controller output and Measured disturbance</i>	20
2.11	<i>Cross-correlation between the measured disturbance and process output (water level in tank 1)</i>	21
2.12	<i>Residual test for the regression model fitted to the process output</i>	22
2.13	<i>Cross-correlation between the driving forces for unmeasured disturbance (a_t) and measured disturbance (b_t)</i>	22
3.1	<i>Output spectrum for different controller settings</i>	32
3.2	<i>Typical ACF for different closed loop dynamics</i>	33
3.3	<i>Output spectrum for different values of integral time constant (T_i)</i>	36

3.4	<i>Output spectrum for different values of proportional gain (K)</i>	37
3.5	<i>Performance Index for a moving window of 500 data points</i>	38
3.6	<i>Output spectrum for different controller settings</i>	38
3.7	<i>Actual output spectrum versus spectrum of desired closed-loop dynamics</i>	39
3.8	<i>Schematic diagram of the single tank computer-interfaced pilot-scale process</i>	40
3.9	<i>Single tank pilot scale process: Process output (water level in tank 1) and manipulated variable (stem position of the valve)</i>	41
3.10	<i>Single tank pilot scale process: Measured output versus predicted output from the model</i>	42
3.11	<i>Single tank pilot scale process: Output spectrum for different controller settings</i>	43
3.12	<i>Schematic diagram of the light bulb experiment</i>	43
3.13	<i>Light bulb: Output trends for different controller settings</i>	44
3.14	<i>Light bulb: Spectrum for different controller settings</i>	45
4.1	<i>Column 1: Output and Setpoint trends</i>	49
4.2	<i>Column 1: Disturbance trends</i>	50
4.3	<i>Column 1: Output ACF vs. Desired ACF</i>	51
4.4	<i>Column 1: Performance Index</i>	52
4.5	<i>Column 1: Performance Index with a sliding window of size 1440; (-.-.- Index with a moving window of size 1440)</i>	52
4.6	<i>Cross-correlation between output error and disturbances</i>	53
4.7	<i>Column 1: Spectra of output and disturbances</i>	54
4.8	<i>Column 1: Spectrum of output with desired spectrum and MV spectrum</i>	56
4.9	<i>Column 2, data set 1: Output error, set point and disturbance trends</i>	56
4.10	<i>Column 2: Actual ACF vs Desired ACF; Time constant = 4 min; Sampling time = 1 min</i>	57

4.11	<i>Column 2: Actual ACF (ooo) vs Desired ACF (***)</i> ; Time constant = 4 min, Sampling time = 1 min	58
4.12	<i>Column 2: Performance Index for data sets 1, 2 and 3 with a moving window of size 1440</i>	59
4.13	<i>Column 2, data set 1: Cross-correlation between output and disturbances 1 and 2</i>	60
4.14	<i>Column 2, data set 2: Cross-correlation between output and disturbances 1 and 2</i>	60
4.15	<i>Column 2, data set 3: Cross-correlation between output and disturbances 1 and 2</i>	61
4.16	<i>Column 2, data set 1: Spectrum of output error and disturbance 2 (differenced)</i>	62
4.17	<i>Column 2, data set 2: Spectrum of output error and disturbance 2 (differenced)</i>	63
4.18	<i>Column 2, data set 3: Spectrum of output error and disturbance 2 (differenced)</i>	64
4.19	<i>Column 2, data set 1: Actual output spectrum with desired spectrum and MV spectrum</i>	66
4.20	<i>Column 2, data set 2: Actual output spectrum with desired spectrum and MV spectrum</i>	67
4.21	<i>Column 2, data set 3: Actual output spectrum with desired spectrum and MV spectrum</i>	68
4.22	<i>Column 3: Output error and disturbance trends</i>	68
4.23	<i>Column 3: Actual ACF (ooo) vs Desired ACF (***)</i> ; Time constant = 20 min; Sampling time = 1 min;	69
4.24	<i>Column 3: Performance Index with each point representing a moving window of 360 points</i>	70

4.25	<i>Column 3: Performance Index with a sliding window of size 360; (-.-.- Performance index with a moving window of size 360)</i>	71
4.26	<i>Column 3: Cross-correlation between output error and disturbance trends</i>	71
4.27	<i>Simplified schematic of the Cominco acid Leach process</i>	74
4.28	<i>Stage 2: Controlled variable and manipulated variable</i>	75
4.29	<i>Autocorrelation function of stage 1 and stage 2 output error</i>	76
4.30	<i>1. Cross-correlation between output 2 and manipulated variable 1 (upper figure); 2. Cross-correlation between output 1 and manipulated variable 2 (lower figure).</i>	77
4.31	<i>Performance index of stage 2 controller</i>	78
4.32	<i>Cross-correlation between various disturbances and output error</i>	79
4.33	<i>Actual output spectrum (stage 2) vs. minimum variance spectrum</i>	80
4.34	<i>1. Spectrum of output error (stage 2); 2. Spectrum of disturbance 2</i>	81
4.35	<i>Simulated process with different output variances</i>	84
4.36	<i>Simulated process operating conditions with different output variances</i>	84
4.37	<i>Performance index for stage 1 controller</i>	85
4.38	<i>Cross-correlation between different disturbances and stage 1 output</i>	86
4.39	<i>Loadings plot</i>	88
A.1	<i>Steps involved in Performance Assessment (I)</i>	97
A.2	<i>Steps involved in Performance Assessment (II)</i>	98
A.3	<i>Steps involved in Performance Assessment (III)</i>	99

Chapter 1

Introduction

1.1 Control Loop Performance Assessment: A brief overview

Modern chemical process industries are highly automated and contain hundreds of control loops that run on various distributed control systems (DCS). The task of the process control engineer is to implement new control algorithms and improve the performance of existing controllers. There are many techniques for designing and implementing a control algorithm ranging from simple PID type algorithms to advanced model predictive control algorithms. But there are few tools that can be used for assessing the performance of existing controllers. This in spite of the fact that automatic controller performance assessment is very important in the chemical industry because of changes in equipment and process conditions and the consequential deterioration in the performance of existing controllers. Ideally performance assessment techniques should be carried out with minimum interference in routine process operation.

Harris(1989) introduced a very simple time series technique to obtain the best theoretically achievable feedback control performance as measured by the output mean

square error for a single input and single output (SISO) system. The most important feature of this technique is to obtain a measure of performance using routine closed loop data with minimum variance control as a reference benchmark. Many researchers have proposed similar or slightly modified performance indices. Desborough and Harris(1992) propose a normalized performance index. Kozub and Garcia(1993) define the measure of performance as closed loop potential (CLP). Tyler and Morari(1995) have extended the same idea to non-minimum phase SISO processes. Huang *et al.*(1995a,1996) have extended the SISO performance assessment techniques to multivariate systems. In their results, they utilize the multivariate analog of the univariate delay term known as the interactor. Desborough and Harris(1993), Stanfelj *et al.*(1993), Huang(1997) have extended the feedback assessment techniques to feedback plus feedforward control loops. Analysis of variance on process output can also be used to analyze the benefit of implementing feedforward control. Comparing the existing controller performance with minimum variance benchmark may not always be practical because minimum variance control usually requires excessive control action and has poor robustness properties. Kozub and Garcia (1993) have proposed that desired closed loop dynamics serve as a benchmark with which the actual output dynamics are compared. Tyler and Morari(1995) propose performance assessment and monitoring schemes based on constraints on the impulse response coefficients using likelihood estimates. More recently Huang and Shah(1996) have proposed performance assessment with user defined benchmark under a unified H_2 framework.

Most of the performance assessment techniques are based on time domain analysis. Spectral analysis involves transforming the time series data into the frequency domain. The frequency domain expressions are analogous to the time domain expressions. However, spectral analysis provides valuable additional insight and information into time series data. For example, spectral analysis can detect periodicities in process variables that may be otherwise unnoticed due to wide band noise. These periodicities in the process variables which are difficult to perceive in the time domain

become very evident when viewed in the frequency domain. Devries and Wu(1978) used spectral analysis to diagnose sources of periodic variation in a paper machine process. The minimum variance condition is usually verified by computing the autocorrelation function(ACF) of the closed loop output. If the controller is close to minimum variance condition then the ACF will be non-zero for the first $d - 1$ lags and zero thereafter where d is the delay of the process. Desborough and Harris(1992) extended the same idea to the frequency domain where the actual output spectrum is compared with minimum variance spectrum to verify how close the existing controller is to the minimum variance condition. This comparison in the frequency domain can be used to see how the controller is tuned with respect to the benchmark spectrum. The controller diagnosis problem is important in performance assessment. Once it is determined that the performance of an existing control system is not satisfactory and that it may be improved by re-tuning the controller, it is important to determine which controller parameters to tune and whether they need to be adjusted upwards or downwards. Comparing the actual spectrum with the minimum variance spectrum can yield information about the frequency range where the controller is performing poorly. It can also determine whether the controller is over-tuned or under-tuned with respect to the minimum variance benchmark so that appropriate action can be taken to improve the performance of the controller. An analogy to the classical 'water bed' effect (in optimal control) is used to illustrate that the minimum variance (MV) spectrum is the absolute lower bound of performance and that having better controller than minimum variance controller at some frequencies comes at the cost of deterioration in performance at other frequencies.

1.2 Organization of the thesis

The thesis is organized as follows. Performance assessment using the minimum variance benchmark for feedback control loops is introduced in chapter 2. The same idea

is extended to feedforward performance assessment in combination with the analysis of variance. All of these techniques are illustrated via simulation and experimental studies. Chapter 3 introduces the discrete Fourier transform which is very useful in transforming data in time domain to frequency domain. The power spectrum of routine operating data is used to detect if the process exhibits any periodicities. The power spectrum is also used to check how close the existing controller is to minimum variance condition. The controller tuning problem is thus addressed using spectral techniques for SISO systems and its application is illustrated via experimental examples. Applying the performance assessment techniques to industrial data confirms the usefulness of the above techniques. In chapter 4, the performance assessment techniques are evaluated by application to two industrial data sets. The first data set is from Shell USA. (The data was released by Kozub and Garcia(1993) for academic purposes and deals with three distillation columns at Shell USA). The second case study deals with the zinc acid leach process at Cominco Inc. In both case studies performance analysis was done using time domain and frequency domain techniques. The thesis ends with concluding remarks and suggestions for future work.

Chapter 2

Feedback and Feedforward Control Loop Performance Assessment

2.1 Introduction

Control loop performance monitoring is important to the control engineer, since it can be used to monitor and diagnose problems associated with the controllers and ensure that the controllers are performing in an optimal manner relative to process specifications. If a process exhibits performance close to minimum variance control, further reduction in the output variance cannot be achieved by retuning the existing controller. However further reduction may be achieved by implementing feedforward control and/or changing the control structure or the process. It has been proved that for a system with time delay d , the minimum variance which is feedback invariant can be estimated from routine closed loop data (Harris,1989). This gives the absolute lower bound for the variance. Desborough and Harris(1992) and Stanfelj *et al.*(1993) have extended this technique to the analysis of feedback plus feedforward control loops. Performance assessment of multivariate systems has been examined in detail by Huang *et al.*(1996, 1995a). The cross correlation between the potential feedforward

variables and the output may be used to determine which of them may be used for feedforward control. The analysis of variance (Desborough and Harris, 1993) highlights the contribution of various disturbances to the overall variance. This helps in determining the benefit of implementing feedforward control.

This chapter is organized as follows: Section 2.2 outlines performance analysis using a minimum variance feedback control benchmark; followed by extension to feedforward performance assessment in section 2.3. The chapter ends with concluding remarks in section 2.4.

2.2 Performance analysis using minimum variance feedback control as a benchmark

Consider a process whose output to be regulated is denoted by y_t , and the setpoint is represented by s_t as shown in Figure 2.1. T is the process transfer function which can also be written as $T = \tilde{T} q^{-d}$ where d is the delay of the process. N is the disturbance transfer function and a_t is a white noise sequence with constant variance and zero mean. Q is the feedback controller transfer function.

The closed loop transfer function between y_t and the disturbance a_t can be represented as:

$$y_t = \frac{N}{1 + TQ} a_t = \frac{N}{1 + q^{-d} \tilde{T} Q} a_t \quad (2.1)$$

The disturbance transfer function N can be expanded using the following diophantine identity:

$$N = \underbrace{\psi_0 + \psi_1 q^{-1} + \psi_2 q^{-2} + \dots + \psi_{d-1} q^{-(d-1)}}_F + R q^{-d} \quad (2.2)$$

where R is a proper rational transfer function (Huang, 1997). Equation (2.1) will

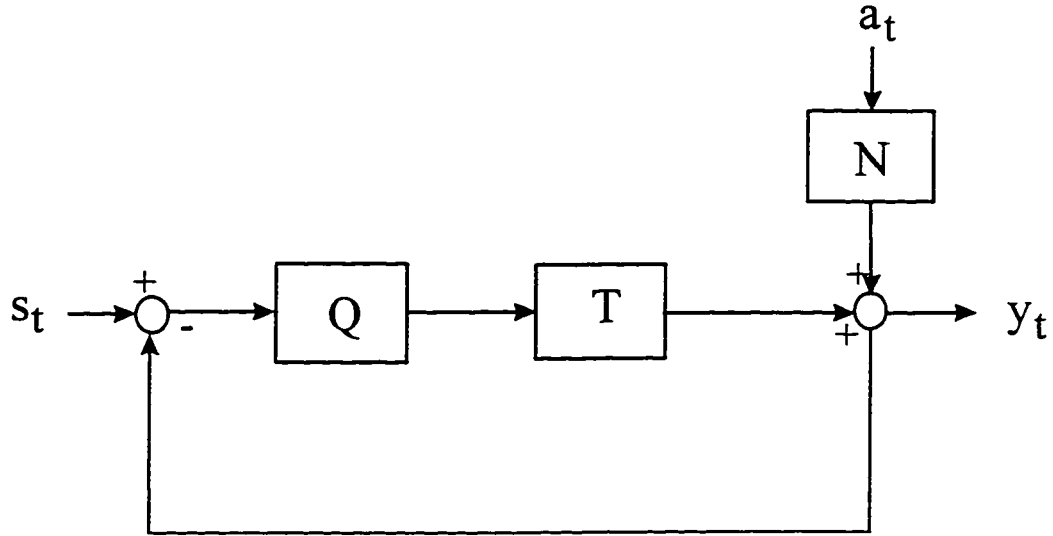

Figure 2.1: *Block diagram of a typical single input single output feedback control system*

then reduce to

$$\begin{aligned}
 y_t &= \frac{F + q^{-d}R}{1 + q^{-d}\tilde{T}Q} a_t & (2.3) \\
 &= [F + \frac{R - F\tilde{T}Q}{1 + q^{-d}\tilde{T}Q} q^{-d}] a_t \\
 &= F a_t + L a_{t-d}
 \end{aligned}$$

The above expression represents an infinite order moving average model where F is independent of the controller transfer function, Q , and is therefore the minimum variance process output. When setpoint changes are present, one can replace the output y_t with the output error defined as $\varepsilon_t = y_t - s_t$ and carry out performance assessment with ε_t instead of y_t . The output error can be written as an infinite order moving average (MA) process (Harris, 1989).

$$\varepsilon_t = (\psi_0 + \psi_1 q^{-1} + \psi_2 q^{-2} + \dots + \psi_{d-1} q^{-(d-1)} + \psi_d q^{-d} + \dots) a_t \quad (2.4)$$

The estimate of the minimum variance or the invariant portion of the output variance

is given by :

$$\sigma_{mv}^2 = (\psi_0^2 + \psi_1^2 + \psi_2^2 + \dots + \psi_{d-1}^2)\sigma_a^2 \quad (2.5)$$

Consider the performance index defined by

$$\begin{aligned} \eta(d) &\triangleq \sigma_{mv}^2 / \sigma_\varepsilon^2 \\ &= \frac{(\psi_0^2 + \psi_1^2 + \psi_2^2 + \dots + \psi_{d-1}^2)\sigma_a^2}{\sigma_\varepsilon^2} \end{aligned} \quad (2.6)$$

This performance index may be directly calculated via equation (2.6) (Harris, 1989) or via a regression analysis approach (Desborough and Harris, 1992). Alternatively $\eta(d)$ can be conveniently estimated via the FCOR (Filtering and Correlation) algorithm introduced by Huang *et al.*(1995). The FCOR (applicable to SISO and MIMO processes) algorithm consists of :

1. Fitting of routine operating time series output data, ε_t , by an ARMA or AR time series model or state space innovation model (via a Kalman Filter) and then estimation of the residuals or innovations sequence, a_t ;
2. A simple correlation analysis between ε_t and a_t to yield the performance index.

2.2.1 Simulation example

Feedback performance assessment is illustrated via a simulation example. The process used in the simulation is given by

$$G(q^{-1}) = \frac{q^{-3}(1.45 - q^{-1})}{1 - 0.8q^{-1}}$$

The process is being controlled by a proportional plus integral (PI) controller with a sampling time of 1 sec. The controller parameters are proportional gain $K = 0.23$ and the integral time constant $T_i = 1\text{sec}$. The process is under regulatory control. Figure 2.2 shows the closed loop output for this controller setting.

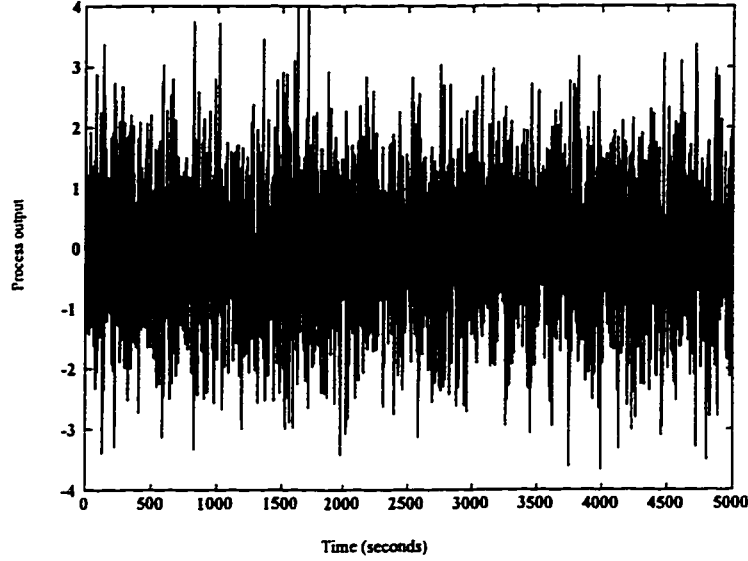

Figure 2.2: *Simulation example: Process output*

The first step involved in obtaining the performance index would be to obtain a time series model for the closed loop output. An auto regressive moving average model was used to represent the output. The ARMA model was then expanded as a finite order moving average model of the form

$$\varepsilon_t = (1 + .9826q^{-1} + .9847q^{-2} + .6907q^{-3} + \dots - .0006q^{-38} - .0004q^{-39} - .0001q^{-40})a_t$$

Since the process delay is three, the first three terms of the above moving average model form the feedback invariant portion of the output or the minimum variance output and can be written as

$$y_{t,mv} = (1 + .9826q^{-1} + .9847q^{-2})a_t$$

The performance index can then be obtained using equation (2.6). The variance of the input signal a_t was estimated from residual analysis of the time series model fitted to the output as $\sigma_a^2 = .3348$. The performance index η can then be obtained as

$$\eta(3) = \frac{\sigma_{mv}^2}{\sigma_\varepsilon^2} = \frac{[1 + (.9826)^2 + (.9847)^2]\sigma_a^2}{1.2561} = 0.7823$$

2.2.2 Experimental study

Experimental evaluation of the feedback performance assessment technique as applied to a single input single output (SISO) system will be illustrated by a pilot scale process. The objective is to control the water level in tank 2 by manipulating the stem position of the valve shown in Figure 2.3 (see Appendix B for experimental details). A cascade controller was implemented with a PID controller (with sampling time of 1 sec) in the inner (flow) loop. An IMC controller was implemented in the outer (level) loop with a sampling time of 10 sec. The IMC controller provides the setpoint for the flow controller. The IMC controller was implemented using *LabView/Matlab intergration platform with Dynamic data exchange (DDE)*.

One of the important information required for performance assessment is the delay of the process. An open loop test was performed to obtain a process model and also to determine the delay of the process. Figure 2.4 shows the water level in tank 2 (process output) and the stem position of the valve during the open loop test. The input sequence is a pseudo random binary sequence. The process model was identified through prediction error method (Ljung, 1987) as

$$G(q^{-1}) = \frac{.0729q^{-2}}{1 - 1.3991q^{-1} + .4267q^{-2}}$$

Figure 2.5 shows the residual analysis of the open loop model obtained. Cross-correlation analysis of the open loop output and input was performed to estimate the delay as shown in Figure 2.6. The delay is estimated as 2 sample intervals.

Routine closed loop data were collected using the IMC controller based on the model obtained from the open loop test. The first step in performance assessment as discussed in the previous example is to obtain a time series model for the output. An ARMA model was fit to the closed loop data. The ARMA model identified can also be written as a finite order moving average model of the form

$$\varepsilon_t = (1 + .8534q^{-1} + .9847q^{-2} + .7943q^{-3} + \dots - .0047q^{-49} - .0015q^{-50})a_t$$

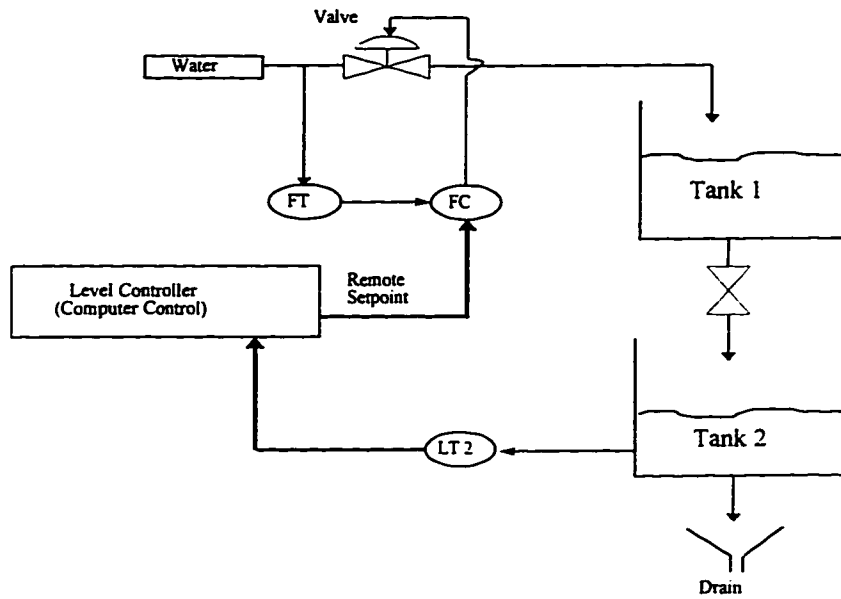

Figure 2.3: *Simplified schematic of the two-tank pilot-scale process*

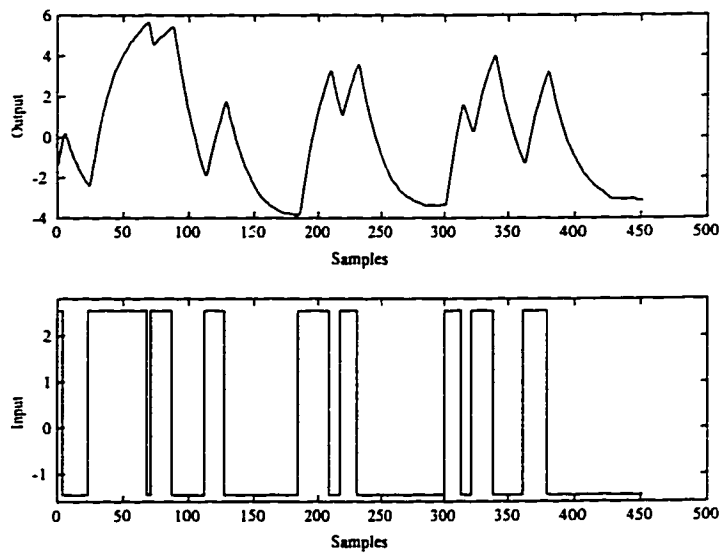

Figure 2.4: *Open loop identification test: Process output and input*

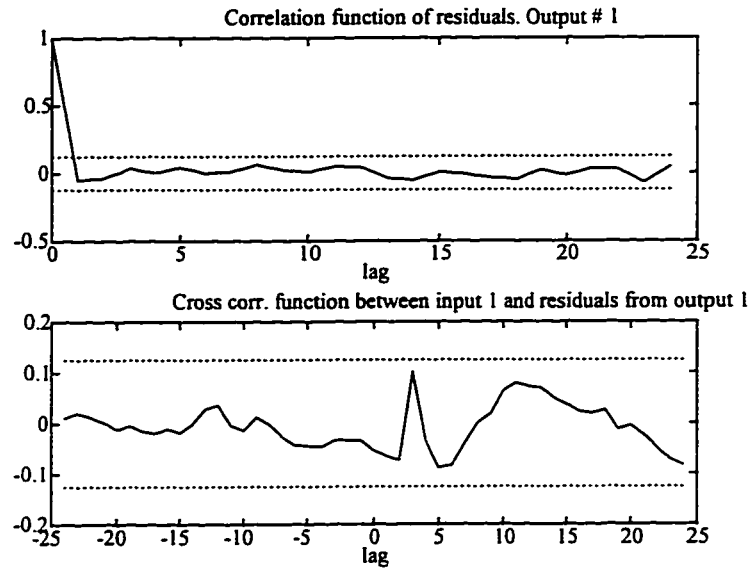

Figure 2.5: *Residual analysis of the identified open loop model*

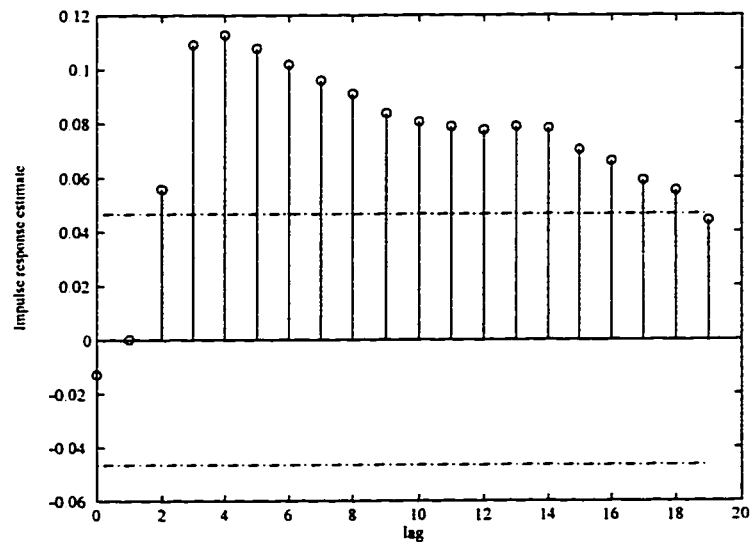

Figure 2.6: *Cross-correlation between process input and output (Open loop test)*

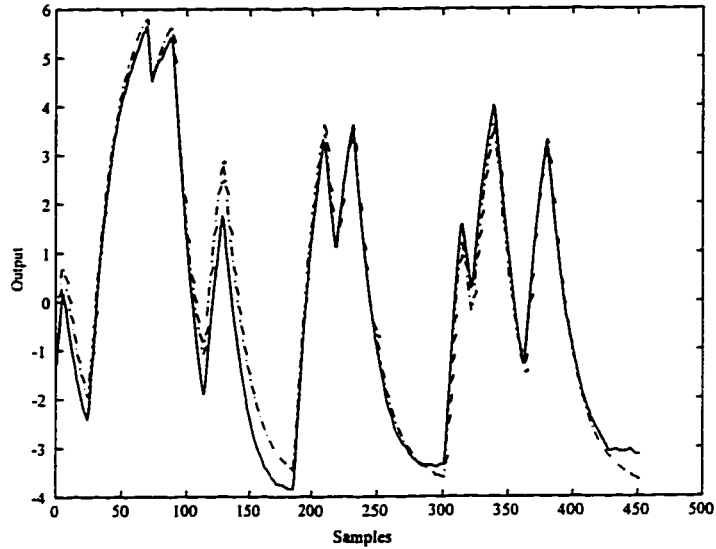

Figure 2.7: Predicted output (---) versus measured output (—)

Since the delay was estimated as two we can obtain the minimum variance or feedback invariant portion of the closed loop output as

$$y_{mv} = (1 + .8534q^{-1})a_t$$

Finally the performance index can be calculated as

$$\eta(2) = \frac{\sigma_{mv}^2}{\sigma_\epsilon^2} = \frac{[1 + (.8534)^2]\sigma_a^2}{.0063} = .4326$$

σ_a^2 can be estimated from residual analysis of the time series model fitted to the process output. The same performance index can also be obtained by using the FCOR algorithm.

2.3 Performance assessment using minimum variance FF and FB control as the benchmark

A closed loop response to both unmeasured and measured disturbances can be written as

$$\varepsilon_t = G_a a_t + \sum_{i=1}^m q^{-i} G_{D_{t,i}} D_{t,i} \quad (2.7)$$

where m is the number of measured disturbances. $D_{t,i}$ are measured disturbances. a_t represents the “shock” of the unmeasured disturbances. Substituting $D_{t,i}$ with a time series model of the form

$$D_{t,i} = G_b b_{t,i} \quad (2.8)$$

we get

$$\varepsilon_t = G_a a_t + \sum_{i=1}^m q^{-i} G_{D_{t,i}} G_b b_{t,i} \quad (2.9)$$

Expanding the above in impulse response form gives

$$\begin{aligned} \varepsilon_t = & \underbrace{(F_0^{(a)} + \dots + F_{d-1}^{(a)} q^{-(d-1)}) a_t}_{e_t^u} + \underbrace{(F_d^{(a)} q^{-d} + F_{d+1}^{(a)} q^{-d-1} + \dots) a_t}_{y_t^u} \quad (2.10) \\ & + \sum_{i=1}^m \left\{ \underbrace{(F_0^{(b)} q^{-i} + \dots + F_{d-l_i-1}^{(b)} q^{-(d-1)}) b_{t,i}}_{e_t^{mv_i}} + \underbrace{(F_{d-l_i}^{(b)} q^{-d} + \dots + F_{d-1}^{(b)} q^{-i-d+1}) b_{t,i}}_{e_{FF_i}} \right. \\ & \left. + \underbrace{(F_d^{(b)} q^{-i-d} + F_{d+1}^{(b)} q^{-i-d-1} + \dots) b_{t,i}}_{y_t^{(b_{t,i})}} \right\} \end{aligned}$$

Equation (2.10) is valid if the process time delay d is greater than the feedforward path time delay l_i . $e_t^{MV} = e_t^u + \sum_{i=1}^m e_t^{mv_i}$ constitutes the portion of minimum variance which is feedforward and feedback controller invariant. e_t^u is the variance contribution to e_t^{MV} from the unmeasured disturbances. y_t^u is due to the non optimality of the feedback controller. $e_t^{mv_i}$ is the variance contribution to e_t^{MV} from the measured disturbances. e_{FF_i} is due to the non optimality of the feedforward controller. $y_t^{(b_{t,i})}$ is the

contribution to the overall variance due to either non optimal feedback/feedforward controller or non optimal feedback plus feedforward controller. The significance of each of these terms is explained in the next section.

If the feedforward delay is greater than or equal to the process delay, then by implementing a minimum variance feedforward controller one can completely eliminate the contribution from the measured disturbances to the output variance. In this case $e_t^{mvi} = 0$. \hat{e}_{FF_i} may exist due to the non optimality of feedforward controller; $y_t^{(b_{t,i})}$ may also exist due to non optimality of either feedback/feedforward controller or feedback plus feedforward controller. The contributions from e_{FF_i} and $y_t^{(b_{t,i})}$ can be eliminated by a minimum variance feedforward controller.

2.3.1 Steps involved in performance assessment

Routine closed loop operating data can be used to perform analysis of variance and to obtain performance indices. When the objective is to minimize variation in the output variables, one needs to address two significant questions. First, what is the potential reduction in the output variation that could be obtained, and second which process variables have the most significant effect on the output variation. The various steps involved in performance assessment have been summarized in Appendix A. Two important steps require further discussion. They are:

2.3.2 Screening the measured disturbances for their potential for implementing FF control

Of the many measured disturbances, not all will have a significant effect on the output error. So one needs to carry out a screening test to determine which of them could be used for feedforward control. This involves two steps: (Desborough and Harris. 1993)

1. Fit a time series model to the disturbances. From this model obtain the residuals which give an estimate of the variance of the driving forces for the disturbances.
2. Compute the sample cross correlation between the residuals found in step 1 and the output error. This can give an idea of the delay structure of the disturbances. Disturbances which do not have any significant correlation are discarded from further analysis.

2.3.3 Analysis of variance

After identifying the prospective feedforward variables, the next task is to determine the benefit of implementing feedforward control of these measured disturbances. First we fit a regression model between the output error and the various measured disturbances as shown in equation (2.7). From the residuals of the above fitted model, one can get an estimate of the variance of the unmeasured disturbances σ_a^2 . Replacing the measured disturbances with a time series model for the disturbances and expanding it in impulse response form as in equation (2.10), provides an analysis of variance table as shown in Table 2.1.

The various terms obtained from equation (2.10) are explained in an earlier section. Consider the contribution from the unmeasured disturbance a_t . The minimum variance portion cannot be eliminated by any amount of control action. But the potential for further reduction in output variance by re-tuning the feedback controller is given by y_t^u . If the contribution to the overall variance is mainly from this source then one does not need to consider feedforward control on any measured disturbances. Instead one should concentrate all their efforts on re-tuning the existing feedback controller.

Now consider the contribution from the measured disturbances which mainly consists of three parts. e_t^{mv} constitutes the invariant portion and cannot be eliminated by any amount of feedforward control action. e_{FF} is the contribution due to non optimality of feedforward controller. This term is very important in determining the

Table 2.1: Analysis of variance

	MV FB/FF	Non opt.FB	Non opt.FF	Non opt.FB/FF	Total
a_t	e_t^u	y_t^u	-	-	$\sigma_{y,a}^2$
$b_{t,1}$	$e_t^{mv_1}$	-	e_{FF_1}	$y_t^{(b_{t,1})}$	$\sigma_{y,b_{t,1}}^2$
\vdots	\vdots	-	\vdots	\vdots	\vdots
$b_{t,m}$	$e_t^{mv_m}$	-	e_{FF_m}	$y_t^{(b_{t,m})}$	$\sigma_{y,b_{t,m}}^2$
Total	σ_{mv}^2	$\sigma_{y,FB}^2$	$\sum \sigma_{e_t,FF_i}^2$	$\sum \sigma_{y,FB/FF_i}^2$	σ_y^2

benefit of feedforward control. If the contribution to the output variance is from this source then no amount of feedback controller re-tuning will eliminate this source of variance. Whereas an optimal feedforward controller can eliminate this contribution completely. If further reduction in output variance is warranted then implementing feedforward control is a good option. $y_t^{(b_t)}$ represents the contribution due to non optimal feedback and/or non optimal feedforward controller. Theoretically this source of contribution can be eliminated either by a optimal feedback or feedforward controller. So feedback controller re-tuning becomes the first option if further reduction is necessary. Figure 2.8 shows the contribution to output error variance from various sources of disturbances.

One of the important assumptions during the analysis of variance is the independence of the pre-whitened input signals associated with the measured disturbances (b_t) and the driving force associated with the unmeasured disturbances (a_t). If this assumption is not valid, it is impossible to uniquely determine the contribution of the various disturbances to the overall output variance. It is necessary to check the independence of these input signals. This can be checked by doing a simple cross-correlation test between these input signals. If these signals are dependent, the analysis becomes more complex and involved. One way of handling such processes is by considering Vector Autoregressive Moving Average models (DeVries and Wu, 1978)

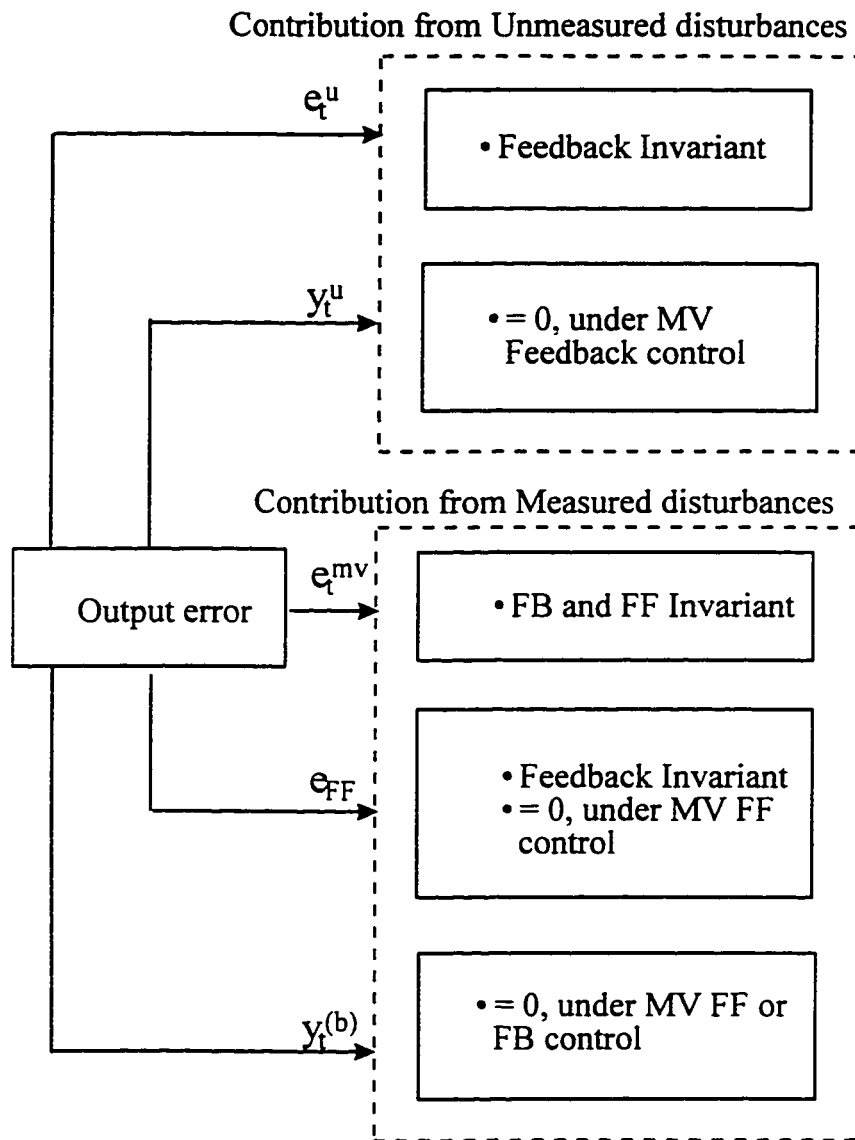

Figure 2.8: Contribution to output variance from various sources of disturbances

and carrying out multivariate regression analysis.

2.3.4 Experimental study

The various steps involved in performance assessment will be illustrated by application to computer-interfaced, pilot-scale process. The objective is to control the water level in tank 1 by manipulating the stem position of the valve shown in Figure 2.9 (see Appendix B for experimental details). An Internal Model Controller (IMC) was implemented via *LabVIEW/MATLAB* integration platform with *Dynamic Data Exchange (DDE)* with a sampling time of 5 seconds. The process transfer function was identified from a previous identification exercise as

$$G(q^{-1}) = \frac{.0168q^{-2}}{1 - 1.2429q^{-1} + .2539q^{-2}}$$

The process delay is 2 sample intervals. There is one source of measured disturbance in the form of water flow into tank 1 from a different source as shown in Figure 2.9. There is no feedforward compensation applied to this disturbance. The setpoint was constant throughout the experiment. The main aim of this exercise is to determine how the existing feedback controller is performing with respect to the minimum variance benchmark. In addition we want to determine the contribution to the output variance from the measured and unmeasured disturbances.

The first step involved in performance assessment is to condition the data. This involves removing outliers from the data set and zero-mean centering the data. Figure 2.10 shows the water level in tank 1 (process output), stem position of the valve (controller output) and the disturbance (water flow rate). Both the output and the disturbance have been zero-mean centered. The next step would be to determine if the disturbance has any effect on the output error. Figure 2.11 shows the cross-correlation between the output error and pre-whitened disturbance and we note that the disturbance has a significant effect on the output error. Since the disturbance has

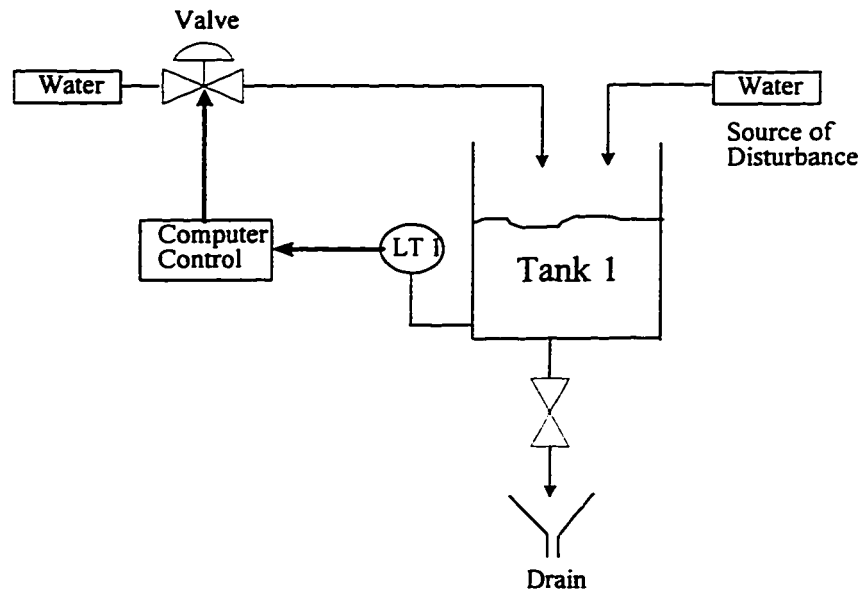

Figure 2.9: Schematic of single tank pilot scale process

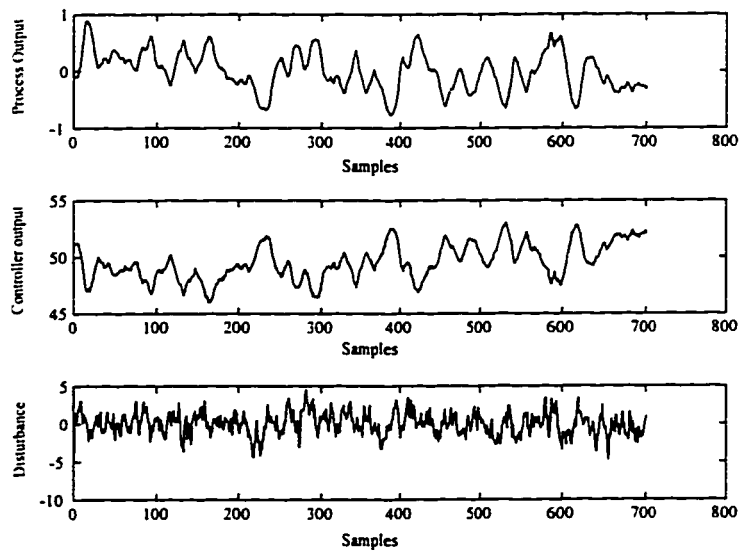

Figure 2.10: Single tank pilot scale process: Process output (Water level in tank 1); Controller output and Measured disturbance

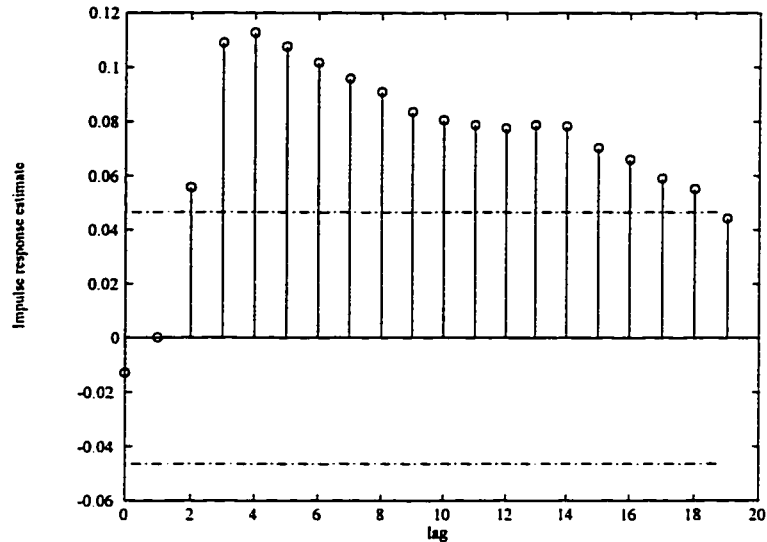

Figure 2.11: *Cross-correlation between the measured disturbance and process output (water level in tank 1)*

been pre-whitened the cross-correlation plot also gives an indication of the delay of the feedforward path which is equal to four in this case.

Having determined that the measured disturbance has a significant effect on the output, the next task would be to perform an analysis of variance on the output error. A regression model of the form given in equation (2.10) was fit to the output error. Figure 2.12 shows the residuals obtained from this model. The measured disturbance was replaced by a time series model. This is done so that the inputs to the measured (b_t) and unmeasured disturbances (a_t) are independent of each other. Figure 2.13 shows the cross correlation between the inputs to measured (b_t) and unmeasured disturbances (a_t) and we can conclude that the input moves are independent of each other. Using this regression model, an analysis of variance was performed on the output as explained in the previous sub-section. Table 2.2 shows the analysis of variance results.

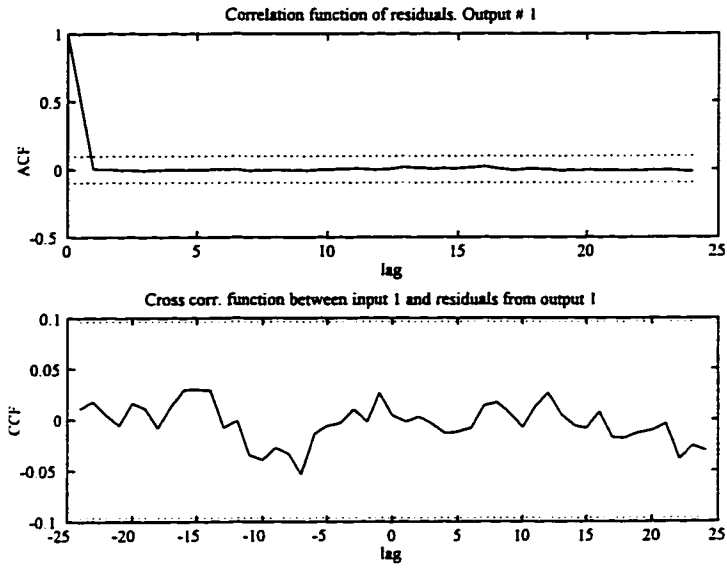

Figure 2.12: *Residual test for the regression model fitted to the process output*

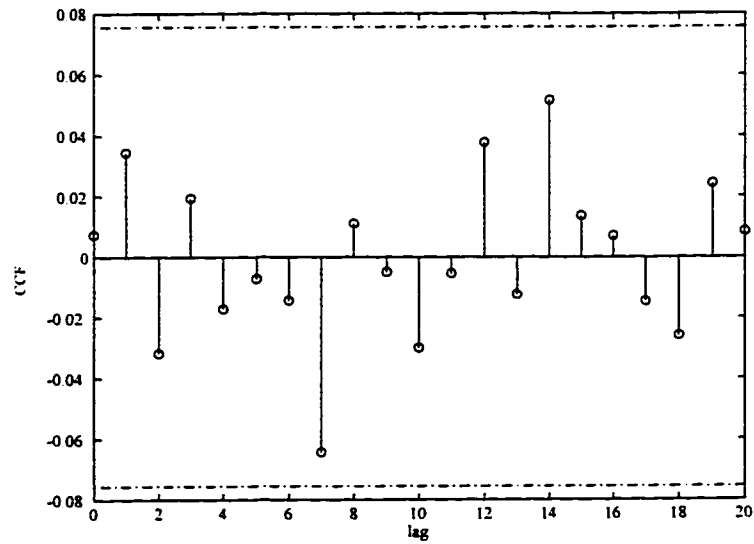

Figure 2.13: *Cross-correlation between the driving forces for unmeasured disturbance (a_t) and measured disturbance (b_t)*

Table 2.2: Analysis of variance (single tank pilot-scale process)

	MV FB/FF	Non opt.FB	Non opt.FF	Non opt.FB/FF	Total
a_t	.0014	.0238	-	-	.0252
$b_{t,1}$	0	-	.0131	.0638	.7069
Total	.0014	.0238	.0131	.0638	.1021

The actual output variance is .1100. The total output variance from analysis of variance is .1021. This difference may be due to estimation errors during regression analysis. The contribution from unmeasured disturbances is $.0252/.1100 = 23\%$. The potential reduction by retuning the feedback controller is $.0238/.1100 = 22\%$. The contribution to the output variance due to the measured disturbance is $.0769/.1100 = 70\%$. The feedforward delay is 4 and the process delay is 2. Since the feedforward delay is greater than the process delay, the minimum variance feedforward portion will be zero i.e. theoretically a minimum variance feedforward controller can eliminate the contribution from this disturbance totally. Therefore by implementing a feedforward controller the potential reduction in variance is equal to $.0769/.1100 = 70\%$.

2.4 Conclusion

Feedback and feedforward control loop performance assessment has been demonstrated via experimental and simulation studies for single input and single output systems. A minimum variance benchmark represents the absolute lower bound that can be achieved using feedback control strategy. Performance indices based on the minimum variance benchmark can be obtained by routine closed loop data and a prior knowledge of the time delay of the process. The analysis of variance is very useful in determining the incentive for implementing feedforward control on measured disturbances as shown in the experimental study.

Chapter 3

Spectral Techniques in Performance Assessment

3.1 Introduction

It is a well known fact that there is a mathematical equivalence between all the time domain expressions in time series analysis and the same expressions in the frequency domain. Even though they are mathematically equivalent, one can sometimes obtain unique and different insight and information through spectral analysis of time series data. The most common benchmark used in performance assessment is the minimum variance benchmark (Harris, 1989). One can obtain the minimum variance output from routine closed loop data and a knowledge of the delay of the process. By comparing the autocorrelation of this minimum variance output with the autocorrelation of the actual output, one can determine how close the existing controller is to minimum variance condition. The same idea can be extended to the frequency domain where the minimum variance spectrum is compared with the spectrum of the actual output. It has been shown (Desborough and Harris, 1992) that this could give an indication of the frequency range where the output deviates from the minimum variance condition

and if a controller is under-tuned or over-tuned. The minimum variance condition is not always a good benchmark since this may not always be desirable due to the fact that a minimum variance controller usually demands excessive control action and may have poor robustness properties. Instead one can specify some desired closed loop dynamics and compare the actual output spectrum with this desired closed loop spectrum. This analysis can then be used to appropriately tune the existing controller. Another area where spectral analysis is very useful is in the detection of adverse oscillations in the closed loop output. These cycles in the output may be due to several reasons. They include poor controller tuning (i.e. usually over-tuned gains), cyclical disturbances or actuator related problems such as valve hysteresis or stiction. Bialkowski *et al.* (1996) have reported that a significant amount of process variance occurs due to actuator related and/or maintenance problems. It is essential during performance assessment to separate these problems and take corrective action accordingly.

This chapter is organized as follows. Estimation of the spectrum via the discrete Fourier transform is discussed in section 3.2. Controller tuning problem and the use of spectral techniques to solve this problem are discussed in section 3.3. Experimental results are presented to illustrate some of the above techniques in section 3.4.

3.2 Signal processing in frequency domain

3.2.1 Discrete Fourier transform

The first step in spectral analysis is to effectively transform the time domain data into the frequency domain. In a typical chemical process, the data one deals with is usually discrete in nature. The discrete Fourier transform converts the discrete time domain data into frequency domain data. Consider time domain data given by y_t , $t = 1, 2, \dots, N$ where N is the total number of data points. The discrete Fourier

transform of this data is given by the expression

$$Y(\omega) = \frac{1}{\sqrt{N}} \sum_{t=1}^N y_t e^{-i\omega t} \quad (3.1)$$

These values are obtained at frequencies $\omega = 2\pi k/N$, $k = 1, \dots, N$. The original series y_t can be recovered by the inverse Fourier transform given by

$$y_t = \frac{1}{\sqrt{N}} \sum_{k=1}^N Y\left(\frac{2\pi k}{N}\right) e^{i2\pi kt/N} \quad (3.2)$$

From the above relations we can conclude that

$$Y(\omega + 2\pi) = Y(\omega) \quad (3.3)$$

Therefore, the function $Y(\omega)$ is uniquely defined in the interval by its values in the interval $[0, \pi]$ (Ljung, 1987). The function $Y(\omega)$ is usually defined in the interval $-\pi \leq \omega \leq \pi$. Therefore equation(3.2) is modified to

$$y_t = \frac{1}{\sqrt{N}} \sum_{k=-N/2+1}^{N/2} Y\left(\frac{2\pi k}{N}\right) e^{i2\pi kt/N} \quad (3.4)$$

The quantity $|Y(\omega)|^2$ represents the contribution of this frequency to the total energy of the signal y_t . This value is also known as the periodogram of the signal y_t . Parseval's theorem (Ljung, 1987) can be used to get a relation between the time domain signal y_t and the periodogram $Y(\omega)$.

$$\sum_{k=1}^N \left| Y\left(\frac{2\pi k}{N}\right) \right|^2 = \sum_{t=1}^N y^2(t) \quad (3.5)$$

3.2.2 Power spectrum

The autocovariance function of the signal y_t at lag τ is given by

$$\gamma(\tau) = E[(y_t - \mu)(y_{t+\tau} - \mu)] \quad (3.6)$$

where μ is the mean of the signal. Since we usually have a finite data set, we can only obtain sample mean and therefore the sample autocovariance function given by

$$\hat{\gamma}(\tau) = E[(y_t - \bar{y})(y_{t+\tau} - \bar{y})] \quad (3.7)$$

where \bar{y} is the sample mean of y_t . We can then define the power spectrum of y_t as

$$\Phi_y(\omega) = \sum_{\tau=-\infty}^{\infty} \gamma_y(\tau) e^{-i\omega\tau} \quad (3.8)$$

Since one can obtain only the sample autocovariance, one can only estimate the sample spectrum denoted as

$$\hat{\Phi}_y(\omega) = \sum_{\tau=-\infty}^{\infty} \hat{\gamma}_y(\tau) e^{-i\omega\tau}$$

Also from the inverse Fourier transform one can obtain

$$\gamma_y(\tau) = \frac{1}{2\pi} \int_{-\pi}^{\pi} \Phi_y(\omega) e^{i\omega\tau} d\omega \quad (3.9)$$

Sample spectrums are also known as periodograms. These periodograms can be estimated via the discrete Fourier transform described earlier. The periodogram is usually estimated by fast Fourier transform (FFT) algorithm as shown (*eg.* in Matlab the command 'fft' will transform the time series data into the frequency domain):

$$Y(\omega) = FFT(y_t) \quad (3.10)$$

then

$$\hat{\Phi}_y(\omega) = \frac{1}{N} Y(\omega) Y^*(\omega) \quad (3.11)$$

where $Y^*(\omega)$ is the complex conjugate transpose of $Y(\omega)$.

3.2.3 Frequency response of a transfer function

Assume that the signal y_t is related to u_t by a stable linear transfer function of the form:

$$y_t = G_y(q^{-1})u_t \quad (3.12)$$

In the frequency domain this translates into (Ljung, 1987):

$$Y(\omega) = G_y(\omega)U(\omega) \text{ or } G_y(\omega) = \frac{Y(\omega)}{U(\omega)} \quad (3.13)$$

Where $U(\omega)$ is the periodogram of the input signal u_t . A similar expression can be obtained in terms of the complex conjugate transpose of $Y(\omega)$ and $U(\omega)$ as

$$Y^*(\omega) = G_y^*(\omega)U^*(\omega) \text{ or } G_y^*(\omega) = \frac{Y^*(\omega)}{U^*(\omega)} \quad (3.14)$$

Combining equation (3.13) with equation (3.14) gives:

$$G_y(\omega)G_y^*(\omega) = \frac{Y(\omega)Y^*(\omega)}{U(\omega)U^*(\omega)} \quad (3.15)$$

Using equation (3.11) the above equation can be reduced to:

$$|G_y(\omega)|^2 = \frac{\Phi_y(\omega)}{\Phi_u(\omega)} \quad (3.16)$$

In particular, let the input u_t be a white noise sequence a_t with mean zero and constant variance σ_a^2 . The spectrum of white noise is constant and is proportional to σ_a^2 (this is because the spectrum is a function of the autocorrelation function and for a white noise sequence the autocorrelation function is zero for all lags except at lag zero where it is equal to σ_a^2). The spectrum of the output y_t can therefore be expressed as:

$$\Phi_y(\omega) = |G_y(\omega)|^2 \sigma_a^2 \quad (3.17)$$

$G_y(q^{-1})$ can represent a time series model such as a Moving Average model (MA) or in general an Auto Regressive Moving Average model (ARMA). A general stationary ARMA(p, q) model can be represented by:

$$\phi_p(q^{-1})y_t = \theta_q(q^{-1})a_t$$

This discrete transfer function can also be represented as an infinite order moving average model of the form

$$y_t = \sum_{j=0}^{\infty} \psi_j a_{t-j} = \psi(q^{-1})a_t = G_y(q^{-1})a_t$$

with

$$\psi(q^{-1}) = \frac{\theta_q(q^{-1})}{\phi_p(q^{-1})}$$

Control loop performance assessment is carried out by collecting routine operating data. This routine closed loop data can be conveniently represented as a time series model. Therefore the above analysis allows one to estimate the spectrum of the closed loop output when it is represented as a time series model.

3.3 Controller tuning

3.3.1 Introduction

The closed loop output y_t can be represented as an infinite order moving average series given by:

$$y_t = [1 + \psi_1 q^{-1} + \dots + \psi_{d-1} q^{-(d-1)} + \dots] a_t = G_y(q^{-1}) a_t$$

If one knows the time delay 'd' of the process, then the minimum variance output corresponding to the feedback invariant part consists of the first 'd - 1' terms of the above expression. So the minimum variance output can be written as:

$$y_{t,mv} = [1 + \psi_1 q^{-1} + \dots + \psi_{d-1} q^{-(d-1)}] a_t = G_{mv}(q^{-1}) a_t$$

The spectra of the above moving average models can be represented as

$$\Phi_y(\omega) = |G_y(\omega)|^2 \sigma_a^2 \quad (3.18)$$

$$\Phi_{mv}(\omega) = |G_{mv}(\omega)|^2 \sigma_a^2 \quad (3.19)$$

Using equation (3.9) and setting $\tau = 0$ one can obtain the variance of the output as

$$\sigma_y^2 = \frac{1}{2\pi} \int_{-\pi}^{\pi} \Phi_y(\omega) d\omega \quad (3.20)$$

The above expression also represents the area under the spectral plot. In other words the integrated power spectrum of a signal over the frequency range $[-\pi, \pi]$ is equal to the variance of the signal. This is a very useful relation because one can obtain the distribution of the output variance at various frequencies. Minimum variance output represents the absolute lower bound beyond which one cannot reduce the output variance, i.e.

$$\sigma_{mv}^2 \leq \sigma_y^2 \text{ or } (\sigma_{mv}^2 - \sigma_y^2) \leq 0 \quad (3.21)$$

The above inequality represents the difference between the minimum output variance and the actual output variance or the difference between the areas under the spectrum of minimum variance output and the actual output. Using equation (3.20) one can translate this inequality into the frequency domain as

$$\int \underbrace{[\Phi_{mv}(\omega) - \Phi_y(\omega)]}_{\delta(\omega)} d\omega \leq 0 \quad (3.22)$$

where $\delta(\omega)$ above denotes the difference between the actual output spectrum and the minimum variance spectrum. The output spectrum can be smaller than the minimum variance spectrum at some frequencies; but the total output variance or the area under the spectrum is always smaller than the minimum output variance. This means that if the output spectrum is smaller than the minimum variance spectrum at some frequencies, then it has to be substantially greater than the minimum variance spectrum at other frequencies so that the total variance is always less than that of minimum output variance. In the context of optimal control this is known as the 'water bed' effect. This 'water bed' effect is illustrated by the following simulation example.

3.3.2 Simulation example

This simulation example deals with a process represented by:

$$G(q^{-1}) = \frac{.33q^{-4}}{1 - 0.67q^{-1}}$$

It is controlled by a Dahlin controller (Eriksson and Isaksson, 1994) given by

$$G_c^1(q^{-1}) = \frac{0.3 * [.7 - 0.47q^{-1}]}{0.28 - .1q^{-1} - .23q^{-4}}$$

The sampling interval is 1 minute. From the routine closed loop data the minimum variance spectrum was estimated. Figure 3.1 shows the spectrum of the minimum variance output and that of the actual output for the stated controller settings. The present controller setting is not close to the benchmark spectrum. Suppose the objective is to make the output spectrum match in the low frequency range. This can be achieved by employing a more aggressive controller than before.

$$G_c^2(q^{-1}) = \frac{0.8 * [.7 - 0.47q^{-1}]}{0.33 - .1q^{-1} - .23q^{-4}}$$

The output spectrum for this new controller setting is shown in Figure 3.1. Even though we were able to shift the output spectrum in the low frequency range, there is deterioration in the performance in the high frequency range. The 'water bed' effect becomes clear here. Finally a more overtuned controller than G_c^2 is employed and it is observed that the output spectrum is closer to the minimum variance spectrum. It is worth mentioning that one does not necessarily want to reach minimum variance condition because it may pose problems such as excessive input moves. This setting which is closer to the minimum variance condition can be regarded as a satisfactory controller setting.

$$G_c^3(q^{-1}) = \frac{0.5 * [.7 - 0.47q^{-1}]}{0.33 - .1q^{-1} - .23q^{-4}}$$

The above analysis using spectral domain information is very useful because it provides one with information on the frequency range where the performance of the

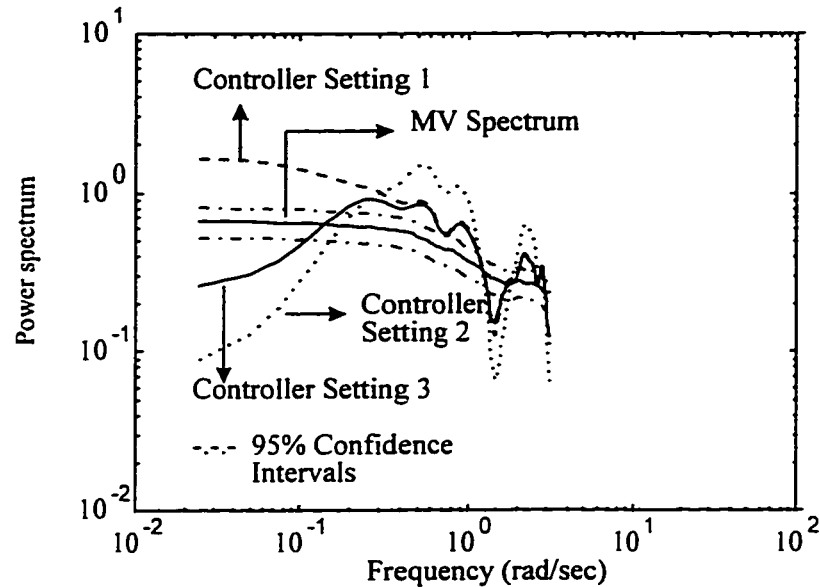

Figure 3.1: *Output spectrum for different controller settings*

controller is adequate. If one is interested in controller performance only at some specific frequency range, this analysis will give an idea of how to tune the existing controller with respect to the frequency range of interest.

3.3.3 User specified closed loop response

A minimum variance controller is not always desirable; so a minimum variance benchmark may not be a practical measure for performance assessment. Instead one can specify the desired closed loop dynamics for the process of interest. This desired dynamics can be in the form of a settling time or a time constant of the closed loop system (Kozub and Garcia, 1993). The desired dynamics may also be in terms of higher order performance objectives such as robustness or frequency domain characterization of the closed loop response. Tyler and Morari(1995) consider all the above performance objectives as constraints on the impulse response of the closed loop system and have proposed a maximum likelihood test based on these constraints. But

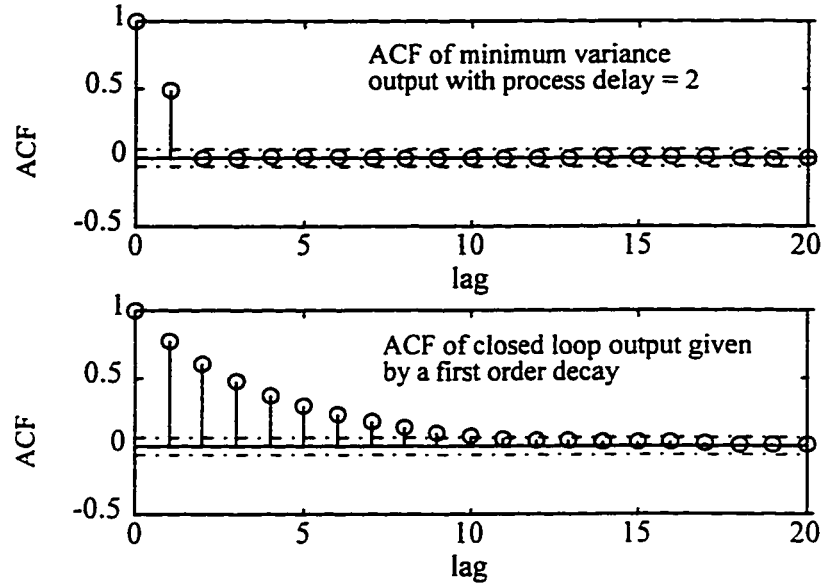

Figure 3.2: *Typical ACF for different closed loop dynamics*

one can also obtain the impulse response of the closed loop system by fitting a sufficiently high order moving average model of the form

$$y_t = [1 + \psi_1 q^{-1} + \dots + \psi_{d-1} q^{-(d-1)} + \dots] a_t \quad (3.23)$$

This ensures that the time series model provides a theoretical autocorrelation similar to the observed autocorrelation. The closed loop output under minimum variance output will consist of the first ' d ' terms in the above expression. Therefore the autocorrelation of the minimum variance output is non zero for first ' $d-1$ ' lags and zero thereafter. This kind of autocorrelation function may need aggressive control action which may not be achievable or desirable. So specifying the desired closed loop dynamics in the form of a settling time or a closed loop time constant is another way of making the autocorrelation function decay smoothly so that excessive control action is avoided. Figure 3.2 shows the autocorrelation function for different desired closed loop dynamics.

Consider the desired closed loop dynamics to be given by a settling time of k lags. This means

$$\psi_p = 0, p > k \quad (3.24)$$

Therefore

$$y_{t,des} = [1 + \psi_1 q^{-1} + \dots + \psi_{d-1} q^{-(d-1)} + \dots + \psi_k q^{-k}] a_t \quad (3.25)$$

Where a_t is estimated from residual analysis of the original time series model. The estimate for a_t depends on the disturbance transfer function. One disadvantage of specifying a desired settling time is that the output response may settle in the specified time but may have a large variance due to bad initial transients. Another approach is to specify a first order decay for the output error for any disturbance upsets. In this case the desired output is given by

$$y_{t,des} = \frac{1}{1 - \alpha q^{-1}} a_t = G_{des}(q^{-1}) \quad (3.26)$$

where a_t is a white noise sequence and α is given by

$$\alpha = \exp\left(\frac{-\Delta T}{\tau}\right) \quad (3.27)$$

One can estimate the desired spectrum for the above expressions as

$$\Phi_{des} = |G_{des}(\omega)|^2 \sigma_a^2 \quad (3.28)$$

Let $\delta(\omega) = [\Phi_{des}(\omega) - \Phi_y(\omega)]$. If the output spectrum is close to the desired spectrum, then $\delta(\omega)$ will be zero for most of the frequency values. After estimating the desired spectrum one can carry out the analysis as described above except that the difference is that one now uses the desired closed loop spectrum as the benchmark. By comparing the output spectrum with the desired spectrum, one can determine whether a controller is undertuned or overtuned relative to the desired closed loop response. If the controller tuning is not satisfactory, this procedure allows us to determine whether one has to overtune or undertune the feedback controller as illustrated by the following simulation example.

Simulation example

The process model is given by

$$G(q^{-1}) = \frac{q^{-2}(1.5 - q^{-1})}{1 - 0.8q^{-1}}$$

The process is controlled by a proportional plus integral (PI) type controller. The manipulated input dead time is 2 seconds and the sampling time is 1 second. The open loop time constant is about 4.5 seconds. The desired closed loop time constant has been set at $\tau = 3$. A settling time of 15 seconds has been specified. The first controller setting used was $K = 0.5$ and integral time constant $T_i = 1 \text{ sec}$. The output spectrum corresponding to this controller setting and the minimum variance spectrum is shown in Figure 3.3. The next step would be to tune this controller setting so that one shifts the output spectrum closer to the minimum variance spectrum. The performance of the controller in the low frequency range can be improved by increasing the integral action. To demonstrate the effect of integral action on the output spectrum three controller settings with different integral time constants have been used. As seen in Figure 3.3 as the integral time constant is reduced from $T_i = 1 \text{ sec}$ to $T_i = .33 \text{ sec}$ (which amounts to increasing integral action), the output spectrum shifts downwards in the low frequency range. For the controller setting with $T_i = .16 \text{ sec}$, the output spectrum shifts below the minimum variance spectrum in the low frequency range but is above the minimum variance spectrum in the mid-frequency range. This gives rise to oscillations in the closed loop output.

Next the effect of increasing the proportional gain was investigated. The initial proportional gain which was $K = .05$ was increased to $K = .35$. We expect the change in the proportional gain to have an overall effect on the output spectrum at all frequencies. From Figure 3.4 one can see that by increasing the proportional gain the output spectrum shifts towards the benchmark spectrum in the low frequency range but results in some high frequency oscillations. This is the result of the 'water bed' effect discussed previously. Performance in the low frequency range is improved

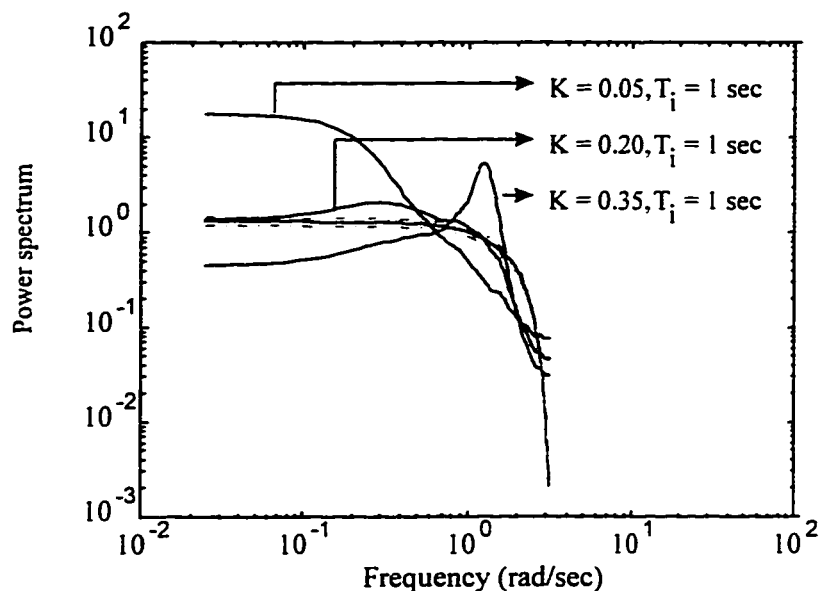

Figure 3.3: Output spectrum for different values of integral time constant (T_i)

but there is deterioration of the performance in the high frequency range. Finally the proportional gain was decreased from $K = 0.35$ to $K = 0.20$. This makes the output spectrum match the minimum variance spectrum over most of the frequency range.

To illustrate the use of this technique in controller tuning the process was simulated and 5000 data points were obtained at controller settings of $K = .10$ and $T_i = 1$ sec. The performance index defined by the minimum variance benchmark was obtained via regression analysis for a batches of 500 data points. The performance index is shown in Figure 3.5. It can be observed that the controller is not operating at minimum variance condition. So the first option is to re-tune the feedback controller. Then the question arises which way should the controller be re-tuned, i.e. should it be de-tuned or over-tuned? A comparison of the actual spectrum and the minimum variance spectrum as illustrated above can be used to determine whether to de-tune or over-tune the controller. Figure 3.6 shows the actual spectrum with that of the minimum variance spectrum for the controller setting $K = 0.11, T_i = 1$ sec. From

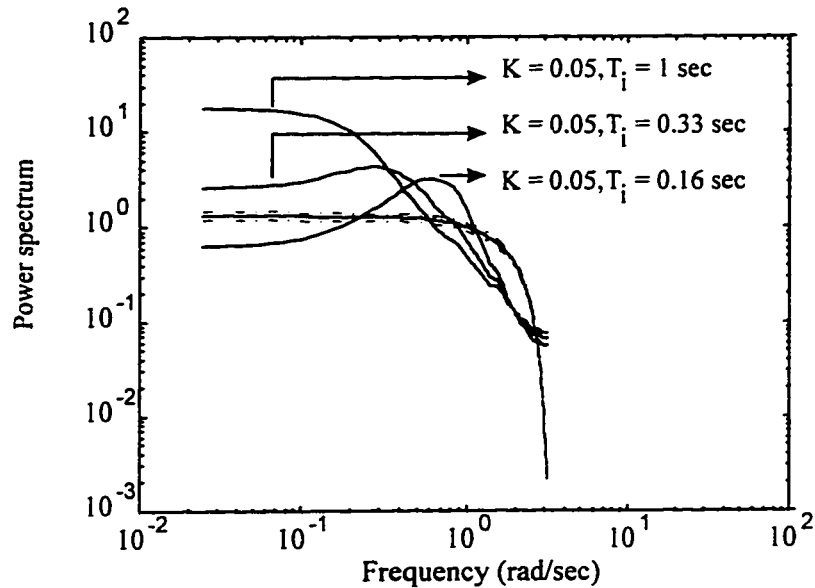

Figure 3.4: *Output spectrum for different values of proportional gain (K)*

the above analysis one can conclude that the controller should be overtuned. So the controller gain is increased to $K = .20$. From Figure 3.5 it can be seen that the performance index is closer to 1 showing that the controller is close to the minimum variance condition. If in the absence of the above analysis one detunes the controller to $K = .05$, the performance of the controller actually deteriorates. So a knowledge of how the controller should be tuned is very valuable.

The above analysis is based on comparing the output spectrum with minimum variance spectrum. Instead one can specify some desired closed loop dynamics. A first order decay to the closed loop output of the form given in equation (3.26) is specified. Since the desired closed loop time constant has been set at $\tau = 3$. This translates to $\alpha = .7887$ according to equation (3.27). Figure 3.7 shows the desired spectrum with upper and lower bounds. The desired spectrum was obtained by assuming a first order decay for the closed loop data as given in equation (3.26). The first controller setting used was $K = .05$. The output spectrum for this controller setting is shown in

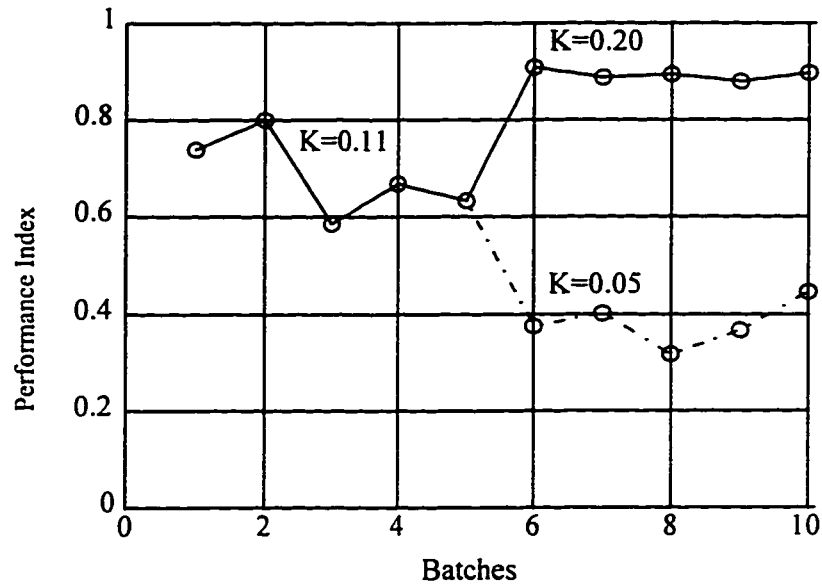

Figure 3.5: Performance Index for a moving window of 500 data points

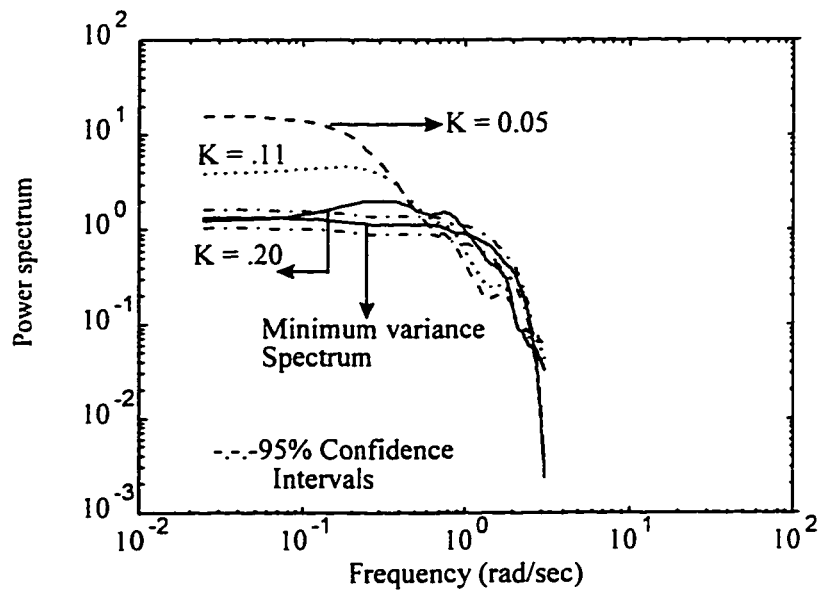

Figure 3.6: Output spectrum for different controller settings

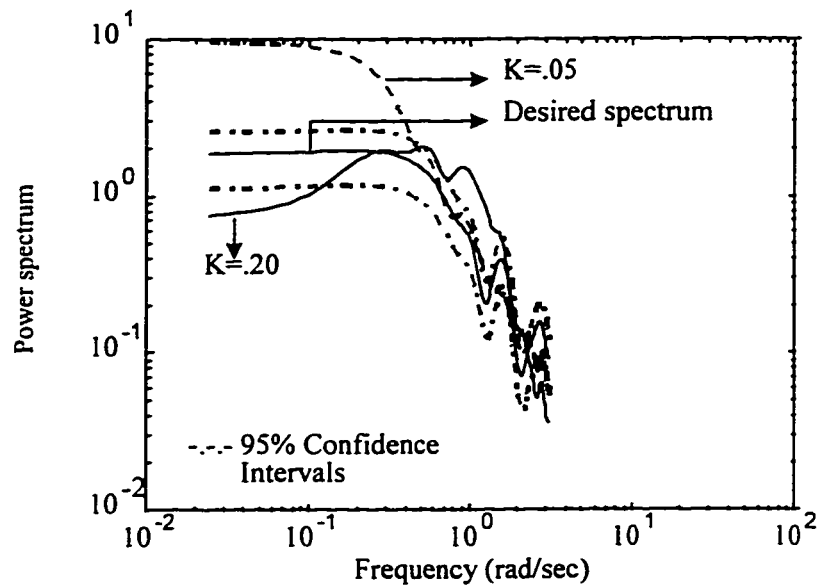

Figure 3.7: *Actual output spectrum versus spectrum of desired closed-loop dynamics*

Figure 3.7. One can see that the controller seems to be slightly undertuned. Therefore the proportional gain has been increased to $K = .20$. The output spectrum for this controller setting is better than the desired spectrum in the low frequency range and is satisfactory at other frequency ranges.

3.4 Experimental results

3.4.1 Single tank pilot-scale process

The use of spectral techniques in the analysis of controller tuning is illustrated on a computer-interfaced pilot scale process shown in Figure 3.8 (see Appendix B for experimental details). The objective in this experiment is to control the water level in tank 1 by manipulating the stem position of the valve. An internal model controller was implemented with sampling time of 5 sec using *LabVIEW/Matlab* with *Dynamic Data Exchange (DDE)* between these two platforms.

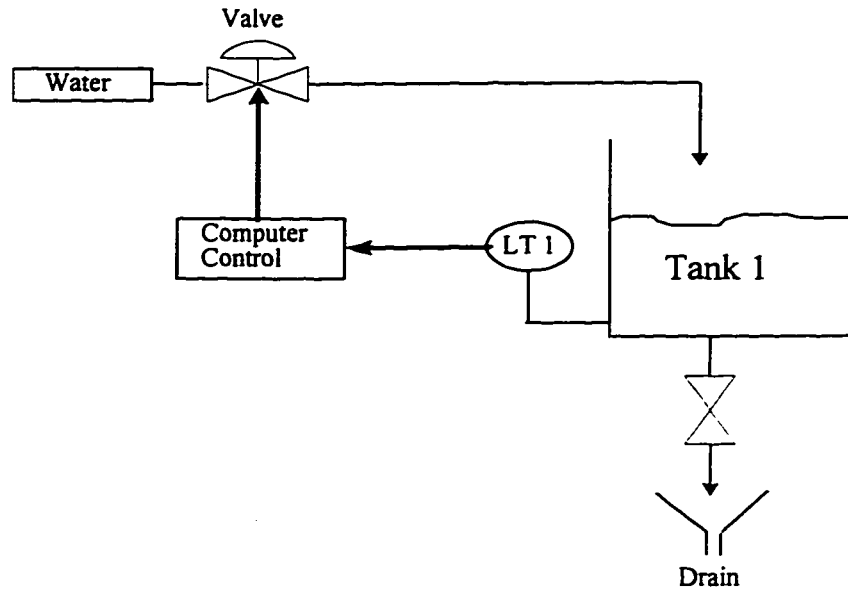

Figure 3.8: *Schematic diagram of the single tank computer-interfaced pilot-scale process*

Since IMC is a model-based controller an open loop identification test was carried out on the process. Figure 3.9 shows the input excitation provided for identifying the process. A pseudo random binary signal was used to excite the process. A second order model for both process transfer function and the disturbance transfer function was chosen. The process model was identified using the prediction error method (Ljung, 1987) as

$$\hat{G}(q^{-1}) = \frac{.0168q^{-2}}{1 - 1.2429q^{-1} + .2539q^{-2}}$$

Figure 3.10 shows the measured output versus predicted output. We see that there is a good match between the predicted output and the actual output. A first order filter of the form

$$G_f(q^{-1}) = \frac{1 - \alpha}{1 - \alpha q^{-1}}$$

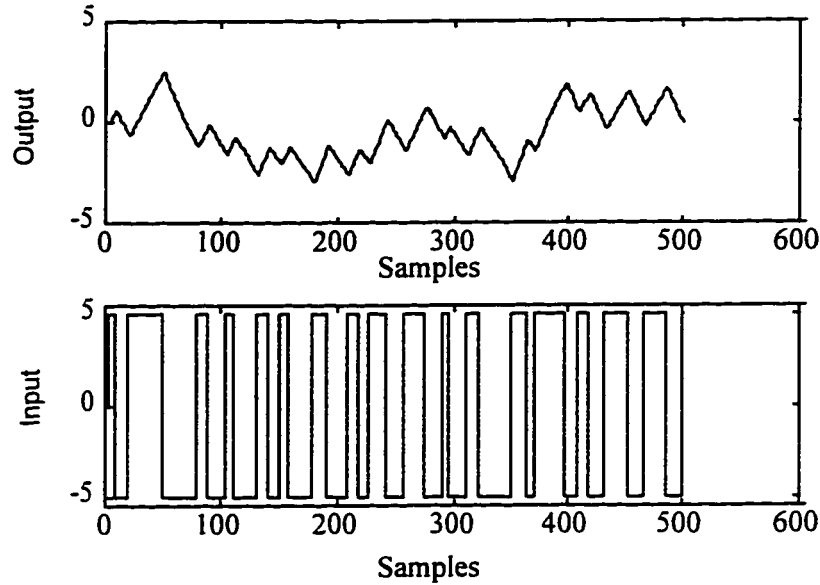

Figure 3.9: *Single tank pilot scale process: Process output (water level in tank 1) and manipulated variable (stem position of the valve)*

was chosen for the IMC controller. Since the process model has no zeros or poles outside the unit circle, the theoretical closed loop output is given by

$$G_{cl}(q^{-1}) = \frac{q^{-d}(1 - \alpha)}{1 - \alpha q^{-1}}$$

where d is the delay of the process. α can be regarded as a tuning parameter. Choosing a particular value of α is equivalent to specifying the closed loop dynamics of the process. When α equals zero we get deadbeat control and as we increase the value of α the controller becomes less aggressive.. Figure 3.11 shows the output spectrum of the process for $\alpha = 0.9$ and the minimum variance spectrum. We note that the controller setting is undertuned with respect to minimum variance spectrum. So the controller is made more aggressive by increasing the value of α to 0.40. The output spectrum for this controller setting is shown in Figure 3.11 and we observe that the spectrum shifts towards the minimum variance spectrum. The final controller setting

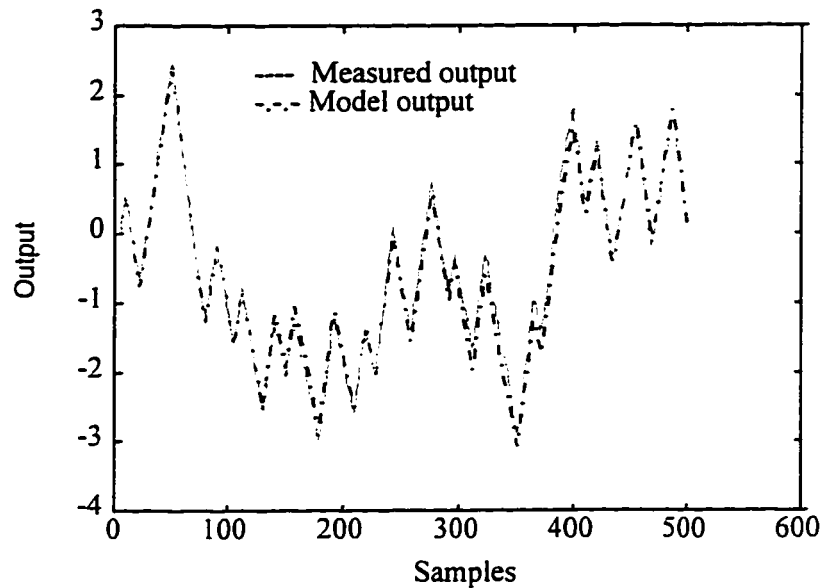

Figure 3.10: *Single tank pilot scale process: Measured output versus predicted output from the model*

used was $\alpha = 0.2$ which resulted in reduced output variance.

3.4.2 The light bulb experiment

The schematic diagram of the light bulb used for this experiment is shown in Figure 3.12. The objective is to control the temperature of the light bulb. A proportional plus derivative controller was implemented using the *Real Time Matlab/Simulink Tool-box* with a sampling time of 1 sec. Figure 3.13 shows the output response for the controller setting $K = 6$ and $K_d = 4$ where K is the proportional gain and K_d is the derivative time constant of the controller. It can be seen that this controller setting produces an oscillatory response in the output.

Figure 3.14 shows the spectrum of the output for this controller setting and the minimum variance spectrum. The oscillations observed in the closed loop output in the time domain plot are also observed in the spectral plot. For controller setting

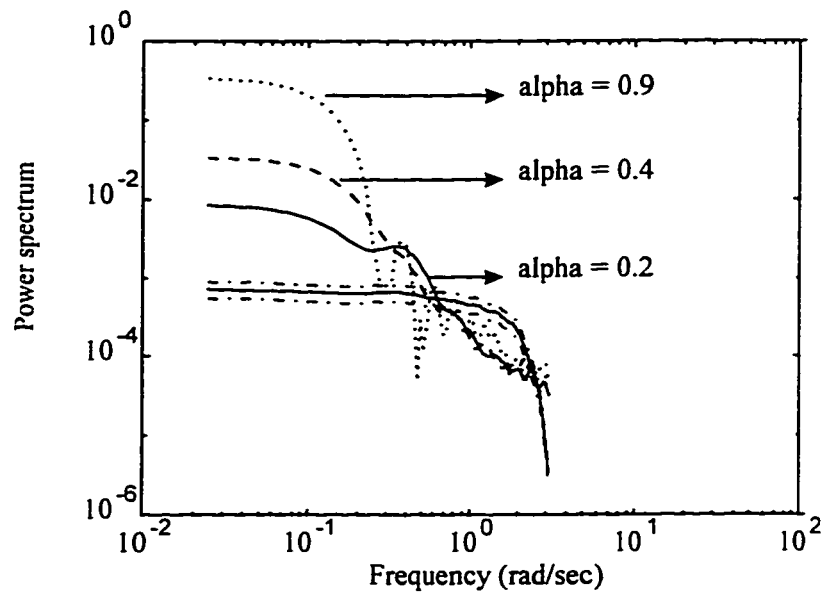

Figure 3.11: *Single tank pilot scale process: Output spectrum for different controller settings*

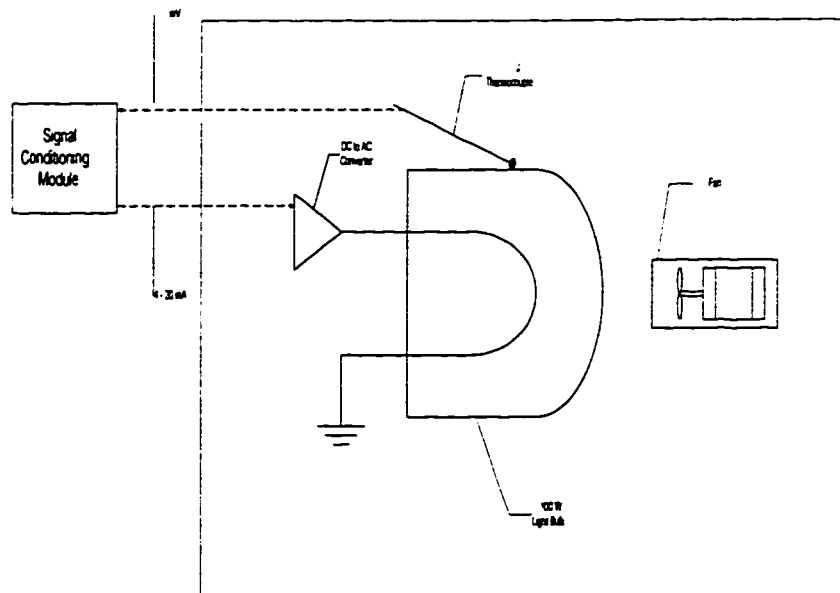

Figure 3.12: *Schematic diagram of the light bulb experiment*

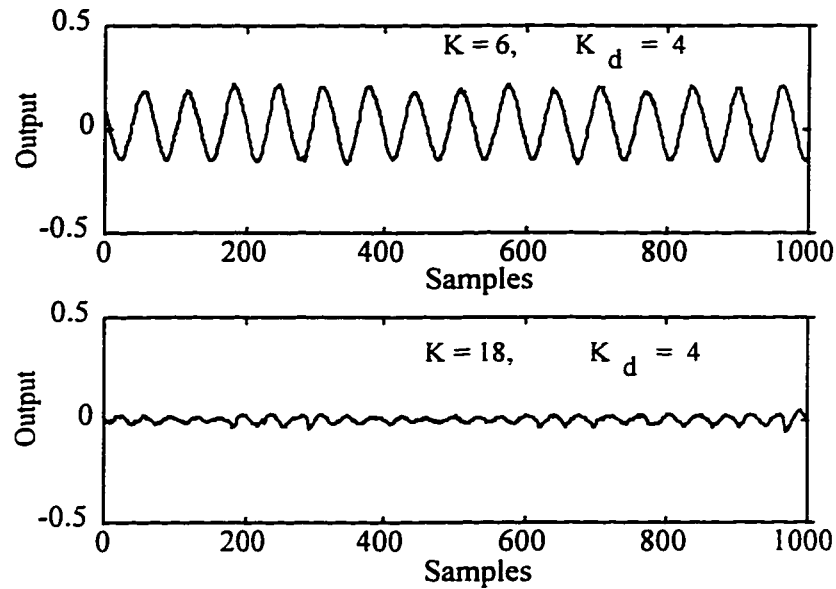

Figure 3.13: *Light bulb: Output trends for different controller settings*

$K = 6$ the spectral plot suggests that the existing controller is under-tuned. The controller gain therefore was increased to $K = 18$. The output response is shown in Figure 3.13 and the spectrum of the output is shown in Figure 3.14. We observe that the output spectrum is now closer to the minimum variance spectrum in the low frequency range but has some oscillatory trends in the mid frequency range. It should be noted that minimum variance spectrum represents the absolute lower bound and one that may not be always achievable. Therefore this controller setting can be regarded as a satisfactory controller setting if regulatory and setpoint tracking at low frequencies is the main control objective.

3.5 Conclusions

Spectral techniques are very useful in obtaining valuable information about a process from routine operating data. One of the areas where spectral analysis is very useful

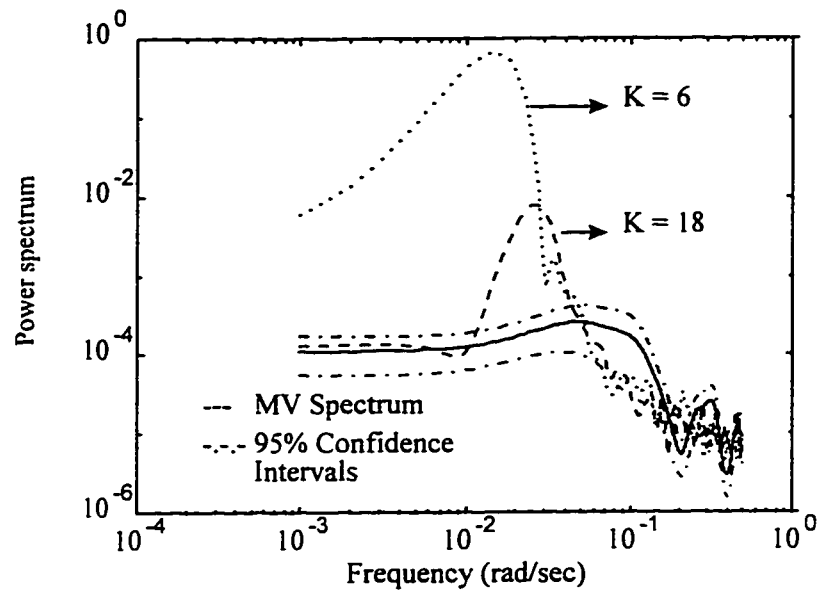

Figure 3.14: *Light bulb: Spectrum for different controller settings*

in control loop performance assessment is the controller tuning problem introduced in this chapter. By comparing the actual output spectrum to the minimum variance benchmark spectrum one can determine if a controller is over-tuned or under-tuned. The same idea can be extended if the benchmark is user-defined instead of the minimum variance benchmark.

Chapter 4

Industrial Case Studies

4.1 Introduction

Chemical process industries aim at achieving reliable and profitable automated control. Control loop performance monitoring and diagnosis plays a crucial role in achieving this objective. Routine industrial data often exhibits complicated time series patterns. This may be due to process non linearities, changing process conditions *etc.* To further complicate the matter, control engineers are often responsible for hundreds of applications, making the analysis of raw data virtually unmanageable. Kozub and Garcia (1993) address these issues and define the requirements for automated controller performance monitoring. The objective of this chapter is to apply the performance assessment techniques introduced in the previous chapters to industrial closed loop data from Shell USA (released for academic purposes) and Cominco Inc.

Performance analysis on these data sets was carried out using both time domain and frequency domain techniques. Simple cross-correlation tests were used to determine which of the measured disturbances could be used for feedforward control. After identifying the prospective feedforward variables, analysis of variance was car-

ried out for obtaining the relative contribution of various measured and unmeasured disturbances on the output variance. This analysis also provides the benefit of implementing feedforward control as discussed in chapter 2. Spectral analysis on the output and the disturbance data sets was used to detect if any unfavourable oscillations were present in the process variables. This chapter is mainly concerned with the experimental evaluation of these performance analysis tools on the Shell and Cominco industrial data sets.

4.2 Shell Industrial Case Study

The data originates from three distillation columns at Shell which shall be referred as columns 1, 2 and 3 respectively. The data was made available at a Shell ftp site¹. The objective in all three cases was to control a single tray temperature (output) at some desired set point using a single manipulated input for control. All three controllers can be assumed to be Quadratic Dynamic Matrix Controllers (QDMC) (Prett and Garcia, 1988). All controllers operate at a one minute execution rate, and all data has been collected at a sample rate of one minute. The ultimate goal is to attain 100% reliable control achieving maximum profitability with minimum cost.

4.2.1 Problems to be considered

- Shell control engineers typically aim for a certain closed loop settling time when significant upsets occur. This is a constraint on the impulse response coefficients of the closed loop transfer function. The impulse response coefficients should go to zero at time greater than the specified settling time.

¹The response data files and files containing the step response models used in the designs are available from Professor Manfred Morari at the ftp site AVALON.CALTECH.EDU in the directory CDS/MONITOR/SHELL

- Most performance assessment tools use minimum variance control as a reference benchmark. However comparing the output error trend with a minimum variance output error trend is not always practical, and one alternative is to specify a desired reference output error trend. For example, Kozub and Garcia (1993) suggest a first order exponential decay trend given by:

$$\varepsilon_t = \frac{1}{1 - \alpha q^{-1}} a_t \quad (4.1)$$

Such a response represents a first order decay for ε_t to disturbance upsets where

$$\alpha = \exp\left(-\frac{T}{\tau}\right) \quad (4.2)$$

with T equal to the sampling interval and τ equal to the desired first order response time constant. This time series model describing an acceptable closed-loop trend for ε_t can be shown to have an autocorrelation pattern given by

$$\rho_e(k) = \alpha^k \quad (4.3)$$

This could be used to determine if the trend for ε_t is acceptable. One could also use the extension by Huang and Shah (1996) where the desired closed loop dynamics are considered as the performance benchmark in a unified H_2 framework. The objectives of the ensuing analysis was

- To characterize the output error response characteristics associated with the disturbances and give a break down of the relative contribution of different disturbances to the output error, including unmeasured ones. This amounts to performing analysis of variance on the data sets
- To also assess if the controller is over-tuned or under-tuned relative to the reference benchmark.
- To obtain an indication of the quality of feedforward control compensation, if present?

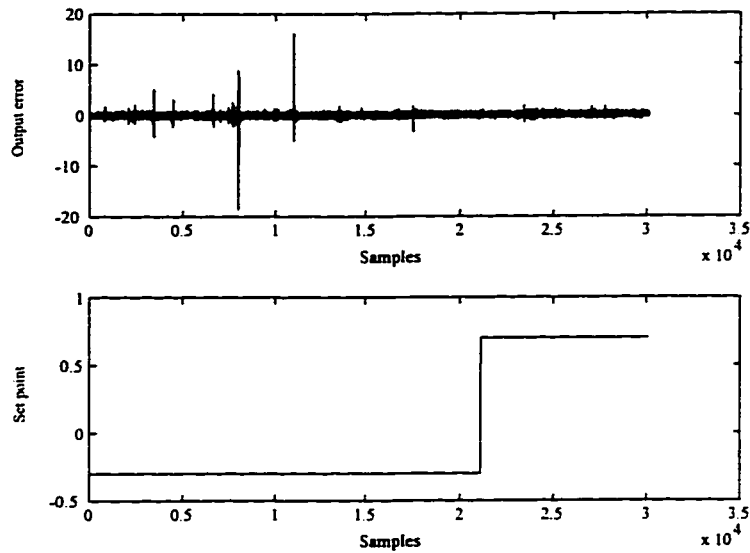

Figure 4.1: *Column 1: Output and Setpoint trends*

- To determine if the response data exhibits time variant response characteristics?

4.2.2 Column 1

Figure 4.1 shows the tray temperature (output) and the setpoint time-series data for column 1. The manipulated input in this case is the reboiler duty. Three trends for consideration as measured disturbances are provided: the column feed flow rate ($b_{t,1}$); the column feed temperature ($b_{t,2}$); and column pressure ($b_{t,3}$). These trends are shown in Figure 4.2. Feedforward compensation was applied to the measured column feed flow rate ($b_{t,3}$).

The autocorrelation function of the output error with the desired output autocorrelation function is shown in Figure 4.3. The autocorrelation plot clearly indicates that the controller is performing nowhere near minimum variance condition since there are significant lags beyond the process delay $d = 1$. The desired autocorrelation function was obtained by assuming a first order decay for output error to disturbance

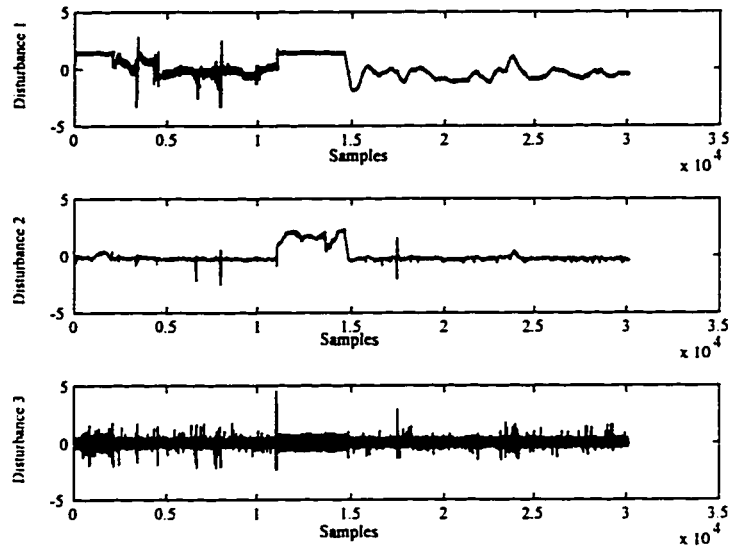

Figure 4.2: *Column 1: Disturbance trends*

upsets as given in equation (4.1). The response time was set at 5 sample intervals. The specified settling time was 15 minutes. The plot indicates that the output settles much slower than the desired settling time.

Figure 4.4 shows the performance index as defined in equation 2.2 over a period of three weeks with each point corresponding to a single day's worth of data. This performance index was obtained by lumping all the measured and unmeasured disturbances and fitting a time series model to the output error. A moving window of size 1440 was used to obtain the performance index. It is assumed that the process is time invariant for this window size. Figure 4.5 shows the performance index for the first 5000 data points with a sliding window of size 1440. The dash-dotted lines in Figure 4.5 represent the performance indices with a moving window of size 1440. So the first three indices in Figure 4.4 are identical to these points in Figure 4.5. A batch of 1440 points was used to obtain the first performance index. For every subsequent data point, the performance index was calculated with a sliding window size of 1440.

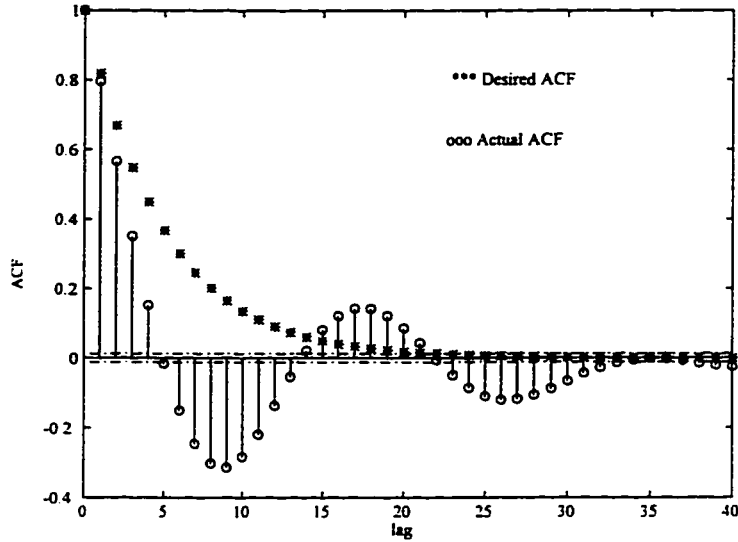

Figure 4.3: *Column 1: Output ACF vs. Desired ACF*

The size of the window is very important in capturing any cyclical behavior in the performance index such as day/night cycles *etc.* Choosing a small window size may not provide accurate statistical results and by choosing a large window size any time varying phenomena in the process are neglected. These are conflicting objectives. For this data set different window sizes were used to obtain the performance index (360, 720, 1440). A window size of 1440 was finally chosen since further reduction in the window size did not provide any additional information. The performance index plot shows that the average index is about 0.3. From the performance index we can conclude that there is a potential for improvement in the performance of the existing control system. Therefore the next step is to identify the source of the problem and ways to improve the performance of the controller.

Figure 4.6 shows the cross correlation between output error and the pre-whitened disturbances. Disturbances have been pre-whitened with an appropriate filter so that any cross correlation between the individual disturbances is removed. The plot

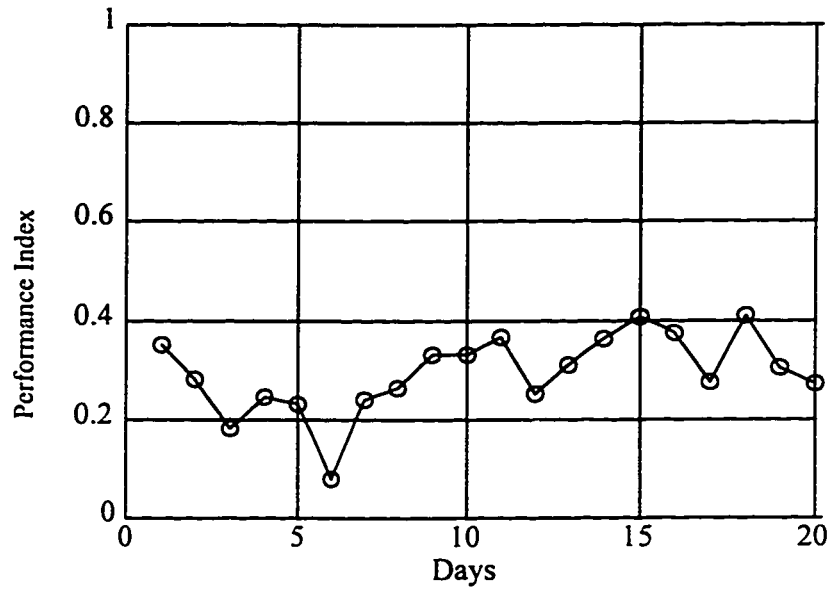

Figure 4.4: Column 1: Performance Index

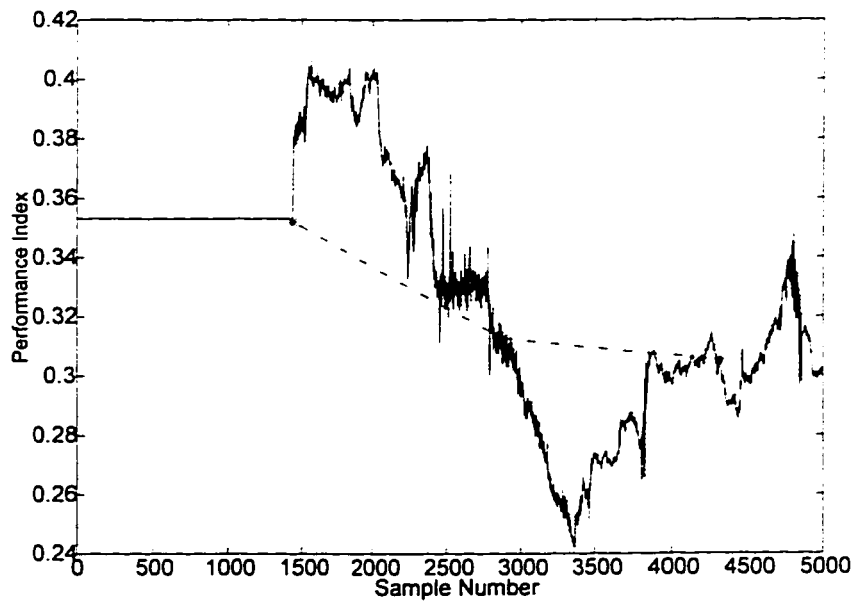

Figure 4.5: Column 1: Performance Index with a sliding window of size 1440; (--- Index with a moving window of size 1440)

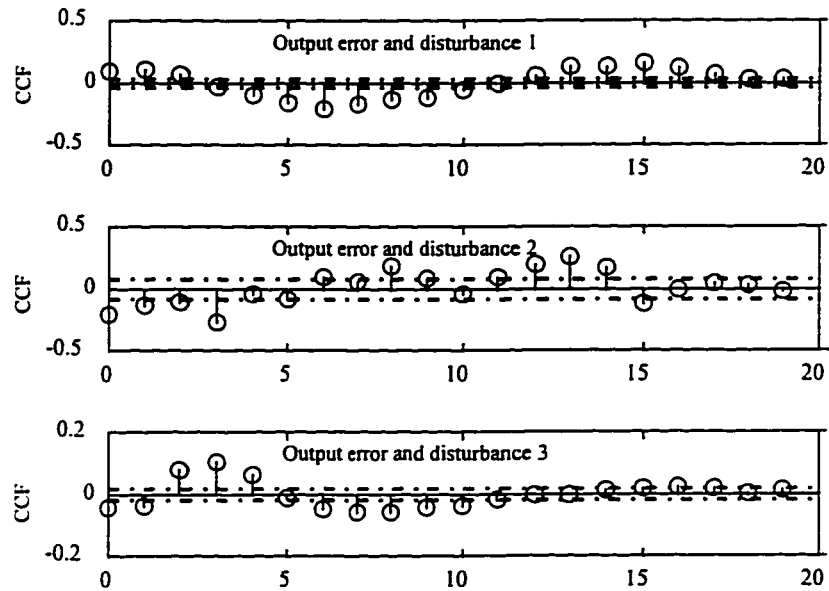

Figure 4.6: *Cross-correlation between output error and disturbances*

indicates that all the disturbances have some effect on the output error. So all the three disturbances have been taken into account for further analysis. A regression model between the output error and the disturbances as given by equation(2.8) was obtained. This can be used to perform analysis of variance on the data set.

Figure 4.7 shows the spectra of output error and different disturbances with confidence intervals. Disturbances 1 and 2 do not have any periodicities associated with them. There is some cycling in disturbance 3 which may cause oscillations in the output error. But from previous analysis it was concluded that disturbance 3 does not have a significant effect on the output error. Table 4.1 shows the results of analysis of variance that was carried out to determine the contribution of the various disturbances to the output variance. These results were obtained by analyzing the whole data set (30000 data points). The contribution from disturbance 3 is about 0.4% (.035/.1201). Unmeasured disturbances contribute 83% (.1005/.1201) to the overall variance. The potential reduction in the output variance by retuning the existing feedback controller

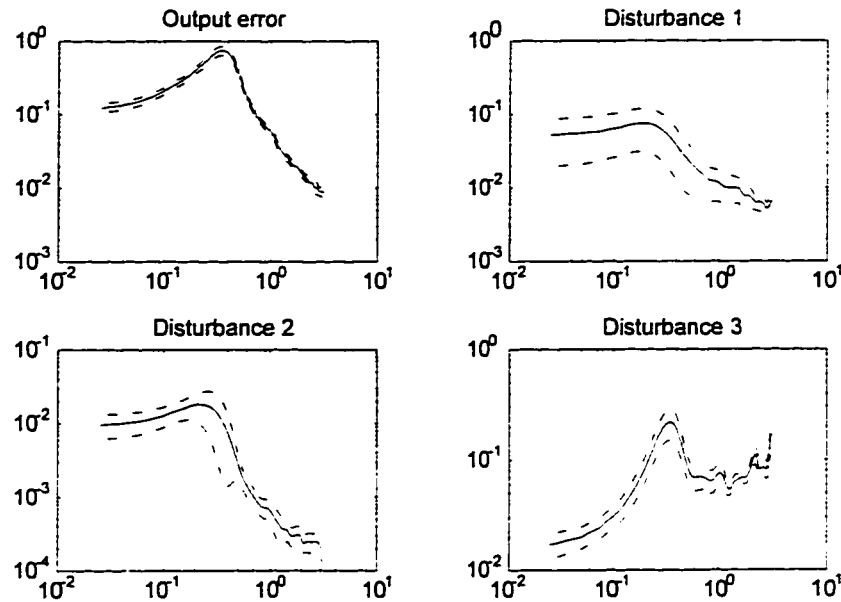

Figure 4.7: *Column 1: Spectra of output and disturbances*

is $(.0651/.1201) = 54\%$. Feedforward control on disturbance 2 and 3 is not worthwhile. If further reduction in variance is warranted, retuning the feedback controller is the best option.

Figure 4.8 shows the spectrum of output error with the desired output spectrum and the minimum variance spectrum superimposed on the same plot. Since a unit process delay was assumed, the minimum variance spectrum is nothing but a white noise spectrum. The desired spectrum was estimated assuming a first order decay of the output for disturbances given by equation (4.1). The output spectrum is better than the desired spectrum in the low frequency range but has an oscillatory trend in the mid frequency range. These oscillations make the output settle much slower than the desired rates. The same can be seen in the autocorrelation plot in Figure 4.3 where the actual output autocorrelation is smaller than the desired autocorrelation for smaller lags but oscillates at higher lags. From the analysis in chapter 3 it can be concluded that the controller is slightly over-tuned with respect to the desired output

Table 4.1: Analysis of variance on Column 1

	MV FB/FF	Non opt.FB	Non opt.FF	Non opt.FB/FF	Total
a_t	.0354	.0651	-	-	.1005
$b_{t,1}$	≈ 0	-	-	.0072	.0073
$b_{t,2}$	≈ 0	-	-	.0086	.0086
$b_{t,3}$	≈ 0	-	-	.0035	.0037
Total	.0354	.0651	-	.0193	.1201

spectrum. To avoid the mid frequency oscillations the controller can be made more conservative. Controller tuning also represents a trade off between performance and robustness of the controller. Incorporating performance and robustness objectives constitutes the next level in performance assessment. This stage of performance assessment requires more knowledge and information about the process. A more general performance measure based on LQ objective is discussed by Huang and Shah(1996).

4.2.3 Column 2

Three sets of response data have been provided for this column. A move suppression term (a tuning parameter for the QDMC controller) was specified for each of the data sets. The manipulated variable is the column reflux flow rate. Two measured disturbance variables for each of the data sets are provided: column feed flow rate ($b_{t,1}$); and column feed temperature ($b_{t,2}$). There is no feedforward compensation applied to this column. A move suppression factor of 8 was applied to data sets 1 and 2. A move suppression setting of 4 was applied to data set 3. So the main objective is to determine which of the move suppression settings yields a more effective performance with respect to the different types of disturbance and setpoint change patterns. Figure 4.9 shows the output, setpoint trend and disturbance trends for data set 1.

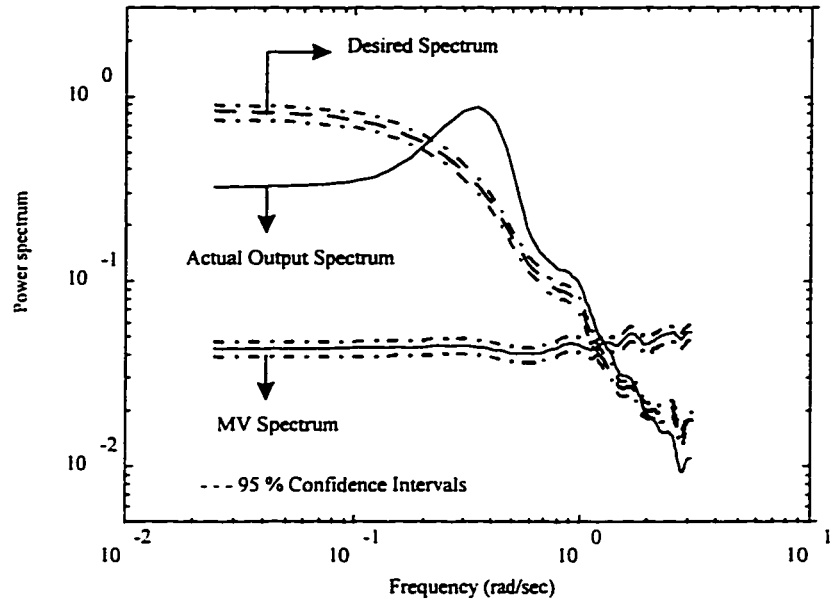

Figure 4.8: *Column 1: Spectrum of output with desired spectrum and MV spectrum*

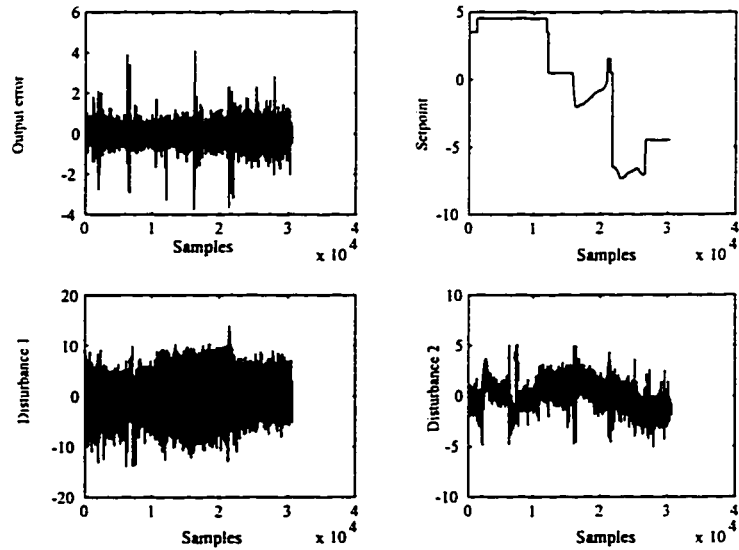

Figure 4.9: *Column 2, data set 1: Output error, set point and disturbance trends*

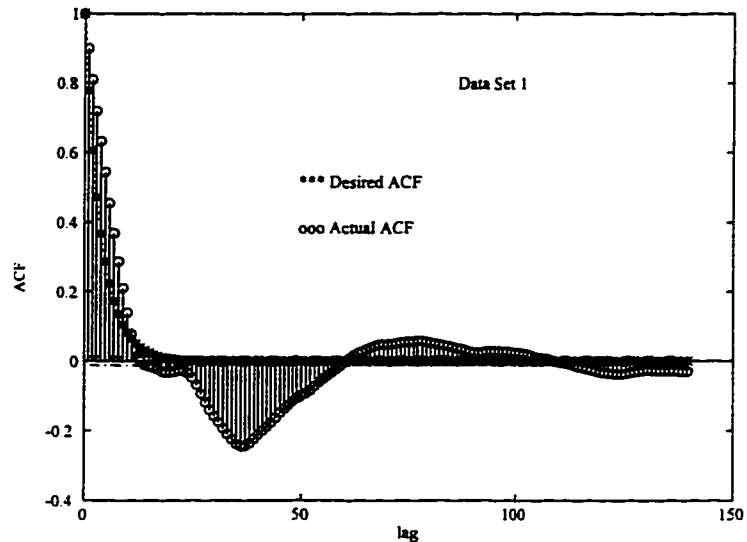

Figure 4.10: *Column 2: Actual ACF vs Desired ACF; Time constant = 4 min; Sampling time = 1 min*

Autocorrelation plots of the output error trends are compared with the desired autocorrelation in Figure 4.10 for data set 1 and for data sets 2 and 3 in Figure 4.11 for each of the data sets. The autocorrelation pattern indicates that the controller is not under minimum variance control since there are significant lags beyond the process time delay $d = 2$. The desired autocorrelation plot was obtained by assuming a first order decay for output error to disturbance upsets as given in equation (4.1). The response time was set at 4 minutes. The plot indicates that the actual autocorrelation of the output matches the specified autocorrelation for smaller time lags but has a oscillatory trend for larger time lags. The specified settling time is about 15 minutes. The output error trend for all the data sets settles much slower than the desired response. This may be due to cycling in the output error as observed in the autocorrealtion function. Figure 4.12 shows the performance index for each of the data sets with a moving window of size 1440 for each of the data sets.

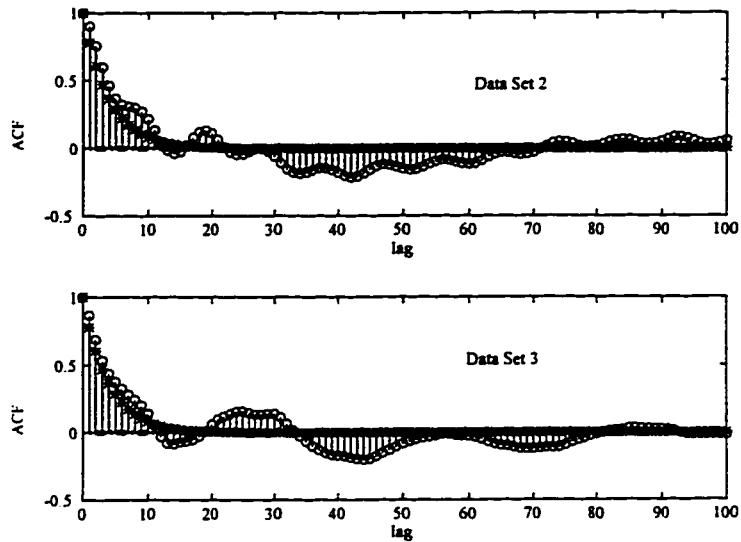

Figure 4.11: *Column 2: Actual ACF (ooo) vs Desired ACF (***)*; Time constant = 4 min, Sampling time = 1 min

Figures 4.13, 4.14 and 4.15 show the cross-correlation between the output error and the pre-whitened disturbances for data sets 1, 2 and 3. For data set 1 as can be seen from Figure 4.13, disturbance 2 appears to affect the output error more than disturbance 1. This is also confirmed by analysis of variance. In data sets 2 and 3 both disturbance 1 and 2 have significant effect on the output error.

Figures 4.16, 4.17 and 4.18 show the spectra of output error and disturbance 2 for all the data sets. The disturbance time-series data have been differenced wherever necessary. This helps in removing the non-stationarity in the data and thus obtain a better picture of any periodicities that may exist. It is interesting to note the spectral plots of differenced disturbance 2 (data set 2 and 3, Figures 4.17 and 4.18). There is a distinct cycling pattern. In Figure 4.17 the peaks in the spectra of output error and disturbance 2 occur at the same frequency suggesting that the cycling in the output error response is caused by disturbance 2. This certainly has an impact on

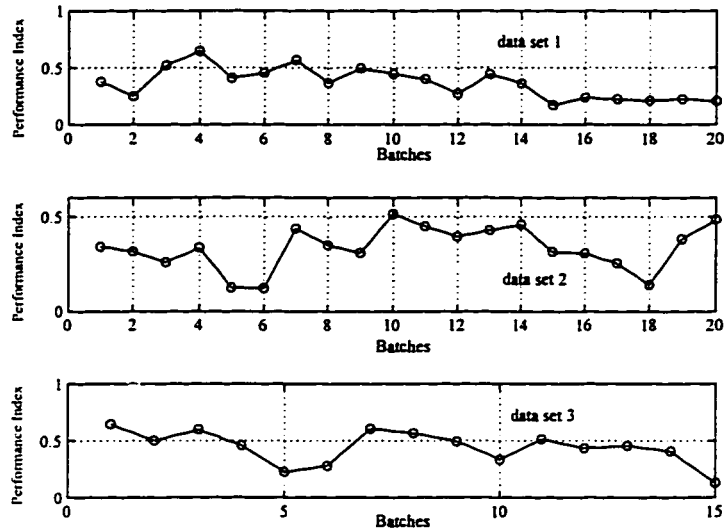

Figure 4.12: Column 2: Performance Index for data sets 1, 2 and 3 with a moving window of size 1440

the output error response and therefore one should expect some contribution to the overall output variance from this disturbance. This can be seen in the analysis of variance table for data set 2 where the contribution to the overall output variance is around 40%. The cause of this is clearly due to the nature of the disturbance itself. In contrast, disturbance 2 (data set 1) does not show any periodicity and contributes very little to the overall output error. Data set 1 has the least contribution to the output variance from measured disturbances. From the spectral plots, it appears that the disturbance trends are very different from one another. Because of the difference in the disturbance dynamics in each of the data sets, one cannot conclude clearly that the first move suppression setting is the best. But it can be concluded that the existing move suppression settings in data set 2 and 3 are not doing a good job of rejecting the measured disturbances. The move suppression setting applied to data set 1 has good performance with respect to setpoint and disturbance changes occurring at that

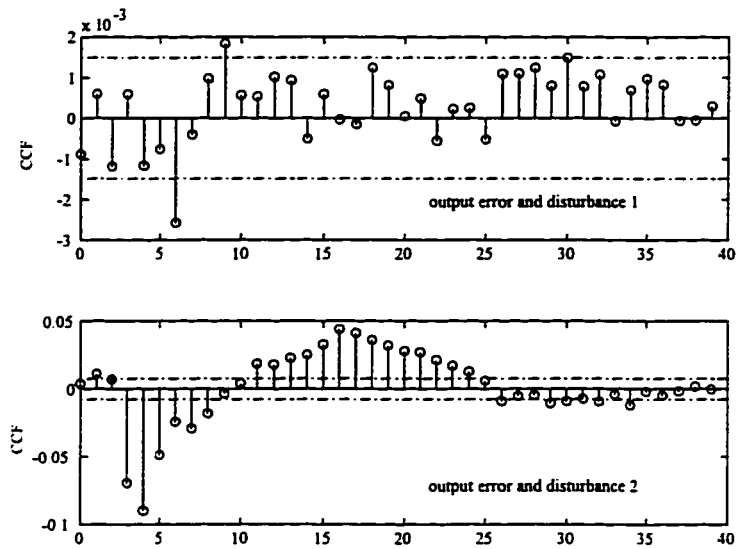

Figure 4.13: *Column 2, data set 1: Cross-correlation between output and disturbances 1 and 2*

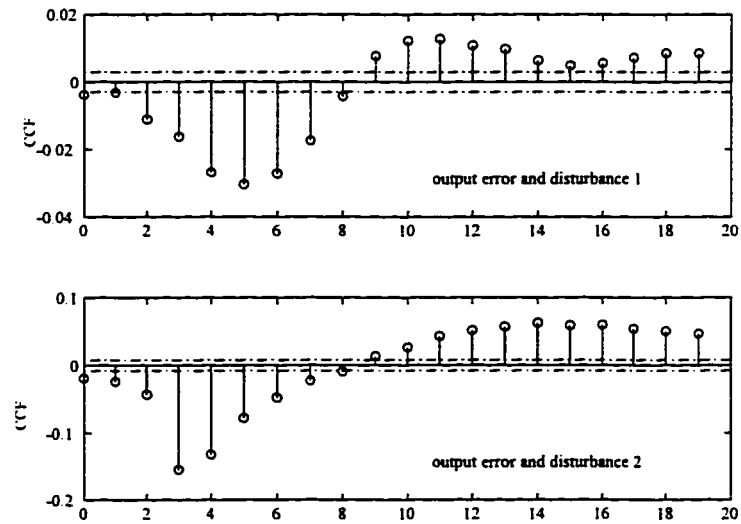

Figure 4.14: *Column 2, data set 2: Cross-correlation between output and disturbances 1 and 2*

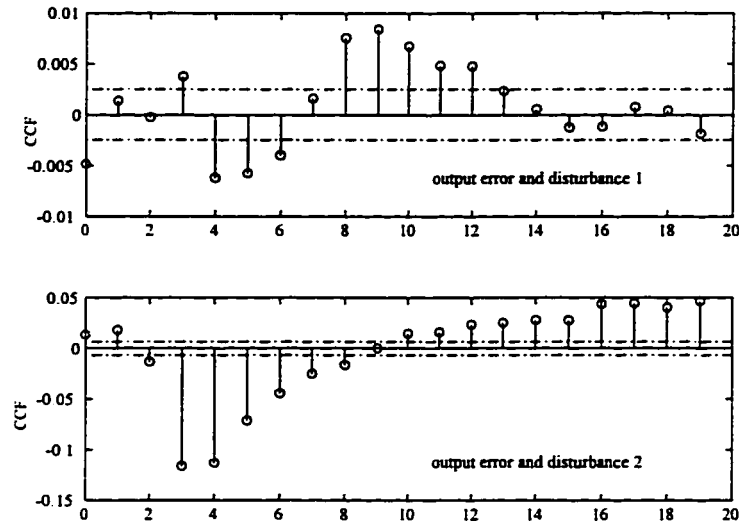

Figure 4.15: *Column 2, data set 3: Cross-correlation between output and disturbances 1 and 2*

time. Analysis of variance for each of the data sets is provided in Tables 4.2, 4.3 and 4.4 respectively. Since there are significant setpoint ($b_{t,3}$) changes, these setpoint changes were treated as measured disturbances to evaluate their contribution to the overall output variance.

Consider data set 1. The output error variance from analysis of variance is .2205 which differs from the actual output error variance which is .2239. This could be due to errors in estimation of the fitted regression model between the output error and the measured disturbances. The contribution from disturbance 1 and set point changes is 2% and 5% respectively. The contribution from unmeasured disturbances to the overall output variance is .1492 (66%) and the minimum variance contribution from the unmeasured disturbances is .0564. By retuning the FB controller the maximum reduction in the variance is $(.0928)/.2205 = 42\%$. The contribution from disturbance 2 is .0547 (24%). The contribution due to the non optimality of the FB/FF controller

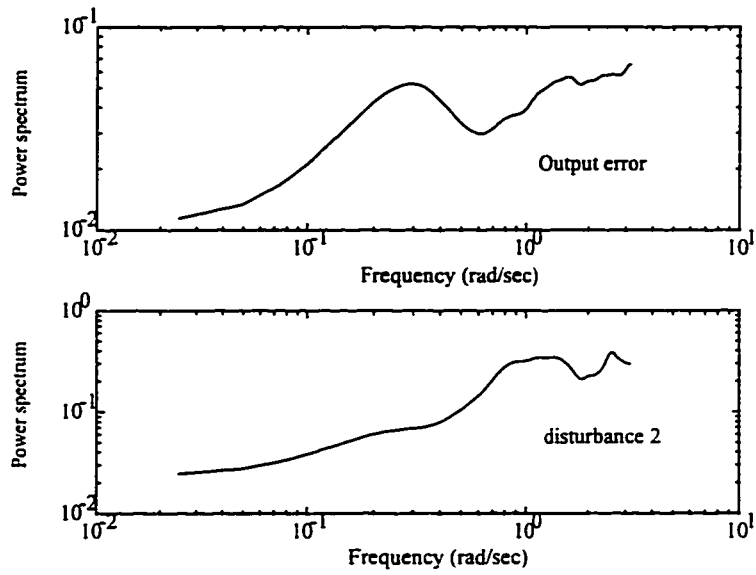

Figure 4.16: Column 2, data set 1: Spectrum of output error and disturbance 2 (differenced)

Table 4.2: Analysis of variance on Column 2 (data set 1)

	MV FB/FF	Non opt.FB	Non opt.FF	Non opt.FB/FF	Total
a_t	.0564	.0928	-	-	.1492
$b_{t,1}$	≈ 0	-	.0001	.0050	.0051
$b_{t,2}$	≈ 0	-	.0002	.0545	.0547
$b_{t,3}$.0022	-	.0011	.0082	.0115
Total	.0586	.0928	.0014	.0677	.2205

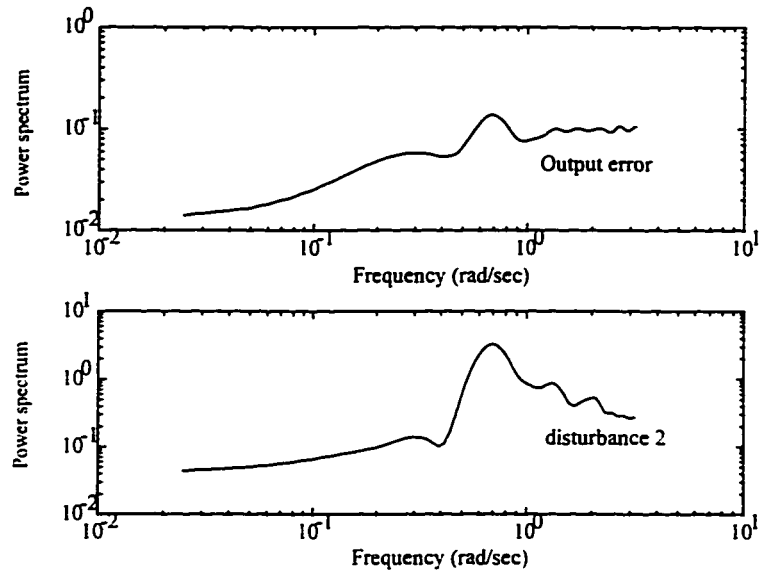

Figure 4.17: Column 2, data set 2: Spectrum of output error and disturbance 2 (differenced)

Table 4.3: Analysis of variance on Column 2 (data set 2)

	MV FB/FF	Total	% contribution
a_t	.0634	.1463	38
$b_{t,1}$	≈ 0	.0118	3
$b_{t,2}$	≈ 0	.1549	40
$b_{t,3}$	≈ 0	.0136	3.5
Total	.0634	.3266	81.5

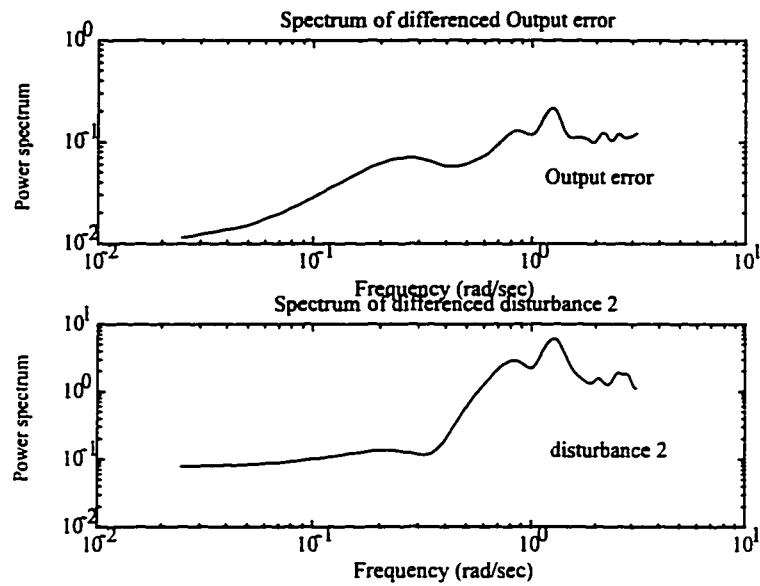

Figure 4.18: Column 2, data set 3: Spectrum of output error and disturbance 2 (differenced)

Table 4.4: Analysis of variance on Column 2 (data set 3)

	MV FB/FF	Total	% contribution
a_t	.0852	.1878	49
$b_{t,1}$	≈ 0	.0030	0.8
$b_{t,2}$	≈ 0	.1692	44
$b_{t,3}$	≈ 0	.0037	1
Total	.0852	.3607	95

which is represented as $y_t^{(b)}$ in equation (2.10) was estimated as .05. An optimal feedback controller can eliminate this contribution to the output variance as explained in section 3. Although a feedforward controller can also eliminate this contribution, there is marginal benefit in implementing a feedforward controller in this case; because the majority of the contribution from disturbance 2 to the output variance is due to the non optimality of FB/FF controller and by appropriately re-tuning the feedback controller we can eliminate this contribution. Therefore the best strategy is to retune the existing FB controller.

In data sets 2 and 3, disturbance 2 has some oscillatory trends associated with it. This is also shown in the analysis of variance table for data sets 2 and 3. The contribution from disturbance 2 to the overall output variance is about 40% and 44% in data sets 2 and 3 respectively. These adverse oscillations can be eliminated at source by a feedforward controller.

Figure 4.19 shows the actual output spectrum with the desired output spectrum and the minimum variance spectrum for data set 1. The desired spectrum was obtained the same way as explained for column 1. The controller setting seems to be under-tuned relative to the minimum variance benchmark. The controller may have been deliberately under-tuned to preserve robustness. If further reduction in variance is desired the controller can be made slightly aggressive.

Figure 4.20 shows the actual output spectrum for data set 2 with minimum variance and desired output spectrum. In data set 2 the output spectrum is close to the desired spectrum in the high frequency range but deviates from the desired spectrum in the low frequency range. To decrease the output variance one can either re-tune the existing feedback controller or implement a feedforward controller on disturbance 2 as discussed earlier.

For data set 3, as can be seen from Figure 4.21, even though the output spectrum is close to the desired spectrum it deviates from the desired spectrum in the mid frequency range. The frequency at which these oscillations occur is about 1.2 rad/sec

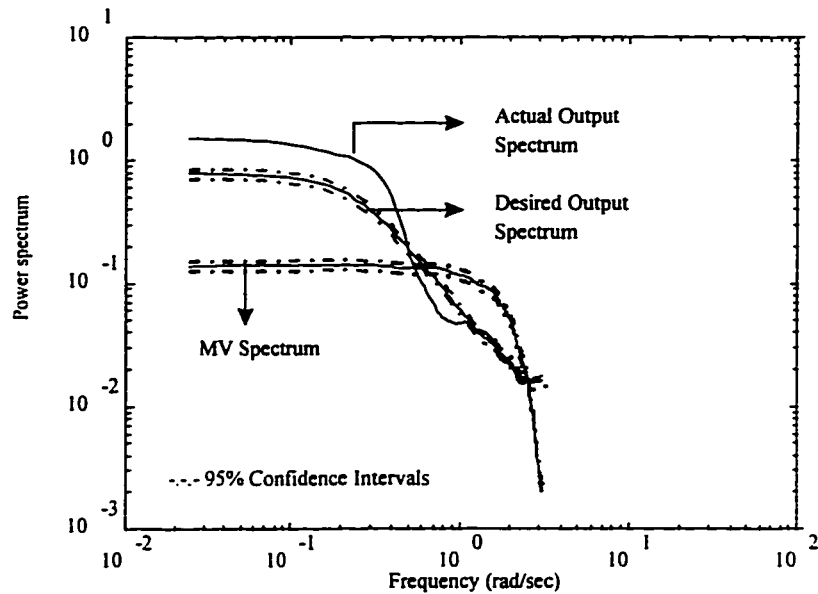

Figure 4.19: *Column 2, data set 1: Actual output spectrum with desired spectrum and MV spectrum*

and we observe from Figure 4.18 that disturbance 2 also has a peak at the same frequency. So the benefit of implementing a feedforward controller on disturbance 2 is further strengthened in this case.

4.2.4 Column 3

The manipulated variable is the reboiler duty. Three measured disturbances trends are supplied for consideration: column feed flow rate ($b_{t,1}$); column feed temperature ($b_{t,2}$); and column reflux flow rate ($b_{t,3}$). Feed forward compensation is applied to both the column feed flow rate ($b_{t,1}$) and the column feed temperature ($b_{t,2}$). Figure 4.22 shows the output error trend.

An autocorrelation plot of the output error trend with the desired trend is shown in Figure 4.23. Since there are significant lags beyond process delay $d = 5$, we can conclude that the controller performance is far from minimum variance condition.

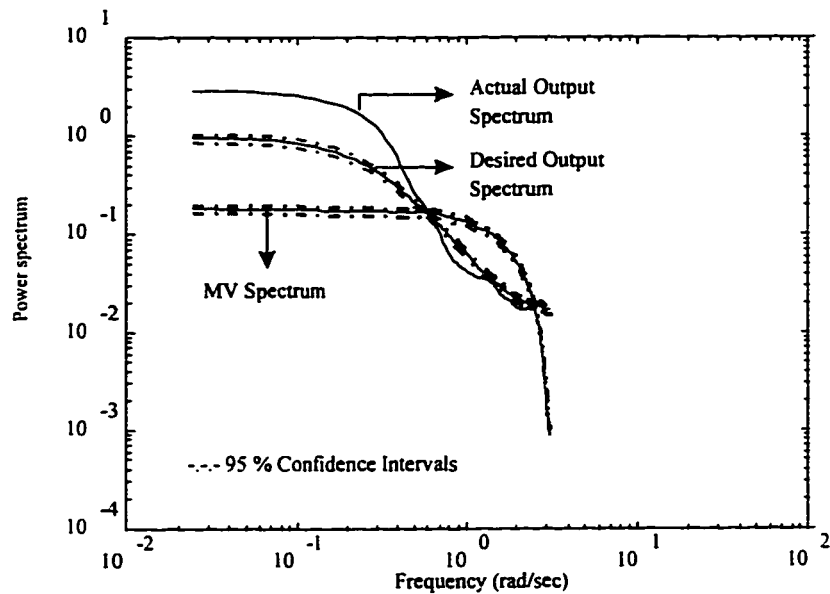

Figure 4.20: *Column 2, data set 2: Actual output spectrum with desired spectrum and MV spectrum*

The desired output trend was obtained as given in equation (4.1) with the response time set at 20 sampling intervals. The output settles in 150 minutes which is much slower than the desired settling time of about 80 minutes. Figure 4.24 shows the daily performance index over 8 weeks with each index representing 360 data points. The wide variation in performance index indicates the possibility of changing process conditions or time variant phenomena. Figure 4.25 shows the performance index with a sliding window of size 360. The indices are obtained as explained in the previous sections.

Figure 4.26 shows the cross correlations between the output error and pre-whitened disturbances. It is evident that all the disturbances 1 and 3 have some influence on the output. Disturbance 2 has a feedforward controller implemented on it. Since there is no significant correlation between disturbance 2 and output error it can be concluded that the existing feedforward controller is doing a good job of rejecting this

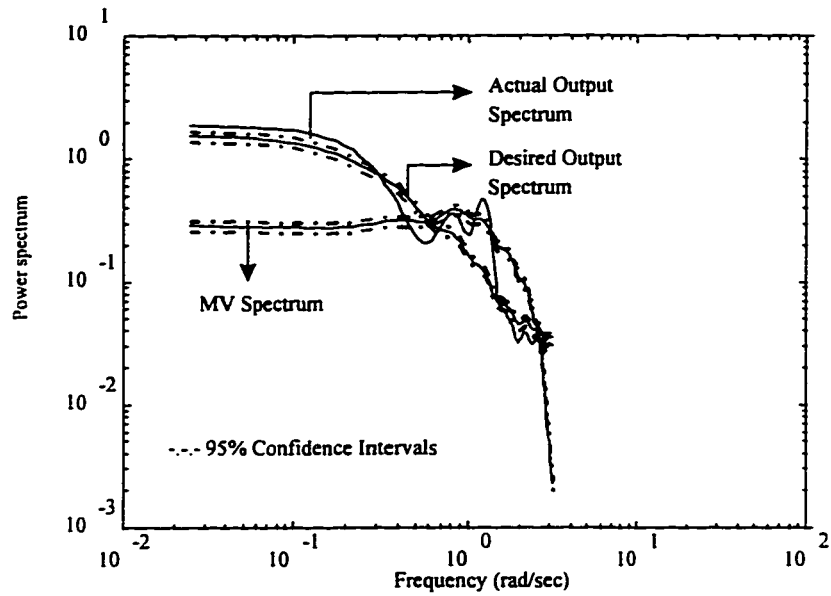

Figure 4.21: *Column 2, data set 3: Actual output spectrum with desired spectrum and MV spectrum*

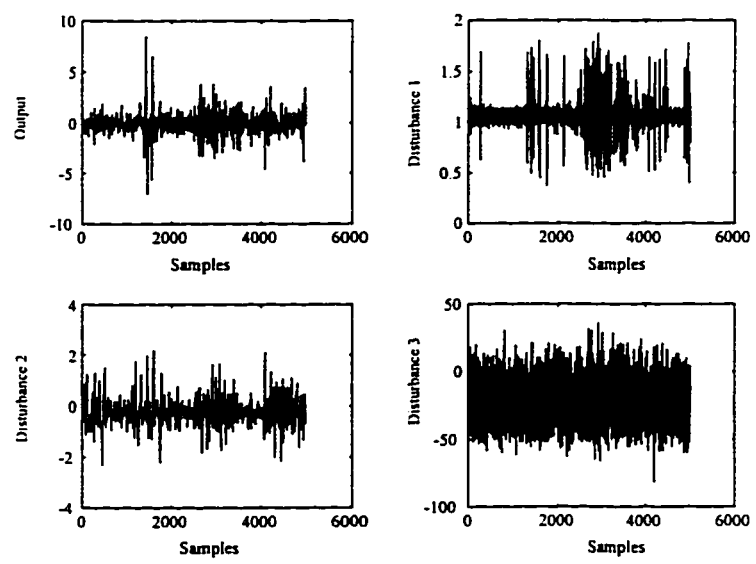

Figure 4.22: *Column 3: Output error and disturbance trends*

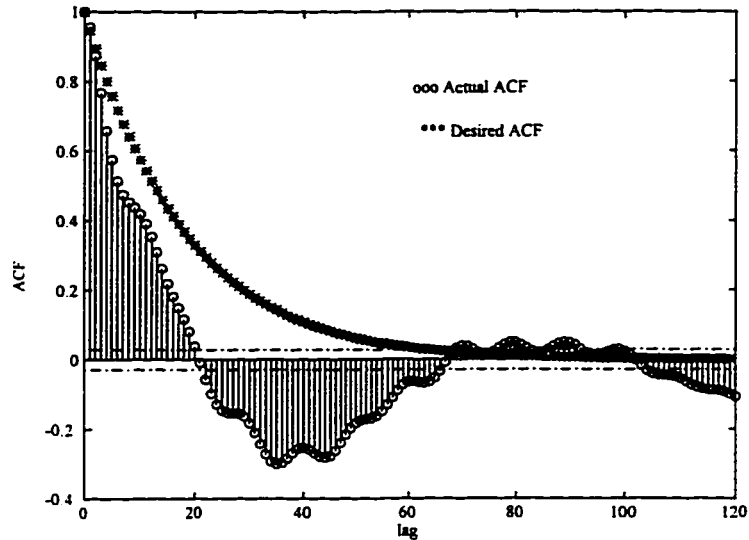

Figure 4.23: *Column 3: Actual ACF (ooo) vs Desired ACF (***)*; Time constant = 20 min; Sampling time = 1 min;

disturbance. A regression model was fit between the output error trend and the two disturbance trends. Table 4.5 gives the results of analysis of variance performed for this data set.

The actual output variance is 1.2604. Unmeasured disturbances contribute 88% to the overall variance. Both measured disturbances contribute very little to the output error variance. Therefore there is no incentive for retuning the existing feedforward controllers. The best solution is therefore to retune the existing feedback controller. The maximum reduction that could be achieved by retuning the feedback controller is $(1.1204 - .4244)/(1.2604) = 55\%$.

4.2.5 Concluding remarks

Control loop performance analysis has been performed on the three Shell distillation columns. In the case of column 1, the existing feedback controller is doing a satisfac-

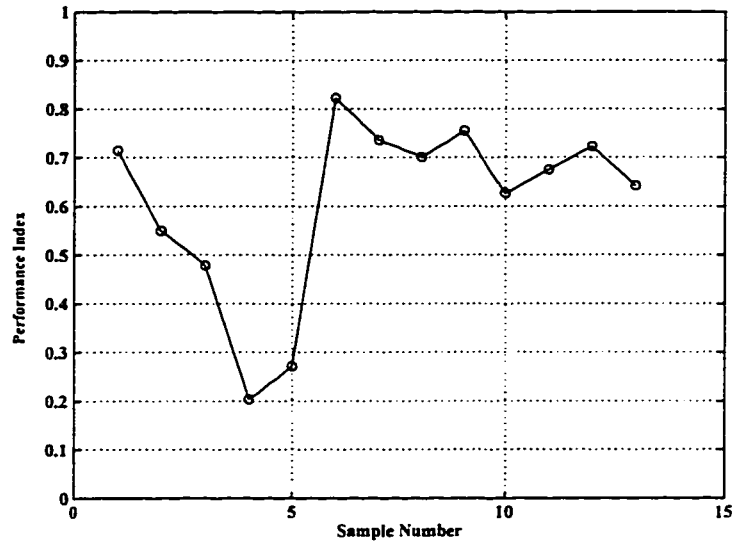

Figure 4.24: Column 3: Performance Index with each point representing a moving window of 360 points

Table 4.5: Analysis of variance on Column 3

	MV FB/FF	Total	% Contribution
a_t	.4244	1.1204	88
$b_{t,1}$	≈ 0	.1130	9
$b_{t,3}$	≈ 0	.0120	1
Total	$\approx .4244$	1.2454	98

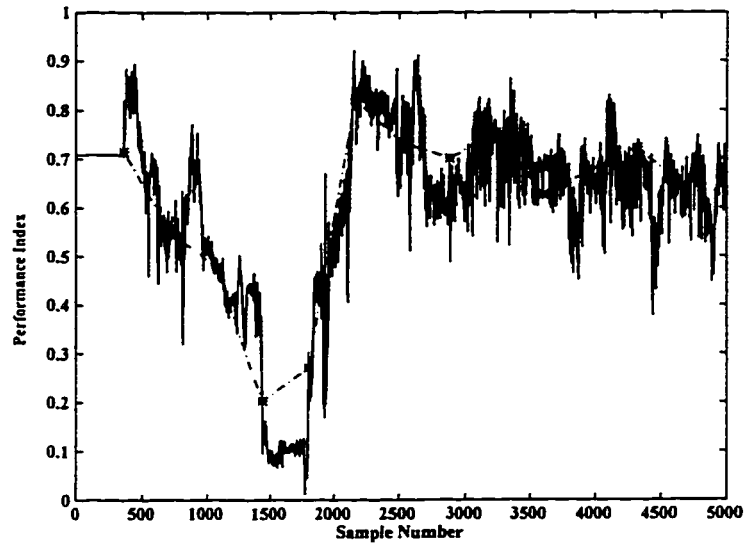

Figure 4.25: Column 3: Performance Index with a sliding window of size 360: (--- Performance index with a moving window of size 360)

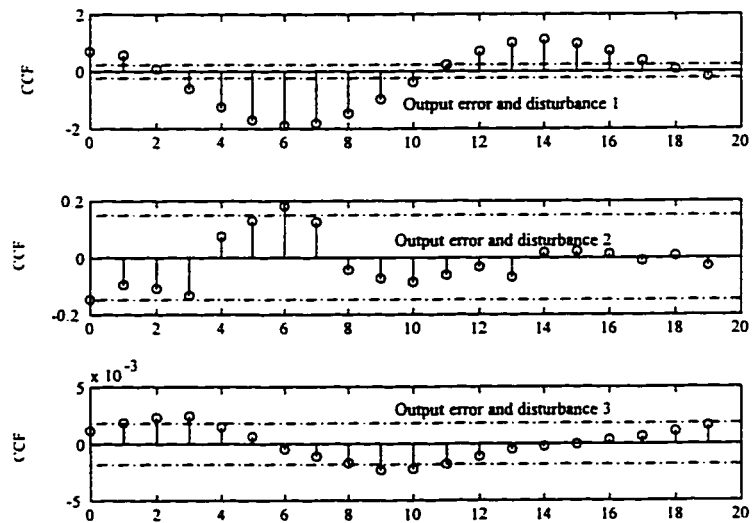

Figure 4.26: Column 3: Cross-correlation between output error and disturbance trends

Table 4.6: Comparison of performance for different controller Settings

Data Set	Move Suppression (Λ)	$\text{Var}(\varepsilon_t)$	$\text{Var}(\Delta u)$	Index (η)
1	8	.2239	.0031	.3773
2	8	.3829	.0273	.3352
3	4	.3883	.0509	.3317

tory job in meeting the process requirements. Any reduction in output variance could be achieved by retuning the feedback controller. There is no benefit of implementing feedforward control on disturbances 2 and 3.

Column 2 had three different control move suppression settings. Table 4.6 summarizes the average performance indices for each of the move suppression settings. The first move suppression provides the best compromise with respect to disturbance and set point trends. Even though the performance index for the first move suppression setting is only slightly higher than the other move suppression settings, data set 1 has smaller output and input variance. Setpoint changes do not have a significant contribution on the overall variance. In all cases disturbance 1 does not have a significant effect on the output error variance. In data set 1, the unmeasured disturbances have the greatest impact on the output error variability. Retuning the feedback controller may lead to further reduction in output variance. In data sets 2 and 3, disturbance 2 has some periodicities associated with the output error. So a feedforward controller may be useful to eliminate this disturbance.

Data from column 3 may have time variant phenomena associated with it. Except for brief excursions between samples 500-1700, the performance index for this column is about 0.6 which can be regarded as a very satisfactory performance level. The drop in the performance index between samples 500-1700 may be due to disturbances effecting the process. There is no incentive in retuning the existing feedforward controller or applying feedforward control to any other measured disturbances. Feedback controller re-tuning or re-designing is the best option in this column. Significant ef-

forts should be focussed on identifying problems related to controller tuning from routine operating data.

All the data sets have fairly complicated response patterns which could be due to several factors such as the presence of nonlinearities or time varying disturbance trends. Very high order whitening filters had to be used sometimes to pre-whiten the data. The data sets consisted of data collected over 6-8 weeks. Traditional time invariant performance assessment techniques posed a lot of problems in obtaining accurate information about the processes. The disturbances were also time varying in nature. A performance index based on a sliding window was used to minimize this problem. This resulted in a performance index for every data point collected. But getting the analysis of variance results for every data point poses a huge computational burden. Recursive estimation of the performance index could lead to better results for time varying processes. Spectral analysis on the output data for each of the data sets complemented and further strengthened the conclusions obtained by time domain performance analysis techniques. It is important to integrate both frequency and time domain performance assessment techniques in industrial control loop performance monitoring and assessment.

4.3 Cominco Industrial Case Study

4.3.1 Performance analysis

The second industrial example deals with the Cominco acid leach process. The main objective of the leaching step is to dissolve zinc from dry calcine by addition of "return acid". Return acid is spent zinc electrolyte recycled from the cell house, and contains H_2SO_4 to facilitate the reaction



The acid wetting cone is a convenient location at which feeds from a number of

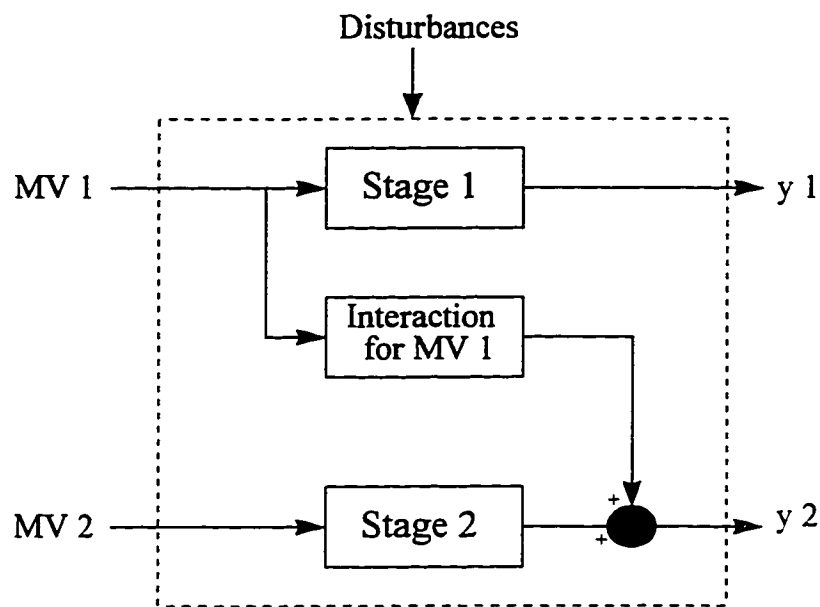

Figure 4.27: *Simplified schematic of the Cominco acid Leach process*

sources are introduced. The setpoints of stage 1 and stage 2 pH are typically set to 1.7 and 3.8 respectively. Tight control of stage 2 pH is of critical importance to the acid leach process because it promotes the precipitation of crystalline goethite particles, which settle well in the acid thickener tank following the later stages of acid leaching. If the second stage pH is allowed to fall below 3.5, iron begins to precipitate as ferric hydroxide, which tends to carry through the thickener tanks and blinds the filter cloths in cold stage purification. A simplified schematic diagram of the acid leach process is shown in Figure 4.27. The control problem can be viewed as 2x2 i.e. two manipulated variables and two controlled variables. Six potential feedforward variables were provided for consideration. They are sum of recycle flow rates (ff1), sum of stage 1 calcine mass flow rates (ff2), zinc pressure leach flow (ff3), oxide leach plant flow (ff4), return acid to hot acid leach (ff5) and acid thickener underflow to hot acid leach (ff6). A multivariate controller has been implemented to control the pH of stage 1 and stage 2. Stage 2 pH control is of critical importance and performance

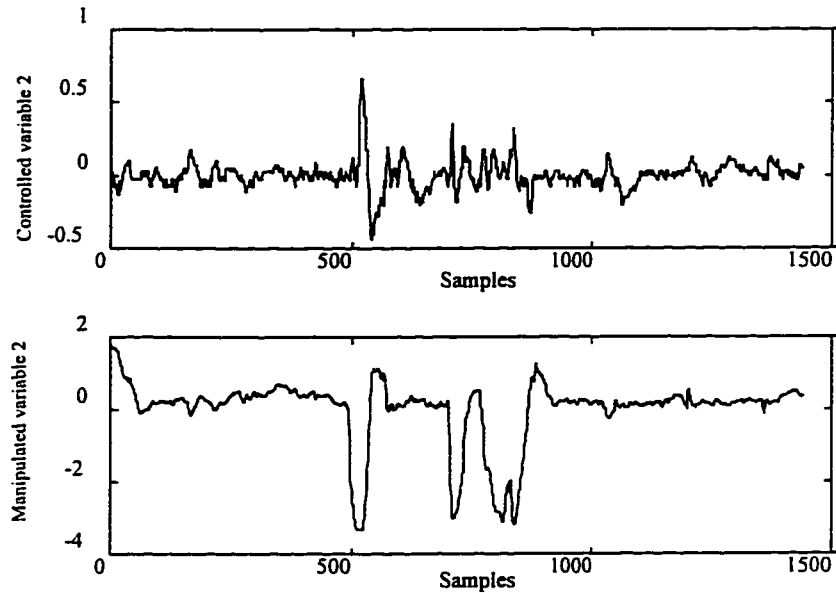

Figure 4.28: *Stage 2: Controlled variable and manipulated variable*

assessment of this loop is discussed first. Even though the existing control strategy is multivariate in nature one can split this multivariate performance analysis into two univariate performance assessment problems. For the stage 2-pH, the performance of existing feedback controller is analyzed by taking the manipulated input from stage 1 as a measured disturbance. For stage 1-pH, traditional SISO performance assessment will hold because there is only one way interaction. Figure 4.28 shows the process output (pH measurement) and the manipulated variable for stage 2. Figure 4.29 shows the autocorrelation function of output error 1 and output error 2. The second stage pH control is definitely not close to the minimum variance condition because there are significant lags beyond the process delay $d = 1$.

The existing control system can be regarded as a triangular system i.e. there is only one way interaction from stage 1 to stage 2. The manipulated variable in stage 1 affects stage 2 pH controller. A simple way to check if there is any interaction between stage 1 manipulated variable and stage 2 output is to carry out a cross-correlation

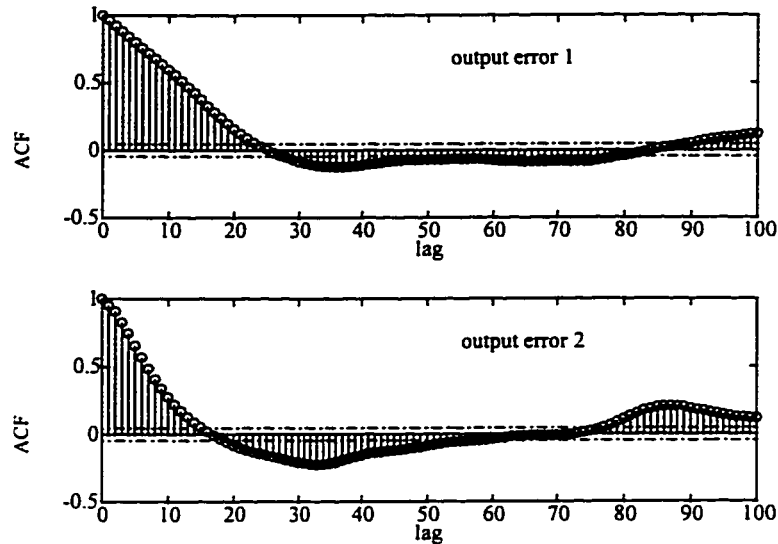

Figure 4.29: Autocorrelation function of stage 1 and stage 2 output error

test between output 2 and manipulated variable 1 as shown in Figure 4.30. It can be observed that there is significant correlation between output error 2 and manipulated variable 1. In the same figure it can also be seen that there is no correlation between output error 1 and manipulated variable 2, as one would expect to be the case. This interaction can be related to the performance of the multivariate controller being implemented. If the multivariate controller is doing a good job then the interaction between the manipulated variable 1 and stage 2 output should be minimal. Since the level of interaction is significant it can be concluded that there is potential for improvement in the performance of the existing multivariate controller.

Figure 4.31 shows the performance index of output 2 with a sliding window of size 500. The first performance index is calculated by using 500 data points and for every subsequent point thereafter a performance index was obtained. The dash-dotted lines represent the performance index with a moving window of size 500. The performance index drops at sample number 516. This can also be verified by the time series plot

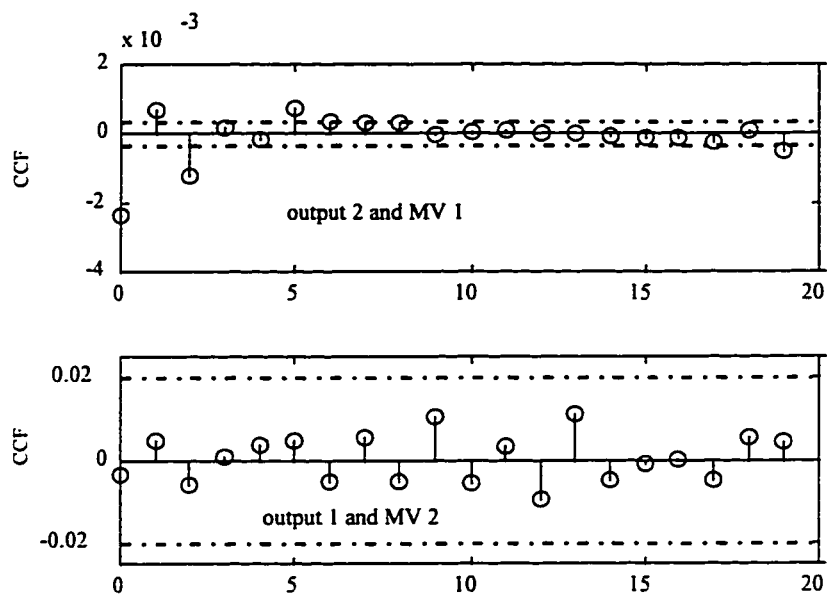

Figure 4.30: 1. Cross-correlation between output 2 and manipulated variable 1 (upper figure); 2. Cross-correlation between output 1 and manipulated variable 2 (lower figure).

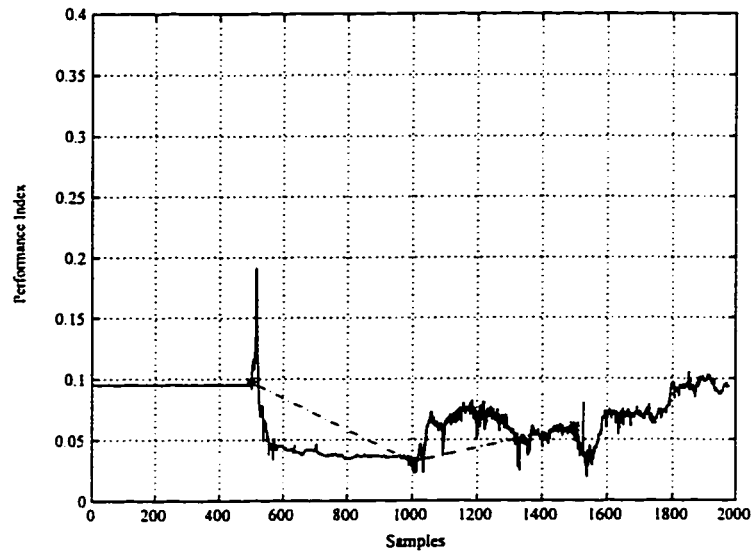

Figure 4.31: *Performance index of stage 2 controller*

of output 2 where there is a big fluctuation in the output at the same sample instant. The average index is about .07 which suggests that there is a potential for improvement in the performance of the existing controller. The next task would be to identify ways of improving the performance of the existing control system, *i.e.* whether to re-tune the existing controller or implement a feedforward controller on any of the measured disturbances.

For this one needs to check which of the six feedforward variables have significant effect on the output error. A simple cross-correlation test was employed to carry out this screening test. Figure 4.32 shows the cross-correlation between process output and various measured disturbances. All the disturbances have been pre-whitened with an appropriate filter. From Figure 4.32 it can be concluded that disturbance 2 and 4 have similar effect on the output error while the other disturbances have negligible effect on the output error. So these two variables are taken into account in a detailed analysis. The manipulated variable from stage 1 is not considered for analysis of vari-

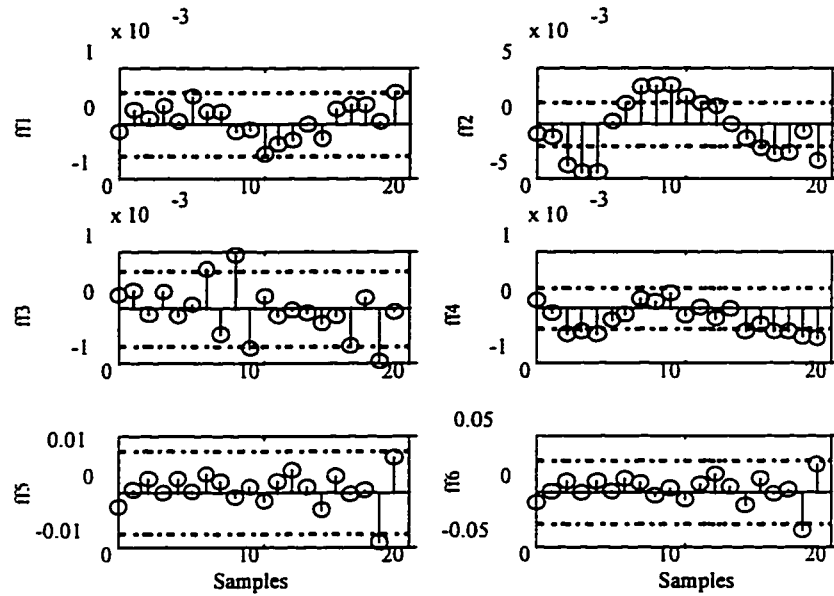

Figure 4.32: Cross-correlation between various disturbances and output error

ance because there is a ratio controller implemented between measured disturbance 2 and manipulated variable 1. Both of these variables are highly correlated and because of this, the ANOVA analysis would give incorrect results. A solution to overcome this problem is to perform a principal components analysis (Lakshminarayanan, 1997) on this data set so that any highly correlated variables can be combined into one or more independent or uncorrelated virtual variables that can efficiently represent the effect of these process variables on stage 2 output.

Figure 4.33 shows the spectrum of output with the minimum variance spectrum. The minimum variance spectrum was estimated on the assumption that the delay for loop 2 is equal to one. The output spectrum is not close to the minimum variance benchmark and deviates more so in the low frequency range. To increase the controller performance in the low frequency region, integral action may be necessary or should be increased if it already exists. Figure 4.34 shows the output spectrum and spectrum of disturbance 2. It can be seen that disturbance 2 has a peak close to the same

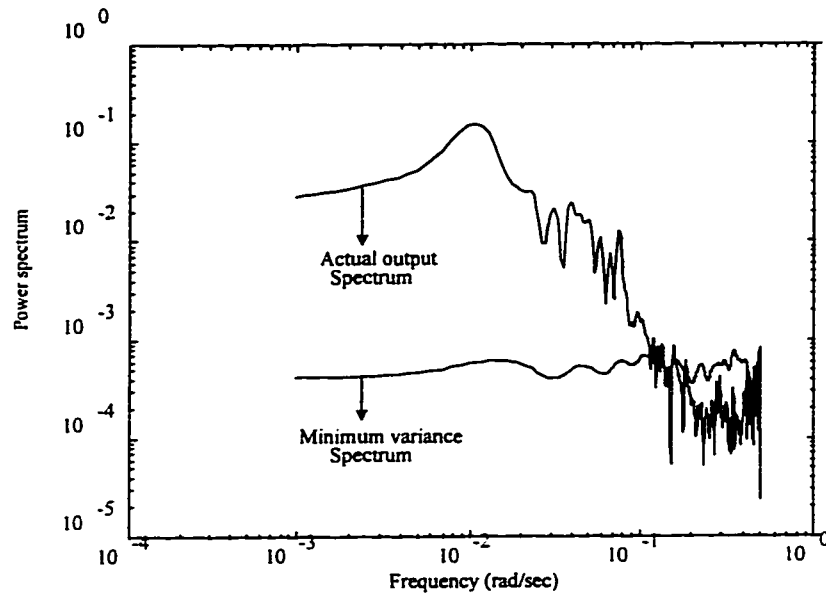

Figure 4.33: *Actual output spectrum (stage 2) vs. minimum variance spectrum*

frequency as the output error, suggesting that disturbance 2 has some unfavourable oscillatory trends which also affects the output error. A feedforward controller can be implemented to reduce these effects.

Table 4.7 provides the analysis of variance results for stage 2 output. The contribution from unmeasured disturbances to the output variance is 70%. The unmeasured disturbances represents the contribution from all the other sources which have not been taken into account for analysis of variance. Some of this contribution can be eliminated by re-tuning the existing feedback controller. Since the feedback controller for stage 2 forms part of the overall multivariate controller for the whole process, this suggests that the existing multivariate controller has to be re-tuned in order to reduce output variation. The contribution from disturbance 2 is 20%. A feedforward controller can be used to eliminate this contribution to the output error. Improving the performance index results in reduced output variance. For stage 2, the output variance is .0076 and the average performance index is about .06. If we can just

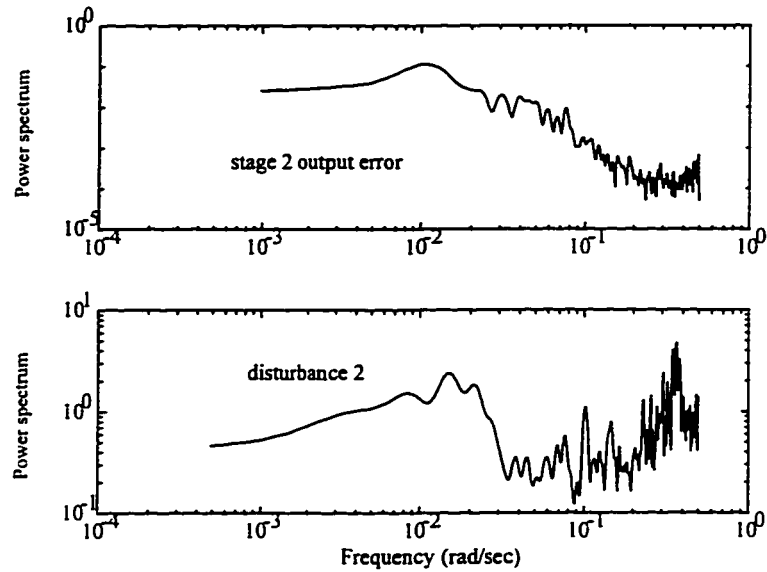

Figure 4.34: 1. Spectrum of output error (stage 2); 2. Spectrum of disturbance 2

achieve 66% increase in the performance index (equivalent to average index = .10) of stage 2 controller, then a 40% reduction in the output variance can be achieved. Table 4.8 provides the decrease in output variance that can be achieved by increasing the performance of stage 2 controller (η is the performance index).

Table 4.7: Analysis of variance (Stage 2 pH control)

	Total	% Contribution
a_t	.0053	70
$b_{t,2}$.0015	20
$b_{t,4}$.0004	5
Total	.0072	95

Table 4.8: Effect of increase in performance on stage 2 output variance

η	% Increase in η	% Decrease in output variance	Output Variance
.06	-	-	.0076
.10	66	40	.0046
.12	100	50	.0038
.18	200	66	.0026

4.3.2 Benefits analysis

For this case study, the benefit of reducing the output variance can be viewed in two different ways. To illustrate the benefit of reducing the output variance, a process output which is normally distributed but with a variance equal to the variance of stage 2 output is simulated. In practice the output may not be normally distributed. For a given variance the normally distributed output response represents the best possible output trend without any sudden upsets in the process. Therefore this gives one an idea of the best way a process can be operated for a given output variance. Figure 4.35 shows the output of the simulated process with a variance of .0076. The mean operating level is at a pH of 3.8. Now assume that the variance is reduced by 40% to .0046. This allows the operator to lower the typical set point from 3.8 to 3.7 and still ensure that the process does not violate the pH lower limit of 3.5, 999 times out of 1000. Figure 4.35 shows the case when the mean setpoint is 3.8 *vs* the case when the mean setpoint is 3.7. The process output is within the lower limit of 3.5 for both cases but in the second case the process output has a reduced variance of .0046; this allows the process setpoint to be reduced from 3.8 to 3.7. This is regarded as a very conservative estimate of possible improvement. In practice significantly more improvements may be achieved.

Another way of assessing the benefit of reduction in variance is to check how far the process operating from the lower (undesired) pH level of 3.5. Assume that the

setpoint is at 3.8 and the process has a variance of .0076. For simplicity assume the process is normally distributed. Then 99.9% of the operating points will lie in the range of $[3.8 \pm 3\sigma]$ which means that the range of process operation is between 3.54 and 4.06. If the variance is reduced to .0046 the range of process operation changes to $[3.6, 4]$. Figure 4.36 shows the process operating conditions when the output variance is .0076 and when the output variance is reduced to .0046. Consider a hypothetical safety margin defined by the distance between the typical process operating conditions and the lower limit of 3.5. We can see that this margin of safety increases as the variance of the output decreases. This mode of operation allows a larger “cushion-zone” between desired setpoints and the lower limit of 3.5. This in turn will lead to reduced Ferric hydroxide precipitation (a pH level of 3.5 causes undesirable ferric hydroxide to form) and ensures smooth operation of downstream processes such as cold stage purification. Again this is a very conservative estimate of the benefits possible with improved feedback control. Effectively this translates into an economic benefit.

The above two benefit analysis complement each other. If the reduction in the mean operating level translates to efficient use of raw materials then efforts should be directed to reduce the output variance so that the mean setpoint can be reduced as illustrated. If the reduction in the mean operating level does not yield significant benefits then the economic benefit of operating the process as far away from the lower undesirable pH value of 3.5 should be explored.

The performance analysis of stage 1 is discussed next. The autocorrelation plot of output error 1 shown in Figure 4.28 indicates that the performance of the stage 1 controller is far away from minimum variance since there are no significant lags beyond the stage 2 loop delay = 2 . Figure 4.37 shows the performance index with a sliding window size of 500. The indices are obtained in a similar fashion as explained for stage 2 performance. The mean performance index is about 0.15. This suggests that there is potential in improving the performance of existing controller. The feedback

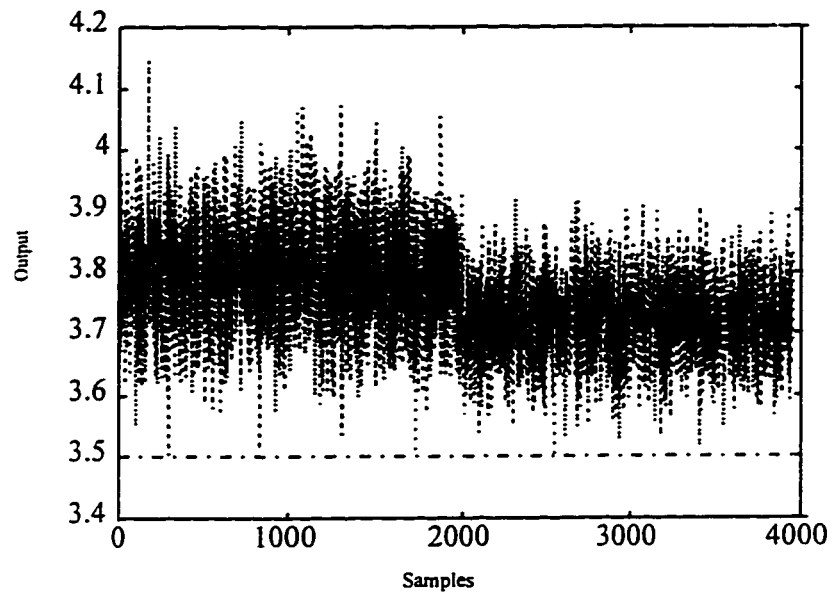

Figure 4.35: *Simulated process with different output variances*

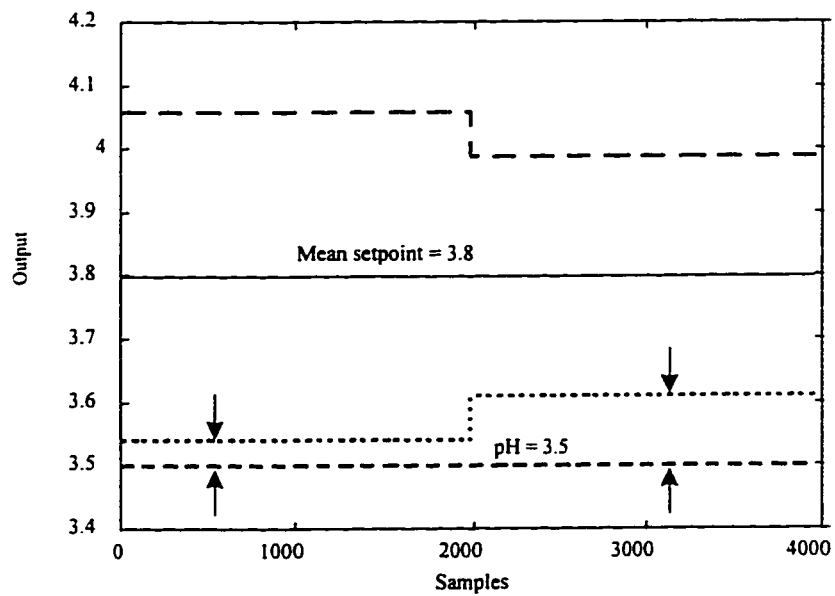

Figure 4.36: *Simulated process operating conditions with different output variances*

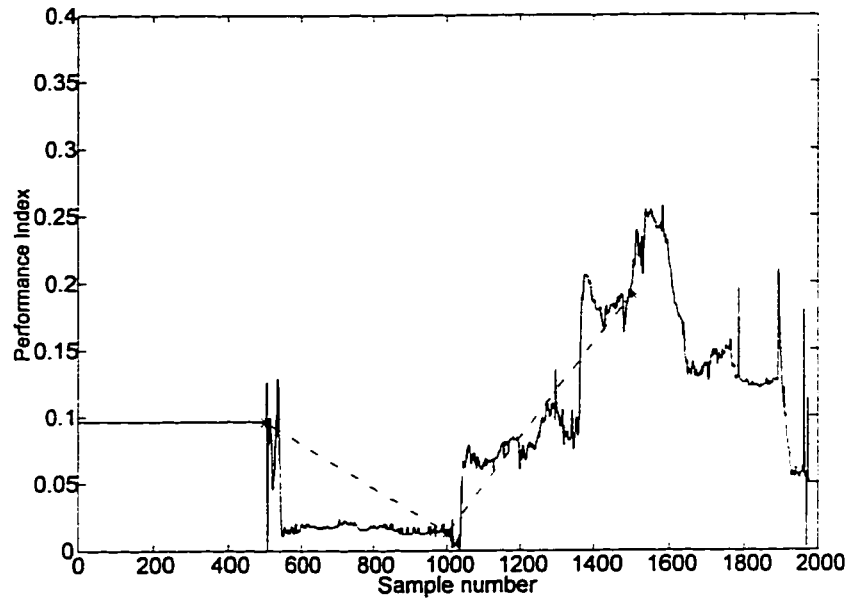

Figure 4.37: *Performance index for stage 1 controller*

controller in stage 1 also forms a part of the multivariate controller. This re-confirms that the existing multivariate controller is not doing a good job in reducing the output variance of stage 1 and stage 2 outputs.

Figure 4.38 shows the cross-correlation between stage 1 output and the various disturbances. Disturbances 2 and 4 affect the output error significantly compared to other disturbances. So these two disturbances are taken into account for further analysis.

Table 4.9 shows the analysis of variance for stage 1 output. The most significant contribution is from the unmeasured disturbances which is around 97%. This contribution can be eliminated to a certain extent by re-tuning or re-designing the existing stage 1 feedback controller. Some remarks on the above analysis are in order. The measured disturbances are highly correlated with one another and also the driving forces for each of the measured disturbances ($b_{t,i}$) and unmeasured disturbances (a_t) were not totally independent of one another. So there may be inflation in the contribu-

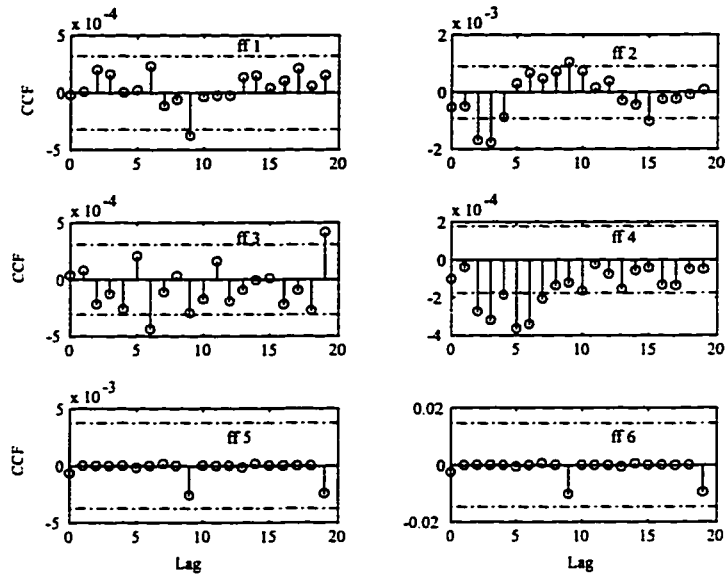

Figure 4.38: Cross-correlation between different disturbances and stage 1 output

Table 4.9: Analysis of variance (Stage 1 pH control)

	Total	% Contribution
a_t	.0030	97
$b_{t,2}$.0002	7
$b_{t,4}$.0001	3
Total	.0033	107

tion of output variances from each of the disturbances. The analysis was also difficult because pH systems are inherently non-linear in nature and this further complicated the data analysis. In addition more insight into the control strategy employed in the actual plant would help in understanding the strong correlation observed between different process variables.

4.3.3 Principal components analysis

The analysis of variance poses a lot of problems when the measured disturbances are highly correlated with one another. One of the main assumptions in performing the analysis of variance is the independence of the driving signals to the unmeasured disturbances and measured disturbances. If this assumption is invalid, then one may not be able to obtain reliable results. Instead of dealing with the measured disturbances individually, one can use principal components analysis (PCA) to compress these correlated variables into fewer independent latent variables. These latent variables are an optimal linear combination of the original variables and can explain most of the variance in the original process variables and are orthogonal to each other i.e. uncorrelated with each other. A detailed discussion on principal components analysis can be found in Lakshminarayanan (1997).

For stage 2 pH control there are six potential feedforward variables. In addition, the manipulated variable from stage 1 can be regarded as a measured disturbance for stage 2 as explained earlier. Of these seven measured disturbances only four were found to have some effect on the output. These four variables were therefore used for principle components analysis and reduced to two latent variables. Figure 4.39 shows the loadings plot between principle components 1 and 2. The loadings plot gives an idea as to which of the variables are correlated with one another. The variables which are correlated with one another tend to cluster together. It can be seen that manipulated variable 1 and feedforward variable 2 are strongly correlated.

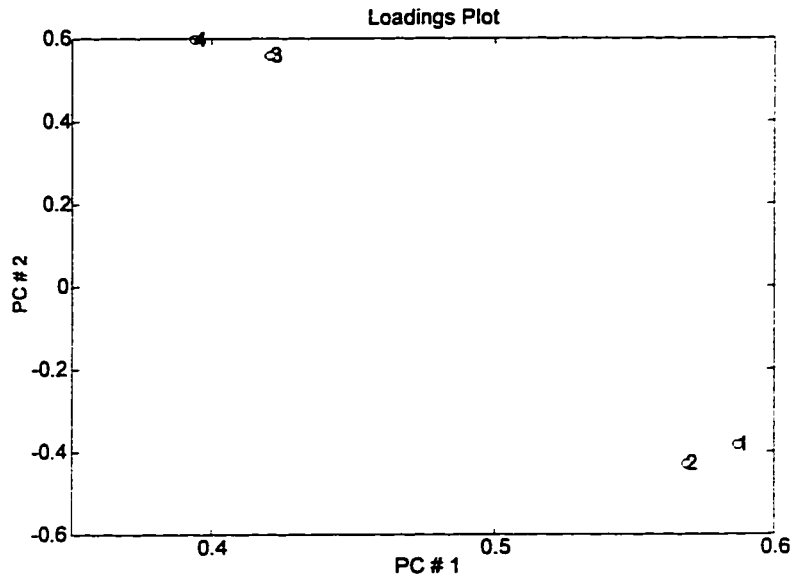

Figure 4.39: *Loadings plot*

Similarly measured disturbances 3 and 4 are correlated with one another. The two latent variables were used for carrying out analysis of variance. The procedure for analysis of variance is similar to that described in earlier sections except that now the latent variables are used instead of the original variables. Table 4.10 gives the contribution from the two latent variables (denoted as $Lv1$ and $Lv2$) to the output variance. By implementing feedforward control of latent variable 1, one can eliminate most of the contribution to the output due to this latent variable.

The main advantage with the above analysis is that one deals with latent variables which are independent of each other and are also an optimal combination of the measured disturbances. So the assumption that the driving forces between unmeasured disturbances (a_t) and measured disturbances (b_t) is easily satisfied.

Table 4.10: Analysis of variance using PCA (Stage 2 pH control)

	Total	% Contribution
a_t	.0049	64.5
$Lv1$.0027	35.5
$Lv2$.0006	7.0
Total	.0082	107

4.3.4 Concluding Remarks

Performance analysis was carried out on two pH control loops associated with the Cominco zinc acid leach process. The performance of the existing multivariate controller is far from satisfactory and significantly away from minimum variance condition. There is significant potential for improvement by re-tuning or re-designing the multivariate controller. From the spectral analysis of the output data it can be concluded that the controller is under-tuned relative to the MV benchmark. To improve controller performance, the controller can be made more aggressive by increasing integral action and/or the proportional gain. The benefits of improved performance for this process include reduction in mean operating levels and operating the process significantly far away from the lower pH limit of 3.5 which can translate into economic benefit.

Chapter 5

Conclusions

Control loop performance assessment should be regarded as an integral part of a control system in any chemical process industry. The key idea behind performance assessment is to use routine operating data to obtain information about the 'health' of the control system. The minimum variance benchmark represents the absolute lower bound beyond which one cannot reduce the output variance. In Chapter 2, the performance assessment of feedback and feedforward control loops using a minimum variance benchmark and analysis of variance was discussed. Once it is determined that the existing controller is not performing satisfactorily with respect to the desired benchmark it is then necessary to carry out controller diagnosis to improve overall performance. One way is to re-tune the existing controller. Thus controller tuning is an integral part of performance assessment. In Chapter 3, spectral techniques are used to evaluate how well the existing controller is tuned with respect to minimum variance benchmark. Spectral analysis of routine closed loop data allows one to determine if a controller is over-tuned or under-tuned with respect to a benchmark spectrum. In Chapter 4, the application of the above performance assessment techniques were evaluated on two industrial data sets.

5.1 Contributions of this thesis

The main contributions of this thesis are:

- Feedback and feedforward performance assessment techniques were extensively evaluated on pilot-scale processes.
- A laboratory scale performance assessment system was developed using *LabVIEW/Matlab* integration platform with *Dynamic Data Exchange (DDE)*. The program collects routine closed loop data and provides the user with on-line performance index and monitors process variables using a univariate Shewart chart. The details of the above performance assessment system are provided in Appendix B.
- Controller tuning problem for single input single output processes was addressed through spectral analysis of routine closed loop data. The technique developed provides the user with information on whether the controller is over-tuned or under-tuned and recommend necessary steps for performance improvement.
- The techniques for the analysis of controller tuning problem were extended to a practical user-defined benchmark such as settling time, desired closed loop constant *etc.* instead of the minimum variance benchmark.
- The use of spectral techniques in performance assessment was demonstrated by experimental application to computer-interfaced pilot-scale processes.
- Control loop performance assessment was also evaluated on two industrial closed loop data sets from Shell USA and Cominco Inc.
- Principal components analysis was used to carry out analysis of variance on the Cominco industrial data set which had highly correlated measured disturbances.

5.2 Future Work

- Measured disturbances are sometimes highly correlated and carrying out analysis of variance often poses many difficulties. One way of tackling this problem would be to use Vector AutoRegressive Moving (VARMA) models and then carry out multivariate regression analysis. Another way would be to combine some of these highly correlated variables into latent variables through principal components analysis and then carry out performance assessment with these latent variables.
- Feedforward controller tuning also forms an important part of the overall performance assessment tool and should be examined with respect to minimum variance feedforward control.
- Performance degradation of the existing control system can be due to either controller related problems or process related problems. Process related problems include poor equipment selection, valve stiction etc. These problems make the process non-linear and traditional performance assessment techniques may not give reliable results. Spectral techniques such as coherency analysis can be used to detect some of these non-linearities. The problem is more involved because one has to deal with closed loop data.
- Fault detection and integration of fault diagnosis and performance assessment would be a logical complement to the techniques discussed in this thesis.
- Industrial data usually is time-variant in nature. Performance assessment techniques that take into account these time-varying phenomena would have great industrial appeal.

Bibliography

- Astrom, K.J (1970). *Introduction to Stochastic Control Theory*. Academic Press.
- Bendat, J.S. (1990). *Nonlinear System Analysis and Identification from Random Data*. John Wiley and Sons.
- Bialkowski, W.L. and R. Elliot (1996). Competency in process control - industry guidelines. *Pulp and Paper Canada* **97:5**, 28–33.
- Box, G.E.P. and G.M. Jenkins (1976). *Time Series Analysis Forecasting and Control*. Holden-Day.
- Cryer, J.D (1986). *Time Series Analysis*. Duxbury Press.
- Desborough, L. and Harris (1992). Performance assessment measures for univariate feedback control. *The Canadian Journal of Chemical Engineering*.
- Desborough, L. and Harris (1993). Performance assessment measures for univariate feedforward /feedback control. *The Canadian Journal of Chemical Engineering*.
- DeVries, W.R. and S.M. Wu (1978). Evaluation of process control effectiveness and diagnosis of variation in paper basis weight via multivariate time series analysis. *IEEE Trans. on AC*.
- Dillon, W.R. and Matthew Goldstein (1984). *Multivariate Analysis Methods and Applications*. John Wiley and Sons.

- Eriksson, P.G. and A.J. Isaksson (1994). Some aspects of control performance monitoring. In: *3rd IEEE conf. Control Applications*. pp. 1029–1034.
- Harris, T.J. (1989). Assessment of control loop performance. *The Canadian Journal of Chemical Engineering*.
- Himmelblau, D.M. (1978). *Fault Detection and Diagnosis in Chemical and Petrochemical Processes*. Elsevier Scientific Publishing Company.
- Huang, B. (1997). Multivariate Statistical Methods for Control Loop Performance Assessment. PhD thesis. University of Alberta.
- Huang, B. and S.L. Shah (1996). Limits of control loop performance: Practical measures of control loop performance assessment. In: *AIChE Annual Meeting*. Chicago.
- Huang, B., Shah S.L. and K.Y. Kwok (1995a). On-line control performance monitoring of mimo processes. In: *American Control Conference*. pp. 1250–1254.
- Huang, B., Shah S.L. and K.Y. Kwok (1995b). Performance assessment and diagnosis of multivariable processes. In: *AIChE Annual Meeting, Miami, USA*.
- Jenkins, G.M. and D.G. Watts (1968). *Spectral Analysis and its Applications*. Holden-Day.
- Kozub, D. and Garcia (1993). Monitoring and diagnosis of automated controllers in the chemical process industries. In: *AIChE Annual Meeting, St.Louis*. Vol. 32.
- Lakshminarayanan, S. (1997). Process Characterization and Control using Multivariate Statistical Techniques. PhD thesis. University of Alberta.
- Ljung, L. (1987). *System Identification*. Prentice-Hall.

- Lynch, C.B. and G.A. Dumont (1993). Closed loop performance monitoring. In: *2nd IEEE Conf. Control Applications*.
- Ohtsu, K. and G. Kitagawa (1984). Statistical analysis of the ar type ship's autopilot system. *J.Dyn.Syst.* **106**, 193–202.
- Prett, D.M. and C.E. Garcia (1988). *Fundamental Process Control*. Butterworths.
- Priestley, M.B. (1981). *Spectral Analysis and Time Series*. Academic Press.
- Pryor, C (1982). Autocovariance and power spectrum analysis-derive new information from process data. *Control Eng.* **2**, 103–106.
- Rice, H.J. and J.A. Fitzpatrick (1987). A generalised technique for spectral analysis of non-linear systems. *Mechanical Systems and Signal Processing* **2(2)**, 195–207.
- Seborg, D.E., Edgar T.F. and D.A. Mellichamp (1989). *Process Dynamics and Control*. John Wiley and Sons NY.
- Stanfelj, N., Marlin T.E. and J.F.MacGregor (1993). Monitoring and diagnosing process control performance: The single loop case. *Ind.Eng.Chem.Res.*
- Tyler, M.L. and M. Morari (1995). Performance monitoring of control systems using likelihood methods. In: *American Control Conference*. pp. 1245–1249.
- Wei, W.W.S (1990). *Time Series Analysis Univariate and Multivariate Methods*. Addison-Wesley.

Appendix A

Steps Involved In Performance Assessment

The various steps involved in performance assessment are shown in Figures A.1-A.3. The first step involved in performance assessment is to screen the closed loop data by removing outliers and mean centering the data. The next step would be to verify if the performance of the existing controller is satisfactory with respect to the desired benchmark. This benchmark could be minimum variance benchmark or user defined benchmark. If the control loop performance is not satisfactory, one needs to determine whether the poor performance is due to controller related or process related problems. Process related problems may include poor equipment selection, sensor/actuator problems *etc.* Figures A.2 and A.3 detail the various steps involved if the performance degradation is due to controller related problems.

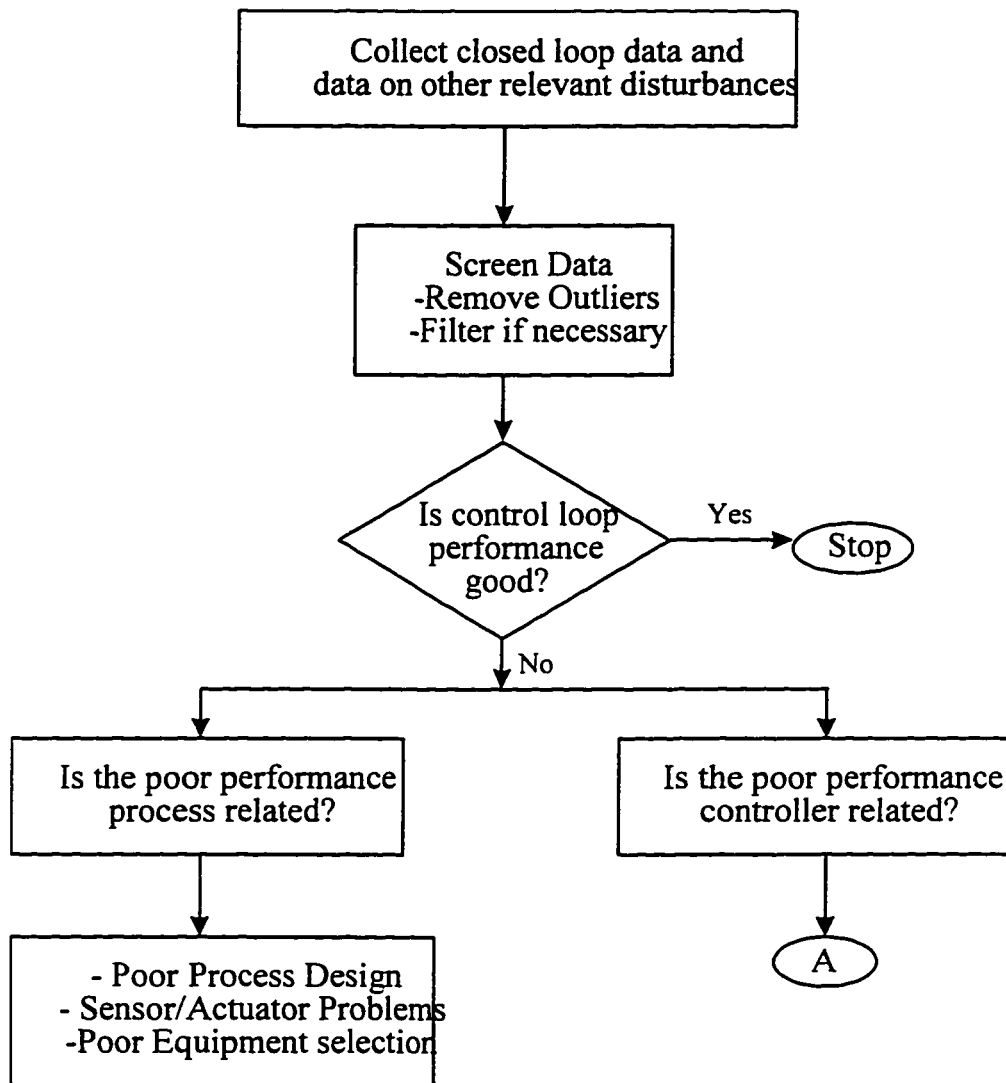

Figure A.1: Steps involved in Performance Assessment (I)

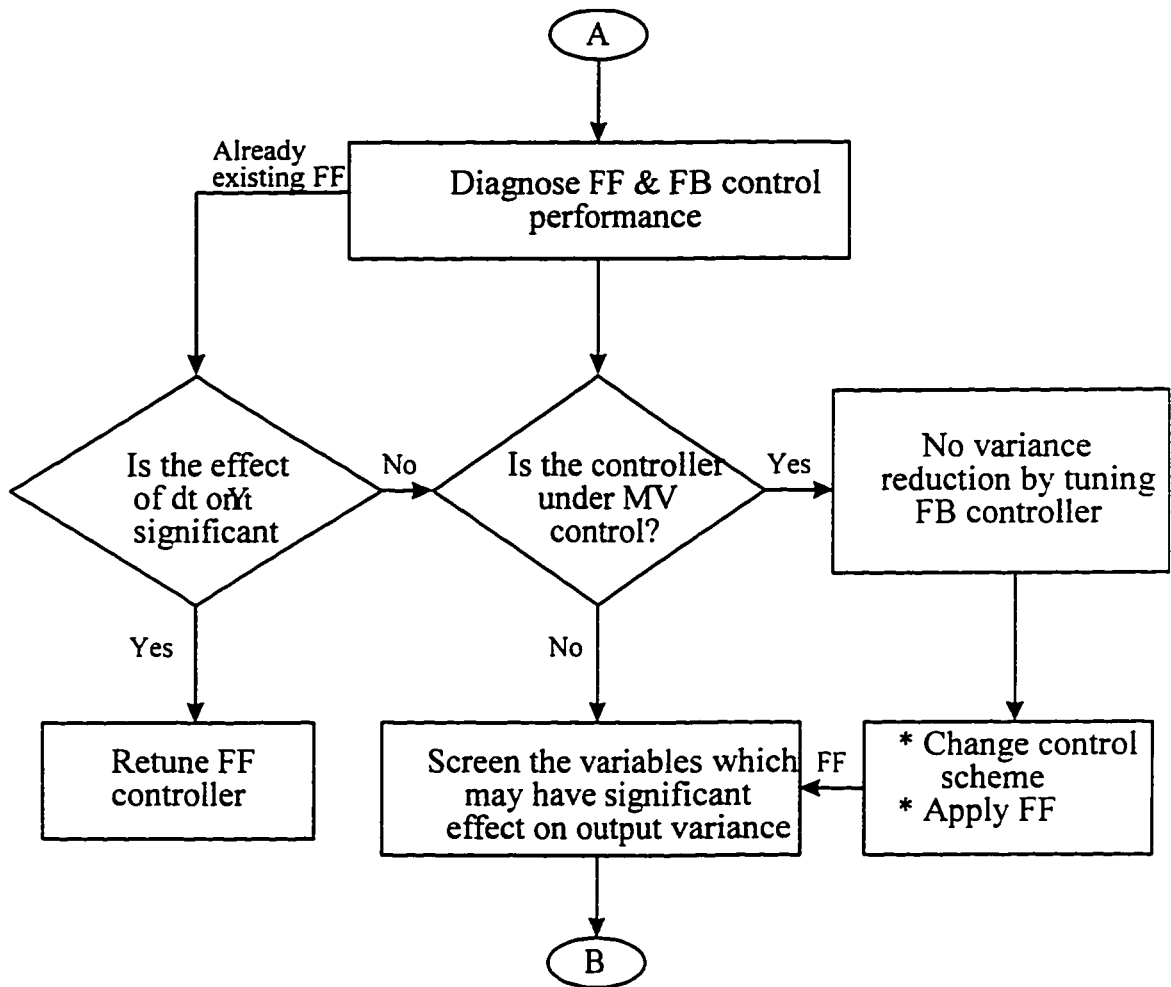

Figure A.2: Steps involved in Performance Assessment (II)

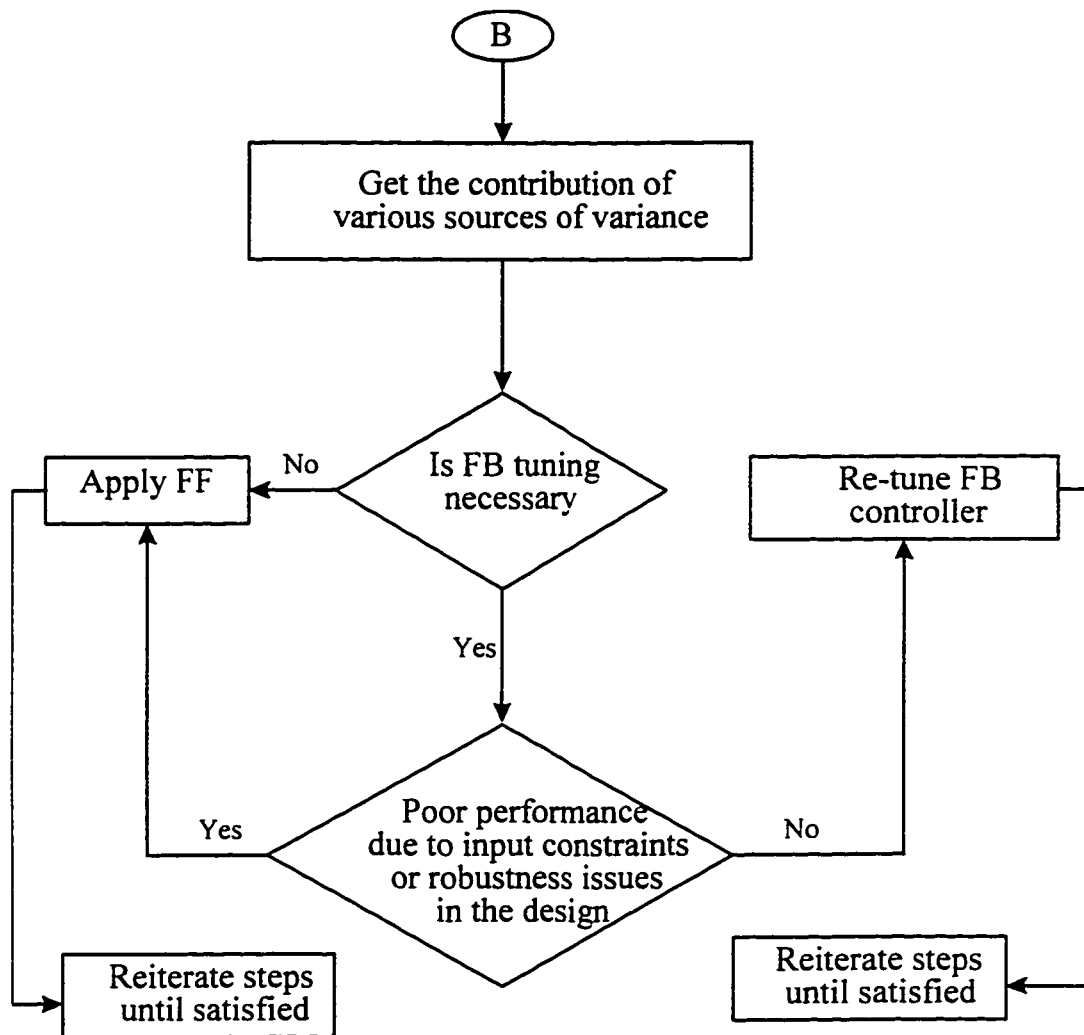

Figure A.3: Steps involved in Performance Assessment (III)

Appendix B

Laboratory Scale Performance Monitoring Using LabVIEW

B.1 Introduction

The main objective in developing this laboratory scale performance monitoring system was to utilize the latest advances in systems integration. A new trend has emerged in the field of systems integration that considerably simplifies the job of the systems integrator, and allows for a lot of flexibility. This trend is towards the establishment of communication interfaces between application programs which may be written on different platforms and may be run on different computers. This new approach has been brought to the PC world by Microsoft's Windows API (Application Programmers Interface). The performance assessment system developed uses Matlab for carrying out the control algorithms and LabVIEW for real-time data acquisition, implementation of the control signals on the process and a LabVIEW MMI or front-end for user interaction. Matlab is extremely useful in developing control algorithms in a relatively straightforward fashion. LabVIEW allows reliable data acquisition in a real-time environment. In effect the performance monitoring system developed here

tries to combine the useful features both of these two platforms.

B.2 System configuration

The main software packages used in the development of this system are Matlab 4.2.c1 and LabVIEW 4.0. The DAQ hardware mainly consisted of OPTO22 - Optomux boards. The program was operating under Windows 3.1 operating system environment (The system developed is also fully compatible with the latest Windows 95 operating system). LabVIEW 4.0 provides a suite of four communication protocol VI (virtual instruments) libraries: DDE (Dynamic Data Exchange), OLE (Object Linking and Embedding), UDP (User Datagram Protocol) and TCP/IP (Transmission Control Protocol/Internet Protocol). The system developed for this particular application uses the DDE protocol in a client (LabVIEW) - server (Matlab) mode. DDE is a client-controlled data passing protocol, which can be used to write, request and execute string commands in another windows application that is running either on the same or on a different computer. Since LabVIEW 4.0 and Matlab 4.2.c1 are DDE-enabled, a DDE conversation can be opened between the two applications, and the DDE read, write, and execute commands can be implemented in real-time. This code also uses VI's in OPTO22 libraries (OPTO22.llb, OPTO22S.llb) to read data from the sensors and write data to the final control elements such as valves. The code has four case structures (details about case structures can be found in the LabVIEW users manual)

- Case 0: Open DDE conversation
- Case 1: Initialize the OPTO22 board at Optumux address FF (255)
- Case 2: Configure the channels of the Optomux board for Read or Write

- Case 3: Perform read/write operations from/to Opto22, and request/execute operations from/to Matlab.

B.3 Main features

The main features of the monitoring system are as follows:

1. Data acquisition is possible on as many as four input variables and three output variables (data acquisition is limited by the existing hardware setup).
2. The system provides the user with a matlab command window where the control algorithm can be implemented.
3. Simple univariate shewart chart is displayed for any or all of the process variables with an option for number of data points to be used for calculating the sample statistics.
4. Univariate performance index is displayed for the controller being implemented with a sliding window whose size is fixed by the user.
5. The front panel created using LabVIEW allows the user to dynamically change the controller tuning parameters, sampling time *etc.* (see Figure B.1)
6. The code is extremely portable and can be used for different pilot-scale processes with appropriate changes in the input/output configurations.
7. Each tank in the experimental setup is a double-walled glass tank 50 cm high with an inside diameter of 14.5 cm The nominal operating conditions are as follows: a) The steady state value of the stem position of the control valve is 50%. b). The steady state value of the water level in the tank is 40% of the actual tank height.

The performance index was obtained using the methods described in chapter 2. The sample statistics such as mean, standard deviation were calculated using inbuilt LabVIEW VI's (Virtual Instruments).

PROCESS MONITORING AND CONTROL LOOP PERFORMANCE ASSESSMENT

Plant Parameters

Sampling | Set point | M/lab Command |
 Data points | Tuning Parameter |
 Valve 1 | Valve 2 | index |

Valve 1 Position | 0.00

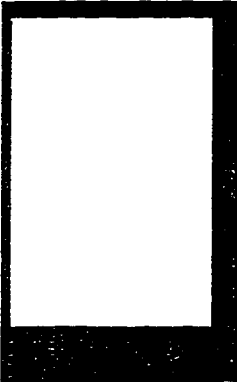

Tank 1



High
Low

Tank 1 Stewart Chart



Standard Dev



Valve 2 Position | 0.00

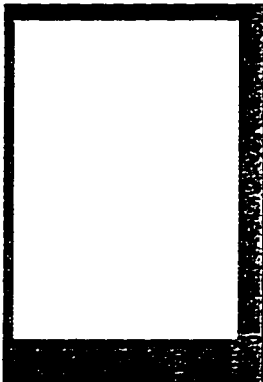

Valve 2 Stewart Chart

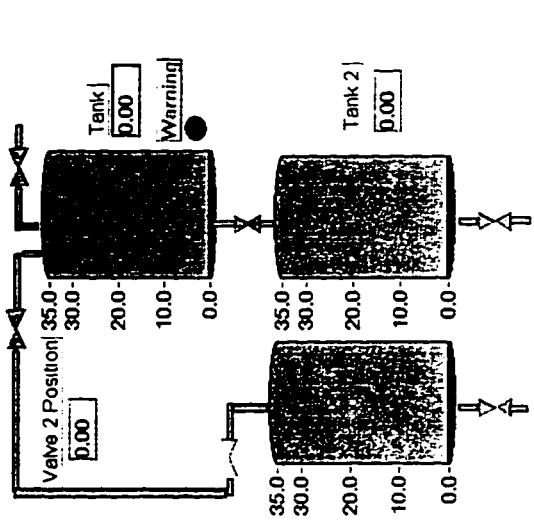

Control Loop Performance Audit

Main Statistics

Loop Tag: AC 3251
Loop Delay: 1

Data Sample size: 1970
Sample date : Jan 17 - 18, 1997
Average Performance Index: 0.06

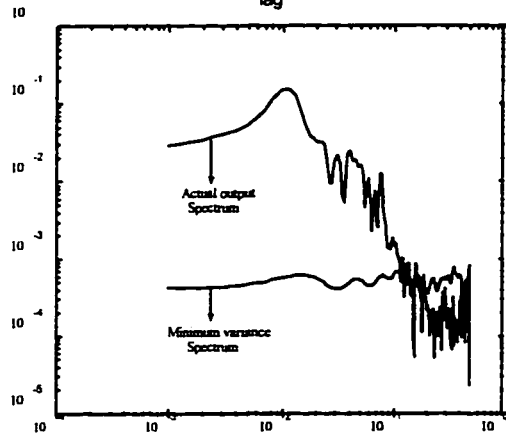
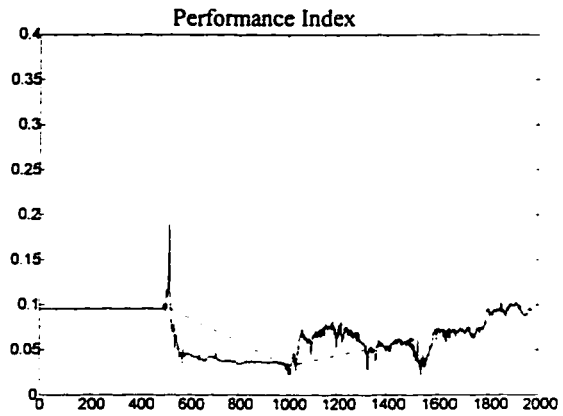
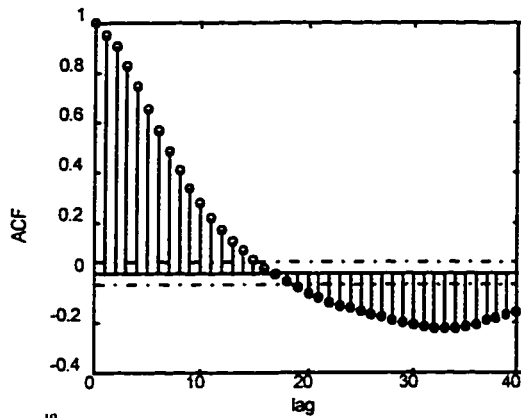

Analysis

1. Controller is far away from minimum variance condition
2. There is significant potential for improvement by re-tuning or re-designing the multivariate controller
3. Controller is under-tuned relative to the MV benchmark

Recommendations

Make the controller more effective/aggressive by increasing integral action and/or the overall proportional gain

Benefits

1. Should lead to reduction in mean operating levels
2. Allows the process to operate significantly far away from the lower pH limit of 3.5 or close to the limit due to reduced variance thus saving operation costs