

THE UNIVERSITY OF ALBERTA

AN ANALYTICAL STUDY OF THE IN SITU
DEFORMATION OF ROCK

by



JACQUES BOURBONNAIS

A THESIS

SUBMITTED TO THE FACULTY OF GRADUATE STUDIES
AND RESEARCH IN PARTIAL FULFILMENT OF THE
REQUIREMENTS FOR THE DEGREE OF
MASTER OF SCIENCE

DEPARTMENT OF CIVIL ENGINEERING

EDMONTON, ALBERTA

FALL, 1973

ABSTRACT

The study undertaken here deals with the deformability of rock masses. To attain reliable conclusions on this subject surface and underground structures like concrete dams and underground powerhouses will be analysed.

At the investigation stage of the construction of large projects, like those mentioned above, in situ tests are performed on the rock to evaluate the deformability characteristics of a mass. The structures we refer to, load a very large volume of rock. Thus, large in situ static tests are the ones which will give the most representative modulus of deformation for a rock mass. But, how representative are the values obtained from an in situ static test vis-a-vis the value needed to account for the actual behaviour of a structure? An answer to this question is pursued here by undertaking the study of case histories.

For the concrete dams analysed, it is found that the overall modulus of deformation of the rock mass, that accounts for the measured structure behaviour, is 1.3 to 5.3 times greater than the static in situ test value. For the powerhouse analysed, these ratios vary from 1.0 to 4.5

ACKNOWLEDGEMENTS

The research described in this dissertation has been carried out at the Civil Engineering Department, University of Alberta, under the direction of Professor N. R. Morgenstern. The author would like to express his gratitude to Professor Morgenstern for having suggested the topic and for his sustained encouragement.

Acknowledgements are due to Dr. S. Rajasekaran and Dr. A. V. G. Krishnappa for their interesting discussions and suggestions during the project.

The author wishes to thank the National Research Council of Canada for awarding him a postgraduate scholarship in the first year of the project. Financial assistance from the Department of Civil Engineering is also appreciated.

The author presents his sincere acknowledgements to his family and friends for their encouragement.

Finally, the author is grateful to Mrs. S. D. Tolchard who has done a great job of typing the text.

TABLE OF CONTENTS

	Page
Release Form	(i)
Title Page	(ii)
Approval Sheet	(iii)
Abstract	(iv)
Acknowledgements	(v)
Table of Contents	(vi)
List of Tables	(x)
List of Figures	(xi)
CHAPTER I	INTRODUCTION
1.1	Rock Mechanics in Engineering 1
1.2	Behaviour of Engineering Structures 2
1.3	Complexity of the Problem 3
1.4	The Finite Element Method 4
CHAPTER II	DETERMINATION OF REPRESENTATIVE ROCK PROPERTIES
2.1	Introduction 6
2.2	The Different Tests Used and their Evaluation 8
2.2.1	The Plate Jacking Test 10
2.2.2	The Pressure Chamber Test 14
2.2.3	The Radial Jacking Test 16
2.2.4	The Thin Flatjack Test 19
2.2.5	Borehole Deformation Tests 22

TABLE OF CONTENTS (continued)

	Page
CHAPTER II (continued)	
2.3 Details of In Situ Test Data and Comparison of Results	25
2.4 Determination of Pre-Existing Stresses in a Rock Mass	28
2.4.1 The CSIR "Doorstopper"	29
2.4.2 Flatjack	31
2.4.3 Recent Developments in In Situ Stress Determination	32
CHAPTER III ANALYSIS OF CASE HISTORIES	
3.1 Introduction	33
3.2 Analysis of Dams	33
3.2.1 Boundary Conditions	33
3.2.2 Procedure Used in an Analysis	35
3.3 Analysis of Krasnoyarsk Dam	37
3.3.1 Introduction	37
3.3.2 Method of Investigation and Values Assumed for the Study	37
3.3.3 Results of Predicted and Measured Displacements	40
i) Gravity Analyses	40
ii) Gravity and Water Load Analysis	44
iii) Gravity and Water Load plus Assumption of a Crack in the Foundation Rock	50
3.3.4 Comparison of Actual Behaviour With Predicted	51

TABLE OF CONTENTS (continued)

	Page
CHAPTER III (continued)	
3.4 Analysis of Alpe Gera Dam	59
3.4.1 Introduction	59
3.4.2 Method of Investigation and Values Assumed for the Study	59
i) Hydraulic Chamber Test	59
ii) Jacking Test	61
3.4.3 Results of Predicted and Measured Displacements	64
i) Gravity Analysis	64
ii) Gravity plus Water Load Analysis (Assumption of a Crack below the Heel of the Dam)	67
3.4.4 Comparison of Actual Behaviour with the Predicted	71
3.5 Analysis of Bhakra Dam	81
3.5.1 Introduction	81
3.5.2 Method of Investigation and Values Assumed for the Study	83
3.5.3 Results of Predicted and Measured Displacements	88
i) Gravity Analysis	88
ii) Gravity plus Water Load Analysis (Assumption of a Crack below the Heel of the Dam)	88
3.5.4 Comparison of Actual Behaviour with the Predicted	101
3.5.5 Influence of Poisson's Ratio on the Final Result	102

TABLE OF CONTENTS (continued)

	Page
CHAPTER III (continued)	
3.6 Analysis of Underground Powerhouses	107
3.6.1 Boundary Conditions	107
3.6.2 Procedure Used in an Analysis	107
3.7 Analysis of Oroville Underground Powerhouse	111
3.7.1 Introduction	111
3.7.2 Methods of Investigation Used and Values Assumed for the Study	111
i) Deformability Characteristics	111
ii) In Situ Initial Stresses	114
3.7.3 Results of Predicted and Measured Displacements	115
CHAPTER IV CONCLUDING REMARKS	
4.1 The Deformability of Rock Masses	122
4.2 The Behaviour of Structures	130
LIST OF REFERENCES	132

LIST OF TABLES

Table	Page
2.2.1 Summary of some borehole deformation apparatus	23
3.3.1 Elastic tangent modulus of concrete versus time	41
3.3.2 Settlements measured on the dam versus time	49
3.3.3 Summary of results for the study of Krasnoyarsk dam	53
3.4.1 Results of moduli of deformation measured at Alpe Gera dam site	63
3.4.2 Overall horizontal and vertical modulus of deformation for depth of cracking = $0.3H$	79
3.5.1 Results of moduli of deformation measured by the jacking tests	85
3.5.2 Uplift pressures under the dam expressed as percentage of net head	94
3.5.3 Summary of final results	100
3.5.4 Values of Poisson's ratio measured in the field	103
3.5.5 Summary of the influence of Poisson's ratio on the final result	105
3.7.1 Summary of rock moduli measured at Oroville dam site	112
3.7.2 Summary of relative deformations for Oroville power plant	119
4.1.1 Variation of the modulus of deformation with depth	127

LIST OF FIGURES

Figure		Page
2.1.1	Representation of Moduli of deformation and Elasticity	9
2.2.1	L.N.E.C. Plate Jacking test	11
2.2.2	Dworshak dam plate jacking test	12
2.2.3	Hydraulic chamber test set-up	15
2.2.4	Yugoslavian radial jacking test	18
2.2.5	L.N.E.C. Thin flatjack test	21
2.3.1	Comparison of the modulus of deformation and modulus of elasticity from in situ static tests	26
2.3.2	Comparison of in situ test modulus and modulus computed from displacement observations of structures	27
3.2.1	Boundary conditions used in the analysis of a dam	34
3.3.1	Finite element mesh used in the study of Krasnoyarsk dam	39
3.3.2	Displacements of the dam due to gravity only for $E_{\text{concrete}} = 360,000 \text{ Kg/cm}^2$ and $E_{\text{rock}} = 100,000 \text{ Kg/cm}^2$	42
3.3.3	Displacements of the dam due to gravity only for $E_{\text{concrete}} = 470,000 \text{ Kg/cm}^2$ and $E_{\text{rock}} = 100,000 \text{ Kg/cm}^2$	43
3.3.4	Displacement ratio versus modulus of deformation ratio for the gravity analyses	45
3.3.5	History of impounding for Krasnoyarsk dam	46
3.3.6	Displacements of the dam for gravity and water loading. $E_{\text{concrete}} = 360,000 \text{ Kg/cm}^2$, $E_{\text{rock}} = 100,000 \text{ Kg/cm}^2$	48
3.3.7	Displacements of the dam for gravity and water loading plus assumption of a crack going down 1.0H into the foundation rock	52

LIST OF FIGURES (Continued)

Figure	Page
3.3.8 Difference in column elevations measured with a hydrostatic level	55
3.3.9 Total stress, water pressure and effective distributions based on the results of the gravity plus water load analysis	57
3.4.1 Section of Alpe Gera dam	60
3.4.2 Jacking test set-up	62
3.4.3 Finite element mesh used in the study of Alpe Gera dam	65
3.4.4 Displacements of the dam due to gravity only	66
3.4.5 Levelling measurements on dam crest and in the foundation	68
3.4.6 Displacements of the dam for a crack going 1.0H into the foundation rock	70
3.4.7 Deflection of block No. 9	73
3.4.8 (a) Rotation of the foundation (vs) Depth of cracking (b) Horizontal displacement of point 3c (vs) Depth of cracking	74
3.4.9 Displacements of the dam assuming no crack going into the foundation rock	75
3.4.10 Displacements of the dam for a crack going 0.3H into the foundation rock	76
3.4.11 Displacements of the dam for a crack going 0.6H into the foundation rock	77
3.5.1 Maximum spillway section	82
3.5.2 Hydraulic jacking test assembly	84
3.5.3 Finite element mesh used in the study of Bhakra dam	89
3.5.4 Displacements due to gravity only	90
3.5.5 Settlements of benchmarks	91

LIST OF FIGURES (Continued)

Figure	Page
3.5.6 Loading conditions on the dam and foundation after separation of the strut	93
3.5.7 Displacements of the dam for a crack going 0.35H into the foundation rock	96
3.5.8 Displacements of the dam for a crack going 0.15H into the foundation rock	97
3.5.9 Displacements of the dam assuming no crack into the foundation rock	99
3.5.10 Influence of Poisson's ratio on the overall modulus of deformation and on the $E_{\text{overall}}/E_{\text{measured}}$ ratio	106
3.6.1 Boundary conditions used in the analysis of an underground opening	108
3.7.1 Finite element mesh used in the study of Oroville underground powerplant	116
3.7.2 Relative position of extensometers for which displacements are quoted	117
3.7.3 Absolute displacements of the opening	120
4.1.1 Comparison of in situ test modulus computed from displacement observation of structures	125
4.1.2 Comparison of Young's modulus E derived from the plate tests and laboratory tests with values derived from full-scale tank test	128
4.1.3 Average horizontal stress as a function of depth	129

CHAPTER I

INTRODUCTION

1.1 Rock Mechanics in Engineering

In the past three decades, with the coming of large structures like mining excavations, dams, underground galleries etc., a need was felt to study in a more rigorous manner the properties of rock as a material and the properties of rock masses as well. The early developments of this newly born science, Rock Mechanics, were of course greatly influenced by Soil Mechanics which had already progressed substantially. Some unfortunate catastrophes made engineers look deeper, in particular, into the properties of rock masses. The importance of the projects involving the construction of some of the structures mentioned above led to the development of better instrumentation to characterize the rock mass.

Rock is the subject of studies from many different areas of science. This has brought engineers, geologists, mineralogists and geophysicists together. Today, it is recognized that to attempt to understand the peculiar behaviour of rock masses upon loading or unloading, the civil engineer has to be in close contact with the structural geologist.

The first two congresses of the INTERNATIONAL SOCIETY OF ROCK MECHANICS have contributed greatly in publicizing answers to different facets of the subject and they have also proved the need for pursuing the development of theories and tools that will

enable us to predict and understand the response of engineering structures involving the behaviour of rock masses.

1.2 Behaviour of Engineering Structures

The study of the behaviour of engineering structures can be pursued only if a good observation program has been undertaken. In turn, the quality of that observation program, on a long term basis, is wholly justifiable by the following three aspects:

i) Instrumentation will obviously strengthen the safeguards for public safety,

ii) Instrumentation will lead to a better understanding and improved design. A good observation program will often provide answers to possible anomalies in the behaviour of a structure. The experience gained by engineers over the years will undoubtedly enable them to avoid inefficient construction techniques and tend to a better optimization of the cost of the structure.

iii) The scientific aspect, which of course is indispensable if a better understanding of the behaviour of the rock mass and consequently, the behaviour of the structure, has to be attained.

In the following study, we are particularly interested by the scientific aspect which is not dissociated from the other two. It provides ways of judging the accuracy of the design hypotheses by interpreting the actual behaviour of the structure.

On the other hand, if the justification of a good observation program for long term conditions is made, it is certainly equally important, if not more, to follow very closely the behaviour of a structure, during and shortly after construction. It is in fact more important than the long term observation since at that time,

no experience has been gained in evaluating the limits of confidence with respect to the initial assumptions made.

The easiest way of obtaining an overall picture of the behaviour of a structure is by measuring displacements. This parameter is directly related to the value of the modulus of deformation determined at the design stage. It is the purpose of the present study to evaluate the accuracy of the modulus of deformation of the rock mass, determined from in situ static tests, in accounting for the displacements measured on the structure. Therefore, displacements will be our standpoint to judge if, whether or not, moduli of deformation determined by in situ static tests are capable of predicting the correct displacements and, if not, suggest possible reasons for this discrepancy.

In this work two particular types of engineering structures will be analyzed i.e. straight concrete gravity dams and underground powerhouses. It is obvious that a study of this type has to be statistical in that analyses of many structures of a same type should be performed if general conclusions are aimed at. By doing so, we actually include a variation of the variables affecting the behaviour of dams or powerhouses and try to find the common denominator to the behaviour of those structures.

1.3 Complexity of the Problem

The complexity which arises every time that an analysis of a structure involving rock has to be performed is a function of two major factors:

- i) the nature of the rock as a material and as a mass,
- ii) our difficulty in taking into account the influence

of faults, joints, schistosity etc., on the behaviour of structures.

Very often rock shows anisotropy either on a microscopic or macroscopic scale. Rock is non-homogeneous. Rock behaviour is time-dependent.

Up to 1960, no numerical method dared taking into account all or even some of the factors mentioned above. The mathematical solution would have been too complicated and difficult to apply by the average engineer.

The finite element method entered general use in 1960 after the work of Clough (1960). This very powerful method has increased in popularity ever since because of its versatility and capability of handling such problems as non-linear behaviour, anisotropy, non-homogeneity, time-dependency and many more. It is this method which will be used in the analysis of the dams and powerhouses considered here.

1.4 The Finite Element Method

It is not the purpose of this section to derive the method. Ample literature exists on this subject and may be referred to if information is needed. Some references are given in the bibliography.

The structure which is to be analyzed is divided into a certain number of elements, interconnected at their nodes. Properties are then assigned to these elements. Equations are established for every node in the mesh and each equation includes the influence of all the elements on a particular displacement at one node. Consequently, a set of simultaneous equations is formed, in terms of the nodal displacements, and represents the behaviour of the whole structure. The solution of these equations requires the

use of a computer. Once the displacements are determined for every node in the mesh, it is then possible to evaluate how much distortion or strain a particular element has undergone. This is done for all the elements. From there, knowing the stress-strain behaviour of the material or having made such an assumption, the conversion from strains to stresses is made for every element. We therefore obtain a complete picture, in terms of displacements and stresses, of the structure.

A finite element analysis can be performed either in two or three dimensions. We have said earlier that only straight concrete gravity dams and underground openings were going to be analyzed. Since these structures usually have a length bigger than their other dimensions, two-dimensional analyses can be performed on them. By doing so, many more analyses can be done which help us in evaluating the influence of various parameters.

Only linear elastic finite element analyses will be performed through this study. Generally, isotropy and homogeneity will be assumed. The reasons for working within the framework of linear elasticity are the following:

i) The conversion of in situ measurements of displacements, when doing a static test, to in situ modulus of deformation, is commonly done by using the theory of elasticity,

ii) It is conventional practice in Rock Mechanics to make use of linear elasticity in design,

iii) A linear elastic analysis is the simplest type of analysis one can use and if positive conclusions can be drawn from it, it then provides a very easy tool to use for further work.

CHAPTER II

DETERMINATION OF REPRESENTATIVE ROCK PROPERTIES

2.1 Introduction

It has been recognized, in the field of Rock Mechanics, that properties determined on rock samples in the laboratory usually overestimate the quality of the rock mass. The reason for this is the fact that the discontinuities of the rock mass are not represented in the core sample. Therefore, the only logical way of obtaining representative rock properties is to go to the field and measure them in place. Even then, the problem of finding representative properties is not entirely solved. Investigations of the behaviour of the rock mass itself are still needed.

The deformability of a rock mass is a function of the quality of the rock itself and of the characteristics of the discontinuities which will be affected by the load transmitted by the structure. In the case of a massive rock body, where discontinuities are almost absent, the properties of the intact rock will govern the deformation of the structure. When the opposite happens, for example a highly jointed rock mass, the joints will play the dominant role in the mode of deformation of the structure. Therefore, since rock masses are, in general, fractured determination of joint spacing, type of discontinuity, degree of weathering, etc. are of primary importance to the engineer who has to decide in which way represent-

ative rock deformability characteristics can best be obtained.

In every project of relative importance, a drilling program is included. After the drilling, logging of the cores and subsequent interpretation will lead to an overall picture of the quality of the rock mass. Deere (1966) has developed a method to describe quantitatively the quality of a rock mass. This method makes use of all the core borings done at the investigation stage. The method is called Rock Quality Designation (RQD) and consists of measuring the total length of all unweathered pieces of core greater than or equal to 10 cm. (4 inches) and dividing the total by the length of the particular core run. This index represents an average quality of a rock mass and other properties might be related to it. It is with this idea in mind that Deere et al. (1969) have investigated the possibility of the existence of such relationships. All the discontinuities of a rock mass will affect its deformability. The RQD being a measure of the continuity of the body, the above investigators have shown that a correlation between the modulus of deformation and the RQD existed. Consequently determination of the RQD will help estimating the competence of a rock mass.

Different tests can be performed on the rock to determine its deformability. Since static loading represents more closely the way rock masses are loaded by the structures we are studying, we will concern ourselves with in situ static tests. It is also legitimate to think that they are the ones which will give us the most representative modulus of deformation for the rock mass. We are not excluding dynamic tests from a testing program. They may very well be performed and their results can certainly be very helpful in zoning a

rock mass.

In situ static tests are expensive and time-consuming. For these reasons the determination of the site where the test will be performed is very important. All of the above tools mentioned, like core logging, RQD, dynamic tests will help the engineer in deciding which volume of the rock mass is likely to have the most critical deformability characteristics with respect to the stability of the structure.

In the following, a description of the most important in situ static tests and their evaluation will be given. Also, it is to be noted that the same terminology used by Deere et al. (1969) will be used all through this work. The modulus of deformation will be the one represented by E_{1-2} on the load-deformation curve shown in Fig. 2.1.1. This modulus corresponds to the maximum load and total deformation. The modulus of elasticity will be the one shown as E_{2-4} on the unloading curve.

2.2 The Different Tests Used and their Evaluation

For the past twenty years a great deal of work has been devoted to increasing the quality of in situ static tests. In the following, we will describe plate jacking tests, pressure chamber tests, radial jacking tests, thin flatjack test and borehole deformation tests. The first two have been performed almost systematically ever since the undertaking of large projects. The radial jacking test constitutes a second phase in the evolution of deformability testing equipment. Finally, the thin flatjack test seems to be the latest development with respect to large in situ static test. The borehole deformation tests will also be looked at.

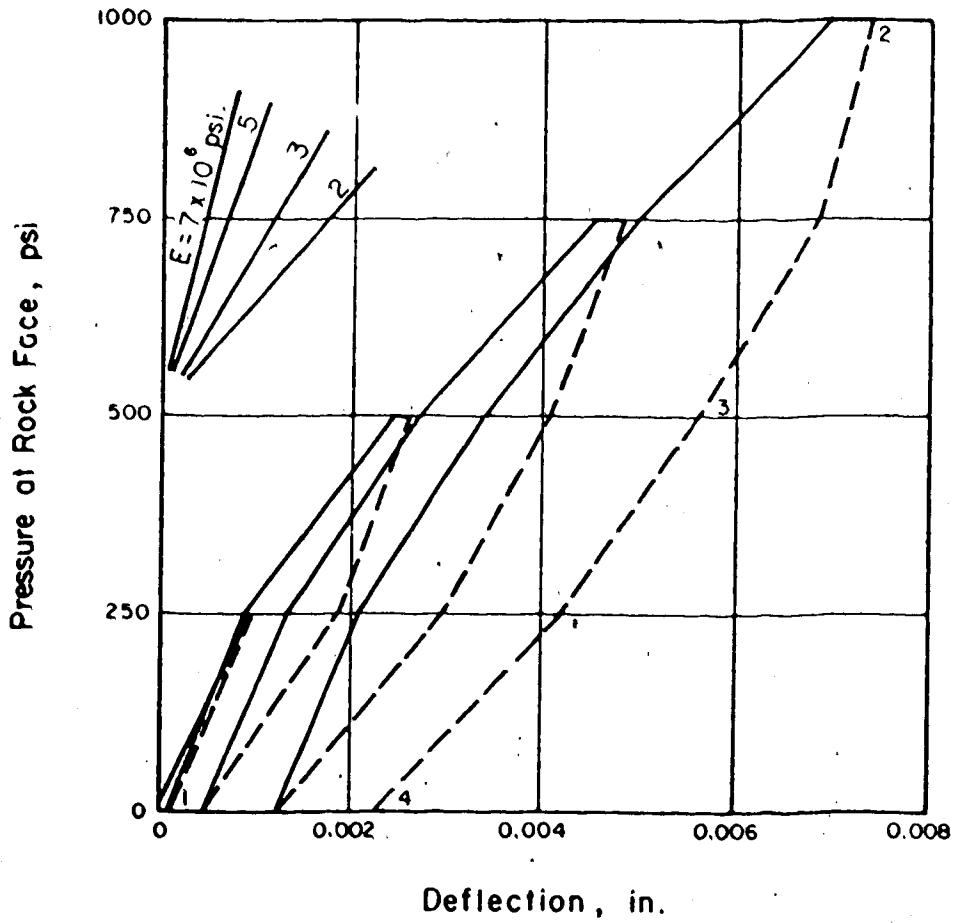
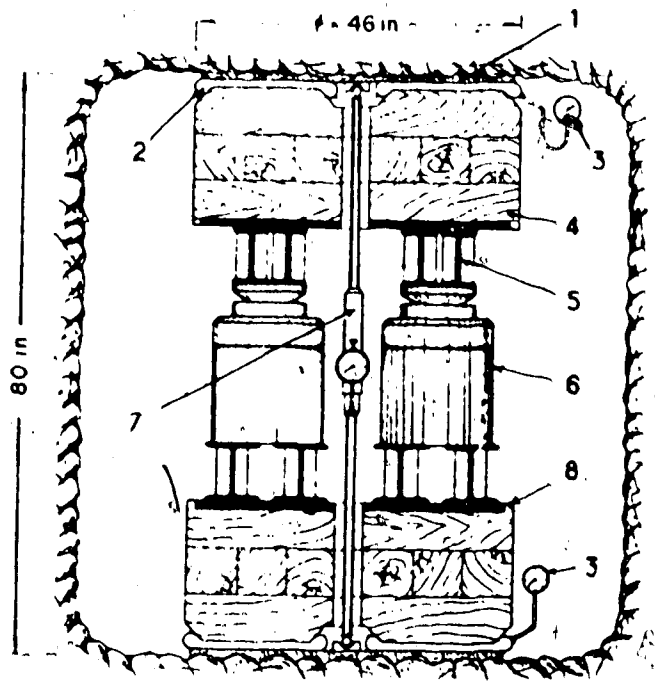

FIG. 2.1.1 REPRESENTATION OF MODULI OF DEFORMATION AND ELASTICITY. (FROM DEERE ET AL., 1969)

2.2.1 The Plate Jacking Test

The plate jacking test is certainly one of the oldest methods for determining the deformability of rock. We have to distinguish here between two different ways of performing this test. The first one uses a rigid plate and the second one a flexible pad to apply the load to the rock mass. Kujundzic (1955) calls the former a punch test or uniform deformation test and Serafim (1964) calls the latter a uniform pressure test. The punch test has almost completely disappeared in current practice due to the complex state of stress it induces in the rock mass and to the relatively small volume of rock affected by the test. Serafim (1966) says that punch tests seem adequate when performed on a non-fractured rock mass or on an extremely fragmented or very altered rock mass. Since geologic conditions of most rock masses are more likely to be within these limits, the uniform pressure test is undoubtedly preferable. Rocha (1955) has inserted between the reaction system of the plate jacking test and the mortar pad applied on the rock surface, oil-filled metallic cushions. This set-up is shown on Fig. 2.2.1. For the rock foundation testing of Dworshak dam, Shannon and Wilson (1964) have developed a uniaxial apparatus which is worth elaborating on. The set-up is shown on Fig. 2.2.2. This apparatus included some very special features. Firstly, Freyssinet jacks were used to load the rock mass. At the same time that loading was performed, uniform pressure on the mortar pad was insured due to the flexibility of the jack itself. Secondly, since information is needed about the creep behaviour of the rock, a pressure recorder-controller device was fixed to the flatjack. As the rock was deforming, constant pressure in the jack was maintained



- (1) Mortar
- (2) Oil Filled Metallic Cushions
- (3) Pressure Gauges
- (4) Timber Packing
- (5) H- Section Irons
- (6) Hydraulic Jack
- (7) Extensometer For Measuring Changes In Distance
- (8) Iron Plate

FIG. 2.2.1 L.N.E.C PLATE JACKING TEST
(AFTER ROCHA, 1955) (FROM
DEERE ET AL., 1969)

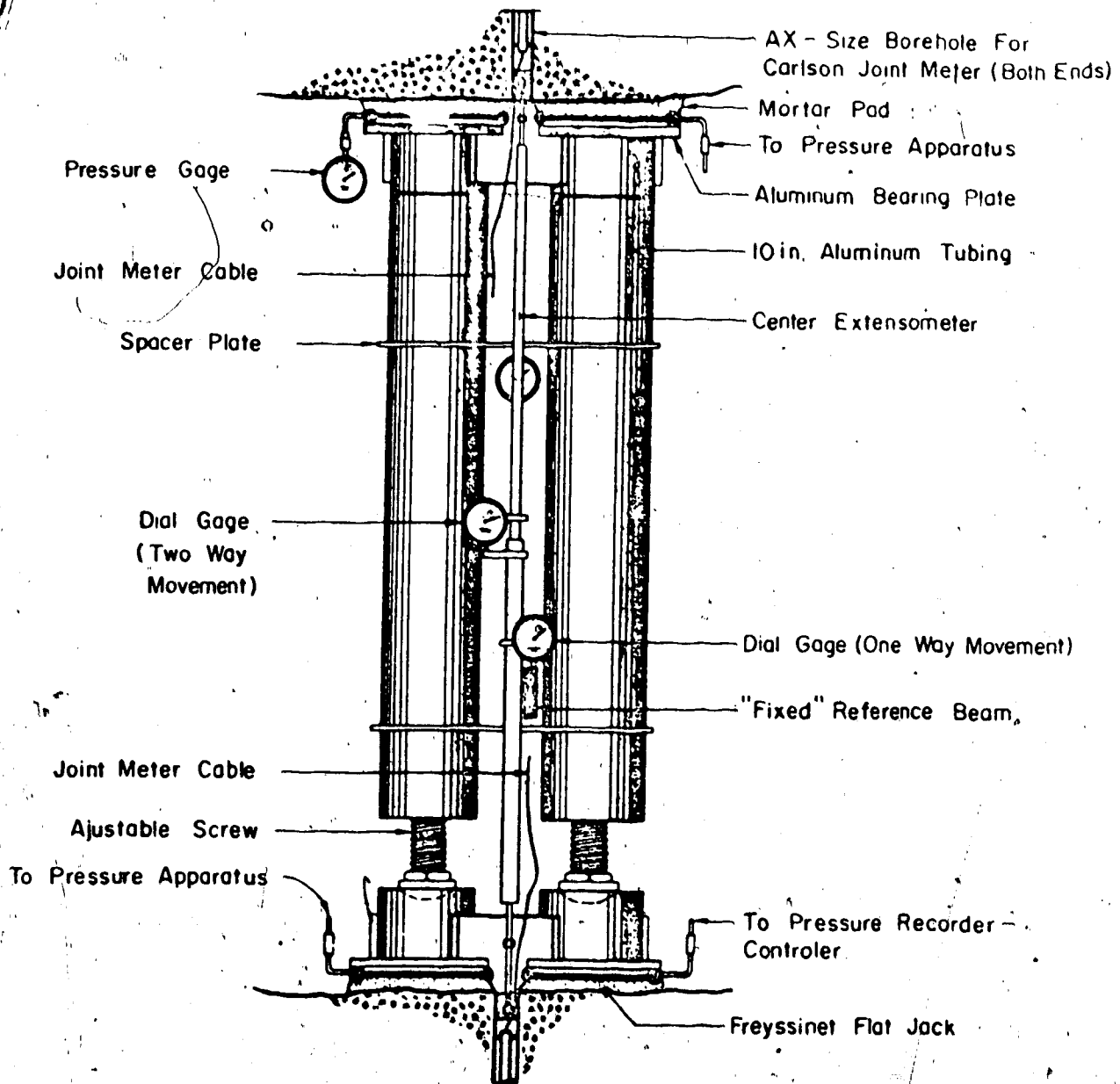

FIG. 2.2.2 DWORSHAK DAM PLATE JACKING TEST (AFTER SHANNON AND WILSON, 1964) (FROM DEERE ET AL., 1969)

by the use of a hydraulic pump. Thirdly, the way deformations were measured is of particular importance. As shown in Fig. 2.2.2 AX size boreholes were drilled at both extremities of the apparatus and Carlson jointmeters were installed in them. The jointmeter usually extended to a depth of 5.5 m. (18 feet) from the face of the gallery and consequently allowed for the measurement of an average deformation for a large mass of rock. The usual diametral extensometer was also used.

The U.S. Bureau of Reclamation had at the same time developed a very similar apparatus as the Shannon and Wilson one. Wallace et al. (1969) give a good description of it. The main difference is in the way deformations were measured. The principle is the same but more information is obtained by the U.S. Bureau test. Rock deformations were measured by a diametral extensometer and two seven positions retrievable extensometers (REX-7P). The diametral extensometer, as well as the REX-7P were installed directly underneath the loaded surface. For this arrangement, small holes were provided in the middle of each flatjack. The retrievable extensometers were fixed in a 6 meters long NX hole and deformations were measured between every one of them and the collar of the hole. The measuring device consisted of seven linear variable differential transformers (LVDT). This way of measuring deformations has proved to be extremely useful.

It is known that whenever a gallery is excavated, the initial state of stress in the rock mass is disturbed. This produces a so-called "distressed zone" (Deere et al., 1969) around the opening which influences greatly the deformability measured by an in situ test.

Benson et al. (1969) quote for one test in particular that 33% of the total deformation between 0 and 4.6 meters (15 feet) from the rock surface had occurred in the first meter. Therefore, it is advisable to measure deformations in depth from the rock surface in a test adit. This will obviously lead to a more representative value of the modulus of deformation of the rock mass.

In brief, it is suggested that the best quality in situ plate jacking test that can be performed now on a rock mass is one of the same type as the U.S. Bureau of Reclamation test. The aluminum tubing makes the apparatus light enough for easy transportation; the Freyssinet flatjacks arrangement fulfills a triple purpose and finally the deformation measuring device provides a better picture of the rock mass behaviour.

2.2.2 The Pressure Chamber Test

The pressure chamber test is one of the largest in situ tests performed on a rock mass. For this reason, this test is used much less frequently than the other in situ static tests. However, the importance of a project together with the rock conditions at a site can easily justify its use. Loading a very big volume of rock, this test will be of particular interest when a large joint spacing characterizes the rock mass to be tested. Figure 2.2.3 gives the usual set-up for the pressure chamber test.

Application of the pressure on the rock mass is achieved by filling the chamber with water. From this comes one of the most delicate problems of the test, to assure the water tightness of the chamber. In some of the earlier pressure chamber tests performed (Kujundzic, 1955), water pressure was directly applied to the rock

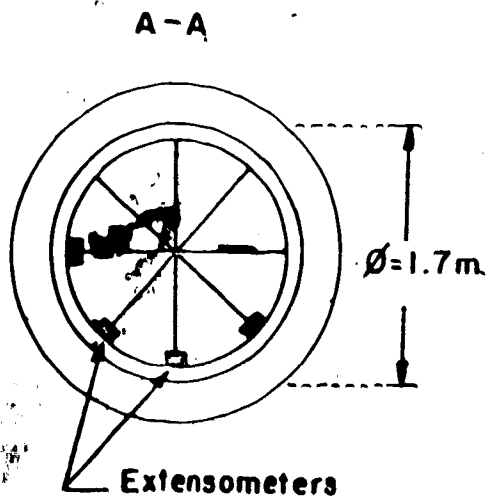
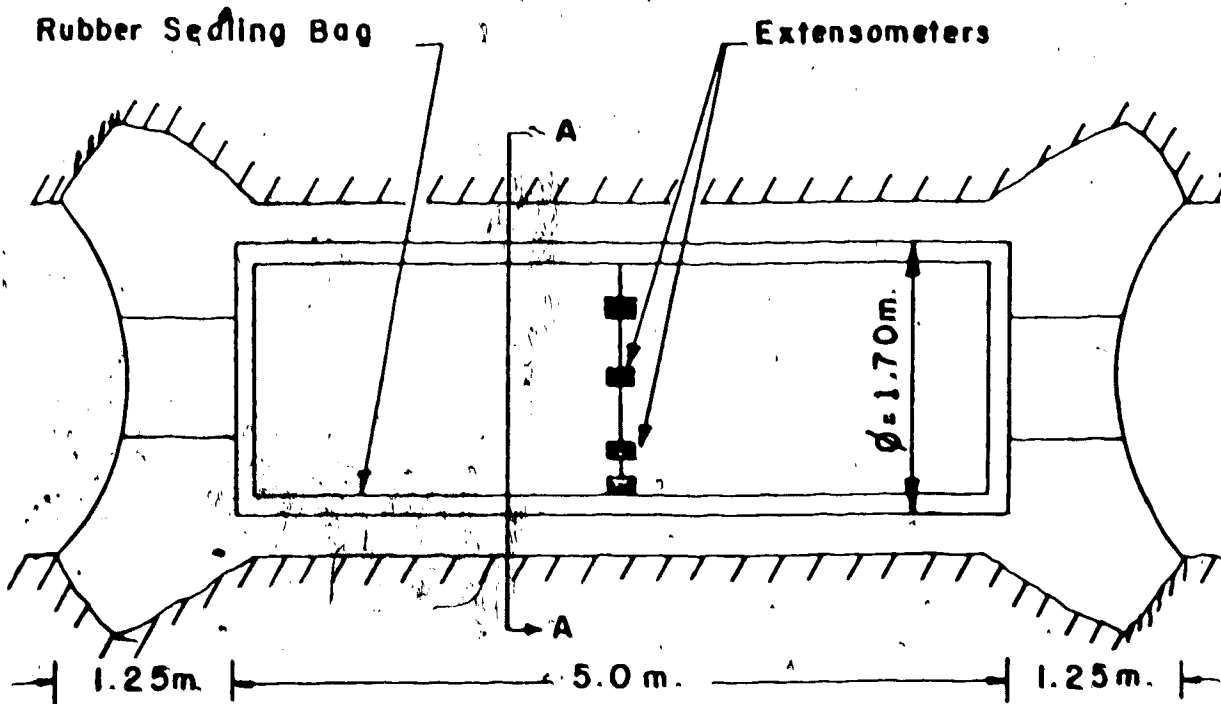

FIG. 2.2.3 HYDRAULIC CHAMBER TEST SET-UP

surface. The amount of water collected after the test was then used to estimate the permeability of the rock. Rocha (1955) has used bituminous material as an impermeable liner. Italian engineers seem to be the ones who have used this test the most extensively. Figure 2.2.3 was based on the usual set-up used in Italy. As seen on this figure, water leakage was prevented by using a rubber sealing bag. A concrete lining with transverse and longitudinal joints was also used between the rock surface and the sealing bag.

In the pressure chamber test, deformations are often measured at the middle section of the chamber. This has for effect to minimize the influence of the extremities of the loaded area. The deformation measuring system usually consists of extensometers installed on four different diameters, one being vertical, another horizontal and the others at 45° to the first two. Usage of buried deformation gages, for the pressure chamber test, has not been found in the literature but it is expected that they have been used in the latest tests. The advantages of using these gages have been discussed previously.

To summarize, if provision is made for measurement of deformations at depth, from the rock surface, the pressure chamber test is likely to give the most representative rock modulus of deformation.

2.2.3 The Radial Jacking Test

The radial jacking test is a combination of a plate jacking test with a pressure chamber test. On one side, it uses the relatively simple mounting procedure of the plate jacking test and on the other benefits of the large volume of rock loaded by the pressure chamber.

The first radial jacking apparatus was developed by the Hydrological Institute of Belgrad (see Kujundzic, 1955). Although almost twenty years old, the test had much similarity with the one performed today. Figure 2.2.4 shows schematically the different characteristics of the test set-up. As seen on the figure, the gallery had a diameter of 2.20 meters. The load was applied on a concrete lining by sixteen flatjacks having a length of 1.85 m. each. The inside face of the jacks was fixed to cylindrical wooden reaction system. Transmission of pressure to the flatjacks was obtained by manually pumping water into them. The deformations were measured at five different sections, three of which were directly under the influence of the flatjacks. At each section, the deformation measuring device consisted of four extensometers making 45° angles between them. Finally the interpretation of the deformation results accounted for the fact that the test had a small LENGTH/DIAMETER ratio.

The radial jacking test has also been used extensively, for the design of pressure tunnels, by Tiroler Wasserkraftwerke, A. G. (TIWAG) in Austria. The apparatus they have used was basically equivalent to the Yugoslavian one but a few modifications were needed. Lauffer and Seeber (1961) give a short description of the Austrian apparatus. Since high internal pressure can be applied on the rock surface in pressure tunnels, the main changes consisted of re-designing the reaction system of the apparatus. Strong hardwood planks and ring supports of high-tempered steel were used. Those modifications then allowed for the application of stresses in the order of 60 Kg/cm^2 . The other features of the test with respect

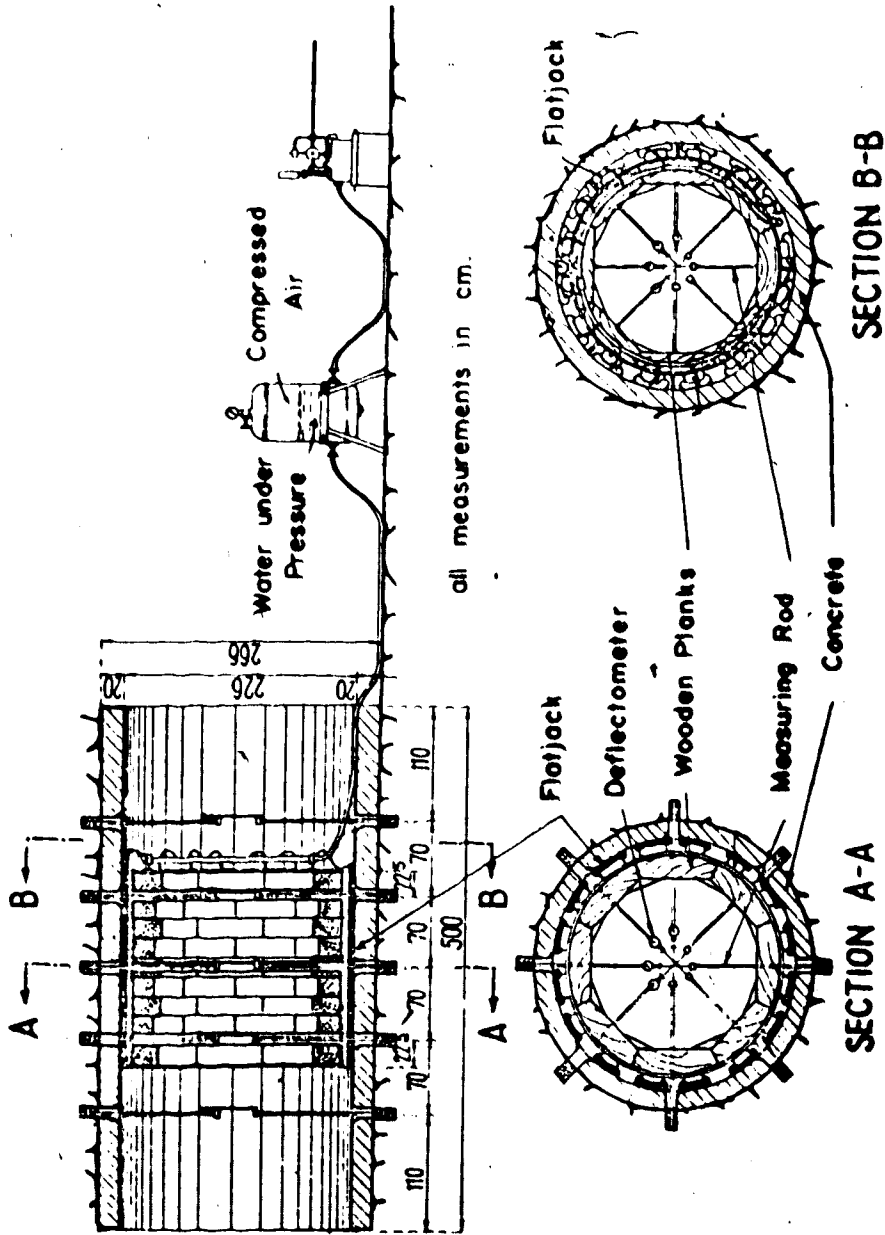

FIG. 2.2.4 YUGOSLAVIAN RADIAL JACKING TEST (FROM KUJUNDŽIĆ, 1955)

to the ones described by Kujundzic (1955) seem to be very similar.

The U.S. Bureau of Reclamation has also developed its own radial jacking test. Wallace et al. (1969) describe the Bureau test. Again, it resembles the first two tests mentioned above with one very important difference: deformations are measured in depth from the rock surface to eliminate the effect of the distressed zone surrounding the excavated gallery. Measurement of diametral deformations of the gallery is also provided. This way, depending on the problem which has to be solved, i.e. the design of a pressure tunnel or a surface structure, the corresponding deformations are used to evaluate the modulus of deformation of the rock.

The radial jacking test, as it is performed today, is certainly the best optimization one could have attained from the plate jacking test and the pressure chamber test. As we said earlier, the assembly is relatively simple; the test loads a large volume of rock; the test area is accessible to the operators; all of the equipment is recoverable. On the other hand, the cost of such a test is high.

2.2.4 The Thin Flatjack Test

The thin flatjack test has been developed mainly by the Laboratorio Nacional de Engenharia Civil (LNEC). The procedure used in performing the test is as follows (Rocha et al. 1970).

i) a diamond disc saw of diameter d is used to open one or a group of slots, contiguous and in the same plane perpendicular to the rock surface, having a depth h and a thickness t ,

ii) thin flatjacks of height $(h - a)$ are then introduced in each slot,

- iii) a pressure p is applied to the flatjacks,
- iv) deformation of the slot is measured by four deformeters inserted in each flatjack,
- v) reduction of deformations to modulus value is made through diagrams.

A representation of three thin flatjacks inserted in the rock is given in Fig. 2.2.5.

Like the other in situ static tests, the thin flatjack test will vary with the nature of the rock and the spacing of the joints. Rocha (1969) has shown the relative decrease of the modulus of deformation by extending the length of the slot.

In general, the thin flatjack test has proved to be of a good quality to determine the modulus of deformation of a rock mass. The apparatus can be taken in a gallery and can measure representative properties providing the slot is cut to a depth beyond the distressed zone. Preparing and performing the test is done relatively quickly and at a much lower cost than the first three tests mentioned previously.

It is felt that the important weakness of this method is in the interpretation of the deformation results. Rocha et al. (1970) have assumed that the rock mass was cracked in the plane of the slot thus allowing them to represent the test by a quarter-space under pressure p . They have developed a special technique to interpret the thin flatjack results and suggested that care should be taken when performing the test in a region of high compressive stresses perpendicular to the slot. It would then be advisable to enlarge the size of the slot all-around the proposed loading area.

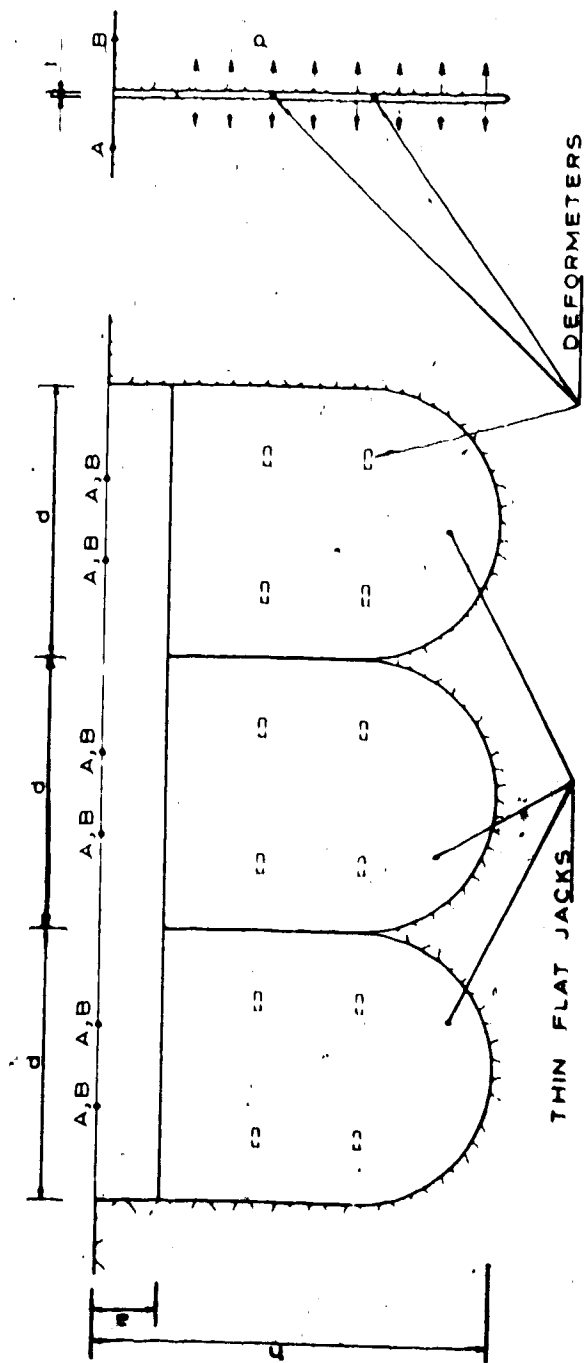

FIG. 2.2.5 L.N.E.C. THIN FLATJACK TEST (FROM ROCHA AND DA SILVA, 1970)

2.2.5 Borehole Deformation Tests

When the size of a project will be such that the use of a large in situ static test will not be justified, borehole deformation tests may be used for determination of the modulus of deformation. Table 2.2.1 enumerates some of the borehole tests used and gives some characteristics of each.

As can be seen, the borehole deformation tests are divided into two major groups depending upon whether transmission of load to the rock is done through a rigid or flexible component. The main differences between the two groups are the following:

i) Usually a higher stress level will be attainable when using a rigid apparatus,

ii) the non-uniformity of the state of stress induced by the rigid test into the rock mass will be more pronounced than for the flexible test,

iii) although possible in the case of a flexible test, cracking of the rock will be more probable when using a rigid apparatus.

iv) for equal size tests and for an equal average applied stress, a smaller volume of rock will be loaded by the rigid apparatus than by the flexible one.

The first two items, will be partly responsible for cracking of the rock. Moreover, the theory of elasticity says that a radially applied pressure in a hole will induce a tensile tangential state of stress around it.

Cracking around the borehole for a flexible test also has to be included in the interpretation of the results. Rocha et al.

TABLE 2.2.1
SUMMARY OF SOME BOREHOLE DEFORMATION APPARATUS

Type of Borehole Test	Rock-Apparatus Contact	Length (cm)	Diameter (cm)	Size of Hole	Maximum Possible Pressure (Kg/cm ²)	Deformation Measuring Device	Pressure Application Device	Particularities
Goodman Jack (USA)	Rigid	122	7	NX { 3 in. (76mm.) }	700	LVDT*	Two Steel Plates	Factor to account for fissuration of rock Interpretation: Plane Strain
USBM Cylindrical Pressure Cell (USA)	Rigid	20		EX { 1 1/2 in. (38mm.) }	500	Fluid Volume Meter	Expansion of a Copper Shell under pressure of a cell	Evaluates Modulus of Rigidity
CEBTP Apparatus (France)	Rigid		74			Induction Extensometer	Rubber Bags inserted in Split Hollow Steel Cylinder	
Menard Pressuremeter (France)	Flexible	100		NX { 3 in. (76mm.) }	105	Fluid Volume Meter	Rubber Membranes	Can also fit BX, AX, EX Holes Used mainly in Soils and Soft Rocks
LNEC Borehole Dilatometer (Portugal)	Flexible	88	7.4	NX { 3 in. (76 mm.) }	150	LVDT at four sections along bore-hole	Rubber Jacket	Can go 200m. Deep Operative under water Fissuration of Rock Is accounted for
Janod-Mermin Apparatus (France)	Flexible	76	16.5		250	Extensometers	Aluminum Sleeve on Rock Surface Pressurized by Water	
Sounding Dilatometer (Yugoslavia)	Flexible	102-120	20-30		42-70	Volume Meter or Extensometers	Rubber Envelope	

*LVDT: Linear Variable Differential Transformers.

(1966) have discussed of cracking around the borehole and have included its effect in their evaluation of the modulus of deformation.

With respect to the volume of rock tested, we have said that the flexible borehole test would load a larger volume than the rigid one. Even then, interpretation and experience will tell if whether or not the rock conditions involved in the flexible test are representative of the whole rock mass. Extreme care has to be taken in that direction since totally erroneous values could be used for design purposes.

The method of drilling the borehole, especially in soft rocks, may influence the result. Meigh and Greenland (1965) give some values of the modulus E measured with the Menard pressure-meter in a sandstone deposit. For the drilling of one borehole, a non-coring water-flush technique was used. For two other boreholes, a drag bit with air-flush and a thin-walled diamond coring bit with water-flush were used. The results presented show that the moduli measured in the boreholes drilled with the non-coring water-flush technique are consistently lower than when using either one of the other methods mentioned. That is to say, the substantial amount of water used during drilling, in the first case, has probably resulted in some softening of the material around the hole.

2.3 Details of In Situ Test Data and Comparison of Results

Up to 1966, data on static in situ tests have been collected and presented in a report by Deere et al. (1969). This has been extended here to 1973. The data are presented in Fig. 2.3.1. Comparison of the modulus of deformation and the modulus of elasticity is made in that figure. As can be seen the newly collected data agree relatively well with the line suggested by Deere et al.

In the same report mentioned above, the investigators have compared some in situ moduli to an overall modulus of deformation computed from displacement observations of structures. In the period going from 1967 to 1973, only two cases were found where the same comparison could be made. Figure 2.3.2 shows the points plotted by Deere et al. (1969) together with the earlier ones. Even if only a few points are plotted on that graph, a very interesting feature emerges. Most of the points representing static in situ tests, except two, are lower than the 1:1 line. This means that if designers have used those moduli values, determined by the static in situ tests, a conservative design has resulted. No comment has been given by Deere et al. with respect to the highest point which corresponds to a plate jacking test. On the other hand, Kleiner and Acker (1971) describe the different characteristics of the rock mass at Mossyrock dam site in Washington state, U. S. A. The point on the 1:1 line corresponds to a plate jacking test performed on a massive andesite. As suggested by the authors, the agreement of the modulus determined by the large scale in situ static test with the one computed from the displacement measurements, is probably due to the natural massiveness of the rock body of Unit B.

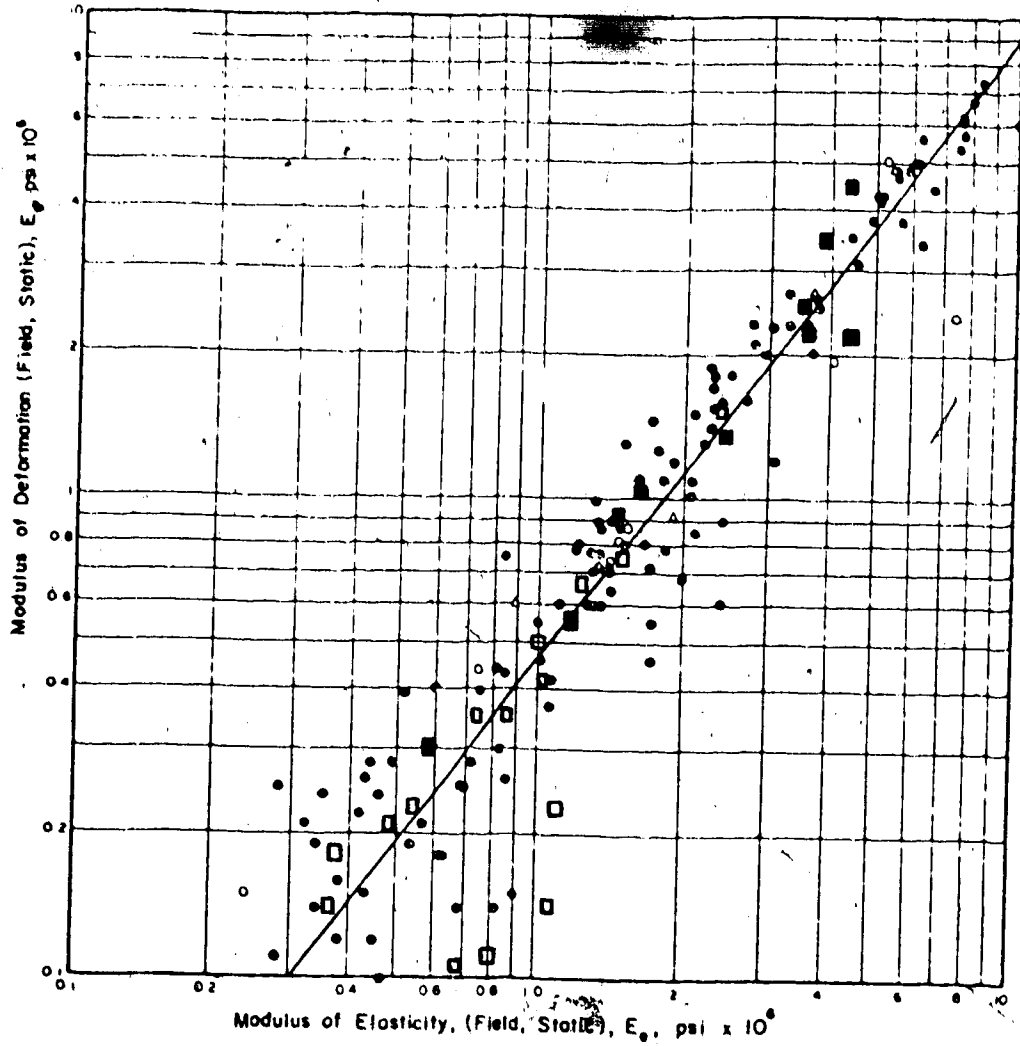

PLATE JACKING TEST •	PLATE JACKING TEST □
RADIAL JACKING TEST ○	RADIAL JACKING TEST ■
BOREHOLE DEFORMATION TEST △	
(UP TO 1969)	(1969 TO 1972)

FIG. 2.3.1 COMPARISON OF THE MODULUS OF DEFORMATION AND MODULUS OF ELASTICITY FROM IN SITU STATIC TESTS (FROM DEERE ET AL., 1969)

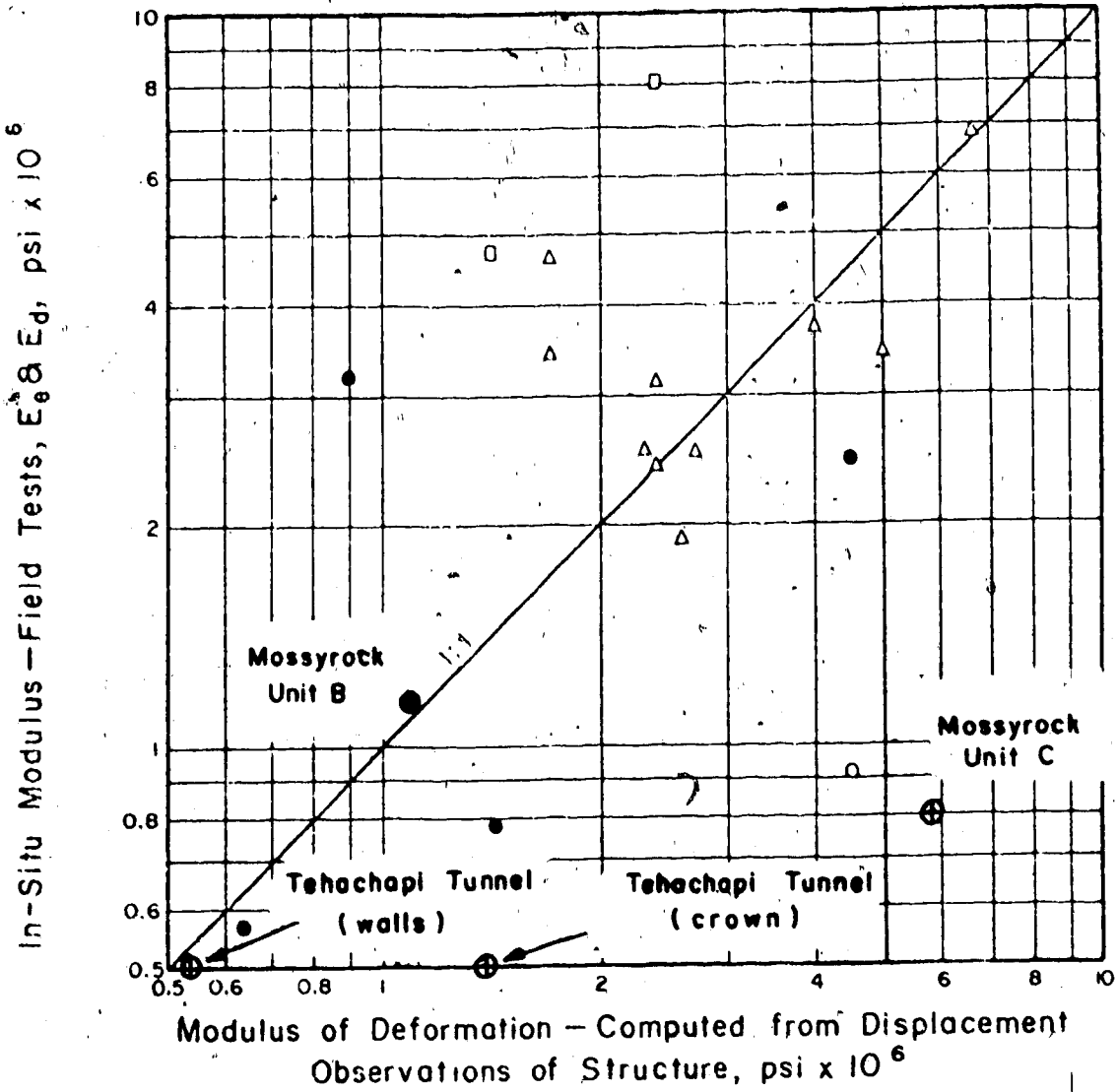

PLATE JACKING TEST ● PLATE JACKING TEST ⊕
 PRESSURE CHAMBER TEST ○
 BOREHOLE DEFORMATION TEST △
 SEISMIC TEST □

(UP TO 1969) (1969 TO 1972)

FIG. 2.3.2 COMPARISON OF IN SITU TEST MODULUS AND MODULUS COMPUTED FROM DISPLACEMENT OBSERVATIONS OF STRUCTURES (FROM DEERE ET AL., 1969).

The points representing the moduli at Tehachapi Tunnel, in California, were compared to a modulus obtained by the tunnel relaxation method. This method is described by Kruse (1969).

On very few cases a comparison has been made between the in situ static modulus and the one to account for the measured deformations. For the cases studied previously we see that the behaviour of the structures involved correspond to an overall modulus higher than the one measured by static in situ tests. This fact supports the concept of the study undertaken herein.

2.4 Determination of Pre-Existing Stresses in a Rock Mass

Knowledge of the natural state of stress in a rock mass is absolutely necessary when dealing with underground openings. Furthermore, if a better understanding of the behaviour of the earth's crust is of interest, determination of the natural state of stress in rock masses is mandatory.

In the past two decades extensive work in developing equipment capable of measuring the natural state of stress has been carried out. Obert (1966) has summarized the principal methods used. New developments were presented at the International Symposium on the Determination of Stresses in Rock Masses, held at Lisbon in 1969. No significant improvement has taken place since. Then, the following is based mainly on the above two references.

In the determination of the natural state of stress in a rock mass one has to distinguish between two major groups of methods: the direct method, i.e. a method in which a stress is measured and the indirect method which makes use of the elastic properties of the material to obtain the state of stress. In the first category we have

rigid inclusion stress gauges and flatjacks. The second group consists mainly of displacement measuring devices and strain measuring devices. It is not the purpose of this section to describe all of these instruments. The two references mentioned above should be referred to if detailed information is needed. However, the following will give a short description of one instrument belonging to each group. Also discussion of the latest developments is presented.

2.4.1 The CSIR "Doorstopper"

In 1965 the South African Council for Scientific and Industrial Research undertook the development of a rock stress measuring device. Commercially available since 1968, the CSIR "Doorstopper" has already been used all over the world.

The "doorstopper" has been designed to determine the absolute stress in rock, using an overcoring stress relieving technique. The method is therefore an indirect method. Performance of a "doorstopper" rock stress measurement is as follows:

i) a BX borehole is drilled to the required depth and its end is flattened and polished with diamond tools,

ii) with an installing tool the "doorstopper" strain cell is bonded on to the end of the borehole and initial strain readings are recorded,

iii) the borehole is then extended with a BX diamond coring crown resulting in a stress relieving of the core,

iv) after overcoring, final strain readings are taken and removal of the core and "doorstopper" is done,

v) knowledge of the elastic constants of the rock, when overcored (see Benson et al., 1970) will allow for the determination of

the stresses present on the flat end of the borehole before overcoring,

vi) a relation exists between the above determined stresses and the stresses of the surrounding rock. Use of this relation permits the calculation of the surrounding stresses. Different relations have been summarized by Leeman (1969).

Rock stress determination with the "doorstopper" can be done in one or three boreholes. If the measurement is performed in one borehole, it is implicitly assumed that the borehole axis is parallel to a principal stress. Consequently, the flat end of the borehole is a principal plane and the problem is reduced to a two-dimensional one. In the case where the validity of such an assumption can be questioned, three different boreholes need to be drilled in order to determine the complete state of stress at a point.

In item 5 above, we see that the elastic constants of the rock are needed. A "hydraulic assimilator" (see Leeman, 1969) has been developed with which it is possible to calculate the state of stress acting around the flat end of the borehole before being overcored. The important feature of using this assimilator is that the elastic constants of the rock are not needed. In brief, the "hydraulic assimilator" loads the core, with the "doorstopper" glued on it, in such a way as to restore the initial strain readings. The load needed to do so is directly related to the principal stresses acting around the flat end of the borehole.

The reliability of rock stress measurements with the "doorstopper" seems to have been proved (Heerden, 1968). However the stresses measured locally on a small piece of core need not be representative of the stresses in the mass at a larger scale.

2.4.2 Flatjack

As mentioned previously, the flatjack technique is referred to as a direct method of rock stress measurement. Determination of the stresses with the flatjack method is done in a gallery excavated in the rock body. As is well known, the excavation of the gallery together with blasting will greatly influence the state of stress of the rock, in the vicinity of the opening. Therefore, stresses measured with the flatjack technique, which is performed close to the rock surface in a gallery, will not represent the state of stress of the rock away from the zone of disturbance. As underlined by Rocha (1969), measurements of the state of stress close to the rock surface by the flatjack method will be applicable to tunnel-driving methods, tunnel maintenance and tunnel-lining design and construction.

In principle, the flatjack method consists of:

- i) fixing references (vibrating wire gages, steel pins, strain gages, etc.) on the rock surface of an adit,
- ii) taking initial readings (frequency of the wire, distance between pins, initial strains, etc.),
- iii) making a slot in the rock mass, close to the references, and inserting a flatjack in the slot,
- iv) pressurizing the flatjack so that the initial readings are recovered.

The pressure necessary to reach "cancellation" is then considered as the natural stress of the rock mass, perpendicular to the flatjack. The stress found by the flatjack technique is an average stress acting over the relatively large area of the flatjack. For this reason, the flatjack technique is rather insensitive to local

concentration of stresses.

2.4.3 Recent Developments in In Situ Stress Determination

In the last ten years, two different organizations have developed a technique by which the complete determination of the in situ state of stress could be obtained in a single borehole. LNEC worked on a plastic cylinder in which an assembly of electrical strain gauges was embedded. The CSIR built a triaxial cell capable of measuring strains with three rosettes at a specific relative orientation.

Undertaking a measurement with these two methods is basically the same. It consists of an overcoring technique. The LNEC plastic cylinder can measure initial as well as induced states of stress in the rock mass. The CSIR triaxial cell is capable of measuring the initial state of stress only.

Further details are given in Rocha and Silverio (1969) and Leeman (1969).

CHAPTER III

ANALYSIS OF CASE HISTORIES

3.1 Introduction

Generally, the selection of case histories in this study was based on the following requirements:

i) results of in situ static deformation tests had to be available,

ii) loading on the dam or in situ rock stresses had to be known or estimated,

iii) the deformation behaviour of the structure considered had to be given.

On this basis three dams and one underground powerhouse were selected for analysis.

3.2 Analysis of Dams

The three dams that are to be analyzed are Krasnoyarsk dam in East Siberia, Alpe Gera dam in Italy and Bhakra dam in India.

3.2.1 Boundary Conditions

In the boundary conditions we will consider the mesh dimensions, the displacements boundary conditions and the loading boundary conditions. All of these items are shown in Fig. 3.2.1.

If H is the height of the dam, the boundaries of the finite element mesh were as follows:

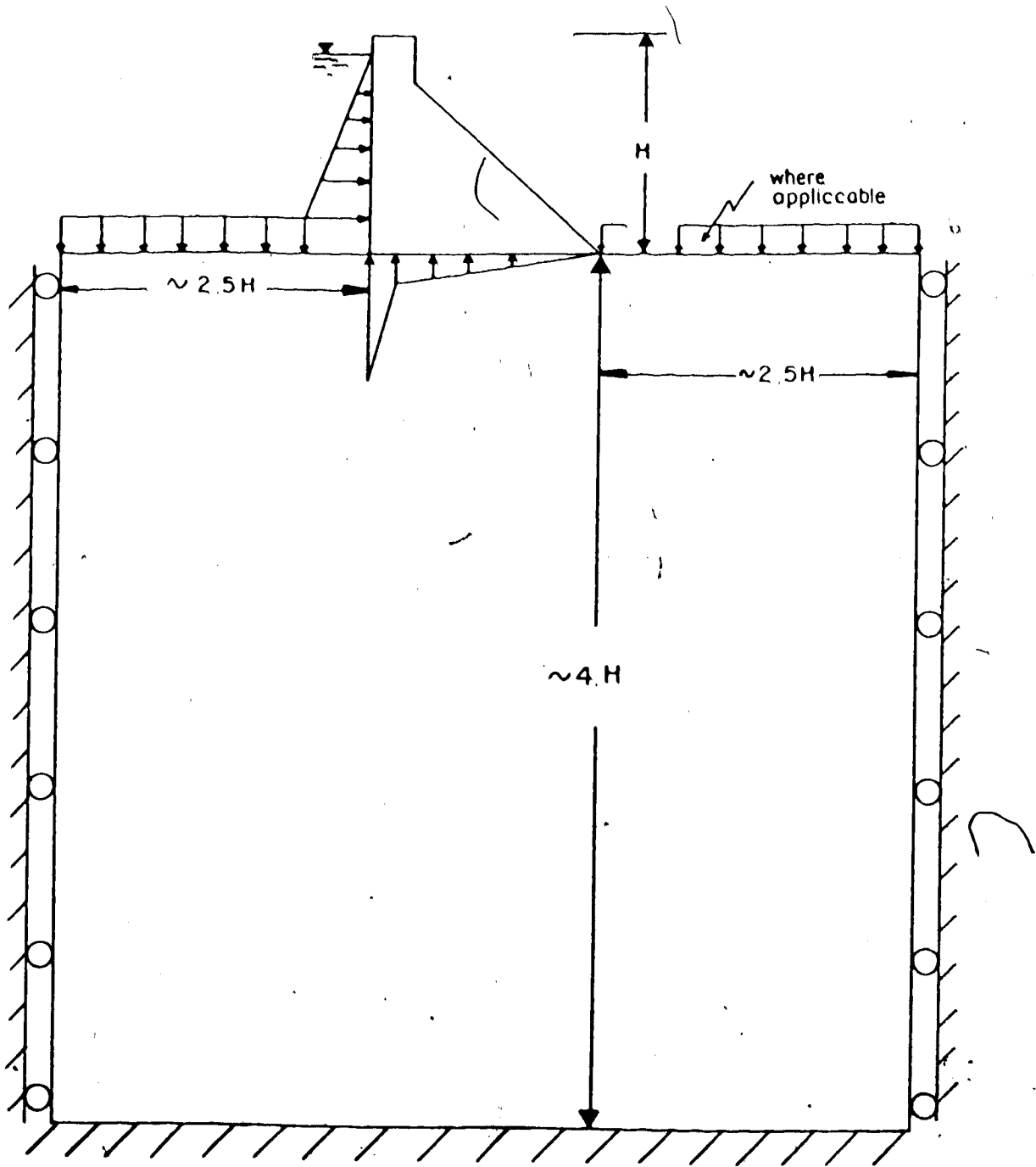

FIG. 3.2.1 BOUNDARY CONDITIONS USED IN THE ANALYSIS OF A DAM.

i) the vertical sides of the mesh were set approximately $2.5H$ downstream of the toe and upstream of the heel,

ii) the bottom boundary of the mesh was about $4.0H$ below the base of the structure.

On the vertical sides of the mesh horizontal movements were prevented and vertical movements were allowed. All along the bottom boundary displacements were restrained in all directions.

The loading boundary conditions consisted of water forces applied on the upstream face of the dam, on the surface of the reservoir bed and where tailwater was present, on the rock surface downstream of the structure. Also the influence of uplift pressures has been simulated by applying upward forces to the base of the dam. Naturally, this is only approximate. An effective stress analysis would take uplift into consideration more accurately. However the accuracy of such an analysis would depend on the accuracy and number of water pressure measurements in the rock mass. No common rule, with respect to the uplift pressure, is set for the three dams that will be analysed. The uplift forces applied to the base of every structure have been taken from actual measurements.

All the analyses assumed plane strain conditions.

3.2.2 Procedure Used in an Analysis

Depending if the displacements of the structure are given with respect to a time zero, corresponding to the beginning of the construction of the dam, the procedure used will vary. Such a value for displacement will include the effect of gravity and the subsequent water loading. Therefore, if for a structure, displacements (referring to a time zero) are given for one particular time in

its history, only one analysis need to be performed. This analysis will include gravity loading and the water load acting on the structure at that particular time. On the other hand, if, for example, displacement measurements have been interrupted for a certain period, in the history of the structure, a different procedure will apply. This procedure consists of performing two analyses, each one representing different loading conditions in time on the structure. By doing so, we consider the first analysis as a reference to the second analysis and we look at the relative displacement.

For the analysis of Krasnoyarsk, the first case mentioned above applies. Alpe Gera dam and Bhakra dam are analysed for two different dates in their history.

3.3 Analysis of Krasnoyarsk Dam

3.3.1 Introduction

Krasnoyarsk dam is one of a series of six dams planned on the Enisei river, in East Siberia, to regulate its flow. The dam also serves the purpose of producing electricity. In fact Krasnoyarsk station has the highest production in the world.

The dam is a massive concrete structure with a height of 124 m. and a base width of about 100 m. It has a triangular profile with a vertical upstream face and an inclined downstream face, having a slope of 1:0.8 in the spillway section and 1:0.76 in the power house section. It is founded on granite.

3.3.2 Method of Investigation and Values Assumed for the Study

As described by Bochkin et al. (1971), the dam is founded on granite that ranges from sparsely jointed to highly jointed.

The modulus of deformation of the foundation rock has been found by subjecting a rigid plate to vertical loading. This test has been performed on the different rock conditions mentioned above and gave the following results:

- i) for sparsely jointed granite $E = 160,000 \text{ Kg/cm}^2$
- ii) for medium jointed granite $E = 90,000 \text{ Kg/cm}^2$
- iii) for highly jointed granite $E = 45,000 \text{ Kg/cm}^2$

Poisson's ratio, for this granite, was assumed to be equal to 0.2 in the finite element analysis. The unit weight of the rock was set to zero because only the displacements caused by the change of stress in the rock mass is of concern here.

Two other materials had to be specified in the analysis.

Obviously, the concrete of the dam body was one, and the crest gate area on the dam was the other.

The elastic tangent modulus of the concrete was taken equal to $360,000 \text{ Kg/cm}^2$, as determined on $10 \times 10 \times 40 \text{ cm.}$ samples at the age of 28 days. As can be seen in Table 3.3.1, the tangent modulus for this concrete, more than double in a period going from three days to 360 days.

The effect of the stiffening of the concrete in time, on the deformations of the rock mass was studied by doing two analyses which will be discussed in the following section.

Poisson's ratio and the unit weight of the concrete were assumed to be 0.2 and 2.4 Tm/m^3 respectively.

The crest gate area is expected to be more deformable than the dam body itself. Since it does not reproduce in the third dimension, a plane strain assumption for this section is not exact. The plane stress solution can be obtained by changing the elastic properties of the concrete, using the theory of elasticity. In order to account for this, the modulus and Poisson's ratio for the crest gate area have been assumed to be $250,000 \text{ Kg/cm}^2$ and 0.25 respectively. However, the results proved to be insensitive to that change. Finally, since this area of the dam is more porous than its body, a weight of 2.0 Tm/m^3 was assumed in the analysis.

Different analyses involving different conditions on the life of Krasnoyarsk dam are presented in the following section. The finite element mesh used through the study is shown in Fig. 3.3.1.

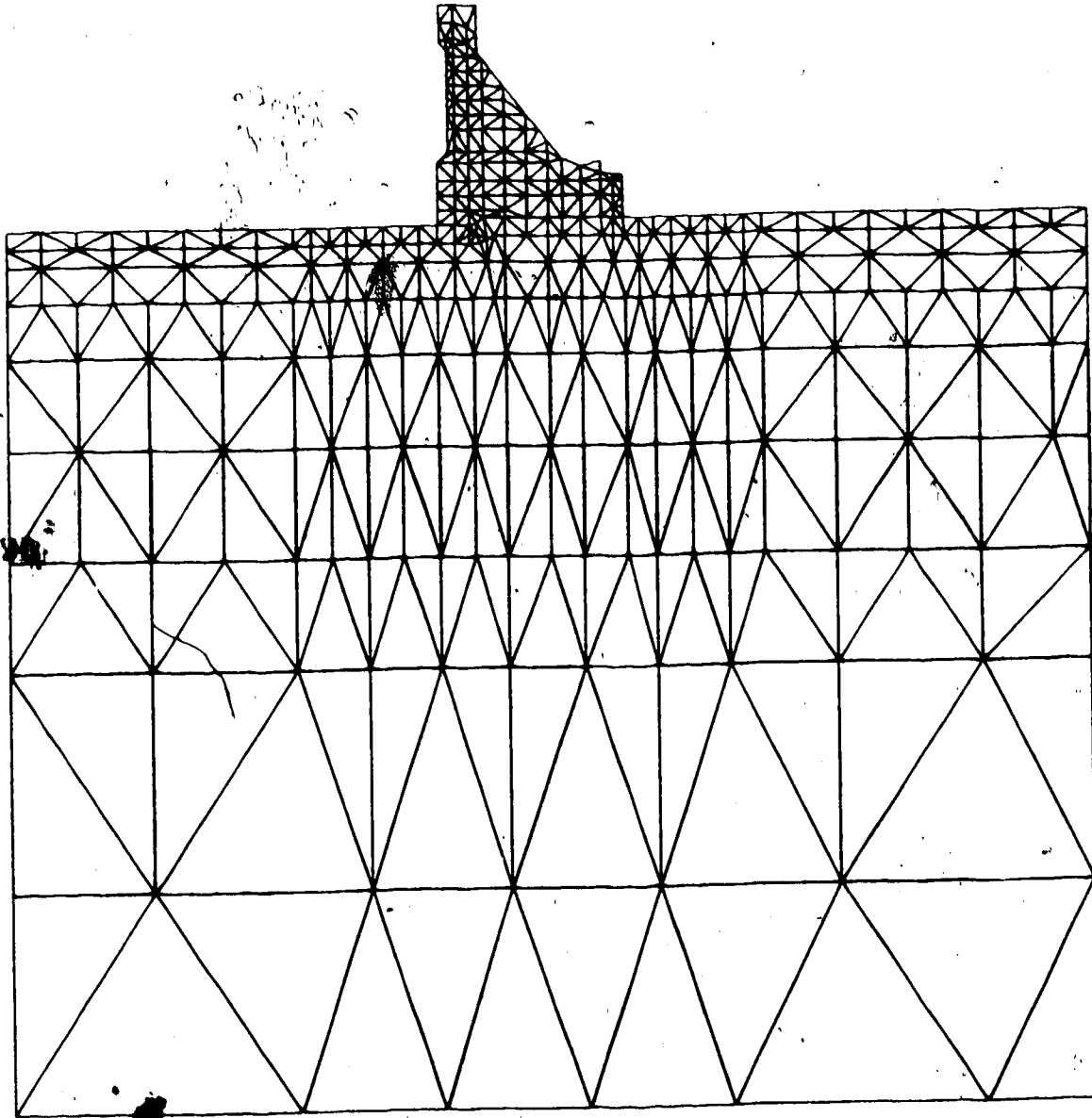

FIG. 3.3.1 FINITE ELEMENT MESH USED IN THE STUDY OF KRASNOYARSK DAM

3.3.3 Results of Predicted and Measured Displacements

As stated in the previous section, a study of the effect of the stiffening of the concrete in time, on the foundation displacements, was done. Two analyses were performed assuming an E value determined after 28 and 360 days. These values are given in Table 3.3.1.

The results of the displacements of the foundation surface for the two cases are given in Figures 3.3.2 and 3.3.3. It is obvious that, in the range of variation considered here, the fact that the concrete stiffens as it ages does not affect the deformations of the rock surface. In the case of a modulus equal to $360,000 \text{ Kg/cm}^2$, the average vertical displacement over the dam-foundation contact is 21.1 mm. The second analysis used $E = 470,000 \text{ Kg/cm}^2$ and an average displacement of 21.0 mm. was calculated. Since the difference was insignificant, the value of $360,000 \text{ Kg/cm}^2$ was assumed in the following analyses.

i) Gravity Analyses

Due to the availability of foundation displacements under the weight of the dam itself, a gravity analysis was undertaken. The modulus of deformation used here was an average of the three values mentioned above, i.e. $1.0 \times 10^5 \text{ Kg/cm}^2$. The displacements are plotted and shown in Fig. 3.3.2. The vertical displacements over the whole dam-foundation contact averaged at 21.1 mm., with a maximum value of 23.7 mm. The settlement measured under section 22 of the dam was 10.2 mm.

It can be concluded from these results that, if the modulus

TABLE 3.3.7

ELASTIC TANGENT MODULUS OF CONCRETE VERSUS TIME

	AGE OF CONCRETE, DAYS						
	7	14	28	90	180	360	
Laboratory Specimens	1.95×10^5	2.70×10^5	3.28×10^5	3.62×10^5	4.30×10^5	4.55×10^5	4.70×10^5

(FROM BOCHKIN ET AL. 1971)

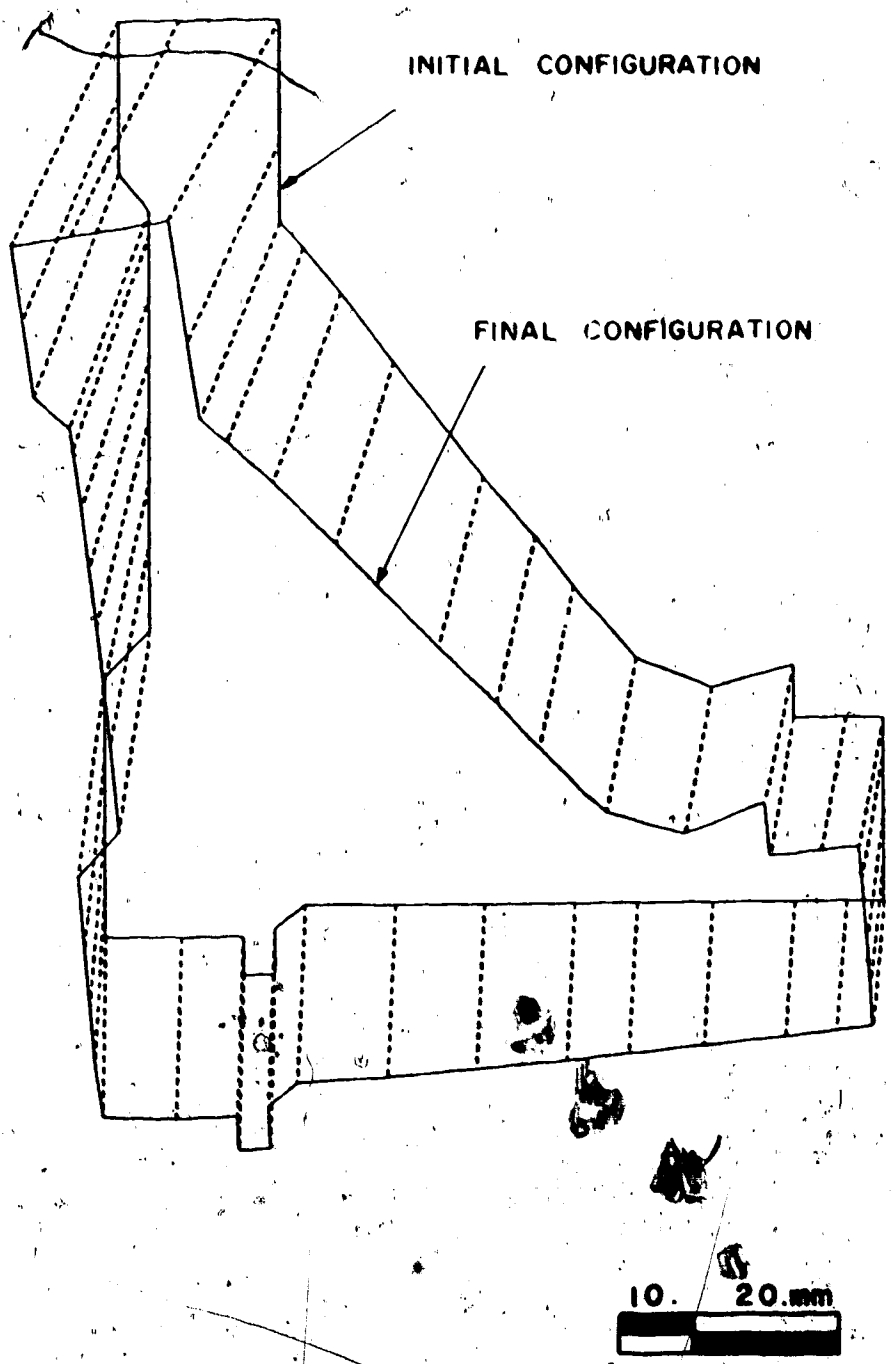

FIG. 3.3.2 DISPLACEMENTS OF THE DAM DUE TO GRAVITY ONLY FOR $E_{\text{CONCRETE}} = 360,000 \text{ Kg/cm}^2$ and $E_{\text{ROCK}} = 100,000 \text{ Kg/cm}^2$

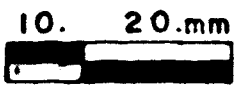
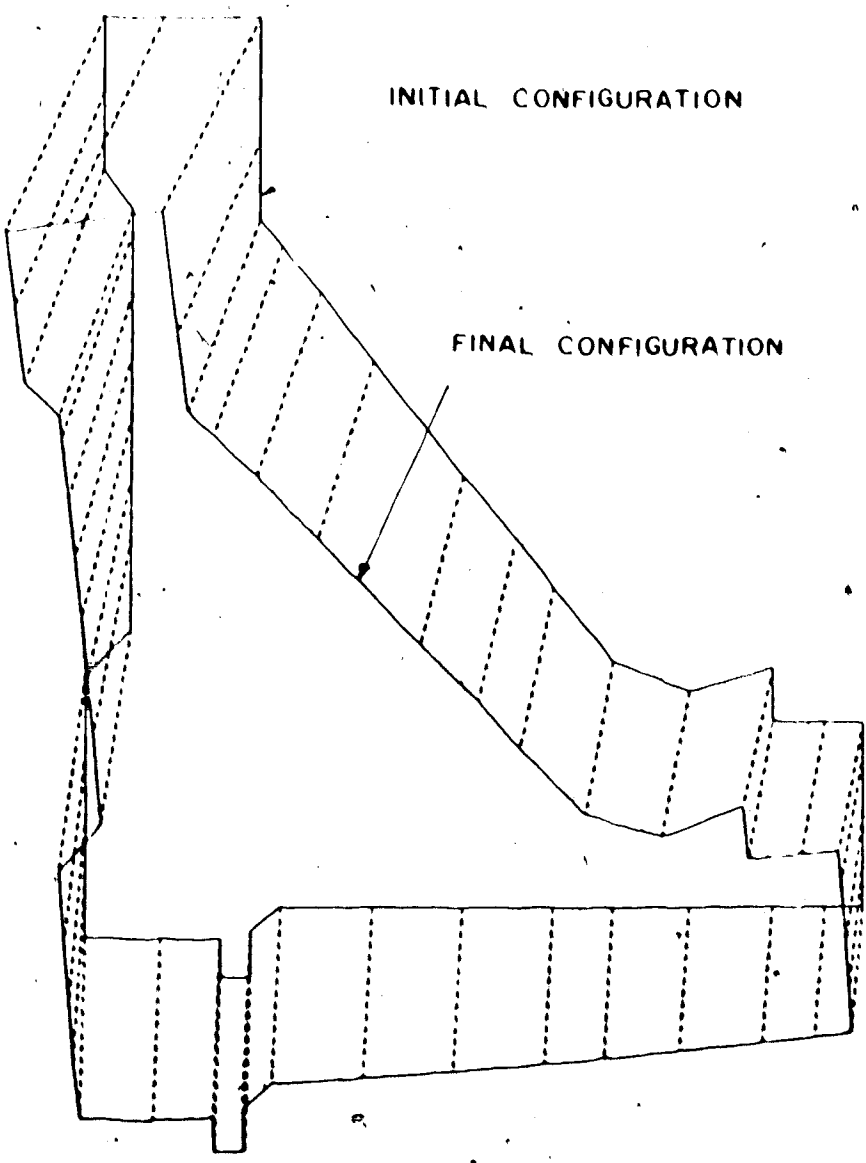

FIG. 3.3.3 DISPLACEMENTS OF THE DAM DUE TO GRAVITY ONLY FOR $E_{CONCRETE} = 470,000 \text{ Kg/cm}^2$ and $E_{ROCK} = 100,000 \text{ Kg/cm}^2$

of deformation of the rock mass below section 22 is taken as the average of the values determined in situ, the displacements predicted will be 2.3 times the measured ones. This implies that, to account for the measured movements of the foundation, its modulus should be equal to $230,000 \text{ Kg/cm}^2$.

Based on a linear elastic analysis, we will always find that no matter which modulus is assumed, if we want to match the measured settlements, a stiffness of $230,000 \text{ Kg/cm}^2$ will be arrived at. The fact that the end result is always the same is rather interesting because the only variable involved here is the decision on the design modulus.

It is very unlikely that the designers of a dam will use the maximum value of the modulus of deformation found from in situ tests. In the case of Krasnoyarsk dam, even if they had chosen the highest value, i.e. $1.6 \times 10^5 \text{ Kg/cm}^2$, a difference of about fifty percent would have still existed between their choice and the stiffness arrived at earlier. This is shown on Fig. 3.3.4 which summarizes the results of the gravity analyses.

ii) Gravity and Water Load Analysis

Filling of the Krasnoyarsk reservoir began in April 1967. The history of the impounding is shown on Fig. 3.3.5.

The available data on Krasnoyarsk dam for Section 22 of the spillway is presented for July 1969, right after a steep rise in the water level. Readings of the uplift pressures on the dam base have shown that the grout curtain and the drains built in the foundation have been very efficient in reducing them. Even if the

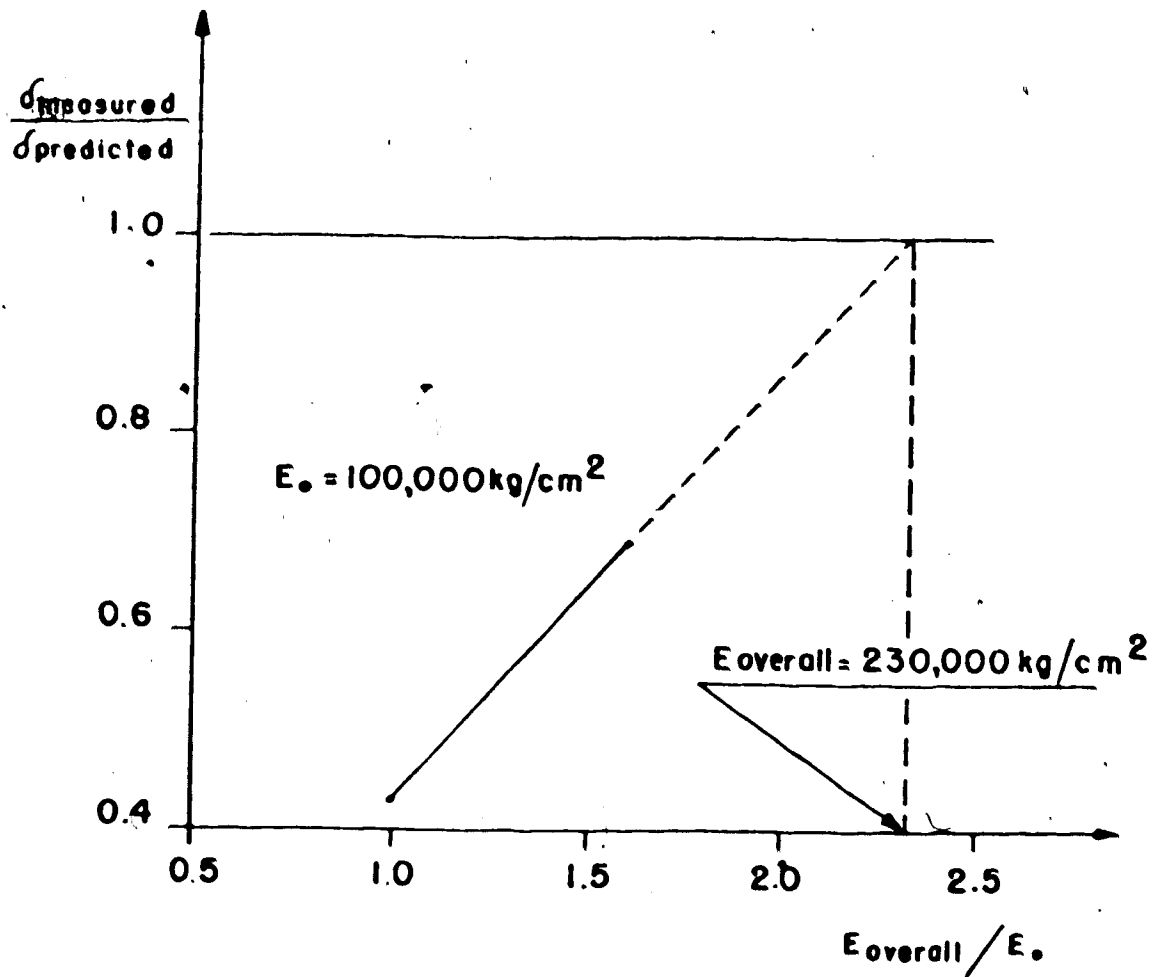

FIG. 3.3.4 DISPLACEMENT RATIO VERSUS MODULUS OF DEFORMATION RATIO FOR THE GRAVITY ANALYSES

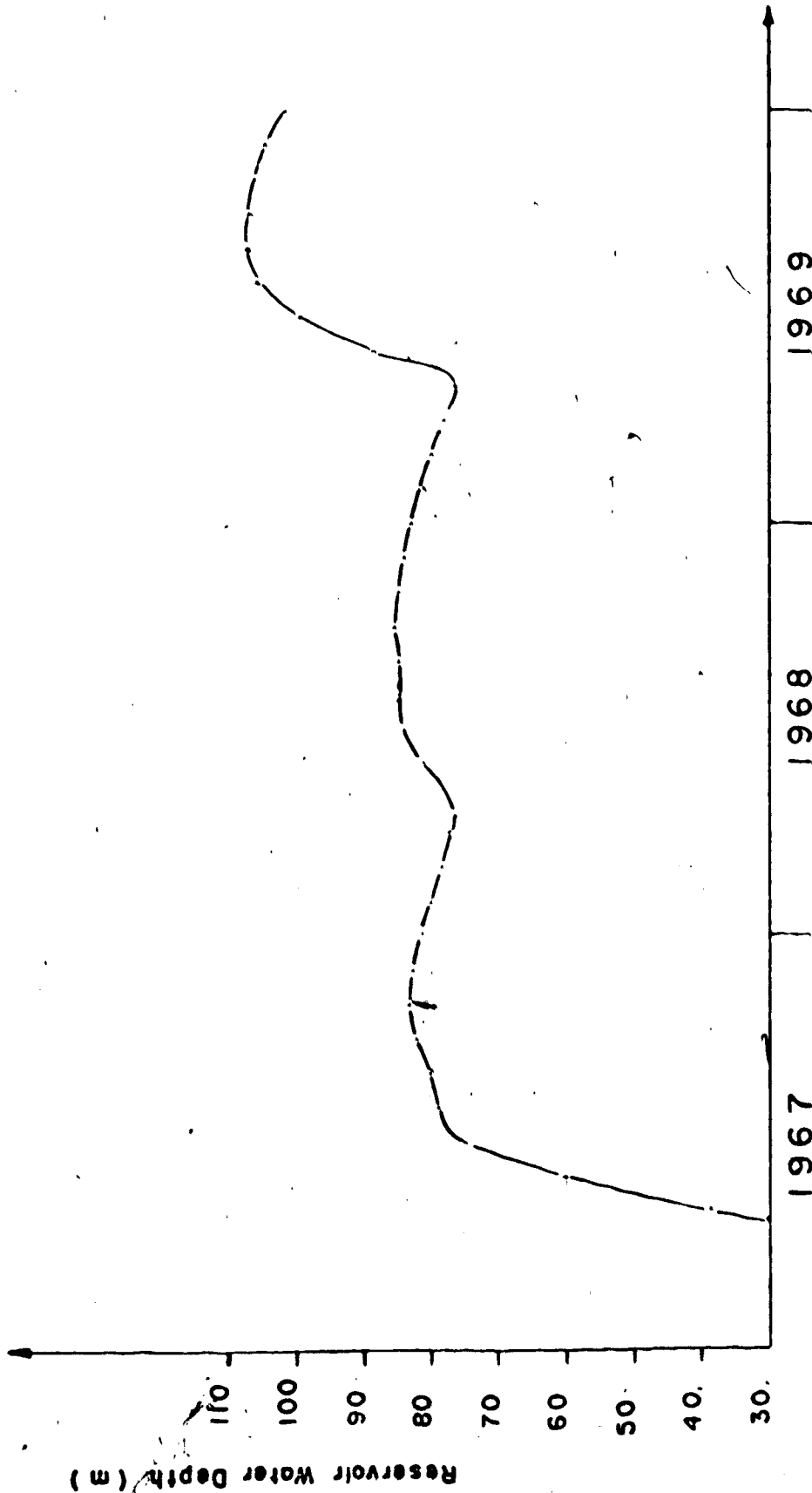

FIG. 3.3.5 HISTORY OF IMPOUNDING FOR KRASNOYARSK DAM

uplift was very small, i.e. approximately one per cent of the total head at that time, uplift forces on the dam base were included in the finite element analysis.

The properties assigned to the crest gate area and the dam body were the same ones as for the gravity analysis. The rock deformation modulus was taken as $100,000 \text{ Kg/cm}^2$ with a Poisson's ratio of 0.2 and no unit weight.

The loads involved in this first analysis are then, the dead weight of the dam, the water pressure acting on the upstream face of the structure and on the reservoir floor and lastly, the uplift pressures on the dam base.

The total displacement vectors of the foundation are shown schematically on Fig. 3.3.6. The maximum settlement calculated was 40.8 mm. and the average over the dam-foundation contact was 37.1 mm.

If, for example, we assume that no hydrostatic pressure was transmitted to the grout curtain, which is very unlikely and also inconsistent with uplift, we would find that, to account for a total displacement of 19.4 mm. up to July 1969, the overall modulus of the foundation rock should be $210,000 \text{ Kg/cm}^2$. The value of 19.4 mm. and others are given in Table 3.3.2., from the beginning of impounding up to July 1969. The more reasonable assumption of full hydrostatic pressure being applied on the grout curtain will be looked at later:

An interesting feature appears if we look at Table 3.3.2 together with Fig. 3.3.5. Up to July 1969, the two severe loading periods are from April to August 1967 and from May to July 1969.

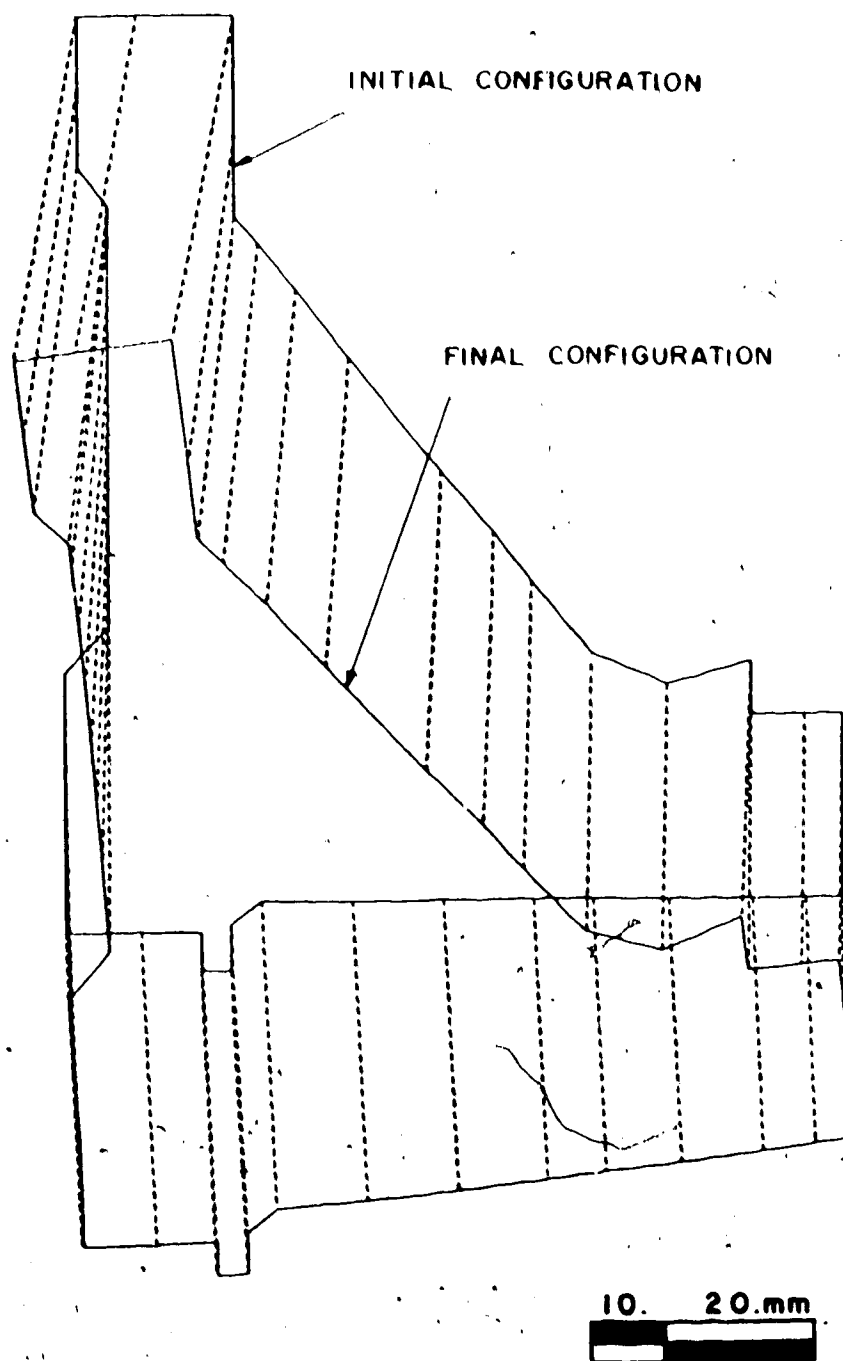

FIG. 3.3:6 DISPLACEMENTS OF THE DAM FOR GRAVITY AND WATER LOADING.
 $E_{\text{CONCRETE}} = 360,000 \text{ Kg/cm}^2$, $E_{\text{ROCK}} = 100,000 \text{ Kg/cm}^2$

TABLE 3.3.2
SETTLEMENTS MEASURED ON THE DAM
VERSUS TIME

Settlements at different times	Section #22
Settlement before filling reservoir (March 1967), mm.	10, 2
Settlement in 1967 (mm.)	6, 8
Settlement in 1968 (mm.)	3, 3
Total settlement up to July 1969, mm..	19, 4

(From Bochkin et al, 1971)

The year 1968 could be qualified as one of constant loading. On the other hand, a displacement of 3.3 mm. is given for that period. This could mean that the rock in the foundation is creeping under that constant load. Since the analysis does not include any time-dependent calculation of the deformations the 3.3 mm. could be subtracted from 19.4 mm., which would bring the overall E to approximately 2.5 times the initial assumption.

The creep effect mentioned above versus the linear elastic finite element analysis can be looked at from another point of view. We seek a correlation between the numerical analysis and the actual deformations measured on the structure. This correlation has to embrace all the possible factors contributing to the deformations of the dam such as discontinuities, anisotropy, time-dependency. We therefore include the possible creep mentioned above in the total displacement and keep the ratio of 2.1 between the overall modulus and the one used in the study.

iii) Gravity and Water Load plus Assumption
of a Crack in the Foundation Rock

The final analysis performed on Krasnoyarsk dam is a more realistic one. It considers the foundation rock to be cracked to a depth equal to the height of the dam and having full hydrostatic pressure applied on the grout curtain. The dam is then free to move under the varying water levels. It is separated from the rock mass upstream of it by an area of zero rigidity. Consideration of the hydraulic aspects of this was given by Casagrande (1961).

The displacements experienced by the dam upon impounding up to a reservoir depth of 105 meters are shown on Fig. 3.3.7. The maximum settlement is 31 mm. and the average over the dam width is 30 mm. If we compare this displacement with the one mentioned before i.e. 19.4 mm., we obtain a ratio of 1.6 between the predicted and the measured. Therefore, if the conditions involved in the analysis are realistic, an overall modulus of $160,000 \text{ Kg/cm}^2$ would make the predicted settlements essentially equal to the measured ones.

Finally, the Russian investigators have also found by considering the dam-foundation inclination due only to water loading, that, to account for the measured deformations of the rock at section 22, the overall modulus of deformation had to be equal to $2.54 \times 10^5 \text{ Kg/cm}^2$. This modulus, with respect to our assumptions, gives us a ratio of 2.54 which is in reasonable agreement with the values we have quoted all through the Krasnoyarsk study. Table 3.3.3 summarizes the results of the finite element analyses and of the actual behaviour.

3.3.4 Comparison of Actual Behaviour With Predicted

In the case of the Krasnoyarsk dam, as in the case of any other dam, a representation of the actual deformations of the foundation of the structure and of the structure itself will be faced with two major alternatives:

- 1) either the rock mass on which the structure is sitting is initially very sparsely cracked and has little tendency to open in tension upon impounding of the reservoir. This is a function in

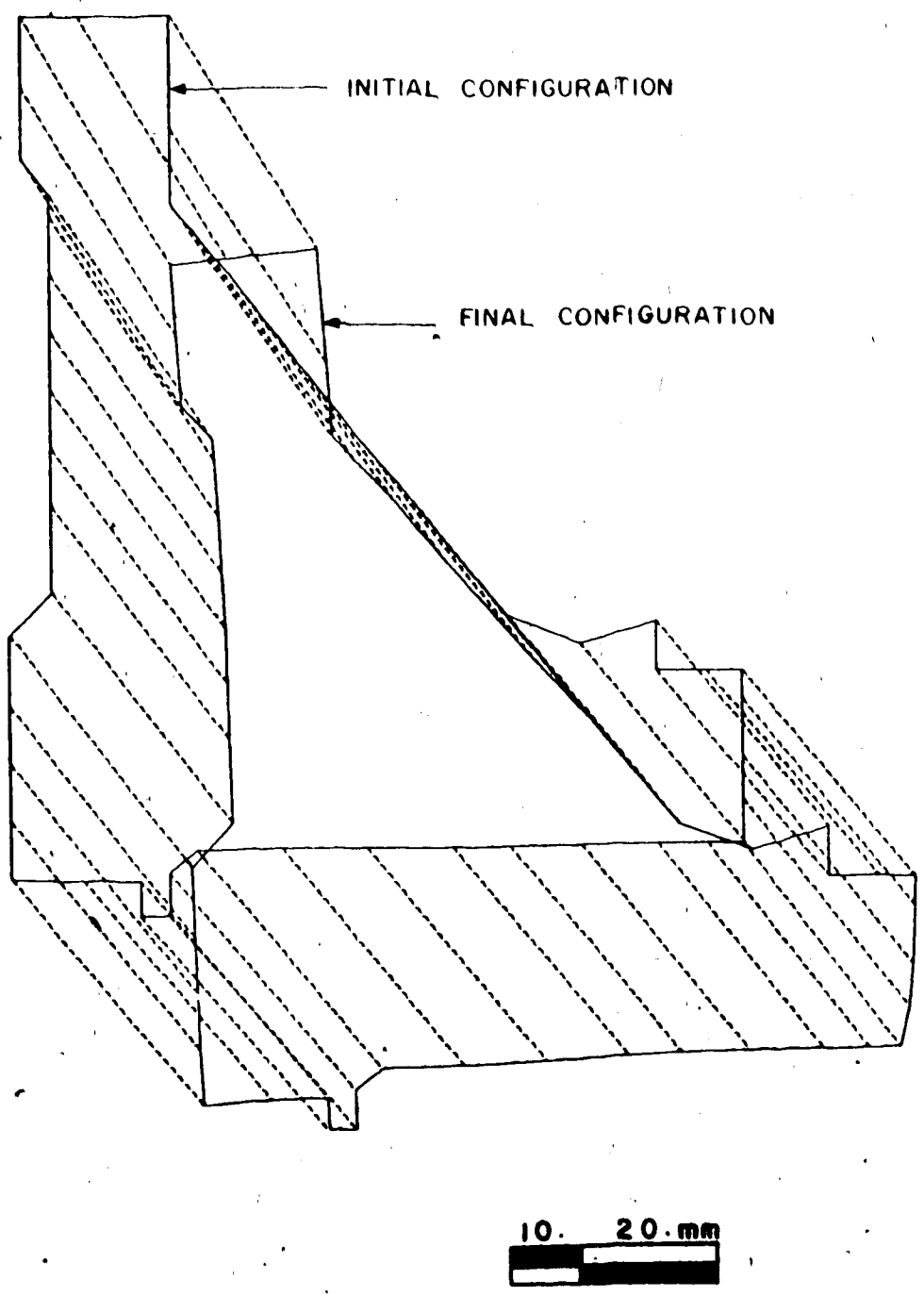

FIG. 3.3.7 DISPLACEMENTS OF THE DAM FOR GRAVITY AND WATER LOADING PLUS ASSUMPTION OF A CRACK GOING DOWN 1.0M INTO THE FOUNDATION ROCK

TABLE 3.3.3

SUMMARY OF RESULTS FOR THE STUDY OF KRASNOYARSK DAM

Displacement Origin	Modulus E (Kg/cm ²)	Predicted * Displacement mm.	Measured Displacement mm.	Ratio (E _{overall} /E _{measured})
Concrete Stiffening	E _{concrete} = 360,000	21.1(v)		
	E _{concrete} = 470,000	21.0(v)		
Gravity	E _{rock} = 100,000	23.7(v)	10.2(v)	2.34
Gravity	E _{rock} = 160,000	14.9(v)	10.2(v)	1.46
Gravity + Water Load + Uplift	E _{rock} = 100,000	40.8(v)	19.4(v)	2.10
Gravity + Water Load + Uplift + Crack at Heel of Dam	E _{rock} = 100,000	31.0(v)	10.4(v)	1.60
Russian Analysis of Dam-Fdn. Inclination				2.54

* Predictions of displacements by a linear elastic finite element analysis.

(v): vertical displacements

particular, of the initial state of stress, the $E_{\text{concrete}}/E_{\text{rock}}$ ratio, of the tensile strength of the rock and of the water pressure distribution in the rock mass.

2) or the rock mass is initially highly cracked and/or does not restrain the development of crack formation at the heel of the dam.

The first case would make the dam body integral with the rock foundation, which in turn would contribute, by its stiffness, in reducing the deformations of the structure. The second case would "disconnect" the dam body from the upstream rock, and make it very much easier to deform and rotate.

If we refer to the results obtained in the analyses of Krasnoyarsk dam and assume that, from the beginning of impounding there is a full hydrostatic pressure applied in the rock mass to a depth equal to the height of the dam, then, up to a certain water level in the reservoir, the dam will rotate in an anti-clockwise manner. This feature is more evident in the following case study of Alpe Gera dam. During the impounding of the reservoir the point of application of the resultant of the water load will become high enough so that the effect of the water pressure on the structure will be dominant and will then make it rotate in a clockwise direction.

If now, we assume that we do not have any crack, i.e. that no full hydrostatic pressure is transmitted in depth into the rock foundation, we see by looking at Figures 3.3.2 and 3.3.6 that the dam undergoes almost no rotation.

In Fig. 3.3.8 are presented the results of the measurements

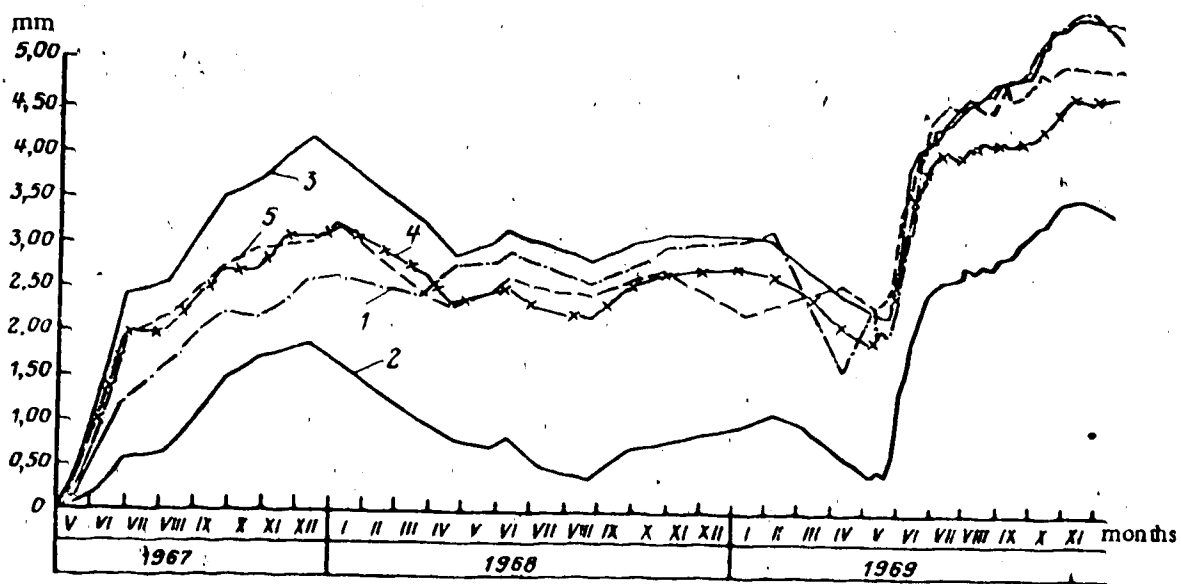

FIG. 3.3.8 DIFFERENCE IN COLUMN ELEVATIONS MEASURED WITH A HYDROSTATIC LEVEL. 1) SECTION 8, COLUMNS II-VI; 2) SECTION 29, COLUMNS I-IV; 3) SECTION 37, COLUMNS II-IV; 4) SECTION 45, COLUMNS II-V; 5) SECTION 54, COLUMNS I-IV (FROM BOCHKIN ET AL., 1971)

of the difference in column elevations for different sections of the dam. It is interesting to note that as soon as filling of the reservoir started, a clockwise rotation was measured. Having this in mind, we can imply that the conditions represented by Fig. 3.3.7 constitute an upper bound in the prediction of the deformations of Krasnoyarsk dam. In fact, to have a clockwise rotation of the structure as impounding increases, full hydrostatic pressure in the foundation rock could only act along a small fraction of the length of the grout curtain.

Using the results of the stresses computed in the gravity plus water load analysis and assuming a $K_0 = 1$ condition in the rock mass prior to loading, we have calculated the variation of the total horizontal stress, σ_{hx} , with depth, below the heel of the dam. The distribution of this stress together with the water pressure distribution, U , assumed in the calculation are shown on Fig. 3.3.9. This figure also shows the result of the subtraction of the water pressure from the total stress, i.e. the effective horizontal stress, σ'_{hx} . The region of positive stress is the tensile zone; the negative stresses are compressive. The depth on which the above stresses are acting is equal to H , the height of the dam.

If we assume that the rock mass has no tensile strength, it would then fail down to about 50% of the length of the grout curtain. Therefore, we see that, in the case of Krasnoyarsk dam, the application of full hydrostatic pressure down to H into the rock mass is far too conservative.

Consequently, it is suggested that the behaviour of

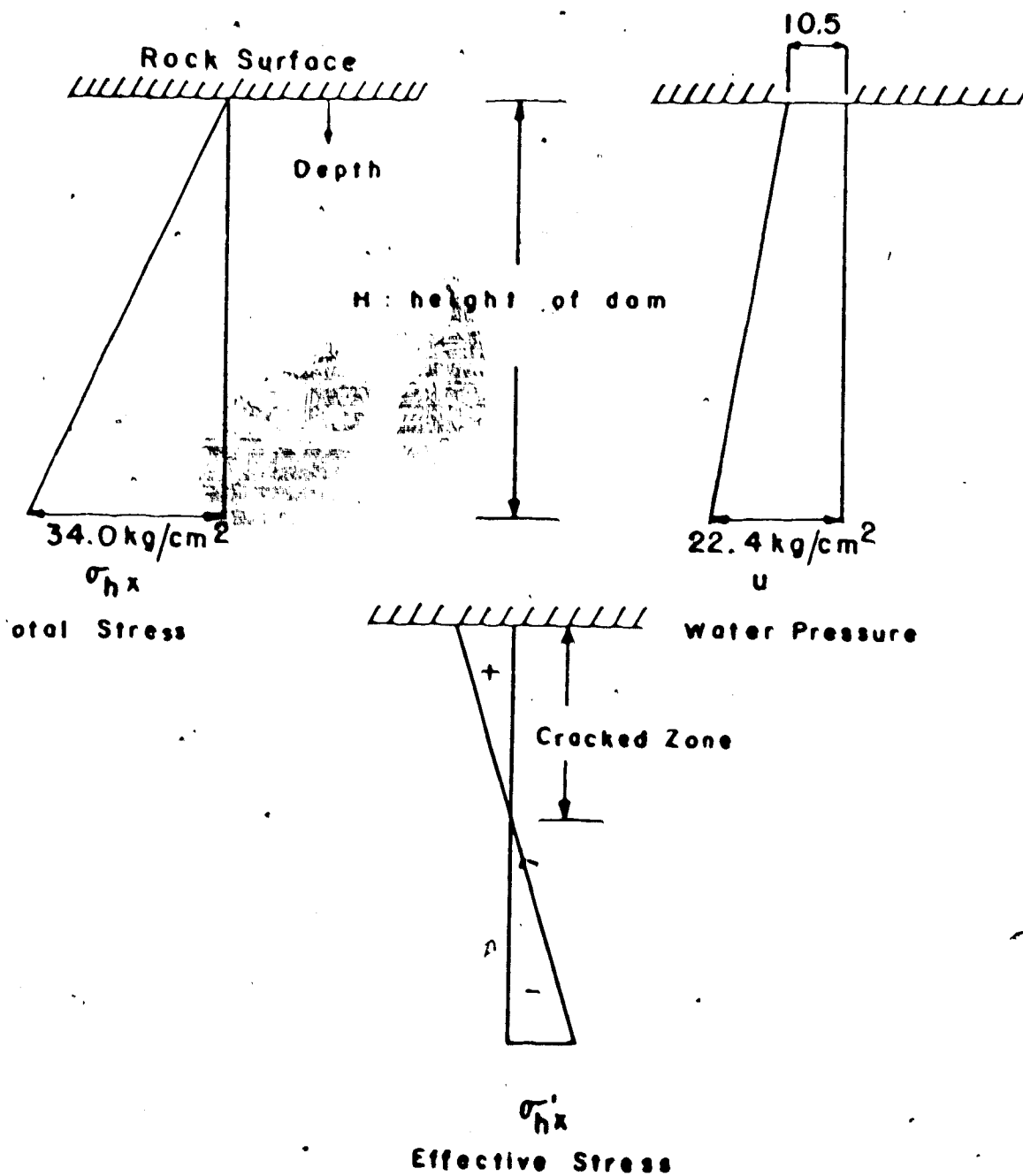

FIG. 3.3.9 TOTAL STRESS, WATER PRESSURE AND EFFECTIVE STRESS DISTRIBUTIONS BASED ON THE RESULTS OF THE GRAVITY PLUS WATER LOAD ANALYSIS

Krasnoyarsk dam is better represented by the conditions shown on Fig. 3.3.6 than on Fig. 3.3.7.

3.4 Analysis of Alpe Gera Dam

3.4.1 Introduction

The Alpe Gera dam is situated on the Mallerio river in the upper Valtellina valley in the Italian Rhaetian Alps. It was built to control the seasonal flows of the Scerscen and Cormor torrents and to produce electricity.

The dam itself is a straight concrete gravity structure with a triangular profile. It is 178 meters high above the lowest foundation point. The upstream face has a slope of 0.03 to one and the downstream face, a slope of 0.70 to one. At the toe of the dam, a concrete block was built to increase the area of contact with the foundation rock. A general view of the structure is presented in Fig. 3.4.1.

Alpe Gera dam is founded on metamorphic serpentine schist, an intrusive volcanic rock.

3.4.2 Method of Investigation and Values Assumed for the Study

The rock at the Alpe Gera site has been investigated by two static methods: hydraulic chamber test and jacking tests. The following is a short description of the methods used.

i) Hydraulic Chamber Test

This test was performed in a gallery having a length of 5 meters and an interior diameter of 1.7 meter. Water is pumped into the chamber which when filled applies an all-around pressure to the rock mass. Usually the deformations are measured at the mid-section of the chamber, by recording the variations in length of

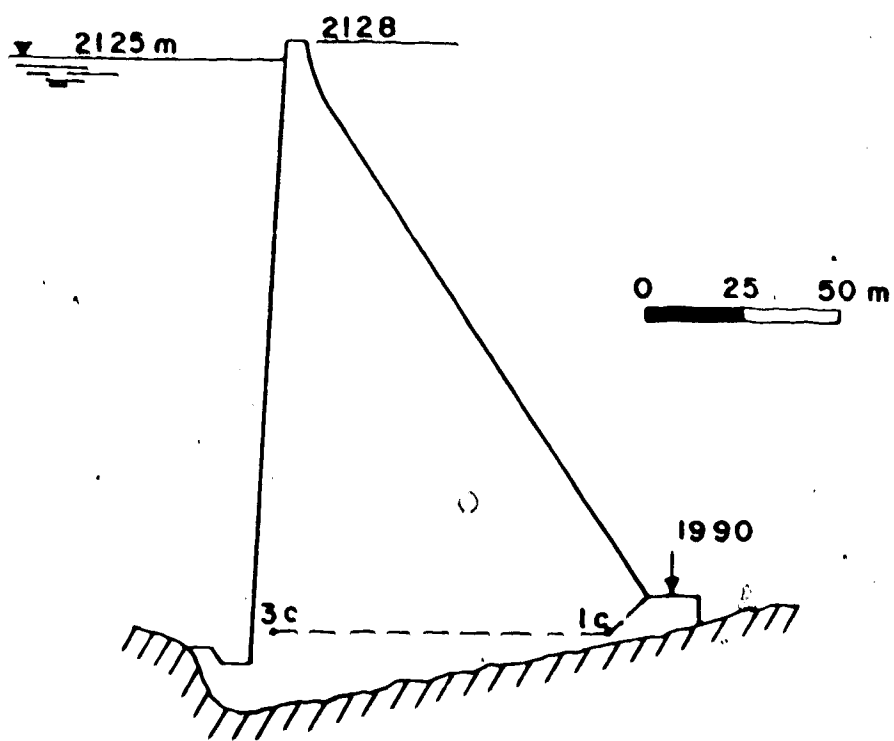

FIG. 3.4.1 SECTION OF ALPE GERA DAM

four different diameters. Every test allows for the application of five loading cycles, gradually increasing the load up to 20 to 30 Kg/cm^2 . The total duration of the test is never less than three hours. Figure 2.2.3 shows schematically the different features of the hydraulic chamber test.

ii) Jacking Test

The jacking test also was performed in a gallery. Very often, as was the case for Alpe Gera, the jacks are installed in the same gallery used for the hydraulic chamber test. The jacks had a capacity of 200 tons distributing their loads on plates having a diameter of 250 mm. The deformations were measured close to the loading plates. The configuration of the jacking test is given in Fig. 3.4.2.

The available data on the tests mentioned above are presented in Table 3.4.1. We notice that all the static tests have been done in the right bank at elevation 1977. The modulus of elasticity found varies from $45,000 \text{ Kg/cm}^2$ to $256,000 \text{ Kg/cm}^2$. The reason for the latter value to be so high with respect to the other ones is probably the fact that it has been obtained from a test performed in the same gallery as the hydraulic chamber tests. The hysteretic compression of the rock mass due to the first loadings has led to an increase in the stiffness value upon reloading.

In the finite element analyses of Alpe Gera dam, two materials have been considered: the concrete of the dam and the foundation rock.

Gentile (1964) has elaborated on the different characteristics of the concrete used in the construction of the dam. The

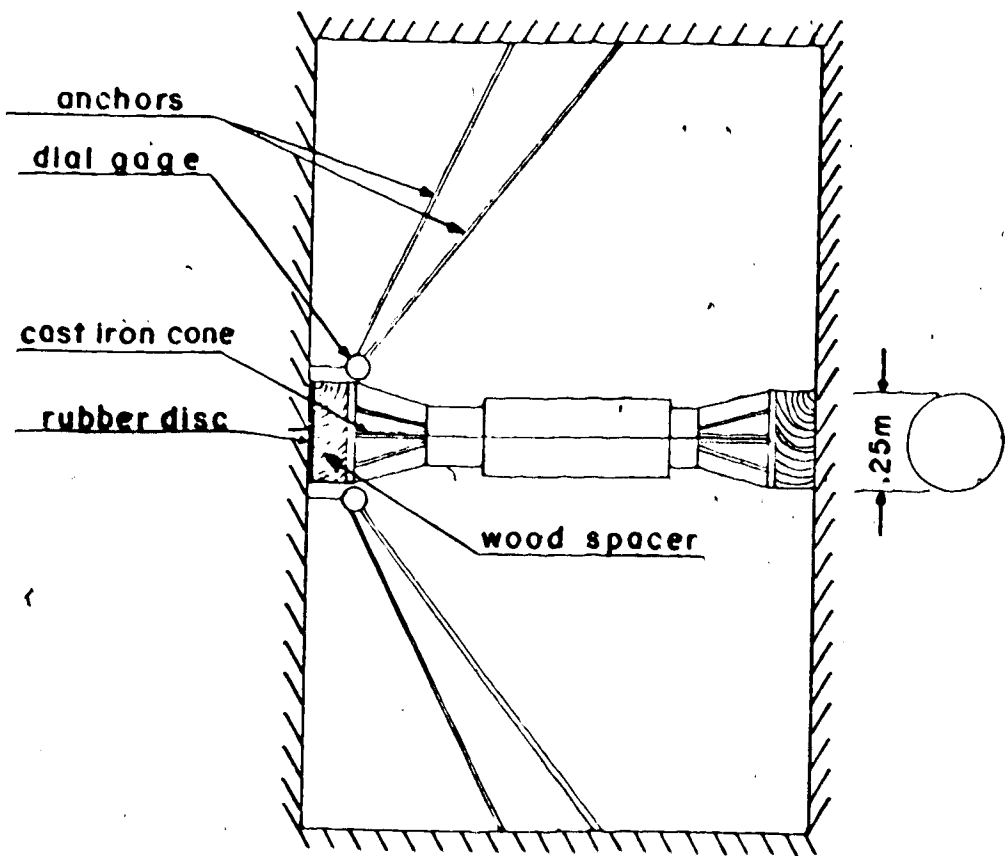

FIG. 3.4.2 JACKING TEST SET-UP

TABLE 3.4.1
RESULTS OF MODULI OF DEFORMATION
MEASURED AT ALPE GERA DAM SITE

Type of Test	Overburden (m)	Max. Test Load Kg/cm ²	Modulus E Kg/cm ²	Direction of Measurements at Test Site	Remarks
H.C.T.	60	18	69,000	*	Only F.G. After C.G.
		36	45,000	*	
J.T.		100	256,000	—	Test performed in same gallery as the H.C.T.
		100	89,000		
J.T.	30	40	169,000	—	
		60	148,000		

Abbreviations

H.C.T.	Hydraulic chamber test	—————	Direction of deformation measurement
J.T.	Jacking Test	-----	Direction of maximum deformation
F.G.	Filling Grouting	Direction of minimum deformation
C.G.	Consolidation Grouting		

(From Direction des Etudes et Recherches, ENEL, Rome, Italie,
First International Congress on Rock Mechanics, V.2, Theme 8,
Paper 20, p. 603-615)

concrete has a low cement content with a modulus of 300,000 Kg/cm² and a unit weight of 2.6 Tm/m³. Poisson's ratio for this concrete was assumed to be 0.18.

As was mentioned before, the choice of the assumption of a modulus value for the rock will not influence the value of the overall calculated E. This is due to the inherent proportionality between modulus and displacements when using a linear elastic analysis. For this reason the E used in the study of Alpe Gera dam was chosen as 100,000 Kg/cm². Poisson's ratio was assumed to be 0.2.

The finite element mesh used in the study of Alpe Gera dam is shown on Fig. 3.4.3.

3.4.3 Results of Predicted and Measured Displacements

i) Gravity Analysis

No data on displacements due to the weight of the dam alone were available. Nevertheless, a gravity analysis was performed to see what would be the initial configuration of the dam prior to the water loading. The deformation results are shown on Fig. 3.4.4. We can see that, based on the hypothesis that the rock mass stiffness can be represented by a modulus of 100,000 Kg/cm², there is an overall anti-clockwise rotation of the dam body as was shown for the case of Krasnoyarsk. The rotation of the dam is caused by a differential settlement of the foundation rock of approximately 9 mm.

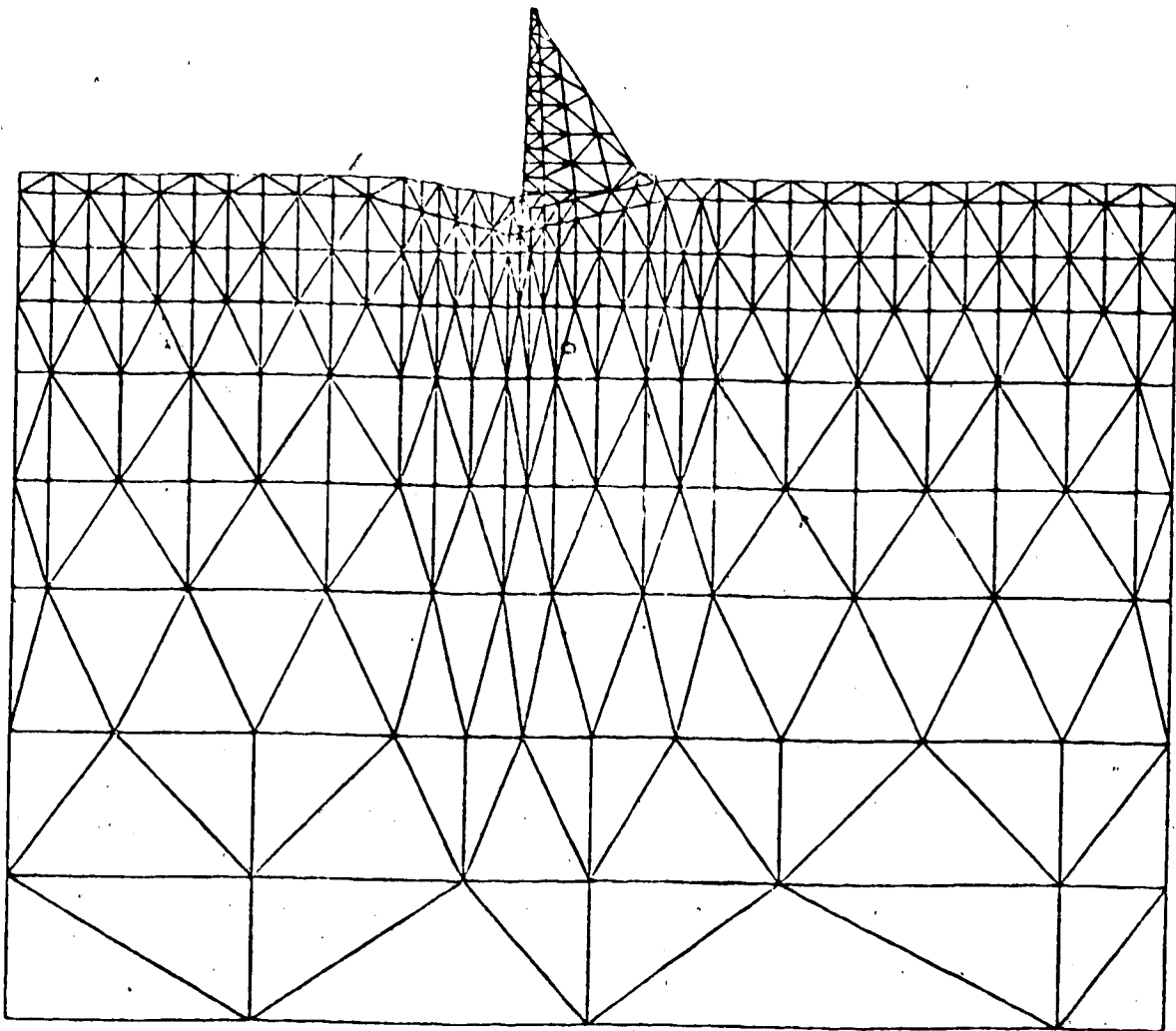

FIG. 3.4.3 .FINITE ELEMENT MESH USED IN THE STUDY OF ALPE GERA DAM

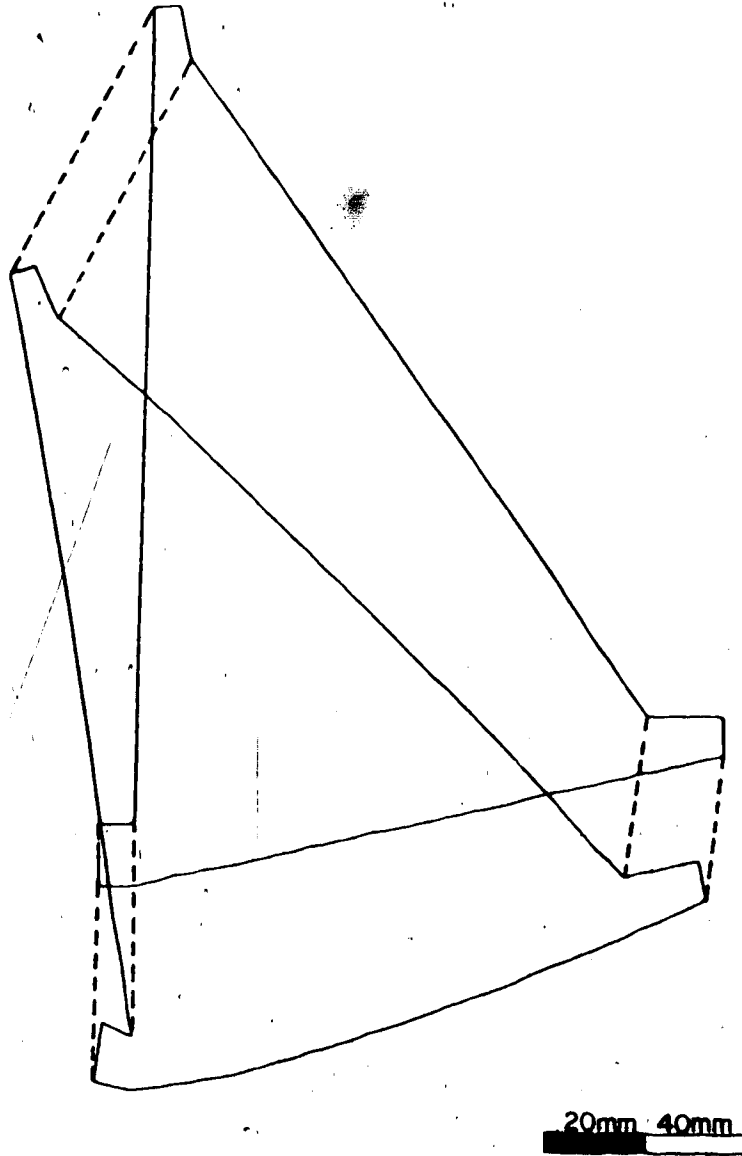

FIG. 3.4.4 DISPLACEMENTS OF THE DAM DUE TO GRAVITY ONLY

ii) Gravity plus Water Load Analysis (Assumption of a Crack below the Heel of the Dam)

The reference for the comparison of predicted and measured displacements in the case of Alpe Gera dam was the rotation measured in the foundation gallery for the whole period of impounding up to the normal reservoir level. The two points involved in the rotation measurements are point 3c and 1c. They are situated at the extremities of the foundation gallery, as shown on Fig. 3.4.1. Figure 3.4.5 shows the reservoir level and temperature variations together with the levelling measurements on the dam crest and in the foundation gallery. The measuring instruments were located in block No. 10 of the dam. The period taken into account in our analyses was the year 1966. This was the first year when the water reached its normal level. The initial condition considered was with the water at level 2040 m. and the final one, at a level of 2125 m.

The forces involved in these two analyses were the weight of the concrete, the water forces applied on the upstream face of the dam*, and on the reservoir bed, water forces in a crack at the heel of the dam penetrating approximately to a depth equal to the height of the structure and finally uplift forces applied on the base of the dam. With respect to the last forces, a maximum of 25% of the head was applied immediately downstream of the grout curtain with a linear variation decreasing to zero at mid-base.

The displacements of the structure, with the water level

* The upstream face of the dam was covered by steel plates. The modelling of the water pressure on this face is therefore very close to reality.

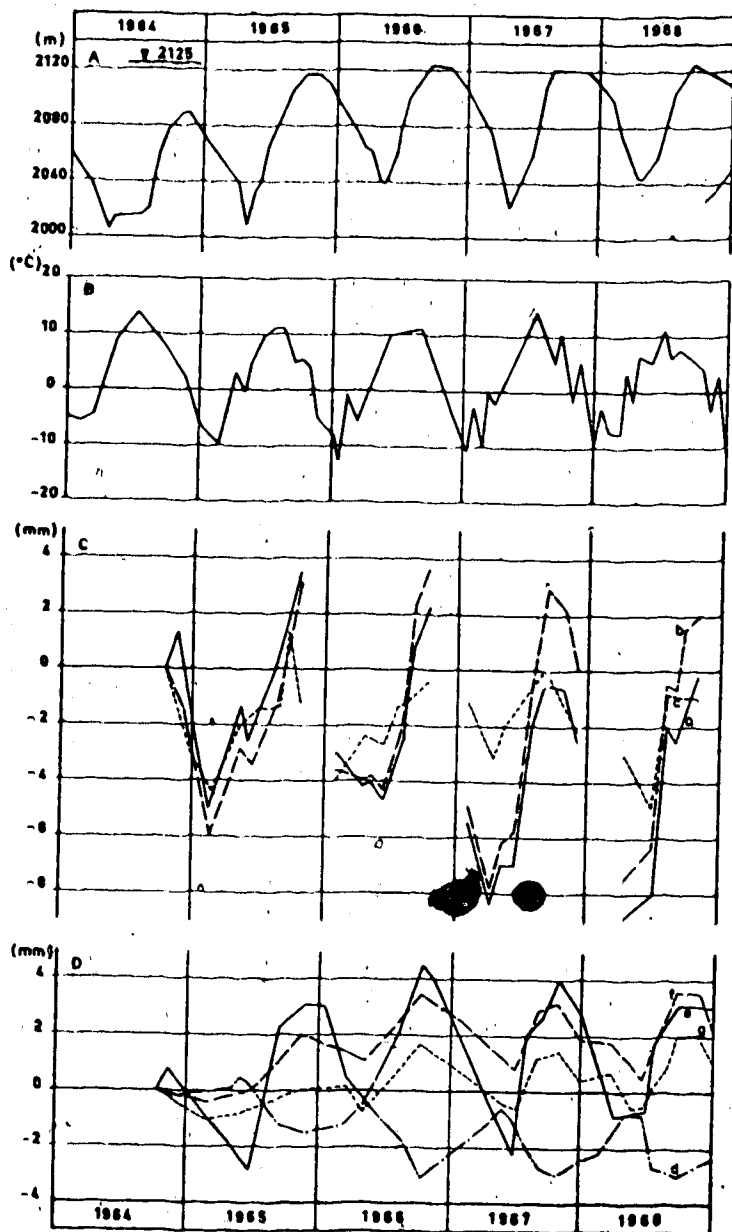

FIG. 3.4.5 LEVELING MEASUREMENTS ON DAM CREST AND IN THE FOUNDATION (A) IMPOUNDMENT (B) EXTERNAL TEMPERATURE (C) LEVELING ON DAM CREST a) SECTION 10 b) SECTION 20 c) SECTION 32 (D) LEVELING IN FOUNDATION d) POINT 1c e) POINT 3c (FROM C. TERRACINI, 1970)

at 2040 m. are shown on Fig. 3.4.6(a). Under the loadings mentioned above, the dam has tilted in an anti-clockwise direction. The differential settlement in the foundation rock has increased to 34 mm.

The last analysis performed on Alpe Gera dam implied an increase in the reservoir level to 2125 m. The corresponding displacements are given on Fig. 3.4.6(b).

It is obvious that between the initial and final condition studied here came a time when the rotation of the structure changed direction. This fact was mentioned in the study of Krasnoyarsk dam. The whole structure has therefore rotated in a clockwise direction bringing the differential settlements between point 3c and 1c back to 9 mm.

Consequently, increasing the water level in the reservoir by eighty-five meters produced a net clockwise rotation corresponding to a differential settlement of 25 mm. During the period considered Fig. 3.4.5 indicates to us a differential settlement of about 7.5 mm. between point 3c and 1c. Therefore, our assumption of $100,000 \text{ Kg/cm}^2$ for the overall modulus of the rock should be increased to almost $335,000 \text{ Kg/cm}^2$ to account for the measured rotation.

Looking back to Fig. 3.4.5, we see that levelling on the dam crest between the low and high level of 1966 gave a net upward movement of 7 mm. The different elevations calculated for those two conditions result in a movement in the same direction but having a value of 27 mm. Consequently, a ratio of 3.75 exists between the predicted and measured displacements. Naturally, the displacements of the dam crest are also influenced by the temperature

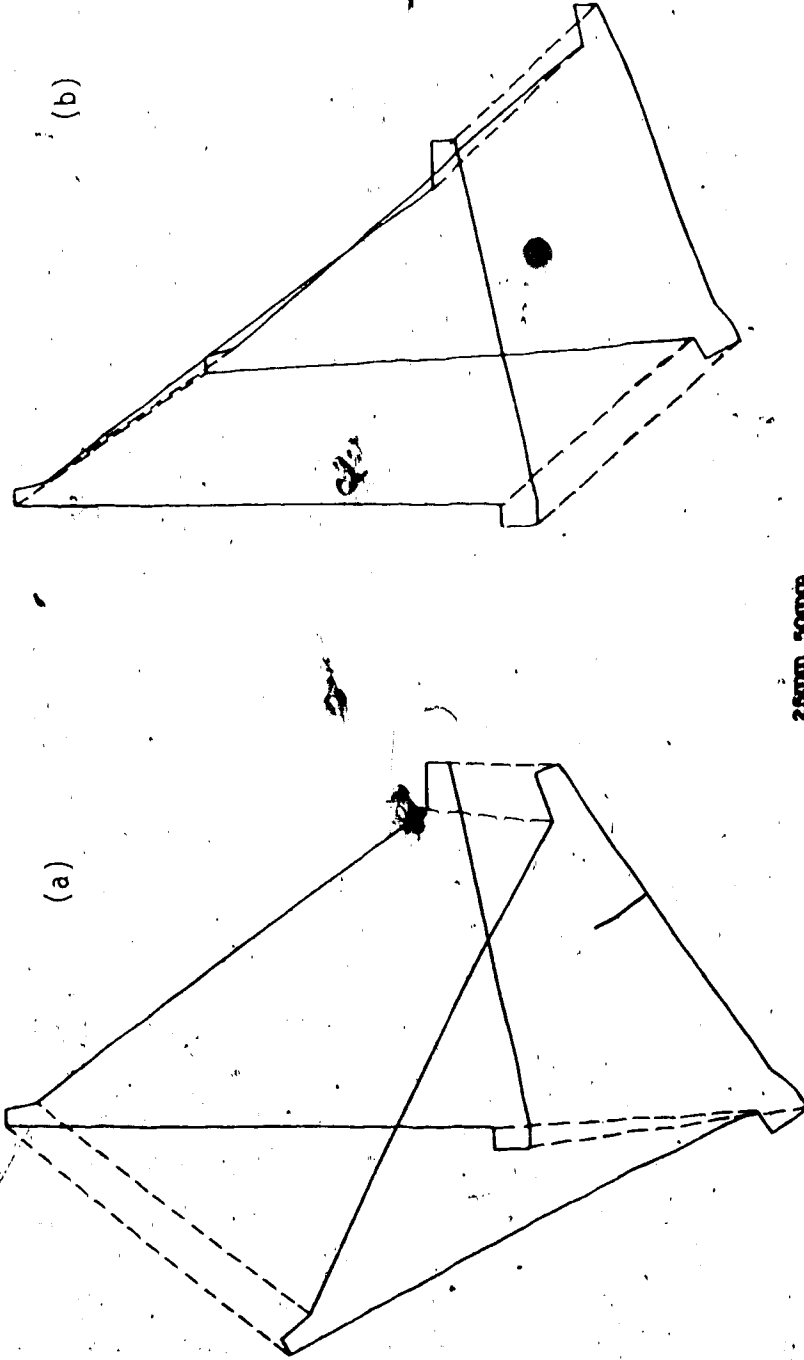

FIG. 3.4.6 DISPLACEMENTS OF THE DAM FOR A CRACK GOING 1.0 H INTO THE FOUNDATION ROCK (a) FOR LOW RESERVOIR LEVEL, EL. 2040 m. (b) FOR HIGH RESERVOIR LEVEL, EL. 2125 m.

variations of the concrete. For the period studied the temperature variations are certainly not high enough to account for a substantial decrease of the end result quoted above.

During the year 1968, the water level increased by the same amount as in 1966, the initial and final level being also the same. The results obtained by the numerical analyses would then remain constant. It is interesting to note that the differential settlement between point 3c and 1c in the foundation gallery has, in 1968, decreased to 6 mm., therefore increasing the ratio $E_{\text{predicted}}/E_{\text{measured}}$ to 4.15. Would this fact mean that the stiffness of the rock foundation of Alpe Gera has increased between 1966 and 1968? If we assume that, from 1966 the foundation behaved elastically and we evaluate what the differential settlement between point 3c and 1c has been, for an increase of 85 m. in the water level we find that:

- i) in 1966 Diff. Settlement = 7.5 mm.
- ii) in 1967 Diff. Settlement = 6.15 mm.
- iii) in 1968 Diff. Settlement = 6.0 mm.

This decrease in the differential settlement over that period suggests that, indeed there has been a stiffening of the foundation rock. Naturally, the improvement of the quality of the foundation rock at Alpe Gera does not constitute the critical conditions for the analysis of foundation behaviour. But, it is of interest to see that the competence of the rock has increased over the period of three years.

3.4.4 Comparison of Actual Behaviour with the Predicted

The overall modulus of elasticity obtained previously, for

the conditions represented by Figures 3.4.6(a) and (b) was based on the comparison of vertical movements of the dam. Figure 3.4.7 shows the measurements of the deflection of block No. 9. It is assumed here that the deflection of block No. 9 is representative of the one which happened in block No. 10 due to their proximity. The curve of interest to us, is curve 'd', showing the displacements measured in the foundation gallery, at point 3c. Between the low and high reservoir level of 1966, a horizontal movement of 5 mm. has been measured. A displacement of 50 mm. is predicted by our analyses. Therefore, the ratio existing here would be equal to 10, implying a modulus of 10^6 Kg/cm² to account for the measured horizontal movements. Obviously, such a high value for a serpentine schist is rather unrealistic. Since this ratio had been obtained assuming full hydrostatic pressure applied down to a depth equal to the height of the dam into the foundation rock, we have investigated the effect of varying the depth of cracking on the rotation and the horizontal displacements of the structure. Figures 3.4.8(a) and 3.4.8(b) show the rotation and horizontal displacements respectively. The movements of the whole structure are also shown from Fig. 3.4.9 to Fig. 3.4.11 for different depths of cracking. Figure 3.4.8 indicates that a decrease in the depth of cracking induces a decrease in the rotation and the horizontal displacements of the dam.

By careful examination of Table 3.4.1 we note that for the hydraulic chamber tests the direction in which the displacements had been minimum was the horizontal one, and that the vertical direction had undergone the maximum displacements. Furthermore, we

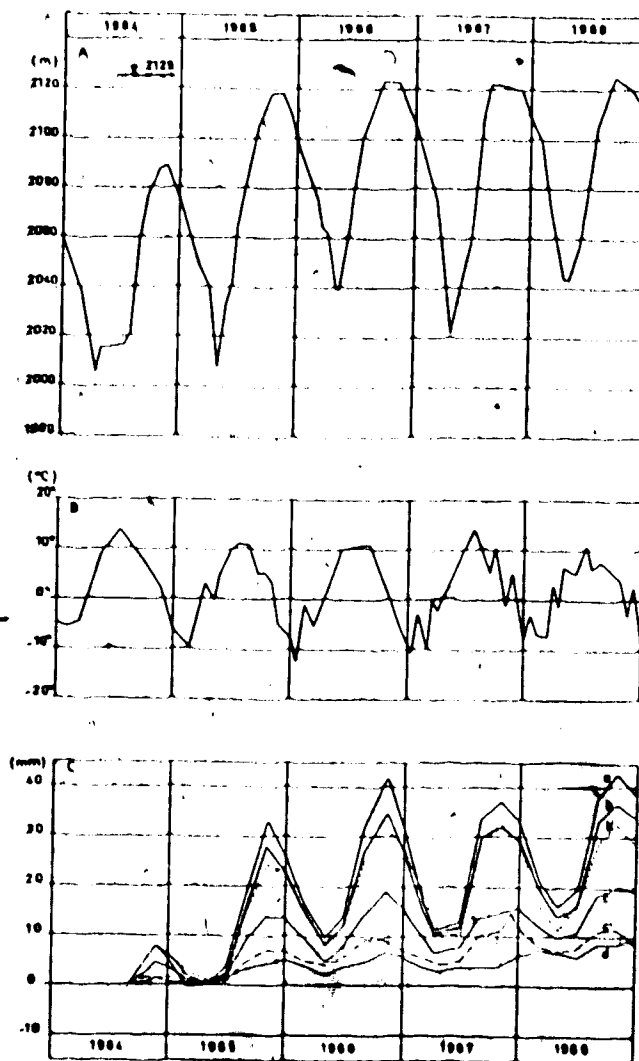

FIG. 3.4.7 DEFLECTION OF BLOCK NO. 9
 (A) IMPOUNDMENT (B) EXTERNAL TEMPERATURE
 (C) DEFLECTIONS MEASURED (d) DEFLECTIONS
 MEASURED BY PENDULUM AT EL. 1981.25 m.
 (FROM C. TERRACINI, 1970)

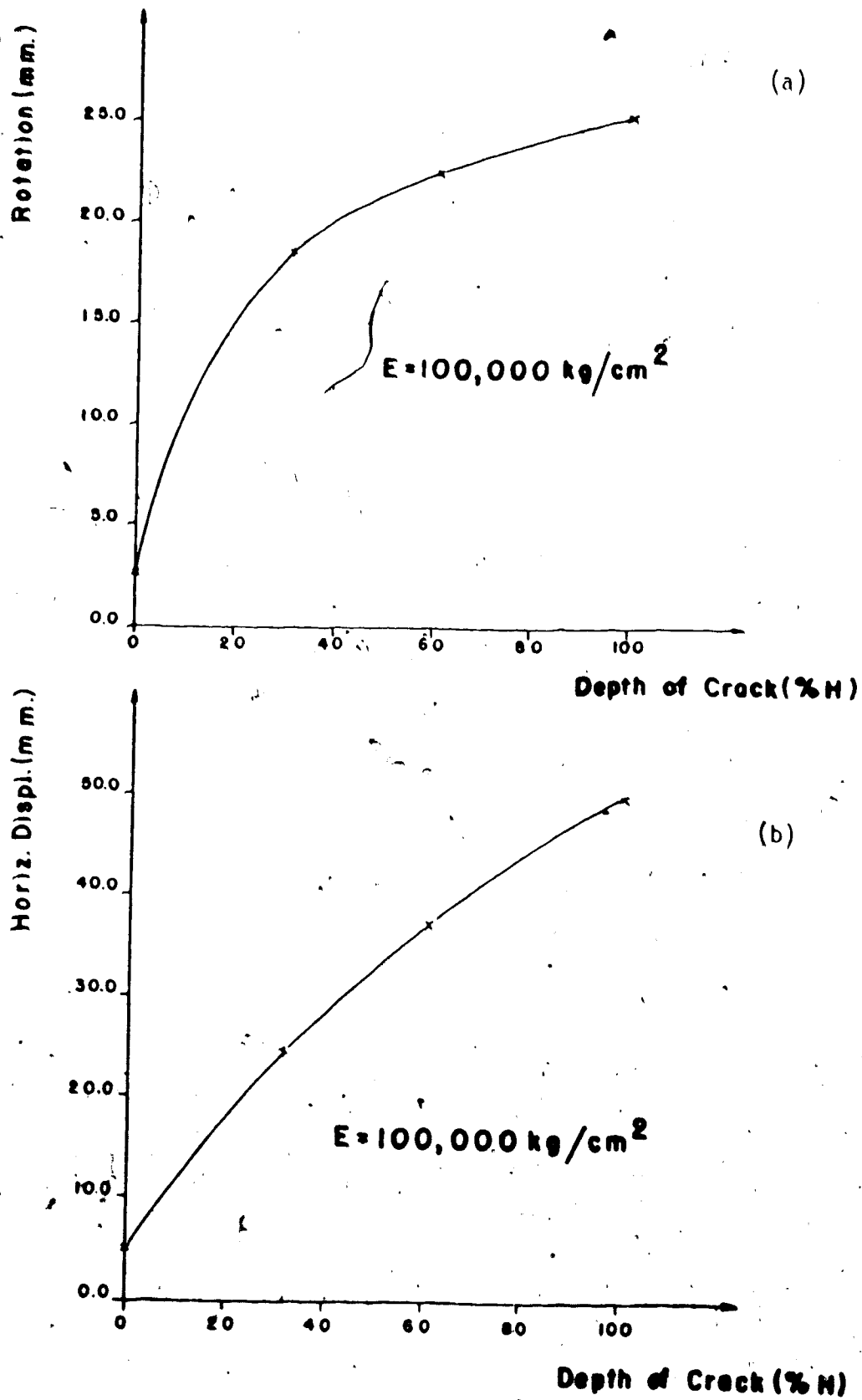

FIG. 3.4.8 (a) ROTATION OF THE FOUNDATION (VS) DEPTH OF CRACKING
 (b) HORIZONTAL DISPLACEMENT OF POINT 3c (VS) DEPTH OF CRACKING

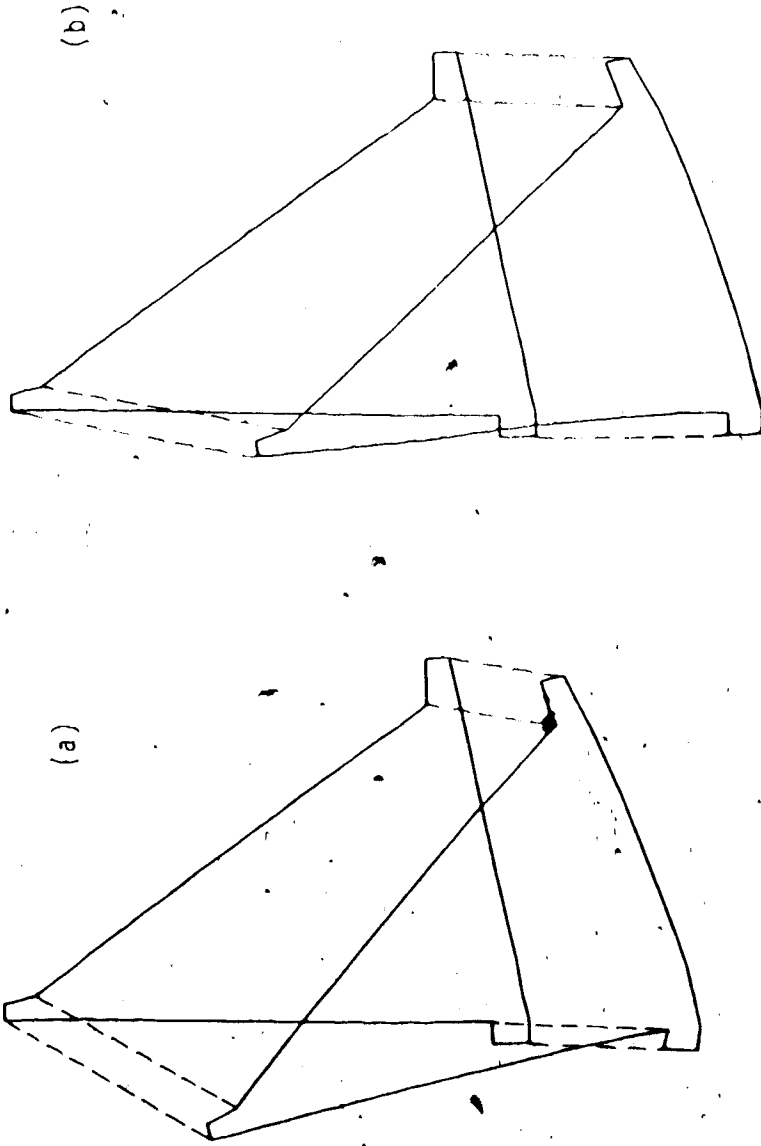

FIG. 3.4.9 DISPLACEMENTS OF THE DAM ASSUMING NO CRACK GOING INTO THE FOUNDATION ROCK (a) FOR LOW RESERVOIR LEVEL, EL. 2040 m. (b) FOR HIGH RESERVOIR LEVEL, EL. 2125 m.

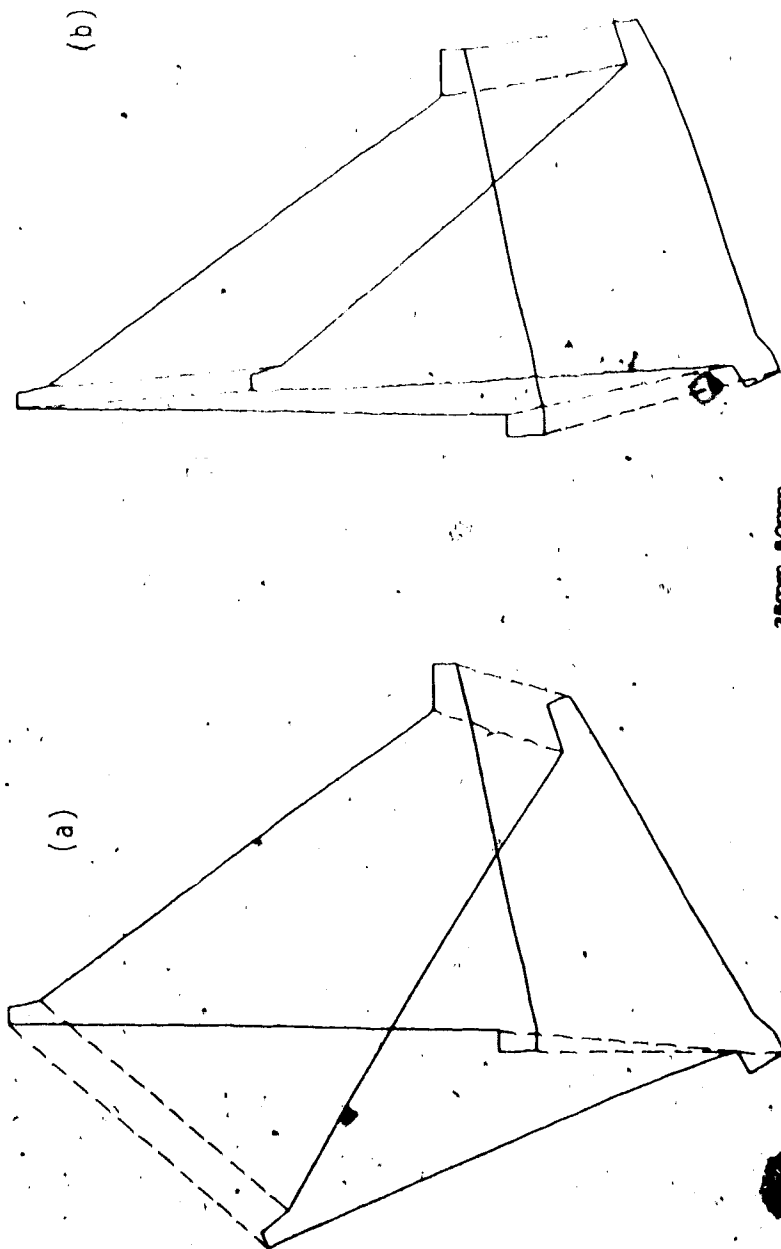

FIG. 3.10 DISPLACEMENTS OF THE DAM FOR A CRACK GOING 0.3 H INTO THE FOUNDATION ROCK (a) FOR LOW RESERVOIR LEVEL, EL. 2040 m. (b) FOR HIGH RESERVOIR LEVEL, EL. 2125 m.

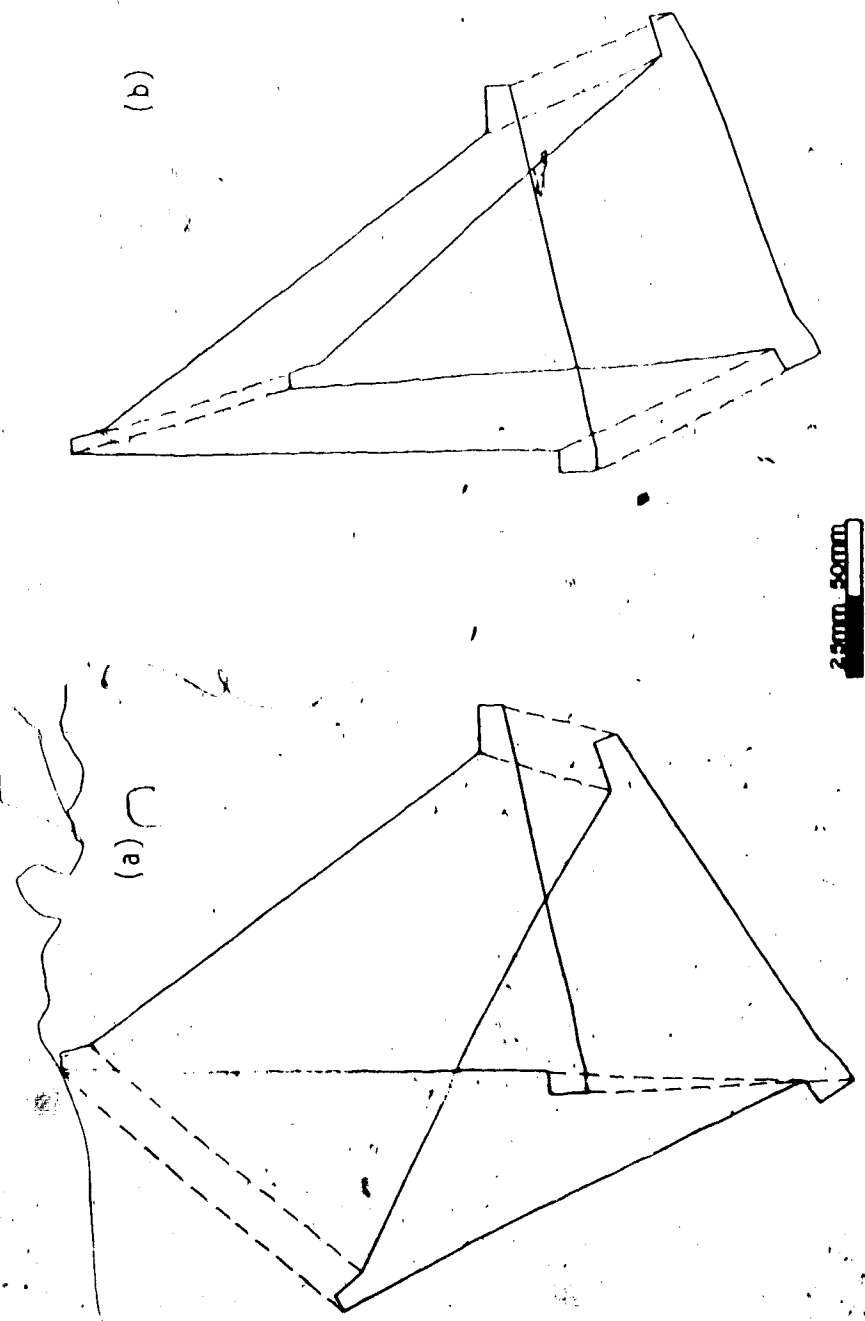

FIG. 3.4.11 DISPLACEMENTS OF THE DAM FOR A CRACK GOING 0.6 H INTO THE FOUNDATION ROCK (a) FOR LOW RESERVOIR LEVEL, EL. 2040 m. (b) FOR HIGH RESERVOIR LEVEL, EL. 2125 m.

see that the jacking tests have been performed in the horizontal and vertical direction, giving a higher horizontal modulus than the vertical. Therefore, both in situ tests agreed in indicating that the rock was anisotropic.

Let us define the anisotropy factor as $A.F. = E_h/E_v$, E_h being the horizontal modulus and E_v , the vertical one. Since the jacking tests have been done in the directions of concern to us in the analysis of Alpe Gera dam, the moduli they have given were the ones used to obtain the anisotropy factor of the rock. The first test gave $A.F. = 2.9$, the second $A.F. = 1.14$ averaging at $A.F. = 2.0$.

If we now go back to Fig. 3.4.8 and try to find the depth of cracking that would make the ratio of the overall horizontal modulus over the overall vertical modulus become 2.0, we find that this depth would have to be equal to $0.3H$. Table 3.4.2 summarizes the above paragraph.

As seen from the Table, an overall vertical modulus of $244,000 \text{ Kg/cm}^2$ would be necessary to account for the measured rotation whereas an overall horizontal modulus of $492,000 \text{ Kg/cm}^2$ would predict the correct horizontal displacements.

If we compare the above values with the average of the horizontal moduli and vertical moduli obtained from the jacking tests, we find a ratio of 2.06 for the vertical and a ratio of 2.3 for the horizontal. That is to say, the jacking tests have underestimated by a factor varying from 2.0 to 2.3 the stiffness of the foundation rock of Alpe Gera.

It is therefore suggested that the behaviour of Alpe Gera

TABLE 3.4.2

OVERALL, HORIZONTAL AND VERTICAL MODULUS
OF DEFORMATION FOR DEPTH OF CRACKING = 0.3H

Depth of Crack	Type of Displacement	$E_{hor.}$ Kg/cm ²	$E_{vert.}$ Kg/cm ²	Predicted (mm)	Measured (mm)	$\frac{\text{Predicted}}{\text{Measured}}$	$E_{\text{Overall Horizontal}}$ (Kg/cm ²)	$E_{\text{Overall Vertical}}$ (Kg/cm ²)	A.F.
0.3H	Rotation	100,000	100,000	18.3	7.5	2.44	244,000		2.01
	Horizontal	100,000	100,000	24.6	5.0	4.92	492,000		

dam corresponds to one for which a crack has developed down to a depth of $0.3H$ into the foundation rock, the rock having a horizontal modulus of deformation of $492,000 \text{ Kg/cm}^2$ and a vertical modulus of $244,000 \text{ Kg/cm}^2$.

3.5 Analysis of Bhakra Dam

3.5.1 Introduction

Bhakra dam is situated about 120 miles north-west of New Delhi in India, in the outer foothills of the Himalayas. The dam provides irrigation, power and flood control by blocking the waters of the Sutlej river.

The structure is a straight gravity dam having a height of 225.6 meters and a base width of about 180 meters between the dam axis and the spillway apron section. The upstream face of the spillway section is vertical from the top at EL. 518 m. to EL. 395 m. Below that point, it slopes at 1:0.35 for a height of 26 m., then slopes at 1:0.88 and 1:2.0 to reach EL. 328 m. The downstream face of the dam has a slope of 1:0.8. Figure 3.1 shows the different characteristics of the spillway section.

The main material encountered in the foundation of Bhakra dam is sandstone. This sandstone is interbedded with mudstone. In the vicinity of the dam there are three major claystone/siltstone bands:

i) the heel claystone band located about 30 meters upstream of the dam axis and dipping at an angle of about 70° to 75° degrees downstream. Its width varies from 30 to 45 meters. A concrete strut, 23 meters thick was extended from the dam to the clay band to transfer the loads to the upstream sandstone.

ii) the middle claystone band having a width varying from 6 to 9 meters.

iii) the downstream claystone band situated under the last

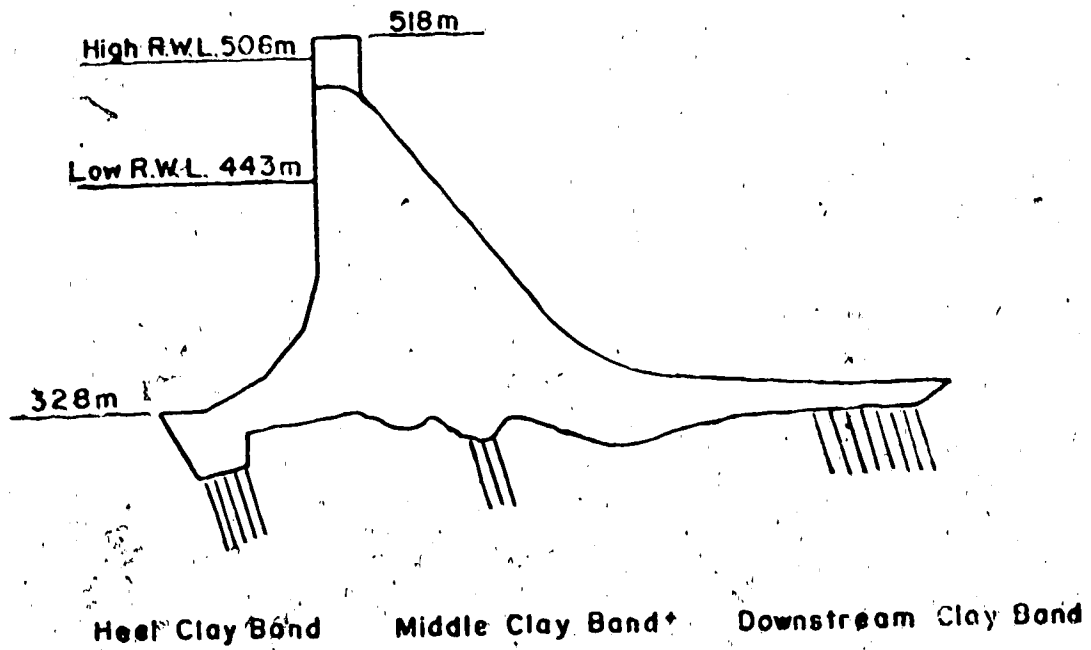

FIG. 3.5.1 MAXIMUM SPILLWAY SECTION

55 meters of the spillway apron. This band does not affect the stability of the dam but could influence the behaviour of the left power plant since this last one is founded partly on sandstone and partly on the claystone band.

The position of these three major bands with respect to the dam is shown on Fig. 3.5.1. Several shear zones are also present in the foundation.

3.5.2 Method of Investigation and Values Assumed for the Study

The deformability of the foundation rock at the Bhakra dam site was studied by jacking tests performed on the right and left bank of the river. The jack, of a hydraulic type, had a capacity of 200 long tons and distributed its load on an area of 920 cm^2 . The displacements were measured between the two faces of the gallery using extensometers capable of a precision of .0025 mm. The different features of the jacking test are presented in Fig.

3.5.2.

Table 3.5.1 shows the results of the jacking tests. The initial tests done gave relatively low values. The results of those tests are shown in the Table under ungrouted conditions. On the basis of the trial load analysis, which was the method of design for the Bhakra project, a maximum stress, in the rock, of 460 psi (32.3 Kg/cm^2) had been calculated. In the Table under item 3 and 4, for a stress range corresponding to the maximum predicted value, we find a modulus of deformation ranging from 498,000 psi ($35,000 \text{ Kg/cm}^2$) to 788,000 psi ($55,375 \text{ Kg/cm}^2$) and averaging at 620,000 psi ($43,570 \text{ Kg/cm}^2$) for the rock in a natural state. If we now

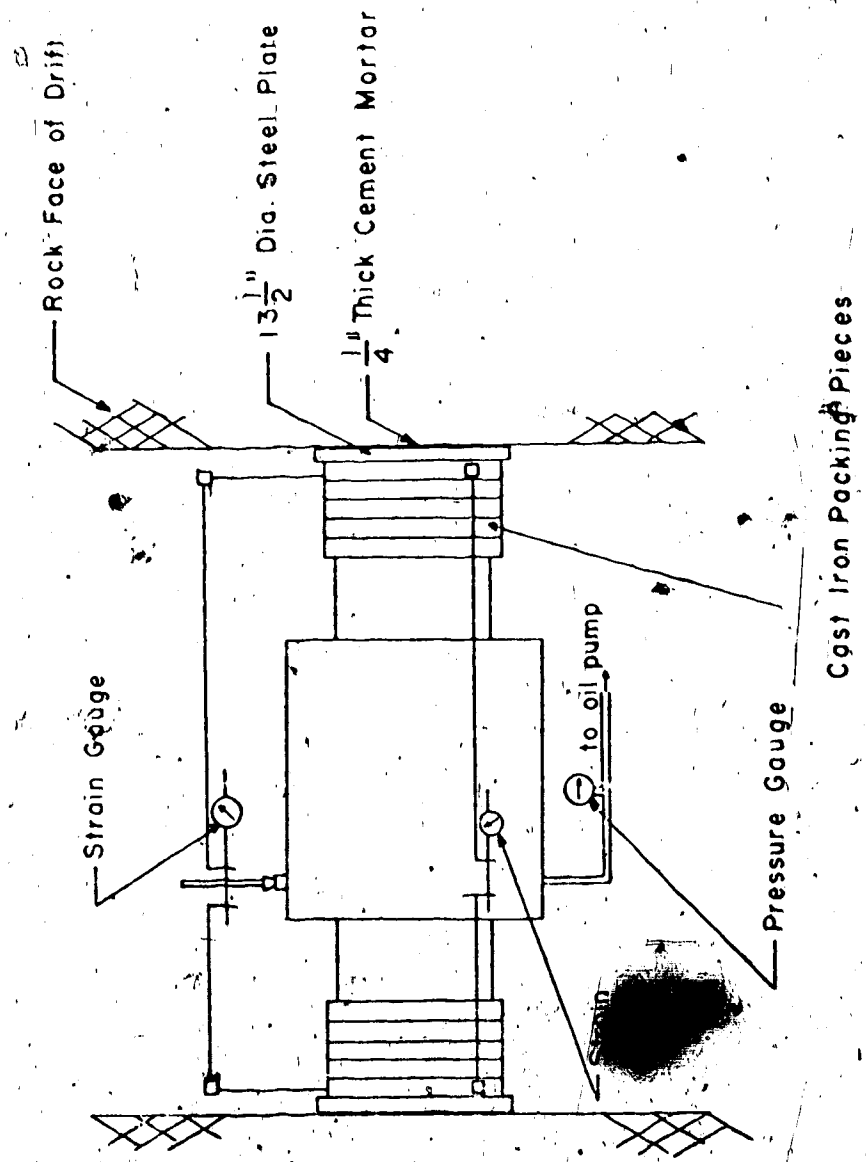

FIG. 3.5.2 HYDRAULIC JACKING TEST ASSEMBLY

Item	Type of rock	Location	Cycle	Stress range psi	E psi
3	Good sandstone ungrouted	Left Diversion Tunnel	1st	279-841	0.788×10^6
			2nd	279-841	0.72×10^6
			3rd	279-841	0.51×10^6
4	Good sandstone ungrouted	Left Diversion Tunnel	1st	279-1840	0.564×10^6
			2nd	279-1840	0.681×10^6
			3rd	279-1840	0.686×10^6
5	Claystone ungrouted	Right Diversion Tunnel	1st	279-838	0.424×10^6
			2nd	279-2524	0.397×10^6
6	Claystone ungrouted	Right Diversion Tunnel	1st	279-838	1.056×10^6
			2nd	279-2524	1.1×10^6
7	Crushed claystone ungrouted	Left Diversion Tunnel	1st	279-526	0.821×10^6
			2nd	279-526	0.768×10^6
			3rd	279-526	0.746×10^6
8	Crushed claystone ungrouted	Left Diversion Tunnel	1st	279-786	0.417×10^6
			2nd	279-786	0.549×10^6
			3rd	279-786	0.504×10^6
9	Shattered sandstone wet ungrouted	Right Diversion Tunnel	1st	279-526	0.074×10^6
			2nd	279-526	0.169×10^6
			3rd	279-526	0.182×10^6
10	Crushed sandstone ungrouted	Right Diversion Tunnel	1st	279-786	0.132×10^6
			2nd	279-786	0.224×10^6
			3rd	279-786	0.237×10^6
11	Crushed sandstone (After grouting but washing done with water only)	Drift 26R	1st	419-838	0.545×10^6
			2nd	419-838	0.508×10^6
12	Crushed sandstone (After grouting but washing done with air and water)	Drift 26R	1st	263-526	8.53×10^6
			1st	263-1052	7.10×10^6
			2nd	263-526	7.92×10^6
			3rd	263-1052	4.37×10^6
13	Good sandstone (Before grouting)	Drift in El. 1428 Grouting & Drainage Tunnel loading parallel to the bedding planes	1st	525-1050	2.91×10^6
			2nd	525-1050	4.84×10^6
			3rd	525-1050	4.31×10^6
			4th	525-1050	5.14×10^6
14	Good sandstone (After grouting)	do	1st	525-1050	6.0×10^6
			2nd	525-1050	21.9×10^6 (*)
			3rd	525-1050	20.1×10^6 (*)
			4th	525-1050	22.9×10^6 (*)

(*) Observations not reliable.

TABLE 3.5.1 RESULTS OF MODULI OF DEFORMATION MEASURED BY THE JACKING TEST (FROM P.S. BHATNAGAR, S.R. SHAH, 1964)

(CONTINUED)

Item	Type of rock	Location	Cycle	Stress range psi	E psi
15	Good sandstone (Before grouting)	Drift in El. 1428 Grouting & Drainage Tunnel loading parallel to the bedding planes	1st	525-2100	4.25×10^6
			2nd	525-2100	4.37×10^6
			3rd	525-2100	3.90×10^6
			4th	525-2100	3.31×10^6
			5th	525-2100	6.45×10^6
16	Good sandstone (After grouting)	do	1st	525-2100	4.58×10^6
			2nd	525-2100	14.55×10^6 (*)
			3rd	525-2100	13.32×10^6 (*)
17	Good sandstone (Before grouting)	do	1st	525-3150	2.69×10^6
			2nd	525-3150	2.30×10^6
			3rd	525-3150	2.94×10^6
18	Good sandstone (After grouting)	do	1st	525-3150	4.65×10^6
			2nd	525-3150	5.29×10^6
			3rd	525-3150	5.38×10^6
			4th	525-3150	2.45×10^6
19	Shattered sandstone (Before grouting)	Drift in El. 1548 Grouting & Drainage Tunnel loading parallel to bedding planes	1st	525-1050	1.68×10^6
			2nd	525-1050	4.61×10^6
			3rd	525-1050	5.36×10^6
			4th	525-1050	
20	Shattered sandstone (After grouting)	do	1st	525-1050	2.94×10^6
			2nd	525-1050	3.06×10^6
			3rd	525-1050	2.59×10^6
21	Shattered sandstone (After grouting)	Drift in El. 1548 Grouting & Drainage Tunnel loading perpendicular to bedding planes	1st	525-1050	2.26×10^6
			2nd	525-1050	2.33×10^6
			3rd	525-1050	2.34×10^6
			4th	525-1050	
22	Shattered sandstone (Before grouting)	Drift in El. 1548 Grouting & Drainage Tunnel loading parallel to bedding planes	1st	525-2100	1.085×10^6
			2nd	525-2100	1.242×10^6
			3rd	525-2100	2.16×10^6
			4th	525-2100	2.515×10^6
23	Shattered sandstone (After grouting)	do	1st	525-2100	2.01×10^6
			2nd	525-2100	2.11×10^6
			3rd	525-2100	1.964×10^6
24	Shattered sandstone (After grouting)	do	1st	525-3150	1.98×10^6
			2nd	525-3150	2.07×10^6
			3rd	525-3150	2.095×10^6

(*) Observations not reliable.

look at items 13, 15 and 17, for stress ranges higher than the expected maximum we find a modulus of deformation ranging from 2.30×10^6 psi (161,630 Kg/cm²) to 5.14×10^6 psi (361,210 Kg/cm²) and averaging at 3.95×10^6 psi (277,580 Kg/cm²).

Of concern to the designers, were the low values found for the anticipated stress range. Investigations were then carried out to see what relative improvement could be achieved by grouting the rock. In doing so, it was found that to reach an acceptable increase in the competence of the rock, grouting had to be done after washing of a certain area with air and water. The results of the tests performed after grouting are also shown in Table 3.5.1.

The moduli of deformation obtained after grouting ranged from 1.98×10^6 psi (139,140 Kg/cm²) to 8.53×10^6 psi (599,440 Kg/cm²) and averaged at 3.81×10^6 psi (267,745 Kg/cm²). This increase in the modulus value allowed the designers to use a design modulus of deformation of 2.5×10^6 psi (175,685 Kg/cm²). It is to be noted that the foundation rock at Bhakra was grouted up to about 15 meters upstream of the heel, 20 meters downstream of the toe, and down to a depth of 15.2 meters in between.

In the analysis of Bhakra dam two materials were taken into account, the concrete of the dam and the foundation rock. As measured by the constructors of the structure, the following characteristics of the concrete were entered in the numerical analysis:

Unit Weight	=	2.44 Tm/m ³
Poisson's Ratio	=	0.17
Modulus of Elasticity	=	267,000 Kg/cm ²

With respect to the rock, the same assumptions as for the studies of Krasnoyarsk and Alpe Gera dam were made i.e.

Unit Weight =	0.0
Poisson's Ratio =	0.2
Modulus of Elasticity =	100,000 Kg/cm ²

The finite element mesh used in the study of Bhakra dam is shown in Fig. 3.5.3. The maximum spillway section, at the center of the dam, was the one which was analyzed. This section is section #20.

3.5.3 Results of Predicted and Measured Displacements

i) Gravity Analysis

A gravity analysis of the structure was undertaken to see what would be its configuration prior to water loading. The displacements of the dam are shown in Fig. 3.5.4.

ii) Gravity plus Water Load Analysis (Assumption of a Crack below the Heel of the Dam)

The observation of the behaviour of Bhakra dam consisted of measuring the deflections of the structure, recorded by plumb lines, and to measure settlements of benchmarks fixed in a gallery at EL. 373.4 m. The horizontal deflections were measured relative to a point in a gallery at EL. 336.8 m. which was assumed to be fixed. Due to this fact, horizontal movements of the structure were not taken into account in the present study. Permanent settlement readings were started in December 1963 and continued ever since. Impounding had started in 1958 which means that up to 1963 the foundation rock has been subjected to cyclic loading and unloading by the reservoir water. Figure 3.5.5 shows the settlements of six benchmarks together with the variation of the reservoir water level from December 1963. In the

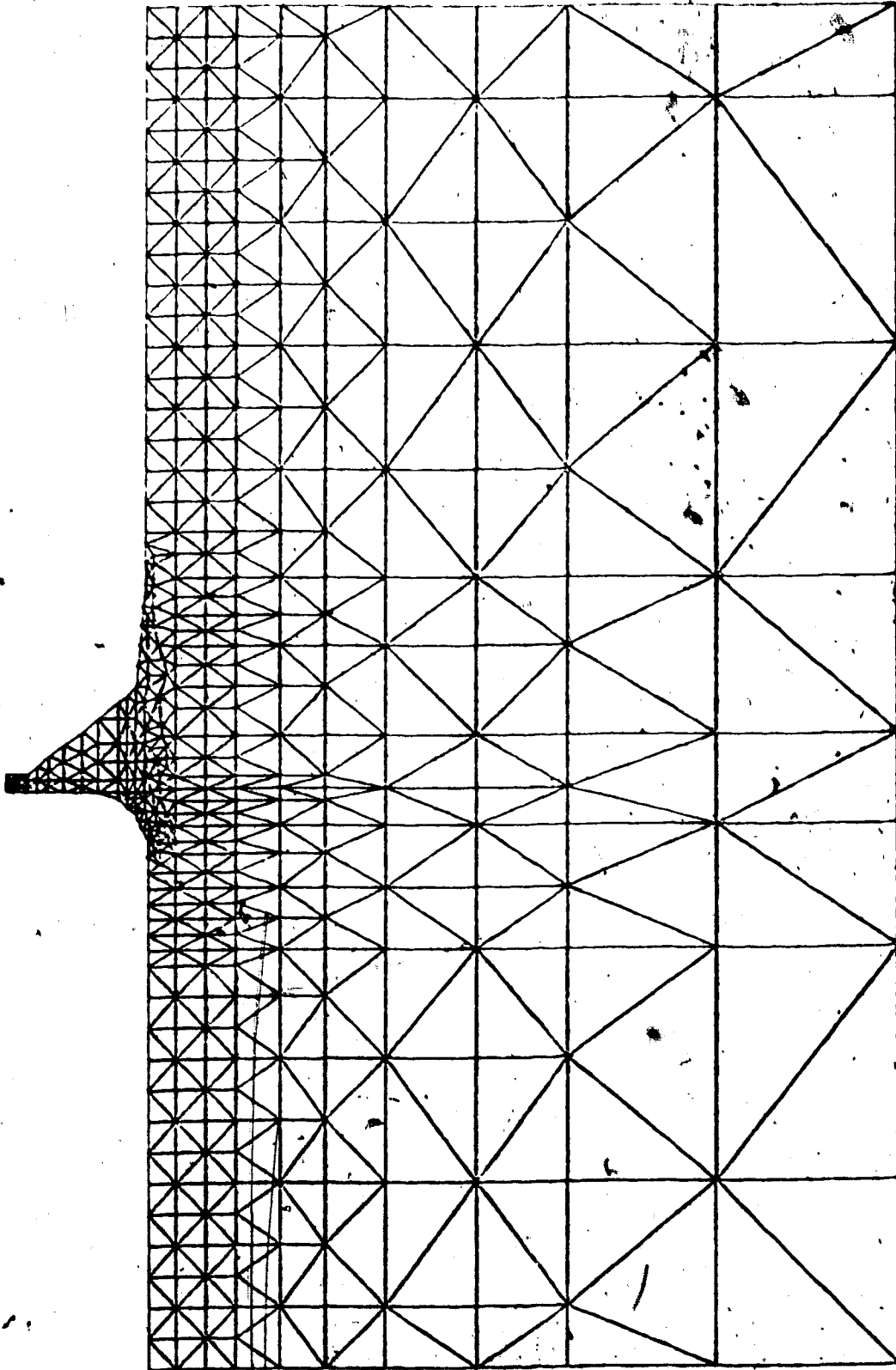

FIG. 3.5.3 FINITE ELEMENT MESH USED IN THE STUDY OF BHAKRA DAM

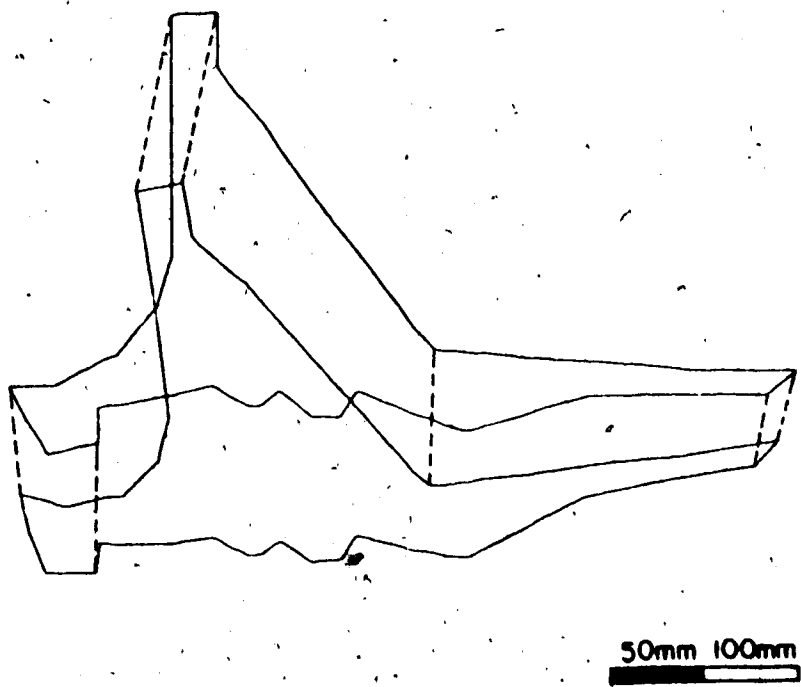

FIG. 3.5.4 DISPLACEMENTS DUE TO GRAVITY ONLY

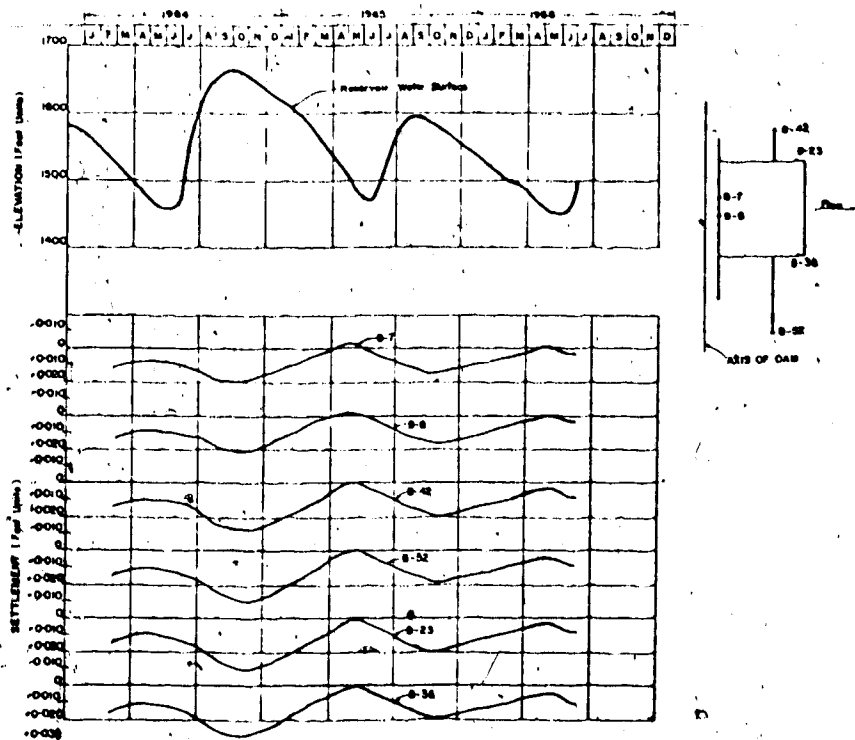

FIG. 3.5.5 SETTLEMENTS OF BENCHMARKS
 (FROM BHATNAGAR ET AL.,
 1967)

following analyses we will investigate the variation in settlement from low water level, EL. 443.5 m. (1455 feet) to the high water level of 1964 at EL. 506 m. (1660 feet).

Up to August 1963, the dam behaved normally. In the period including September and October 1963, extensive leakage was measured through cracks in the transverse strut gallery. Two pipes had been installed for uplift pressure measurement at the concrete-rock contact at the upstream extremity of the strut. These two pipes started registering full hydrostatic pressure on August 30, 1963. The observation of cracks in the transverse strut gallery and the leakage indicated that separation of the strut from the dam had occurred at or near the longitudinal joint plane, 23 meters upstream of the dam axis, in a direction normal to the strut surface slope. In our analyses, since the strut was separated completely from the dam body, a crack was assumed through it where full hydrostatic pressure was developed. Also, full reservoir head was applied around the strut, on the rock, up to approximately the heel of the dam. Figure 3.5.6 shows the loading conditions on the structure.

As mentioned above, the dam was loaded with the low and high reservoir level of 1964. The water reached elevation 506 m. (1660 feet) at the end of September 1964. Table 3.5.2 shows the measurements of uplift pressures, expressed as a percentage of net head, for different sections of the dam. As we can see, the uplift at section #20 was practically non-existent. For this reason, uplift loading on the base of the dam was neglected in the analyses.

At this stage, consideration has to be given to the fact that the analyses assumed plane strain conditions even if Bhakra dam

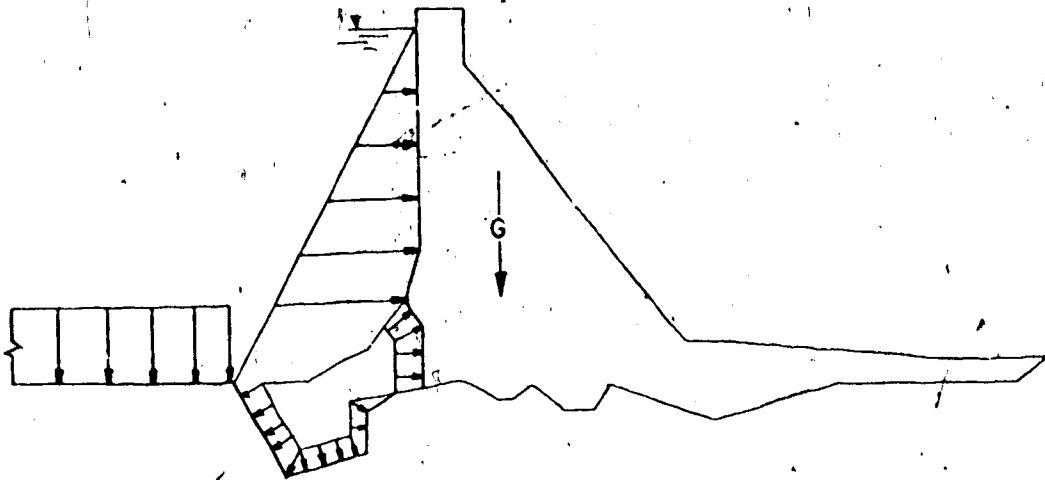

FIG. 3.5.6 LOADING CONDITIONS ON THE DAM AND FOUNDATION AFTER SEPARATION OF THE STRUT

Date : October 3, 1964. Res. water surface El. 1661.60

PIPE	A	B	C	D	E	F	G	H	I	J	K
Block 9	X	42.25	80.25								
Line 1	Design %	26	14								
Sta 7 + 33	Actual %	Dry	Dry								
Block 12	X	25.0	85.0								
	Design %	43	25								
	Actual %	Dry	10.29								
Block 15	X	32.25	62.25	142.25	202.25	254.0					
	Actual %	33	30	20	13	7					
	Design %	4.83	Dry	18.82		4.70					
Block 18	X	52.25	91.25	137.25	212.25	268.25	324.25	424.25	524.25		
	Design %	43	30	27	23	19	16	9	3		
	Actual %	4.69		Dry							
Block 20	X	135.0	0.0	31.75	76.75	121.75	166.75	266.75	336.75	436.75	536.75
	Design %		49	33	30	28	25	19	15	9	3
	Actual %	Choked									
Block 22	X	31.75	65.0	168.0	276.0	326.0	421.0				
	Design %	33	31	25	19	16	10				
	Actual %	Plugged	0.46		3.28						
Block 25	X	32.25	97.25	167.0	235.0						
	Design %	48	26	18	11						
	Actual %	20.69	9.59	Plugged	5.87						
Block 28	X	1.17	100.25	220.25							
	Design %	87	23	7							
	Actual %	51.75	Dry	Dry							

(X) Denotes distance from axis of dam in feet, positive in the downstream direction and negative in the upstream direction.
 (°) Denotes R.W.L. below average bottom elevation of pipes or below the tail water level.
 (Dry) Indicates the pipe to be dry in case of straight pipes and water below elevation of bend in case of bent pipes.

TABLE 3.5.2 UPLIFT PRESSURES UNDER THE DAM EXPRESSED AS PERCENTAGE OF NET HEAD
 (FROM P.S. BHATNAGAR, I.P. KAPILA, R.P. SHARMA, 1967)

is located in a narrow gorge. At section #20, a deflection parallel to the dam axis of the order of 2.5 mm. was measured. This displacement was directed towards the left bank. It is not felt that such a small displacement is enough to abandon the plane strain assumption.

By looking at the mode of vertical displacement shown on Fig. 3.5.5, it was expected that, at the most, a shallow crack, below the heel of the dam could develop. We see that for the water level variation to which the structure was subjected, settlements increase as the water level increases and vice-versa. In the past experience, i.e. the studies of Krasnoyarsk and Alpe Gera dams, we saw that, for a water level range going from about 50% to 90% of the dam height, settlements changed direction. This was based on the assumption of a crack in the foundation rock, below the heel of the dam. Bhakra dam departs from this behaviour. Cracking was therefore assumed down to a depth of $0.35H$ as a starting assumption. Figure 3.5.7(a) and (b) show the settlement of the structure under the specified loading. At low level, the displacement corresponding to benchmarks B-7 and B-8, situated in the plane of the dam axis, was 135 mm. Raising the reservoir level gave us a displacement of 131 mm. Therefore the dam has moved up by 4 mm.

The second analysis assumed a crack down to $0.15H$ in the foundation. The displacements are shown on Fig. 3.5.8(a) and (b). The low level gave a vertical displacement of 131 mm. and the high level a displacement of 136 mm. On the basis of this assumption we had an increase of 5 mm. in the settlement value.

The final analysis looked at the conditions where no crack was present in the foundation rock. The displacements corresponding

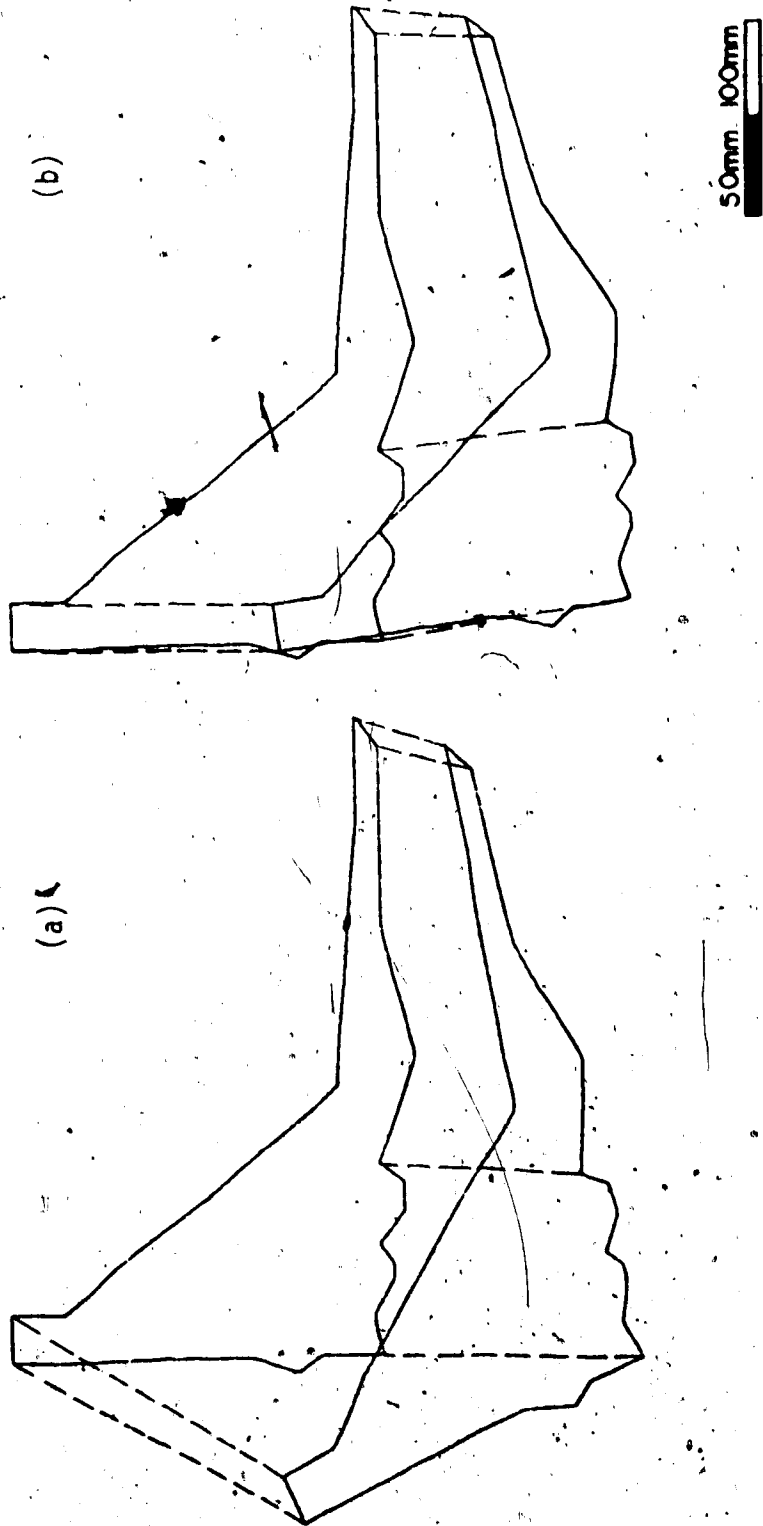

FIG. 3.5.7. DISPLACEMENTS OF THE DAM FOR A CRACK GOING 0.35H INTO THE FOUNDATION ROCK
(a) FOR LOW RESERVOIR LEVEL, EL. 443.5 m. (b) FOR HIGH RESERVOIR LEVEL,
EL. 506 m.

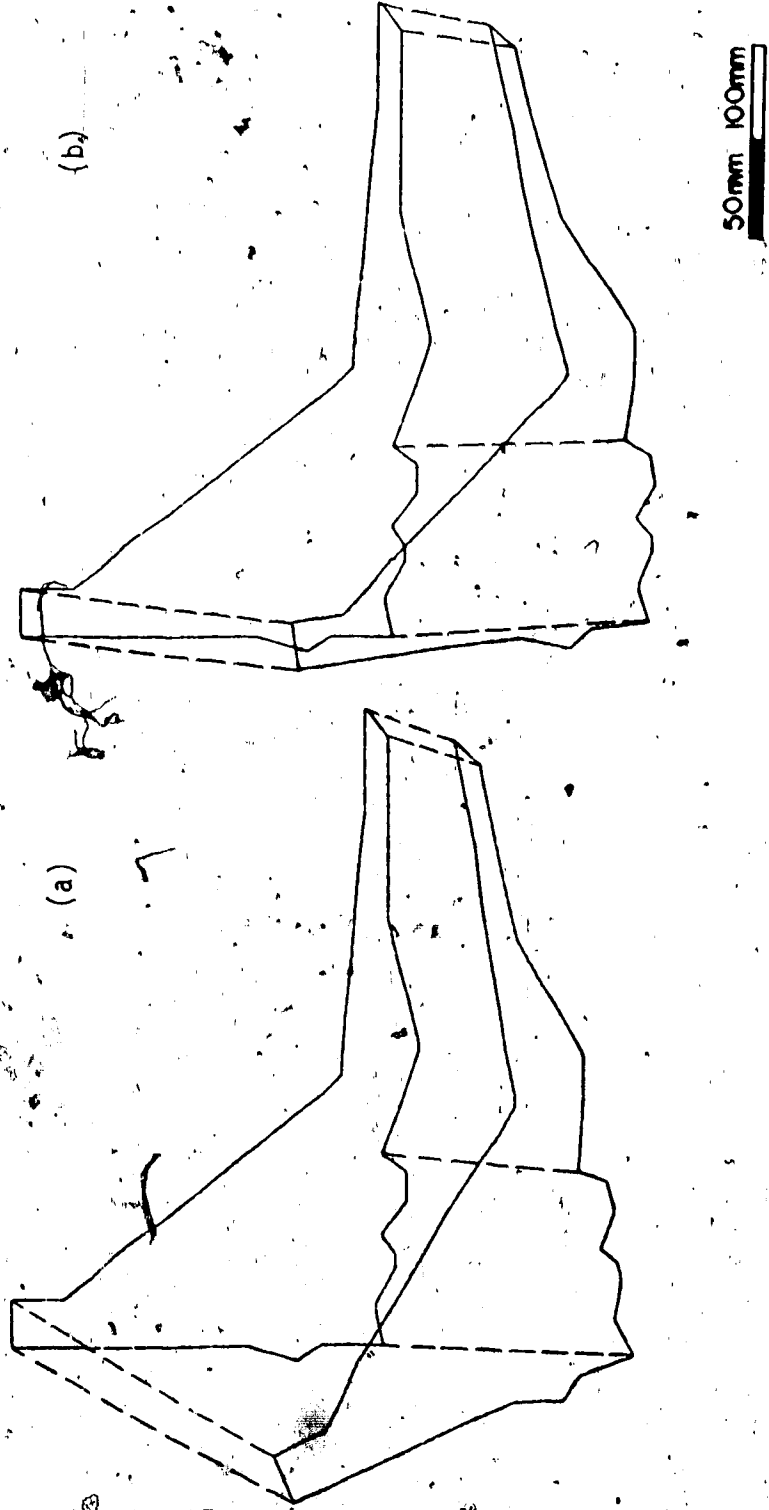

FIG. 3-5.8 DISPLACEMENTS OF THE DAM FOR A CRACK GOING 0.15H INTO THE FOUNDATION ROCK
(a) FOR LOW RESERVOIR LEVEL, EL. 443.5 m. (b) FOR HIGH RESERVOIR LEVEL,
EL. 506 m.

to this situation are shown in Fig. 3.5.9(a) and (b). Under the low reservoir level, a vertical displacement of 128 mm. was predicted. Increasing the reservoir level to EL 506 m. gave a final settlement of 142 mm. Under the conditions of no crack, we find that the dam is subjected to an increase in settlement of 14 mm.

For benchmarks B-7 and B-8 which were situated in the middle of the dam, Fig. 3.5.5 gives us an increase of 4 mm. in the vertical displacement. Comparing this value to the variation of settlement obtained for the second analysis (Depth of Crack = 0.15H) we find a ratio of 1.25 between the predicted and the measured. If we now compare the measured settlement to the one obtained in the final analysis (No Crack), we find a ratio of 3.5 between the predicted and the measured. The ratios of 1.25 and 3.5 give an overall value for the modulus of elasticity of 125,000 Kg/cm² and 350,000 Kg/cm² respectively. Comparison has now to be made with the in situ measured values. In Section 3.5.2 we have quoted a value of 43,570 Kg/cm² for the modulus of deformation of the rock in a natural state. Consequently $E_{\text{overall}}/E_{\text{measured}} = 2.87$ for a depth of cracking equal to 0.15H and $E_{\text{overall}}/E_{\text{measured}} = 8:0$ for the no-crack analysis.

Comparison of the same moduli with the ones measured after grouting and averaging at 267,745 Kg/cm² gives the following ratios:

$$\frac{E_{\text{overall}}}{E_{\text{measured}}} = 0.47 \text{ for crack} = 0.15H$$

and

$$\frac{E_{\text{overall}}}{E_{\text{measured}}} = 1.30 \text{ for the no-crack analysis}$$

Table 3.5.3 summarizes the above results.

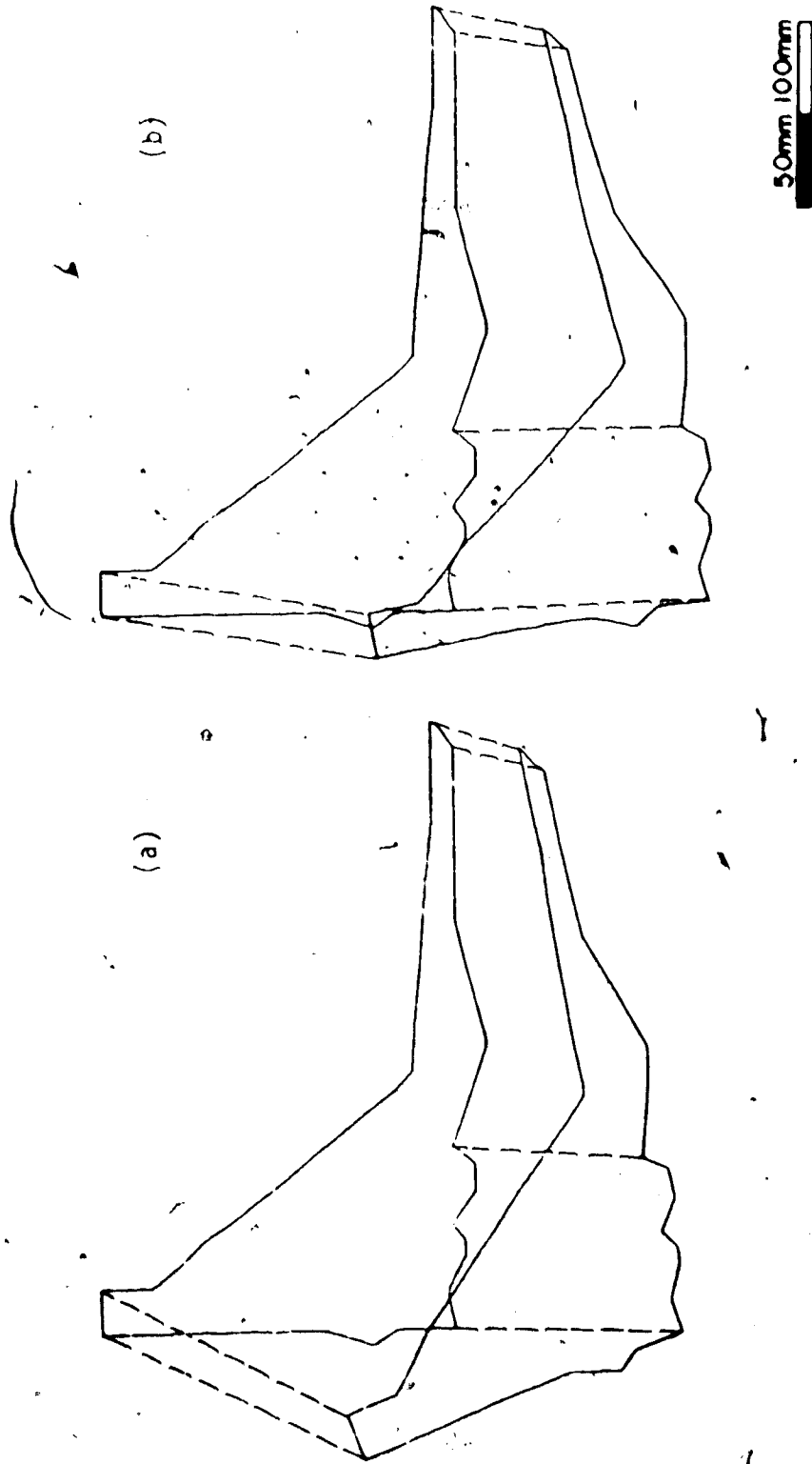

FIG. 3.5.9 DISPLACEMENTS OF THE DAM ASSUMING NO CRACK INTO THE FOUNDATION ROCK
(a) FOR LOW RESERVOIR LEVEL, EL. 443.5 m. (b) FOR HIGH RESERVOIR LEVEL,
EL. 506 m.

TABLE 3.5.3

SUMMARY OF FINAL RESULTS

Depth of Cracking % H	Predicted Displacement mm.	Measured Displacement mm.	Natural State		Grouped State			
			Ratio	E_{overall} Kg/cm ²	Ratio	E_{measured} Kg/cm ²	Ratio	E_{measured} Kg/cm ²
0.15	5	4	1.25	125,000	2.87	43,570	267,745	0.47
0.0	14	4	3.5	350,000	8.0	43,570	267,745	1.30

3.5.4 Comparison of Actual Behaviour with the Predicted

As we have underlined in Section 3.5.2 extensive consolidation grouting was done in the foundation of Bhakra dam. Measurements of uplift pressure on October 3, 1964 showed that no uplift had been recorded in the foundation rock, downstream of the heel. It is believed that the quality on the consolidation blanket was high enough to prevent cracking and subsequent propagation of uplift pressure in the rock.

Based on these facts, it is suggested that the conditions represented by the final analysis, in which the presence of a crack was ignored, are more likely to represent the actual behaviour of Bhakra dam. The $E_{\text{overall}}/E_{\text{measured}}$ ratio, based on an average E after grouting, therefore gives us a value of 1.30.

It is of interest to discuss the value of E_{grouted} which is used here for comparison purposes. Grouting was carried down 15.2 meters into the foundation rock. The change in stress caused by the dam itself and the water loading is responsible for the deformation of the rock. This change in stress does not affect only a layer of 15 meters but is felt down to great depths. The modulus of deformation of the rock immediately below the consolidation blanket is likely to be smaller than E_{grouted} . That is to say, that the in situ E we compare our overall modulus obtained by the numerical analysis to should include the composite effect of a stiff layer and of a region of expected lower modulus. This composite E would be smaller than E_{grouted} but higher than $E_{\text{ungrouted}}$. Therefore, it would be legitimate to expect an $E_{\text{overall}}/E_{\text{in situ}}$ ratio higher than 1.30.

For the Bhakra project a modulus of deformation of 175,685 Kg/cm^2 was used for design. We then see that the decision of the designers brought a factor of safety of 2.0 on the deformability of the rock mass at Bhakra dam site.

3.5.5 Influence of Poisson's Ratio on the Final Result

In the available data on Bhakra dam, values of Poisson's ratio for the different materials encountered in the foundation had been measured. The results of those measurements are shown in Table 3.5.4. In the petrographic classification within the table, calcareous subgreywacke corresponds to what was called sandstone in the field. Since this material was, as mentioned before, the main material under the dam, it is the one we will refer to in the following.

As we can see in Table 3.5.4, Poisson's ratio was measured for air dry and moist conditions, for different stress ranges going from 0 to 200 psi (0 - 14 Kg/cm^2) to 0 to 1000 psi (0 - 70 Kg/cm^2) for the air dry conditions and from 0 to 500 psi (0 - 35 Kg/cm^2) to 0 to 4000 psi (0 - 280 Kg/cm^2) for the moist conditions. For the tests performed under air dry conditions, Poisson's ratio takes a minimum and a maximum value of 0.0 and 0.17 respectively. Under moist conditions the minimum Poisson's ratio found was 0.003 and the maximum, 0.13.

Obviously, rock under a dam will have a water content greater than zero. The values given for a 75% moisture condition are therefore more realistic with respect to the field conditions.

In the finite element analysis, the effect of varying Poisson's ratio, on the final result of the previous section, was

TABLE 3.5.4

VALUES OF POISSON'S RATIO MEASURED IN THE FIELD

Ser. no.	Petrographic classification.	Moisture condition.	Static Poisson's Ratio for stress ranges, psi.				
			0-200	0-400	0-600	0-800	0-1000
1.	Calcareous subgrey wacke.....	Air dry	0 to 0.11	0 to 0.14	0 to 0.17	0.03 to 0.17	0.03 to 0.17
2.	Slightly calcareous subgrey wacke.....	Air dry	0.02	0.04	0.04	0.04	0.05
3.	Conglomerate.....	Air dry	0.10 to 0.11	0.14	0.16 to 0.17	0.17	0.17
4.	Calcareous siltstone.....	Air dry	0.15 to 0.35	0.18 to 0.27	0.24 to 0.27	0.26 to 0.28	0.23 to 0.30

Ser. no.	Petrographic classification.	Moisture condition.	Static Poisson's Ratio for stress ranges, psi.							
			0-500	0-1000	0-1500	0-2000	0-2500	0-3000	0-3500	0-4000
1.	Calcareous subgrey wacke	75 %	0.008 to 0.03	0.006 to 0.04	0.003	0.004 to 0.06	0.08	0.02 to 0.10	0.12	0.04 to 0.13
2.	Calcareous siltstone.....	75 %	0.03 to 0.11	0.04 to 0.12	0.04 to 0.13	0.05 to 0.16	0.06 to 0.16	0.07 to 0.16	0.08 to 0.15	0.09 to 0.18
3.	Conglomerate.....	75 %	0.05 to 0.16	0.08 to 0.15	0.09 to 0.16	0.10 to 0.17	0.11 to 0.18	0.11 to 0.19	0.13 to 0.19	0.13 to 0.20

(FROM BHATNAGAR AND SHAH, 1964)

studied. A Poisson's ratio of 0.1 and 0.4 were input to the analysis. Table 3.5.5 summarizes the results obtained. Figure 3.5.10(a) shows the variation of the overall modulus of deformation needed to account for the measured displacements as a function of Poisson's ratio. Fig. 3.5.10(b) shows the influence of Poisson's ratio on the $E_{\text{overall}}/E_{\text{measured}}$ ratio.

For the range of values measured on samples taken from the field, we see that there is no appreciable difference in the overall modulus and consequently in the $E_{\text{overall}}/E_{\text{measured}}$ ratio. In fact, with the assumption of a Poisson's ratio equal to 0.2 in our analyses, we are on the conservative side.

TABLE 3.5.5

SUMMARY OF THE INFLUENCE OF POISSON'S RATIO ON THE FINAL RESULT

Poisson's Ratio	Predicted Displacement (mm.)	Measured Displacement (mm.)	Ratio	E _{overall} (Kg/cm ²)	E _{measured} (Kg/cm ²)	Ratio
0.1	15	4	3.75	375,000	267,745	1.4
0.2	14	4	3.5	350,000	267,745	1.3
0.4	4	4	1.0	100,000	267,745	0.37

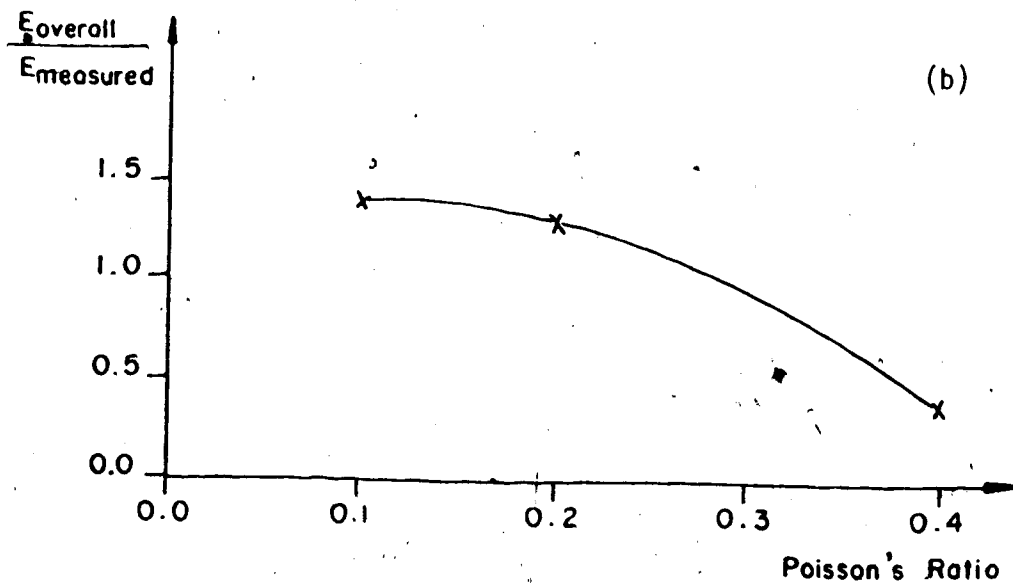
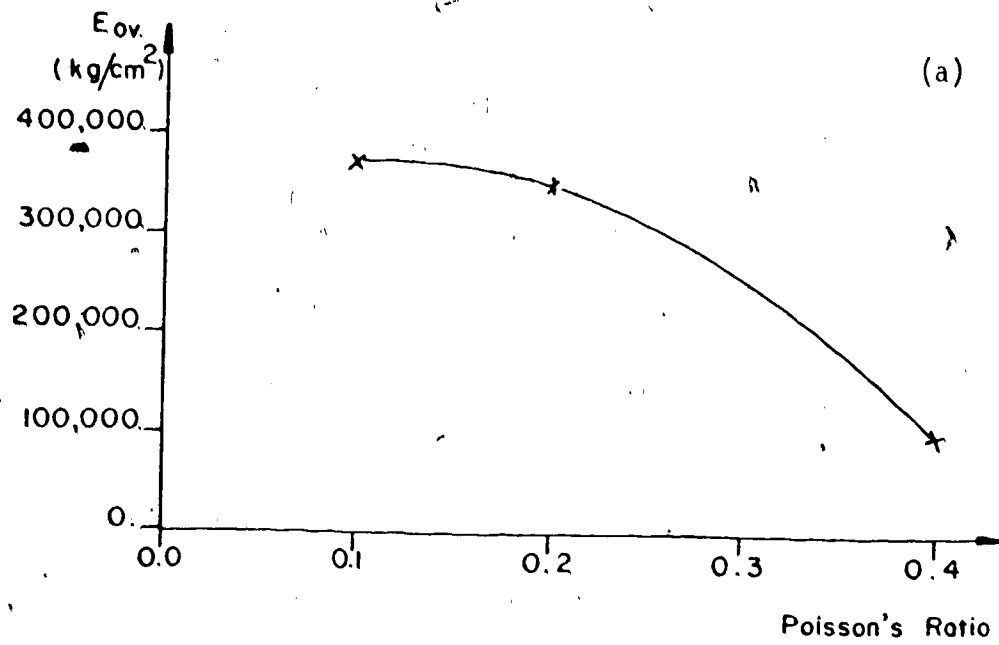

FIG. 3.5.10 INFLUENCE OF POISSON'S RATIO (a) ON THE OVERALL MODULUS OF DEFORMATION (b) ON THE $\frac{E_{overall}}{E_{measured}}$ RATIO

3.6 Analysis of Underground Powerhouses

The only powerhouse that will be analysed is the one excavated at the Oroville dam site, in Northern California. This underground opening has already been studied by Professors J. M. Raphael and R. W. Clough at the University of California. Results of its behaviour have been presented by Kruse (1971). One reason for redoing the analysis of the Oroville powerplant is to see if the procedure which will be used here will reproduce the results already obtained.

3.6.1 Boundary Conditions

The boundary conditions used in the analysis of Oroville powerplant are as shown on Fig. 3.6.1(a) and (b). Further explanation of those boundary conditions are given in a subsequent section.

The top of the mesh was sloping, modeling the flank of a mountain. Its average height and width were about ten times the width of the underground opening.

On the vertical sides of the mesh movements were allowed in any direction. The bottom boundary of the mesh was completely fixed.

Simulation of the excavation, which constitutes the loading of the finite element mesh, will be described in the following section.

3.6.2 Procedure Used in an Analysis

In the analysis of an underground opening, knowledge of the initial state of stress in the rock mass is of primary importance. If from its determination it is found that the horizontal stress is related to the vertical by Poisson's ratio, a gravity analysis, in which the horizontal displacements of the side boundaries are fixed, will give the measured state of stress. On the other hand,

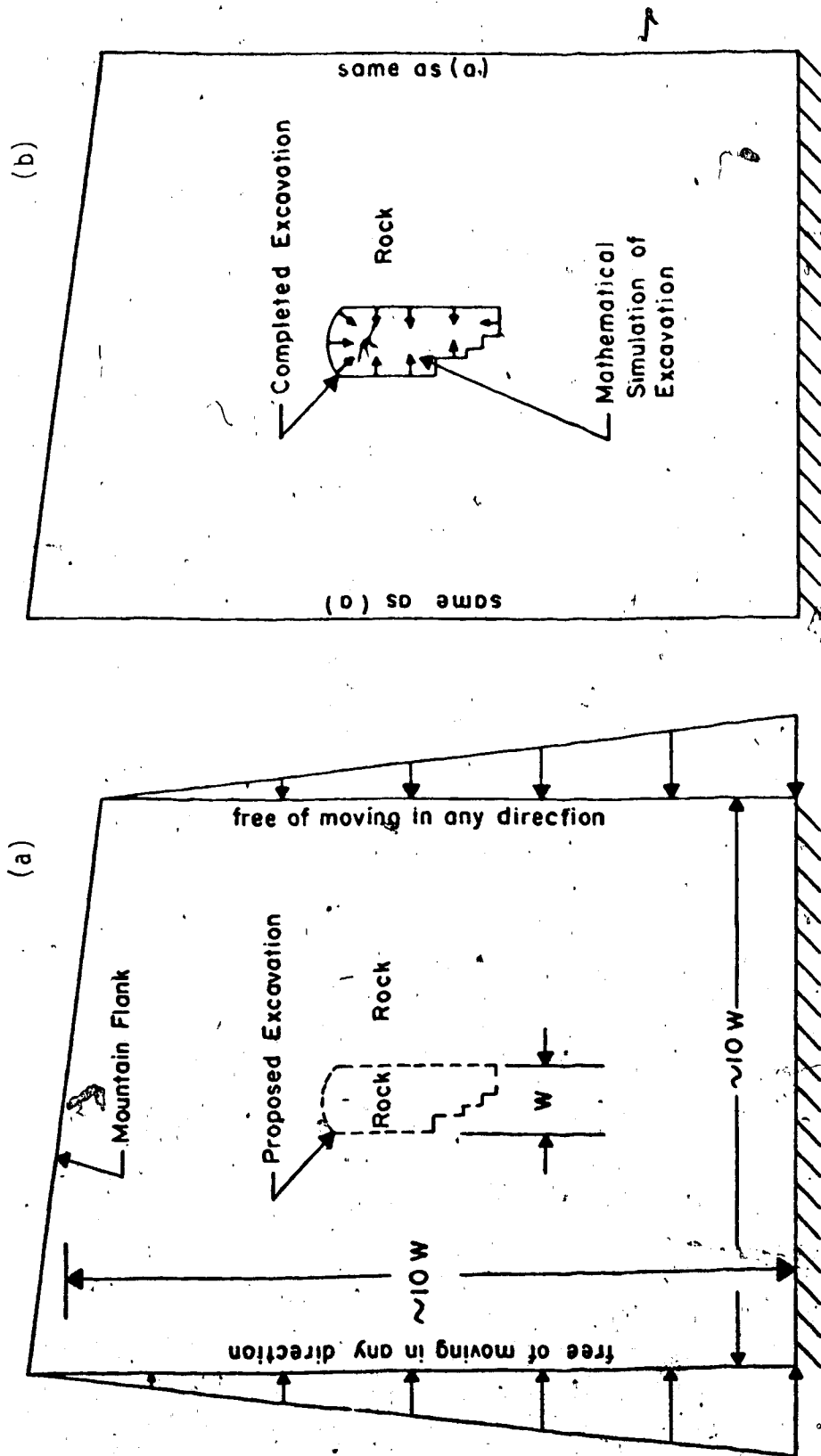

FIG. 3.6.1 BOUNDARY CONDITIONS USED IN THE ANALYSIS OF AN UNDERGROUND OPENING.
 (a) FIRST ANALYSIS (b) SECOND ANALYSIS

if the above relation does not exist, it is probably due to local heterogeneities in the rock mass or to the tectonic forces which depend on the earth's crust activity.

Therefore, knowledge of the initial state of stress allows us to load the lateral vertical sides of the mesh in order to generate the stresses in the finite element model. Naturally, if this is done, movements of the lateral boundaries must be allowed in any direction.

In the study of the Oroville powerplant two analyses will be performed. As explained above, the first one consists of inducing the initial state of stress in the model. In the same analysis, the forces which will simulate the excavation of the rock mass can be calculated by applying the following finite element equation, (Zienkiewicz, 1971):

$$\{F\}^e = \int_V [B]^T \{\sigma_0\} dv \quad (1)$$

Where:

$\{F\}^e$ = is the matrix corresponding to the nodal forces for one element,

$[B]^T$ = is the matrix representing the geometry of an element,

$\{\sigma_0\}$ = is the matrix corresponding to the initial stresses in one element,

V = is the volume of one element

If the calculation involved in this equation is done for all the elements inside the outline of the opening and having a side in common with this outline, nodal forces will be calculated all around the opening.

It is important to note that the state of deformation the finite element model is in, at the end of this analysis, is assumed to represent the state of equilibrium in the rock mass, before starting the excavation.

In the second analysis the following items are applied:

i) the same boundary conditions all-around the mesh are kept but no side forces are applied,

ii) for all the elements included inside the outline of the opening, properties of air (E_{air}) are given,

iii) the weight of the material surrounding the opening is set equal to zero,

iv) the forces found in the first analysis are applied to their respective nodes, around the outline of the opening.

Performance of this second analysis will give the displacements caused by the excavation itself. The analysis being a linear elastic one, the final state of stress around the opening is obtained by adding the states of stress of the two analyses.

3.7 Analysis of Oroville Underground Powerhouse

3.7.1 Introduction

Oroville underground powerplant is situated in the state of California, in U. S. A., about 85 miles north of the City of Sacramento. Oroville dam and powerplant are part of the State Water Project in California, which has the objective of distributing water from northern regions to the southern regions.

The powerplant itself contains six generating units. Its length is approximately 170 m. (550 feet). Its maximum width and height are 21 meters (70 feet) and 42 meters (140 feet) respectively.

The underground chamber has been excavated in metamorphic rock high in amphibole minerals. The rock was called amphibolite. At the excavation site three joint sets characterize the rock mass. Shears and schistose zones are also present. A more detailed description of the site geology is given in Kruse (1971).

Excavation of the opening started in March 1964 and was 90% completed by May 1965.

3.7.2 Methods of Investigation Used and Values Assumed for the Study

i) Deformability Characteristics

A publication by Kruse (1969) discusses the different methods used in the determination of the modulus of deformation of the rock at Oroville dam site. Table 3.7.1 summarizes those results. As can be seen a very extensive testing program was undertaken. The results we are concerned with here are those of the flatjack tests, the plate bearing tests (or plate jacking tests) and the tunnel relaxation method.

TABLE 3.7.1

SUMMARY OF ROCK MODULI MEASURED AT OROVILLE DAMSITE

Type of Test	Number of Measurements	Range	Rock Modulus psi (Kg/Cm ²)	Average
Static tests on Cores	21	10.8-15.2x10 ⁶ (7.6-10.6x10 ⁵)		12.9 x 10 ⁶ (9.x10 ⁵)
Sonic tests on Cores	3	14.8-17x10 ⁶ (10.4-11.9x10 ⁵)		16 x 10 ⁶ (11.2x10 ⁵)
Geophysical - seismic velocity	19	4.9-15.5x10 ⁶ (3.4-10.9x10 ⁵)		10.2 x 10 ⁶ (7.1x10 ⁵)
Flatjack	10	1.4-16.4x10 ⁶ (1.0-11.5x10 ⁵)		7.5 x 10 ⁶ (5.2x10 ⁵)
Tunnel Relaxation	22	0.6-7.5x10 ⁶ (0.4-5.3x10 ⁵)		2.6 x 10 ⁶ (1.8x10 ⁵)
Plate Bearing	5	1.2-1.8x10 ⁶ (0.8-1.2x10 ⁵)		1.5 x 10 ⁶ (1.05x10 ⁵)

(FROM KRUSE, 1969)

The primary objective of the flatjack tests performed was the determination of the initial state of stress in the rock mass. However, the flatjack test can also give an estimate of the modulus of deformation knowing the stress transmitted and the displacement undergone by the grouted pins. Thirty measurements with the flatjack test gave moduli ranging from $100,000 \text{ Kg/cm}^2$ ($1.4 \times 10^6 \text{ psi}$) to $1,150,000 \text{ Kg/cm}^2$ ($16.4 \times 10^6 \text{ psi}$) and averaging at $530,000 \text{ Kg/cm}^2$ ($7.5 \times 10^6 \text{ psi}$).

Five plate jacking tests were done. Their orientation being mainly perpendicular to the surface of the rock in a gallery, they are likely to be more influenced by the distressed zone around the opening. Low values of the modulus of deformation would then be expected. Table 3.7.1 gives values ranging from $85,000 \text{ Kg/cm}^2$ ($1.2 \times 10^6 \text{ psi}$) to $125,000 \text{ Kg/cm}^2$ ($1.8 \times 10^6 \text{ psi}$) and averaging at $105,000 \text{ Kg/cm}^2$ ($1.5 \times 10^6 \text{ psi}$).

The tunnel relaxation method consists of computing analytically the displacements around an opening and to compare these displacements to the actual measured ones. The position of the measuring device being known, with respect to the opening, displacements can be calculated and plotted for a range of values of the modulus of deformation. Upon excavating, the measured displacements are also plotted on the same graph and a best-fit line can give the modulus of deformation based on the measured displacements. This method has the advantage of considering a very large volume of rock in the comparison. However, it is limited with respect to the shape of opening that it has been derived for. More details are given in Kruse (1969).

Twenty-two tunnel relaxation comparisons were made and gave

modulus ranging from 42,000 Kq/cm² (0.6×10^6 psi) to 530,000 Kq/cm² (7.5×10^6 psi). The average modulus of deformation was 180,000 Kq/cm² (2.5×10^6 psi).

From the above data, it is seen that a considerable scatter exists in the modulus value. However, since the tunnel relaxation method and the plate jacking test load large masses of rock, their results were thought to be more representative. For the Oroville underground chamber, a design modulus of 105,000 Kq/cm² (1.5×10^6 psi) had been used in the previous analyses. The same value was used in our analysis.

No data was available for the value of Poisson's ratio of the rock at the Oroville site. It was assumed equal to 0.25.

The weight of the material was taken equal to 2.9 Tm/m^3 .

ii) In Situ Initial Stresses

The determination of in situ initial stresses at the site of the powerhouse was done by two methods (Merril et al., 1964): the flatjack and borehole deformation methods.

The flatjack method performed at the Oroville site was similar to the one already described. The reference for displacement measurements was an assembly of eight pins, four grouted on each side of the flatjack.

The borehole deformation test used an overcoring technique. Measurement of deformations upon overcoring was made by a gage inserted in a drilled hole. The deformation consisted of a change in diameter at a specific orientation. Therefore consecutive measurements at three different depths from the rock surface needed to be done in order to obtain a complete state of stress.

In spite of the disadvantages of each method, their agreement was relatively good. From the measurements it was concluded that the stress field was essentially hydrostatic and equal to 35 Kq/cm^2 (500 psi). This stress corresponded quite well with the weight of the overburden. In our analysis the horizontal stress was then made equal to the vertical stress determined from the weight of the overburden.

3.7.3 Results of Predicted and Measured Displacements

In the analyses performed on the Oroville powerplant, only the rock overlying the opening has been considered. The powerplant was built under the upstream shoulder of the dam. As was mentioned earlier, the excavation was almost completed in May 1965. At that time there was not a considerable thickness of material directly on top of the chamber. The finite element mesh used in the study of Oroville powerplant is depicted in Fig. 3.7.1.

Complete results of the deformations measured around the chamber are given by Kruse (1969) and Kruse (1971). Extensometers had been installed in the arch and the walls of the opening. They were approximately 6m (20 feet) long in the arch and 12m. (40 feet) long in the walls. Figure 3.7.2 shows their relative position.

In the arch of the opening, thirty-nine deformation measurements were made ranging from .05 mm. (.002 inches) to 1.5 mm. (.059 inches) and averaging at 0.30 mm. (.012 inches). For a depth of six meters from the rock surface our analysis gives a relative displacement of 1.33 mm. (0.52 inches). Therefore to account for the measured displacement of the arch the modulus used should be multiplied by a factor of 4.45. This would result in a modulus of deformation equal

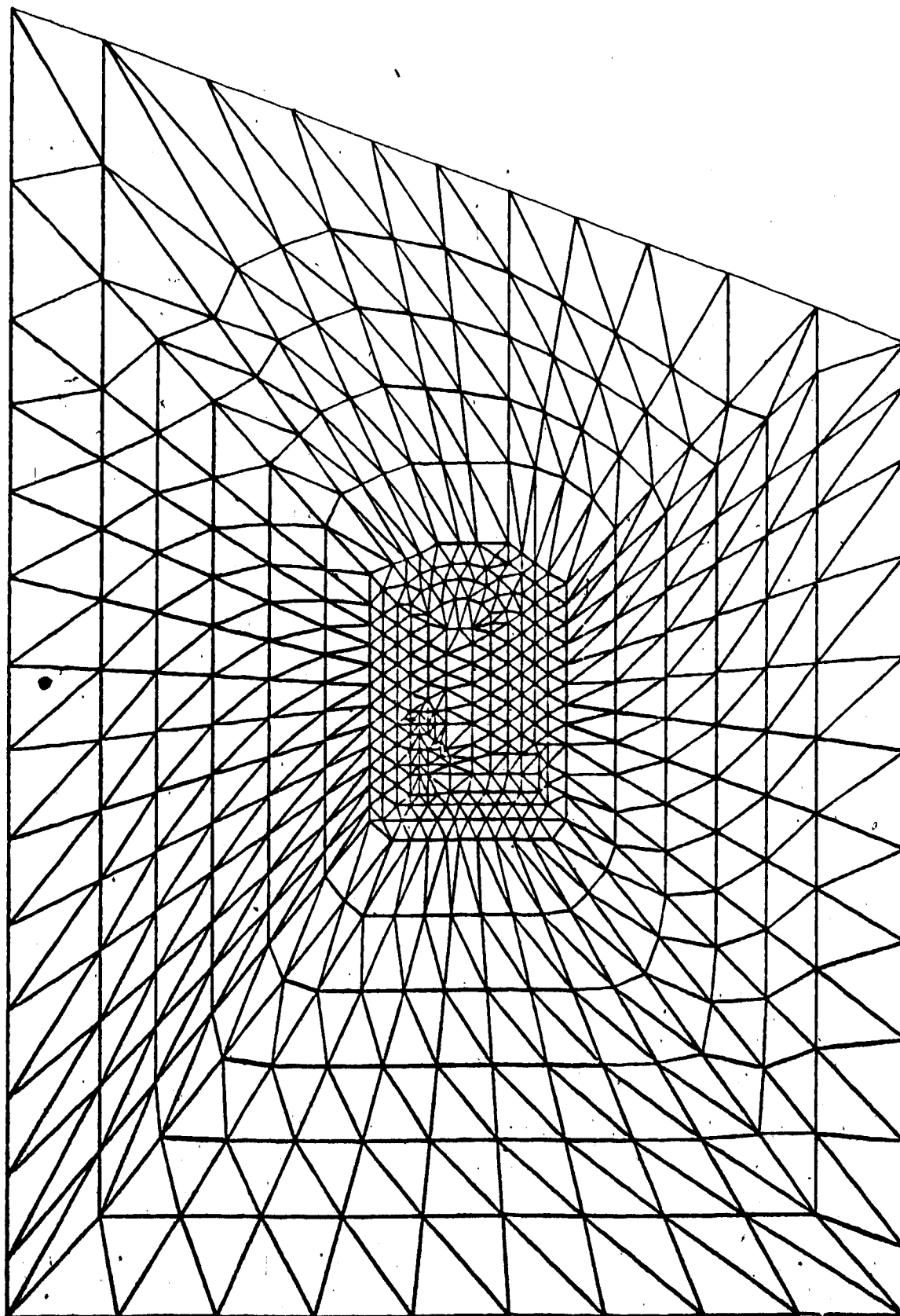

FIG. 3.7.1 FINITE ELEMENT MESH USED IN THE STUDY OF OROVILLE UNDERGROUND POWERPLANT.

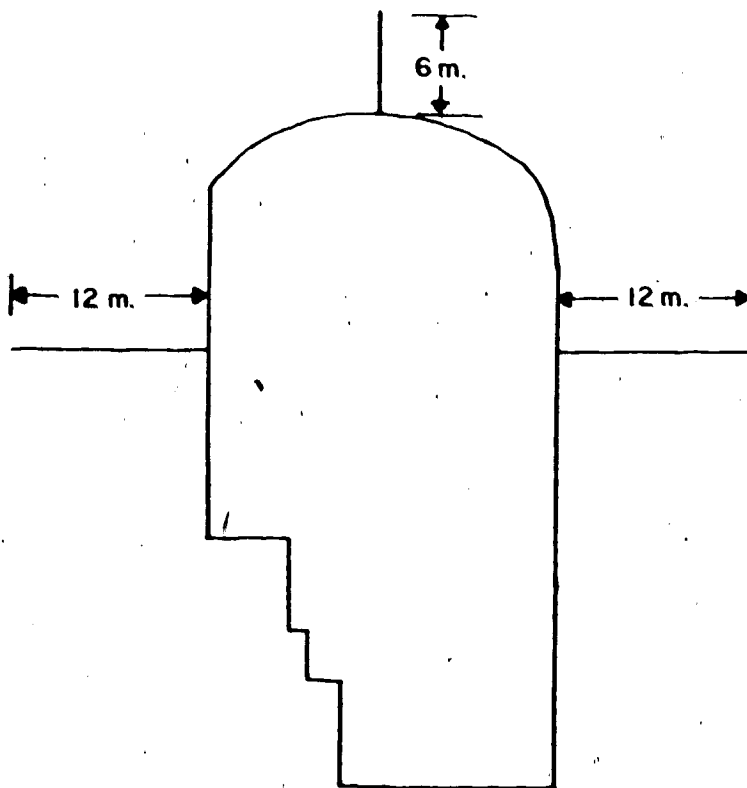

FIG. 3.7.2 RELATIVE POSITION OF EXTENSOMETERS FOR WHICH DISPLACEMENTS ARE QUOTED.

to 470,000 Kg/cm² (6.5×10^6 psi) for the arch portion. The finite element analysis performed at the University of California gave a relative displacement of 1.65 mm. for the arch of the opening. This last displacement would result in a modulus equal to 580,000 Kg/cm² (8.2×10^6 psi) for the arch portion.

At the end of the excavation the displacements measured by the horizontal extensometers ranged from 1.38 mm. (0.054 inches) to 6.3 mm. (0.247 inches). The average was 2.9 mm. (0.114 inches.). The relative displacement for a distance of 12 meters and calculated by the numerical analysis was the same for the right and left wall. It was equal to 2.7 mm. Almost no difference exists between the calculated and measured displacement. For all practical purposes it can be said that a modulus of 105,000 Kg/cm² (1.5×10^6 psi) correctly represents the walls' deformation behaviour. The relative displacement calculated at the University of California was equal to 3.55 mm. (0.140 inches). Although resulting in a higher modulus than the one we have calculated, this relative displacement is further from the actual measured one. All of the above results are summarized in Table 3.7.2. The absolute deformation of the rock surface, calculated in our analysis, is also given in Fig. 3.7.3

The fact that such a big difference exists between the moduli of deformation needed to account for the measured arch and wall movements is of particular importance. Some possible reasons were suggested in Kruse (1971). The one which was considered as the most plausible was the following: "The difference in bolt spacing and installation specification may account for the apparent difference in crown modulus and wall modulus."

TABLE 3.7.2
SUMMARY OF RELATIVE DEFORMATIONS FOR
OROVILLE POWER PLANT

Analysts	Crown		Walls	
	Finite Element (mm)	Measured (mm)	Finite Element (mm)	Measured (mm)
University of California	1.65		3.55	
		0.3		2.9
Bourbonnais Morgenstern	1.33		2.7	

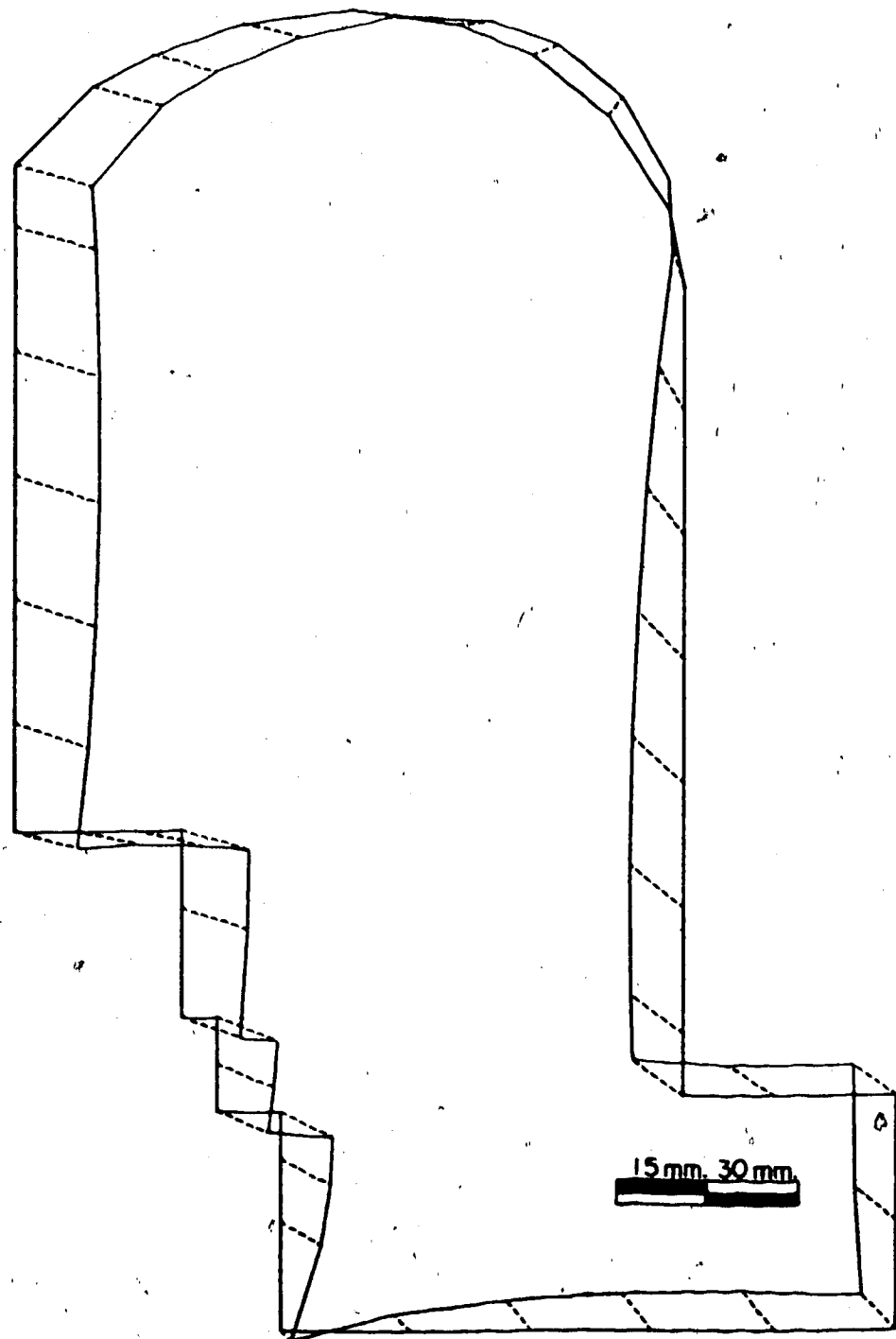

FIG. 3.7.3 ABSOLUTE DISPLACEMENTS OF THE OPENING.

Indeed the rock bolts of the arch were installed in a four feet center to center pattern whereas the bolts of the walls were six feet away from each other.

To summarize, our analysis of Oroville powerplant grossly agrees with the one performed at the University of California. However, our results show a closer agreement to the actual behaviour.

CHAPTER IV
CONCLUDING REMARKS

4.1 The Deformability of Rock Masses

In this study we have tried to prove that the overall stiffness of a rock mass subjected to the loading of a dam and adjacent reservoir, for example, is higher than the stiffness arrived at by an in situ static test. It is important to note that for the three cases analysed, different moduli (modulus of deformation or modulus of elasticity) have been used to obtain the final ratios. In the case of Krasnoyarsk dam the in situ modulus was found by subjecting a plate to vertical loading. The modulus obtained from such an in situ test could be regarded as a deformation modulus. In the analysis of Krasnoyarsk dam the measured displacements used for comparison purposes were given with respect to the beginning of the construction of the dam. Therefore these displacements included the effect of gravity, water loading, creep of the rock mass etc. The analytical overall modulus obtained after comparison is therefore an overall modulus of deformation. Care has to be taken so that the overall analytical modulus obtained and the one determined from the in situ test are of the same type. For Krasnoyarsk dam an overall modulus of deformation was then compared to an in situ modulus of deformation.

The study of Krasnoyarsk dam led us to the conclusion that an overall modulus of deformation of $210,000 \text{ Kg/cm}^2$ is representative

of the measured structure behaviour. The average in situ modulus of deformation was equal to $100,000 \text{ Kg/cm}^2$.

The case of Alpe Gera dam was different than Krasnoyarsk dam. Here, the displacements used for the comparison had been measured long after the first impounding of the reservoir. The structure had been subjected to cyclic loading. Therefore the analytical overall modulus obtained was an overall modulus of elasticity. Consequently this modulus has been compared to an in situ modulus of elasticity.

In the analysis of Alpe Gera dam, we found that the overall moduli of elasticity of $492,000 \text{ Kg/cm}^2$ and $244,000 \text{ Kg/cm}^2$ would account for the measured horizontal and vertical displacements respectively. These moduli average at $368,000 \text{ Kg/cm}^2$. The hydraulic chamber test performed at the dam site gave an in situ modulus of $69,000 \text{ Kg/cm}^2$. The plate jacking test taken to a stress level of 100 Kg/cm^2 averaged at $175,000 \text{ Kg/cm}^2$.

Finally, the case of Bhakra dam is similar to Alpe Gera dam in the sense that the structure has been subjected to many cycles of impounding. The analytical overall modulus, with respect to our terminology would then be an overall modulus of elasticity. In the section on Bhakra dam the moduli determined by the static tests were called moduli of deformation. The overall modulus of elasticity, obtained from the analysis, was compared to a modulus measured after grouting had been performed. The very high values obtained after grouting suggest that the modulus of elasticity of a test would be very close, if not equal, to the quoted modulus of deformation.

In the study of Bhakra dam an overall modulus of elasticity of $350,000 \text{ Kg/cm}^2$ was found to account for the measured displacements.

The average of the in situ tests moduli, measured after grouting, was $267,745 \text{ Kg/cm}^2$.

In this work only one underground opening was analysed. The study of Oroville underground powerhouse revealed that moduli of $470,000 \text{ Kg/cm}^2$ and $105,000 \text{ Kg/cm}^2$ were necessary to account for displacements of the arch and walls respectively. The average of the moduli determined by the plate jacking test is $105,000 \text{ Kg/cm}^2$:

Figure 4.1.1 summarizes the results obtained all through this study. The data of Fig. 2.3.2 is also included.

From Fig. 4.1.1 it can be concluded that large in situ static tests will underestimate the value of the modulus of deformation or elasticity of rock masses. This can readily be understood:

If we refer firstly to the case of a dam, we find that large in situ static tests are usually performed at shallow depths from the surface. At that depth weathering has a more marked influence on the rock; very often surface excavation of rock is undertaken which results in a stress release and subsequent opening or widening of joints; in areas of severe climatic conditions, freezing of water in the winter plays a role in increasing the deformability of the upper strata; in situ static tests being usually performed in galleries, the surrounding distressed zone will affect considerably the value of the modulus obtained from the test. On the other hand, a structure like a dam will carry its load down to great depths in the rock mass, where the rock is usually sounder.

In the case of an underground opening all of the above factors might affect the value of the modulus determined from a test. But, since underground openings are often excavated deep within the rock

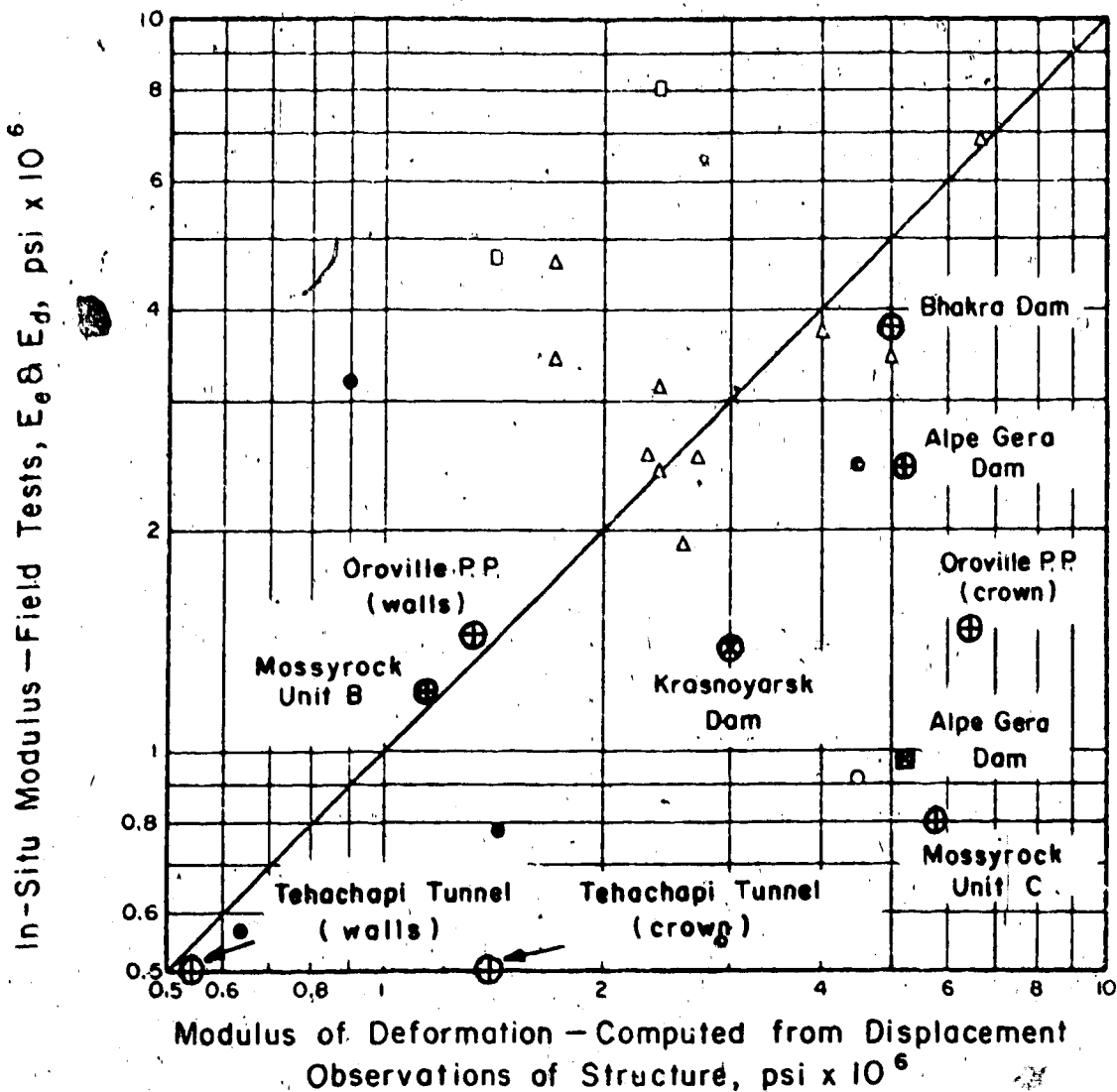

PLATE JACKING TEST	●	PLATE JACKING TEST	○
PRESSURE CHAMBER TEST	○	PRESSURE CHAMBER TEST	⊠
BOREHOLE DEFORMATION TEST	△	VERTICAL PLATE LOADING TEST	⊗
SEISMIC TEST	□		
(Up to 1969)		(1969 to 1973)	

FIG. 4.1.1 COMPARISON OF IN SITU TEST MODULUS AND MODULUS COMPUTED FROM DISPLACEMENT OBSERVATION OF STRUCTURES

body, the last factor mentioned above is the one that plays the dominant role. Therefore, if provision is made for long buried gages, to go beyond the zone of disturbance in a test adit, it is likely that the modulus obtained from a static test will be more representative of the rock mass.

From the studies of many dam sites Snow (1968) has evaluated, from permeability measurements in drill holes, the fracture spacing, the size of fracture opening and fracture porosity of rock masses. His conclusions are:

- i) the fracture porosity decreases logarithmically with depth,
- ii) fracture spacing increase with depth,
- iii) fracture openings decrease with depth,
- iv) neither spacings nor openings are notably different from one rock type to another, nor are porosities or permeabilities which depend on the first two.

All of these items are consistent with an increase of rigidity of the rock with depth.

Rocha (1969) has measured with the LNEC dilatometer an increase of modulus with depth. His results are shown in Table 4.1.1.

Burland and Lord (1969) have measured, under ideal conditions, an increase of the modulus of elasticity with depth. Their results are shown in Fig. 4.1.2.

Many other investigators (Hast, 1967; Voight, 1969; Li, 1970) have measured an increase in the horizontal stress with depth. Figure 4.1.3 shows some results gathered by Voight (1969). This increase in horizontal confinement with depth would also result in an increase of

TABLE 4.1.1
VARIATION OF THE MODULUS OF DEFORMATION
WITH DEPTH

Depth (m)	Modulus of Deformability (kg/cm ²)
7.75	176,500
14.10	155,550
15.50	181,250
28.0	201,500
29.00	232,750
30.6	258,250

(FROM ROCHA, 1969)

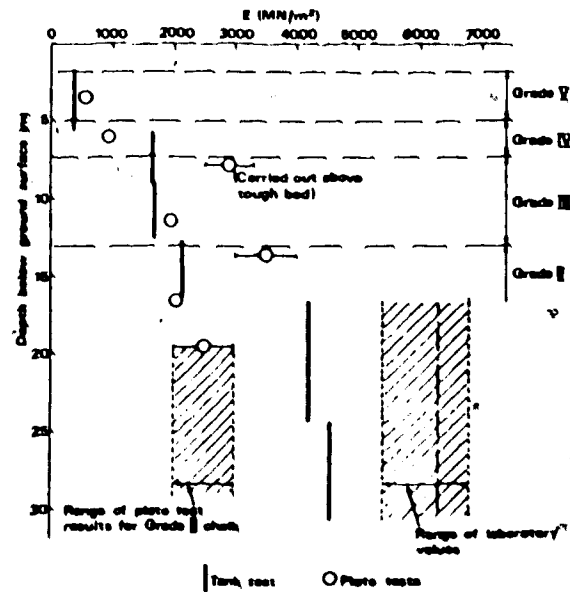

FIG. 4.1.2 COMPARISON OF YOUNG'S MODULUS E , DERIVED FROM THE PLATE TESTS AND LABORATORY TESTS WITH VALUES DERIVED FROM FULL-SCALE TANK TEST

(FROM BURLAND AND LORD, 1969)

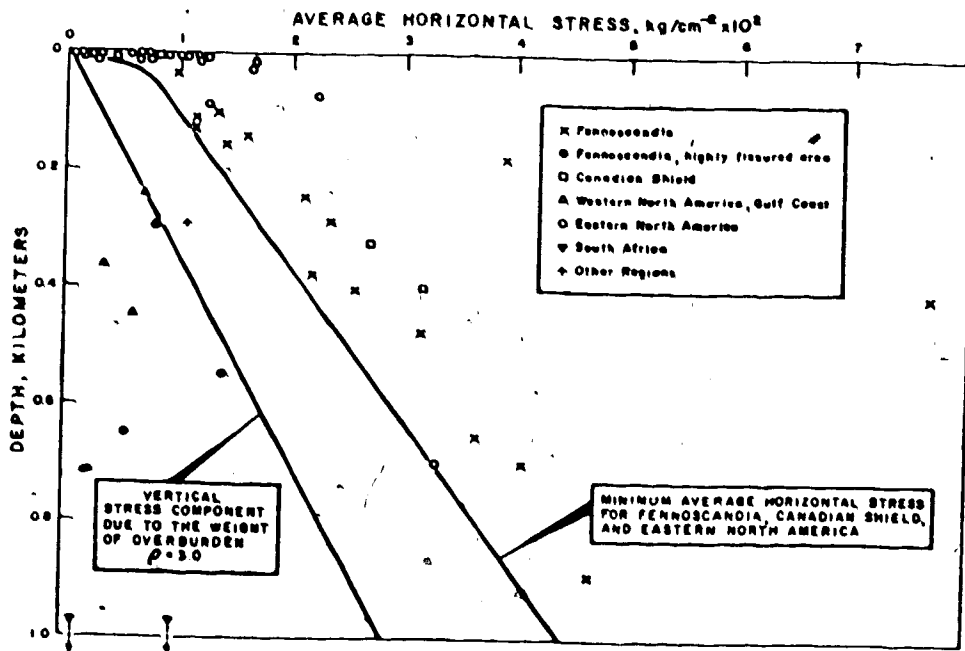

FIG. 4.1.3 AVERAGE HORIZONTAL STRESS AS A FUNCTION OF DEPTH

DATA FROM SEVERAL SOURCES (CF., HAST, 1967; VOIGHT, 1967, 1969). VALIDITY OF SOME POINTS MAY BE QUESTIONED (E.G. JAEGER, AND COOK, 1969 FIG. 14.3)

(FROM VOIGHT, 1969)

modulus.

All of the above mentioned references clarify the fact that a higher modulus than the one measured by an in situ static test is needed to account for the measured deformations of a structure.

It will certainly take many more analyses like the ones which have been performed here, to be able to set a criteria regarding the overall deformability of rock masses. But, at this stage, more confidence may exist in the mind of the designers of large structures knowing that the overall stiffness is likely to be better than that based upon common in situ tests.

4.2 The Behaviour of Structures

Since this work has dealt mostly with concrete dams, the following observations are of interest.

It has been recognised by many (Zienkiewicz, 1963; Weyerman, 1966; Serafim et al., 1967; Sabarly, 1968; Tizdel, 1970) that the state of stress induced in rock foundations upon impounding is of primary importance in the evaluation of the subsequent deformation behaviour of the structure. As is mentioned in the references above, a tensile state of stress will exist at the heel of the dam when its reservoir is filled. This tensile state of stress will make the natural fractures of the rock open and let full hydrostatic pressure enter the foundation. Depending mostly on the pre-existing stresses in the rock mass, a crack will propagate until these initial stresses counteract the effect of the water pressure.

Very recently the barrage of Malpasset in France has failed. In a report presented by the Commission charged to study the catastrophe (1966), it was concluded that tensile failure of the rock upstream of

the dam and subsequent propagation of full hydrostatic pressure in the rock mass were responsible for the initiation of the failure of the dam.

Although of extreme importance, with respect to the behaviour of a structure, seepage forces and full hydrostatic pressure in a crack at the heel of a dam have been rarely considered in its design. Rocha (1970) has analysed the effect of seepage pressure in the foundation rock below a concrete dam. He has used the finite element method and has also done model studies. His results show that water pressure applied on the grout curtain of a dam has a significant effect on the stresses and deformations of the structure.

Throughout this study, the concept of introducing full hydrostatic pressure down to a certain depth, at the heel of a dam, has been explored. For the three dams analysed, it has helped in understanding their behaviour.

At Malpasset the conditions led to a catastrophe. One of the recommendations of the Commission was to assure that propagation of full hydrostatic pressure at the heel of a dam would not take place. The Commission suggested that upstream grouting or, if necessary, prestressing of the rock would prevent undesirable effects.

The case of Bhakra dam, in this study, supports this view. Extensive grouting was performed in the foundation of Bhakra dam, upstream and downstream of the structure. No crack was consistent with the measured behaviour. However, in many cases the presence of a crack may be tolerable without special treatment.

REFERENCES

- Benson, R. P., et al., 1969. Modulus testing of rock at the Churchill Falls underground powerhouse, Labrador. Determination of the in situ modulus of deformation of rock, ASTM STP 477, p. 89-116.
- Benson, R. P., et al., 1970. In situ and induced stresses at the Churchill Falls underground powerhouse, Labrador. Second International Congress on Rock Mechanics, V.2, Theme 4, Paper 60.
- Bhatnagar, P. S., Shah, S. R., 1964. Experiments on Bhakra dam foundations. Eighth International Congress on Large Dams, Edimbourg, V. 1, Q. 28, R. 58, p. 1081-1108.
- Bhatnagar, P. S., et al., 1967. Structural behaviour of Bhakra dam. Ninth International Congress on Large Dams, Istamboul, V. 3, Q. 34, R. 15, p. 245-274.
- Bochkin, A. E., et al., 1971. The condition of the Krasnoyarsk dam during the initial years of operation. Hydrotechnical Construction, 1971, Part 1, p. 316-325.
- Burland, J. B., Lord, J. A., 1969. The load-deformation behaviour of Middle Chalk at Mundford, Norfolk: a comparison between full-scale performance and in situ and laboratory measurements. Conference on in situ Investigations in soils and rocks, British Geotechnical Society, p. 3-15.
- Casagrande, A., 1961. First Rankine Lecture: Control of seepage through foundations and abutments of dams. Geotechnique, V. 11, No. 3, p. 161-181.
- Clough, R. W. 1960. The finite element in plane stress analysis. Proc. of 2nd A.S.C.E. Conf. on electronic computation, Pittsburgh, Pa.
- Deere, D. U., and R. P. Miller, 1966. Classification and index properties for intact rock. AFWL-TR-65-116, AF Special Weapons Center, Kirtland AFB, New Mexico.
- Deere, D. U., et al., 1969. Engineering classification of in situ rock. AFWL-TR-67-144, Air Force Weapons Laboratory, Kirtland, New Mexico.
- Desai and Abel, 1972. Introduction to the finite element method, Van Nostrand Reinhold.

- ENEL, Direction des études et recherches, 1966. Deformabilité de la roche de fondation dans le cas de quelques barrages italiens. First International Congress on Rock Mechanics, V. 2, Theme 8, Paper 20, p. 603-615.
- Gentile, G., 1964. Study, preparation and placement of low cement concrete with special regard to its use in solid gravity dam. Eighth International Congress on Large Dams, Edimbourg, V. 3, Q. 30, R. 16, p. 259.
- Hast, N., 1967. The state of stress in the upper part of the earth's crust. Engineering Geology, V. 2, V. 5.
- Kleiner, D. E., Acker, R. C., 1971. Rock mechanics studies for Mossyrock arch dam. Journal of the Power Division, Proc. ASCE, V. 97, No. PO 1, p. 11-24.
- Kruse, G. H., 1969. Deformability of rock structures, California State Water Project. Determination of the in situ modulus of deformation of rock, ASTM STP 477, p. 58-88.
- Kruse, G. H., 1971. Powerplant chamber under Oroville dam. Symposium on Underground Rock Chambers, ASCE National Meeting on Water Resources Engineering.
- Kujundzic, B., 1955. Methode de determination experimentale du module d'elasticite des roches. Symposium sur l'observation des ouvrages, Rilem, V. 2, p. 268-297.
- Lauffer, H., Seeber, G., 1961. Design and control of linings of pressure tunnels and shafts, based on measurements of the deformability of the rock. Seventh International Congress on Large Dams, Rome, V. 2, Q. 25, R. 91, p. 679-709.
- Leeman, E. R., 1969. The CSIR "doorstopper" and triaxial rock stress measuring instruments. International Symposium on the Determination of Stresses in Rock Masses, Lisbon, Paper 28, p. 578-616.
- Li, B., 1970. Natural stress values obtained in different parts of the fennoscandian rock masses. Second International Congress on Rock Mechanics, V. 1, Theme 1, Paper 28.
- Malpasset: Le rapport de contre-expertise sur la rupture du barrage de Malpasset. Le Genie Civil, V. 143, No. 1, p. 14-20, No. 5, p. 99-108.
- Meigh, A. C., Greenland, S. W., 1965. In situ testing of soft rocks. Sixth International Conference on Soil Mechanics and Foundation Engineering, V. 1, p. 73-76.
- Merrill, R. H., et al., 1964. Stress Determinations by flatjack and borehole deformation methods. U. S. Bureau of Mines, Report of Investigations, 6400, 1964.

- Obert, L., 1966. Determination of stress in rock - A state-of-the-Art Report. ASTM STP 429.
- Rocha, M., 1955. Deformability of Foundation Rocks, Fifth International Congress on Large Dams, Paris, V. 3, Q. 18, R. 75, p. 531-559.
- Rocha, M., et al., 1966. Determination of the deformability of rock masses along boreholes. First International Congress on Rock Mechanics, V. 1, Theme 3, Paper 77, p. 697-704.
- Rocha, M., 1969. New techniques in deformability testing of in situ rock masses. Determination of the in situ modulus of deformation of rock, ASTM STP 477, p. 39-57.
- Rocha, M., et al., 1969. A new technique for applying the method of the flatjack in the determination of stresses inside rock masses. International Symposium on the Determination of Stresses in Rock Masses, Lisbon, Paper 19, p. 431-450.
- Rocha, M., Silverio, A., 1969. A new method for the complete determination of the state of stress in rock masses. International Symposium on the Determination of Stresses in Rock Masses, Lisbon, Paper 18, p. 405-430.
- Rocha, M., Da Silva, J. N., 1970. A new method for the determination of deformability in rock masses. Second International Congress on Rock Mechanics, V. 1, Theme 2, Paper 21.
- Rocha, M., et al., 1970. Influence on the behaviour of an arch dam of the hydrostatic pressure on the grout curtain and of the stresses in the ground upstream. Tenth International Congress on Large Dams, Montreal, V. 4, Q. 39, R. 29, p. 541-558.
- Sabarly, F., 1968. Les injections et les drainages de fondation de barrages en roches peu perméables, Geotechnique, V. 18, p. 229-249.
- Serafim, J. L., 1964. Etude des fondations rocheuses des barrages en beton. Annales de l'Institut Technique du Batiment et des Travaux Publics, No. 197, p. 472-490.
- Serafim, J. L., Guerreiro, M., 1966. In situ tests for the study of rock foundations of concrete dams. First International Congress on Rock Mechanics, V. 2, Theme 8, Paper 12, p. 549-556.
- Serafim, J. L., et al., 1967. Aspects of the percolation of water under concrete dams and the deformation of rock foundations. Ninth International Congress on Large Dams, Istanbul, V. 5, Communication 7, p. 381-406.

- Shannon and Wilson, Inc., 1964. Report on In Situ Rock Tests, Dworshak Dam Site, for U. S. Army Engineer District, Walla Walla, Corps. of Engineers, Seattle, Washington.
- Snow, D. T., 1968. Rock fracture spacings, openings, and porosities. J. of the Soil Mechanics and Foundations Division, Proc. ASCE, V. 94, No. SM 1, p. 73-91.
- Terracini, C., 1970. Behaviour of Alpe Gera gravity dam in its early operational stages. Comparison between the measurements in situ and the analytical and experimental results. Tenth International Congress on Large Dams, Montreal, V. 4, Q. 39, R. 7, p. 119-137.
- Tizdel, R. R., 1970. Deformation of Rock Foundations of High Dams after filling the reservoirs. Hydrotechnical Construction, June 1970, Part 1, p. 512-519.
- Van Heerden, W. L., 1968. Determination of the accuracy of "door-stopper" stress measurements in coal. Report to the South African Council of Scientific and Industrial Research, Meg 693.
- Voight, B., 1969. Prediction of "in situ" stress patterns in the earth's crust. International Symposium on the Determination of Stresses in Rock Masses, Lisbon, p. 111-131.
- Wallace, G. B., et al., 1969. In situ methods for determining deformation modulus used by the Bureau of Reclamation. Determination of the in situ modulus of Deformation of rock, ASTM STP 477, p. 3-26.
- Weyerman, W., 1966. Deformations des roches de fondation des barrages. First International Congress on Rock Mechanics, V. 2, Theme 8, Paper 13, p. 557-561.
- Zienkiewicz, O. C., 1963. Stress Analysis of hydraulic Structures including pore pressure effects. Water Power, V. 15, March 1963, p. 104-108.
- Zienkiewicz, O. C., 1971. The finite element method in engineering science. McGraw Hill.