

THE UNIVERSITY OF ALBERTA

DEVELOPMENT AND VALIDATION OF A TRAFFIC CIRCLE SIMULATOR

BY



JOHN KUFUOR-BOAKYE

A THESIS

SUBMITTED TO THE FACULTY OF GRADUATE STUDIES

AND RESEARCH IN PARTIAL FULFILMENT

OF THE REQUIREMENTS FOR THE

DEGREE OF MASTER OF SCIENCE

DEPARTMENT OF COMPUTING SCIENCE

EDMONTON, ALBERTA

FALL, 1973

ABSTRACT

This thesis presents the development and validation of a traffic circle simulator for use as a tool in the evaluation of traffic circle performance. The simulator was constructed as a general traffic flow model. Different traffic circle situations can be simulated by supplying the simulator with the descriptive geometrical characteristics of the circle in terms of circle configuration, and pertinent data including the total traffic volumes from the various approaches of the circle.

The model has the capacity for the dynamic analysis of traffic flow at a circle with up to 6 arteries, and up to 2 approach lanes, 2 exit lanes and 2 circle lanes. The model was implemented on an IBM 360/67 computer in FORTRAN IV.

The model was validated at the macroscopic level. Several different macroscopic comparisons were made between simulated phenomena and real data collected at various traffic circles in the City of Edmonton. The comparisons were found to be consistent and reasonable.

ACKNOWLEDGEMENTS

I wish to thank Dr. K. V. Leung, my supervisor for his advice. My thanks are also due to Dr. J. R. Sampson and Dr. J. Tartar who carefully read and criticized the thesis.

The help, encouragement and guidance offered by Mr. Dale Rhyason, P. Eng., of the City of Edmonton Engineering and Transportation Department throughout the preparation of this thesis is gratefully acknowledged. Other encouragement offered by friends, especially Mr. and Mrs. Kweku Edugyan is also appreciated.

Finally I wish to thank the Department of Computing Science for financial assistance throughout my graduate program.

TABLE OF CONTENTS

	Page
Chapter I: Introduction	1
1.1 General Introduction	1
1.2 Nature of the Problem	3
1.3 The Need for Traffic Circle Simulation Model.	5
Chapter II: Traffic Flow Theory and Simulation	12
2.1 Introduction	12
2.2 Analytical Models in Traffic Flow	14
2.3 Simulation	17
2.3.1 Modeling and Computer Simulation	18
2.3.2 Analytical vs. Simulation Models	20
2.3.3 Traffic Simulation Models	21
2.3.4 Advantages and Disadvantages of Traffic Simulation	22
2.3.5 Languages Used In Simulation	23
2.4 Simulation of Traffic Flow	32
2.4.1 Introduction	32
2.4.2 Methods of Simulation in Traffic Flow ...	34
2.4.2.1 Analog Simulation	34
2.4.2.2 Digital Simulation	35
2.4.3 Vehicle-Roadway Representation	37
2.4.3.1 Physical Representation	37
2.4.3.2 Memorandum Representation	38

2.4.3.2.1	Individual Vehicle Representation	42
2.4.3.2.2	Vehicle and Space Platoons Representation	45
2.4.4	Scanning Techniques	49
2.4.4.1	Periodic Scan	50
2.4.4.2	Event Scan	51
2.4.5	Other Traffic Simulation Models	52
2.4.5.1	Macroscopic Models	53
2.4.5.2	Microscopic Models	55
2.5	Traffic Circle and Traffic Signals	56
Chapter III:	Model Development	59
3.1	Initial Considerations	59
3.2	Primary Model Criteria	60
3.2.1	General Criteria	61
3.2.2	System Criteria	62
3.3	Simulation with Fortran	63
3.4	TRACISM (<u>T</u> RAFFIC <u>C</u> IRCLE <u>S</u> IMULATION <u>M</u> ODEL) ..	66
3.4.1	The Physical System	67
3.4.2	Vehicle Representation	69
3.4.3	Distance Headway Measurements	72
3.4.4	Vehicle Speed Determination	74
3.4.5	Model Processing Order	78
3.4.6	Circle Entry	81
3.4.7	Gap and Lag Acceptance	82
3.4.8	Measures of Effectiveness	83
3.4.9	Theory of Control Parameters	85

Chapter IV: Model Validation	90
4.1 Testing and Refinements	91
4.2 Statistical Validation	98
Chapter V: Conclusions and Recommendations	104
5.1 Conclusions on Operational Study	108
5.2 Conclusions on Study Methods	104
5.3 Recommendations for Further Study	106
References	108
Appendix A: Probabilistic Functions in the Model	113
A.1 Uniform Distribution	113
A.2 Exponential Distribution	115
A.3 Normal Distribution	118
Appendix B: Components of the Model	124
B.1 Vehicle-Index Arrays	124
B.1.1 Approach Array	125
B.1.2 Circle Array	126
B.1.3 Exit Array	127
B.2 Vehicle Lists	127
B.2.1 Approach List	128
B.2.2 Circle Lists	132
B.3 Vehicle-Characteristic Array	133
Appendix C: Program Logic and Input Organization	136
C.1 Program Logic	136
C.1.1 Vehicle Generation	137
C.1.2 Assignment of Direction	139

C.1.3	Assignment of lane	140
C.1.4	Circle Approach Flow	141
C.1.5	Gap Acceptance from Inner Approach Lane .	145
C.1.6	Gap Acceptance from Outer Approach Lane .	147
C.1.7	Inner Circle Flow	147
C.1.8	Outer Circle Flow	148
C.1.9	Exit Process	150
C.1.10	Queue Measurements	152
C.2	Input Organization	154
C.2.1	Data Type 1	156
C.2.2	Data Type 2	162
C.2.3	Data Type 3	165
 Appendix D: Analysis of directional flows		
	at Traffic Circles	169
 Appendix E: Data Collection and Analysis		
E.1	Data Collection for Peak-Hour Demand	175
E.2	Data Collection to establish Capacities of Circle Lane Sections	176
E.3	Data Collection for Gap Measurements	177

LIST OF TABLES

		Page
Table 1.1	Intersection Flow Analysis	
	Sample Summary Sheet	6
Table 4.1	Comparison of Simulated and	
	Observed Phenomena	97
Table 4.2	Performance Measures	99
Table 4.3	Wilcoxon Signed Rank Test for	
	Matched System Travel Time	
	Pairs for OD-3	101
Table C.1	Sample Data Format	
	Total Hourly Statistics	158
Table C.2	Sample Data Format	
	Periodic Arrival Percentages	158
Table C.3	Sample Data Format	
	Total Hourly Statistics	164
Table C.4	Sample Data Format	
	Periodic Turn Percentages	164
Table C.5	Sample Data Format	
	Total Hourly Statistics	167
Table C.6	Sample Data Format	
	Periodic Arrival and	
	Turn Percentages	167
Table E.1	Summary of Study Circles	176

Table E.2	Inner Lane Gap analysis	
	Summary sheet	180
Table E.3	Outer Lane Gap analysis	
	Summary sheet	181

LIST OF FIGURES

		Page
Figure 3.1	System configuration showing all section lanes	70
Figure 3.2	Vehicle positions	75
Figure 3.3	Processing Order	80
Figure 4.1	Sample Program Output	93
Figure A.1	Uniform probability distribution	114
Figure A.2	Exponential density Function	116
Figure A.3	Cumulative exponential distribution ...	116
Figure A.4	Normal probability curve	119
Figure A.5	Standard normal probability curve	119
Figure A.6	Cumulative Std. Normal curve	121
Figure A.7	Cumulative normal distribution	121
Figure B.1	Vehicle parameter list	135
Figure C.1	Scheme for gap analysis	138
Figure C.2	Vehicle generation/assignments of direction and lane	142
Figure C.3	Circle approach flow	144
Figure C.4	Inner circle flow	149
Figure C.5	Outer circle flow	151
Figure C.6	Exit processing	153
Figure C.7	Queue measurements	155
Figure C.8	Arrival frequency distribution	160

Figure D.1 Measured flows to determine
directional flows 171

Figure E.1 Schematic of Circle depicting
layouts for gap analysis studies 178

Chapter I

Introduction

1. General Introduction

The increased use of motor vehicles for the past three decades, and the prospects of even greater increases in the future, have alerted traffic engineers in particular and other public officials in general to the problem of providing adequate facilities for safe and efficient movement of traffic on the roads. The problems in the cities and metropolitan areas have already reached major proportions. Freeway developments, which emerged as a sure answer to the urban and metropolitan traffic problems, are becoming less attractive as a means of accommodating travel, due to extremely high cost and adverse social effects. Therefore more emphasis is now being placed on obtaining maximum capacity and efficiency of the existing street networks as well as improved public transit. In such a direction, detailed study should be given each element, to gain complete understanding of its operation and its relation to each of the other elements in the system.

Every driver would like to proceed as he pleases

through the street network from his origin to his destination. Since his path crosses that of other vehicles at intersection points in the system, it is desirable and in fact imperative to minimize the chances that the intersection of the vehicle paths will not result in collision or undue delay to any one vehicle or group of vehicles.

The paths of two vehicles can be separated by either space or time. When a few vehicles are distributed over a relatively large number of streets, as happens in rural networks, the separation in time due to the low probability of interference usually obviates any need to control the intersection points. When street use becomes more intense, however, the probability of time separation of vehicles by mere chance becomes smaller, and the possibility of vehicle collisions at potential intersections becomes a concern to public officials. When the severity of the problem justifies it, vehicles can either be separated at intersection points by space (grade separation) or rules can be established to force time separation.

The rules applied vary from the simple right-of-way rule to traffic control devices which range from 'yield signs' to 'traffic signals'. The degree of control should increase with increasing probability that time separation of the vehicles at intersection points will not occur by mere chance. Therefore the rules change from those requiring

restriction of one or two streams (YIELD and TWO-WAY-STOP) to those requiring restriction of all intersecting streams (FOUR-WAY-STOP, TRAFFIC CIRCLES, SIGNAL CONTROL). The question to ask at this juncture, is how to organize and control traffic so that drivers could fully enjoy an increased mobility on the roads.

"To answer this question is, in essence the job of the traffic engineer. Considering such objectives as the minimization of delay or travel time, a decrease in the number of stops, an increase in the smoothness of driving, and an increase in safety, he must fit traffic to the existing road system by regulation and control or he must fit the road system to the traffic demands by planning and redesigning." [14; p. 2].

1.2 Nature of the Problem

The flow of traffic through the urban and metropolitan areas could be thought of as vehicles moving on roadways and intersections of roadways under the following methods and devices of intersection control:

- a) Yield signs;
- b) Stop signs;
- c) Traffic circles;
- d) Fixed-time traffic signals;
- e) Vehicle-actuated signals; and
- f) Computer-controlled signal-systems.

Until a vehicle encounters an intersection (where it might experience some delay), it is assumed that the vehicle travels at a desired speed unless it follows a slower vehicle. Again, a vehicle could be delayed when it is forced to travel below the desired velocity due to a traffic congestion downstream occasionally caused by a restriction of the roadway such as construction, accident, narrowing and so on. We could say therefore that vehicular delays are caused mainly by the vehicles encountering intersections controlled by any of the six methods mentioned above.

While delay is undesirable from the driver's point of view, it serves some form of useful purpose from the point of view of the road designer or the traffic engineer. Delay is useful in describing the level of service at an intersection or in a system of streets. Also it lends itself to economic analysis. The driver, however, is annoyed by delay, and he is constantly attempting to eliminate it altogether or at least minimize it. It is useful therefore, to know what the major causes of delay are, and to what extent each contributes to the total delay in a complete network of streets. With such a knowledge, the engineer can evaluate what the overall effect would be with the removal of one of the causes of delay.

With the above reasoning, it is important therefore that the traffic engineer knows which method of control is best for a given intersection condition, having taken into

account the volume of traffic at the intersection, and the turning volumes from the various approach streams of the intersections. However, only meager information is available concerning methods of control below the level of traffic signals.

1.3 The Need for Traffic Circle Simulation Model

The overall objective of this thesis is to better identify the operating characteristics that affect the level of service at a traffic circle, and in this way give the traffic engineer some criteria for the measure of performance at a traffic circle. Once this type of knowledge has been gained, it will be relatively easy to develop criteria for deciding which method of control to apply to a specific intersection (stop signs are usually not of concern, since they are converted to signals when accidents or traffic volumes warrant such installations).

Most often the traffic engineer has available to him some form of traffic data obtained from field surveys. This data is usually made up of the total volume inflow of vehicles from the various approach directions of the intersection and the turning volumes from same (see Table 1.1). Table 1.1 is a summary of morning 15 minute peak period traffic counts stratified into the various turning volumes for cars and trucks separately.

Table 1.1
Sample Summary Sheet

15 MIN PERIOD	FROM NTH ON 280 ST.	FROM STH ON 280 ST.	FROM EST ON 114 AVE.	FROM WST ON 114 AVE.	TOTL
ENDING	LFT THR RGT	LFT THR RGT	LFT THR RGT	LFT THR RGT	
7.15 C	2 112 0	0 76 10	10 4 4	1 1 2	222
T	0 9 0	0 4 0	0 0 0	0 0 0	13
					235
7.30 C	3 166 3	0 83 5	11 11 4	4 7 8	305
T	0 9 0	0 3 0	0 0 0	0 0 0	12
					317
7.45 C	5 206 3	5 26 5	21 12 5	8 14 6	416
T	0 7 0	0 6 0	1 0 0	0 0 0	14
					430
8.00 C	0 159 1	8 165 12	18 22 4	13 6 7	415
T	1 3 0	0 14 0	0 0 0	0 0 0	18
					433
8.15 C	2 123 3	8 81 2	9 8 4	9 11 6	266
T	1 14 0	0 12 0	0 0 0	0 0 0	27
					293
8.30 C	1 108 2	6 72 6	10 11 3	5 3 1	229
T	0 10 0	0 10 0	0 0 0	0 0 0	20
					249
8.45 C	3 104 9	4 76 3	12 8 3	5 4 6	237
T	0 6 0	0 6 0	0 0 0	1 0 0	13
					250
9.00 C	0 119 19	5 56 3	8 7 2	8 5 11	249
T	0 17 0	0 10 0	0 0 0	0 0 0	27
					270
TOT. C	161097 40	36 735 46	99 83 29	53 51 48	
7-9 T	2 75 0	0 65 0	1 0 0	1 0 0	
	1230	882	212	153	2477
PEDST	NTH CRSSWLK	STH CRSSWLK	EST CRSSWLK	WST CRSSWLK	
7-9	8	14	5	4	31
PEAK C	10 654 10	21 455 24	59 53 17	34 38 27	
T	2 33 0	0 35 0	1 0 0	0 0 0	
7-8	709	535	130	99	1473
%T	5	7	1	0	
%LEFT	2	4	46	34	
%RGHT	1	4	13	27	
4HR C	592130 214	1311950 131	166 321 74	396 318 149	
TOT. T	3 146 2	1 146 0	1 0 0	4 0 1	
7-9AM	2554	2359	562	868	6343
+4-6PM					

Briefly, the abbreviations in the Table mean the following:

280 ST = Code name for Groat Road;

C = Cars;

T = Trucks;

CRSSWLK = Crosswalk;

PEDST = Pedestrian;

NTH, STH, EST, and WSI respectively stand for North, South, East and West.

Presently, there are many simulation models for signal controlled intersections, so that the engineer could always apply his data to those models; modify the data as he wished, to study the intersection performance under various operating characteristics [13, 17, 29, 31]. It cannot be overemphasized therefore, that a similar simulation model on the traffic circle should be available to the traffic engineer since the flow of vehicles through a circle deviates very much from the passage of vehicles through an orthogonal intersection under any other form of control.

During the passage of vehicles through a traffic circle controlled by unsignalized devices such as the YIELD signs, vehicles cannot be assigned a generalized velocity such as the 'constant queue discharge velocity' (a hypothetical velocity which describes the departure of queued vehicles at a signalized intersection during the green phase). This is because each individual vehicle which queues up at the entry to the circle has to evaluate and

accept or reject gaps in the circle traffic stream before entering the circle. The passage of vehicles through a traffic circle could therefore be likened to the passage of a minor street vehicle through its intersection with a major street. But, as compared to the traffic circle, the passage of such a minor street vehicle through the intersection could be thought of as being instantaneous (in the sense that, once it accepts a lag or gap to enter the intersection, it does not spend much time at the intersection).

Operational rules at a traffic circle require more interpretation on the part of the driver, and more activity, skill and alertness than at a signalized intersection. In order to study the control of traffic behaviour at traffic circles, an attempt must be made to consider fully the behaviour aspect of the operation, since there is more interplay between drivers at traffic circles than at signalized intersections. Another important characteristic of a traffic circle is the fact that the rate and time of arrivals of vehicles is of major importance, because it is vehicle presence in the circle stream that determines what the driver in the approach stream does. With the traffic circle simulation model the traffic engineer could study the performance of the circle through the use of his field data or through arbitrary apportionment of generating characteristics to the various approaches of the circle.

Presently, there is a great concern in urban areas in most countries especially in North America, where the use of traffic circle is very limited, to replace existing traffic circles with signal controlled intersections and to halt the construction of more traffic circles. But such statements are usually general policy statements, since there is normally limited valid evidence to warrant such undertakings.

Before a traffic engineer decides to replace an existing traffic circle with a signal-controlled intersection or vice versa, he must have subjected the particular intersection to variable traffic conditions through the use of a signal-controlled intersection model and a traffic circle simulation model. Then, he must have convinced himself that improvements of the intersection performance expected through such a conversion would be worth the efforts involved in the implementation of such a decision, especially before committing public funds.

Of course, such an evaluation process can only be carried out cheaply, realistically and conveniently through simulation. He needs simulation models capable of simulating the operations of the intersection under signal control and under traffic circle control. He might arrive at the conclusion that the volume of left-turning traffic from a particular approach would make a traffic circle superior to a signal controlled intersection even with

'protected' left turns, or vice versa. In short, with the capability of varying input information to both the simulation models, the engineer could evaluate the justification of any type of conversion from the use of one method of control to the other.

The above analysis of the problem of implementing some conversion policies, greatly justifies the need for the traffic circle simulation model as described in this thesis; a model which accepts traffic data of all forms, dynamically varies the arrival frequencies and turning movements during a stipulated period of the simulation, at rates specified by the traffic engineer. A model with such a capability will therefore give a good indication of the real life performance expected from the traffic circle under the specified conditions.

This thesis presents the development and validation of such a traffic circle simulation model for use as a tool in the evaluation of traffic circle performance in terms of level of service. Chapter II is a general review of existing literature covering the major analytical and simulation work done in the field of Traffic Flow. Chapter III describes 'TRACISM' the Traffic Circle Simulation Model. The Chapter is devoted to the formulation of the traffic circle simulation model. The important parts of the model are discussed with the relevant diagrams. The detailed analysis of the representations of the model in the computer

and the actual flow logic are described in Appendices B and C respectively.

Chapter IV describes the validation studies of the model by a series of simulation runs on test model configurations, and the eventual validation of the model by comparison with real data. A major part of this Chapter deals with the study of various measures of effectiveness of the circle performance. Chapter V contains the various conclusions as made evident from Chapters III and IV and recommendations for further study on the Traffic Circle and their role in urban street networks.

Chapter II

Traffic Flow Theory and Simulation

2.1 Introduction

With the recent concern for the control of urban air pollution, vehicle manufacturers are urged to produce 'roadworthy' cars with respect to pollution. In much the same way, automobile users are concerned about the roads on which they drive, and therefore urge the responsible public officials to provide 'carworthy' roads. Carworthy roads need not only be smooth with respect to potholes but also should afford smooth trips. This can be achieved through redesigning and control of the existing roads.

The importance attached to the control of traffic on the roads is evident from the numerous attempts that have been made, through the developments of various traffic models aimed at improving one traffic situation or another. Insights into the behaviour of traffic on the roads are obtained through two major approaches, namely:

- a) Experiments and field observations, and
- b) Modeling of the real situation.

The former method is not entirely satisfactory. Conclusions

drawn from field observations may be wrong because real traffic conditions usually make it impossible to reproduce the causes of the observed behaviour. The field experiments are extremely useful however, and should be conducted before a large capital outlay is made since they give an indication of the validity of the latter method. Since modeling is essentially experimenting on a working analogy having the necessary relations and properties similar to those of the system being studied, modeling techniques may be classified as follows:

(i) Analytical model.

In this case equations sufficiently representative of the system are solved analytically.

(ii) Software simulation model.

Here a large digital computer may be used to assist in the solution. This approach is particularly relevant if nonlinearities are present in the system.

(iii) Hardware simulation model.

Here a special-purpose computer constructed from units performing mathematical and/or logical operations on simulated variables is employed.

The study of the system behaviour using the software simulation model or the hardware simulation model is hereafter referred to as 'Simulation'. The next three sections give a summary of analytical models in traffic flow and the simulation of traffic flow.

2.2 Analytical Models in Traffic Flow

Solutions to traffic flow problems have been attempted by analytical methods for many years. The analytical approach has been confined mainly to analysis of uncontrolled intersections, intersections controlled by yield signs or two-way stops, intersections controlled by fixed-cycle traffic signal and those controlled by vehicle-actuated traffic signals. Most of the analytical models on the fixed-cycle traffic signals, have been concerned with the queue measurements at the beginning of red periods. The fixed-cycle traffic signal queues have been investigated by probabilistic methods by a number of investigators, and a brief review of the various methods of approach is given below.

Beckman, McGuire and Winsten [3] considered a discrete time queuing model with binomial arrivals and regular departure headways during the green phase. They went on to derive a relation between the stationary mean delay per vehicle and the stationary mean queue-length per vehicle at the beginning of a red period of the traffic signal. Haight [24] and Buckley and Wheeler [8] considered models with Poisson arrivals and again regular departure headways during green phase, and investigated certain properties of the queue length. Newell [42] dealt with the model proposed by Beckman et al, and obtained the probability generating function of the stationary queue length distribution.

Darroch [11] discussed a more general discrete time model with stationary, independent arrivals and regular departure headways, and derived a necessary and sufficient condition for the stationary queue length to exist, and obtained its probability generating function.

McNeil [36] proposed a model for the solution to the fixed-cycle traffic signal problem for compound Poisson arrivals. In McNeil's model, an intersection is controlled by a traffic signal with fixed cycle time T , the possibility of other delays such as those due to turning vehicles, is completely ignored. Arrivals at the signal form a compound Poisson process, which, as McNeil himself points out, is unrealistic since such an assumed arrival process presumes a zero car length. If vehicles arrive to a green signal and an empty queue they cross the intersection undelayed, while on the contrary, the vehicles depart when they reach the head of the queue, provided the signal is green, each vehicle taking a constant time to move off. McNeil's model contains numerous assumptions typically embodied in most analytical models aimed at simplifying the situation under study enough to make it mathematically tractable. The assumptions usually render the models too simple and unrealistic to be useful.

Vehicle-actuated signal intersections have been investigated in two ways, the non-priority and the priority types. In the non-priority type, neither of the

intersecting streets is favoured, rather the intersection is controlled by signal which favours one queue at a time and switches when the favoured queue empties. The priority vehicle-actuated traffic signal on the other hand is the one at which the main street signal is green unless traffic arrives on the side-street.

In the priority vehicle-actuated traffic problem, Little [33] has considered a queuing process of side street traffic. The intersection considered is made up of two one-way streets. But there is no apparent reason why the intersecting streets should be assumed to be one way other than to make the mathematical analysis simpler, and of course to limit the scope of the problem. In Little's model, the signal shows green on the main (priority) street unless it is actuated to change by side-street traffic. There is no detector on the main street so that the density of the main-street traffic has no effect on the operation of the signal.

Side-street traffic causes the signal to change by means of a detector which senses whether or not there is a vehicle at the intersection. After detection of a vehicle, an activation period t , must elapse before the signal changes to green for the side-street traffic, this period corresponding to the amber (clearance) period on the main road. After changing, the signal remains green to side-street traffic for a fixed interval of length g , and each

green period is followed by a red period of minimum length r . During this minimum red period, the length of which is a constant, programmed into the signal mechanism, the signal will not change to green for the side-street traffic. Little's model is very similar to the queue balancing model of Lieberman [32], where the signals do not respond to vehicle presence but rather to some threshold values of queue lengths and signal lengths. Little developed a mathematical model of the intersection operation as described above and obtained the following:

1. The transition probabilities of the queue lengths at the end of each cycle (green plus red);
2. The probability distribution of the queue lengths in the steady state; and
3. The mean queue lengths.

2.3 Simulation

Simulation could be defined as a dynamic representation of reality, achieved by building a model and moving it through time. The problems solved by simulation are characterized by being mathematically intractable and having resisted solutions by analytical methods. The problems usually involve many variables, many parameters, functions which are not well-behaved mathematically, and random variables. Simulation should therefore be the technique to apply when the number of nonlinearities in a

system makes analytical techniques inapplicable. After identifying and formulating the problem, the next major step in simulation is the modeling phase which is described below.

2.3.1 Modeling and Computer Simulation

The following concept of modeling and simulation is taken from C.W. Bell and R.N. Linebarger [4] who define modeling and simulation as consisting of four sequential steps as follows:

- a) Concept development;
- b) Model formulation;
- c) Model implementation;
- d) Model operation.

The ability to simulate system behaviour depends upon the formulation of the model, and each step in the modeling and simulation process contains a feedback path whereby implementation and evaluation of current models can generate new structures and question of validity.

The first step involves the development of the conceptual system behaviour. Here, the analyst observes and classifies phenomena into conceptual framework. The second step is the model formulation which may be done in the following four ways:

- (i) Verbal;
- (ii) Physical;

(iii) Mathematical.

The verbal model provides the structuring of the system concepts on a verbal basis and seldom undergoes implementation of any kind. Rather, the verbal model is primarily used for developing new concepts of system behaviour. The physical model is usually a scaled analogy of the actual system under study.

In mathematical models the system to be studied is represented by mathematical relations derived from observations of fundamental data. The mathematical model is almost always manipulated by means of computer simulation of the basic system state-transition functions.

After formulation, the next process is implementation. Here the abstract model is translated into some form of device which allows the model parameters and system structures to be manipulated. Physical models are implemented using physical analogies. Mathematical models are implemented using a variety of tools, primarily computer-oriented.

The final step in the simulation process is the operation of the implemented model. Here, the model parameters can be altered or varied and the resultant model response analysed. On the basis of these results, refinements can be proposed for both the formulated and the implemented model, to make them better representations of the system being studied.

In summary, the process of modeling and simulation involves a set of sequential steps with feedback paths. Inherent in computer simulation studies is the principle of interaction with an implemented model whereby the model can be exercised and the resultant response compared with observed data.

2.3.2 Analytical versus Simulation Models

There are several similarities and differences between analytical models and simulation models. Some of the similarities are:

1. Both approaches require a thorough understanding of the process being modelled.
2. Both approaches involve the formulation of an abstract model which represents a concrete situation.
3. The translation of a real situation into either type of model reflects the users concept of what the key elements of the system are and how they interact.

Some of the major differences between analytical and simulation models are:

1. The analytical model yields analytical solutions whereas the simulation model shows what happens under a particular set of assumptions and does not yield a 'solution'.
2. An analytical model, in order to be solvable is often so gross a simplification of the actual situation as

to yield invalid results. Simulation usually permits a less abstract and relatively more faithful representation of a real system.

2.3.3 Traffic Simulation Models

As applied to traffic flow studies, the following is a summary of the requirements of a good simulation model, as listed by Drew [12]:

- a) It must provide an easy, inexpensive method of traffic simulation.
- b) It must be general enough so that any similar traffic configuration can be simulated by the input of the proper geometric parameters.
- c) The input to such a program must be easily understood and capable of execution by non-computer oriented personnel.
- d) It must furnish output which is easily readable and which contains all parameters needed by the traffic engineer for application in the design or modification of traffic streams.
- e) It must be written in modular fashion, such that any of the moduli can be changed without affecting the rest of the program (for example, the car-following process should be completely independent of the input generation process, and so on).
- f) It must be written such that new moduli such as

traffic hazards, curves, and some other variable traffic conditions can be added without extensive programming changes.

- g) It must be machine independent, written in one of the higher level languages such as FORTRAN IV in such a manner that a relatively unsophisticated programmer can modify it.

2.3.4 Advantages and disadvantages of Traffic Simulation.

a) Advantages: As applied to traffic flow studies, the following is a summary of the advantages of simulation again listed by Drew [12].

1. The task of laying out and operating a simulation is a good way of systematically gathering pertinent data. It makes for a broad education in traffic characteristics and operation.
2. Simulation of complex traffic operation may provide an indication of which variables are important and how they relate. This may lead eventually to successful analytic formulations.
3. Simulation gives an intuitive feeling for the traffic system being studied, and is therefore instructive.
4. Simulation gives a control over time.

Real time can be compressed, and the results of a long signal phase can be observed in a few minutes of computer time. On the other hand, machine time can be

expanded and run slower than real time so that all the manifestations of the complex interactions of traffic movements can be comprehended.

5. Simulation is safe. It provides a means of studying effect of control measures on existing road systems.

b) Disadvantages:

There are however some disadvantages to the application of simulation to traffic flow studies. The major disadvantages are listed by Ferris [14] as follows:

1. Considerable effort is required in the programming of a simulation model of some desired complexity.
2. Simulation of traffic flow problems becomes very costly, and consideration must be given to man-machine feasibility.
3. Accurate and detailed data is essential to any traffic simulation model.

However, it should be mentioned that some of the above disadvantages apply equally to analytical models, so that the utility of simulation models is still superior to that of analytical models.

2.3.5 Languages used in Simulation

The languages used in Computer simulation studies fall into two major categories, namely:

- a) General Purpose Simulation Languages, and
- b) General Purpose Programming Languages.

The early 1960's saw the advent of several general purpose simulation languages. Most of them were adaptations of FORTRAN (for example, SIMSCRIPT, DYNAMO, GASP) or ALGOL (for example, SIMULA). Some were entirely new, for example GPSS.

a) Advantages:

1. The main advantage of the general purpose simulation languages as compared to the ordinary general purpose programming languages is the fact that the former incorporate means for controlling the sequence in which events occur. This sequencing aspect of simulation models introduces many complexities when ordinary programming languages are used, in which case the co-ordination of events in the model remains the responsibility of the analyst or sometimes the user.
2. Another major advantage of simulation languages is that their diagnostic programs can check for logical errors as well as syntax and capacity violations in the model.
3. Simulation languages usually have built-in provision for collecting and printing out at least some of the statistical outputs desired from most simulation models.
4. Finally the use of simulation languages makes the model closer in outward appearance and structure to the situation being simulated than when nonsimulation language are used.

b) Disadvantages:

1. The major disadvantage of most general purpose simulation languages is the fact that they require a large-scale computer and are often therefore limited in use. For example, GPSS/360 and Flow Simulator are designed for computers with core capacity of 64K or greater.
2. Another disadvantage of the use of most general purpose simulation languages is the fact that they are often too slow for large scale simulation systems.

Presently, there are dozens of simulation languages, but most of them are special-purpose types which are not widely used. The major simulation languages in North America today include GPSS, SIMSCRIPT, SIMULA, and DYNAMO. Of these, GPSS is the most widely used. GPSS has been more widely employed in traffic flow simulation studies than any of the other simulation languages. Before the advent of the general purpose simulation languages, general purpose programming languages such as FORTRAN or ALGOL had been used for many years for simulation studies and are still in use. Presently, the most widely used nonsimulation languages are FORTRAN, ALGOL and PL/1. Of these FORTRAN is used more often than the rest.

Watjen [51] used GPSS for the simulation of a simple traffic network, to study the effect of offsets in signal light synchronization. A pioneer application of GPSS to

the simulation of traffic flow was done by Blum [6]. He used GPSS to simulate a network of intersections where the intersection area is divided up into cells represented by facilities in GPSS.

A more recent application of GPSS to traffic flow simulation studies has been done by Lieberman [32] at the General Applied Sciences Laboratories, Inc. in New York. The model is an integrated set of computer programs which simulate traffic flow at signal-controlled intersections. The complete set of programs are collectively named SURF (Simulation of URban traffic Flow).

Intersection area in the model is subdivided into lanes some of which are accessible to both pedestrian and vehicular traffic. Separate queues are allotted for vehicular and pedestrian traffic. Each vehicle is treated as a separate transaction whose behaviour is monitored from the instant it is generated into the system until it crosses the terminate line and is discharged from the system.

The entire approach distance of each approach lane represents a queue, whereas the distance from a stop line to an intersection entry line of each approach lane represents a facility which is used by both vehicular and pedestrian traffic. Similarly, each distance of an exit lane from the intersection exit line to the terminate line (concurrent with the stop line at an approach) constitutes a facility which is again used by both vehicular and pedestrian

traffic. Thus, upon entry into the system, a vehicle travels the approach distance by spending some calculated time in the appropriate queue. Upon emergence from the approach queue, the vehicle begins its journey into and out of the intersection by successfully seizing (occupying) and releasing (leaving) facilities, until it has finally released a terminal facility after which it leaves the system.

Some prime features that are exhibited by Lieberman's microscopic model are:

1. The ability to accommodate a wide variety of intersection configurations;
2. The ability to accept multiphased traffic signals;
3. The ability to simulate traffic-actuated signals; and
4. The ability to accommodate coupled pedestrian and vehicular traffic.

Vehicle arrival is generated by approach according to a shifted exponential distribution with a minimum inter-arrival gap of one second, and a mean gap equal to the reciprocal of the specified flow rate (traffic volume in vehicles per hour). Turning maneuver is assigned stochastically based upon the specified turning percentages for each approach. A turning vehicle joins the appropriate turning lane at the approach and a through vehicle joins the shorter of the approach queues.

This method of vehicle arrival generation and eventual

assignment to a lane depending on turning maneuver of a vehicle, eliminates the possibility for lane-changing in the approach flow. This is because, during peak hours, lane-changing within the vicinity of the intersection is almost always impossible, so that upon entry into the approach, drivers quickly determine their lanes and stay in that lane for intersection maneuver.

A major objective of the simulation was to study the difference in intersection performance under fixed-cycle signal control and varying cycle length signal control. To this end, the following test models were used for validation purposes.

Model A: Two approach lanes in each direction with traffic controlled by a two-phased signal of fixed cycle length.

Model B: Two approach lanes in each direction with traffic controlled by a two-phased signal of varying cycle length. The signal timing is controlled by the density of traffic flow.

Incorporated in Model B is a well-defined algorithm of queue-balancing strategy employed by Lieberman. The objectives and the consequent measures taken to achieve the objectives through the use of the 'responsive traffic control algorithm' are:

1. Optimization of intersection performance by attempting to

- a) utilize intersection capacity fully;
 - b) reduce total delay time (in queues) to a minimum;
 - c) equalize (in each direction) the queue lengths and delay times.
2. Reduction of driver irritation and consequent accident potential with the following policies:
- a) Set maximum signal phase length;
 - b) Set minimum signal phase length.
3. Prevention of spill-back into 'upstream' intersections.

With the above objective, the following specifications were made: minimum signal length, maximum signal length, amber signal length, critical queue length for East-West traffic (EW) and critical queue length for North-South (NS) traffic.

During the simulation, traffic signal 'interrogates' intersection traffic status every simulation cycle (scan interval) and acts according to prevailing conditions. A signal remains green in a direction such as East-West unless any of the following conditions is met.

- a) Maximum signal for the direction is exceeded.
- b) If signal has been green longer than the minimum specified and not more than one vehicle occupies a queue in this direction. That is, if demand is dissipated in this direction.

c) If signal has been green longer than minimum length specified and critical queue length in the other direction has been attained or exceeded, while the queue length in this direction is shorter than the prescribed critical value.

d) If $q_{NS} > q_{EW} + E_{NS}$, where

q_{NS} = average length of North-South queues;

q_{EW} = average length of East-West queues;

E_{NS} = net inflow of vehicles in North-South lanes during period of minimum signal length.

Hence, the signal remains green until the queues in the other direction become slightly longer. For the Model A, fixed specifications were made for Green, Amber and Red for each direction. The statistics which were generated by the program included the following:

- (i) Variation of queue lengths as a function of time;
- (ii) Travel and delay times for vehicles according to discharge lane and turning maneuvers; and
- (iii) Travel and delay times for pedestrians as well.

Other statistics included the intersection capacity, expressed in vehicles per hour. After subjecting the two models to various traffic conditions of a typical intersection configuration, Lieberman [32] reached the following conclusions:

1. There is no advantage from the use of a computer controlled signal during periods of saturated demand

when the demand conditions exceed the intersection capacity.

2. When demand conditions exceed intersection capacity, there may be only slight improvement in overall delay time when a responsive signal replaces a fixed time signal. But the responsive signal gives a remarkable improvement in the balancing of queues at the various approaches.
3. Intersection performance improves substantially in all respects, if the incoming flow rate is at, or below saturation level when a computerized signal system replaces a fixed cycle system.

A novel feature in Lieberman's model is its ability to simulate varying (peak-hour) demand conditions. When varying traffic demands are simulated, queue lengths and delay times are greatly reduced during peak hour traffic conditions due to the response of the signal to changing traffic demand in the use of the responsive system.

Lieberman's model is very realistic and excellent as a tool for helping the traffic engineer in the evaluation of intersection performance. The model is more of a tool than most other models because in Lieberman's model the traffic engineer does not have to worry about input data such as vehicle acceleration, vehicle deceleration and other such 'hard-to-collect' data.

The input data required by the system is precisely

that information which is available to the traffic engineer.

This data consist of:

- a) density of vehicular and pedestrian traffic flow from each direction;
- b) vehicular turning movements from each direction;
- c) signal phasing and cycle time (or actuated control specifications).

This description of Lieberman's simulation program shows how GPSS can be applied in complex traffic situations.

2.4. Simulation of Traffic Flow

2.4.1 Introduction

To fully evaluate the effect of a traffic situation, it would be desirable to test it under a wide variety of conditions. It would be of further benefit to vary certain parameters while holding others constant, thereby permitting conduct of experiments similar to those in the laboratory. It is not practicable however, for the traffic engineer to study operations under such controlled conditions in the field. Therefore he must resort to methods of analogy, or modeling.

"Simulation probably provides the most accurate form of assessment of a road network, parameters can be altered at will, and the resulting changes in delay and journey times noted for costing purposes. The parameters that can be altered are numerous and

include not only traffic signal control policies, but also road alterations or the flows and routes taken by different categories of vehicles. It is the ease with which the network can be altered, controlled and assessed that makes simulation so vital to area traffic control" [48; p. 464].

The application of simulation techniques enables the study of complex traffic systems in the laboratory rather than in the field. It is usually faster and less expensive than the testing of real system and in many cases enables the study of system characteristics prior to construction of the facility. In the study of traffic simulation, it is possible to represent traffic of a particular characteristic desired and in the quantities desired, whereas to obtain the characteristics in the field may be very difficult. Furthermore, there are substantial hazards in conducting field trials whereas such situations can be studied by simulation without risk.

Blackmore [5] at the Road Research Laboratory has conducted experiments in the field by setting up experimental tracks and briefing the participating drivers on how to drive through the tracks. It is evident that the success of such a field experiment depends on the cooperation of the participating drivers, and that such experiments could be very expensive.

"For the most part it can be said that the goals

achievable by simulation in the traffic flow process are clearcut and rewarding. Simulation is an ideal technique for traffic research. The simulation model is not just another means for accomplishing what we can do today but it is a tool, for solving problems which cannot be solved today" [12; p. 286].

2.4.2 Methods of Simulation in Traffic Flow

There are two general types of computers namely:

Analog (continuous-variable) and Digital (discrete-variable) computers, and both types are employed in simulation studies. A simulation technique is classified as analog or digital, depending on the way the problem is formulated and the type of computer needed for the formulation and solution.

2.4.2.1 Analog Simulation

An analog computer is one in which computation is performed by varying the state of some physical elements in which the variables are continuous. When analog simulation is employed, all parts of the system must be simulated simultaneously. The parallel nature of analog simulation therefore makes it closer to the traffic behaviour than does digital simulation.

Each component or function of the analog simulation system must be simulated by one or more components in the computer. This nature of analog simulation always requires

the addition of more computer equipment as the system being simulated becomes more and more complex. For small systems this requirement is not serious, but for the study of large systems the addition of more simulator elements can become expensive. Moreover, in many cases further additions of simulator elements may not be feasible because there is a practical limit to the number of simulator elements that will work together satisfactorily.

Furthermore, the accuracy of the analog computer is limited to the accuracy of the physical components involved. Thus, the use of analog simulation in traffic studies becomes attractive when a special part of a general system is to be scrutinized, and this leads to the building of a special purpose model; but analog technique becomes less attractive as the problem under study becomes more and more generalized.

2.4.2.2 Digital Simulation

Digital simulation is characterized by the use of a digital computer. Whereas the analog computer must handle all elements of the simulation system simultaneously (in parallel) the digital computer handles elements of the simulation system one after another (in series). In this way, an increase in the system complexity results in an increase in the time required for computation. Although accuracy may not necessarily be an important factor in the

simulation, it is possible in digital simulation to reach any degree of accuracy desired by carrying out more computations.

In analog simulation, the mathematical models used must be those which involve differential equations or which can be made to look as though they involve differential equations. In digital simulation, the analyst has the choice as to the representation of traffic on the roadway depending on the detail of simulation required. There are two major methods of representation in a traffic simulation, the microscopic representation and the macroscopic representation. For single intersections, the microscopic approach of detailed vehicle characteristic assessment is usually employed. When considering vast intersection networks, the large amount of real traffic and area involved in the simulation may obviate the use of the microscopic approach. In such situations, the macroscopic approach is imperative because of computer time and core storage requirements. Again, the choice will be a function of the available facility and the desired level of detail required in the model.

2.4.3 Vehicle-roadway Representation

In digital simulation, where there is a flow of discrete objects such as vehicles on the roadway, there are two general ways in which the objects may be represented for the purposes of simulation in the computer, the physical representation and the memorandum representation.

2.4.3.1 Physical representation

With the physical representation, one or more binary digits are assigned to represent the presence, position and perhaps the size of the item or vehicle to be simulated. Certain areas of the computer memory are assigned and organized in such a way as to represent the flow network, and the groups of binary digits representing the items are caused to flow in the network by suitable manipulations.

The implementation of the physical method of vehicle representation requires considerable familiarity with the computer hardware configuration, and as such is not a suitable method to choose when developing a simulation model which is meant to be a tool for non-computer-oriented personnel.

2.4.3.2 Memorandum representation

Memorandum representation consists of recording all conditions pertaining to a given vehicle where representation is by bits, bytes or words of computer memory uniquely associated with this vehicle. These defined memory locations are usually referred to as vehicle parameters. When the vehicle parameters are stored using a single coded computer word, the parts of the word signifying different attributes of the vehicle-driver characteristics can be extracted and interpreted using suitable computer routines. This method of attribute extraction and storage to and from a computer word (usually referred to as 'unpacking and packing of a word') could be time consuming, especially when certain attributes such as the position and velocity of the vehicle are to be updated every scan interval of the simulation. When computer memory preservation is not crucial, especially with the advent of virtual memory in modern computers, it would be more efficient to let one computer word store a single attribute and thereby reduce the time used in computation.

The memorandum method is easier to understand and to program for the computer than the physical method. The status of each vehicle is kept in the memory circuit of the computer when using the memorandum method. The data for each vehicle usually include position (distance from starting point or reference point), lane, desired speed,

actual speed, turn requirements (points at which turns are to be made). Other desirable information would include the length or class of vehicle (whether a car or a truck), normal acceleration and deceleration, passing characteristics of drivers, and the time at which the vehicle entered the system.

One computer word is usually assigned to each vehicle to conserve computer storage space. In the memorandum representation, a register or memory cell of the computer is used as a clock counter. The clock counter is advanced at each simulation cycle, and the memoranda of vehicles and other data are scanned to determine the kinds of actions to be taken by different parts of the system. These actions can be summarized in the following decision blocks:

- a) Is it time for a new vehicle to enter the system?
- b) Is this vehicle going to encounter another vehicle during the next unit of time?
- c) Is it safe to pass the leader?
- d) Is it time for a vehicle to select a routing lane for intersection maneuver?

Once such questions have been answered, each vehicle can be advanced by changing the record to show its position and speed one time unit later. The position one time unit later is calculated by multiplying the vehicle's speed by the length of the unit of time and adding the product to the present position of vehicle.

Memorandum method may be varied by allocating one memory cell to each unit block. If a vehicle is in a given block then data concerning the vehicle may be stored in the corresponding memory cell. Thus it may not be necessary to otherwise record the position and lane of each individual vehicle in the system. In this way, different forms of memorandum representation could be applied depending on the form of distribution of traffic in the network or the individual intersection as required by the analyst.

The form in which the network or the individual intersection is represented in a computer program will determine the following:

1. The amount of information concerning individual vehicles that can be stored; for example, position, type, speed, entry lane, destination, travelling times and so on.
2. The computing time and storage requirements of the program.
3. The structure of the simulation, taking into account the updating routines and routing rules in the system.

The above features in computer programs demand some form of memorandum representations, typical examples of which are:

- a) Individual vehicle representation, where each vehicle is allocated an initial position, speed and destination. Its position and speed being updated each computer cycle.

- b) Vehicle spaces, where the network is divided into vehicle spaces and a number stored in each address representing a vehicle space indicates the speed of the vehicle occupying that space. Usually a zero indicates a vacant space. In this type of representation, vehicles have no identity and intersection routings are based upon simple deterministic or probabilistic rules.
- c) Platoons, where the network is divided into vehicle spaces as in (b); the spaces in a lane are then grouped into blocks consisting alternatively of vehicles, spaces, vehicles.

The number of vehicles, or spaces in each block is then stored in successive computer addresses. For each lane, the occupancy of the first block is stored at another address (zero for spaces, unity for vehicles).

Gerlough and Wagner [19] have applied the concept of the individual vehicle representation to the detail simulation of an individual intersection. Longley [34] has also applied the representation of vehicle and space platoons to the simulation of signalized intersection network aimed at controlling and balancing queues at the various approach lanes.

42

2.4.3.2.1 Individual Vehicle Representation:

Gerlough and Wagner [19] of the Planning and Research Corporation at Los Angeles have developed and implemented a detailed microscopic simulation model of an individual intersection. Their simulation employed the individual vehicle representation method and was implemented with a General Purpose Programming Language -- FORTRAN II. The simulation model of Gerlough and Wagner is an isolated signalized intersection in which the roadway is represented as an orthogonal intersection of two six-lane bidirectional roadways.

Each artery constitutes a co-ordinate system whose origin happens to be the intersection entry line, and in which the positive scale is the direction of flow from the artery in question. All negative co-ordinates are considered as part of approach leg and all positive co-ordinates are part of an exit leg.

Upon entry into the system, vehicles have negative positions, travel to zero position at the entry line to the intersection, and begin a journey on a positive scale as they enter the intersection.

Vehicles are generated by lane at the predefined system entry points according to a composite exponential distribution developed by Kell [29]. For a particular direction, such as the Northbound direction, each approach lane of the artery forms a list with its continuous lane on

the exit leg of the Southbound artery; so that for the six-lane bidirectional intersection, the maximum number of lists that would be maintained is 12. Thus, each list is made up of an approach portion and exit portion with intermediate portion being the intersection estate. Vehicle processing through the system is done by means of pointers to the first and last vehicles of approach portions and exit portions of the lists.

The number of vehicles in the approach lanes and the exit lanes of a list, at any time are stored in some variables. By identifying each vehicle with a lane-list corresponding to its directional co-ordinate system, straight through vehicles are simply processed from the approach portion of a list to the exit portion of the same list and turning movements are accomplished by transferring vehicles from a particular lane list (originating list) to another (destination list).

Maximum turning velocities for all turn movements are derived according to the turn radii of each particular turning path, and this velocity is assumed to be sustained throughout the turn process when turning can be made unimpeded. Right turns are assumed to follow the same path whereas left turns have two configurations--one for free flow turns and the other for delayed turns when there is a conflict in turning due to oncoming vehicles. Since maximum turn velocities are derived based solely on turn radii,

there are two types of maximum turns velocities for left-turning vehicles: one for free flow left-turners and the other for delayed left-turners.

Vehicle motion in the system is evaluated by applying some acceleration equations to the individual vehicles. These equations are referred to as the 'car-following and the free-behavior' equations.

A vehicle in the system is either a leader or a follower, it is automatically a leader if it is the first vehicle on a list, but it could still be considered a leader if it is not the first on a list and still its free flow motion is uninhibited by preceding vehicles; otherwise it is a follower. During each period of the simulation, a vehicle is updated by applying the appropriate equation to it according to the position of the vehicle in relation to the rest of the vehicles in the system and to other decision models such as signal system.

Slowing down and or stopping occur in a variety of situations such as red light approaches, amber light approaches and blocked turns. Upon generation, each vehicle is tagged with desired velocity, desired acceleration and deceleration; all obtained from precoded distributions whose means are supplied as input to the model.

Queue statistics are provided for in the model and the underlying assumption here is that vehicles become members of a queue when they stop behind other vehicles which are

already in the queue. For a leader of an approach lane of a list, it enters into a queue when it is required to stop at the intersection stop line due to one of the stopping criteria. A great deal of analytical statistics are provided for in the system to be used as parameters for the measurement of effectiveness. Included are such things as the number of stops, stopped time per vehicle, maximum stopped delay, mean stopped delay and so on.

Mean system delay (referred to by Gerlough and Wagner [19] as 'primary measures of effectiveness') was correlated to most of the rest of the statistics gathered in the system collectively referred to by Gerlough and Wagner as 'secondary measures of effectiveness'. The secondary measures of effectiveness included the mean stopped delay, mean stopped delay per stopped vehicle, mean queue length, mean delay in queue, and proportion of vehicles stopped. The results of the regression analysis showed that all the five secondary measures of effectiveness were very strongly correlated with the mean system delay, the primary measure of effectiveness.

2.4.3.2.2 Vehicle and Space Platoons Representation:

Longley [34] has applied the representation of vehicle and space platoons to the simulation of signalized intersection networks aimed at controlling and balancing queues in the various approach lanes. In his representation, current vehicle speeds are not stored, but

are allocated on the basis of headway only. The apparent major objection to this technique as pointed out by Longley himself is the fact that vehicle acceleration constraints are neglected. But to use it as a readily available tool, the traffic engineer does need to make field surveys in order to be able to estimate accelerations and decelerations of drivers using the roadway, so that the crude model of Longley is deemed satisfactory.

In the simulation, speeds are restricted to the discrete values of 0, 15, or 30 miles per hour only but speeds at the intersection are restricted to 15 miles per hour only so that acceleration from 0 to 30 miles per hour in one second, which would otherwise be unrealistic, is avoided. Longley, by these speed assignments, assumes that travel speeds of 0 to 10 miles per hour are effectively stopped; speeds of 11 to 20 miles per hour are equivalent to 15 miles per hour, and speeds of 21 to 30 miles per hour are equivalent to 30 miles per hour.

These discrete speeds look unrealistic at first glance, but for simulation of large intersection models or networks, the above speed assignments approach the continuous nature of actual driver speeds based on acceleration and deceleration rates; yet much computation time is saved by by-passing the detail computation of travel speeds for individual vehicles based on acceleration and deceleration models. However, the speed assignments could

approximate closely the continuous speed distribution scheme, by widening the range of choice of speeds from 0, 15, 30 to say 0, 10, 20, 30 or even 0, 5, 10, 15, 20, 25, 30 miles per hour and still maintain the time-saving headway method of speed assignment (determination) .

Each vehicle space in Longley's model represents a distance of 22 feet and vehicle positions are updated in each computer cycle representing 1 second real time. The updating routine is performed in two phases. In the first phase all lane vehicles except those queueing at the intersection stop lines, are moved up one vehicle space. In the second phase platoons of vehicles with individual headways of two or more vehicle spaces are moved along a further 22 feet corresponding to speeds of 30 miles per hour. With British cars the effective car length of 22 feet as chosen by Longley is satisfactory. In North America however, a more realistic effective car length would be 25 feet.

Movement of vehicles in the four intersections making up the network is carried out in two stages: The occupancy of the first vehicle space from which the vehicle would leave is determined, and a check is made to see if a space exists at the rear of the receiving lane in the intersection. This first procedure is necessary in order to avoid the process of making all necessary checks in preparation for a merging vehicle from an approach when in

actual fact, no vehicle might have reached the point of entering the intersection yet.

Thus the knowledge of the occupancy of the first space is a necessity in Longley's model, just as Gerlough and Wagner [19] store the information about the first vehicle in any list.

The intersections are considered to be 66 feet square and non-turning traffic moves across them at a speed of 15 miles per hour. Vehicles in the intersection square move across it when the light is amber or green, and enter the center lane of the receiving road, provided that vacant space exists at the rear end. Entry into the intersection was restricted by the condition that a vehicle could enter the intersection only if there are a total of less than four vehicles in the intersection, and four vehicle spaces at the rear end of the receiving lane. This rule ensured that no vehicle was stranded in the intersection so long as the amber time equaled or exceeded 3 seconds; the vehicle could always clear the intersection during the amber phase at the prescribed speed of 15 miles per hour or 22 feet per second. This is because Longley does not allow a vehicle to enter the intersection if the signal goes amber, so that with an amber time of at least 3 seconds, the three vehicle spaces in the intersection lane would be cleared at the constant speed of 15 miles per hour by any vehicle which happened to be caught in the intersection before the signal went amber.

But the condition that vehicles are never allowed to enter the intersections when the signal goes amber is too strict and unrealistic, since from the speed distributions in his model, vehicles could reach the intersection stop line at speed of 30 miles per hour when the signal goes amber, and at such a speed it is unrealistic not to allow some of the vehicles on the platoon to run the amber as happens in real traffic situations. It would seem more reasonable to stop vehicles from running the amber when a vehicle is already stopped before the signal went amber, but that some probabilistic way be employed to let a vehicle run an amber if the vehicle is already in motion and at the intersection stop line at the time the signal goes amber.

2.4.4 Scanning Techniques

In digital simulation, whether by standard general purpose programming language or by a general purpose simulation language, time is usually divided into discrete units, and since it is impossible to examine, within the digital computer, all parts of the system simultaneously, some form of scanning must be employed in the simulation. Simulation packages such as GPSS maintain this form of clock updating and correlate events automatically. With the standard programming languages, the clock updating routine is the responsibility of the analyst or the user.

Whether the system accounts for the clock updating or

the user accounts for clock updating, there are two general scanning methods available. These are the periodic scan and the event scan.

"An event-scan program is essentially asking 'what happens next?'; whereas the periodic-scan program asks 'what will the situation be one time unit from now?'" [12; p. 274].

2.4.4.1 Periodic Scan

'Periodic scanning' consists of scanning and updating the entire system once during each unit of time. This technique is very straightforward and is easy to program. For example when periodic scanning is employed in the simulation of an individual intersection, then during each particular scan interval every vehicle is updated in turn whether or not it is scheduled to perform any action during the current scan interval. When all vehicles have been updated in terms of accelerating them, decelerating them, stopping them or whatever, then all generating points are checked for possible entry of new vehicles into the system. In short, the entire simulation system is scanned in any one particular interval before the clock is advanced to the next simulation interval.

2.4.4.2 Event Scan

'Event scanning' consists of determining the next event of significance by extrapolation and moving the clock to this event without any intervening scans.

For example, when an event scanning technique is employed in simulation of traffic circle or any unsignalized intersection, vehicles queueing up behind other vehicles at the circle entry line or at the minor roads of the unsignalized intersection would not be scanned during each scanning interval. Instead, the imminent significant events such as the acceptance of gap by a leader of queued vehicles and eventual entry into the circle, the entry of new vehicles into the system or the exiting of vehicles from the circle, would always be determined and stored and the earliest one to occur selected. The occurrence of this next significant event may alter the possibility or timing of other events that had been listed, so that a new set of events and times be calculated. The event-scanning technique saves a lot of execution time but requires more programming complexities and more computer storage.

Usually, the periodic-scan and the event-scan methods are partially combined in order to produce a program that is best suited to the problem at hand. This is true especially in the simulation of traffic phenomena at unsignalized intersections, uncontrolled intersections, or traffic circles. Since vehicles occupying different parts of the

roadway in such a simulation system would have different priorities based solely on their positions on the roadway; it would be necessary to update priority-vehicles first before the non-priority vehicles. The idea of updating priority-vehicles first, especially the leaders in the same priority lanes, is event-scanning in nature, where the earliest imminent events are always selected first for updating. On the other hand, the idea of not moving the simulator clock to suit a particular event but instead continuing to scan the rest of the vehicles in the entire system after updating the priority-vehicles, is periodic-scanning in nature. In simulating traffic phenomena, partial combinations of periodic- and event-scanning techniques are therefore not only suitable but necessary in order to simulate the parallel nature of traffic flow in real situations.

2.4.5 Other Traffic Simulation Models

The actual application of computers to the study of traffic flow problems was initiated by Goode, Pollmar and Wright [20] when in 1956 they developed a model which simulated the movement of traffic through signalized intersections. Since the work of Goode et al, traffic simulation studies have expanded considerably with the two main methods of approach being the 'macroscopic method' and the 'microscopic method' as already mentioned.

2.4.5.1 Macroscopic Simulation Models

The macroscopic method of simulation has been applied mainly to large networks of intersections, the sizes of which usually obviate the use of microscopic simulation methods. The majority of macroscopic traffic simulations have the same approach which is the division of the roadway into coarse segments and keeping track of the number of vehicles in each segment during the entire period of the simulation. Variations of this approach have been used by Sakai and Nagao [46], Katz [27] and Gerlough [17]. The length of the roadway segment is dictated by the current traffic conditions and the detail desired in the simulation. The length of the cell is usually equal to the mean distance that an average vehicle would travel in a scan interval, which makes the periodic scanning technique suitable for the macroscopic simulation of networks.

Macroscopic network simulation models have varied in degree of detail and complexity depending on the primary objective of the various models. When the modelling of the network is used merely as a tool to test the validity or effectiveness of some design criteria or proposed strategy, then the network is usually simplified to suit the purpose. But when the modelling of the network is done solely to simulate the behaviour of an actual traffic network where validation of the model would be carried out by comparison with real traffic data, as many complexities involved in the

real network situation as possible are included in the simulation model.

Examples of network simulation models in which the networks are simplified to study some other design criteria are:

1. The network simulation model by Watjen [51] of the Technical University of Denmark. The aim of this study was to investigate the delay of vehicles traversing three intersections using a variety of synchronizing offsets. The secondary objective of his simulation was to study the effectiveness of the application of GPSS to traffic simulation studies. Watjen's model comprised only a single lane of one-way traffic and a fixed-cycle signal scheme at each of the three linearly arranged intersections. The only variables in the model were the offsets of signal two from signal one and that of signal three from signal two. The model is of course oversimplified and in fact too simplified to be useful; however, the objectives of the study were realized. The study shows that GPSS/360 is useful for such small scale, non-detailed simulation and that inter-signal influences in a network should be considered when simulating a large network of signalized intersections.

2. Similarly, the network employed by Longley [34] in his simulation was four symmetrical orthogonal intersections which formed a square. In this simulation also, the primary objective is the queue balancing strategy, so that the

complexity and realism in the network itself, is a secondary matter.

However, in other major network simulation studies such as that of Katz [27], where model validation is done by comparison with real traffic data from specific locations, all complexities and details of the network are included in the model, because the primary objective in such models is the study of behaviour of vehicles in a real traffic network. The advantage in the use of macroscopic representations lies in the efficient usage of computer storage and the speed of computation, and are applicable particularly to large networks where slight errors are negligible; however they suffer the disadvantage of lack of model realism and detail.

2.4.5.2 Microscopic Simulation Models

Microscopic methods are usually employed in the simulation of individual intersections where detailed realism is important. The obvious disadvantage in the use of microscopic methods for simulating traffic behaviour lies in the inefficient use of computer space and time, but when the model is not very big or when computer time and space are not crucial, the use of microscopic methods should always be preferred since microscopic models tend to convey more understanding than macroscopic models. The most well-defined microscopic simulation model is the one by Gerlough

and Wagner [19] as described in section 2.4.3.2.

2.5 Traffic Circles and Traffic Signals

At high traffic flows, the most convenient form of intersection control is a grade-separated one, since with grade-separation only turning traffic encounter any form of conflicts, and even this form of conflict is treated by imposing a priority intersection such as a 2-way STOP or by imposing a traffic circle or a traffic signal.

Grade separation is employed on freeways and other intersections where flows are very heavy, because of the high importance attached to the avoidance of any form of slowing down or delay to main road traffic. The Highway Capacity Manual [26] implies that in a rural area at least, grade separation is justified if total demand at intersection exceeds 4000 vehicles per hour. While grade-separated intersections are ideal from the driver's point of view, they have major disadvantages such as:

1. they are extremely expensive to construct;
2. the amount of land taken up is very high;
3. interference with pedestrian movement is maximized by grade-separated structures.

The last two disadvantages of grade-separated intersections are more pronounced in urban areas with the additional disadvantage that grade separation is particularly intrusive environmentally, and may have adverse social effects.

In urban areas therefore it is particularly important to exploit to the full, the potentialities of at-grade intersections. The two major forms of at-grade intersections are signal-controlled intersections and traffic circles. The choice between signal-controlled intersections and traffic circles is evident from the following characteristics of the two forms of control as given by Millard [37]:

- a) The land taken up by the ordinary conventional large central island traffic circle is greater than that for traffic signals. In urban situations, where land acquisition may be crucial, this is often the deciding factor for the choice of signals over circles.
- b) Where flows are unbalanced, particularly if traffic entering from one arm greatly exceeds traffic leaving by it, as occur at some intersections during peak hours; traffic circles cause undue delays to traffic from the minor streets.
- c) Left-turners are as a rule very poorly treated by signal-controlled intersections. Usually either a special phase is needed or they must queue up in an approach. Either procedure delays them and reduces the capacity of the intersection. When the number is large, a traffic circle treatment is to be preferred.
- d) Three-way intersections are not satisfactorily treated by traffic lights, especially if the flows are

balanced. The same is true to a lesser degree, at five- and more-way intersections.

The above characteristics spell out the fact that while traffic circles may be regarded with disfavour, due to substantial delays liable to be experienced by drivers when capacity is exceeded, they cannot be ignored or eliminated completely from urban street network if utmost efficiency is to be achieved in the system.

Chapter III describes a model which can be used to study the operation and performances of traffic circles of different configurations.

Chapter III

Model Development

3.1 Initial Consideration

Most traffic simulation models are claimed to be tools, aimed at helping the traffic engineer in the evaluation of one traffic situation or the other. However, in the majority of these models, the kind of data required, such as the acceleration and deceleration constraints, vehicle-driver reaction times and other data of the like, make such models impracticable due to difficulty with which the data could be obtained. It was decided therefore to develop a traffic simulation model which would meet the kind of data readily available to the traffic engineer and be accurate enough to give a true indication of the traffic situation.

To assess the performance of a traffic circle of assumed configuration, the random nature of the distribution of turning vehicles within the circle traffic stream should be taken into account and included in the analysis. The model which was built to meet the above specifications was given the acronym TRACISM (TRAFFIC CIRCLE SIMULATION MODEL).

In TRACISM the traffic engineer need not specify the acceleration and deceleration of the drivers occupying the two-dimensional roadway. At the beginning of each scan interval vehicles are deterministically reassigned velocities taking into account only their current headways and velocities.

In this model, the general procedure followed to obtain a value of stochastic variable is to transform by an appropriate function, a random sample from a uniform distribution in the interval 0 to 1. These transforming functions are in the case of driver desired velocity, a normal distribution and for interarrival time gaps, a negative exponential distribution (see Appendix A). After generating an arrival, the Monte Carlo technique is used to assign destinations (turning or straight through) to the vehicles of the arriving traffic stream.

3.2 Primary Model Criteria

The objective of this thesis in the area of simulation was to develop a model with sufficient accuracy to describe the operation of a traffic circle under a number of controlled conditions. The following criteria based on the above objective of the thesis, have been established for the model.

3.2.1 General Criteria

- (i) The model should be flexible enough to allow variations of physical, control and operational conditions with minimum effort. To this end, the number of circle arms, lanes and the general geometrics of the circle should be made variables so that they can be changed as required.
- (ii) The model should realistically and accurately simulate system conditions for the purposes of the study being undertaken. This will require the use of stochastic models to describe operational and driver behaviour variations at the traffic circle. The stochastic models will include the choice of circle routing lanes, the choice of exit lanes and the acceptance of gaps in the circle traffic stream from the approach streams.
- (iii) The model should exclude refinements which do not add significantly to the accuracy of the simulation phenomenon. Such refinements as the actual diameter of the central island of the circle, and of the circulating lanes, which do not add significantly to the operational efficiency of the model, should therefore be excluded from the model.
- (iv) The input should be based on operational patterns and characteristics which can be readily measured and checked by the traffic engineer. In this respect,

such data as driver reaction times, accelerations and decelerations which are not so obviously and readily measured by the engineer, should be eliminated if possible.

(v) The output should be designed to allow testing and analysis in the simplest possible manner. As a tool therefore, the output should contain those statistics which are relevant to the engineer; typical of such outputs are measures like the time spent in approach queues, the demand at the circle, (number of vehicles entering the system), the capacity of the circle (number of vehicles leaving the system within the simulation period), mean system transit times, mean system delays and so on.

(vi) The amount of data and its processing for a particular investigation should be minimal.

3.2.2 System Criteria

(i) The model should be flexible enough to describe operation of a traffic circle  particular vehicle, as an average per vehicle or as a total for the system. Thus, the model should be able to simulate trucks only or cars only or the mixture thereof.

(ii) The system should be sensitive enough to show operational variation with a significant alteration at

any one point in the system. For instance, if the frequency of arrivals at a particular artery changes significantly during some specific short period of time, such a variation in the demand should reflect on the delay to vehicles in this particular approach direction, the queue lengths in the lanes of this approach direction, and in the system as a whole, and all the measures of effectiveness which depend on the traffic demand at that particular approach direction.

3.3 Simulation with FORTRAN

In discrete-event simulation the language used must enable the system designer to represent a complex system conveniently and comfortably. The representations could involve such requirements as solving of equations, preserving interrelations, representing decision logics and physical characteristics of the system. The languages employed vary from Assembler languages through the general purpose programming languages (FORTRAN, PL/1, ALGOL) to the general Purpose Simulation languages (GPSS, SIMSCRIPT). In TRACISM, the general purpose programming language FORTRAN IV was chosen as the tool over the available General Purpose Simulation languages, notably GPSS, for the following reasons:

- (a) GPSS/360 is available only on larger machines so that the use of such a language would limit the scope of

the model and hence limit its use as a tool for the traffic engineers.

- (b) The speed of execution in GPSS tends to decrease with the growth of model size and complexity; and as a tool, it is important that execution be as fast as possible to make the use of the model economical.
- (c) It is easier to expand or decrease the size of the model through redimensioning of the appropriate FORTRAN arrays than it would be for a novice programmer to use the REALLOCATE feature in GPSS to expand a model programmed in GPSS.

According to Reitman [45], the general requirements of a language in the area of simulation may be reduced to four basic characteristics as follows:

1. Short-term results;
2. Ability of system to represent real world;
3. Long-term results;
4. Effort required.

FORTRAN meets the above four requirements for the purposes of this study as summarized below.

(a) Short-term results: The system designer must have a good programming background in the language before he can use it for simulation. But FORTRAN, being one of the most common languages gives less difficulty as far as background in programming is concerned.

(b) Ability of system to represent real world. Almost

any real-world condition could be represented in FORTRAN; the effort goes up, however with complexity in a nonlinear relationship.

- (i) Logical situations in the model can be represented without difficulty.
 - (ii) Mathematical capability of the language is excellent. There are numerous special-purpose techniques for data smoothing, linear programming, and other forms of data manipulations which are both available and accessible for the simulation.
 - (iii) Maximum model size is completely under the control of the programmer. He can make trade-offs between storage hierarchy and speed of execution.
- (c) Long-term results. In this area lies the most important advantage of language generality.
- (i) Documentation is under the control of the individual. There are aids in the form of cross-reference files after the individual has thoroughly set up his comments.
 - (ii) System designers other than the original model developer can easily follow the logic and detail of the simulation with less effort.
 - (iii) Computers of different manufacturers can use the same higher-order language program. Usually there is some requirement for rework; but in the overall size of effort, this would be considered minor.

(d) Effort required. Less effort is required to carry out the simulation in FORTRAN than it would be for the rest of the General-Purpose programming and simulation languages. Several programmers can work on the simulation in parallel if the conventions governing the transfer of data between subroutines are well planned in advance. In this respect, a simulation program written in FORTRAN, in modular fashion, can easily be altered by anyone with a working knowledge of FORTRAN, and in particular, parts of the program can be altered without affecting the whole program.

3.4 TRACISM (Traffic Circle Simulation Model).

The Traffic Circle Simulation Model has been developed as a tool for the traffic engineer in his evaluation of traffic circle performance in terms of capacity and other measures of effectiveness. The model has therefore been designed to be as flexible as possible in terms of ease of application and some other general terms; and still give results accurate enough for the purposes of the evaluation study being undertaken. A more detailed description of the model in terms of programming logic and input data organization is given in Appendix C. This present section describes the model at the design, geometric and representation levels.

3.4.1 The Physical System

The physical system represented by the model is a traffic circle of arbitrary central island and up to six circle arms (also called 'arteries') and 1250 feet of approach distance. Entry into the circle is controlled by YIELD signs situated at a car length from the circle entry lines of the various approaches. The physical dimensions of the circle in terms of central island radius, and the radii of the circulating lanes are not supplied to the simulator as input; instead the following configuration options are specified by the user of the model:

1. The number of arms at the circle. This could be as few as three and as many as six, but in each case, it is assumed that the circle distance from one arm to the other is the same for all adjacent arms, so that for a 4-arm circle for instance, the distance from one arm to the other along a particular circulating lane constitutes a quadrant of the circle. Each arm of the circle is made up of an approach portion and an exit portion so that ideally, the number of generating points in the system is always equal to the number of arms at the circle. However, an arm of the circle could be transformed into a one-way street into or out of the circle by merely suppressing the exit or approach portion of that arm during an input conversion phase.

2. The approach distance of all approach lanes in the system is supplied to the simulator as input. This

distance, when specified, is the same for all approach lanes and sets up the system boundary for the model. The approach distance should be a multiple of the effective length of a queued vehicle (also specified by the user) so that the maximum number of vehicles that can be queued up at an approach lane at one time could easily be calculated at the beginning of the simulation period.

Currently, the distance is set at 1250 feet so that with an effective car length of 25 feet there can be a maximum of 50 queued vehicles in any approach lane during any particular time of the simulation, and therefore an excess of 50 will indicate an intolerable situation (probably a spill-over into an upstream intersection). The system can be expanded however, by simply re-dimensioning the appropriate arrays in the program; a process that is easily accomplished by anyone with a working knowledge of Fortran.

3. The circle circulation lanes and the number of lanes at the approach and exit portions of each arm are set at 2 each, but again, this figure can be changed to any desired value in the input phase. However, it should be mentioned that any number of lanes specified in the input phase applies to all the three portions of the physical system namely: the approach, exit and circle sections. For example, if the number of lanes specified is 3, then it means that there are 3 circulating lanes around the circle,

3 approach lanes and 3 exit lanes at each arm of the circle.

4. The effective length of a queued vehicle, also known as vehicle space in the system, is specified as part of physical configuration of the system, since it affects the specification of the approach distance of the circle arms.

The various arms and lanes are numbered in an anticlockwise direction. For a 2-lane circle configuration all inner lanes on all parts of the system are odd-numbered lanes, and all outer lanes are even-numbered lanes. The system configuration depicting the numbering system in the model is shown in Figure 3.1.

3.4.2 Vehicle Representation

Vehicles are represented in the system by the individual vehicle space method as described in this section. A vehicle space is equivalent to an effective car length as specified in the input phase, so that the various sections of the system are considered as being made up of discrete vehicle spaces. However, vehicles are not physically moved from one vehicle space to the other within the same section of the system. Instead, a vehicle in the system is always thought of as having occupied a vehicle space in a section of the physical system, and movement is accomplished by updating the position parameters of the individual vehicles.

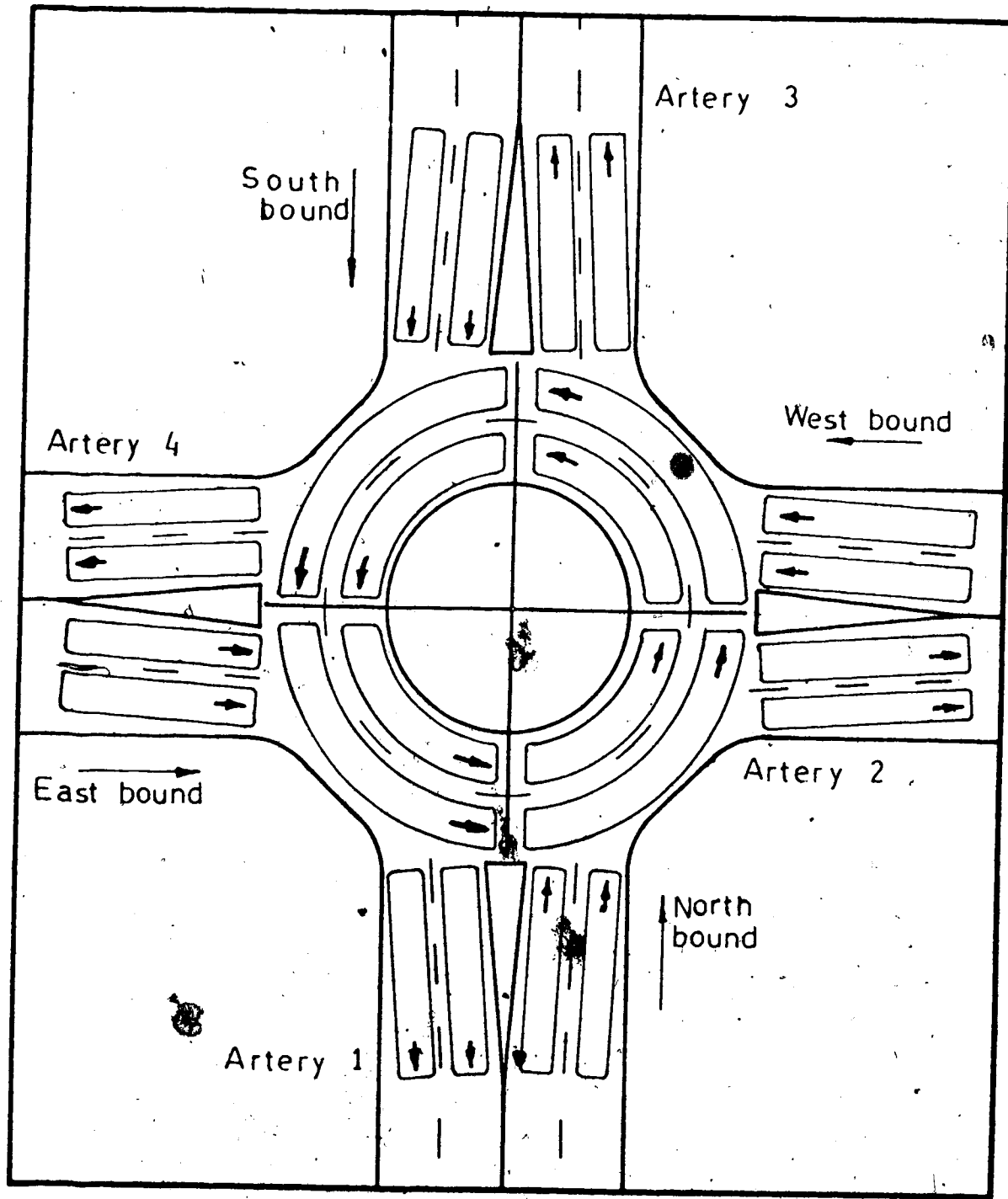

Figure 3.1
System configuration showing all section lanes.

Vehicles are generated at the various generating points of the circle arms on an approach basis and assigned to a lane of that approach depending on the predetermined destinations. Upon generation, each vehicle has 11 parameters associated with it. Some of these parameters are given initial values upon entry into the system while others are given values during the course of the vehicle's passage through the system and at the time of exit from the system. The parameters that are initialized on entry into the system are: the originating approach lane, destination artery, time of entry into the system, vehicle desired velocity and the current velocity and position of the vehicle.

During the passage of the vehicle through the system, the current velocity and position are updated continuously while other parameters such as the time of entry into queue and the time of entry into the circle are recorded and stored in the appropriate parameters of the vehicle. The artery by which the vehicle enters the system is not stored as a parameter attached to the vehicle, since a knowledge of the approach lane number, automatically gives an indication of the originating artery of the circle. A vehicle covers the approach distance at a speed of 30 miles per hour (the maximum allowable speed on the approach portion of the system) unless it follows a slower vehicle or unless it has to join a queue at the approach. Upon entry into the circle section of the system, vehicles travel at 20 miles per hour

(the maximum speed on the circle) unless they follow slower vehicles. When a vehicle comes to the desired exiting artery of the circle, it exits from the system by travelling one vehicle space along the exit lane. After travelling that distance along the exit lane, the time of departure from the system is recorded, the rest of the desired statistics about the vehicle are gathered by accessing the parameters associated with the vehicle, and the vehicle is eventually removed from the system. The statistics gathered about the individual vehicles are analyzed on per lane, per approach and per artery basis to produce the desired measures of effectiveness as described in section 3.4.7.

3.4.3 Distance Headway Measurement

The determination of distance headways of vehicles in the system is the same for all vehicles on the approach, circle and exit portions of the system. When the distance headway has been determined the assignment of subsequent speeds is different for vehicles in the approach lanes and in the circle lanes, because the model assumes different speed limits for vehicles on the approach lanes and the circle lanes. Presently, the speed limits have been set at 30 miles per hour on the approach and 20 miles per hour on the circle. In distance headway measurements we scan all lists in the system, computing spacing between all vehicles during each scan interval.

Suppose the average length of a vehicle is 17 feet, and the effective length of a queued vehicle is taken to be 25 feet in the system; this implies that the length of a vehicle space is 25 feet and therefore a minimum spacing of 8 feet between successive vehicles is inherent in the system. There are three ways in which the vehicle position is reckoned in simulation systems. The position of a vehicle in a simulation system could be taken as the position concurrent with the front bumper of the vehicle, or the rear bumper or even the midsection of the vehicle. With any of the above representations a minimum safe distance of 8 feet between successive vehicles becomes inherent.

In this model, the position of the vehicle at any time in the simulation is taken to be the position concurrent with the Front Bumper of the vehicle.

The following procedure of determining distance headways of vehicles in the system was adopted:

Suppose the position of vehicle I, the leader, at time t is X feet, that is

$$\text{POS}(I, t) = X$$

and $\text{POS}(I+1, t) = X'$ = Position of vehicle I+1, the follower at time t. Then the headway H between vehicle I and vehicle I+1 during the scan interval at time t is given by

$$H = \text{POS}(I, t) - (\text{POS}(I+1, t) + \text{ELENTA})$$

$$= X - (X' + \text{ELENTA}) \text{ where}$$

ELENTA is the specified effective length of, a queued

vehicle, also taken to be the length of a vehicle space in the system. The above procedure of calculating headways of vehicles in the system always maintains the existence of a safe minimum inter-vehicular spacing in the model (as illustrated in Figure 3.2).

3.4.4 Vehicle Speed Determination

Current vehicle speed and position are continuously stored during the simulation period, so that new speeds and positions can be computed for the vehicles during the next scan interval.

Speed distributions in the system are approximated as summarized below:

SPEED CODE	SP0	SP1	SP2	SP3
VALUE	0	1	2	3
M.P.H	0	10	20	30
FEET/SEC	0	15	30	45

During a scan interval (equivalent to 1 second real time) vehicles in the system are either stopped or travelling at 15, 30, or 45 feet per second depending on the available distance headway and the section of the physical system being occupied by the vehicles. Around the circle however, vehicles are either stopped, or travelling at 15 feet per second or 30 feet per second (corresponding to speeds of 0, 10, or 20 miles per hour respectively); since a speed of 30 miles per hour is not permitted around the circle.

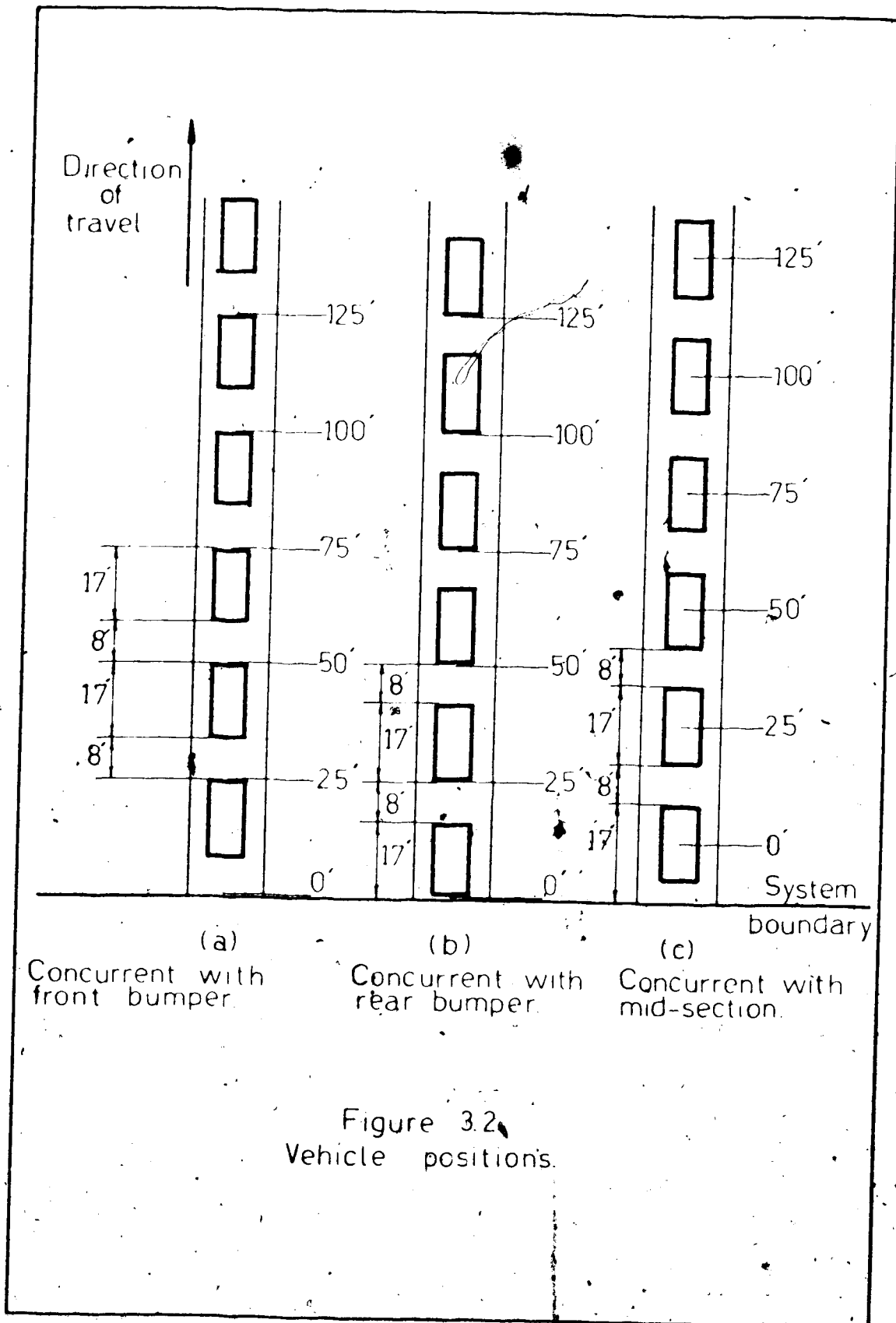

As soon as a vehicle stops in the approach lane (that is, when the vehicle attains a speed of SP_0), its progression is monitored until it is able to merge with the circle traffic stream. This accounts for the delay on the approach. Suppose that the distance headway H of a vehicle has been determined (as in section 3.4.3), then the speeds and positions are updated as follows:

For the leader of an approach lane the updating logic is:

$$\begin{aligned} \text{(a) } H \leq 15 \text{ feet} \quad & \text{VEL}(1,t+1) \leftarrow SP_0 \\ & \text{POS}(1,t+1) \leftarrow \text{LENT} \end{aligned}$$

where LENT is the approach distance to be covered. That is, if the leader of the approach lane is within 15 feet of the circle entry line and there is no acceptable gap in the circle traffic stream, then the vehicle is decelerated to a stop at the circle stop line during the next time interval and awaits the next acceptable gap. However, within the distance of 15 feet of the circle, if there is an acceptable lag or gap in the circle traffic stream the vehicle would accelerate into the circle.

$$\begin{aligned} \text{(b) } 15 \leq H \leq 30 \text{ feet} \quad & \text{VEL}(1,t+1) \leftarrow SP_1 \\ & \text{POS}(1,t+1) \leftarrow \text{POS}(1,t) + 15 \end{aligned}$$

That is, if the distance headway is greater than 15 feet but less than 30 feet (if there is a distance headway of at least one car length) the vehicle would accelerate or decelerate in order to cover a distance of at most 15 feet during the next time interval, depending on the current

speed of the vehicle. Such an updating process may seem unreasonable, but remembering the fact that the model is structured towards peak hour flows, it is reasonable to assume that queued vehicles move up slowly at a circle whenever there is a headway of at least half a car length.

$$(c) \quad 30 < H \leq 75 \text{ feet} \quad VEL(1,t+1) <---SP2$$

$$POS(1,t+1) <---POS(1,t+1) + 30$$

For a distance headway of at least a car length and at most three car lengths, a vehicle travels at a speed of 20 miles per hour and covers a distance of 30 feet in the next time interval.

$$(d) \quad H > 75 \text{ feet} \quad VEL(1,t+1) <---SP3$$

$$POS(1,t+1) <---POS(1,t+1) + 45$$

For a distance headway of more than three car lengths, there is enough room for a vehicle to accelerate to a speed of 30 miles per hour, providing that it is not accelerating from rest (that is if its current speed is not zero).

For subsequent vehicles, the determination of vehicle speeds and eventual updating of vehicle positions is the same as that for the leader of the lane except that no vehicle other than the leader is allowed to enter the circle stream within the same scan interval of 1 real second. Vehicle speed and position updating are the same for the circle lanes as for the approach lanes except that the maximum speed around the circle is set at 30 feet per second (20 miles per hour) as opposed to the maximum speed of 45

feet per second (30 miles per hour) on the approach.

3.4.5 Model Processing Order

At a signal-control intersection there is less interplay between drivers, especially when the intersection is under a 4-way phasing scheme where every intersection routing is protected. Even in the ordinary 2-way phasing scheme, there is less interplay between drivers than at a traffic circle. This is because, during the green phase, straight through and right-turning vehicles from the opposing directions have some kind of synchronized actions of intersection routing without much interference other than that due to pedestrian; only left-turning vehicles have any form of interplay with opposing oncoming vehicles. Thus, in simulating a signal-controlled intersection, all lanes of a particular approach could be processed or updated before considering another set of lanes, and still be within reasonable accuracy with this form of serial processing.

However, at a traffic circle where there is almost no evidence of synchronized driver reactions from the intersecting traffic streams, parallel processing of vehicles at the circle is imperative if any form of accuracy is expected in terms of approximation to real situations. Since the presence of other vehicles in the circle traffic stream, the arrival of other vehicles in the circle and the exiting of yet other vehicles from the circle do dictate

what other drivers in the approach lanes do, it is important to co-ordinate all movements in the system.

In this model therefore, the sequencing of simulated vehicle maneuvers had to be performed with some care, since an essentially parallel operation in real traffic system is simulated by a serial computation in the digital computer.

As a general rule, vehicles are only allowed to enter a lane after the vehicles in that lane have been updated.

In order to implement this condition, the exit lanes were the first to be updated, and the total sequence employed is illustrated in Figure 3.3, and summarized below:

- (i) Each individual maneuver (such as the 'Inner Approach Lanes') was updated in all four arterials before the next set of lanes was processed.
- (ii) Traffic was considered to have left the system as soon as a vehicle had passed one vehicle space along the exit lane, so that no computer time was wasted in updating outward-bound traffic on the exit roads.
- (iii) The circle arms and roadways were numbered so as to retain uniformity of circle operation in the system.
- (iv) The simulation included the assumption that the exit roads were clear so that traffic was always free to leave the system. This assumption was guaranteed valid by the fact that exit lanes were the first to be processed at the beginning of each scan interval.

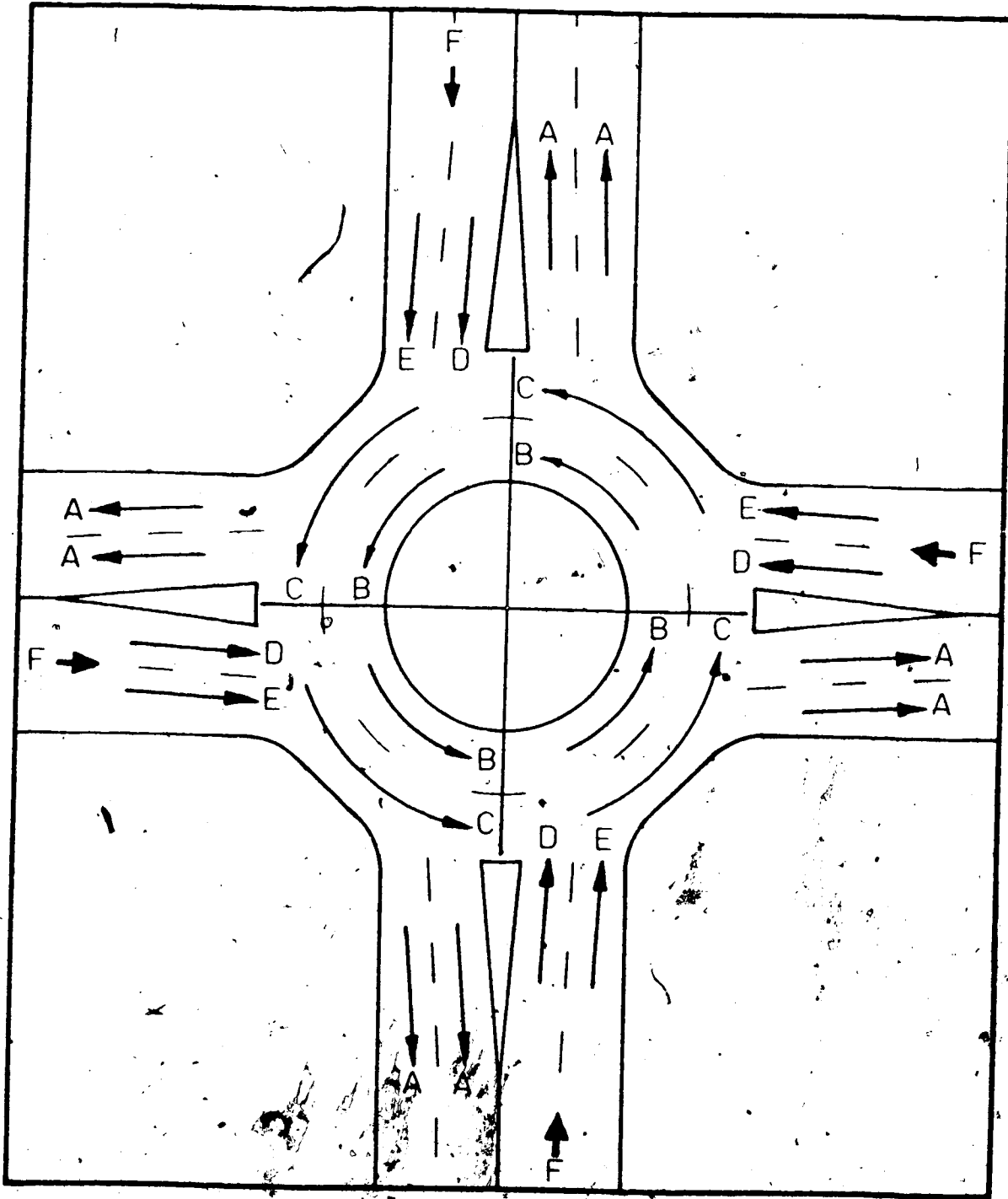

Figure 33-

Processing order.

- A — all exit lanes
- B — all inner circle lane sections.
- C — all outer circle lane sections.
- D — all inner approach lanes.
- E — all outer approach lanes.
- F — all generating points.

3.4.6 Circle Entry

Approach vehicles at the circle entry line which are ready to merge with the circle traffic stream have to evaluate the gaps in the circle stream by means of some deterministic rules. The circulating lanes in the circle are divided into sections, forming separate lanes in terms of circle configuration and processing. For a 4-arm circle with 2 circulating lanes, division of lanes will result in 8 separate circle lane sections; for a 5-arm circle with 2 circulating lanes division of the lanes will result in 10 separate circle lane sections, and so on.

Vehicles ready to enter the circle find themselves confronted with two streams of traffic to their left and right. A potential merger attempts an entry into the circle after completing the following safety checks:

1. that the portion of the circle where he intends to drive to, is free of vehicles;
2. that he could drive to his destination in the circle before a vehicle from a left lane of the circle occupies the space.

In short, a potential merger from an approach lane always defines some form of a safety zone which should be completely free of vehicles before an entry into the circle would be attempted. Different potential mergers define different unique safety zones based on their own judgements taking into account the abilities of their vehicles and

their own responses. This type of decision is usually carried out by means of a stochastic model which randomly assigns safety zones to all vehicles which are ready to merge with the circle traffic stream. But in this model, a uniform deterministic way of safety zone evaluation is adopted after field observations of gap acceptance maneuvers at some traffic circles. Measurements were made at some specific traffic circles in the City of Edmonton as described in Appendix E, and upon those measurements a safety zone was selected for all vehicles ready to merge with the circle traffic stream.

3.4.7 Gap and Lag Acceptance

The acceptance or rejection of a time or space gap is a binomial response and is dependent on the size of the gap. The minimum time or space gap that a driver accepts is fixed for that driver. He will reject all gaps smaller than that time interval and accept all gaps larger than that time or space gap. There is an evidence that this minimum acceptance time or space gap would decrease with time pressure and the number of vehicles in the circle traffic stream.

A lag at the circle may be defined as the time interval between the arrival of an approach street vehicle, and the arrival thereafter of the first vehicle in the circle section at a reference point. A gap at the circle is

defined as each time or space headway formed by successive crossing of a reference line by circle lane vehicles.

If the approach street vehicle moves into the circle before the arrival of the first circle lane vehicle, the driver of the approach street vehicle is said to "accept" the lag. If he remains until after the first vehicle passes, he has "rejected" the lag. After rejecting a lag, he then evaluates the gaps between the successive circle lane vehicles. Each gap that he fails to accommodate his vehicle into is said to be rejected. The gap that the driver finally moves his vehicle into is said to be accepted.

3.4.8 Measures of Effectiveness

Measures of effectiveness, sometimes referred to as figures of merit, are used in most traffic simulation models for both validation and research purposes. For validation studies, measures that are readily obtainable in supporting field studies are chosen for determination of equivalence between the simulated system and actual system performance. On the other hand, for research purposes, measures are chosen that indicate efficiency and uniformity of traffic flow. Such measures usually include spot speeds, average acceleration and deceleration, system entry speeds and other measures which are often irrelevant as far as comparison with actual data is concerned.

In designing this model, several different measures were considered, most of which are for validation studies more than for research purposes. The measures include the following:

1. directional flows at the circle;
2. average waiting time in a queue;
3. mean transit time by route;
4. mean delay by route;
5. mean system delay;
6. mean delay by approach;
7. mean delay by lane;
8. average queue length
9. maximum queue lengths;
10. mean system transit time.

The measures of effectiveness indicated above are figures that are readily obtained by field counts and surveys and some data reduction and analysis, so that validation of the model realism by comparison of simulated phenomenon with real traffic data is easily accomplished. Various tables are provided for on lane, approach and entry basis, so that any form of queue balancing or equalisation of delay policies can easily be implemented. Some of the tables are also provided for on origin-destination (route) basis so as to give an indication of the effect of circle routing on the delays and travel times.

Using this traffic circle model, a number of

simulation runs were carried out to indicate the degree of detail required in the simulation of traffic circles. The results of these runs for some typical traffic circle configurations are given in the next Chapter together with the appropriate refinements to the model.

3.4.9 Theory of Control Parameters

Let (\bar{a}) be the vector which describes the probabilities of vehicle arrival at the various approaches of the circle arteries. Then (\bar{a}) is given by

$$(\bar{a}) = \begin{pmatrix} a_1 \\ a_2 \\ \cdot \\ \cdot \\ \cdot \\ a_n \end{pmatrix}$$

Where n is the number of arteries at the traffic circle.

Let $[\bar{t}]$ be the matrix which describes the waiting probabilities (also called the turning probabilities) of the arriving vehicles; then the matrix is represented as:

$$[\bar{t}] = \begin{bmatrix} 0 & t_{12} & \dots & t_{1n} \\ \cdot & & & \cdot \\ \cdot & & & \cdot \\ \cdot & & & \cdot \\ t_{n1} & t_{n2} & \dots & 0 \end{bmatrix}$$

$[\bar{t}]$ is an $n \times n$ square matrix with zero diagonal elements,

where n is as defined above.

t_{ij} = probability that a vehicle from the approach leg of artery i will exit from the circle by the exit leg of the j -th artery

$i, j = 1, 2, 3, \dots, n \quad i \neq j$

$t_{ij} = 0$ if $i=j$.

Basing a measure of performance of the traffic circle on the queue lengths and the waiting times in the queues as well as the delays experienced by the vehicles during their passage through the system; the following queue, waiting time and delay matrices are maintained in the model:

$[\bar{Q}]$ is a matrix which contains the average queue lengths maintained at the approach lanes. For a circle of 2 approach lanes at each of the approach legs, $[\bar{Q}]$ is an $n \times 2$ matrix for an n -artery traffic circle, given by

$$[\bar{Q}] = \begin{bmatrix} Q_{11} & Q_{12} \\ Q_{21} & Q_{22} \\ \vdots & \vdots \\ \vdots & \vdots \\ Q_{n1} & Q_{n2} \end{bmatrix}$$

Similarly, $[\bar{W}]$ the matrix of waiting times in the approach queues is represented as follows:

$$[\bar{W}] = \begin{bmatrix} W_{11} & W_{12} \\ W_{21} & W_{22} \\ \cdot & \cdot \\ \cdot & \cdot \\ W_{n1} & W_{n2} \end{bmatrix}$$

Q_{ij} = average length of the j -th queue at the approach leg of artery i .

W_{ij} = average waiting time in the j -th queue of the i -th artery.

$[\bar{D}]$ is a matrix which describes the vehicle transit delays in the system, and is represented by:

$$[\bar{D}] = \begin{bmatrix} 0 & D_{12} & \cdot & \cdot & \cdot & D_{1n} \\ D_{21} & 0 & D_{23} & \cdot & \cdot & D_{2n} \\ \cdot & \cdot & \cdot & \cdot & \cdot & \cdot \\ \cdot & \cdot & \cdot & \cdot & \cdot & \cdot \\ D_{n1} & D_{n2} & \cdot & \cdot & \cdot & 0 \end{bmatrix}$$

D_{ij} = the average delay (slowing and stopping delays) to the vehicle which enters the system by the approach leg of artery i and exits from the system by the exit leg of artery j .

The following relationships based on the above control parameters have been established in the model:

1. $[\bar{Q}] = f((\bar{a}), [\bar{t}])$
2. $[\bar{W}] = g((\bar{a}), [\bar{t}])$

the average queue lengths and the average waiting times in the queues are both functions of the arrival

probabilities and exiting probabilities (together referred to as 'generating characteristics').

3. $[\bar{D}] = h(\bar{a}, [\bar{t}])$

the delay to the vehicles is also a function of the generating characteristics.

Thus varying \bar{a} and $[\bar{t}]$ would result in varying values of $[\bar{Q}]$, $[\bar{W}]$ and $[\bar{D}]$. It is possible therefore to determine the values of \bar{a} and $[\bar{t}]$ by manipulating the total and turning volumes of traffic at the circle that would yield saturation values for $[\bar{Q}]$, $[\bar{W}]$ and $[\bar{D}]$, assuming that some limits have been placed on $[\bar{Q}]$, $[\bar{W}]$ and $[\bar{D}]$ beyond which the use of traffic circle would be regarded with disfavour. This kind of circle evaluation study is necessary for the implementation of some conversion policies from the use of an existing traffic circle to traffic signals or the decision to construct new traffic circles within some localities.

When flows are very light it suffices to control the intersection points with YIELD signs, 2-way STOP signs or even 4-way STOP signs, depending on some other characteristics of the intersection such as the range of visibility from the various approach streams. As flows at the intersection get heavy, it becomes necessary to go into more restrictive control such as the use of traffic circle or traffic signals. It is important that the traffic engineer establishes the unsuitability of the use of a

traffic circle at the particular intersection before going into the installation of traffic signals.

The suitability or unsuitability of a traffic circle with respect to the above performance measures can be established by controlling the values of (\bar{a}) and $[\bar{t}]$ to study the distribution of $[\bar{Q}]$, $[\bar{W}]$ and $[\bar{D}]$. By the use of a model with signal control, it will be possible to obtain the distributions of $[\bar{Q}]$, $[\bar{W}]$ and $[\bar{D}]$ under signal control, and thereafter establish criteria for the implementation of a policy in favour of a traffic circle or a traffic signal.

Chapter IV

Model Validation

Validation in traffic flow simulation studies is the process whereby the simulation model is evaluated by either a straight comparison with actual traffic behaviour or through some statistical methods, to determine whether the model satisfactorily duplicates real traffic behaviour. Since it is not the goal in traffic simulation to reproduce all minute details in real system, it is necessary to establish in the beginning of the simulation those characteristics of real traffic which the model must duplicate in order to be considered as a useful model; in other words, which criteria are to be used in validation process.

Theoretically, the model should duplicate the characteristics that the traffic engineer uses as design criteria or the characteristics that the engineer uses as operational criteria. However, the choice of the characteristics for validation studies is more often than not dictated by the feasibility of their measurements in the field, since any traffic flow simulation validation is meaningless unless there is a measure of comparison from

actual traffic situations.

The lack of adequate data on the operational measures of a traffic circle limited the validation studies to the flow characteristics at the circle and the travel times during peak flows. From the analysis of the observed data as obtained from the Traffic Division of the City of Edmonton Engineering and Transportation Department, the directional flows at the study circles were chosen to be the characteristics for operational criteria and hence for validation process. Additional field studies were undertaken at specific traffic circles to determine the real travel times for some particular origin-destination routes. The validation process involved two sequential steps: the refinement of the model during test runs; and the comparison of performance between the simulated and real system.

4.1 Testing and Refinement

The testing of the model was done in two stages: First, a test run was made on the simulation model for a given set of conditions in the system. The realism of the model was then tested in a general way by observing whether or not the outputs were reasonable. Second, a more exacting test was applied by simulating conditions for actual locations (see Appendix E for the specific locations). The simulation was carried out for four different cases of peak-hour traffic input conditions as follows:

Case

- C1 Constant Incoming flow rate, and constant turning rates
- C2 Varying Incoming flow rate, and constant turning rates
- C3 Constant Incoming flow rate, and varying turning rates
- C4 Varying Incoming flow rate, and Varying turning rates.

For each peak-hour traffic data obtained for a particular location, the model was employed for successive runs under the conditions as specified by the four cases above. The output of a typical run for a specific input data is shown in figure 4.1 .

The average travel times and the number of vehicles through, are categorized by origin-destination, with the approach lane as the origin and the exit artery as the destination. In this way the 16 allowable routes in the system are given by the 16 origin-destination codes starting from 1 through 16. The allowable routes are the right-turn maneuvers by outer lane vehicles, the left-turn maneuvers by inner lane vehicles only and straight-through maneuvers by both inner and outer lane vehicles.

Run number 1
 Duration of run 3600 secs.
 Simulation time interval 1 secs.
 Current time of simulation 2700 secs.
 Fill time 900 secs.

Average Travel Times/Vehicles through

OD-Code	Time (secs)	Vehicles Through
1	20	197
2	26	354
3	19	73
4	26	150
5	25	110
6	19	319
7	15	28
8	21	262
9	26	515
10	23	266
11	84	29
12	43	37
13	19	319
14	25	20
15	19	109
16	23	298

Figure 4.1

Sample Program Output

Figure 4.1 (contd.)

Avg. Queue Length/Max. Queue Length/Avg. Wait in Queue

Lane	Avg. Que. Lnth.	Max. Que. Lnth.	Avg. Wait
1	1	6	8
2	1	7	40
3	1	5	21
4	1	6	19
5	2	13	30
6	1	15	75
7	1	5	16
8	1	9	21

Vehicle entry/Turn maneuvers/Output flows

Artery	Entry	Lft.	Thru	Rgt.	Exit Flow
1	775	354	347	73	763
2	715	110	581	28	956
3	848	266	544	37	395
4	744	20	617	109	972

Mean System travel time = 26 seconds

Mean System delay = 6 seconds

Figure 4.1

Sample Program Output

For example:

OD-1 South-north maneuver via Inner lanes

OD-2 South-West maneuver

OD-3 South-East maneuver

OD-4 South-North maneuver via outer lane and so on.

The queue statistics are gathered on per approach lane basis, so that the output shows the queue statistics for the 8 approach lanes of a 4-legged 2-lane traffic circle.

The vehicle entry and exit flows are both recorded on an artery basis to indicate how many vehicles enter the system by an artery and how many leave by that same artery. However, the vehicle entry statistics are further stratified into left-, through-, and right-turn maneuvers. Obviously the results are specific to the particular traffic circle configuration. However, on the basis of these restricted studies the model has demonstrated its ability and usefulness as a tool to the traffic engineer.

The accuracy of the model was tested by comparing the outputs of the simulation with field measurements of the same parameters. This led to an iterative process whereby the model was made successively more accurate through a series of refinements. The refinements of the model included both parameter tuning and logic modifications.

For parameter tuning, the effective vehicle length was varied between 20 and 30 feet while holding the rest of the system parameters constant. Examination of the various

output results and comparison with observed data indicated that an effective vehicle length of 25 feet was most appropriate. In the logic modification stage, the allowable routes in the system were initially made to include U-turn maneuvers at the circle; but the inconsistency of the simulation results with observed data (which was collected and analyzed on the assumption of non-U-turners) necessitated the exclusion of U-turn maneuvering from the logic of the system.

The refinement phase was repeated until results were deemed satisfactory. Upon completion of the refinement phase the model was employed to investigate the comparison of performance between the simulated and real systems. Comparison of the results was categorized by origin-destination on both the simulated and real systems.

Table 4.1 shows the comparisons employed for the various cases of peak-hour traffic demands. The Table lists the computed inflow of traffic and the computed results of circle capacity, in vehicles per hour. Real data were derived from traffic counts and surveys conducted by the City of Edmonton Engineering and Transportation Department, Traffic Division. The Capacity/Demand Ratio is simply the ratio of computed capacity and computed incoming flow, both in units of vehicles per hour (VPH). The reasonable agreement shown in the computed and observed values supports the validity of the model.

Table 4.1

Comparison of Simulated and Observed phenomena

<u>Case</u>	<u>C1</u>	<u>C2</u>	<u>C3</u>	<u>C4</u>
Morning Peak				
Computed Incoming Flow, VPH	4097	3807	4106	4121
Observed Incoming Flow, VPH	3456	3456	3456	3456
Circle Capacity } Computed	4102	3823	4207	4112
(VPH) } Observed	3456	3456	3456	3456
Computed Capacity/Demand Ratio	1.001	1.003	1.020	0.997

The computed values shown in Table 4.1 were obtained for 4 different cases of peak hour conditions because the specific case (under which the available data was collected) was not known. It was not possible to duplicate in the simulation, the exact traffic conditions of peak-hour flow during which the data was collected; so periodic flow and turn rates supplied to the simulator as inputs were based on estimates taken from 15-minute counts of peak-hour traffic flow.

It is interesting to note that more vehicles left the system within the one hour peak period than entered it, as indicated by some of the Capacity/Demand Ratios. The explanation of this discrepancy is the fact that, for any one hour period simulated, a 15-minute period of fill-up was simulated prior to that one-hour simulation period.

Therefore, when the simulation is started, there are already some vehicles in the system. Thus the number that would leave the system may or may not reflect the number that entered it within the one-hour duration. This fill-up concept is very reasonable, since it would be unrealistic to assume that there would be no vehicles in the system before the beginning of a one-hour peak period. Table 4.2 lists some of the performance measures computed in the model for the four different cases of variable generating characteristics for a typical traffic circle configuration.

The model was not validated for all the measures of performance due to the lack of adequate data, but since driver attitude indicate that delay is a prime concern, the statistics from the system are worth considering for efficient use of the traffic circle simulation model for more detailed evaluation studies on the traffic circle.

4.2 Statistical Validation

The validity of the model has further been examined by applying a suitable two-sample statistical testing procedure to the system statistics for the data set pairs (simulated and observed) obtained. The data set pair for the statistical validation studies was the simulated and observed average travel times by route.

Table 4.2
Performance measures

<u>Case</u>	<u>C1</u>	<u>C2</u>	<u>C3</u>	<u>C4</u>
Avg. System Travel Time (secs)	24	29	21	27
Avg. System Delay (secs)	6	10	5	11
Max. Queue Length, Northbound (veh)	7	9	6	5
Max. Queue Length, Westbound (veh)	5	7	6	9
Max. Queue Length, Southbound (veh)	14	25	10	8
Max. Queue Length, Eastbound (veh)	7	10	9	19
Avg. Wait in Queue, Northbound (secs)	20	18	14	13
Avg. Wait in Queue, Westbound (secs)	15	17	11	11
Avg. Wait in queue, Southbound (secs)	44	62	22	16
Avg. Wait in Queue, Eastbound (secs)	19	28	27	40

data was collected on one of the study circles for the afternoon peak-hour flow, by merely timing the individual vehicles from the instant they enter the system (after crossing a predetermined system boundary) until they exit from the system. The timing was done by an ordinary stop watch, so that the timing process could be repeated over and over again to make the data collection process attain some degree of reasonable accuracy.

Lack of vantage point for the whole of the approach legs and exit legs of the circle limited the field studies

to vehicles from one approach leg only. This accounted for 4 origin-destination routes for the right-turning maneuver, left-turning maneuver and straight-through maneuvers from either of the approach lanes. However, greater faith was placed in the average travel times of the right-turning maneuvers, since visibility was better only for adjacent arteries of the circle.

Let m_i be the average travel time for the i -th run, $i = 1, 2, 3, \dots, 8$, observed in the real world for a particular origin-destination pair in the model.

Let u_i be the corresponding true, but unknown average travel time for the simulation.

Let t_i' be the average travel time measured for a complete set of simulation runs.

The null hypothesis:

$$m_i = u_i, \quad i = 1, 2, 3, \dots, 8$$

is then tested by considering the statistic

$m_i = t_i', \quad i = 1, 2, 3, \dots, 8$, that is, by comparing the real average travel times and the simulated average travel times.

Now, consider the statistics $m_i - t_i' = D_i$. Application of the Central Limit Theorem implies symmetry of the distribution of the statistics $m_i - t_i'$. Also, these statistics can be assumed to be independent. Again, the numbers $D_i = m_i - t_i'$ may be assumed to be continuous

random variables. Hence the Wilcoxon Signed Rank Test may be used on the numbers

$$D_i = m_i - t_i, \quad i = 1, 2, 3, \dots, 8$$

to test the following hypothesis:

$$H_0 : m_i = u, \quad i=1, 2, 3, \dots, 8$$

$$H_1 : m_i \neq u, \quad i=1, 2, 3, \dots, 8.$$

The steps involved in the Wilcoxon Signed Rank Test are summarized in Table 4.3

Table 4.3
Wilcoxon Signed Rank Test for
Matched System Travel Time Pairs for OD-3

	RUN NUMBER							
	1	2	3	4	5	6	7	8
Real Avg. Travel Time (secs)	38	31	29	28	29	24	26	30
Simulated Avg. Travel Time (secs)	29	24	31	24	29	30	27	30
Difference	9	7	-2	4	0	-6	-1	0
Sign of Difference	+	+	-	+		-	-	
Rank of Difference	6	5	2	3		4	1	
Signed Rank	6	5	-2	3		-4	-1	

$$\sum - = 7$$

$$\sum + = 14 \quad P = 0.562$$

From Table 4.3 for an effective sample size of 6, the two-tailed significance probability corresponding to $\sum = 7$ (the smaller sum) is given by

$$P = (2) (0.281) = 0.562$$

for OD-3 (South-East traffic).

We could also define the test statistic T as the sum of the assigned ranks of the positive differences, that is,

$$T = \sum_{i=1}^6 R_i$$

where $R_i = 0$ if D_i is negative

$R_i =$ the rank assigned if D_i is positive

$$\text{so that } T = \sum + = 14$$

Now, for a two-tailed test and a critical region of size $\alpha = .05$, we accept the null hypothesis H_0 if T is between $w_{\alpha/2}$ ($=1$, obtained from Table of Quantiles for Wilcoxon Signed Rank Test) and $w_{1-\alpha/2}$ ($=20$, obtained from Table of Quantiles for Wilcoxon Signed Rank Test), or equal to either quantile. And since $T=14$ for the test in Table 4.3 the null hypothesis is readily accepted. Hence the hypothesis that the simulated average travel times are equal to the real travel times cannot be rejected for OD-3 (the South-East traffic). For OD-1 (South-West traffic via Inner lane), OD-2 (South-West traffic) and OD-4 (South-North traffic via the Outer lane), results were less emphatic, because of lack of accurate travel time measurements in the field, but at the

5-percent significance level, the hypothesis could still not be rejected.

On the basis of these four tests, corresponding to the various origin-destination routes from an approach it is concluded that the model is validated satisfactorily, since the logic is the same for all approach legs to the circle.

Chapter V

Conclusions and Recommendations

5.1 Conclusions on Operational Study

The feasibility of developing a digital computer simulation model of a traffic circle for use as a flexible and reliable tool for determining traffic circle performance, has been demonstrated. Field validation of some test configurations indicates that faithful results can be expected from the use of the model.

The simulation model has the capacity of accommodating variations in the assigned values of all significant design and operational parameters of a traffic circle. This includes geometric parameters, such as number of lanes, approach distances, lengths of circle lane sections, number of circle arms, and traffic demands including vehicle-driver characteristics. With this model, rational and reliable operation decisions will be possible under controlled conditions, heretofore unobtainable when performing such studies at real traffic circle locations.

5.2 Conclusions on Study Methods

The results obtained from the use of the model on test configurations indicate that although the methods used for

the field studies are not all that sophisticated and perhaps unacceptable in terms of accuracy and precision, the iterative procedure of simulation refinement studies enabled reasonable results to be obtained. The methods used for the gap measurements and headway measurements cost almost nothing and can therefore be repeated over and over again as required in the simulation. However, to provide a permanent study record and to facilitate desired exactness of measurements, time-lapse photography should be used as the most appropriate means of recording gaps, lags and headways.

The flexibility of the gap/lag acceptance routine has been built into the model so that the gap acceptance logic can be changed to suit more faithful field studies that may be undertaken in future. The present logic in the system employs the simple idea of a vehicle accepting gap in the circle traffic stream after checking the occupancy of some predetermined vehicle spaces around the circle (see Appendix E). This crude approach of uniform gap acceptance procedure was chosen to avoid the prohibitive cost of gap and headway measurements in the field through the use of some more exacting procedures such as time-lapse photography.

When the probability of gap acceptance table has been constructed after analyzing field data from time-lapse photography, for instance, the table is employed in a gap analysis process by defining certain sections of the roadway which should be free of vehicles before a vehicle (which

happens to be evaluating gaps) would enter the circle roadway of the major street. This implies that the use of such procedures estimate the time gaps which are in turn translated into space gaps by drivers in the approach streams. Thus, by changing the gap acceptance logic in the model so that different drivers would define different safety zones, and hence, different numbers of vehicle spaces that must be free of vehicles before they would attempt circle entry, the use of the space gap acceptance procedure in the model would be more economical and easier to apply.

5.3 Recommendations for Further Study

The field validation study employed in the model is not that sophisticated, since most of the parameters were based on the good judgements of drivers, thus eliminating as many traffic hazards as possible. More field validation study should be pursued to confirm or more clearly establish the parameters that have been estimated in the model as a result of the crude field studies.

Further study should be undertaken whereby the rest of the statistics generated by the model, such as the waiting times in approach queues, the mean system delay, and so on, would be validated by means of rigorous field studies. When most of the statistics as generated by this model, have been validated, it would then be possible to faithfully evaluate the suitability of the choice of traffic signal or traffic

circle as a method of intersection control for some specific intersection configurations.

The model is built to accommodate a maximum of 6 arms (or arteries) on a traffic circle, but the validation study was confined to traffic circles with 4 arms (the commonest form of a circle in the City of Edmonton). It will be of further benefit to the traffic engineer to have the model validated for 5- or 6-arm traffic circles so as to be able to evaluate and compare the performance of a 5-way or 6-way intersection under a variety of intersection control methods.

The number of lanes is set at 2 for all sections of the system. It will be worthwhile to alter the program slightly so as to be able to accommodate multilane specifications on different parts of the system configuration.

Very often, the developers of individual intersection simulation models mention extensions of their models to network simulation on intersection to intersection basis. One wonders how the traffic circles (which may happen to form part of the network of intersection) are treated in such network simulations. Now, it is possible to combine a refined form of the traffic circle simulation model and the existing individual traffic signal simulation models to realistically simulate a network of intersections on intersection to intersection basis.

REFERENCES

1. Ashworth, R., "The Capacity of Priority-type Intersections with a Non-uniform Distribution of Critical Acceptance gaps", Transportation Research, Vol. 3, No. 2, January 1969, pp. 273-278.
2. Bapat, P., "Dead Areas on Roundabout", Traffic Engineering and Control, April 1969, Vol. 10, pp. 610-613.
3. Beckman, M., McGuire, C.B. and Winsten, C.B., Studies in the Economics of Transportation, Yale University Press, 1956.
4. Bell, Charles, W. and Linebarger, Robert, N., "Applications of Computer Modeling and Simulation to Science Education", Simulation, Vol. 14, No. 4, April 1970, pp. 185-190.
5. Blackmore, F.C., "Capacity of Single-level Intersections", Road Research Laboratory, Report LR 356, 1970.
6. Blum, A.M., "Digital Simulation of Urban Traffic", IBM System Journal, Vol. 3 No. 2, 1964, pp. 41-50.
7. Brennan, R.D. and Linebarger, R.N., "A Survey of Digital Simulation", Simulation, Vol. 3, No. 6, December 1964, pp. 22-36.
8. Buckley, D.J. and Wheeler, R.C., "Some Results for Fixed-time Traffic-Signals", Journal of the Royal Statistical Society B 26, 1964, pp. 133-140.
9. Conover, W.J., Practical Nonparametric Statistics, John Wiley and Sons, Inc., New York, 1971
10. Cress, Paul, Dirksen, Paul, and Graham, Wesley J., Fortran IV with Watfor and Watfiv, Prentice-Hall, Inc., Englewood Cliffs, New Jersey, 1970.
11. Darroch, J.N., "On the Traffic light queues", Annals of Math. Stats., 35, 1964, pp. 380-388.

12. Drew, D.R., Traffic Flow Theory and Control, McGraw-Hill Book Company, 1968.
13. Faulkner, C.R., "Experimental Carriageway markings at Urbridge Circus Roundabout", Traffic Engineering and Control, Vol. 10, May 1968, pp. 28-31.
14. Ferris, C.D., "An Urban Traffic Simulator", Unpublished M.Sc. Thesis, University of Alberta, 1969.
15. Gazis, Denos C., "Traffic Flow and Control Theory and Application", American Scientist, Vol. 60, 1972 July-August, pp. 414-424.
16. Gerlough, D.L., "Traffic Inputs for Simulation on a Digital Computer", Proceedings of Highway Research Board, Vol. 38, 1959, pp. 480-492.
17. Gerlough, D.L., "Simulation of Traffic Flow", Highway Research Board Special Report, No. 79, 1964.
18. Gerlough, D.L. and Wagner, F.A., "Improved Criteria for Traffic Signals at Individual Intersections--- Interim Report 3", National Cooperative Highway Research Program Report 3, 1964.
19. Gerlough, D.L. and Wagner, F.A., "Improved Criteria for Traffic Signals at Individual Intersections", National Cooperative Highway Research Program Report 32, 1967.
20. Goode, H.H., Pollmar, C.H. and Wright, J.B., "The Use of Digital Computer to Model a Signalized Intersection", Proceedings of the Highway Research Board, Vol. 35, 1956, pp. 548-557
21. Gordon, Geoffrey, System Simulation, Prentice-Hall, Inc., Englewood Cliffs, New Jersey.
22. Grant, E., "Traffic Capacity of Small Roundabouts", Traffic Engineering and Control, Vol. 10, April 1969, pp. 613-614.
23. Hartley, M.G. and Green, D.H., "Study of Intersection Problems by Simulation on a Special Purpose Computer", Traffic Engineering and Control, Vol. 7, July 1965, pp. 219-223.
24. Haight, F., "Overflow at a Traffic Light", Biometrika, 46, 1959, pp. 420-424.

25. Haight, F.A., Mathematical Theories of Traffic Flow, Academic Press, New York, 1963.
26. Highway Capacity Manual, Highway Research Board Special Report 87, 1965.
27. Katz, Jesse H., "Simulation of a Traffic Network", Communications of the A.C.M., Vol. 6, No. 8, August 1963, pp. 480-486.
28. Keeping, E.S., Introduction to Statistical Inference, D. Van Nostrand Company, Inc., Toronto, 1962
29. Kell, J.H., "Intersection Delay Obtained by Simulation Traffic on a Computer", Highway Research Record, No. 15, 1963, pp. 73-97.
30. Kell, J.H., "Analyzing Vehicular Delay at Intersections through Simulation", Highway Research Board Bulletin, Vol. 356, 1962, pp. 28-39.
31. Le Bourgeois, P., "Simulation Study of a Series of Synchronized Intersections", Second Conference on Application of Simulation, December 1968, pp. 212-217.
32. Lieberman, Edward, "Simulation of Traffic Flow at Signalized Intersections", 1970 Summer Computer Simulation Conference, Vol. 2, pp. 1134-1145.
33. Little, James G. Jr., "Queueing of Side-street Traffic at a Priority-type Vehicle-actuated Signal", Transportation Research, Vol. 5, 1971, pp. 295-300
34. Longley, D., "A Simulation Study of a Traffic Network Control Scheme", Transportation Research, Vol. 5, 1971, pp. 39-57.
35. Martin, F.P., Computer Modelling and Simulation, John Wiley and Sons, Inc., 1968.
36. McNeil, Donald R., "A Solution to the Fixed-cycle Traffic light Problem for Compound Poisson Arrivals", Journal of Applied Probability, 5, 1968, pp. 624-635.
37. Hillard, B.S., "Roundabouts and Signals", Traffic Engineering and Control, Vol. 13, May 1971, pp. 13-15.

38. Miller, S.B. and Little, J.D.C., "Evaluation and Improvement of Traffic Signal Settings by Simulation", Highway Research Board, Record No. 170, 1967.
39. Morgan, J.T. and Little, J.D.C., "Synchronizing Traffic Signals for Maximal Bandwidth", Operations Research, Vol. 12, 1964, pp. 896-912.
40. Naylor, Thomas H., Wertz, Kenneth, and Wonnacot, Thomas H., "Methods for Analyzing Data from Computer Simulation Experiments", Communications of the A.C.M., Vol. 10, No. 11, November 1967, pp. 703-710.
41. Naylor, Thomas H., Balintfy, Joseph L., Burdick, Donald S. and Kong Chu, Computer Simulation Techniques, John Wiley and Sons, Inc., New York, 1966.
42. Newell, G.F., "Queues for a Fixed Cycle Traffic Light", Annals of Mathematical Statistics, Vol. 31, 1960, pp. 589-597.
43. Ogland, P., "Improving Traffic Capacity at an Oslo Roundabout", Traffic Engineering and Control, Vol. 4, November 1962, pp. 386-390.
44. Powner, E.T., Hartley, M.G., Heath, F.G. and Green, D.H., "Road Traffic Simulation Employing a Hardware Approach Philosophy and Design Considerations", Simulation, Vol. 15, September 1970, pp. 113-116.
45. Reitman, Julian, Computer Simulation Applications, John Wiley and Sons, Inc., New York, 1971
46. Sakai, T. and Nagao, H., "Simulation of Traffic Flow in a Network", Communications of the A.C.M., Vol. 12, No. 6, June 1969, pp. 311-318.
47. Stark, M.C., "Computer Simulation of 9 Blocks of a City Street", Highway Research Board Bulletin, Vol. 356, 1962, pp. 40-47.
48. Story, C.E.R., "Simulation of Traffic by Digital Computer", Traffic Engineering and Control, Vol. 11, February 1970, pp. 464-467.

49. Tiechroew, D. and Lubin, J.F., "Discussion of Computer Simulation Techniques and Comparison of Languages", Simulation, Vol. 9, No. 4, October 1967, pp. 181-191.
50. Van Hoffen, P., "Measurement of Directional Flows at Roundabouts", Traffic Engineering and Control, Vol. 6, March 1965, pp. 674-675.
51. Watjen, W.D., "Computer Simulation of Traffic Behaviour Through Three Signals", Traffic Engineering and Control, Vol. 6, February 1965, pp. 623-626.
52. Webster, F.V. and Blackmore, F.C., "Improving Road Capacity", Science Journal, Vol. 4, No. 8, August 1968.

APPENDIX A

PROBABILISTIC FUNCTIONS IN THE MODEL

A.1 Uniform Distribution

If integers are picked at random from the range A to B inclusive, the probability of any particular one being picked is given by the density function

$$f(y) = 1/B-A \text{ where } A \leq y \leq B \quad (1)$$

The cumulative probability F is obtained by integrating the density function over the range of y

$$\begin{aligned} F(y) &= \int_0^y f(y) dy \\ &= \int_A^y 1/B-A = y-A/B-A \end{aligned} \quad (2)$$

and solving for y to obtain the relationship

$$y = A + (B-A)F \quad (3)$$

From (2) we see that F varies between 0 and 1 since y varies from A to B; so that for y in expression (3), we can substitute RN (random number from the range 0 to 1) and thus make y a random variable which is a function of RN:

$$y = A + (B-A)RN \quad (4)$$

Denoting y by FN, we get the equation

$$FN = A + (B-A)RN \quad (5)$$

Equation (5) converts values of RN to uniformly distributed values which lie in the range A to B as shown in Figure A.1.

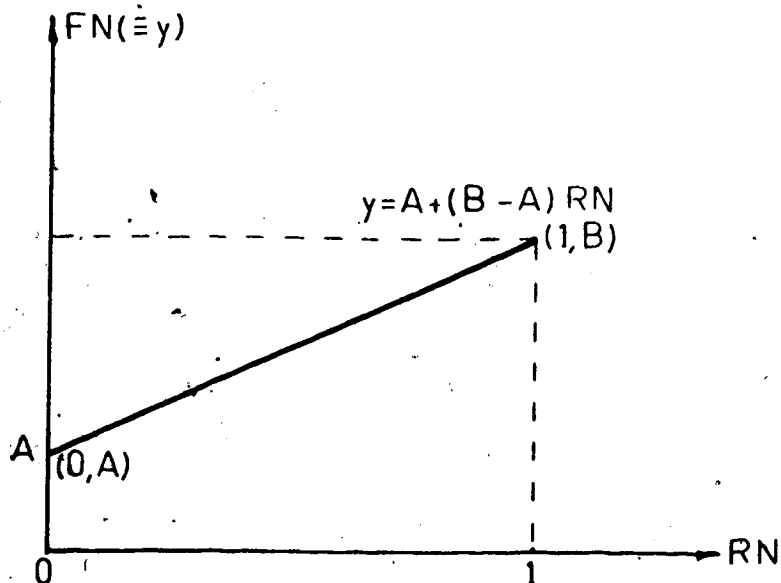
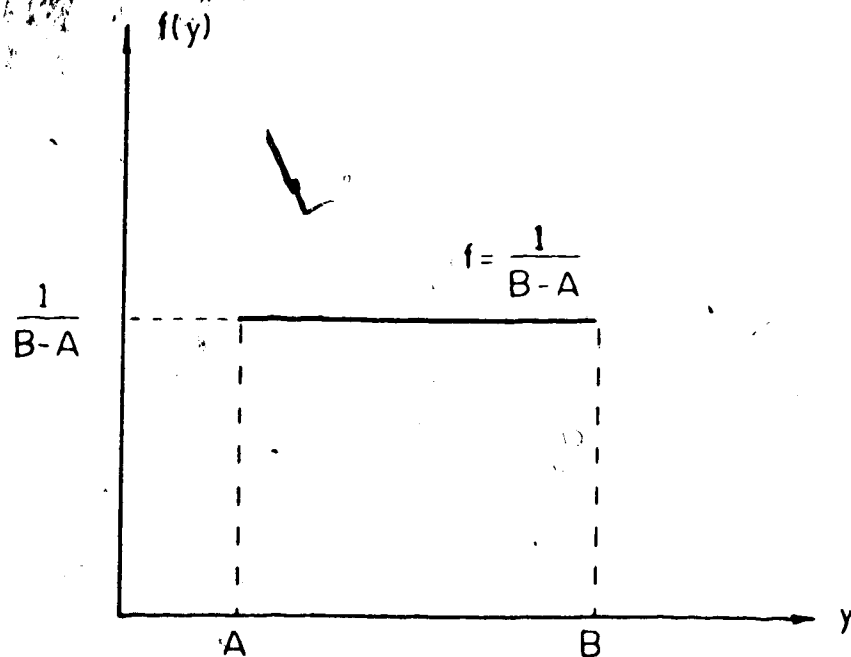

Figure A.1.
Uniform probability distribution.

A.2 Exponential Distribution

The exponential probability density function is given by

$$f(y) = \lambda \exp(-\lambda y). \quad (1)$$

The cumulative probability is obtained by integrating (1) to give

$$\begin{aligned} F(y) &= \int_0^y \exp(-\lambda y) dy \\ &= 1 - \exp(-\lambda y). \end{aligned} \quad (2)$$

Since y ranges from 0 to ∞ , F varies from 0 to 1, so that if we denote a random number obtained from a $U(0,1)$ as R_N , then we can substitute R_N for F and solve equation (2) to obtain

$$y = \frac{1}{\lambda} \ln(1 - R_N) \quad (3)$$

The exponential distribution whose probability density function is that given by equation (1) has a mean of $\frac{1}{\lambda}$. If we denote this mean by m , and if we rename y as FN , equation (3) becomes

$$FN = -m \times \ln(1 - R_N) \quad (4)$$

This is the cumulative exponential distribution function. Both the original density function and the cumulative distribution function are plotted in Figures A.2 and A.3. From equation (4), it is clear that the value of FN can be obtained by finding the value of $\ln(1 - R_N)$ and multiplying by the mean m .

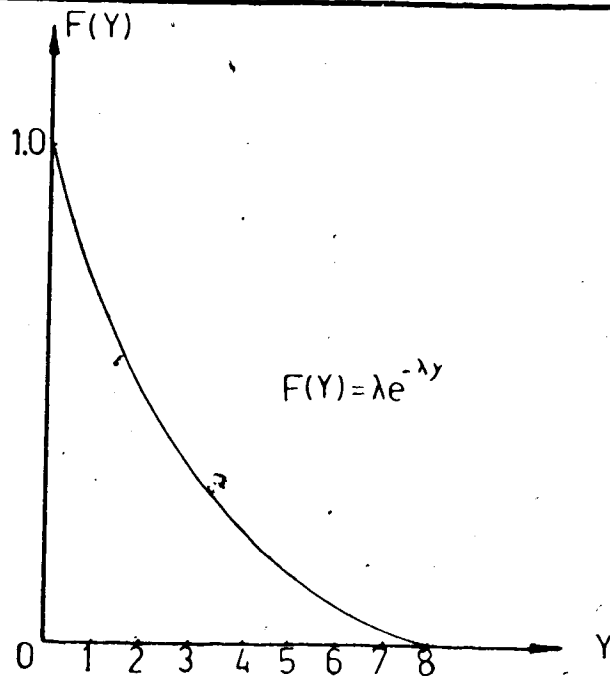

Figure A.2 Exponential density function.

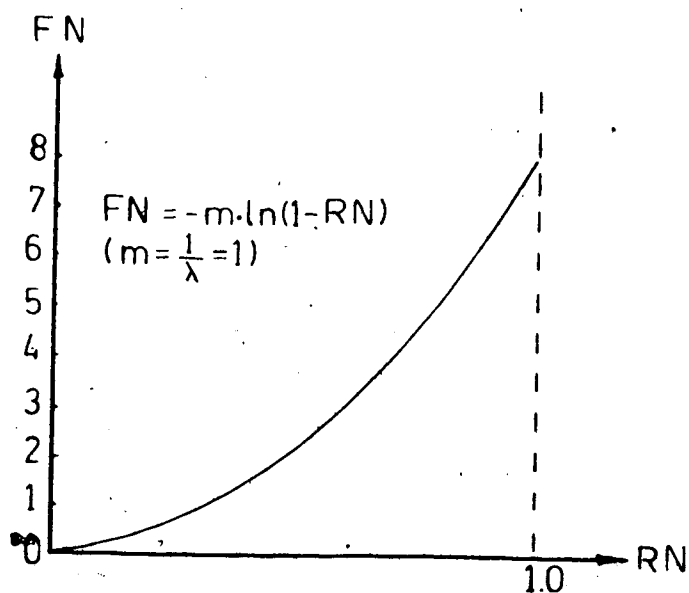

Figure A.3 Cumulative exponential distribution.

To use the exponential distribution to generate vehicle arrivals in a traffic model system, the INTERARRIVAL time of vehicles must be known. The interarrival time is the 'Inverse' of the frequency of vehicle arrivals.

For example, if 20 vehicles enter the system via a particular approach in a minute, then the frequency of vehicle arrival is 20 vehicles per minute and the interarrival time is $1/20$ minute per vehicle or 3 seconds per vehicle. In other words, one vehicle will arrive at this particular approach every 3 seconds.

Without the specification of the exponential distribution, vehicles will enter the system at regular intervals of 3 seconds.

The vehicles are made to enter the system according to a Poisson distribution by generating a number from the exponential distribution, EXRN, and multiplying by 3; in this way vehicle arrivals become random, and exponentially distributed.

While describing the relationship between interarrival time and frequency, it should be pointed out that if a collection of interarrival times are exponentially distributed, the corresponding frequencies belong to a Poisson distribution. Hence the words 'Exponential' and 'Poisson' are often (but not always correctly) used interchangeably.

A.3 Normal Distribution

A Normal distribution is completely specified if its mean and standard deviation are given.

The density function of a Normal distribution is denoted as:

$$p(V) = \frac{1}{\sqrt{2\pi}\sigma} \exp\left[-\frac{(V - \mu)^2}{2\sigma^2}\right] \quad (1)$$

where

V is a random variable

σ is the standard deviation and

μ is the mean.

A standard normal distribution is defined as one with a mean of zero and standard deviation of 1. Its density function is obtained by substituting the values of 0 and 1 for μ and σ respectively, in equation (1) to obtain:

$$p(F) = \frac{1}{\sqrt{2\pi}} \exp(-F^2/2). \quad (2)$$

Both the Normal probability curve and the standard form are shown in Figures A.4 and A.5.

A normally distributed variable V can be translated into a value F by using the definition of the standard normal deviate:

$$F = \frac{V - \mu}{\sigma} \quad (3)$$

$$\implies V = \sigma F + \mu. \quad (4)$$

If we can somehow obtain a value of F (belonging to the standard normal distribution) we can then use equation (4) to convert it to a value of V (belonging to the normal distribution defined by μ and σ).

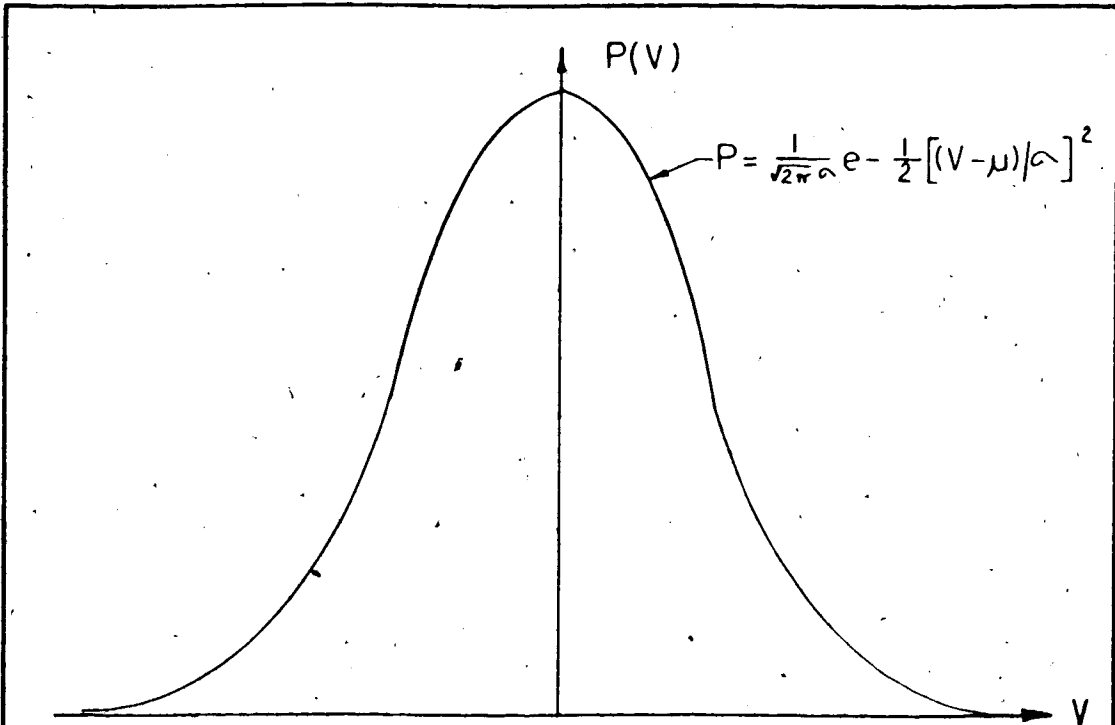

Figure A 4
Normal probability curve.

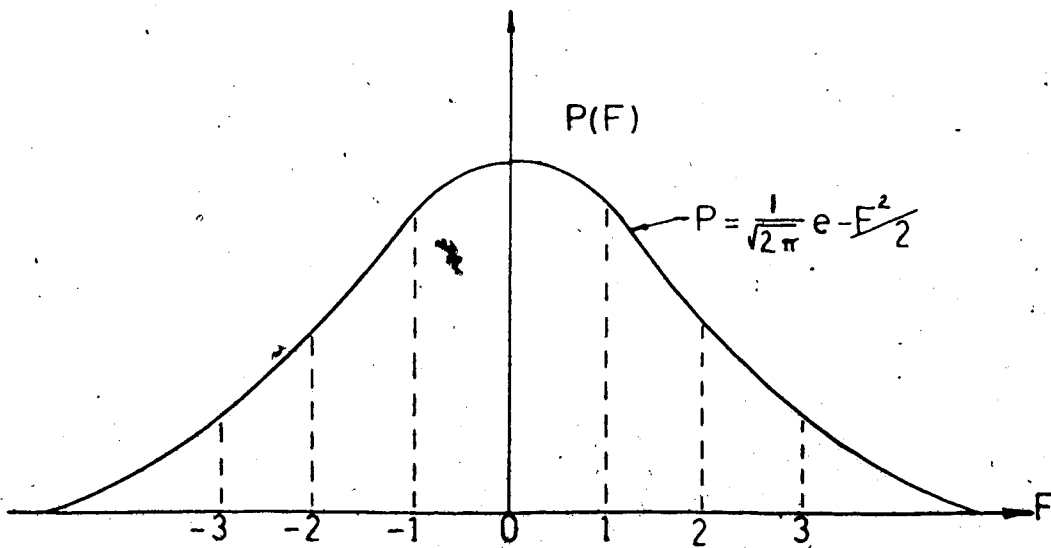

Figure A 5.
Standard normal probability curve.

The cumulative standard normal curve is shown in two different forms in figures A.6 and A.7. The cumulative curve as shown in figure A.6 is a conversion from the standard normal curve which yielded a monotone increasing function. From the curve it is seen that the probabilities associated with areas under the curve are cumulative so that there is a cumulative probability associated with every value of F , and that probability is equal to the area to the left of the ordinate corresponding to F .

By reversing the dependency of the variables and using RN instead of P , we get the curve as shown in figure A.7. The F will assume values ranging from approximately -4 to $+4$ as RN varies from 0 to 1.

The use of the Normal distribution in discrete simulation systems can be described as follows: the user wants to obtain random values V from a distribution with mean μ and standard deviation σ . To do this, he defines a cumulative standard normal distribution from which random values F are obtained. These values of F are translated into values of V by means of a simple equation as shown in (4).

In traffic flow simulation studies, vehicle desired or target free flow velocity is usually determined by means of a normal distribution.

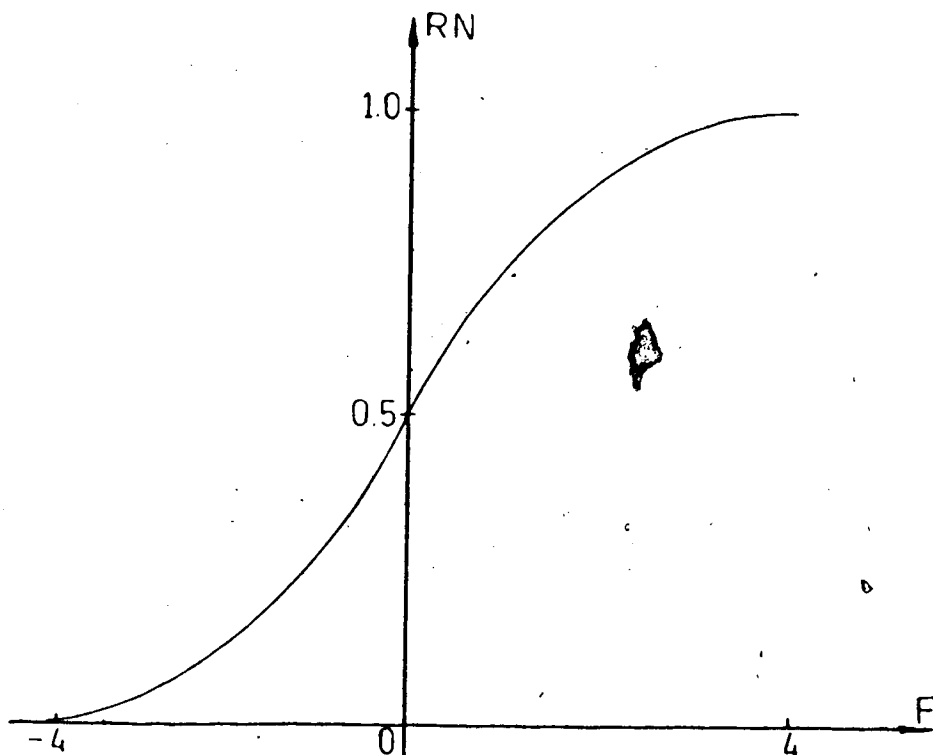

Figure A. 6 Cumulative Std. normal curve.

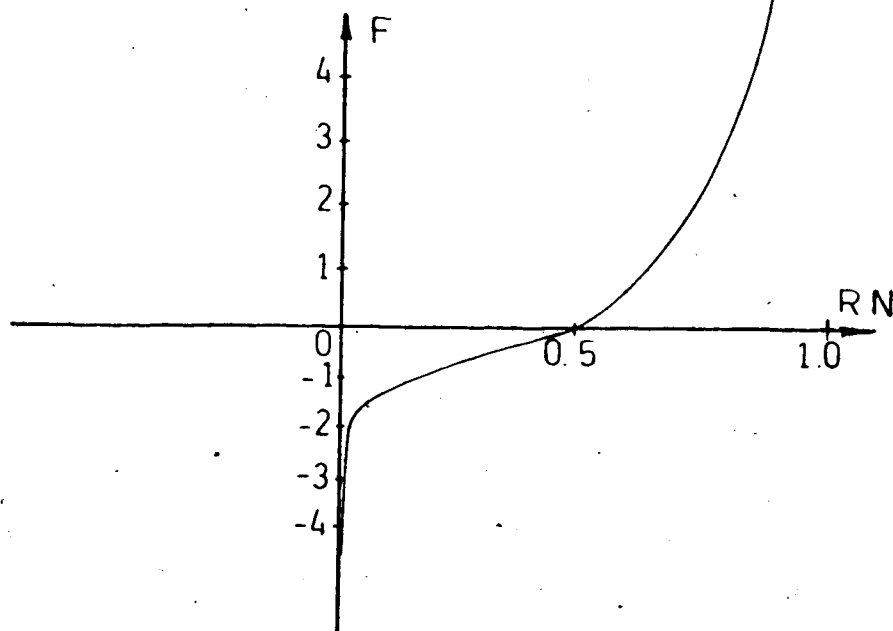

Figure A. 7 Cumulative normal distribution.

The mean for the velocities in a particular approach direction of flow is specified, and the individual desired velocities are generated normally about this mean. Usually the speed about this specified mean is limited within a specific range, so that some form of transformation has to be carried out if the generated random deviate falls outside the specified range.

For example, if an arterial mean velocity is denoted by M , and target free flow velocities are generated normally about this mean velocity in the range of 0.75 to 1.25, then we have the inequality:

$$0.75M \leq TVEL \leq 1.25M.$$

In the inequality expression above TVEL is the computed free flow or target velocity for a generated or newly arrived vehicle at the specified generating point; so that for a mean arterial velocity of 24 miles per hour, the individual target free flow velocities will be selected from the range of 18 to 30 miles per hour.

To obtain normally distributed velocities in the above range we require random values V from a distribution of mean 1.0 and standard deviation $1/20$. To do this, a standard normal distribution is defined with mean 0 and standard deviation 1 in the range -5 to $+5$. Then by the use of $U(0,1)$ random numbers values of F (which are normally distributed with $\mu = 0$ and $\sigma = 1$) are obtained and translate them into values of V belonging to the 'nonstandard' normal

distribution.

$$V = \sigma P + \mu = 1/20P + 1.0 \quad (5)$$

and $TVEL = V \times M$.

By means of a table lockup procedure values of P are obtained in the range -5 to +5 and use equation (5) to obtain values of V in the range 0.75 to 1.25 and multiply by M (the arterial mean arrival velocity) to obtain the individual target free flow velocities.

APPENDIX B

COMPONENTS OF THE MODEL

B.1 Vehicle-Index Arrays

The physical system of the model is made up of three distinct sections namely: the approach, the circle and the exit sections. These sections are represented in the computer as follows.

The approach and the circle sections are each made up of a two-dimensional array, the first of which is an index for the identification of a particular vehicle and the second dimension is an identification of the particular lane being occupied on the roadway. The exit section is made up of a one-dimensional array which stores the vehicle indices before the vehicles exit from the system. The arrays themselves contain the storage addresses of the characteristics describing the vehicles occupying the two-dimensional roadway.

As vehicles are introduced into the system, they are numbered sequentially and stored in the system in the approach array. During the simulation process, the movement of any particular vehicle is represented by updating the

position and velocity of the vehicle within the same column of the matrix, or by shifting its index within the same matrix (when lane changing takes place within the same section of the system) or by shifting its index from one matrix to another (as the vehicle leaves the approach and enters the circle or from the circle to the exit lanes) and the general register is updated accordingly.

B.1.1 Approach Array

The approach array 'APPRCH(I,J)' is dimensioned to accommodate a maximum of 50 queued vehicles, so that an intolerable situation will occur in the system only when there are more than 50 queued vehicles in an approach lane at one instant during the simulation run.

Vehicle processing in the approach lanes is done in a circular manner, so that the arrays are capable of accepting infinite number of vehicles so long as there are no more than 50 vehicles in a lane at a particular scan interval. This circular array processing concept is described in detail in section B.2.

At any time, an element of the approach array either contains a zero or a vehicle index a_{ij}

*APPRCH(I,J) = 0 if no vehicle occupies that section of the approach lane
 or = a_{ij} if a vehicle occupies that section of the approach lane.

The vehicle whose index is a_i occupies the i -th position of the approach lane j , but it is not necessarily the i -th vehicle in approach lane j . The i -th vehicle in approach lane j is the vehicle which occupies the $(NFSTA(J) + i)$ -th position of approach lane j as explained in section B.2.

B.1.2 Circle Array

The circle array $CIRCLE(I, J)$ is dimensioned to accommodate a maximum of 10 vehicles per lane of a circle lane section. Unlike the approach lanes, where vehicles are always free to enter the lanes, vehicles from the approach lanes can enter the circle only when there is enough space in the appropriate circle lane (determined from some simple deterministic rules) so that locking up of the circle never occurs.

Like the approach array, processing of vehicles in the array is done by reference to pointers which point to the first and last vehicles in the particular lane of the circle array.

The odd-numbered lanes form a continuous inner circle lane and the even-numbered lanes form a continuous outer circle lane.

Thus, a vehicle in the inner circle lane travels from one inner circle lane section to the other until it comes to the point of exiting from the circle.

B.1.3 Exit Array

The exit lanes are represented by a one-dimensional array $EXIT(J)$. This is because exit flows in the system are recognized only as one vehicle space, and that a vehicle is removed from the system after travelling one vehicle space along the exit lane.

Vehicles from inner circle lanes exit from the system via the inner exit lanes, and vehicles from the outer circle lanes exit from the system via the outer exit lanes.

The system is organized in such a way that vehicles in the circle lane J always exit from the system via exit lane J ; so that at any moment in the simulation, the element e_j of the exit vector contains either a zero or the index of the vehicle occupying the exit lane J .

B.2 Vehicle Lists

In accordance with the circular list processing concept in the model of Gerlough and Wagner [19], vehicle lists are maintained in this model in the approach and circle sections of the system. Unlike the orthogonal intersection of Gerlough's model where an approach lane could form a continuous list with an exit lane, in this model, approach lists are maintained separately from circle lists.

Lists are not maintained on the exit lanes, since vehicles are deemed to have left the system as soon as they

cross one vehicle length (vehicle space) along the exit lane. Approach lists start from the system entry boundary and end at the circle entry line. Each approach lane in the system forms a separate list, so there are as many approach lists as there are approach lanes. Similarly, circle lists are maintained in each lane section of the circle depending on the number of lanes around the circle; so there are as many circle lists as there are circle lane sections.

B.2.1 Approach lists

Vehicle lists on the approach are ordered so that vehicle sequence on a list is identical to vehicle sequence on the roadway. The first vehicle on a list has the highest position value (that is, farthest from the zero or reference point), and the last on the list has the lowest position value (closest to the zero or reference point).

When a vehicle is generated at an approach boundary (hereinafter called 'System Boundary'), some vehicle parameters are attached to it, among these parameters is the position parameter. When the vehicle is generated it is placed at the bottom of the list by giving the value of zero to the position parameter; and the movement of the vehicle on the approach is done by incrementing the value of the position parameter until it has travelled the full approach distance.

Thus, when a vehicle is generated and placed on the

approach array, its position is not physically shifted around until it is ready to merge with the circle traffic stream. As a vehicle merges with the circle traffic stream it is struck off the top of the approach list, and placed at the bottom of the appropriate circle list depending upon the originating approach lane which was occupied by the merging vehicle.

Control over vehicle processing on a given approach lane is maintained by reference to the following index arrays:

NFSTA(I) = Index of the first vehicle
on approach list I;

NLSTA(I) = Index of last vehicle
on approach list I;

NA(I) = Number of vehicles
on approach lane I.

The indices of the first and last vehicles on the approach lists are kept in separate arrays as indicated above, so that during updating, scanning of the list could be limited only to indices within the range of NFSTA(I) to NLSTA(I). Initially, before any vehicle has been generated into the system the index arrays are initialized as follows:

NFSTA(I) <----- 1;

NLSTA(I) <----- 0;

NA(I) <----- 0.

As the first vehicle enters approach lane I, it is

identified as the first on the approach by giving it a number equal to 1 on the list; and by storing the index of its position on the approach list in the vector NFSTA(I) to give the following status of the arrays:

$$NLSTA(I) \leftarrow NLSTA(I) + 1 = 1;$$

$$NA(I) \leftarrow NA(I) + 1 = 1.$$

After the tenth vehicle has entered the approach lane I, the indices of the approach list attain the status;

$$NFSTA(I) = 1;$$

$$NLSTA(I) = 10;$$

$$NA(I) = 10.$$

We see that until the first vehicle on the approach lane I is able to merge with the circle traffic stream, the value of the index NFSTA(I) stays at 1, irrespective of how many vehicles have entered the system via that approach lane.

However, that of NLSTA(I) keeps increasing as more and more vehicles enter the system via approach lane I. As the first vehicle is able to merge with the circle traffic stream we get the following situation of the vehicle index array for approach lane I:

$$NFSTA(I) \leftarrow NFSTA(I) + 1 = 2;$$

$$NLSTA(I) \leftarrow 10 = 10;$$

$$NA(I) \leftarrow NA(I) - 1 = 9.$$

The second vehicle on approach lane I becomes the first on the approach as the first vehicle on the list leaves; and the number of vehicles on the list is decreased from 10 to

9; however the tenth vehicle on the list still remains as the last on the list until another vehicle arrives on that approach lane.

In summary, as more vehicles enter approach lane I, the value of the index NLSTA(I) is always incremented in order to point to the most recent vehicle on the approach and the number of vehicles on the approach list is incremented accordingly:

$$NLSTA(I) \leftarrow NLSTA(I) + 1;$$

$$NA(I) \leftarrow NA(I) + 1.$$

Overflow of vehicles occurs on approach list I when either of the following conditions occurs:

$$NLSTA(I) > JAPP \text{ and } NFSTA(I) = 1$$

OR

$$NLSTA(I) = NFSTA(I) \text{ and } NA(I) = JAPP$$

where

JAPP is the maximum number of vehicles that can be accommodated on an approach lane conveniently.

However, if $NLSTA(I) > JAPP$ and $NFSTA(I) \neq 1$

then $NLSTA(I) \leftarrow 1$.

Similarly, as more vehicles leave the approach lane I, the index vectors are updated as follows:

$$NFSTA(I) \leftarrow NFSTA(I) + 1;$$

$$NA(I) \leftarrow NA(I) - 1.$$

When $NFSTA(I) > JAPP$, $NFSTA(I)$ is automatically reset to 1 whether or not there are any more vehicles on the approach lane. The number of vehicles on the approach list I, at any

instant, is given by the value of $NA(I)$ which is updated continuously during the simulation. However the value of $NA(I)$ could be computed at any time from the formulas:

$$NA(I) = NLSTA(I) - NFSTA(I) + 1 \text{ if } NLSTA(I) \geq NFSTA(I);$$

$$NA(I) = (JAPP + NLSTA(I)) - NFSTA(I) + 1$$

$$\text{if } NLSTA(I) < NFSTA(I).$$

The pointers $NLSTA$ and $NFSTA$ are reset to their initial values whenever there is no vehicle on the appropriate approach list.

That is, if $NA(I) \leq 0$ then $NFSTA(I) \leftarrow 1$
and $NLSTA(I) \leftarrow 0$.

Thus, the pointers $NFSTA(I)$ are moved (incremented or reset to 1) when a vehicle leaves an approach lane and merges with the circle traffic stream; and the pointers $NLSTA(I)$ are moved (incremented or reset to 0 or 1) as more vehicles join the approach lane I .

B.2.2 Circle Lists

Vehicle lists on the circle lanes are treated much the same way as vehicle lists on the approach lanes. Index arrays $NLSTC(I)$, $NFSTC(I)$ and $NC(I)$ are maintained to monitor the movements of vehicles around the circle in the same way as vehicle movements on the approach lanes are monitored by references to the index arrays $NLSTA(I)$, $NFSTA(I)$ and $NA(I)$ as described in section B.2.1.

But there is more shifting of vehicle indices around

the circle than at the approach lanes. Unlike the approach flows where vehicle physical position on the approach array stays the same until it merges with the circle; vehicle index on the circle is shifted from one vehicle list to another as the vehicle completes its journey in one lane section and travels to the next lane section, until it finally joins the exit lanes.

B.3 Vehicle-Characteristic Array

The characteristics of all vehicles in the system are stored in each row of a vehicle characteristic array, $AUTO(I,J)$, so that pertinent information about a vehicle is obtained by reference to this array. When a new vehicle is generated at an approach boundary (also called the System Boundary), its characteristics are stored in a row of the characteristic array and the row number of this array is stored in the appropriate approach lane. During simulation, it is this row number (rather than the vehicle sequence number) which is shifted around in the system to represent movement of the vehicle.

Whenever an updating routine is to be performed on a particular vehicle, its sequence number on the vehicle characteristic array is extracted from one of the vehicle index arrays; and the updating process is carried out by modifying the appropriate elements of the row of the Auto array corresponding to that number. In the beginning of the

simulation, all rows of the vehicle characteristic array are linked together, and an index of the first row is stored in the link pointer, LINK. When the first vehicle arrives in the system its characteristics are stored in the first row of the vehicle characteristic array. Thereafter, characteristics of subsequent vehicles are stored sequentially in the rows of the array until some of the previously occupied rows are vacated by exiting vehicles.

When a new vehicle arrives in the system and a previously occupied row of the vehicle characteristic array is vacated, then the link pointer would be pointing to the most recently vacated row, which will then be assigned to the newly arrived vehicle. Thus, arriving vehicles are always assigned to a fresh space in the vehicle characteristic array only when there are no vacated spaces. This form of 'Garbage Collection' procedure in using the vehicle characteristic array insures an optimum use of the array; and in this way, saturation of the system (when there are at least 1000 vehicles in the system) will occur only when the link pointer points to the last row of the vehicle characteristic array.

Typical parameters stored in the vehicle characteristic array for each vehicle which enters the system are shown in figure E.1.

The numbers in Figure B.1 indicate the columns of a typical

I	1	2	3	4	5	6	7	8	9	10	11

Figure B.1 Vehicle Parameter List

row of the AUTO array.

1 = vehicle sequence number, referred to as vehicle identification number;.

2 = entry lane of the vehicle, which of necessity must refer to an approach lane;

3 = exit artery of the vehicle;

4 = time of entry into the system;

5 = the total distance to be travelled around the circle;

6 = the speed of the vehicle at any time during the simulation;

7 = position of the vehicle in the system at any time during the simulation;

8 = vehicle desired velocity;

9 = time of joining a queue at the approach;

10 = time of entry into the circle;

11 = time of exit from the system.

APPENDIX C

PROGRAM LOGIC AND INPUT ORGANIZATION

C.1 PROGRAM LOGIC

The logic of the program is explained in detail in this section with accompanying flow charts.

The order of the logic segments in this section does not necessarily duplicate the order of processing in the model as explained in Chapter III. The following abbreviations have been made use of in the accompanying flow charts.

- Q-IN = Inner approach lane queue;
- Q-OUT = Outer approach lane queue;
- C-IN-R = Inner circle lane section to the right of a potential merger;
- C-OUT-R = Outer circle lane section to the right of a potential merger;
- C-IN-L = Inner circle lane section to the left of a potential merger;
- C-OUT-L = Outer circle lane section to the left of a potential merger;

IN-ZONE = Conflict zone of a potential merger ready to merge from Q-IN;

OUT-ZONE = Conflict zone of a potential merger ready to merge from Q-OUT;

RD = Random fraction generated from $U(0, 1)$;

APF = Arrival frequency at an approach direction;

Potential Merger = Leader of approach queue (or lane), ready to accept lag/gap to enter circle.

Some of the abbreviations above are illustrated in Figure C.1

C.1.1 Vehicle Generation

The amount of origin-destination is controlled by the user who sets the allowable origin-destination distribution at an input boundary. The flow rate, indexed by boundary is also provided by the user.

If the volume of arriving vehicles is denoted by VOL vehicles per hour, then in an interval of time equal to the scan interval, the average frequency of arrival, denoted by AFRQ is given by:

$$AFRQ = VOL \times SCAN/3600$$

where

SCAN stands for the unit of scan interval; so that for a scan interval of 1 second, the average frequency of arrival is given by:

$$AFRQ = VOL \times 1/3600.$$

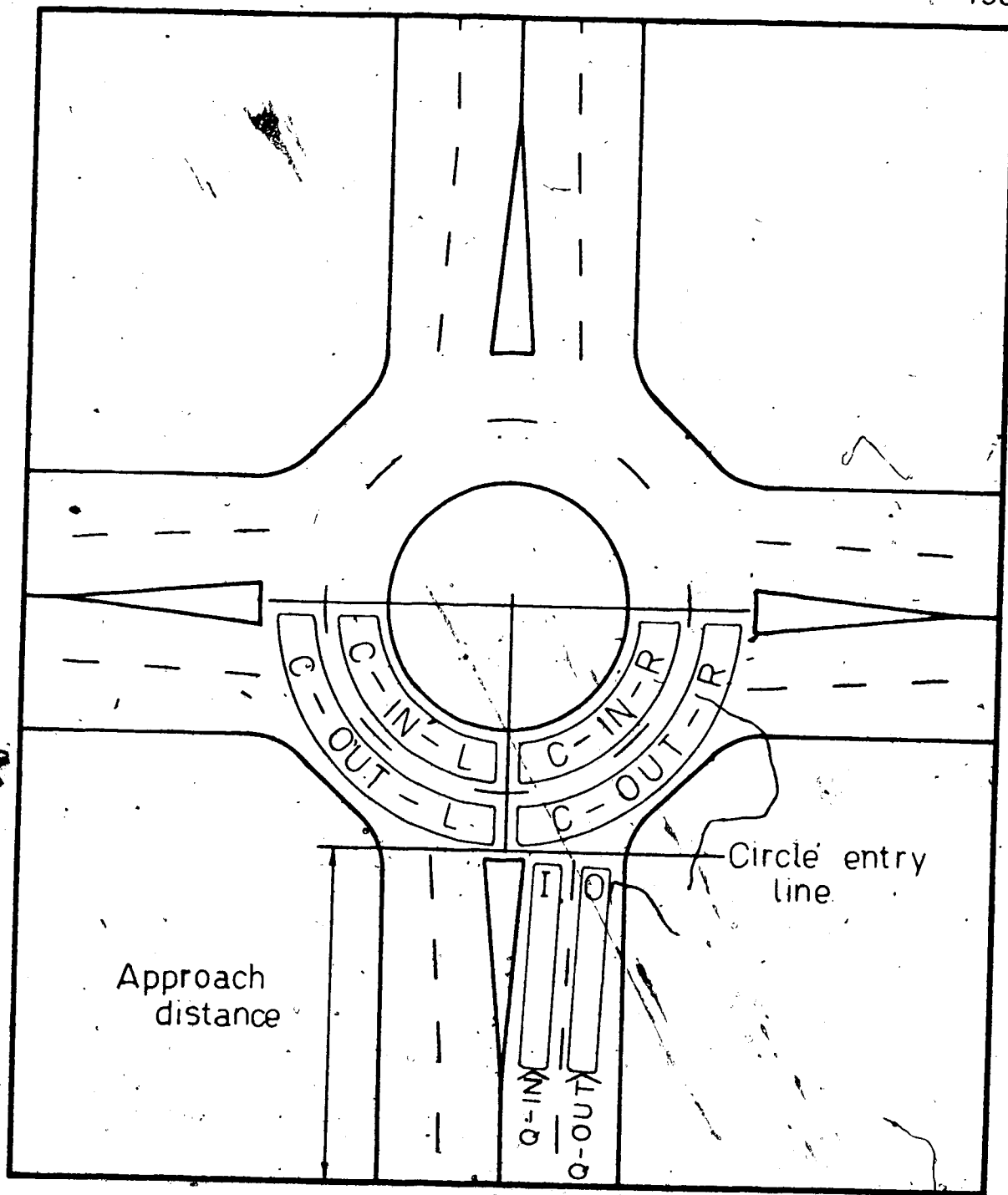

Figure C.1
Scheme for gap analysis.

A random fraction with rectangular distribution about a mean of 0.5 (that is, $U(0,1)$ random number) is generated for each scan interval and if the random fraction RF is less than or equal to the average arrival frequency $AFRQ$, then a vehicle is assumed to have arrived at the particular vehicle generating point during that scan interval.

However, if $RF > AFRQ$ then no vehicle is assumed to have arrived.

Vehicle arrivals then follow a Binomial distribution with a constant probability which is an approximation to a Poisson distribution.

C.1.2. Assignment of Direction

If a vehicle arrives in the scan interval, then it is assigned a direction by the Monte Carlo technique. A random fraction, RF , is generated and compared with the estimated probability of a vehicle turning right, turning left or going straight through the intersection.

The probability of a right turn (RT) is taken as being equal to the percentage of right-turning vehicles over a period of time, and if $RF \leq RT$ the vehicle is assigned a right-turn destination.

Similarly, the probability of a left-turn (LT) is taken to be equal to the percentage of left-turning vehicles over a period of time, and if $RF \leq LT$ the vehicle is assigned a left-turn destination.

Finally, the probability of a straight-through (ST) is taken to be equal to the percentage of straight through vehicles over a period of time, and if $RF \leq ST$ the vehicle is assigned a straight through destination.

The probabilities RT, LT and ST are cumulative in the sense that if $RT = a_1$, $LT = a_2$ then ST is automatically equal to $1 - a_1 - a_2$ so that

if $RF \leq a_1$ the vehicle is assigned a RT destination

if $a_1 < RF \leq a_1 + a_2$ vehicle is assigned a LT destination

if $a_1 + a_2 < RF \leq 1$ the vehicle is assigned a ST destination.

C.1.3 Assignment of Lane

For a 2-lane approach in a 4-arm traffic circle, if the inner approach lane as is denoted as 'lane 1' and the outer approach lane as 'lane 2', then all right-turning vehicles are assigned to the right-turn queue (lane 2) and all left-turning vehicles are assigned to the left-turn queue (lane 1).

Of the straight through vehicles, assignment to lane 1 or lane 2 is accomplished in one of two methods as explained below:

1. The lengths of the two queues of the approach lanes are compared and the straight through vehicle is

assigned to the shorter queue.

2. If neither of the queues appears shorter than the other, then the assignment of the vehicle to lane 1 or lane 2 is predicted with the Monte Carlo technique as follows:

A random fraction, RF, is generated and compared with the probability based on observed lane usage of straight through vehicles from the approach direction, and the vehicle is assigned to the correct lane in that random fashion.

Presently, it is assumed that vehicle usage of inner approach lanes by straight through vehicles from all approach directions of the traffic circle is 0.70 (p) and of the outer approach lane is 0.30 ($1-p$). Of course, since p is read into the program as an input variable, the probability of lane usage by straight through vehicles from the various approach directions can be set to any desired value based on the data at hand. See Figure C.2 for the flow logics of sections C.1.1, C.1.2, and C.1.3.

C.1.4 Circle Approach Flow

The logic for processing vehicles which are travelling from the system boundary to the circle is the same for both inner and outer approach lanes. The difference comes only in the logic for gap acceptance at the circle.

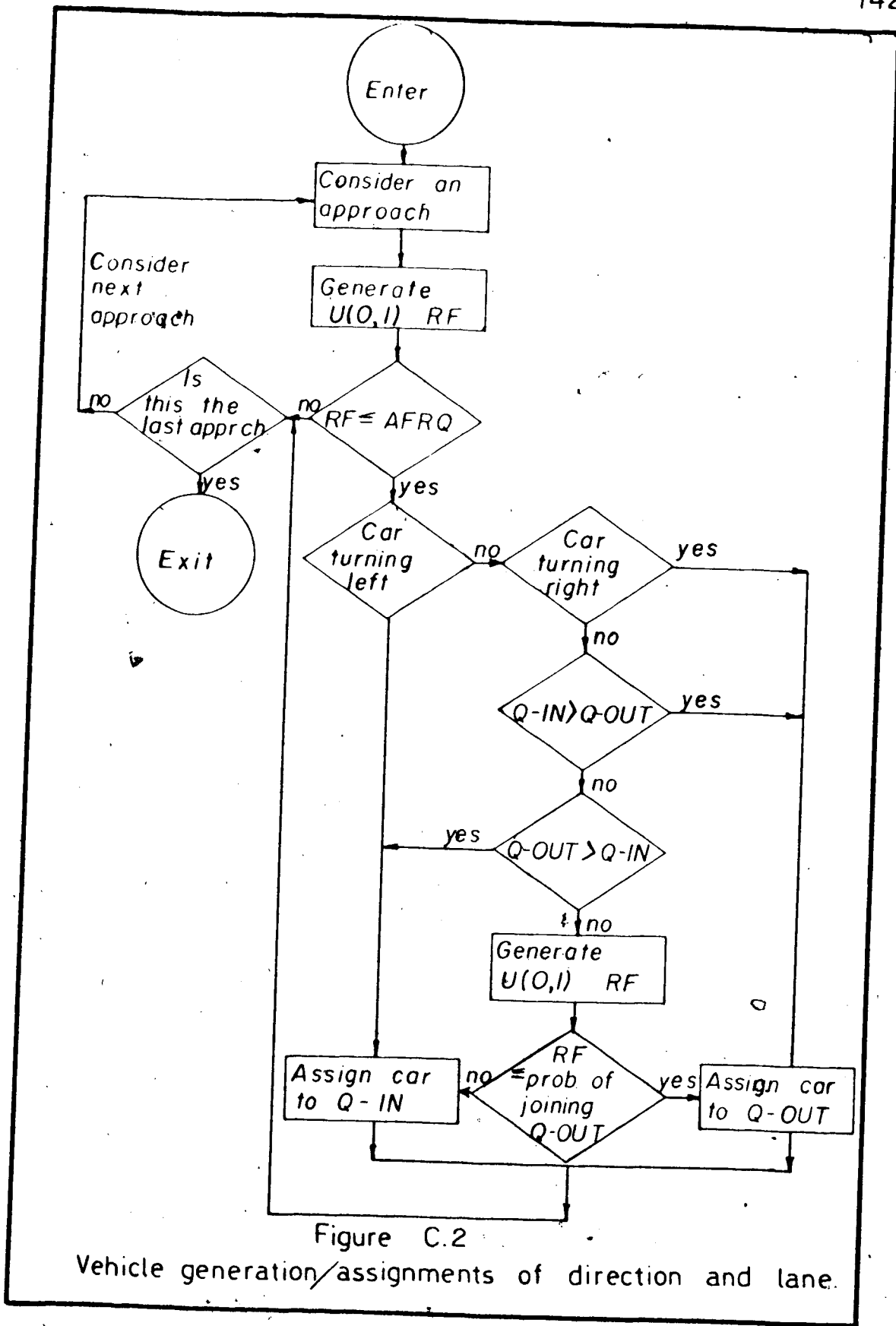

Figure C.2

Vehicle generation/assignments of direction and lane.

Essentially the logic for processing vehicles on the approach lanes (illustrated in Figure C.3) as follows:

The leader of the approach lane is first considered. If the leader is within some specified distance (presently taken to be 15 feet) from the circle, then the gap acceptance logic is called to determine the probability of the vehicle accepting the available gap in the circle traffic stream. If it accepts the gap to enter the circle, it is processed out of the approach lane into the appropriate circle lane, and the necessary statistics are gathered to update the status of the originating approach lane and destination circle lane.

However, if the leader rejects the available gap or if there is no gap in circle stream, then the vehicle is decelerated to a stop at the circle entry line within the next scan interval. If the leader is further away than the specified distance (here, 15 feet) from the circle, then it is accelerated or decelerated depending on how far it is from the circle and its current speed. But the leader is not allowed into the circle during the current scan interval if it is further away from the circle than the distance as specified above.

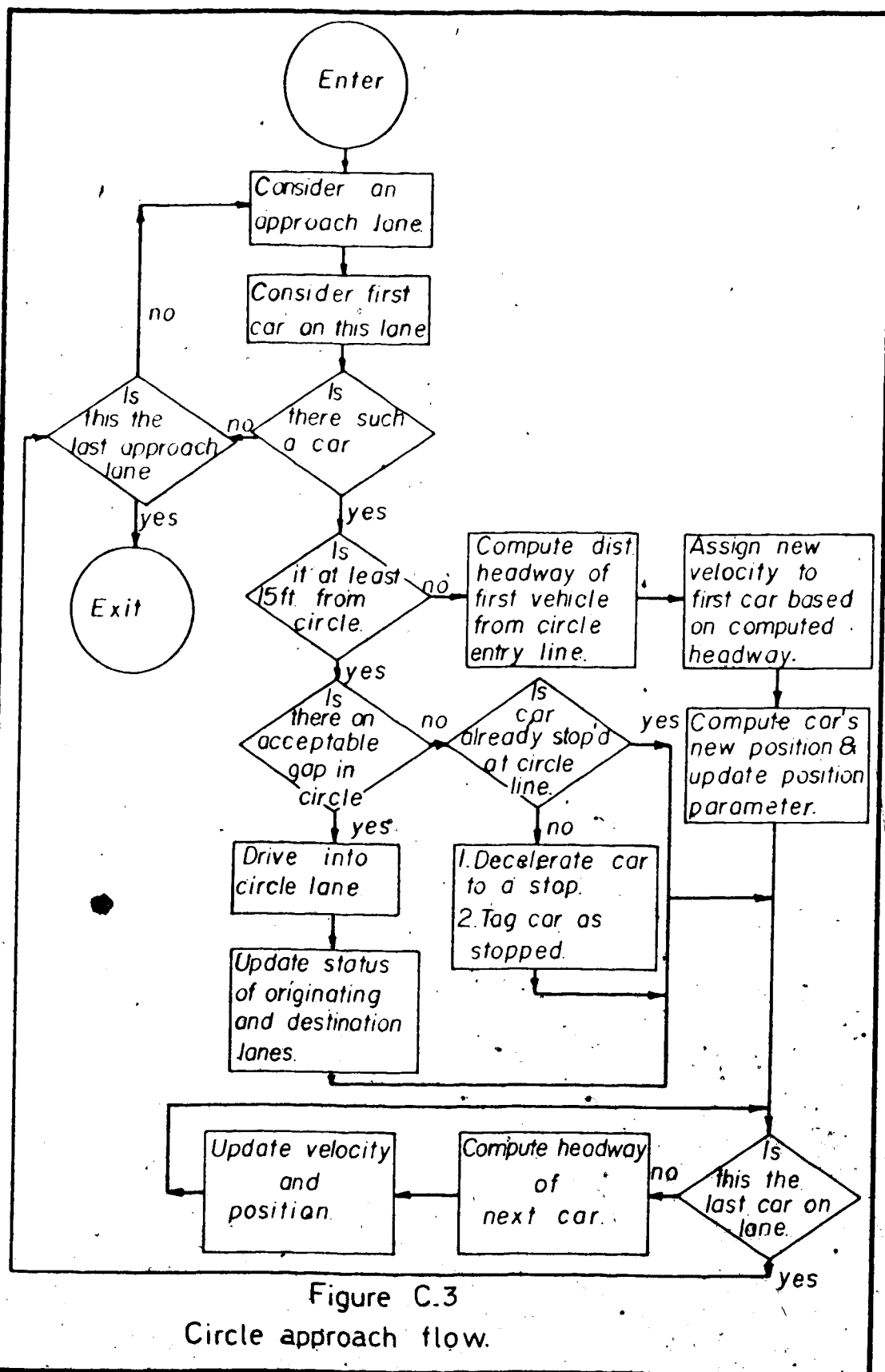

Figure C.3
Circle approach flow.

After the leader has been updated, the rest of the vehicles in the approach lane are updated by merely computing the distance headways between successive vehicles and assigning new velocities for the next scan interval. After reassigning the velocities, the position parameters of the vehicles are updated to show the respective positions of the vehicles during the coming scan interval. When all vehicles of a lane have been updated as described, the vehicles in the next lane of the current set of lanes are considered in the order as indicated in Chapter III.

C.1.5 Gap Acceptance from Inner Approach Lane

For a vehicle wishing to merge with the circle traffic stream from an inner approach lane, it is faced with the evaluation of lags and/or gaps from the two circle lanes (circle streams), since its path to its destination in the circle crosses both circle streams of traffic.

Such a vehicle is concerned with that half of the traffic circle which immediately faces it, and as far as its evaluations are concerned, the other half of the circle does not exist. In its immediate half of the circle there are two continuous circle lanes (inner and outer).

To distinguish between destination lanes and gap evaluation lanes in the circle, the two continuous streams facing the potential merger are broken up into two halves each. (see Figure C.1). One set of lanes is from the entrance of the approach artery on his immediate left to his

own exit artery (C-IN-L and C-OUT-L), and the other halves are from his artery to the exit leg of the artery on his immediate right (C-IN-R and C-OUT-R). To the potential merger, we can therefore distinguish between right and left circle lane sections. His conflict zone happens to be the first vehicle position of the outer and inner circle lanes to his right.

Before such a vehicle attempts an entry into the circle, the following conditions must be tested and satisfied simultaneously:

- (i) that the last vehicle in C-IN-R is beyond the conflict zone;
- (ii) that the last vehicle in C-OUT-R is beyond the conflict zone;
- (iii) that if the first vehicle in C-OUT-L is not an immediate turner (that is, not turning at the exit of the potential merger's artery), then such a C-OUT-L vehicle should not reach the conflict zone in the outer circle during the next scan interval;
- (iv) that if the first vehicle in C-IN-L is not an immediate turner (that is, not turning at the exit of the potential merger's artery), then such a C-IN-L vehicle should not reach the conflict zone during the next scan interval.

When the four conditions above have been met, the potential merger is said to have accepted the gap at the circle.

C.1.6 Gap Acceptance from Outer Approach Lane

The gap acceptance logic for vehicles wishing to enter the circle from the outer approach lanes (Q-OUT vehicles) differs from that of the potential mergers from the inner approach lanes (Q-IN vehicles) in the sense that, the former evaluate gaps in the outer circle lane sections only.

A Q-OUT vehicle considers C-OUT-L and C-OUT-R lanes in much the same way as a Q-IN vehicle considers the same set of the lanes; and accepts lag and/or gaps to enter the circle when the necessary tests (incorporated in Section C.1.5) are satisfied.

One important gap acceptance feature for Q-OUT vehicles is the fact that they can proceed simultaneously into the circle as soon as a Q-IN vehicle accepts a gap and enters the circle. But the reverse is not true. This is because the gap acceptance logic for Q-IN vehicles incorporates the gap acceptance logic for Q-OUT vehicles but not vice versa.

C.1.7 Inner Circle Flow

Within the system, vehicles in the inner circle lanes have the highest priority whenever there is any conflict in movements. The general flow logic in both circle lanes is the same as that in the approach lanes; in the sense that during a scan interval one and only one vehicle (the leader) is processed out of the circle lane list into the next

circle lane list or into an exit lane (see Figure C.4). The rest of the vehicles in the lane list are merely updated in the same manner as the rest of the vehicles in the approach lanes.

The leader of an inner circle lane section either travels to the next inner circle lane section or exits from the system when it is within some specified distance (15 feet) from the end of the current lane section. During exiting, an inner circle vehicle crosses the path of an outer circle vehicle with absolute priority. Since lane changing within the vicinity of the circle is not allowed in the model, it is during an entry into or exiting from the circle only, that an inner circle vehicle ever crosses the outer circle lane.

C.1.8 Outer Circle Flow

Vehicle flow in the outer circle lanes is the same as that for the inner circle lanes except that vehicles in the outer circle lanes have to yield right-of-way to vehicles in the inner circle lanes when conflict in movements occurs. After entering the circle from an outer approach lane, a vehicle in the outer circle lane travels from one outer circle lane section to the other until it reaches the exiting artery where it drives into the outer exit lane.

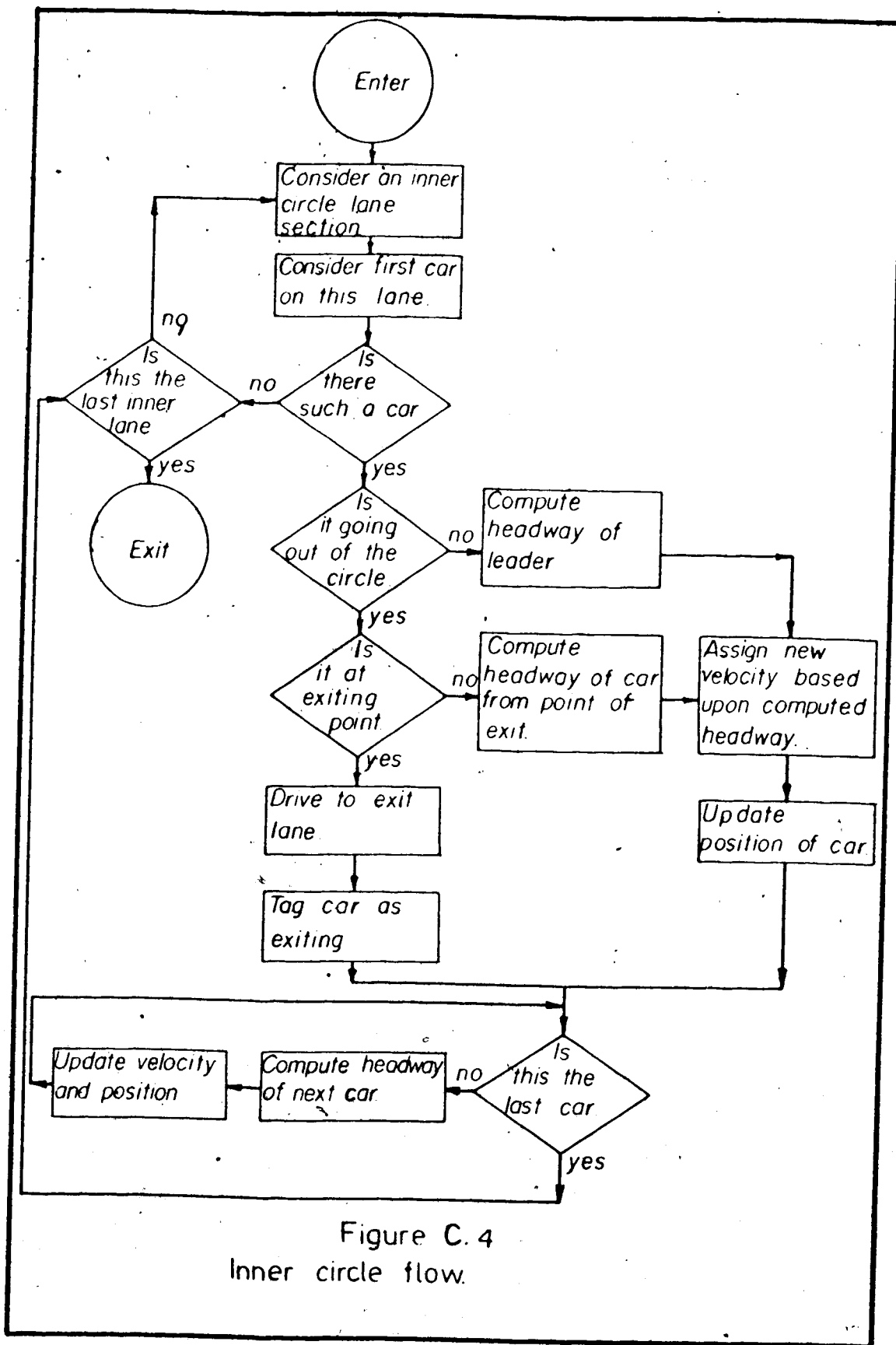

Figure C. 4
Inner circle flow.

During its passage from its current lane section to the next (anticlockwise), it checks for possible conflict with an adjacent inner circle lane vehicle which may be ready to exit. If such a conflict exists, then the outer circle vehicle yields right-of-way to the inner circle vehicle.

When all vehicles of an outer lane section have been updated, vehicles in the next outer circle lanes are considered until all outer circle lane sections have been updated (see Figure C.5).

C.1.9 Exit Process

There is no list processing along the exit lanes, because vehicles are allowed to enter the exit roads from inner and outer circle lanes one at a time, and moreover, vehicles are deemed to have left the system after traversing one vehicle space on the exit road. After travelling one vehicle-space on the exit road, the following statistics are gathered about the outgoing vehicle (if the warm-up period for the run is over):

1. The time of leaving the system;
2. Originating approach lane;
3. Exiting artery;
4. Desired travel time;
5. Actual travel time;
6. Delay;
7. Exiting speed.

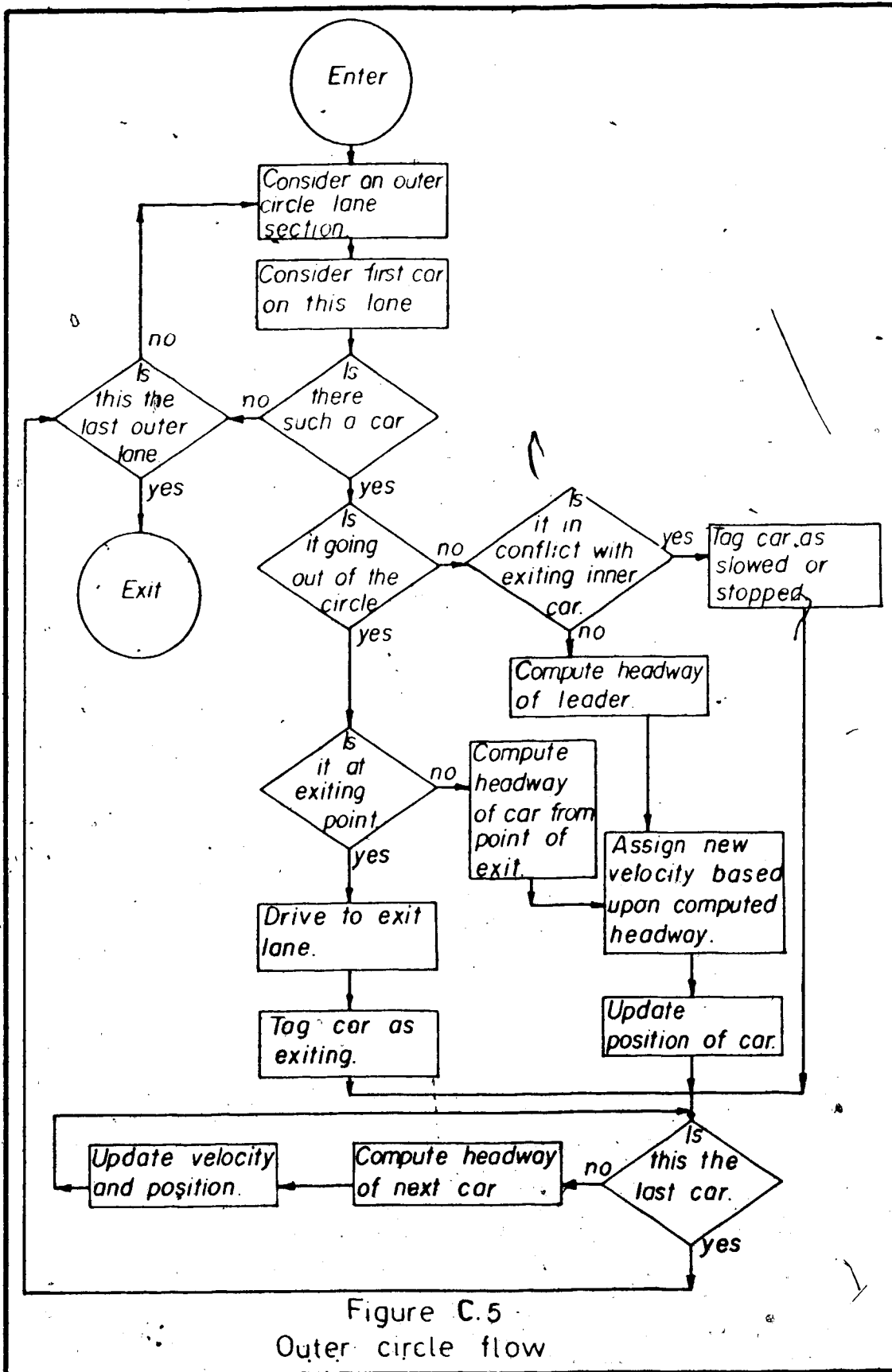

Figure C.5
Outer circle flow

When the above statistics have been collected, the vehicle is removed from the system by discarding its sequence number on the vehicle-characteristic array (see Figure C.6).

C.1.10 Queue Measurements

Queue lengths are updated for each approach queue during each scanning cycle. Initially, because there are no vehicles in the system, queue lengths are set to zero for all n approach lanes ($KUELEN(I) = 0, I=1, n$), and the updating routine is accomplished as follows:

(a) If $KUELEN(I) = 0$ and the first vehicle of this approach lane I (whose index is given by $J = NFSTA(I)$) stops, then

$KUELEN(I) \leftarrow 1$.

(b) If $KUELEN(I) > 0$ then

(i) We decrease $KUELEN(I)$ when

the first vehicle on the approach

which is not yet a member of the queue

(whose index is given by $J = NFSTA + KUELEN(I)$)

stops: $KUELEN(I) \leftarrow KUELEN(I) + 1$.

(ii) We decrease $KUELEN(I)$ when the

first vehicle in the approach lane

(whose index is given by $NFSTA(I)$) is

able to merge with the circle traffic

stream: $KUELEN(I) \leftarrow KUELEN(I) - 1$.

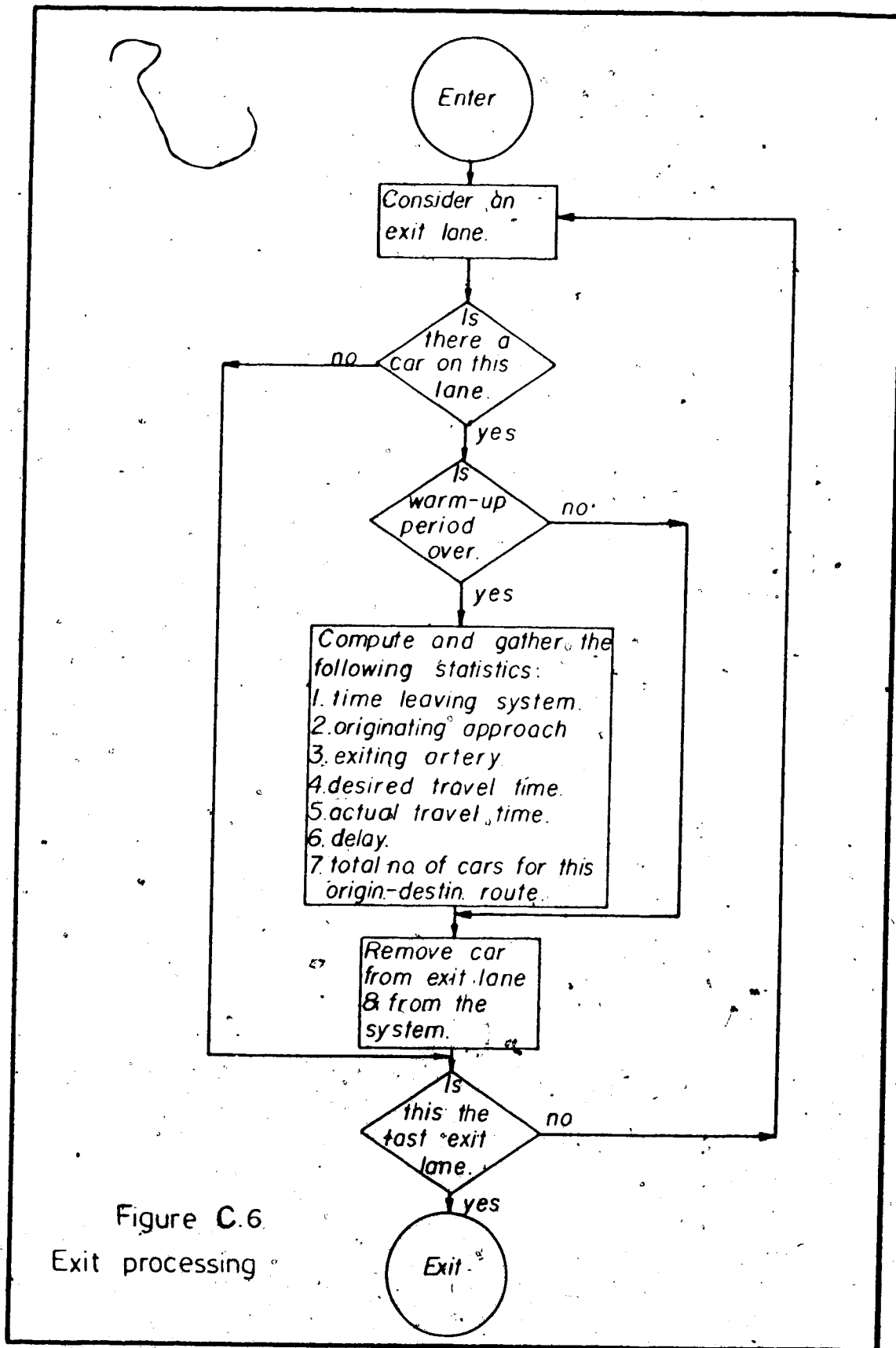

Figure C.6
Exit processing

Using this technique of queue measurement (as illustrated in Figure C.7), any vehicle that joins a queue by stopping behind the last vehicle in the queue continues to be a member of that queue until it merges with the circle traffic stream. Thus, at any instant, all vehicles counted as members of a queue are not necessarily stopped; and they continue to be members of the queue from the instant they stopped behind the queued vehicles to the instant they are able to merge with the circle traffic stream.

C.2 INPUT ORGANIZATION

To be useful as a tool for the traffic engineer in his evaluation study of a traffic circle performance, the acquisition of data to be used as input to the simulator should not constitute another problem in itself.

Taking into account the types of data on the traffic circle that are generally available to the engineer, and the types that are readily collected if not available, there are 3 different ways in which data would be accepted by the simulator depending on the type of manipulations that the engineer wishes to do with the available data. The following general form of data is usually available to the engineer; since data collected by field surveys on the traffic circle is readily and easily analyzed, using the traffic circle data analysis technique as outlined in Appendix D.

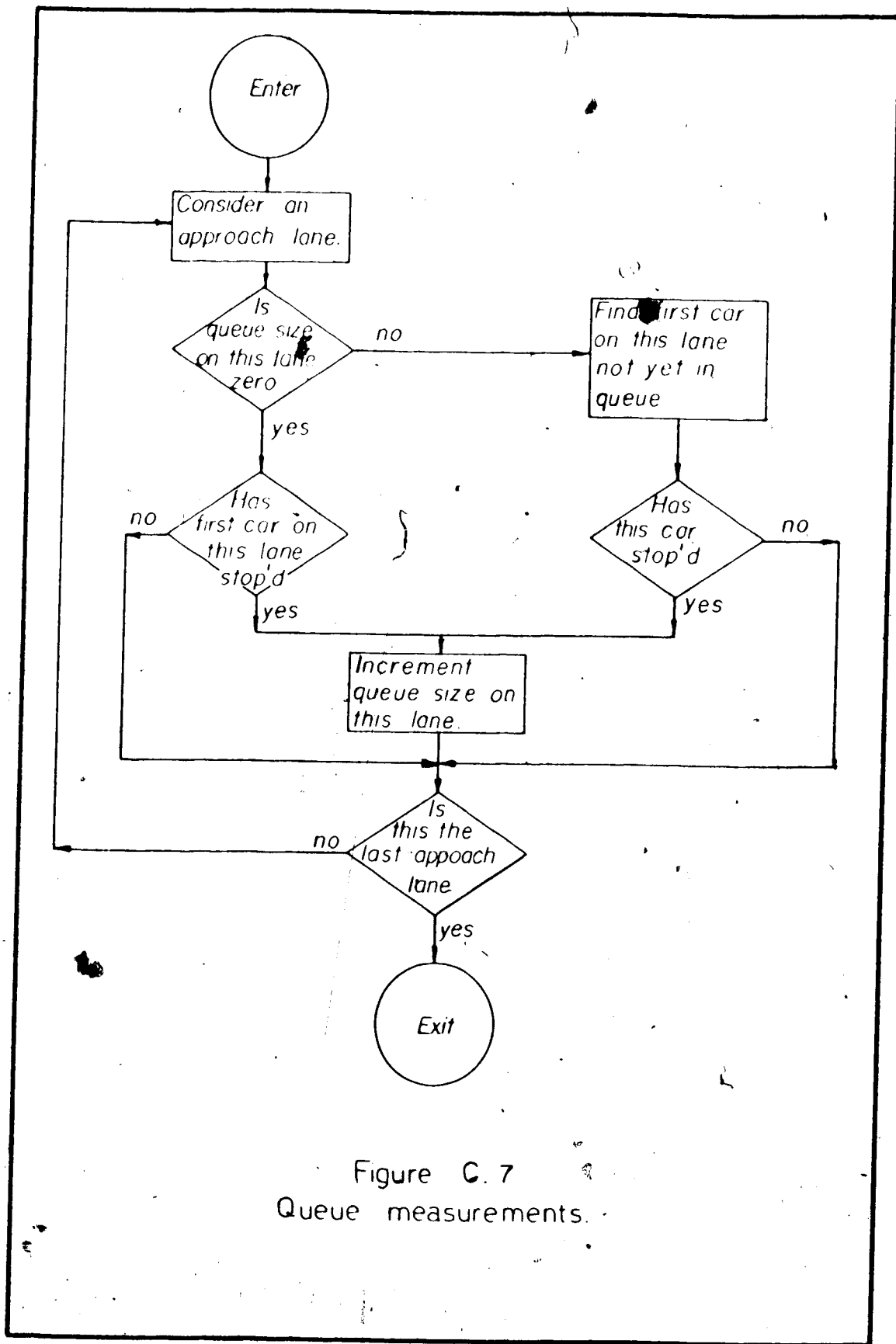

Figure C.7
Queue measurements.

- (a) Total volume (in periods of 15 minutes, 30 minutes or 1 hour) inflow of vehicles from each approach direction to the traffic circle.
- (b) The turning volumes from each approach direction for the period of data collection.

These two sets of data are always read into the program, so that they could be varied as often as needed.

Now, the rest of the input phase depends on what the engineer would want to do with the above general form of traffic circle data. As already mentioned, the simulator accepts all three types of data format.

C.2.1 Data Type 1

In this type, estimates are made of the percentages of the total volume of vehicles that arrive at the approach directions at discrete time periods of t minutes ($t=5, 10, 15, 20, 30$ or even 60 minutes) assuming that the turning rates stay the same over the simulation runtime.

Therefore the time periods and/or the arrival percentages at the approach directions could be varied, and hence vary the arrival rates at the approaches during the specified simulation runtime.

This form of data manipulation for different sets of time periods and different sets of arrival rates can be repeated as often as needed.

For example:

Suppose that the arrival rate at the approach

directions of a traffic circle is varied every 15 minutes for the first simulation period of 1 hour; and for the next hour of simulation the arrival rate is varied every 20 minutes.

The number of times that the data is to be manipulated in this manner will have to be specified and read in as input to the simulator.

Consider the data for the East approach as shown in Tables C.1 and C.2.

The hourly volume of arrival = 865 vehicles per hour
therefore, on the average the frequency of arrival is given:

$$\begin{aligned} \text{AFRQ} &= 865/3600 \\ &= 0.24 \end{aligned}$$

Considering the percentage arrivals during the four 15 minute periods of the simulation we get the following distribution of discrete arrival rates:

<u>Time Periods</u>	<u>Arr. %</u>	<u>Volume</u>	<u>Avg. Arr. Freq</u>
430--445	25	216	$216/900 = 0.25$
445--500	31	268	$268/900 = 0.30$
500--515	24	207	$207/900 = 0.24$
515--530	20	173	$173/900 = 0.21$

Table C.1
Sample Data Format
Total Hourly Statistics

APPROACH	TOTAL VOLUMES	TURN VOLUMES			TURN FREQUENCIES		
		LFT	THRU	RGT	LFT	THRU	RGT
1	815	331	404	80	0.40	0.49	0.09
2	788	85	657	46	0.10	0.83	0.05
3	988	265	680	43	0.26	0.68	0.14
4	865	15	770	80	0.01	0.89	0.09

Table C.2
Sample Data Format 1
Periodic Arrival Percentages

15 MINUTE PERIOD AFTERNOON PEAK	SOUTH APPROACH (%VOL.)	NORTH APPROACH (%VOL.)	WEST APPROACH (%VOL.)	EAST APPROACH (%VOL.)
430-445	24	33	20	24
445-500	25	31	24	31
500-515	31	24	31	20
515-530	20	20	25	25

By plotting the graph of arrival frequency against time periods, we find (in Figure C.8) that the periodic arrival distribution gives a better indication of the traffic fluctuations during peak hour flow than the constant average arrival frequency.

Preparing Input for Data Type 1

The data format for Data Type 1 is shown in Tables C.1 and C.2. In order to manipulate data with the simulator as outlined above the data should be arranged in the following sequence:

(i) CARD 1

should have the number '1' in column 4

(ii) CARD 2

should have the runtime (30 minutes or 1 hour) in seconds, punched in columns 1-4 right justified. A one hour simulation runtime will be punched in the first 4 columns as 3600.

(iii) CARD 3

should have 1, 2, 3,, Punched in columns 1-4 right justified, depending on the total number of sets of data to be manipulated in this fashion, or how many times the engineer wishes to manipulate the given data using this format.

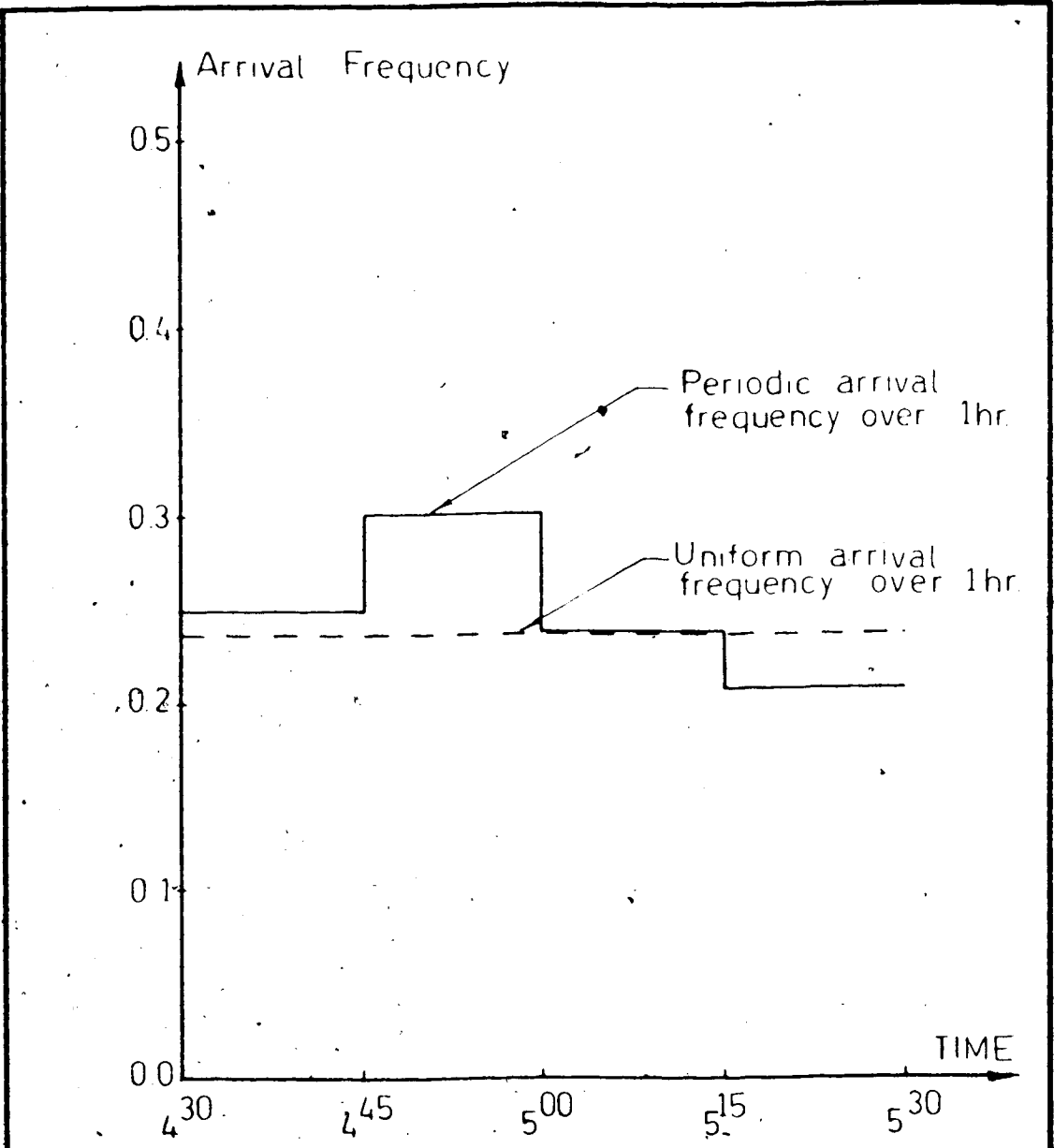

Figure C. 8
Arrival frequency distribution

(iv) CARDS 4-6

CARD 4 --- contains LFT volumes from all approaches;

CARD 5 --- contains THR volumes from all approaches;

CARD 6 --- contains RGT volumes from all approaches.

(v) CARD 7

contains the total arrival volume for the arrival arteries; and are punched in 6-column fields right-justified.

(vi) CARD 8

contains the time interval representing a period in the simulation after which necessary generating characteristics are varied. This time must either be a multiple of 30 (5, 10, 15) or a multiple of 60 (5, 10, 15, 20, 30, 60) or even a multiple of 120 depending on the specified simulation runtime on CARD 2.

(vii) CARDS 9-?

depending on the interval chosen in (vi) and the runtime chosen in (ii), there can be as many number of cards for this input phase as necessary.

For example:

(a) For a runtime of 1 hour = 3600 seconds and a 15 minute period of varying the generating characteristics we get the following

$$\text{INT1} = (3600/60)/15 = 4$$

$$\text{INT2} = \text{INT1} + 1 = 5.$$

(b) For a runtime of 30 minutes = 1800 seconds and a 15 minute period of varying the generating characteristics we get the following

$$\text{INT1} = (1800/60)/15 = 2$$

$$\text{INT2} = \text{INT1} + 1 = 3.$$

In example (a) there will be 5 cards for inputting the percentages: CARDS 9-13. And for the example (b) there would be 3 cards for inputting the percentages: CARDS 9-11. In all cases, the first card, that is CARD 9, would contain the percentages of the total arrival volumes used for system fill-up purposes; and the rest of the cards should contain figures (integers) which add up to 100 columnwise. The cards are punched in 6-column fields right-justified. If there are more sets of data of this form in the sense of period to be used and the percentages to be used; then different sets of CARD 8 and CARD 9-? are repeated, but the number of such data should not exceed the figure as represented in CARD 3.

C.2.2 Data Type 2

In this type of data organization, estimates of the turning percentages from the approach directions are made at discrete time periods of t minutes ($t=5, 10, 20, 30, 60$) assuming that the average arrival frequency stays the same over the period of the simulation.

The time periods and/or the turning percentages from

the approach directions are varied so as to have variable turning rates from the various approach directions during the simulation period.

Preparing input for Data Type 2

The data format for Data Type 2 is shown in Tables C.3 and C.4. The procedure for preparing input data to manipulate the generating characteristics as outlined above is as follows:

(i) CARD 1

should have the number '2' in column 4.

(ii) to (iv) are the same as for Data type 1

(vii) CARDS 9-?

depending on the interval chosen in (vi) and the runtime chosen in (ii), there can be as many number of cards for this input phase as necessary.

For example, if there are 6 periods for varying the turning percentages, then together with the warm-up period there would be 7 cards for each approach, the first of which is meant to be warm-up turn percentages for each approach direction.

Table C.3
Sample Data Format
Total Hourly Statistics

APPROACH	TOTAL VOLUMES	TURN VOLUMES			TURN FREQUENCIES		
		LFT	THRU	RGT	LFT	THRU	RGT
1	815	331	404	80	0.40	0.49	0.09
2	788	85	657	46	0.10	0.83	0.05
3	988	265	680	43	0.26	0.68	0.04
4	865	15	770	80	0.10	0.89	0.09

Table C.4
Sample Data Format 2
Periodic Turn Percentages

15 MINUTE PERIOD	SOUTH			NORTH			WEST			EAST		
	APPROACH			APPROACH			APPROACH			APPROACH		
	(%TURN)			(%TURN)			(%TURN)			(%TURN)		
	LFT	THR	RGT	LFT	THR	RGT	LFT	THR	RGT	LFT	THR	RGT
430-445	30	40	30	15	14	9	14	67	9	10	30	60
445-500	27	61	12	6	92	2	10	78	12	17	12	71
500-515	59	15	36	12	7	81	13	86	1	23	21	56
515-530	4	85	11	33	33	34	2	95	3	30	9	61

Cards 9 through 36 would therefore be arranged as follows:

```

          { CARD 9  contains 30 40 30;
          { CARD 10 contains 15 65 20;
For      {
Approach {
1        {
          { CARD 14 contains 17 57 26;
          { CARD 15 contains 41 36 23.

```

The rest of the cards follow the same arrangement as above; with CARDS 16-22 for Approach 2 CARDS 23-29 for Approach 3 and CARDS 30-36 for Approach 4 in that order.

In the above sequence of cards, CARDS 9, 16, 23 and 30 contain the warm-up turn percentages from the Approaches 1, 2, 3 and 4 respectively.

If there are more sets of data of this form in the sense of period to be used and the percentages used; then different sets of the CARD 8 and CARDS 9-? are repeated, but again the number of such sets of data should not exceed the figure as represented in CARD 3.

C.2.3 Data Type 3

This is a combination of the first two types of data formats. In this type, estimates are made of percentages of the total volume of vehicles that arrive at the various approach directions at the discrete time periods as may be specified, and at the same time estimate the turning

percentages of the estimated arrivals during the period specified.

Here, it is possible to study the effect of periodic changes both in arrival rates and turning probabilities by arbitrarily specifying arrival percentages (of the total hourly volume) for discrete time intervals, and at the same time specifying the percentages of turning volumes for the particular period from all approach directions.

Preparing input for Data Type 3

The data format for Data Type 3 is shown in Tables C.5 and C.6. In order to manipulate data with the simulator as outlined above, the following procedure of input data organization should be followed:

(i) CARD 1

should have a '3' in column 4.

(ii) to (vi) are the same as for Data Types 1 and 2.

(vii) CARDS 9-? Correspond to CARDS 9-? Of Data Type 1.

(viii) CARDS 16-? Correspond to CARDS 9-? Of Data Type 2.

Table C.5
Sample Data Format
Total Hourly Statistics

APPROACH	TOTAL VOLUME	TURN VOLUMES			TURN FREQUENCIES		
		LFT	THRU	RGT	LFT	THRU	RGT
1	815	331	404	80	0.40	0.49	0.09
2	788	85	657	46	0.01	0.83	0.05
3	988	265	680	43	0.26	0.68	0.04
4	865	15	770	80	0.01	0.89	0.09

Table 6
Sample Data Format 3
Periodic Arrival and Turn Percentages

15 MINUTE	SOUTH APPRH			NORTH APPRH			WEST APPRH			EAST APPRH						
PERIOD	AR	(%TURN)		AR	(%TURN)		AR	(%TURN)		AR	(%TURN)					
P.M. PEAK	%	LT	TH	RT	%	LT	TH	RT	%	LT	TH	RT				
430-445	24	30	40	30	25	15	41	34	20	14	67	9	24	10	30	60
445-500	25	27	61	12	30	6	92	2	24	10	78	12	31	17	12	71
500-515	31	59	15	36	24	12	7	81	31	13	86	1	20	23	21	56
515-530	20	4	85	11	20	33	33	34	25	2	95	3	25	30	9	61

It is clear from the three types of data organization that Data Type 3 comprises Data Types 1 and 2 so that data types 1 and 2 could be simulated using data type 3 by merely holding one of the generating characteristics (arrival volumes or turning volumes) constant.

Of course, most parts of the input organization could be changed very easily by any one familiar with FORTRAN, by changing the appropriate format statements.

The user does not have to conform to the 6-column and the 4-column fields chosen for test data organization as described in the input organization section.

APPENDIX D

ANALYSIS OF DIRECTIONAL FLOWS AT TRAFFIC CIRCLES

This is a method developed by van Hoffen [50] for more accurate and precise analysis of traffic circle counts.

Briefly, the method is as follows:

Some selected movements are counted directly, and all other movements are calculated by solving simultaneous equations. Assuming that vehicles do not negotiate U-turns at traffic circles; that is, vehicles entering the circle via the approach section of an artery do not exit from the circle via the exit section of the same artery; then treating cars and trucks alike (Vehicles), 12 equations can be set up involving 12 directional flows at any 4-arm traffic circle.

The following abbreviations are made use of on the equations to follow:

NE --- North-East traffic;

NS --- North-South traffic;

NW --- North-West traffic;

WN --- West-North traffic;

WE --- West-East traffic;

WS --- West-South traffic;

SW --- South-West traffic;

SN --- South-North traffic;
 SE --- South-East traffic;
 ES --- East-South traffic;
 EW --- East-West traffic;
 EN --- East-North traffic.

Referring to Figure D.1 the indicated measured flows are interpreted as follows:

- (1) ----> Vehicles entering circle from the North;
- (2) ----> " " " " " West;
- (3) ----> " " " " " South;
- (4) ----> " " " " " East;
- (5) ---> Vehicles leaving circle at the North Exit;
- (6) ---> " " " " " West "
- (7) ---> " " " " " South "
- (8) ---> Vehicles which cross that point as indicated
 by the arrow in Figure D.1;
- (9) ---> Right-turning vehicles from the North;
- (10) ---> " " " " West;
- (11) ---> " " " " South;
- (12) ---> " " " " East.

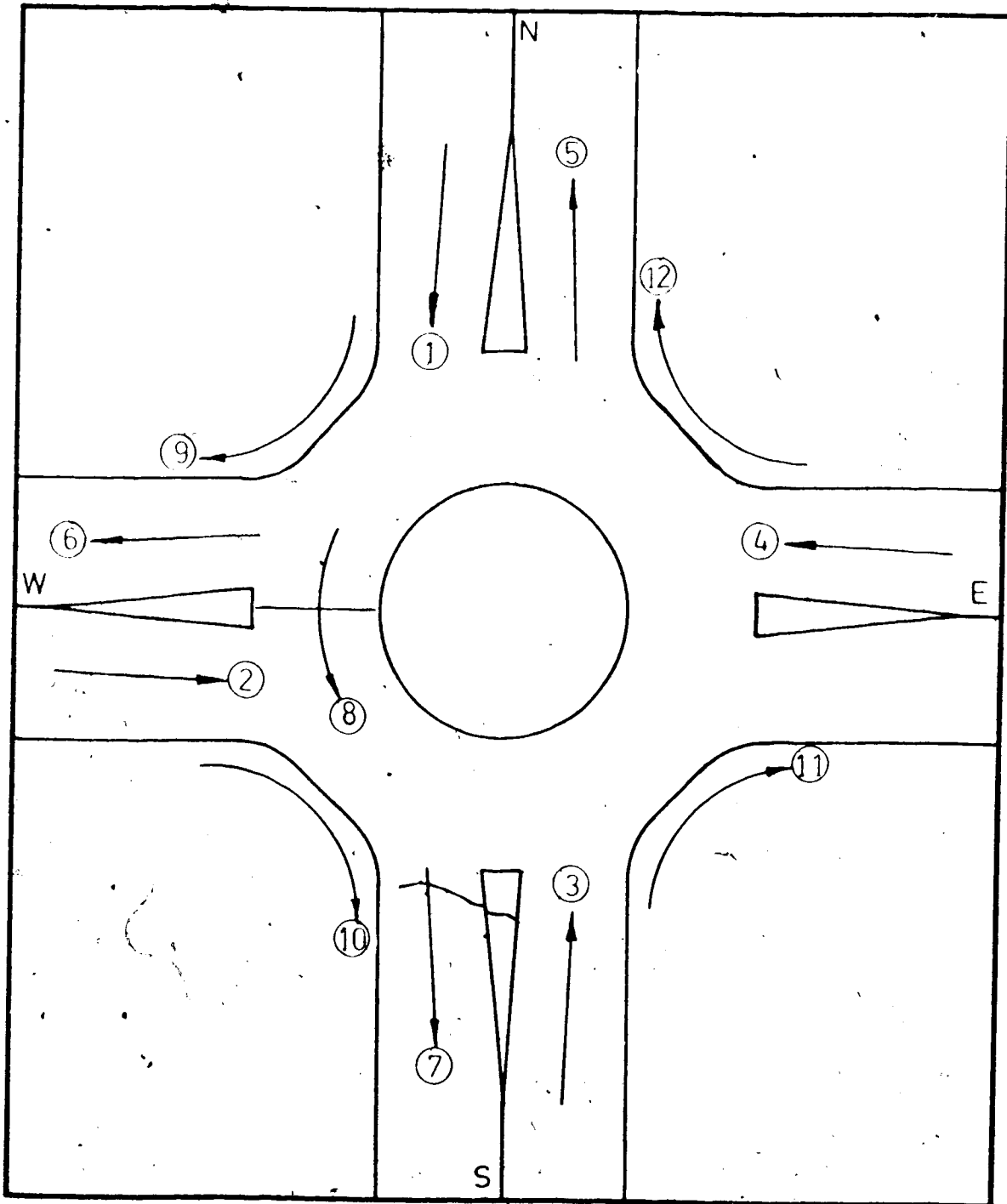

Figure D.1
Measured flows to determine directional flows.

The 12 simultaneous equations that can be set up as a result of the above measurements are:

$$(1) \text{---} \rightarrow NE + NS + NW = a_1 ;$$

$$(2) \text{---} \rightarrow WN + WE + WS = a_2 ;$$

$$(3) \text{---} \rightarrow SW + SN + SE = a_3 ;$$

$$(4) \text{---} \rightarrow ES + EW + EN = a_4 ;$$

$$(5) \text{---} \rightarrow WN + SN + EN = a_5 ;$$

$$(6) \text{---} \rightarrow SW + EW + NW = a_6 ;$$

$$(7) \text{---} \rightarrow ES + NS + WS = a_7 ;$$

$$(8) \text{---} \rightarrow ES + NS + NE = a_8 ;$$

$$(9) \text{---} \rightarrow NW = a_9 ;$$

$$(10) \text{---} \rightarrow WS = a_{10} ;$$

$$(11) \text{---} \rightarrow SE = a_{11} ;$$

$$(12) \text{---} \rightarrow EN = a_{12} .$$

Equations (9) to (12) are the only ones that are obtained directly from the field surveys. In addition to the directly measured flows, the remaining 8 values are easily solved as follows:

We set up 8 simultaneous linear equations with 8 unknowns in this manner.

$$\text{From (1) and (9) ---} \rightarrow NE + NS = a_1 - a_9 ; \quad (A)$$

$$\text{From (2) and (10) ---} \rightarrow WN + WE = a_2 - a_{10} ; \quad (B)$$

$$\text{From (3) and (11) ---} \rightarrow SW + SN = a_3 - a_{11} ; \quad (C)$$

$$\text{From (4) and (12) ---} \rightarrow ES + EW = a_4 - a_{12} ; \quad (D)$$

$$\text{From (5) and (12) ---} \rightarrow WN + SN = a_5 - a_{12} ; \quad (E)$$

$$\text{From (6) and (9) } \rightarrow SW + EW = a_6 - a_9 ; \quad (F)$$

$$\text{From (7) and (10) } \rightarrow ES + NS = a_7 - a_{10} ; \quad (G)$$

$$\text{From (8) } \rightarrow ES + NS + NE = a_8 . \quad (H)$$

SOLUTIONS:

$$\text{From (G) and (H) } \rightarrow NE = a_8 (ES+NS) = a_8 - a_7 + a_{10};$$

$$\text{From (A) } \rightarrow NS = a_1 - a_9 - NE;$$

$$\text{From (G) } \rightarrow ES = a_7 - a_{10} - NS;$$

$$\text{From (D) } \rightarrow EW = a_4 - a_{12} - ES;$$

$$\text{From (F) } \rightarrow SW = a_6 - a_9 - EW;$$

$$\text{From (C) } \rightarrow SN = a_3 - a_{11} - SW;$$

$$\text{From (E) } \rightarrow WN = a_5 - a_{12} - SN;$$

$$\text{From (B) } \rightarrow WE = a_2 - a_{10} - WN.$$

Thus, knowing all the a's, the directional flows are easily computed from the selected measured flows.

For example, the total flow from the four approaches and the corresponding turning movements from the same four approaches are given as:

	<u>Approach</u>	<u>Volume</u>	<u>Turn</u>	<u>Movements</u>
From North	1	$NE+NS+NW=a_1$	NE	NS NW;
From West	2	$WN+WE+WS=a_2$	WN	WE WS;
From South	3	$SW+SN+SE=a_3$	SW	SN SE;
From East	4	$ES+EW+EN=a_4$	ES	EW EN.

a_1, a_2, a_3, a_4 are measured directly as part of the selected counts to be made; and SW, SN, SE, ES, EW and so on, are obtained as solved above.

This method will fail however, when there is no guarantee for non U-turners at the circle, and it is applicable only to circles with 4 approaches and exits.

APPENDIX E

DATA COLLECTION AND ANALYSIS

E.1 Data Collection for Peak-Hour Demand

To be able to collect the data for the measured flows at a traffic circle in order to determine the 12 directional flows of a 4-legged circle, 8 observers are needed for traffic counts. Fortunately enough, the model generates vehicle arrivals on the same basis as the counts made by the traffic division of the City of Edmonton Engineering Department, that is, on approach basis; so that the Input Traffic Volumes used for the model generation routine were the peak-hour demand collected occasionally by the Traffic Division of the City of Edmonton Engineering and Transportation Department.

The counts are one-hour traffic obtained for all approaches of a traffic circle. Traffic counts for each approach are stratified into left-turn, through, and right-turn maneuvers. The data are for the morning and afternoon peak hours (7³⁰-8³⁰ AM and 4³⁰-5³⁰ PM respectively) for the following traffic circles in the City of Edmonton:

1. 111 Avenue and Great Road;
2. 114 Street and University Avenue;
3. 125 Avenue and St. Albert Trail;

4. 114 Street and 72 Avenue.

A brief description of each traffic circle is given in Table E.1

Table E.1
Summary of Study Circles

TRAFFIC CIRCLE	TYPE	MAJOR STREET	MINOR STREET	LOCATION WITHIN CITY
111 Ave and Groat Road	4-Legged 2-way-2-way 2 lanes in all sections	Groat Road	111 Ave	Outlying Shopping Center
114 St. and Univ. Ave	4-Legged 2-way-2-way 2 lanes in all sections	114 St.	Univ. Ave	Outlying University Area
125 Ave and St. Albert Trail	4-Legged 2-way-2-way 2 lanes in all sections	St. Albert Trail	125 Ave	Outlying Shopping Center
114 St. and 72 Ave.	4-Legged 2-way-2-way 2 lanes in all sections	114 St.	72 Ave	Outlying University Area

E.2 Data Collection to Establish Capacities
of Circle Lane Sections

The number of vehicles within a circle lane section is theoretically computed from the specification of the length of a circle lane section and the effective vehicle length assumed in the system. But due to the fact that the

vehicles in the circle lanes are always in motion (since they have absolute priority in the system), it is practically impossible to have all the vehicle spaces in a circle lane section simultaneously occupied.

Data was therefore collected at some specific traffic circles to determine practically how many vehicles are within a lane section of a circle at any time during peak hour flows. One observer was adequate for the collection of this data, since attention was focussed on one circle lane section at a time first, attention was focussed on the inner circle lane section and for time intervals of 1 minute, the number of vehicles within the lane section was recorded. Thus after one hour, the maximum number of vehicles within a circle lane section during peak hour flow was established for both inner and outer circle lane sections.

E.3 Data Collection for Gap Measurements

The data collection for gap measurement at the circle was done in a simple less sophisticated manner. The circle lane sections to the left of a potential merger were divided into vehicle spaces for both inner and outer circle lane sections (see Figure E.1). The following procedure was adopted for the evaluation of gaps by inner and outer approach lane potential mergers:

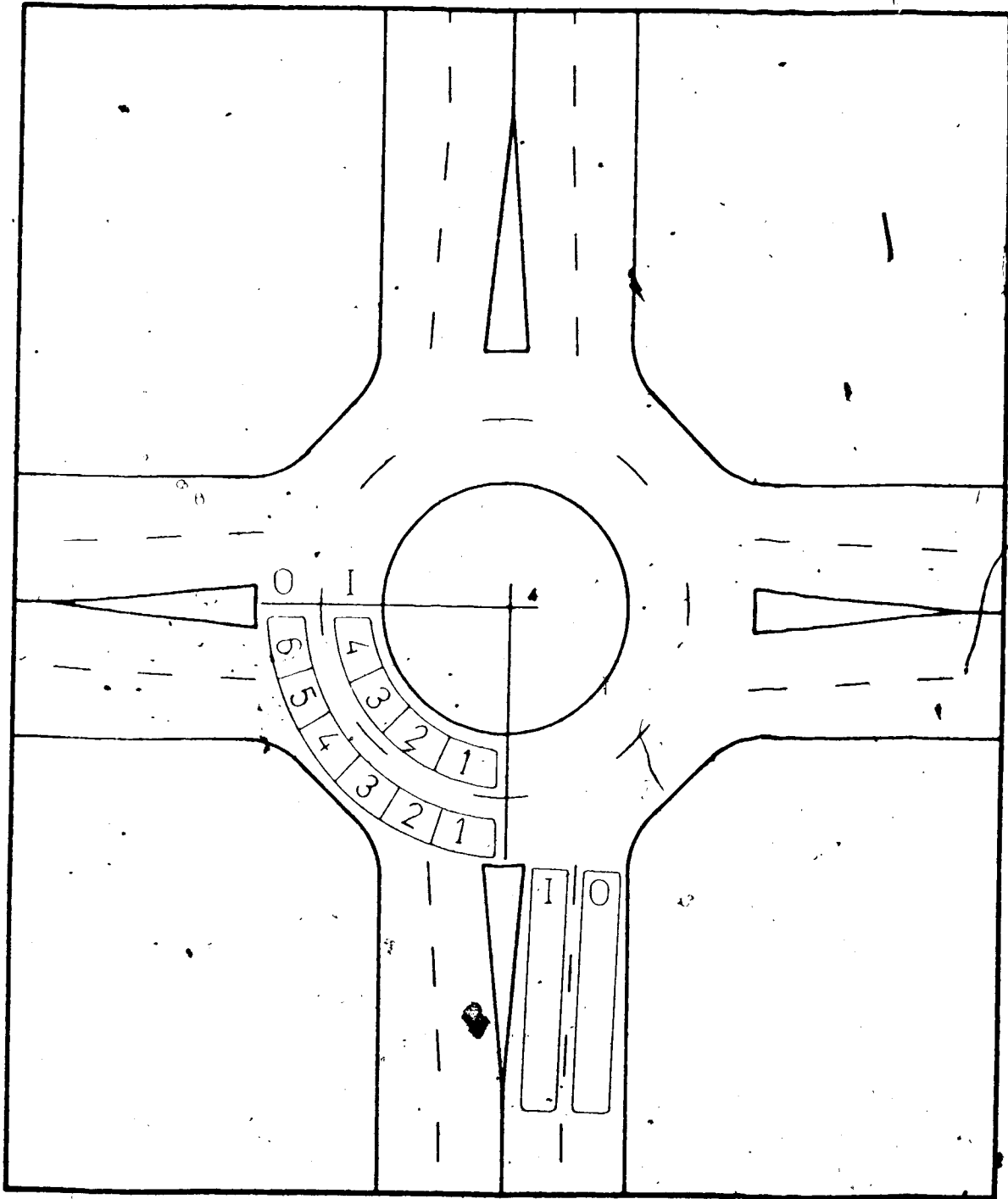

Figure E.1

Schematic of Circle depicting layouts for gap analysis studies.

Inner

For the evaluation of gaps by an inner approach vehicle, attention was focussed on the first four vehicle positions of the inner and outer circle lane sections to the left of the potential merger as shown in Figure E. Two observers were needed for this measurement.

Whenever an inner approach vehicle accepted a gap to enter the circle, one observer would check the vehicle positions in the inner circle lane section which were occupied, and the other would do likewise for the outer circle lane section. This process was repeated for all vehicles entering the circle from the inner approach lane for a period of 30 minutes of the peak hour flow, and the results were tabulated as shown in Table E.2.

Outer

For the remaining 30 minutes of the peak hour flow attention was focussed on the first four vehicle positions of the outer circle lane section only. One observer was adequate for recording the evaluation of gaps by outer approach vehicles. Whenever an outer approach vehicle accepted a gap to enter the circle the occupied vehicle positions in the outer circle lane sections were checked only if an adjacent inner approach vehicle had not already accepted gap to enter the circle. That is, no record was kept for an outer approach vehicle taking advantage of gap analysis by an inner approach vehicle.

Table E.2
Inner Lane Gap Analysis Summary Sheet

	I				O					
	1	2	3	4	1	2	3	4	5	6
1	N	N	Y	Y	N	N	N	Y		
2	N	N	N	Y	N	Y	Y	Y		
3	N	Y	N	N	N	N	Y	Y		
4	N	N	Y	Y	N	Y	Y	Y		
5	N	N	N	Y	N	N	N	Y		
100	N	N	N	Y	N	N	Y	Y		

N---unoccupied vehicle space
Y ---occupied vehicle space

Again, the process was carried out for all vehicles entering the circle from the outer approach lane for a period of 30 minutes of the peak hour flow, and the results were tabulated as shown in Table E.3. After analyzing the two tables for the peak hour data, it was deduced that the conflict zone for inner approach vehicles was the first two vehicle spaces of the inner and outer circle lane sections together with the last vehicle position of the potential merger's destination lane. Similarly, it was deduced that the conflict zone of the outer approach lane was the first vehicle position of the outer circle lane section together with the last two vehicle positions of the potential

Table E.3
Outer Lane Gap Analysis Summary Sheet

	1	2	3	4	5	6
1	N	Y	Y	Y		
2	N	N	Y	N		
3	Y	N	N	Y		
4	N	N	Y	Y		
5	N	N	Y	Y		
100	N	N	Y	Y		

N---unoccupied vehicle space
Y---occupied vehicle space

merger's destination lane.

Such a gap analysis procedure is understandably not very accurate, but considering the amount and effort required in sophisticated field measurements, this crude method is deemed satisfactory for the accuracy required in the model.