

Role of Water and Fine Solids in Onset of Coke Formation During Bitumen Cracking

by

Paul Nhieu

A thesis submitted in partial fulfillment of the requirements for the degree of

Master of Science

in

Chemical Engineering

Department of Chemical and Materials Engineering

University of Alberta

© Paul Nhieu, 2014

ABSTRACT

The aim of this study was to examine the effect of steam and fine solids on coke formation during thermal cracking of bitumen. Experiments in a batch reactor at hydrothermal conditions determined the effects of fine solids and water on the onset of coke formation, total coke yield, and defined the overall conversion to light products of Athabasca vacuum tower bottoms. Removal of fine solids had significant effects on the onset time of coke formation while addition of water played a smaller role. The addition of water had no significant impact on onset time or total coke yield. The yield of cracked products, as determined by simulated distillation, was insensitive to water and fine solids. Based on the findings from this study, residual fine solids have a beneficial effect on thermal upgrading, while water gives little impact. Fine solids allows for longer reaction before coke formation, enabling increased bitumen conversions.

ACKNOWLEDGEMENTS

I would like to formally acknowledge my supervisor, Dr. Murray Gray, for his guidance and mentorship. I am very grateful to be given the opportunity to work under his supervision. I also thank Dr. Qi Liu and Dr. William McCaffrey for their insights and suggestions during group meetings.

I am thankful to have had Leonardo de Oliveira as a summer research student. Leonardo proved to be an enormous help in my collection of experimental data. Additionally, I would like to recognize Lisa Brandt, Xiaoli Tan and Jeremiah Bryska for their support in running COSI, providing training on lab equipment and ensuring safe and secure day-to-day lab operations.

I would also like to mention the assistance I've received from countless number of students and staff here at the University of Alberta. They have made my university experience an extremely memorable and enjoyable one.

Special thanks to my parents for providing me with support and encouragement throughout my studies and also to the friends I have made who shared this journey with me and become an essential part of my life.

TABLE OF CONTENTS

CHAPTER 1: Introduction	1
1.1 Introduction	1
1.2 Research Objectives	3
CHAPTER 2: Literature Review	4
2.1 Overview of Thermal Cracking of Bitumen	4
2.2 Effect of Water on Thermal Cracking of Bitumen	6
2.2.1 Water Solubility in Bitumen	9
2.3 Effect of Solids on Thermal Cracking of Bitumen	11
2.4 Proposed Approaches to Upgrading Bitumen-Water Mixtures in Literature	13
CHAPTER 3: Experimental Methods	15
3.1 Chemicals and Materials	15
3.2 Feed Characterization and Analysis	16
3.2.1 Analysis and Characterization of Vacuum Tower Bottoms	16
3.2.2 Analysis and Characterization of Bitumen Froth	16
3.3 Microreactor Sand Bath Experiments	17
3.3.1 Experimental Conditions	19
3.3.1.1 Temperature	19
3.3.1.2 Reaction Time	19
3.3.1.3 Pressure Estimations and Calculations	21
3.3.2 Coke and Fine Solids Yield Measurement	22
3.4 Simulated Distillation Analysis	22
CHAPTER 4: Results and Discussion	23
4.1 Feed Composition of Athabasca Vacuum Tower Bottoms	23
4.2 Feed Composition of Athabasca Bitumen Froth	25
4.3 Temperature Profile of Microreactor in Sandbath	27

4.4	Onset of Coke Formation for Athabasca Tower Bottoms with Varying Content of Water	28
4.5	Determining Coke Onset Time for Athabasca Tower Bottoms Through Linear Regression	31
4.6	Examining the Significance of Water in the Amount of Coke Formed	33
4.7	Testing For Linear Trend in Coke Yield as a Function of Water Content	35
4.8	Onset of Coke Formation for Athabasca Vacuum Tower Bottoms with and without Solids	36
4.9	Onset of Coke Formation for Bitumen Froth	38
4.10	Simulated Distillation and Conversion	40
	4.10.1 Conversion of Vacuum Tower Bottoms	40
	4.10.2 Conversion of Bitumen Froth	41
4.11	Comparison of Results with Literature	43
4.12	Integration of Findings for Process Design of Bitumen-Water Upgrading	44
	4.12.1 Base Case	45
	4.12.2 Supercritical Case	49
	4.12.3 Issues to be Addressed	49
	CHAPTER 5: Conclusions and Recommendations	51
	5.1 Conclusions	51
	5.2 Recommendations	52
	REFERENCES	53
	APPENDIX A: Additional Data and Figures	58
	APPENDIX B: Bitumen Water Solubility Calculations	60
	APPENDIX C: Conversion Calculations	65
	APPENDIX D: Sample Process Design for Supercritical Case	66

LIST OF TABLES

Table 2.1	Summary of literary findings from thermal cracking of bitumen or vacuum residue with water	8
Table 2.2	Parameters for Model A (Amani 2014)	10
Table 3.1	List of chemical and materials used in microreactor experiments	15
Table 3.2	VMGSim estimated pressure for each experimental case	20
Table 3.3	VMGSim worst case pressure for high pressure experimental cases	21
Table 4.1	Elemental analysis of vacuum tower bottom fine solids	23
Table 4.2	Mineral content of vacuum tower bottoms obtained from X-ray diffraction	24
Table 4.3	Elemental analysis of bitumen froth fine solids	25
Table 4.4	Mineral content of bitumen froth fine solids obtained from X-ray diffraction	26
Table 4.5	Coke onset times as a function of water content calculated from linear regression with upper and lower 95% confidence intervals	32
Table 4.6	Yield of coke and fine solids for varying water content at 45 minutes and 410°C	33
Table 4.7	Yield of coke and fine solids for varying water content at 50 minutes and 410°C	33
Table 4.8	Yield of coke and fine solids for varying water content at 60 minutes and 410°C	33
Table 4.9	P-values for paired t-test of coke yield with various water content at 3 different reaction times	35
Table 4.10	Slope of linear regression line for coke yield as a function of water content with 95% confidence intervals	35
Table 4.11	Conversion of vacuum tower bottoms for 40 minutes of reaction time at 410°C	41
Table 4.12	Conversion of bitumen froth for 45 minutes of reaction time at 410°C	42
Table A1	Boiling curve for Syncrude Athabasca bitumen (Gray 2014)	58
Table B1	Bitumen-water solubility obtained from Model B of Amani (2014)	63

LIST OF FIGURES

Figure 2.1	Proposed SAGD and partial upgrading facility (Modified from Kayukawa 2009)	13
Figure 4.1	X-ray diffraction pattern of fine solids from vacuum tower bottoms	24
Figure 4.2	X-ray diffraction pattern of fine solids from bitumen froth	26
Figure 4.3	Temperature profile of microreactor immersed in the sand bath setup	27
Figure 4.4	Coke and fine solids yielded as a function of time for VTB without addition of water (0.25 MPa)	29
Figure 4.5	Coke and fine solids yielded as a function of time for VTB with 17.4 wt% addition of water (13 MPa)	29
Figure 4.6	Coke and fine solids yielded as a function of time for VTB with 33.3 wt% water (23 MPa)	30
Figure 4.7	Linear regression on coke and fine solids yielded as a function of time for VTB without addition of water	32
Figure 4.8	Coke and fine solids yielded for VTB as a function of water content at 3 different reaction times	34
Figure 4.9	Linear regressions on coke yield as a function of time for VTB with and without solids	36
Figure 4.10	Linear regressions on coke yield as a function of time for VTB with solids removed and varying water content	37
Figure 4.11	Coke and fine solids yielded as a function of time for bitumen froth (6.9 MPa)	38
Figure 4.12	Coke and fine solids yielded as a function of time for bitumen froth (17.5 MPa)	39
Figure 4.13	Linear regression on coke and fine solids yielded as a function of time for bitumen froth	39
Figure 4.14	Boiling curves of VTB feed and products obtained from SimDist for 40 minutes of reaction time at 410°C	40

Figure 4.15	Boiling curves of bitumen froth feed and products obtained from SimDist for 45 minutes of reaction time at 410°C	42
Figure 4.16	Process flow diagram for base case of bitumen-water upgrading	48
Figure A1	Simulated distillation curve for Athabasca vacuum tower bottoms (McFarlane 2007)	58
Figure A2	Linear regression on coke and fine solids yielded for vacuum tower bottoms with 17.4 wt% water added	59
Figure A3	Linear regression on coke and fine solids yielded for vacuum tower bottoms with 33.3 wt% water added	59
Figure D1	Process flow diagram for bitumen-water upgrading under supercritical conditions	68

NOMENCLATURE

H_{wt}	Hydrogen weight fraction
K	Equilibrium constant
k	Rate constant
$m_{feed,524+}$	Mass of feed with boiling point above 524°C
$m_{product,524+}$	Mass of product with boiling point above 524°C
P	Total pressure
P_{bit}^{sat}	Saturated pressure of bitumen
P_w	Partial pressure of water
T	System temperature
T_b	Boiling point of hydrocarbon
t	Reaction time
w_w	Weight fraction of water in hydrocarbon/liquid phase
X	Conversion

CHAPTER 1

INTRODUCTION

1.1 Introduction

Bitumen is a heavy crude oil that is differentiated from conventional crude by its high viscosity, high density and high metal content. The bitumen deposit contained in the Athabasca oil sands is a vast and valuable resource. It is estimated that the reserves contain approximately 170 billion barrels of bitumen that can be recovered using current technology (Energy Resources Conservation Board 2011). Bitumen contained in these reservoirs is heavy and extremely viscous. Bitumen can be converted into a lighter and sweeter synthetic crude oil to increase its value through a process called upgrading. Oil sands or bitumen upgrading can be achieved through a variety of ways including: removal of sulfur, nitrogen, oxygen and heavy metals, conversion of high boiling point components to lower boiling point components and reduction in density (Gray 2014).

In oil sands mining operations, where the oil sands formation is near the surface, the ore is excavated through open-pit mining and sent to crushers. The crushed oil sands particles are made into a slurry through the addition of air, water and other additives. The slurry is sent through hydrotransport pipelines to digest the ore and liberate the bitumen from the sand grain by attaching to air bubbles (Masliyah et al. 2011). This mixture is sent to an extraction plant where it is diluted with water and undergoes gravity separation. Bitumen froth is removed from the top of the vessel and leaves the extraction plant. The bitumen froth is further processed to obtain clean bitumen through a process called froth treatment. There are two main methods of bitumen froth treatment, paraffinic and naphthenic froth treatment. In paraffinic froth treatment, a paraffinic solvent is added and asphaltenes are precipitated. The asphaltenes serve as a collector of fine solids and water. In this operation, approximately 7-9 wt% of the bitumen is precipitated and rejected into the tailings (Gray 2014). Naphthenic froth treatment consists of adding naphtha as a solvent to reduce the viscosity and density of the bitumen to allow for easy

separation of water and solids (Masliyah et al. 2011; Gray 2014). After the froth treatment process, the diluent is removed and crude bitumen is sent to a processing stage where it is thermally cracked at temperatures above 420°C in a process referred to as primary upgrading (Gray 2014). The objective of primary upgrading is to break chemical bonds to obtain a lighter product. Primary upgrading method will depend on the froth treatment method employed. If paraffinic froth treatment is employed, LC-finishing is the method of choice for primary upgrading. Coking processes such as delayed coking or fluid coking is more suited for naphthenic froth treatment (Gray 2014). The difference in the choice of processes is because of partial deasphalting in paraffinic froth treatment, where many of the large bitumen molecules have already been rejected so a coking process is not required. Subsequently, secondary upgrading method is used for removal of unwanted sulphur and nitrogen atoms. Secondary upgrading involves using hydrogen and a catalyst at high pressure and temperature. Afterwards, bitumen becomes a high quality synthetic crude oil ready to be sent to a refinery for fractionation and further processing.

A key challenge faced in oil sands upgrading is the formation of an unwanted by-product called coke. Coke is a carbon rich material that is formed from bitumen in high temperature processes and is undesirable (Gray 2014). A large build-up of coke can cause fouling of process equipment which eventually reduces heat transfer and increases pressure drop (Gray 2014). A solution that is being discussed is to include water and fine solids in the upgrading process to reduce coke yield and increase onset time of coke formation (Cheng et al. 2009; Zhao et al. 2006). A proposed method for bitumen-water upgrading by Kayukawa (2009) suggests bitumen and water reactions at very high temperature pressure, above supercritical point of water, and also addition of water to obtain a high water to bitumen ratio. This approach requires expensive equipment in order to pressurize and heat the mixture to such high pressures and temperatures.

A viable alternative is to partially upgrade the bitumen froth with its residual water and solids at hydrothermal conditions, prior to froth treatment, in order to combine the steps of froth treatment and primary upgrading. Hydrothermal conditions are defined in this study as conditions of high temperature and pressure; however pressure does not exceed the critical pressure of water. Potential benefits of this approach include: increased onset time before coke formation, lowered

total coke yield and higher overall conversion of heavy products to light products. Also, the process can reduce capital and operating costs as well as reduce environmental impact since the use of a solvent is no longer required and a portion of the bitumen is no longer rejected into tailings. The upgraded bitumen would meet the specifications to be shipped directly to refineries (Kayukawa 2009).

1.2 Research Objectives

The objective of this research thesis is to:

- conduct cracking reactions under hydrothermal conditions and compare the results to studies done under supercritical conditions
- determine the effect of water and fine solids on the onset of coke formation, total coke yield and conversion of Athabasca vacuum tower bottoms
- investigate the effects of thermal cracking bitumen froth at different pressures
- propose a process design to upgrade bitumen-water mixture from current findings of the project and identify areas of the process design where research and data are lacking

CHAPTER 2

LITERATURE REVIEW

2.1 Overview of Thermal Cracking of Bitumen

In conventional bitumen thermal cracking processes, the objective is to decompose large molecules of bitumen into smaller molecules by breaking bonds to give lighter products (Gray 2014). This is achieved by the cleaving of carbon-carbon bonds through free radical chain reactions (Gray and McCaffrey 2002; Gray 2014). A temperature of at least 420°C is required in thermal cracking processes without the use of a catalyst. Generally, shorter reaction times at higher temperature equates to longer reaction times at lower temperature (Gray 1994).

The term coke, when used in the petroleum industry, refers to the carbonaceous solids that form from thermal cracking of bitumen. Onset time of coke is defined as the time in which coke begins to form. Formation of coke is due to polymerization of aromatic compounds in bitumen that occurs during thermal treatment (Gray 2014; Wiehe 1993). Coke contains high carbon content and is insoluble in organic solvents such as toluene. Coke is generally an unwanted by product and has little value compared to the other petroleum products. Formation of coke can also foul process equipment by reducing heat transfer, increasing pressure drop, decrease overall liquid yield and deactivate the catalyst (Sankey et al. 1998). Therefore, reducing the amount of coke formed can greatly increase the efficiency of thermal cracking.

There are several ways to approach thermal cracking of bitumen. In general, there are three main commercial thermal cracking and coking processes: delayed coking, fluid coking and visbreaking. These processes differ greatly in the operating parameters such as type of reactor, reactor size, temperature, pressure and mean residence time.

Delayed coking is a semi-batch process with high temperature and long reaction times used to convert the residue fraction of the feed to lighter components and coke. The coke formed is enriched with sulfur, nitrogen and metals relative to the feed (Gray 2014). Typical delayed coking operations involve a semi-batch reactor with large coker drums of diameter 26-29 feet at temperatures of approximately 500°C and cycle times between 12-48 hours (Gary et al. 2007). Feed is sent to a fractionation tower where it is then pumped to a coking heater and heated to 480-500°C before being sent to coker drums. Steam is used in the heater tubes to increase velocity and minimize/delay coke deposition; hence the term delayed coking (Liu 2002). Coke forms in the coker drums and begin filling over 12-48 hour time period. The cracked products exit as vapor to the fractionation tower. Once a coke drum is filled to a certain point, the feed is sent to the other coke drum which has been emptied out. Emptying coke drums are done through high pressure water. Delayed coking is the most widely used among all commercial coking processes (Liu 2002; Wiehe 1993). A delayed coker being operated in Edmonton, Alberta has a coke rejection of 20.5 wt% (Masliyah et al. 2011).

Fluid coking is a continuous process at high temperatures that involves spraying feed into a fluidized coke bed. Fluid coking is operated at higher temperatures, usually at 510-550°C (Gray 2014). Feed is sprayed into the reactor and coking occurs on the surface of the fluidized coke particles. Cracked products leave as vapor through cyclones at the top of the reactor. Cyclones then remove entrained coke particles and the vapor product enters a scrubber. The vapor products are quenched by fresh feed and sent to a fractionator where gas oil is withdrawn and fuel gases are sent to condensers. Back in the reactor, steam is used to strip liquids off the coke particles. Coke passes to a burner where some of the coke is burned to supply heat to the reactor. Coke can be withdrawn from the burner as product coke.

Visbreaking is a short and mild thermal cracking treatment used to reduce the viscosity of the bitumen or residue (Speight 2012). The objective involves reducing the viscosity of bitumen to allow for smoother transportation through pipeline. In the visbreaking process, the oil is sent to a furnace with conditions of 475-500°C, 0.7-5 MPa and a mean residence time of 1-3 minutes (Gray 2014). Long reaction times are avoided in order to ensure coke does not form. During

this treatment, a 5-10% conversion of residue can be achieved. The end result is a 5-10 times reduction in viscosity.

2.2 Effect of Water on Thermal Cracking of Bitumen

In operations for thermal cracking of bitumen, water is typically not present at high concentrations in the feed. Depending on which type of froth treatment is employed, bitumen entering the primary upgrading operations can contain 1.5-2.5 wt% water after naphthenic froth treatment and 100-300 ppmw of water after paraffinic froth treatment (Masliyah et al. 2011). The water rejected during froth treatment is sent to tailings pond for disposal. Thermal cracking of bitumen froth prior to froth treatment is a relatively new concept, however there have been several studies done on thermal cracking of bitumen with water, mainly in the supercritical water regime.

Cheng et al. (2009) found that the amount coke produced from vacuum residue is significantly less in the presence of supercritical water. The total amount of coke formed in a nitrogen atmosphere was many times greater than in supercritical water. The authors reason that coking is a second-order free radical reaction where the asphaltene does not face resistance during mass transfer when there is no water present. However, when there is supercritical water present, the asphaltene is partially dissolved and dispersed in the form of an emulsion. This reduces the asphaltene content for coking. It is interesting to note that the water content in these experiments range from 67 wt% to 80 wt%, which is much higher than any conventional bitumen froth sample. Increasing water content from 67 wt% to 80 wt% increased conversion marginally from 77% to 83%. At such high water-oil ratios, the solvent effect can explain the difference in conversions. Supercritical water has a high diffusivity coefficient and exceptional solubility with many light organic molecules. These properties allow for some components of the oil to freely diffuse and dissolve into the supercritical water, as a result, more liquid product can be produced if more water is present. These effects were also discovered earlier by Siskin and Katritzky (2001).

A related study completed by Morimoto et al. (2010), examined the products from bitumen cracking reactions in three different atmospheres including supercritical water, nitrogen and toluene. Products from nitrogen and supercritical water atmospheres were identical and chemically different from toluene leading to the conclusion that supercritical water does not participate chemically in the reaction. Higher conversion in supercritical water was also discovered and attributed to the solvent effect. Morimoto et al. (2014) completed another study examining the solvent effect of water on treatment of heavy oil with supercritical water. It was proposed that supercritical water keeps the components of heavy fractions in a dispersed state thus preventing recombination reactions. Supporting this conclusion was a comparison of the products from reaction with supercritical to products from the reaction with nitrogen atmosphere and it was found that reaction in supercritical water produced lower molecular weight compounds.

Zhao et al. (2006) examined the effect of temperature, pressure and reaction time on vacuum residue upgrading in supercritical water. The experiments were run at 23-27 MPa for 1 hour using H₂O:VR of 0.78:1 and 2:1 on a weight basis. SARA (saturates aromatics resins asphaltenes) analysis was done on the products leading to the conclusion that increasing temperature or reaction time increased saturate content as well as coke yield. The content of aromatics, resins and asphaltenes all decreased substantially due to being converted into saturates. Pressure changes in the range of 23-27 MPa had negligible effects on composition.

Though a majority of the studies that were done simply used water, Gregoli et al. (1989) determined that cracking bitumen in the presence of brine at supercritical conditions yielded lighter products with lower viscosity than without brine. Brine was determined to be effective at concentrations between 20-40 wt% of the mixture. The use of brine for thermal cracking of bitumen was not pursued further likely due to the fact that salts such as chloride can react with water to form hydrochlorides which can corrode process equipment thus eliminating the practicability of using brine (Zhao 2013).

A summary of the results from studies done on bitumen or vacuum residue cracking with water is given in Table 2.1. Studies completed in the supercritical regime of water are listed with

bolded text. From examination of the table, it can be concluded that a majority of the studies support the use of supercritical water in thermal cracking of both bitumen and vacuum residue. The studies generally favour higher amounts of water than oil in the cracking process. Many benefits are observed, including reduced coke yield, lower viscosity, increased conversion and reduced metal content.

Table 2.1 Summary of literary findings from thermal cracking of bitumen or vacuum residue with water

Author(s)	Feed	Water:Oil (wt)	Temp. (°C)	Pressure (MPa)	Reaction Time	Benefits
Berkowitz et al. (2011)	Heavy Oil	Undisclosed	300-450	4-21	25s-10min	Reduced Coke Yield, Lower Viscosity
Cheng et al. (2009)	Vacuum Residue	2:1 to 4:1	380-420	25-27	1 hour	Reduced Coke Yield, Increased Conversion
Gregoli et al. (1989)	Bitumen	1:4 to 2:3 of Brine*	380-490	23-25	0.25-2.5 hours	Lower Viscosity, Increased Conversion
He at al. (2008)	Bitumen	1:1 to 2:1	374-400	23-28	20-40 mins	Lower Viscosity, Increased Conversion
Morimoto et al. (2010)	Bitumen	2:1	420-450	27-30	0.5-2 hours	Reduced Coke Yield, Increased Conversion
Zhao et al. (2006)	Vacuum Residue	0.8:1 to 4:1	380-460	23-27	1 hour	Increased Conversion, Reduced Metals and Nitrogen in Product

2.2.1 Water Solubility in Bitumen

Water solubility in bitumen is an issue that needs to be considered when designing and operating an upgrader containing significant amounts of water (Brunner 1990). Water solubility in bitumen, especially in and near the supercritical region, is an area lacking much research and data (Amani et al. 2013). The Peng-Robinson equation of state is traditionally used for hydrocarbons and nonpolar materials, but modelling water solubility in bitumen using Peng-Robinson may not be accurate. Other alternatives such as a correlation found in the API Technical Data Book (1997) can be used to estimate solubility of water in low molecular weight hydrocarbons; however, bitumen contains many high molecular weight compounds. Another difficulty found in developing models for water-bitumen solubility is that bitumen contains a large mix of components that are not well defined.

Amani (2014) investigated phase behaviour of bitumen-water mixtures at near critical water conditions. Two separate models were developed to calculate the solubility of water in hydrocarbon-rich phase, w_w , based on solubility data from experiments.

The first model termed Model A, is used for water solubility in hydrocarbons up to the critical point of water which is 374°C. The correlation, Equation 2-1, relates w_w to hydrogen weight fraction, H_{wt} , boiling temperature of the hydrocarbon, T_b , and system temperature, T . The parameters for Model A are provided on Table 2.2. Model A yields reliable results for the temperature range of 0°C to 374°C which makes it unsuitable for modeling of thermal cracking reactions.

$$\ln(w_w) = (a_1T_b + b_1H_{wt} + c_1)\frac{1}{T} + (a_2T_b + b_2H_{wt} + c_2)\ln(T) + (a_3T_b + b_3H_{wt} + c_3) \quad (2-1)$$

Table 2.2 Parameters for Model A (Amani 2014)

Subcript	a	b	c
1	1.188×10^1	$-3.914 \times 10^4 (\text{K})$	$2.933 \times 10^3 (\text{K})$
2	$2.758 \times 10^{-2} (\text{K}^{-1})$	-7.232×10^1	1.477×10^1
3	$-1.998 \times 10^{-1} (\text{K}^{-1})$	5.202×10^2	-9.917×10^1

The second model from Amani (2014), Model B, is used for water solubility in hydrocarbons above the critical point of water. Model B yields reliable values in the temperature range of 180-430°C. Model B is of interest in bitumen-water upgrading because as discussed earlier in this chapter, generally a temperature above 420°C is required and is well above the critical temperature of water at 374°C. Model B is represented by the following Equations 2-2 to 2-4.

Total pressure, P , of the mixture can be expressed by:

$$P = P_w + P_{bit}^{sat} \quad (2-2)$$

Saturated pressure of bitumen, P_{bit}^{sat} , is assumed to be negligible compared to the partial pressure of water, P_w , making the total pressure of the mixture, the partial pressure of water. The solubility of water in the hydrocarbon-rich phase, w_w , can be related to the partial pressure of water by:

$$P_w = K w_w \quad (2-3)$$

K , the equilibrium constant, is a function of temperature:

$$\ln(K) = \frac{1.8532 * 10^4}{T} + 3.2959 * 10^1 * \ln(T) - 2.3657 * 10^2 \quad (2-4)$$

It is important to be aware that Model B of Amani (2014) is a quadratic extrapolation of experimental data for solubilities above the critical temperature, thus caution should be exercised when using these equations.

2.3 Effect of Solids on Thermal Cracking of Bitumen

Several studies have investigated the effect of bitumen-mineral interactions in thermal cracking. A wide range of benefits have been suggested when solids are present in thermal cracking which include: increase in overall bitumen conversion, induction time before coke formation, and reduced coke yield. Similar to the case of water content, for solids depending on the type of froth treatment used, bitumen entering the primary upgrading operations can contain 0.4-0.8 wt% solids after naphthenic froth treatment and 500-800 ppmw solids after paraffinic froth treatment (Masliyah et al. 2011). The rejected solids are sent to tailings pond for disposal.

Tanabe and Gray (1997) studied the role of fine solids in the coking of vacuum residue by examining coke yield with and without solids. Experiments performed using vacuum residue that contained residual solids had an induction time prior to noticeable coke formation. When solids were removed from the vacuum residue, almost no induction time before coke formation was observed. The induction time is attributed to fine solids helping disperse coke-precursors at reactor conditions preventing agglomeration and causing altering of the ratio of coke formation. In the study done by Bi et al. (2007), it was found that the deposition of coke on solids prevented coke layers from accumulating. Hydrophobic fine carbon solids were added in the coking of Arab heavy-residue. Coke was deposited on the surfaces of the hydrophobic carbon fines and prevented agglomeration of coke. Kaolinite is one of the major clay minerals that are present in fine solids from bitumen (Kaminsky et al. 2009; Osacky et al. 2013). Rahimi et al. (1999) contends that kaolinite clay can impede merging of the coke mesophase as compared to illite and montmorillonite. Mesophase coke, formed by irreversible polymerization of asphaltene components (Bagheri 2012), is prevented from agglomerating due to the presence of kaolinite clay and its hydrophilicity (Rahimi et al. 1999).

Liu (2002) investigated the effect of solids on coke formation from bitumen and vacuum residue 524°C+. Solids free bitumen was found to produce coke immediately at the beginning of the reaction while whole bitumen with solids had an induction time of 10-15 minutes before coke was formed. The effect of removing solids is more profound in vacuum residue than bitumen.

One explanation for lower coke yield is because coke molecules contains substantial amount of side chains and aliphatic bridges which undergo cracking reactions. Coke coated on solid surfaces enhances the release of cracking products since the solid surface provides larger mass transfer area and shorter mass transfer path. An important finding from Liu is that the concentration of fine solids from 0.5 to 2.0 wt% did not change the ultimate coke yield, implying that these effects may occur only at the start of the reaction. Higher concentrations of solids in the range of 2.0 to 10.0 wt% should be studied in order to confirm this conclusion.

Sanaie et al. (2001) found that adding native clays to bitumen decreased the amount of coke formation. Experiments were performed with added solids at 1 wt%, 2 wt% and 4 wt%. Increased solids concentration in the reactor decreased the coke yield but no effects were seen on volatiles formation. As an additional benefit, Sankey et al. (1998) contends that coke formed during reaction is deposited on the surface of the solids rather than on equipment. The allowable conversion is increased because if coke was formed on the surface of process equipment, heat transfer would be reduced and pressure drop would occur. Supporting this conclusion is the work of Fan et al. (2004), who examined the catalytic effects of rock and clay minerals in a heavy oil-water thermal cracking system. It was found that minerals decreased viscosity and average molecular weight of the product with water present. The benefit is attributed to formation of highly acidic sites that enhance hydrolysis reactions which are responsible for changes in the crude oil.

Zhao (2013) sought to characterize fine solids before and after hydrothermal reaction. After reaction, fine solids no longer stabilized emulsions and became oil-wet. This result confirms the finding from Van Den Berg et al. (2004) who discovered breaking oil-water emulsions was possible through raising the temperature. Zhao (2013) then completed FBRM (focused beam reflectance measurement) tests to examine particle size and determined that fine solids particle size increased after reaction which contributed to an increase in filterability of the solids. These changes in fine solid properties allow for solids to be easily removed from filtration thus allowing for thermal cracking of bitumen with residual water and solids to be a practical consideration.

2.4 Proposed Approaches to Upgrading Bitumen-Water Mixtures in Literature

There have been several proposals on how to upgrade bitumen-water mixtures. Kayukawa (2009) of JGC Corporation proposes using water at supercritical conditions to partially upgrade the bitumen and produce a high yield sour crude oil. Reactors with conditions of 480°C and 30 MPa are suggested. The proposed scheme implicitly stops reaction at a mean residence time, or reaction severity, before coke is formed. The results from the bench scale apparatus discovered that 60% of the vacuum residue from the feedstock bitumen was converted to distillates and vacuum gas oils. A suggested implementation of the idea involves integration with a thermal recovery process such as SAGD (steam-assisted gravity drainage) process as shown in Figure 2.1. A mixture of oil and water is recovered in a SAGD process (Edmunds et al. 1994). Bitumen and a portion of the water can easily be sent to a supercritical water cracking facilities for upgrading. A sour synthetic crude oil can be recovered, and the heavy residue fraction is sent to SAGD boiler facilities for use in steam generation. Leftover water can be drained back into an empty SAGD reservoir. Benefits compared to conventional thermal cracking include: inexpensive process since no hydrogen, natural gas or catalyst are required, much simpler process compared to delayed coking and lower capital as well as operating costs.

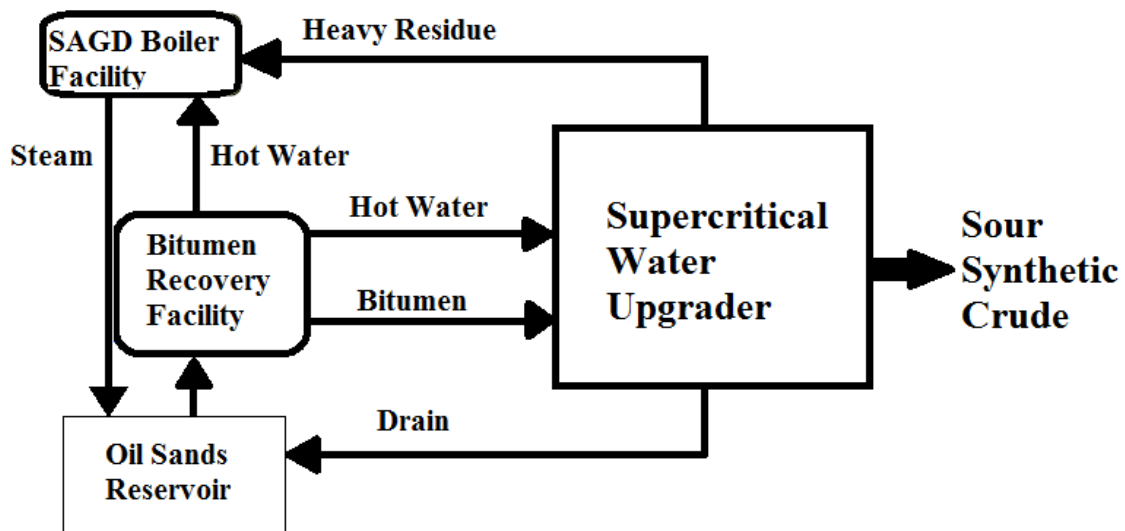

Figure 2.1 Proposed SAGD and partial upgrading facility (Modified from Kayukawa 2009)

Others such as Berkowitz et al. (2011), Nagamatsu et al. (2011) and He et al. (2008) have also suggested similar processes involving supercritical water at high water:bitumen ratios for use in thermal cracking of bitumen. However, there is a lack in literature for processes using subcritical water and at low water concentrations (<25 wt%).

CHAPTER 3

EXPERIMENTAL METHODS

3.1 Chemicals and Materials

The chemicals and materials used to complete the batch microreactor experiments are listed in Table 3.1. The chemical and materials used in standard characterization techniques such as X-ray diffraction analysis or Simulated Distillation were carried out according to standard procedures and thus not listed in Table 3.1.

Two types of feed are used in these experiments, Athabasca vacuum tower bottoms and Athabasca bitumen froth. Vacuum tower bottoms contain some fine solids of which the content is to be determined. Bitumen froth contains water and fine solids that also need to be determined for each batch of sample.

Toluene is used as an extraction solvent during removal of materials from microreactor.

Milli-Q water is used during the addition of water to vacuum tower bottoms.

Nitrogen gas is used to purge reactors and provide an inert atmosphere.

Stainless steel microreactors with 15 mL internal volume are used in the experiments. The microreactor has a pressure rating of 33 MPa at room temperature and 30 MPa at 410°C.

Table 3.1 List of chemical and materials used in microreactor experiments

Chemical/Material	Details
Athabasca Vacuum Tower Bottoms	Obtained from Cold Lake, Alberta (courtesy of Syncrude), contains 2.0 wt% fine solids after measurements
Athabasca Bitumen Froth	Obtained from Devon, Alberta (courtesy of Imperial Oil), contains 10 wt% water and 3.3 wt% fine solids after measurements
Filter Paper 0.22 μm	Durapore® membrane filter
Milli-Q Water	Obtained from Millipore system
Nitrogen Gas	Obtained from PRAXAIR Canada Inc., Ultra High Purity
Stainless Steel Microreactor	Assembled by and ordered from Swagelok, 15 mL volume
Toluene	Obtained from Fisher Scientific, Certified ACS

3.2 Feed Characterization and Analysis

3.2.1 Analysis and Characterization of Vacuum Tower Bottoms

The vacuum tower bottom feed is known to contain fine solids. In order to determine the solid content in the feed, 3g of vacuum tower bottoms was diluted with 150 mL of toluene and mixed for 3 hours. After the vacuum tower bottoms have completely dissolved, it is sent through a vacuum filtration unit with 0.22 μm filter paper. The content collected on the filter paper is considered the fine solids in the vacuum tower bottoms. This procedure was repeated 3 times to ensure accuracy of the number. The average fine solids content in the 3 runs was 2.0 wt%. The fine solids collected through this method was enough for use in elemental analysis. A VARIOMICRO Elemental Analyzer was used to obtain carbon, hydrogen and sulfur content.

In order to determine the mineral composition in the feed, 1 gram of solids is required for X-ray diffraction (XRD) analysis. Approximately 50 grams of vacuum tower bottoms was diluted with 500 mL of toluene and mixed for 3 hours. After the vacuum tower bottoms have completely dissolved, it is placed in a centrifuge operated at 30 000 RCF for 20 minutes. The supernatant was disposed of and the sediments were diluted with toluene once again. This process is repeated until the supernatant was clear. The sediment collected was dried in an oven to evaporate remaining solvent. The solids remaining were subject to XRD analysis to obtain mineral composition.

3.2.2 Analysis and Characterization of Bitumen Froth

In order to determine water content in the bitumen froth, Dean-Stark analysis was completed on a sample of froth. A large sample of approximately 60 grams was used to minimize the effect of experimental deviations, the water content was determined to be 10 wt%.

The procedure used in determining fine solids content in the vacuum tower bottoms could not be repeated for bitumen froth because it was not filterable even at a higher dilution. The solid

content was determined by the centrifuge procedure identical to the isolating of solids in vacuum tower bottoms for XRD analysis. The bitumen froth solids collected through this method had an average of 3.3 wt% from 3 runs. The solids collected were analyzed for mineral composition as well as elemental analysis.

3.3 Microreactor Sand Bath Experiments

In order to investigate the onset time of coke formation as well as total coke yield, a batch microreactor experiment setup is used. The main goals of the batch microreactor experiments are to determine to what extent water, solids and pressure affect coke formation, coke yield and overall conversion to light products.

To determine the effect of water on coke formation and yield, a base case of pure vacuum tower bottoms is used which contains no water. Two separate cases of water addition were carefully considered. Experiments from literature have typically used high water content of over 50 wt%. On a related note, bitumen froth is known to contain water content from 10-30 wt% (Gray 2014, Masliyah et al. 2011). In order to achieve the objective in this study, lower water content in the range of bitumen froth is used. A water content of 17.4 wt% and 33.3 wt% were used which gave VMGSim estimated pressures of 13 MPa and 23 MPa respectively. One case is in the desired operating pressure range and the other is in the supercritical range. The method used to estimate pressures from VMGSim is discussed in later sections.

For the effect of solids on coke formation and yield, solids are removed from vacuum tower bottoms prior to reaction. As discussed earlier in the chapter, vacuum tower bottoms contain 2.0 wt% solids. An additional case where water is added to solid free vacuum tower bottoms is used to determine if removing solids when water is present will still retain the effects if any.

The second feed used in this study is bitumen froth which contains 10 wt% water and 3.3 wt% solids. In order to investigate the effect of pressure, two cases were introduced for this series of experiments. The first case, or base case, involves purging the microreactor with nitrogen and leaving it at atmospheric pressure prior to heating in the sand bath. The VMGSim calculated

pressure for this case is 6.9 MPa at 410°C. The second case involves pressurizing the microreactor with nitrogen gas prior to heating in the sand bath. Pressurizing the microreactor to 5 MPa at room temperature corresponds to a 17 MPa pressure at 410°C, calculated from VMGSim.

The general procedure used for the microreactor batch reactions involves weighing out approximately 3 grams of feed placing it into a 15mL stainless steel microreactor. Milli-Q water is also added to the applicable experimental runs. Lubrication is applied and the microreactor is then tightly sealed. The microreactor is brought to a nitrogen gas cylinder for a leak test. The leak test is done with pressures of up to 16 MPa to ensure that it does not leak during reaction. After the check it is purged three times to remove air and fill it with nitrogen. The microreactor is then completely closed and brought to the sand bath. The sand bath is adjusted to the desired temperature and the microreactor is attached to the agitator where it is immersed in the sand bath. The agitator is turned on and the microreactor is left for the desired reaction time. The reactor is then removed from the sand bath and left to cool to room temperature by ambience for 12 or more hours. The reason the microreactor is left to cool through ambient air is to preserve the durability of the reactor for multiple usages. After cooling, the gas is vented and the liquid and solid products are extracted using toluene for analysis.

Some assumptions made are:

- no leakage in the microreactor because it is leak tested at high pressures and used at conditions well under manufacturer specified limits.
- though most of tubing is not immersed in the sand bath, it is assumed that the whole mixture is at the same conditions. Volume of the tubing is negligible because compared to the rest of the reactor, the volume is approximately 1% of the total volume.

3.3.1 Experimental Conditions

3.3.1.1 Temperature Selection

Temperature is a key variable in these experiments. A range of temperatures were considered from 400°C to 440°C. Choosing a higher temperature caused the sand bath to drop drastically in temperature once the reactor was immersed. Also the temperature in the sand bath recovers much slower at high temperatures. As discussed in Chapter 2, generally a temperature around 420°C is required for useful thermal cracking rates so choosing a lower temperature may not give the desired cracking conditions. Also the reactor may not reach the desired pressure. With all things considered, a reaction temperature of 410°C was chosen.

3.3.1.2 Pressure Estimations and Calculations

Due to the conditions of the experiment and the setup, pressure cannot be accurately measured. All microreactor pressures reported in this study are estimations based on VMGSim.

The microreactors used in the experiments have a pressure rating of 30 MPa at 410°C after de-rating. Since each microreactor was expected to be used multiple times and sand bath temperature may fluctuate a few degrees over the set point, a maximum pressure of 25 MPa was decided to be a safe operating limit.

In the pressure estimation calculations, an additional case is used for safety purposes. A worst case scenario is considered where the underlying assumption is that the water and nitrogen are completely insoluble in bitumen and vacuum tower bottoms. The result is higher pressure estimation than the original estimated pressure using VMGSim solubility estimations. This can cause safety concerns if VMGSim grossly underestimates the pressure inside the reactor and the actual pressure exceeds the safety limit. As a result, the highest pressure experimental case for both bitumen and vacuum tower bottoms were calculated for worst case scenario.

In order for VMGSim to estimate the properties of oil, a boiling curve must be inputted into the software. An Athabasca vacuum tower bottoms boiling point curve was obtained from

McFarlane (2007) and used in VMGSim for preliminary estimations until an experimental boiling point curve could be obtained. Similarly for bitumen, a boiling point table was obtained from Gray (2014) and used in VMGSim for pressure estimations for bitumen froth. The respective boiling point curves can be observed in Appendix A.

Since the reactions in this experimental study are batch and VMGSim generally operates assuming continuous flow, a different method had to be used to estimate pressures. An input of 3.0 grams of VTB contains a certain volume. The remaining volume of the reactor is assumed to be nitrogen so the mass of nitrogen in the reactor can be calculated. After heating to reaction temperature, the VTB and nitrogen expand consequently causing pressure to increase. By iterating the pressure until the reactor volume of 15 mL matches with the total product volume, the reactor pressure can be determined. Similarly, the pressure for cases with added water or even bitumen froth can be calculated using the same procedure. An input feed of bitumen + water or VTB + water will have a certain volume at room temperature. The rest of the volume is nitrogen and the pressure can once again be iterated until the final product volume matches the actual reactor volume. A summary of the pressures for all of the experimental cases can be seen on Table 3.2. As discussed earlier in the experimental design, pressures of 13 and 23 MPa for VTB with 17 and 33 wt% water respectively. Pressures of 6.9 and 17.5 MPa for bitumen froth and bitumen froth pressurized respectively.

Table 3.2 VMGSim estimated pressure for each experimental case

Experimental Case	VMGSim Estimated Pressure (MPa)
VTB	0.25
VTB + 17 wt% water	13
VTB + 33 wt% water	23
VTB solids removed	0.25
VTB solids removed + 17% water	13
Bitumen Froth	6.9
Bitumen Froth Pressurized	17.5

Calculation of pressures in worst case scenario assumes that water and nitrogen is completely immiscible with the vacuum tower bottoms and bitumen. The key difference to the previous pressure calculation is that the streams are no longer combined. Three separate streams each being individually pressurized and heated as opposed to a combined stream. However, the pressure of the reactor is still determined in the same way and all the final product stream pressures are iterated until their combined volume matches the actual reactor volume. The obtained pressures are shown on Table 3.3. The VTB + 33 wt% water has an increased pressure of 0.5 MPa and the bitumen froth pressurized is increased by 1 MPa but both are still below the safety limit.

Table 3.3 VMGSim worst case pressure for high pressure experimental cases

Experimental Case	VMGSim Estimated Pressure (MPa)
VTB + 33 wt% water	23.5
Bitumen Froth Pressurized	18.5

3.3.1.3 Reaction Time

Reaction time in a batch reactor is an important variable that will differ on a case to case basis. Different feeds such as bitumen and vacuum tower bottoms can have significantly different onset of coke times. Reaction times reported in this study starts when the microreactor is dropped into sand bath and ends when it is pulled out. The experimental approach used was to start off with short reaction times to ensure that there was no coke formation. After a reaction time where no coke was formed has been found, maintain small increments of 5 minutes to catch the onset of coke formation. After the onset of coke formation, generally 2-3 more reactions with reaction times past the onset of coke formation are completed to obtain coke yield data for linear correlation purposes.

3.3.2 Coke and Fine Solids Yield Measurement

After the microreactor has undergone reaction and cooled down to room temperature, the microreactor is then opened up and the contents diluted with toluene to assist removal from microreactor to a beaker. A vacuum filtration apparatus is then set up with 0.22 μm filter paper. The product is filtered through with fine solids and coke collected on the filter paper. The filter paper is left overnight to dry off the remaining toluene.

Total coke yield can be calculated by:

$$\% \text{ Coke Yield} = \frac{\text{Mass of Solids on Filter Paper} - \text{Mass of Native Solids}}{\text{Mass of Feed} - \text{Mass of Native Solids}} \quad (3-1)$$

3.4 Simulated Distillation for Boiling Point Curve and Conversion

Simulated distillation is a method used to obtain the boiling point curve of mixtures with a wide range of boiling points. Since the feed used in the experiments are relatively heavy, ASTM D-5307 method is used because it is best suitable for heavy mixtures with an IBP (initial boiling point) of 174°C and higher. Simulated distillation was done for key reaction times as well as for the unreacted feed. The products chosen for simulated distillation generally had reaction times before the onset of coke formation.

Conversion is calculated using the following equation:

$$\text{Conversion} = \frac{m_{\text{feed},524+} - m_{\text{product},524+}}{m_{\text{feed},524+}} \quad (3-2)$$

CHAPTER 4

RESULTS AND DISCUSSION

4.1 Feed Composition of Athabasca Vacuum Tower Bottoms

The results of the vacuum tower bottom fine solids elemental analysis for carbon, hydrogen and sulfur content are shown on Table 4.1. The average of the 3 runs for carbon is 18.4 wt%, hydrogen is 2.2 wt% and sulfur is 4.0 wt%.

Table 4.1 Elemental analysis of vacuum tower bottom fine solids

	Weight % with Standard Deviation
Carbon	18.4 ± 0.3
Hydrogen	2.21 ± 0.03
Sulfur	4.00 ± 0.82

The results of the XRD analysis are shown on Figure 4.1 and corresponding mineral content on Table 4.2. Kaolinite and illite clays make up the majority of the mineral composition. Small amounts of non-clays such as pyrrhotite, quartz and siderite are also present.

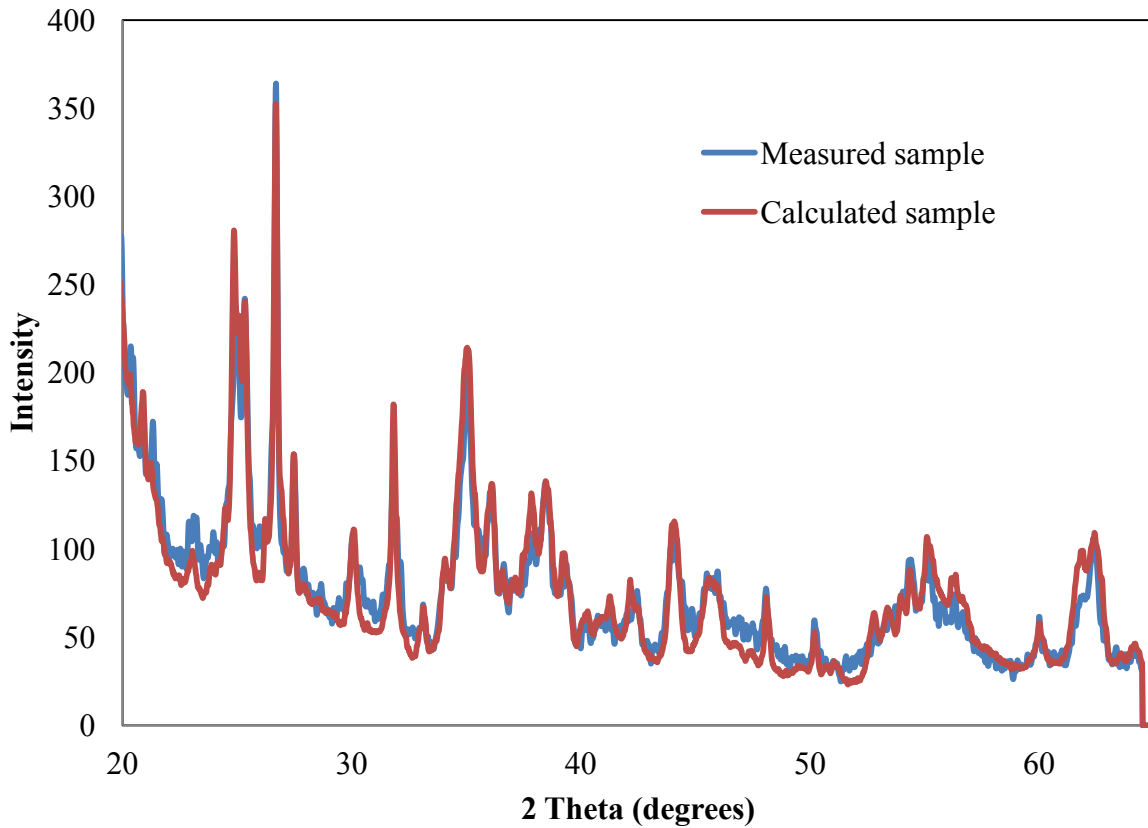

Figure 4.1 X-ray diffraction pattern of fine solids from vacuum tower bottoms

Table 4.2 Mineral content of vacuum tower bottoms obtained from X-ray diffraction

Mineral	Weight %
NON-CLAYS	
Quartz	3.6
Siderite	3.6
Pyrite	0.4
Anatase	1.3
Rutile	1.9
Pyrrhotite	5.2
Total non-clays	16
CLAYS	
Kaolinite	39.4
Illite	44.6
Total clays	84
TOTAL	100

4.2 Feed Composition of Athabasca Bitumen Froth

The results of the elemental analysis on the bitumen froth solids are disclosed in Table 4.3. The bitumen froth solids contain 17.5 wt% carbon, 1.9 wt% hydrogen and 4.6 wt% sulfur based on the average of 3 repeat runs. These values are consistent with Liu (2002) who used a similar Athabasca bitumen feed.

Table 4.3 Elemental analysis of bitumen froth fine solids

	Weight % with Standard Deviation
Carbon	17.5 ± 0.0
Hydrogen	1.89 ± 0.02
Sulfur	4.57 ± 0.08

Figure 4.2 shows X-ray diffraction pattern obtained from bitumen froth solids and corresponding mineral content on Table 4.4. Siderite, kaolinite and illite make up for the majority of the mineral composition. These results are comparable to what is seen by Zhao (2013) who used a similar feed.

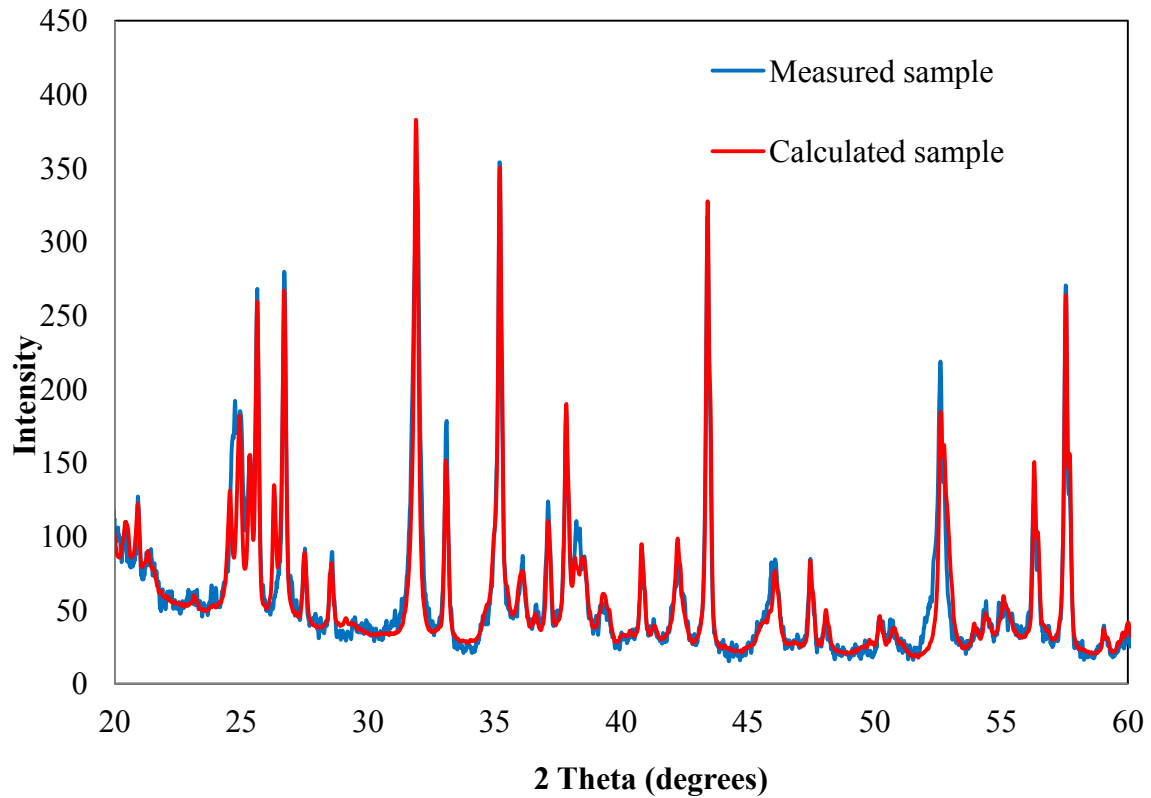

Figure 4.2 X-ray diffraction pattern of fine solids from bitumen froth

Table 4.4 Mineral content of bitumen froth fine solids obtained from X-ray diffraction

Mineral	Weight %
NON-CLAYS	
Quartz	5
Siderite	20
Pyrite	6
Anatase	2
Rutile	2
Total non-clays	35
CLAYS	
Kaolinite	34
Illite	31
Total clays	65
TOTAL	100

4.3 Temperature Profile of Microreactor in Sandbath

The temperature inside the reactor was measured using a thermocouple. There is a temperature difference of 5°C between the internal reactor and the sand bath set point temperature. All temperature values reported in this study are the measured internal reactor temperature. The resulting temperature profile is shown on Figure 4.3. From the moment the reactor is immersed in the sand bath, it takes 100 seconds for the reactor to reach 350°C and 267 seconds to reach 400°C. For the reactor to reach the maximum temperature of 410°C, approximately 10 minutes are required. For cooling of the reactor after removal from sand bath, around 120 seconds are needed for temperature to cool below 400°C and 220 seconds to cool below 350°C.

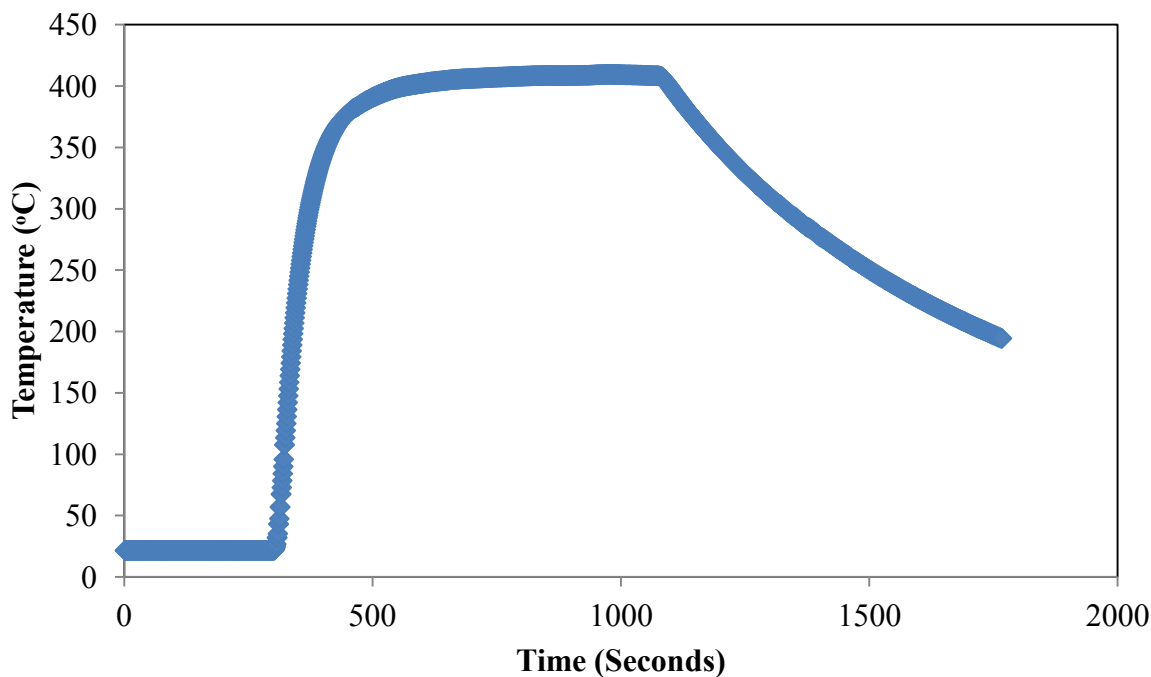

Figure 4.3 Temperature profile of microreactor immersed in the sand bath setup

4.4 Onset of Coke Formation for Athabasca Vacuum Tower Bottoms with Varying Content of Water

Figures 4.4 to 4.6 show the coke and fine solids yield from Athabasca vacuum tower bottoms (VTB) as a function of time for 0.0 wt%, 17.4 wt% and 33.3 wt% content of water respectively. The VMGSim estimated pressure for the three cases are 0.25 MPa, 13 MPa and 23 MPa respectively. The amount of fine solids in the initial vacuum tower bottoms is approximately 2.0 wt%, shown by a horizontal line in each of the aforementioned figures. Yield values that are above this line are considered to be the mass of toluene-insoluble material, or coke, formed after reaction. The standard deviation from a minimum 3 replicates at times where coke was formed is shown on each figure. The data shows strong repeatability of the experiments for reaction times before and near the onset time of coking with standard deviation of roughly +/- 0.2%. After coke formation occurred, the standard deviation increased to +/- 1%.

The data of Figure 4.4 show that for 0.0 wt% water content that there is no appreciable amount of coke until reaction time is past 40 minutes. Figure 4.5 shows a slightly different result in the presence of 17.4 wt% water, where no appreciable amount of coke is formed until past the 45 minute point. In Figure 4.6, a considerable amount of coke is formed at 40 minutes with the presence of 33.3 wt% water. These results suggest that water may affect the onset of coke formation, but significance of the effect is dependent on the amount of water. Detailed statistical analysis is completed in order to quantitatively define these effects and is discussed in the following sections.

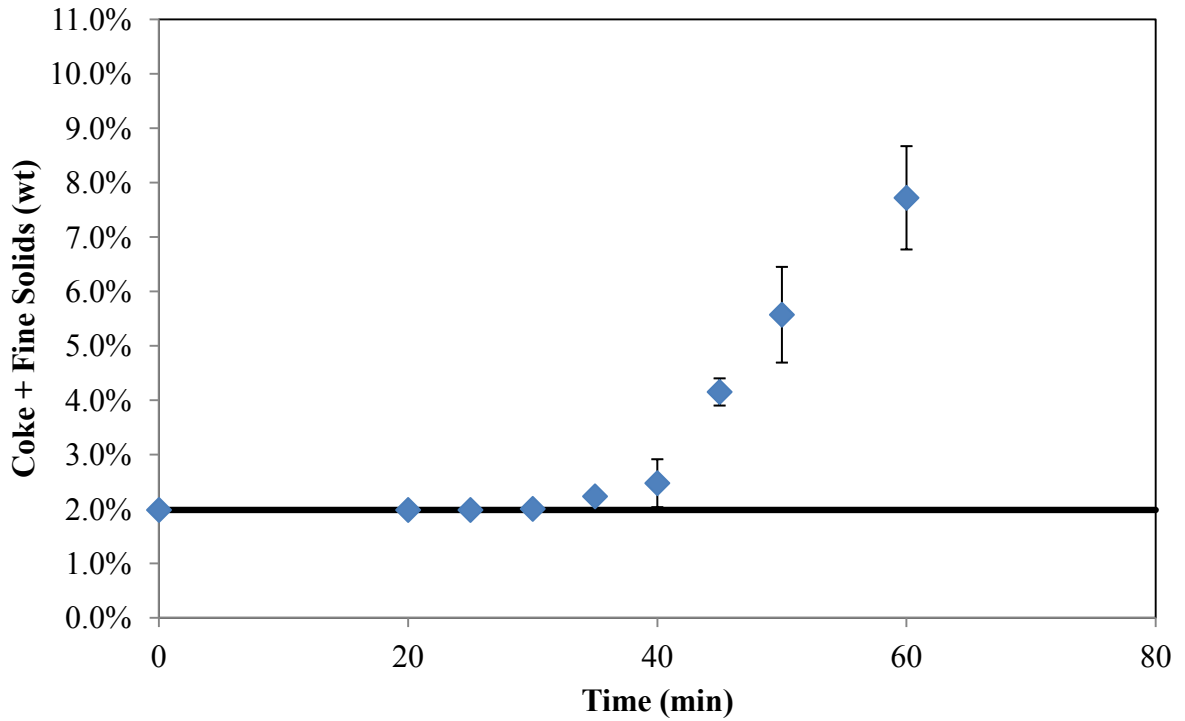

Figure 4.4 Coke and fine solids yielded as a function of time for VTB without addition of water (0.25 MPa)

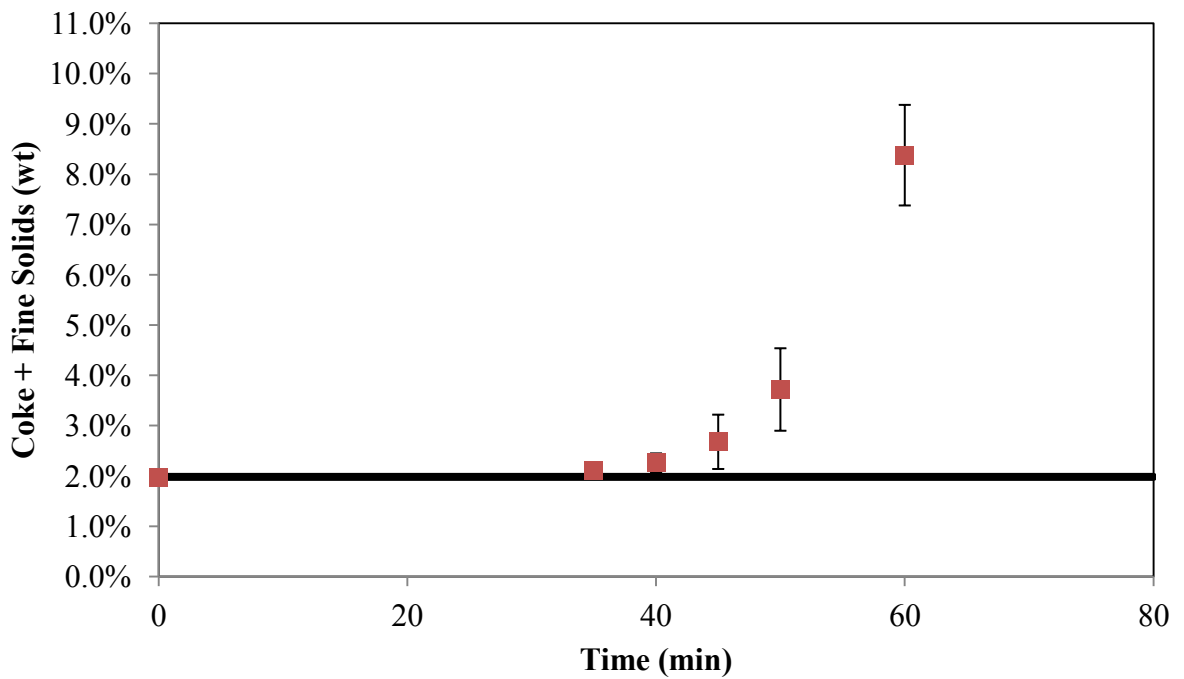

Figure 4.5 Coke and fine solids yielded as a function of time for VTB with 17.4 wt% addition of water (13 MPa)

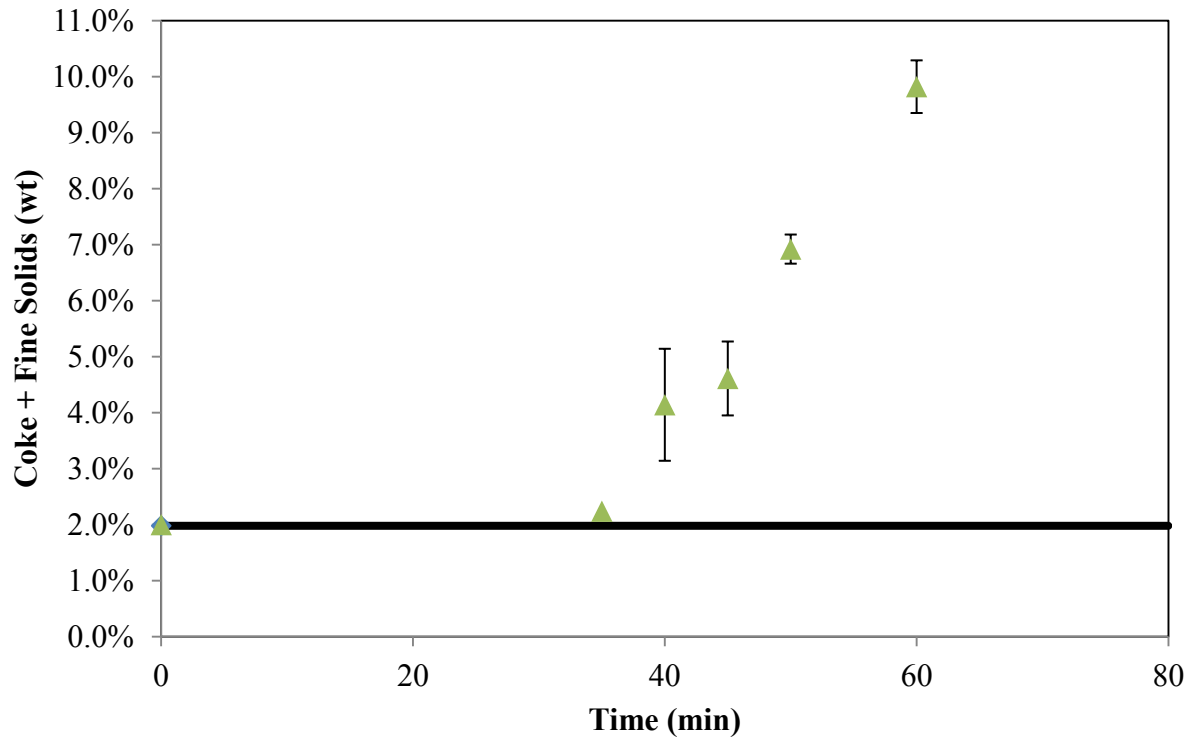

Figure 4.6 Coke and fine solids yielded as a function of time for VTB with 33.3 wt% water (23 MPa)

4.5 Determining Coke Onset Time for Athabasca Vacuum Tower Bottoms Through Linear Regression

When coke yield is plotted as a function of time, it generally yields an s-shape curve where no coke is formed until it reaches the onset time (Tanabe and Gray 1997; Liu 2002). After reaching the onset point, coke will then form rapidly and eventually level off at a set yield after an extended reaction time. The data presented in Figure 4.7 indicate that the increase in coke yield as a function of time is relatively linear. Although the thermal cracking of bitumen fractions follows first-order kinetics, the data of Figure 4.7 do not exhibit the trends typical of a product of a first order reaction. The formation of coke is significantly delayed after the start of reaction, and its accumulation is relatively linear. This observation is consistent with models for coke formation that suggest a complex combination of reactions and phase behavior is responsible for the appearance of coke (Wiehe, 1993). Consequently, linear regression can be used to estimate the rate of coke formation, and the error bounds on the rate. By extrapolating to zero coke yield, we obtain a systematic estimate of the onset time for coke formation that is more robust than attempting to determine when the total solids content increases from the initial level. A logarithmic plot was considered but ruled out as a suitable estimate for two main reasons. Once coke begins to form, the yield is linear indicating a zero order reaction. The other reason is that there is a significant time delay before the formation of coke; a logarithmic model will be unable to capture this portion because the coke yield was zero.

Figure 4.7 shows an example of a linear regression for vacuum tower bottoms without addition of water. The remaining figures can be found in Appendix A. Using the equation from the fitted linear regression, the onset of coke formation can be back-calculated to determine the time where the regression line intersects 2.0 wt%. Table 4.5 shows the coke onset times as a function of water content calculated from linear regression with 95% confidence estimates. The onset of coke formation times for water contents of 0.0%, 17.4% and 33.3% are 34-40, 39-44 and 30-36 minutes respectively. There is some overlap of the confidence estimates when comparing the case of no water content to both the cases with added water indicating that addition of water at 17.4 wt% and 33.3 wt% does not significantly change coke onset time.

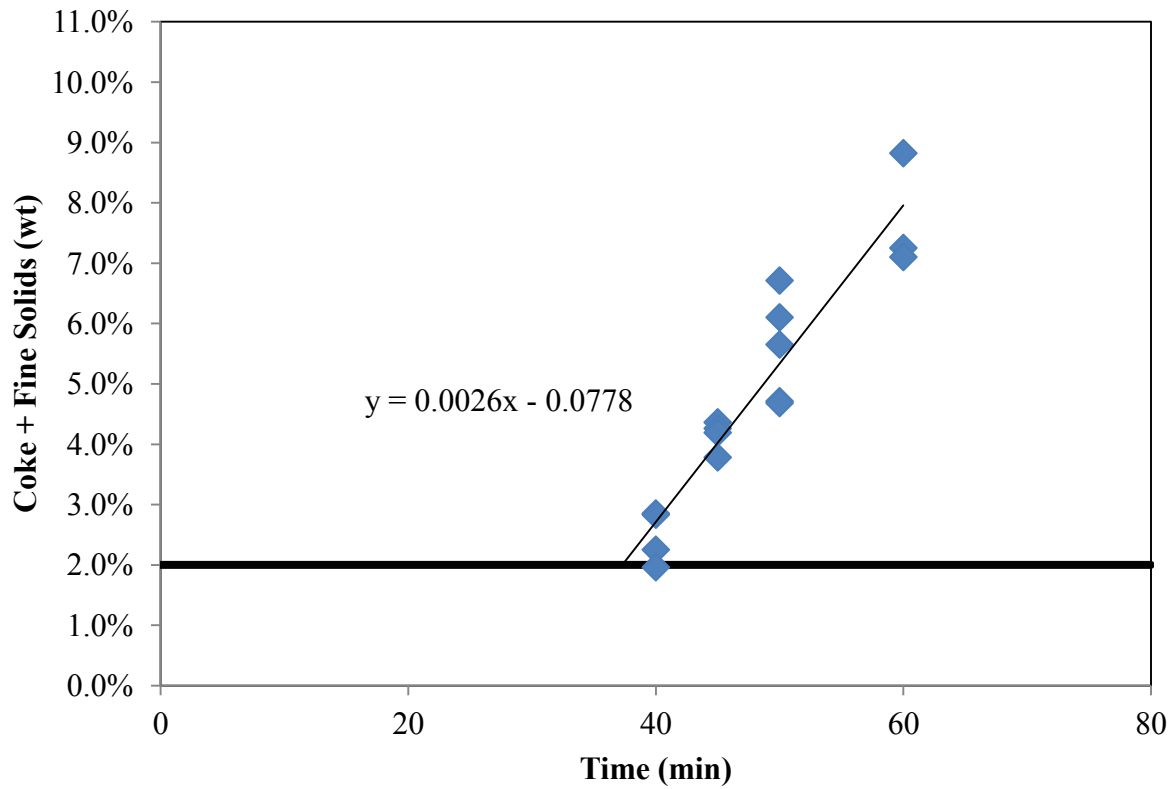

Figure 4.7 Linear regression on coke and fine solids yielded as a function of time for VTB without addition of water

Table 4.5 Coke onset times as a function of water content calculated from linear regression with upper and lower 95% confidence estimates

Water Content (wt%)	Intercept Onset Time (min)	Minimum Estimate of Onset Time to 95% Confidence (min)	Maximum Estimate of Onset Time to 95% Confidence (min)
0.0	37	34	40
17.4	42	39	44
33.3	34	30	36

4.6 Examining the Significance of Water on the Amount of Coke Formed

Average coke and fine solids yield including standard deviation for various water contents at 3 different reaction times where coke has been formed are shown on Table 4.6 to Table 4.8. At a reaction time of 45 minutes, it is observed that having 17.4 wt% of water yields the lowest amount of coke. This same result is also seen at 50 minutes of reaction time. However, at 60 minutes the 17.4 wt% water content case no longer yields the lowest amount of coke but the second lowest. An interesting note is that at a water content of 33.3 wt%, the highest coke yields are obtained at each of the reaction times.

Table 4.6 Yield of coke and fine solids for varying water content at 45 minutes and 410°C

Reaction Time 45 Minutes		
Water Content (mass fraction)	Coke + Fine Solids Yield	Standard Deviation
0.000	4.2%	0.3%
0.174	2.7%	0.5%
0.333	4.6%	0.7%

Table 4.7 Yield of coke and fine solids for varying water content at 50 minutes and 410°C

Reaction Time 50 Minutes		
Water Content (mass fraction)	Coke + Fine Solids Yield	Standard Deviation
0.000	5.6%	0.9%
0.174	3.5%	0.9%
0.333	6.9%	0.3%

Table 4.8 Yield of coke and fine solids for varying water content at 60 minutes and 410°C

Reaction Time 60 Minutes		
Water Content (mass fraction)	Coke + Fine Solids Yield	Standard Deviation
0.000	7.7%	1.0%
0.174	8.4%	1.0%
0.333	9.8%	0.5%

The data of Figure 4.8 show the coke and fine solids yield as a function of water content for 45, 50 and 60 minutes of reaction, showing the same data as in Tables 4.6 to 4.8. At 45 and 50 minute reaction times, the least amount of coke is formed for a water content of 17.4 wt%. This plot suggests that there is a monotonic trend only at a reaction time of 60 minutes. In order to discern the significance of the apparent differences, Table 4.9 shows the P-value for paired t-tests. For 45 minute reaction time, the yield with 17.4 wt% water is statistically different (P-value less than 0.05) from the 0.0 wt% and 33.3 wt% cases implying that the coke yield is at a minimum. This result is repeated at the 50 minute case where 17.4 wt% water is at a minimum and is significantly different than 0.0 wt% and 33.3 wt%. However at 60 minutes, the only result that is statistically significant is between 17.4 wt% and 33.3 wt% water. Based on these calculations of statistical significance, we conclude that 17.4 wt% water gives a lower coke yield than 33.3 wt% water for all reaction times, and lower than 0.0 wt% water for 45 and 50 minute reaction times.

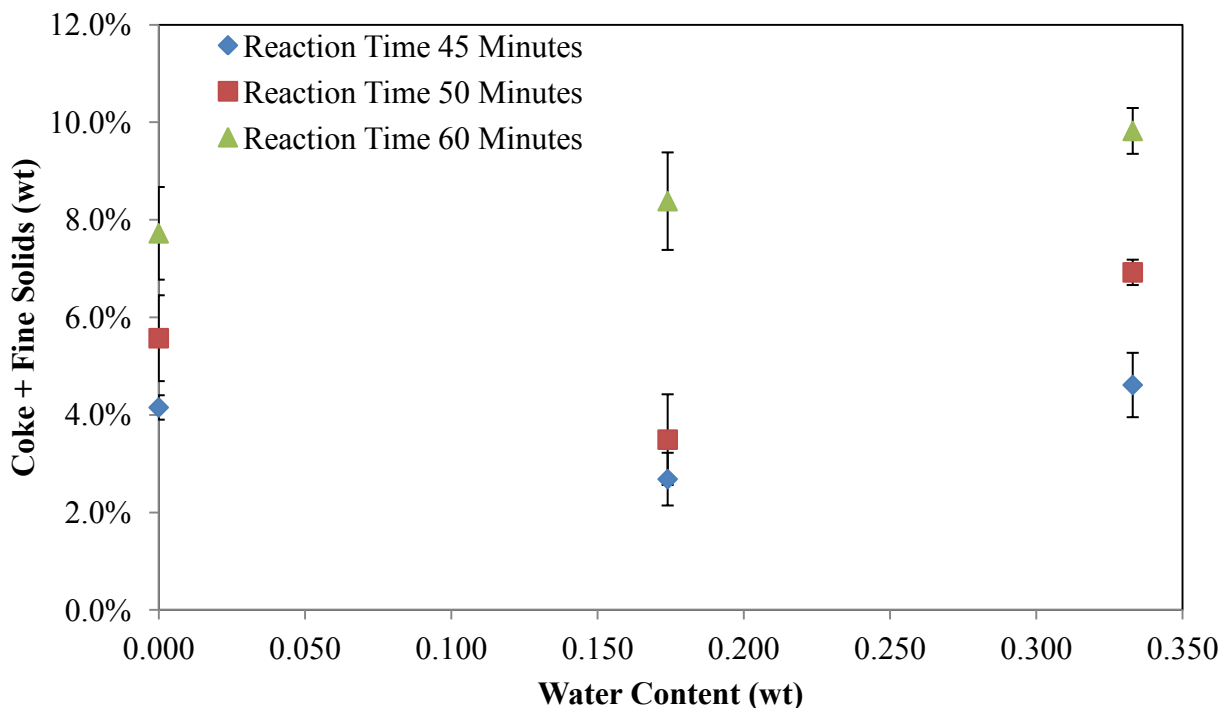

Figure 4.8 Coke and fine solids yielded for VTB as a function of water content at 3 different reaction times

Table 4.9 P-values for paired t-test of coke yield with various water content at 3 different reaction times

Reaction Time 45 Min		Reaction Time 50 Min		Reaction Time 60 Min	
Water Content	P-Value	Water Content	P-Value	Water Content	P-Value
0.000 vs 0.174	0.007	0.000 vs 0.174	0.048	0.000 vs 0.174	0.584
0.000 vs 0.333	0.222	0.000 vs 0.333	0.021	0.000 vs 0.333	0.099
0.174 vs 0.333	0.007	0.174 vs 0.333	0.003	0.174 vs 0.333	0.044

4.7 Testing For Linear Regression in Coke Yield as a Function of Water Content

Table 4.10 shows linear regression statistics for coke yield as a function of water content for reaction times of 45, 50 and 60 minutes. For reaction times of 45 and 50 minutes, there is no significant linear regression because the confidence intervals of the slope encompass a null result of zero slope. However at 60 minutes, there is a linear trend with a positive slope to 95% confidence. Be that as it may, the lack of a consistent trend for the other reaction times suggests that this trend is not robust and will continually shift.

Table 4.10 Slope of linear regression line for coke yield as a function of water content with 95% confidence intervals

Reaction Time 45 min		Reaction Time 50 min		Reaction Time 60 min	
Slope	0.012	Slope	0.038	Slope	0.062
Upper 95% CI	0.060	Upper 95% CI	0.098	Upper 95% CI	0.110
Lower 95% CI	-0.036	Lower 95% CI	-0.022	Lower 95% CI	0.015

4.8 Onset of Coke Formation for Athabasca Vacuum Tower Bottoms (VTB) with and without Solids

Figure 4.9 shows linear regression done on coke yield as a function of time for Athabasca vacuum tower bottoms (VTB) as a function of time for the cases with and without solids. The difference between the two cases is significant. For VTB with solids, coke formation does not occur until 37 minutes of reaction time. In the case of VTB without solids, appreciable amount of coke is formed after just 14 minutes of reaction. Removing the solids from the VTB before reaction greatly shortens the onset time of coke formation.

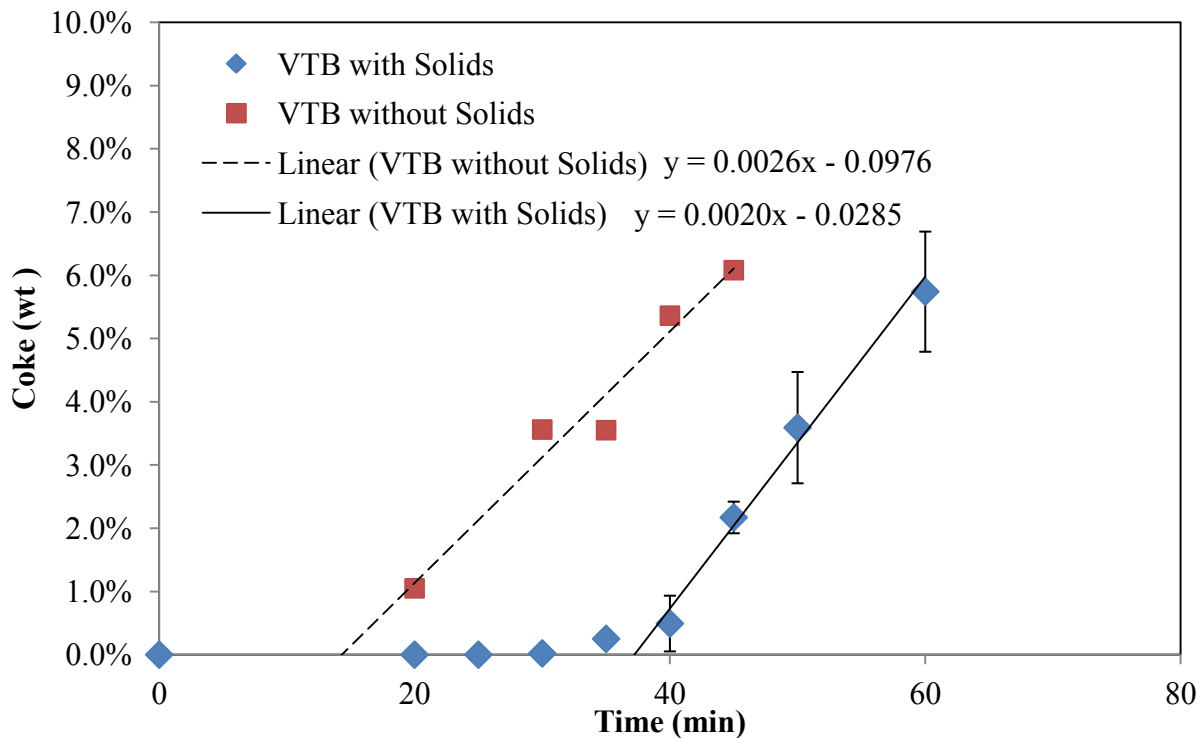

Figure 4.9 Linear regressions on coke yield as a function of time for VTB with and without solids

Figure 4.10 shows linear regression data of coke yield as a function of time for Athabasca vacuum tower bottoms with solids removed for a case with no water, and a case with 17.4 wt% water added. Coke onset time obtained from linear regression is 13.7 minutes with water as compared to 14.2 minutes without added water. The addition of water to solid free VTB did not exhibit any significant changes to the coke onset time. The case with added water, but still solid free, gives a much earlier onset of coke formation similar to the solid free case without water.

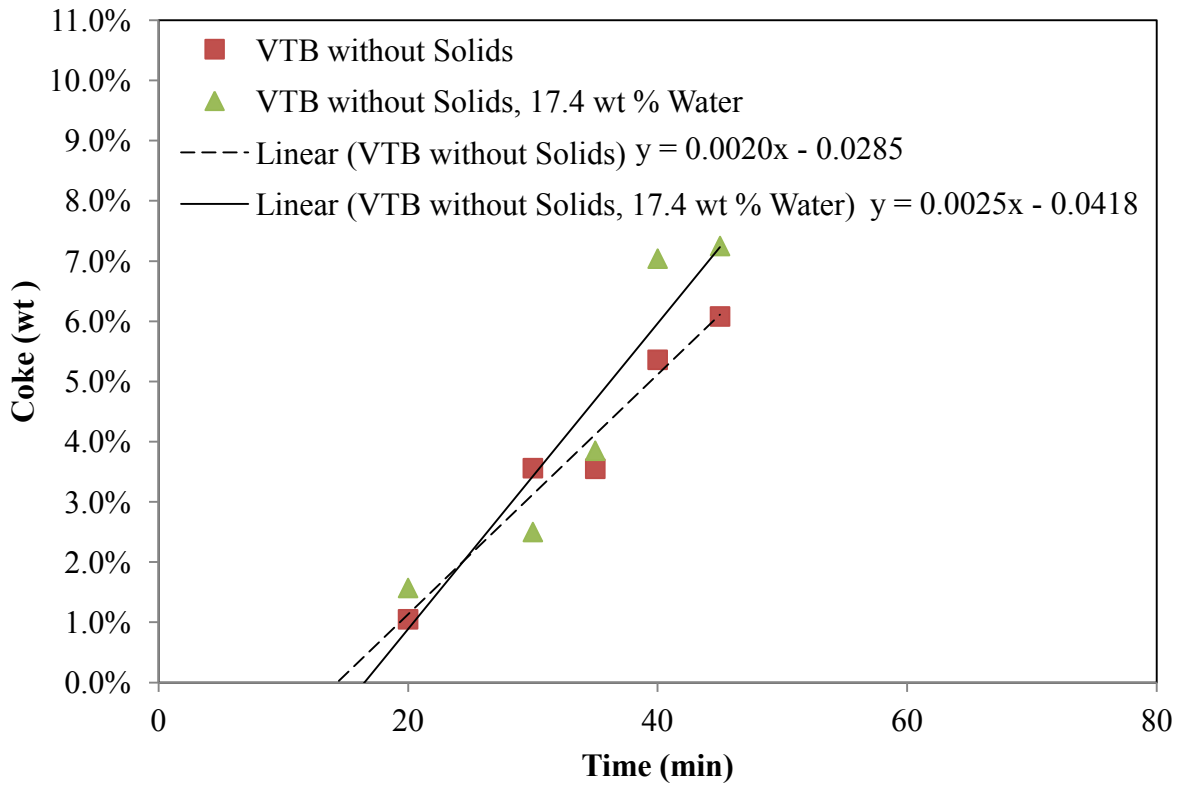

Figure 4.10 Linear regressions on coke yield as a function of time for VTB with solids removed and varying water content

4.9 Onset of Coke Formation for Bitumen Froth

Figures 4.11 and 4.12 show the coke and fine solids yield of Athabasca bitumen froth as a function of time for pressures of 6.9 MPa and 17.5 MPa estimated by VMGSim respectively. Linear regressions of the two data sets are shown in Figure 4.13. The amount of fine solids contained in this sample of bitumen froth is approximately 3.3 wt%, shown by a horizontal line in each figure. Yields of solids after reaction above this line are considered to be the mass of coke formed. The standard deviation from a minimum 3 replicates at times where coke was formed is shown on each figure. The data of Figures 4.11 and 4.12 shows that both cases give no appreciable amount of coke until reaction time approaches 40 minutes. To be more precise, from the linear regression the onset time of coke formation for 6.9 MPa is 38 minutes and for 17.5 MPa is 36 minutes. The amount of coke formed, as well as the onset time for the two different pressures, do not vary significantly and are within error of one another. Pressurizing bitumen froth does not have an impact on coke formation at these pressures.

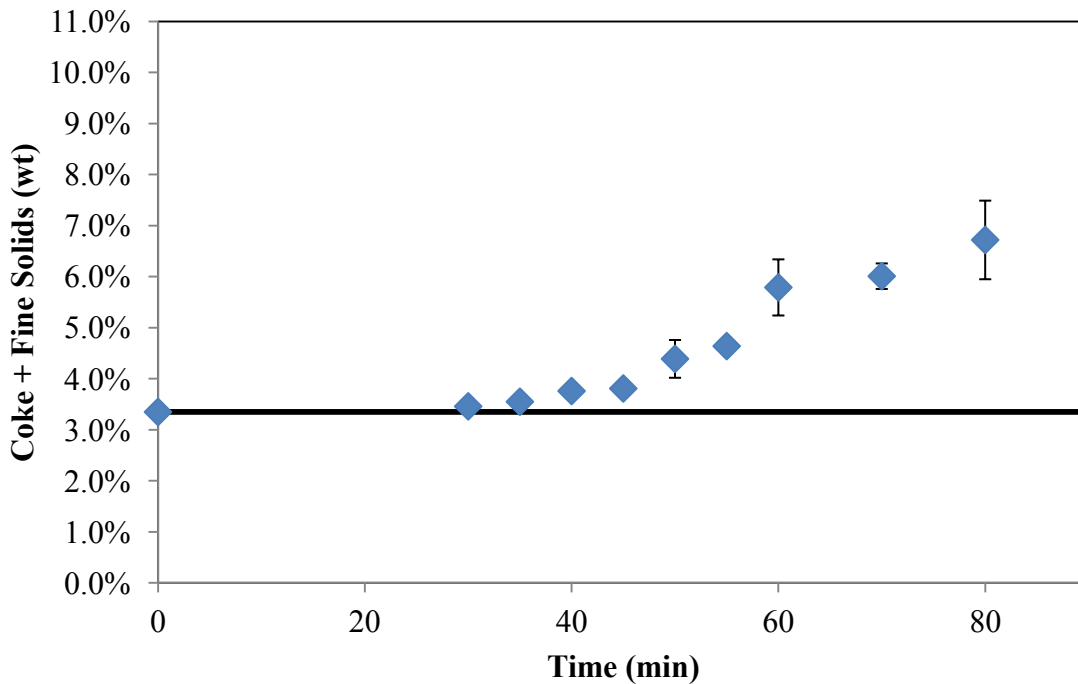

Figure 4.11 Coke and fine solids yielded as a function of time for bitumen froth (6.9 MPa)

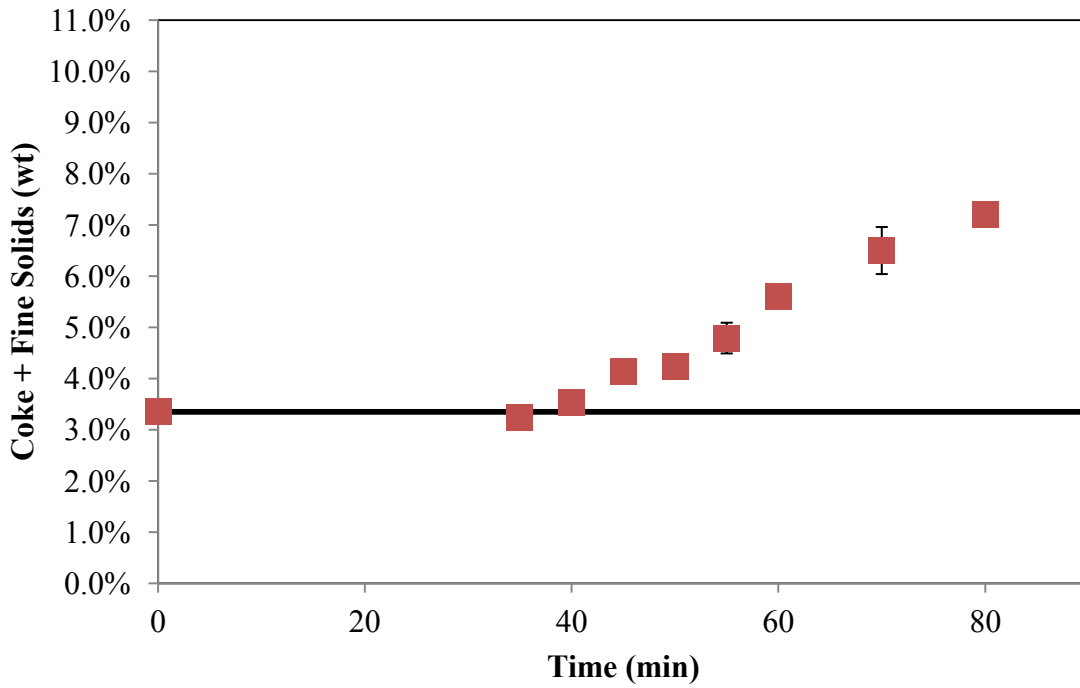

Figure 4.12 Coke and fine solids yielded as a function of time for bitumen froth (17.5 MPa)

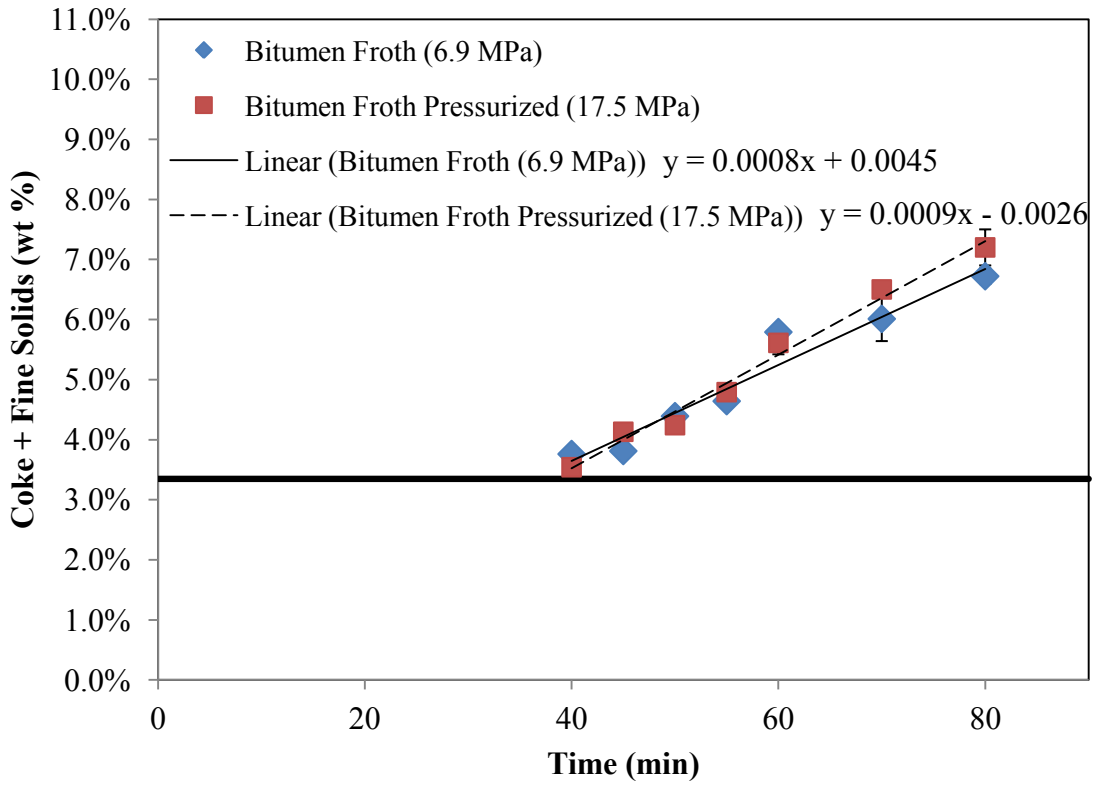

Figure 4.13 Linear regression on coke and fine solids yielded as a function of time for bitumen froth

4.10 Simulated Distillation and Conversion

4.10.1 Conversion of Vacuum Tower Bottoms

Figure 4.14 shows the boiling curve for Athabasca vacuum tower bottoms obtained from SimDist for both the feed and different reacted cases with a reaction time of 40 minutes at a temperature of 410°C. As expected, significant reduction in the boiling points can be observed for all of the reacted cases indicating conversion of heavy to light products. The obtained conversions can be seen on Table 4.11. The conversion of VTB without water and solids is 29%. Leaving the solids in the VTB, the conversion is 25%. Addition of water at 17.4 wt% and 33.3 wt% on top of leaving the solids in the VTB, the conversions are 28% and 31% respectively. Based on these data, the effect of water and fine solids on conversion do not vary significantly and are within experimental error.

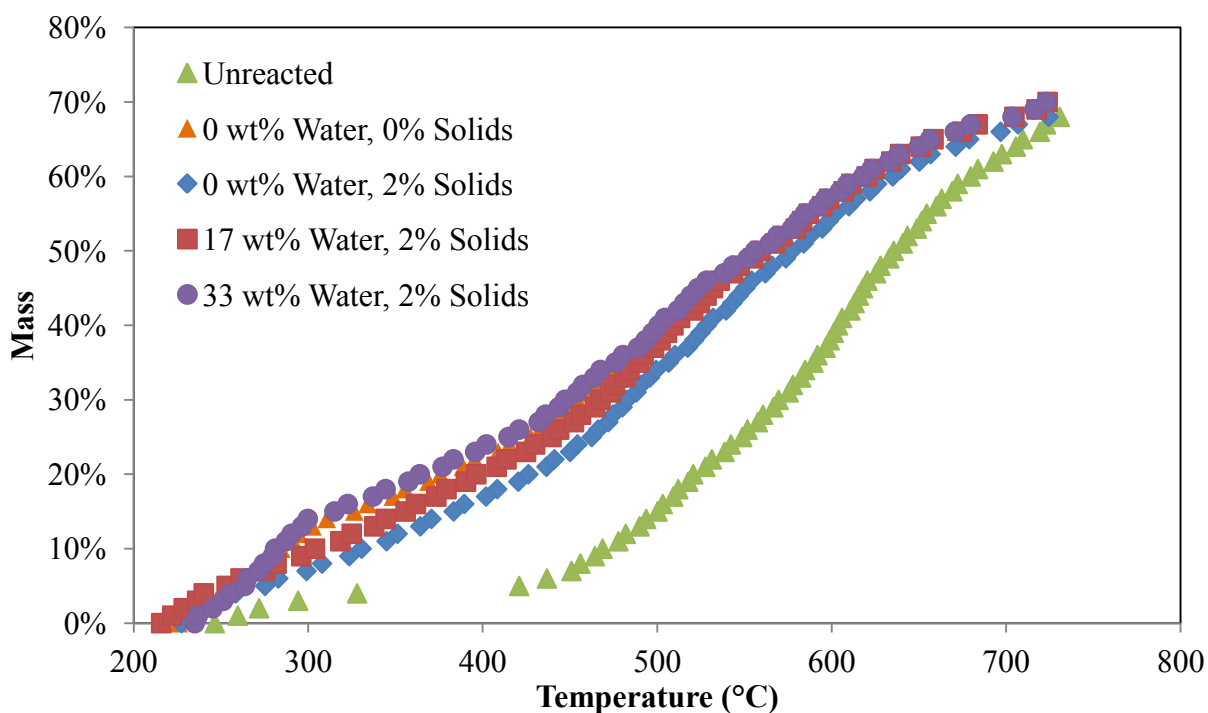

Figure 4.14 Boiling curves of VTB feed and products obtained from SimDist for 40 minutes of reaction time at 410°C

Table 4.11 Conversion of vacuum tower bottoms for 40 minutes of reaction time at 410°C

VTB Conversion (40 Minutes, 410°C)			
0 wt% Water, 0% Solids	0 wt% Water, 2% Solids	17 wt% Water, 2% Solids	33 wt% Water, 2% Solids
29%	25%	28%	31%

4.10.2 Conversion of Bitumen Froth

Figure 4.15 shows the boiling curve for Athabasca bitumen froth obtained from SimDist for 6.9 MPa and 17.5 MPa cases with a reaction time of 45 minutes at a temperature of 410°C. A reduction in the boiling points can be observed for the reacted cases indicating conversion of heavy to light products. The obtained conversions can be observed in Table 4.12. The conversion of bitumen froth at 6.9 MPa is 17% and at 17.5 MPa is 15%. Based on these data, the effect of pressure on conversion does not vary significantly and are within experimental error at these conditions.

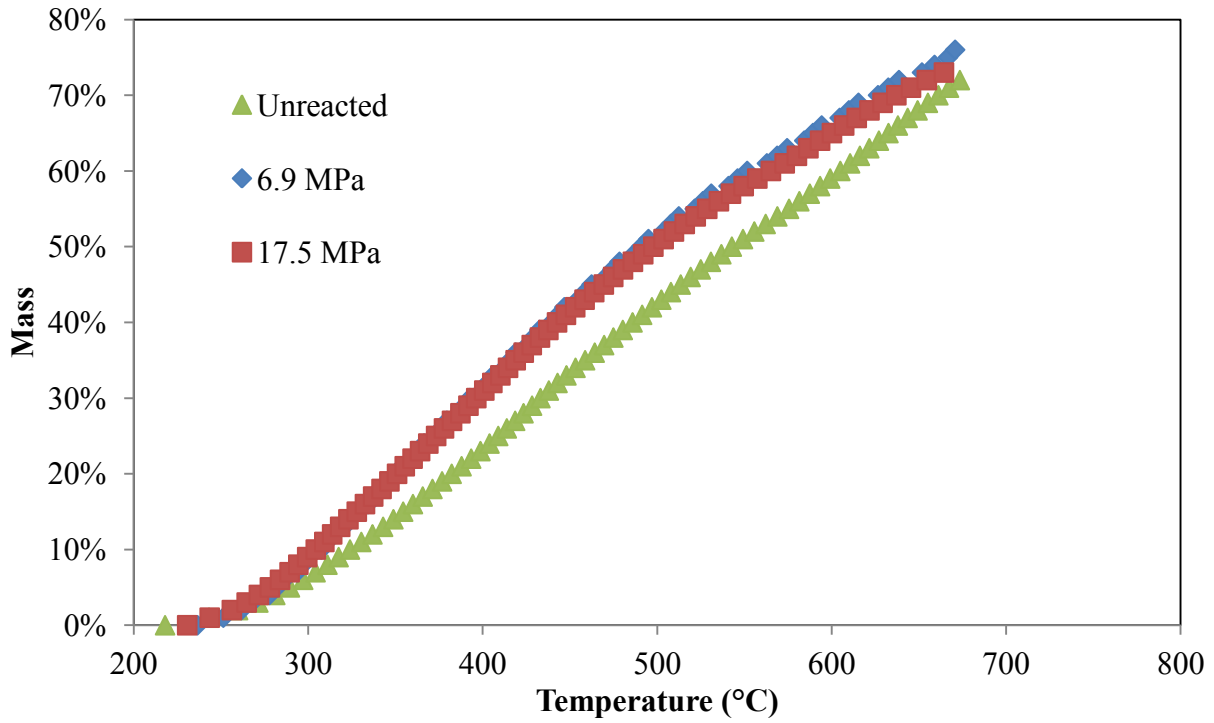

Figure 4.15 Boiling curves of bitumen froth feed and products obtained from SimDist for 45 minutes of reaction time at 410°C

Table 4.12 Conversion of bitumen froth for 45 minutes of reaction time at 410°C

Bitumen Froth Conversion (45 Minutes, 410°C)	
6.9 MPa	17.5 MPa
17%	15%

4.11 Comparison of Results with Literature

In this section, the observed effects of water and fine solids in thermal cracking of bitumen found in literature studies are compared to the experimental results found in this study. Comparison of the results found in this study with results found in literature yields the following conclusions.

Onset of coke formation, total coke yield and overall conversion of VTB is not significantly affected by water at the concentrations used in this study, in contrast to the results of Cheng et al. (2009), He et al. (2008), Kayukawa (2009), Morimoto et al. (2010) and Zhao et al. (2006). The water contents that were examined in these experiments, ranging from 0 wt% to 33 wt%, are much lower than in prior work which ranged from 50 wt% to 80 wt%. In the present study, the reacting bitumen material was mostly in a single liquid phase containing low water concentrations. Whereas at higher water concentrations and pressures, there will be two phases present and an increased amount of water dissolved in the bitumen-rich phase. The denser aqueous phase would extract a significant amount of material from the reacting bitumen as well as better suppress second-order addition reactions by dilution of the reactants. Both factors could contribute to a suppression of coke formation, and a delay in the onset of coke formation to higher conversion. These results support the hypothesis by Cheng et al. (2009), who hypothesized that high water:oil ratios are required in order to improve cracking behaviour by increasing conversion and decreasing overall coke yield. Cheng et al. (2009) found that a water:VR ratio of 2:1 cracked at 420°C for 60 minutes generates only 1/4 of the coke for VR without water at the same conditions. Morimoto et al. (2010) observed an increase in conversion from 60% to 71% when bitumen was cracked in the presence of supercritical water at 450°C and a water:oil ratio of 2:1 for 120 minutes. Due to its relatively low water:oil ratio, thermal cracking of bitumen froth does not yield any supplementary benefits over reacting bitumen alone unless a high total concentration of water is added to the process at high pressure to enable solvent extraction of the heavy components.

The results from this study examining the effects of fine solids on thermal cracking of bitumen and vacuum tower bottoms are in agreement with literature in regards to delaying onset of coke formation and decreasing coke yield. Reaction of vacuum tower bottoms with fine solids provided an induction time before coke was formed similar to what was found in Tanabe and

Gray (1997) and Liu (2002). However, conversion of bitumen and vacuum tower bottoms was not significantly changed by the presence of fine solids which is in disagreement with Sankey et al. (1998). In the case of Sankey et al. (1998), the increase in conversion is attributed to the fact that reducing or eliminating coke formation on process equipment will prevent fouling thus better heat transfer and less pressure drop can be observed. This benefit does not apply to this experimental study as coke formation in the batch microreactor will not greatly affect heat transfer or pressure drop. Nonetheless, these results are consistent with the findings from Sanaie et al. (2001) who observed that solids did not have an effect on volatiles formation thus there should not be a change in conversion. Overall, thermal cracking of bitumen with fine solids provides a beneficial result by delaying onset of coke formation and decreasing coke yield.

4.12 Integration of Findings for Process Design of Bitumen-Water Upgrading

There are several advantages of upgrading bitumen-water mixtures containing residual fine solids over bitumen as discussed earlier in this study. Though optimal conditions on running a bitumen-water upgrading process are still relatively unknown, this section will suggest sample process designs for two different cases that attempt to utilize some of these advantages. The first case is designated as the base case which is operated at hydrothermal conditions and without added water. A secondary case designated as the supercritical case operates at supercritical conditions with addition of water and is based on the findings from this study combined with findings from literature. The goals of these process designs are to take advantage of the benefits and suggest a simple method in thermal cracking bitumen-water mixtures where reaction time is held as long as possible until the onset of coke formation occurs in order to maximize conversion and to avoid coke forming.

The first benefit of upgrading bitumen-water with fine solids is that after reaction, fine solids normally stabilized by emulsions, become hydrophobic and are easily filterable possibly providing an environmentally friendly alternative to the expensive process of froth treatment to remove unwanted solids (Zhao 2013). The implication to process design is that now the relatively complex froth treatment step can be replaced with a simpler filtration step.

Additionally, maintaining the solids in the mixture will allow for a longer cracking time before coke formation, thus increasing conversion as conversion, X , is a function of time, t , and rate constant, k , as shown in Equation 4-1 (Gray 2014).

$$(1 - X) = e^{-kt} \quad (4-1)$$

As an example, using the findings from Section 4.8, leaving solids in VTB changes the coke onset time from 14 minutes to 37 minutes. An increase in reaction time from 14 minutes to 37 minutes enables an increase in conversion from 11% to 26%. Details of the calculation are shown in Appendix C.

Though not examined in this study but found in literature, the presence of supercritical water at high water:oil ratios can increase conversion and reduce coke yield. Since the base case is not operated at supercritical conditions or high water:oil ratios, this benefit may not be applicable. The supercritical case differentiates itself by capturing the benefit at the costs of operating at more severe conditions and requiring a water addition stream.

4.12.1 Base Case

The objective of the base case is to directly upgrade the bitumen froth without addition of water and maintain pressures in the range of 12-16 MPa. Reactor conditions of 12 MPa and 410°C are chosen and in proximity to the pressure and temperature used in experiments. Based on the findings from Section 4.9, a reaction time of 40 minutes is chosen to avoid coke formation. The process flow diagram for base case is given on Figure 4.16.

In order to avoid unnecessary complexities outside of the scope of this study, the process design includes the following assumptions:

- Solids are hydrophobic, will be present in the liquid/oil phase after reaction and can be easily removed by filtering (Zhao 2013).

- Feed bitumen froth has a composition: 85 wt% bitumen, 10 wt% water and 5 wt% solids.
- Upgraded bitumen viscosity is low enough that it can be cooled down significantly to undergo filtration and oil-water separation through a flash drum.

The assumed bitumen froth composition already has relatively low water content. For a pressure of 12 MPa, the solubility of water in the liquid hydrocarbon phase is lower than most water compositions in bitumen froth at 4.1% as calculated from Model B of Amani (2014). Details of the calculation as well as comparison with VMGSim can be found in Appendix B. Increased water content from the originally assumed 10% will cause increased pressure. Increased pressure will cause slightly more water to be dissolved; however, even if the pressure is increased to supercritical pressure of 23 MPa, the amount dissolved is only 8.3%. This is not enough solubility to dissolve all of the water. Therefore, it will be difficult to keep the mixture in one phase unless much lower water content is assumed or much higher pressures are used. With regards to coke formation, varying water content (in the ranges of 0-33 wt% water) as observed in the VTB coking experiments of Sections 4.4-4.7, does not have a major impact on the coke onset time. With respect to conversion, having varying water content in these ranges does not affect conversion as discussed earlier in this chapter.

The design proceeds as follows:

Bitumen froth is pumped (P-101) and pressurized to 12 MPa. It then enters a heater, H-101, where it is heated to 410°C. The heated bitumen froth enters the reactor, R-101, where it has a reaction time of 40 minutes. The product then exits the reactor and goes into a vapor-liquid separator, S-101, where the two streams is separated (Ulrich and Vasudevan 2004).

The vapor stream which is comprised of water that was not dissolved, in the form of steam, as well as light ends, is cooled by HX-101 and depressurized through V-101. After it is cooled and depressurized, it is sent to a vapor-liquid separator, S-102, where gases formed during the cracking reaction can be separated from the mixture. The remaining liquid enters an electrostatic precipitator, E-101, and the sour light crude is separated from the water.

The liquid stream, comprised of upgraded bitumen, water dissolved in the upgraded bitumen and solids is cooled (HX-102) and depressurized (V-102) to 250°C and 1 MPa. These conditions are ideal for pressure filtration as concluded by Sankey et al. (1998). At this point, the water should drop out of the bitumen because the solubility is much lower. It is then sent through a pressure filtration system, F-101, and the solids are filtered from the product liquid stream (Sankey et al. 1998). The upgraded bitumen enters a flash drum where water is separated (FD-101) from the upgraded bitumen and can be combined with the vapor from S-101. The upgraded bitumen can be sent for further refining outside of this design scope.

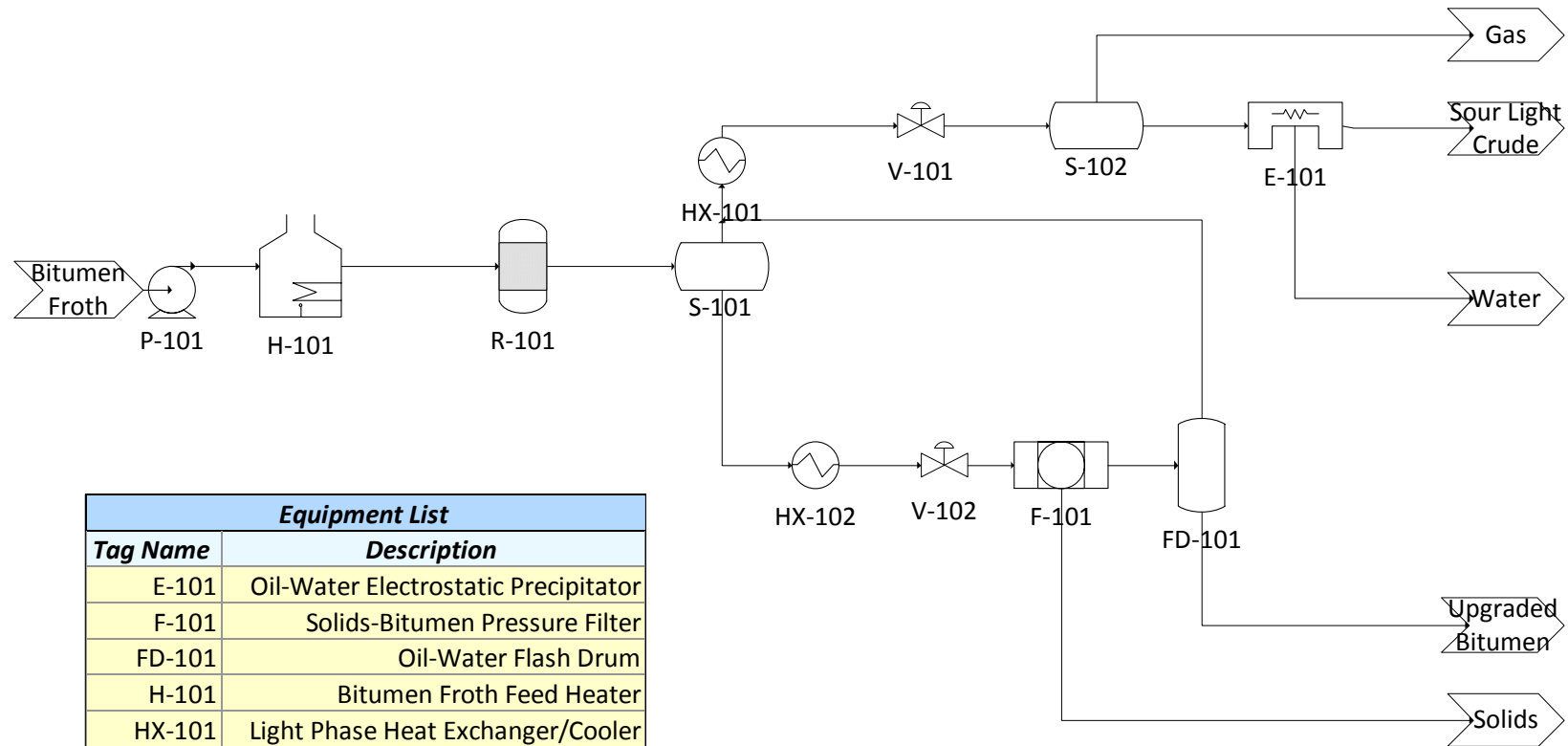

Equipment List	
Tag Name	Description
E-101	Oil-Water Electrostatic Precipitator
F-101	Solids-Bitumen Pressure Filter
FD-101	Oil-Water Flash Drum
H-101	Bitumen Froth Feed Heater
HX-101	Light Phase Heat Exchanger/Cooler
HX-102	Heavy Phase Heat Exchanger/Cooler
P-101	Bitumen Froth Feed Pump
R-101	Bitumen Froth Reactor
S-101	Post Reaction Vapor-Liquid Separator
S-102	Vapor-Liquid Separator
V-101	Light Phase Pressure Reducer
V-102	Heavy Phase Pressure Reducer

Figure 4.16 Process flow diagram for base case of bitumen-water upgrading

4.12.2 Supercritical Case

As discussed earlier in Chapter 2, findings from literature suggest the use of supercritical water at high water-bitumen ratios. A make-up water stream is generally necessary as the water obtained from bitumen froth is not nearly enough to achieve the water concentrations recommended. This process becomes very energy intensive which adds a layer of complexity to the design. Due to the fact that the experiments completed in this study were not at high water-oil ratios, this sample process design case is entirely based on literature references and thus a range of temperatures and pressures are given. The process description and process flow diagram for the supercritical case is given in Appendix C.

4.12.3 Issues That Need to Be Addressed

Upgrading of bitumen-water mixtures presents additional challenges compared to upgrading only bitumen. Some of these issues include:

- Varying content of water in the bitumen froth feed can cause a myriad of issues in the reactor and heating equipment. A change in water content will cause changes in volumetric flow rates and consequently mean residence time in the reactor.
- Heat exchangers are likely to be fouled when operated with bitumen-water mixtures (Jennings and Shaikh 2007). Therefore, heat exchangers may not be easily incorporated in the design and as a result, energy costs are going to be greatly increased. The base case design does not contain a water addition stream to the feed so omitting heat exchangers from the design will not be as significant as in the supercritical design where the bitumen froth feed requires a water addition stream of 2:1 in volume. Heating costs of the feed will be significant there and a solution to incorporate heat exchangers should be investigated in order to increase the economic viability of the supercritical case.
- Salts in the process water can react to form acids which corrode and destroy process equipment (Jennings and Shaikh 2007).
- At the conditions suggested in this study, the reactor fluids will not be single phase due to excess water. Unless the water content is very low, less than 4 wt%, the reactor will not

be single phase. Having significant volumes of steam in the piping and reactor impairs the feasibility of this process.

CHAPTER 5

CONCLUSIONS AND RECOMMENDATIONS

5.1 Conclusions

From investigating of the effect on water and fine solids on the thermal cracking of bitumen, the following conclusions can be made about how these components effect onset time of coke formation, total coke yield and overall conversion to light products:

- Addition of water to vacuum tower bottoms at low concentrations can have either a slightly increasing or decreasing effect on onset time of coke formation depending on the water content. The higher water content case shortened onset time while the lower water content case was observed to lengthen onset time both compared to the base case of no water. These shifts in onset times are not nearly as dramatic as the shift from fine solids.
- Coke yield did not change considerably nor exhibit a consistent trend with water content at these concentrations. Supporting the hypothesis that the solvent effect is not present until a much denser aqueous phase is achieved thereby providing significant solvent extraction.
- Both water and solids do not change overall conversion of heavy products to light products indicating that they do not affect bitumen cracking chemistry.
- Removal of fine solids in vacuum tower bottoms decreases the onset time for coke formation significantly. This time shift can be utilized by keeping the fine solids in the vacuum tower bottoms while thermal cracking until the onset of coke. By cracking for a longer duration of time, conversion can be increased. Also, addition of water after solid removal does not change the onset time for coke formation.
- Increasing pressure in the cracking of bitumen froth did not change conversion, coke yield, nor the onset time of coke formation.

5.2 Recommendations

Additional works that can be completed based on the findings from this study include:

1. Further examining the effect of water concentration on bitumen thermal cracking. The results of this study dismiss the solvent effect being present at low water-oil ratios. A water-oil ratio of 1:1 could be used as a starting point to determine at which point the solvent effect is present in bitumen thermal cracking.
2. Consideration of different water feeds. Process water obtained from SAGD (steam assisted gravity drainage) and tailings ponds contains dissolved salts among other things. This process water is much different than the deionised water used in this experiment and can have vastly different effects during upgrading. If direct upgrading of bitumen-water mixtures is to be further considered, completing another series of experiments using added process water may be of interest.

REFERENCES

- Amani, M. J., Gray, M. R., and Shaw, J. M. (2013), 'Volume of mixing and solubility of water in Athabasca bitumen at high temperature and pressure', *Fluid Phase Equilibria*, 358, 203-211.
- Amani, M. J. (2014), '*Phase Behavior and Thermophysical Properties of Athabasca Bitumen and Athabasca Bitumen + Toluene Mixtures in Near-critical Water*', (University of Alberta).
- American Petroleum Institute (1997), *API Technical Data Book: Petroleum Refining (6th ed.)*, Washington, D.C. American Petroleum Institute.
- Bagheri, S.R. (2012), '*Mesophase Formation in Heavy Oil*', (University of Alberta).
- Berkowitz, N., Dror, I., and Dunn, S. R. (2011), 'Method for extracting and upgrading of heavy and semi-heavy oils and bitumens', in 947 USPTO 7, 165 (ed.), (USA).
- Bi, W., McCaffrey, W. C., and Gray, M. R. (2007), 'Agglomeration and deposition of coke during cracking of petroleum vacuum residue', *Energy and Fuels*, 21, 1205-11.
- Brunner, E. (1990), 'Fluid mixtures at high pressure. IX. Phase separation and critical phenomena in 23 (n-alkane +water) mixtures', *J. Chem. Thermodyn.*, 22, 335-53.
- Cheng, Z. M., Ding, Y., Zhao, L. Q., Yuan, P. Q., and Yuan, W. K. (2009), 'Effects of Supercritical Water in Vacuum Residue Upgrading', *Energy & Fuels*, 23, 3178-83.
- Edmunds, N. R., Kovalsky, J. A., Gittins, S. D., and Pennacchioli, E. D. (1994), 'Review of phase a steam-assisted gravity-drainage Test', *SPE Reservoir Engineering*, 5, 119-124.

- Energy Resources Conservation Board (2011, March), *Big Reserves, Big Responsibility*. Retrieved from <http://www.energy.gov.ab.ca/OilSands/pdfs/osgenbrf.pdf>
- Erasmus, D. E., Dawson, N. P., and Chachula, F. (2010), 'Process for Recovering Heavy Minerals from Oil Sand Tailings', in 695 USPTO 7, 612 (ed.), (USA).
- Fan, H. F., Zhang, Y., and Lin, Y. J. (2004), 'The catalytic effects of minerals on aquathermolysis of heavy oils', *Fuel*, 83, 2035-39.
- Garner, W. N., Madge, D. N., and Strand, W. L. (2008), 'Bituminous Froth Inclined Plate Separator and Hydrocarbon Cyclone Treatment Process', in 438 USPTO 7, 189 (ed.), (USA).
- Gary, J. H., Handwerk, G. E., and Kaiser, M. J. (2007), *Petroleum Refining: Technology and Economics, 5th Ed.* Boca Raton, Florida: CRC Press.
- Gray, M. R. (1994), *Upgrading Petroleum Residues and Heavy Oils*. New York, New York: Marcel Dekker Inc.
- Gray, M. R. (2014), *Upgrading Oilsands Bitumen and Heavy Oil*, University of Alberta Press.
- Gray, M. R., Eaton, P. E., and Le, T. (2008), 'Inhibition and promotion of hydrolysis of chloride salts in model crude oil and heavy oil', *Petroleum Science and Technology*, 26, 1934-44.
- Gray, M. R. and McCaffrey, W. C. (2002), 'Role of Chain Reactions and Olefin Formation in Cracking, Hydroconversion, and Coking of Petroleum and Bitumen Fractions', *Energy and Fuels*, 16, 756-766.
- Gregoli, A. A., Oko, U. M., and Leder, F. (1989), 'Process for converting heavy crudes, tars and bitumens to lighter products in the presence of brine at supercritical conditions ', in 818 USPTO 4, 370 (ed.), (USA).

- He, Z., Li, L., Li, L., Zestar, L. P., and Chinn, D. (2008), 'Process and Reactor for Upgrading Heavy Hydrocarbon Oils', in 099 USPTO 0, 378 (ed.), (USA).
- Jennings, D. W. and Shaikh, A. (2007), 'Heat-Exchanger Deposition in an Inverted Steam-Assisted Gravity Drainage Operation. Part 1. Inorganic and Organic Analyses of Deposit Samples', *Energy and Fuels*, 21, 176-184.
- Kaminsky, H. A. W., Etsell, T. H., Ivey, D. G., and Omotoso, O. (2009), 'Distribution of clay minerals in the process streams produced by the extraction of bitumen from Athabasca oil sands', *The Canadian Journal of Chemical Engineering*, 87(1), 85-93.
- Kayukawa, T. (2009), 'Upgrading of Bitumen by Using Supercritical Water', *5th NCU Upgrading and Refining Conference 2009* (September 14-16, 2009, Edmonton, Alberta.).
- Liu, L. (2002), '*Effect of Solids on Coke Formation from Athabasca Bitumen and Vacuum Residue*', (University of Alberta).
- Masliyah, J. H., Xu, Z., and Czarnecki, J. A. (2011), *Handbook on Theory and Practice of Bitumen Recovery from Athabasca Oil Sands*. Cochrane, Alberta: Kingsley Knowledge Pub., 144-212.
- McFarlane, R. (2007), '*Evaluation of New Co-Volume Mixing Rules for the Peng-Robinson Equation of State*', (University of Alberta).
- Morimoto, M., Sato, S., and Takanohashi, T. (2010), 'Conditions of Supercritical Water for Good Miscibility with Heavy Oils', *Journal of the Japan Petroleum Institute*, 53 (1), 61-62.
- Morimoto, M., Sugimoto, Y., Sato, S., and Takanohashi, T. (2014), 'Solvent Effect of Water on Supercritical Water Treatment of Heavy Oil', *Journal of the Japan Petroleum Institute*, 57 (1), 11-17.

- Murthy, A. K. S., Kundanbhai, M. P., and Bekker, A. Y. (1984), 'Process for production of light hydrocarbons by treatment of heavy hydrocarbons with water', in 446 USPTO 4, 012 (ed.), (USA).
- Nagamatsu, S., Tomoki, K., Hikari, E., and Takayoshi, F. (2011), 'Heavy Oil Upgrading Apparatus and Heavy Oil Upgrading Method', in 774 Canadian IP Office 2, 062 (ed.), (Canada).
- Osacky, M., Geramian, M., Ivey, D. G., Liu, Q., and Etsell, T. H. (2013), 'Mineralogical and chemical composition of petrologic end members of Alberta oil sands', *Fuel*, 113, 148-157.
- Rahimi, P., Gentzis, T., and Fairbridge, C. (1999), 'Interaction of Clay Additives with Mesophase Formed during Thermal Treatment of Solids-Free Athabasca Bitumen Fraction', *Energy & Fuels*, 13, 817–825.
- Sanaie, N., Watkinson, A. P., Bowen, B. D., and Smith, K. J. (2001), 'Effect of minerals on coke precursor formation', *Fuel*, 80, 1111-1119.
- Sankey, B. M., Maa, P. S., and Bearden, R. Jr. (1998), 'Conversion of the organic component from tar sands into lower boiling components', in 795 USPTO 5, 464 (ed.), (USA).
- Sato, T., Trung, P. H., Tomoyuki, T., and Itoh, N. (2012), 'Effect of water density and air pressure on partial oxidation of bitumen in supercritical water', *Energy & Fuels*, 95, 347–351.
- Siskin, M. and Katritzky, A. R. (2001), 'Reactivity of organic compounds in superheated water: General background', *Chemical Reviews*, 101 (4), 825-35.

Speight, J. G. (2012), 'Visbreaking: A technology of the past and the future' *Scientia Iranica*, 19 (3), 569-573.

Tanabe, K. and Gray, M. R. (1997), 'Role of fine solids in the coking of vacuum residues', *Energy and Fuels*, 11, 1040-43.

Ulrich, G. D. and Vasudevan, P. T. (2004). *Chemical Engineering Process Design and Economics: A Practical Guide (2nd Edition)*. Durham: Process Publishing.

Van Den Berg, F. G. A., Jansen, A., and Stamps, P. A. (2004), 'Breaking of Oil/Water Emulsion', in 787 USPTO 6, 027 (ed.), (USA).

Wiehe, I. A. (1993), 'A Phase-Separation Kinetic Model for Coke Formation', *Ind. Eng. Chem. Res.*, 32, 2447-2454.

Zhao, J. (2013), '*Characterization of Fine Solids in Bitumen Froth Before and After Hydrothermal Reactions*', (University of Alberta).

Zhao, L., Cheng, Z. M., Ding, Y., Yuan, P. Q., Lu, S. X., and Yuan, W. K. (2006), 'Experimental study on vacuum residuum upgrading through pyrolysis in supercritical water', *Energy & Fuels*, 20, 2067–2071.

Appendix A: Additional Figures and Data

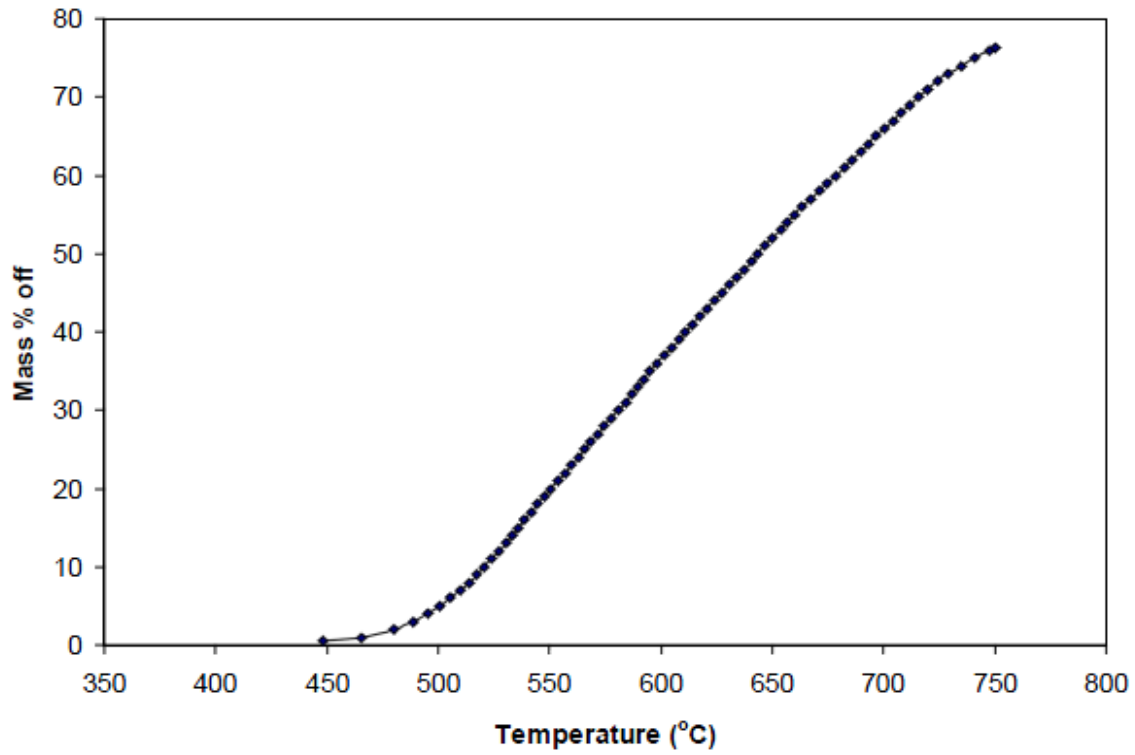

Figure A1. Simulated distillation curve for Athabasca vacuum tower bottoms (McFarlane 2007)

Table A1. Boiling curve for Syncrude Athabasca bitumen (Gray 2014)

TBP Yield (vol%)	NBP (°C)
IBP	260.0
5	329.1
10	361.0
20	411.2
30	460.1
40	507.1
50	546.9
60	580.9
70	620.9
80	677.9
90	794.0
95	886.2
98	942.5
EP	979.9

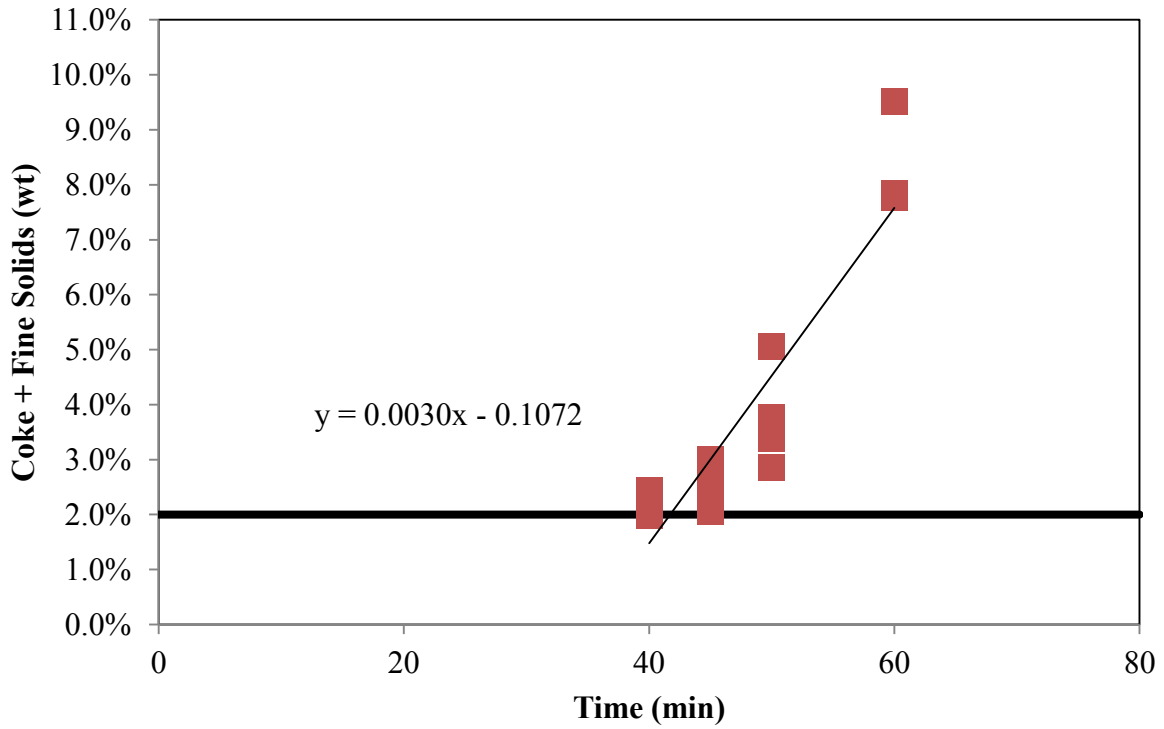

Figure A2. Linear regression on coke and fine solids yielded for vacuum tower bottoms with 17.4 wt% water added

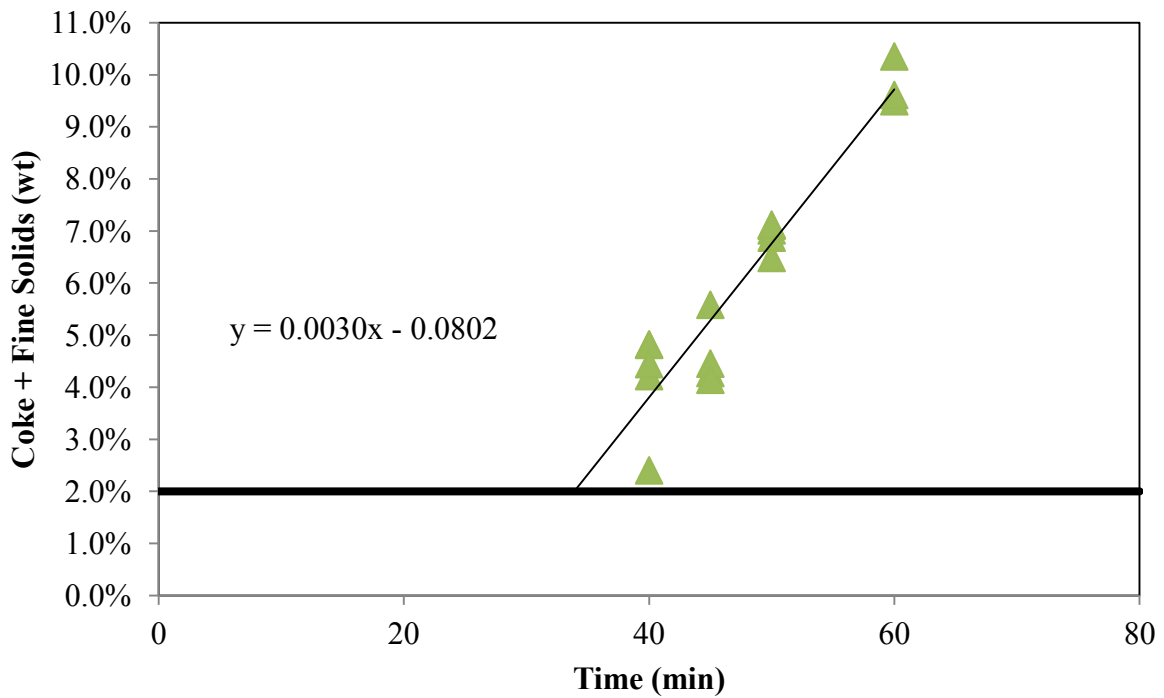

Figure A3. Linear regression on coke and fine solids yielded for vacuum tower bottoms with 33.3 wt% water added

Appendix B: Bitumen-Water Solubility Calculations

Assume: Constant Froth Composition of 85% bitumen, 10% water and 5% solids

Basis: 3000g of feed (2550g bitumen, 300g water, 150g solids)

Equation obtained from Amani (2014) Model B.

Built in Assumptions: Bitumen saturated pressure is negligible; therefore there is a negligible volume of bitumen in the vapor phase.

Equation (1)

$$\ln(K) = \frac{1.8532 * 10^4}{T} + 3.2959 * 10^1 * \ln(T) - 2.3657 * 10^2$$

Equation (2)

$$P_w = P - P_{bit}^{sat}$$

Equation (3)

$$P_w = K w_w$$

T in Kelvin

W_{H_2O} fraction in HC phase

P in MPa

For temperature of **410°C** (683K) and Pressure of **17.5 MPa**

From Equation (1)

$$\ln(K) = \frac{1.8532 * 10^4}{683} + 3.2959 * 10^1 * \ln(683) - 2.3657 * 10^2$$

$$K = 290 \text{ MPa}$$

From Equation (3)

$$17.5 \text{ MPa} = 290 \text{ MPa} * w_w$$

$W_{\text{H}_2\text{O}, \text{liq}} = 6.0 \text{ wt\% in HC/Liquid phase}$

We can back calculate the amount of bitumen in the liquid phase since we know mass fraction of bitumen is $1 - W_{\text{H}_2\text{O}}$

$$W_{\text{Bitumen}, \text{liq}} = 94.0 \text{ wt\%}$$

Since all the bitumen is assumed to be in the liquid phase, we can calculate the total mass of the liquid phase

$$m_{\text{Bitumen}, \text{vap}} = 0\text{g}$$

$$m_{\text{Bitumen}, \text{liq}} = 2550\text{g}$$

$$m_{\text{Total}, \text{liquid}} = 2550 / 0.940 = 2713\text{g}$$

The rest of the mass in the liquid phase is water

$$m_{\text{H}_2\text{O}, \text{l}} = 2713\text{g} - 2550\text{g} = 163\text{g}$$

Mass balance to determine water in the vapor phase

$$m_{\text{H}_2\text{O}, \text{v}} = 300\text{g} - 163\text{g} = 137\text{g}$$

VMGSim Check

A boiling curve for bitumen was used for VMGSim calculation as seen on Table A1. Introduce a basis feed of 300 kg/h of H₂O and 2550 kg/h bitumen. They are both mixed and set to conditions of 410°C and 17.5 MPa for the solubility check.

The screenshot shows the 'Equilibrium Results' tab for a stream named 'S6'. The 'Port / Fluids' dropdown is set to 'In'. The table below shows the results for various properties across four phases: Bulk, Vap, Liq0, and Liq1. The mass fraction of water in the liquid phase (Liq1) is highlighted in red as 0.0331.

Name	Bulk	Vap	Liq0	Liq1
Phase Frac [Fraction]	1.00	0.5616	0.4384	0.00
T [C]	410.0	410.0	410.0	410.0
P [kPa]	17500.00	17500.00	17500.00	17500.00
Mole Flow [kgmole/h]	21.57	12.11	9.45	0.00
Mass Flow [kg/h]	2850.00	277.24	2572.76	0.00
Volume Flow [m3/hr]	6.222	2.723	3.498	0.000
Std Liq Volume Flow [m3/hr]	3.036	0.287	2.749	0.000
Std Gas Volume Flow [SCMD]	1.2262E+4	6.8868E+3	5.3753E+3	0.00E+0
Properties				
Fraction				
MassFraction				
WATER [Fraction]	0.1053	0.7745	0.0331	0.1053
NITROGEN [Fraction]	0.00	0.00	0.00	0.00
Oil_1_522_Bitumen_Assay_ABP[513]F [Fraction]	0.0078	0.0141	0.0071	0.0078
Oil_1_522_Bitumen_Assay_ABP[538]F [Fraction]	0.0079	0.0129	0.0073	0.0079
Oil_1_522_Bitumen_Assay_ABP[563]F [Fraction]	0.0080	0.0118	0.0075	0.0080
Oil_1_522_Bitumen_Assay_ABP[588]F [Fraction]	0.0079	0.0106	0.0077	0.0079
Oil_1_522_Bitumen_Assay_ABP[613]F [Fraction]	0.0087	0.0103	0.0085	0.0087
Oil_1_522_Bitumen_Assay_ABP[639]F [Fraction]	0.0134	0.0141	0.0134	0.0134
Oil_1_522_Bitumen_Assay_ABP[663]F [Fraction]	0.0208	0.0194	0.0209	0.0208
Oil_1_522_Bitumen_Assay_ABP[688]F [Fraction]	0.0215	0.0177	0.0219	0.0215
Oil_1_522_Bitumen_Assay_ABP[713]F [Fraction]	0.0228	0.0164	0.0235	0.0228

Output at 410°C and 17.5 MPa:

$$m_{\text{Total, liq}} = 2572.8\text{g}$$

$$w_{\text{H}_2\text{O, liq}} = 3.3\% \text{ in HC/Liquid Phase}$$

$$m_{\text{Bitumen, liq}} = 2572.8 \cdot (1 - 0.0331) = 2488\text{g}$$

$$m_{\text{Bitumen, vap}} = 2550\text{g} - 2488\text{g} = 62\text{g}$$

$$m_{\text{H}_2\text{O, liq}} = 2572.8 * 0.0331 = 85.2\text{g}$$

$$m_{\text{H}_2\text{O, vap}} = 300\text{g} - 85.2\text{g} = 214.8\text{g}$$

Comparison

For 17.5 MPa and 410°C

Table B1. Bitumen-water solubility obtained from Model B of Amani (2014)

Amani (2014)	Liquid (g)	Vapor (g)
Bitumen	2550	0
Water	163	137
Total	2713	137

Table B2. Bitumen-water solubility obtained from VMGSim

VMGSim	Liquid (g)	Vapor (g)
Bitumen	2488	62
Water	85	215
Total	2573	277

For 12 MPa and 410°C

Amani (2014)

$$w_{\text{H}_2\text{O, liq}} = 4.1\% \text{ in HC/Liquid Phase}$$

VMGSim

$$w_{\text{H}_2\text{O, liq}} = 2.3\% \text{ in HC/Liquid Phase}$$

Conclusions

- Amani (2014)'s equation predicts much higher water solubility in bitumen than does VMGSim (6.0% versus 3.3%)
- Water is not fully soluble in bitumen at this condition and composition (both VMGSim and Amani's data) even though a relatively low composition of water in froth is assumed (10 wt%)
- VMGSim predicts a small amount of bitumen present in the vapor phase (2.4% of total bitumen)
- Pressure in the microreactor calculated by VMGSim is likely to be an overestimate due to having a higher amount of vapor(insoluble water) compared to Amani's data

Appendix C: Conversion Calculations

Equation for first order, irreversible batch reactor obtained from Gray (2014)

$$(1 - X) = e^{-kt}$$

The average conversion of the 4 cases from Table 4.11 is 28% at a reaction time of 40 minutes; the rate constant can be obtained as follows:

$$\ln(1 - 0.28) = -k * 2400s$$

$$k = 1.37 * 10^{-4} s^{-1}$$

For a reaction time of 14 minutes, which is the onset time of coke formation without solids, conversion can be calculated as follows:

$$(1 - X) = e^{-(840)*0.000137}$$

$$X = 0.11$$

For a reaction time of 37 minutes, which is the onset time of coke formation with solids, conversion can be calculated as follows:

$$(1 - X) = e^{-(2220)*0.000137}$$

$$X = 0.26$$

Appendix D: Sample Process Design for Supercritical Case

The first step in this process involves pumping and heating bitumen froth to a pressure of 23-30 MPa and a temperature of 100-150°C. The bitumen froth is then mixed with a stream of supercritical water at 500-550°C and 23-30 MPa at a volume ratio of 1:2 (Zhao et al. 2006; He et al. 2008). The mixture is sent to a reactor with conditions of 400-440°C (Zhao et al. 2006; He et al. 2008; Cheng et al. 2009), 23-30 MPa and a mean residence time of 30 minutes (Tanabe and Gray 1997; He et al. 2008).

The reacted mixture enters a separator where the heavy phase is removed (Kayukawa 2009; Nagamatsu et al. 2011). The product mixture which is comprised of light sour crude oil, water and gas is sent to a heat exchanger where it gets cooled to 250°C by heating the water stream that is added to the mixer in the early stages of the process. The pressure is reduced to 1 MPa from a pressure reducing valve (Nagamatsu et al. 2011). The product mixture is cooled further to 100-150°C by heating the bitumen froth feed at the start of the process. After the product mixture is cooled, it enters a phase separator where gases can be separated from the stream (Sankey et al. 1998). Finally, the sour crude oil is separated from the water by electrostatic precipitation.

The heavy phase is sent to a heat exchanger where it is cooled to a temperature of 250-300°C and then dropped to a pressure of 1 MPa through a pressure reducing valve (Nagamatsu et al. 2011). The product mixture then undergoes pressure filtration at elevated temperatures (Sankey et al. 1998) where the solids are separated. The stream is sent to a flash drum where the water is separated. The heavy phase can be used as boiler fuel or a portion of it can be mixed with the sour crude oil stream to increase the yield (Nagamatsu et al. 2011).

The water stream is comprised of make-up water as well as recycled water from electrostatic precipitation. Water is pumped to a pressure of 23-30 MPa and heated through heat exchange and a heater to 500-550°C. The reason for generating superheated steam is to avoid heating the bitumen to reaction temperatures which may cause thermal cracking and coking (He et al. 2008).

The water stream enters the mixer and does not separate until electrostatic precipitation. The water is then held in a storage vessel where it is sent as recycle to the start of the process.

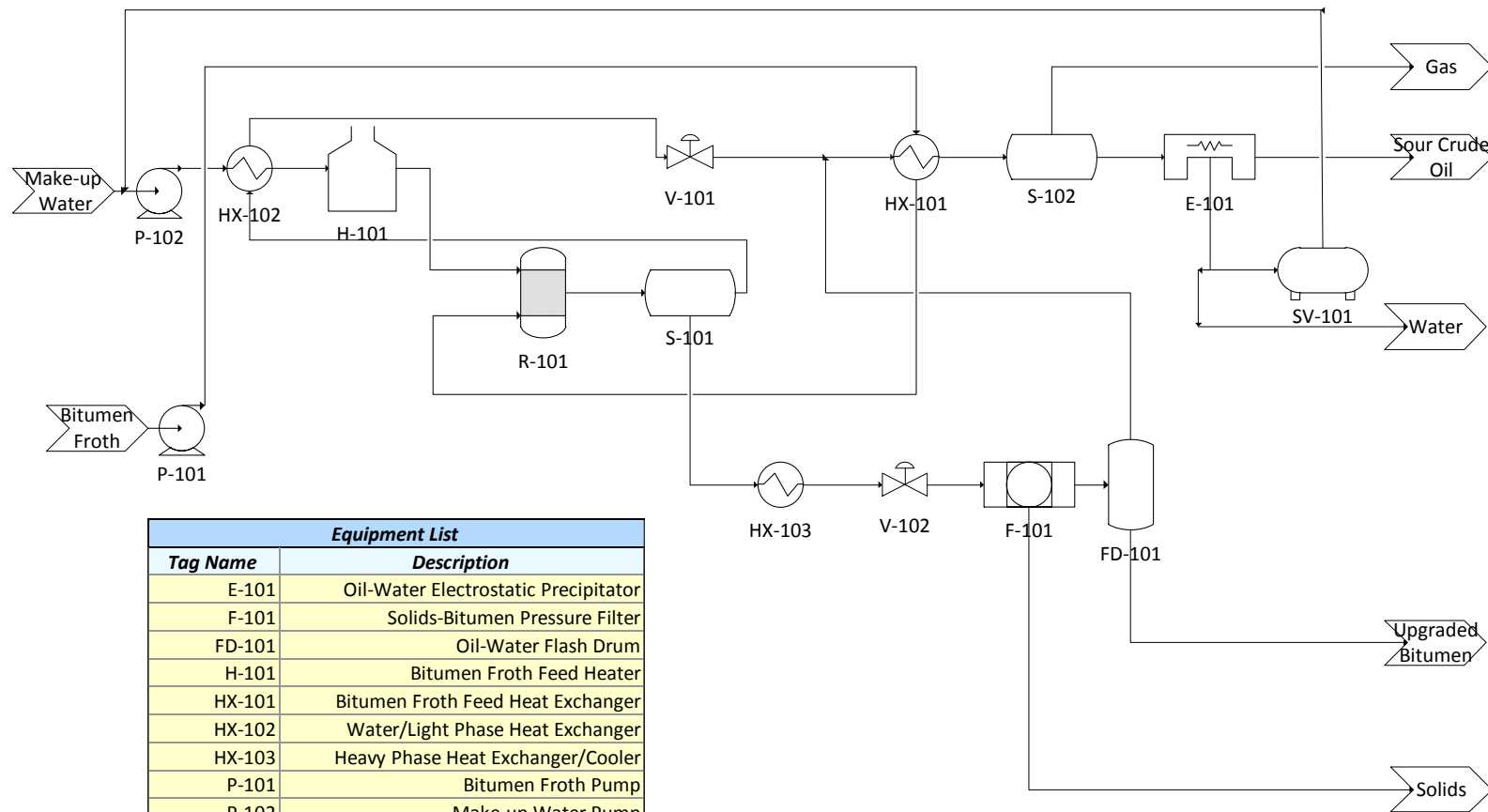

Equipment List	
Tag Name	Description
E-101	Oil-Water Electrostatic Precipitator
F-101	Solids-Bitumen Pressure Filter
FD-101	Oil-Water Flash Drum
H-101	Bitumen Froth Feed Heater
HX-101	Bitumen Froth Feed Heat Exchanger
HX-102	Water/Light Phase Heat Exchanger
HX-103	Heavy Phase Heat Exchanger/Cooler
P-101	Bitumen Froth Pump
P-102	Make-up Water Pump
R-101	Bitumen Froth Reactor
S-101	Light-Heavy Phase Separator
S-102	Vapor-Liquid Separator
SV-101	Water Storage Vessel
V-101	Light Phase Pressure Reducer
V-102	Heavy Phase Pressure Reducer

Figure D1. Process flow diagram for bitumen-water upgrading under supercritical condition