

OTTAWA



OTTAWA

NAME OF AUTHOR.....*READ TRYSTAD SEIDER*.....

TITLE OF THESIS.....*THE CHEMISTRY OF (C₄H)₁₀*.....
HYDROCARBONS.....

UNIVERSITY.....*OF ALBERTA*.....

DEGREE.....*P.H.D.*.....YEAR GRANTED.....*1969*.....

Permission is hereby granted to THE NATIONAL LIBRARY OF CANADA to microfilm this thesis and to lend or sell copies of the film.

The author reserves other publication rights, and neither the thesis nor extensive extracts from it may be printed or otherwise reproduced without the author's written permission.

(Signed).....*Read Seider*.....

PERMANENT ADDRESS:

10657-5 Ave
Edmonton, Alberta

DATED.....*April 15*.....1969

THE UNIVERSITY OF ALBERTA

THE CHEMISTRY OF $(CH)_{10}$ HYDROCARBONS

by



Read Trygstad Seidner

A THESIS

SUBMITTED TO THE FACULTY OF GRADUATE STUDIES
IN PARTIAL FULFILMENT OF THE REQUIREMENTS FOR THE DEGREE
OF DOCTOR OF PHILOSOPHY

Department of Chemistry

Edmonton, Alberta

Spring, 1969

THE UNIVERSITY OF ALBERTA
FACULTY OF GRADUATE STUDIES

The undersigned certify that they have read, and
recommend to the Faculty of Graduate Studies for acceptance
a thesis entitled

THE CHEMISTRY OF $(CH)_{10}$ HYDROCARBONS

submitted by Read Trygstad Seidner in partial fulfilment of the
requirements for the degree of Doctor of Philosophy.

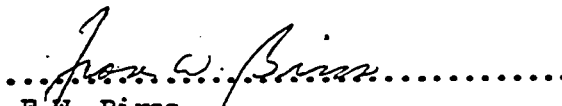

.....
S. Masamune (Supervisor)

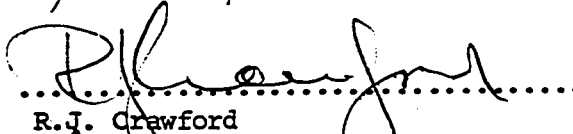
.....
F.W. Birss

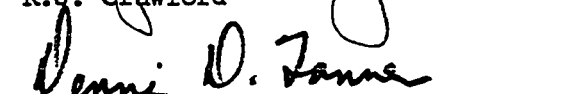
.....
R.J. Crawford

.....
D.D. Tanner

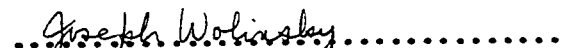
.....
I.G. Dalla Lana

.....
J. Wolinsky (External Examiner)

Date: March 31, 1969

To Dani

ACKNOWLEDGMENTS

The author is indebted:

To Dr. S. Masamune for his guidance and encouragement.

To other members of this laboratory for their assistance and helpful discussions.

To the spectroscopy laboratory staff for their cheerful and capable services.

To his wife, Dani, for her understanding and patience.

To Mrs. G. Whittal for typing this manuscript.

To the University of Alberta Chemistry Department for providing financial assistance in the form of a Teaching Assistantship.

ABSTRACT

Bicyclo[6.2.0]deca-2,4,6,9-tetraene (XI), tetracyclo[4.4.0.0^{2,10}.0^{5,7}]deca-3,8-diene (X), (*cis*)⁵[10]annulene (XIII) and *trans*-(*cis*)⁴[10]annulene (XII) had been postulated as intermediates in many (CH)₁₀ isomerizations. The preparation of all these compounds has been carried out and the photochemical and thermal properties of these compounds has been elucidated.

The synthesis of (XI) was effected by photolytic decomposition of the sodium salt of bicyclo[6.1.0]nona-2,4,6-triene-*trans*-carboxaldehyde tosylhydrazone. Other products present in this reaction were cyclooctatetraene, tricyclo[5.3.0.0^{4,8}]deca-2,5,9-triene (IX) and bicyclo[4.2.2]deca-2,4,7,9-tetraene (VI). The mechanism of this reaction is briefly discussed.

By use of low temperature photolysis techniques the photochemical behavior of XI and *cis*- and *trans*-9,10-dihydronaphthalenes (III and VII) was investigated. Photo-irradiation of any of these three compounds at -110° provided a similar photolysate in which the major (65%) product was X. Photo-irradiation of these compounds in the temperature range 0° to -190° demonstrated that XI, III and VII exhibited temperature dependent quantum yields and that significant amounts of the [10]annulenes (XII and XIII) were produced in the photolysis of only III at -60°. A preliminary mechanistic interpretation is offered to account for these observations.

Investigation of some thermal $(\text{CH})_{10}$ isomerizations has been carried out. By a first order process, XI provided quantitatively VII, which underwent further reaction to naphthalene, 1,2-dihydronaphthalene, and hydrogen partly by a second order process. Compound X readily isomerized to VI below 0° . The temperature dependent nmr spectra of VI and the thermolysis of VI to III are explained in terms of intermediate X.

TABLE OF CONTENTS

	<u>Page</u>
Acknowledgments	iv
Abstract	v
List of Tables	viii
List of Figures	ix
1 INTRODUCTION	1
2 RESULTS AND DISCUSSION	13
A. Synthesis of bicyclo[6.2.0]deca-2,4,6,9-tetraene.	13
B. Photochemical Reactions of some (CH) ₁₀ compounds.	32
C. Thermal Reactions of some (CH) ₁₀ compounds.	58
3 EXPERIMENTAL	78
REFERENCES	100

LIST OF TABLES

<u>Table</u>		<u>Page</u>
1	(CH) ₁₀ compounds	3
2	Photochemical reactions of bicyclo[6.2.0]deca- 2,4,6,9-tetraene and <i>cis</i> - and <i>trans</i> -9,10-dihydro- naphthalenes	48

LIST OF FIGURES

<u>Figure</u>		<u>Page</u>
1	Nmr spectrum of methyl bicyclo[6.1.0]nona-2,4,6-triene- <i>trans</i> -carboxylate	20
2	Nmr spectrum of methyl bicyclo[6.1.0]nona-2,4,6-triene- <i>cis</i> -carboxylate	20
3	Mass spectrum of bicyclo[6.2.0]deca-2,4,6,9-tetraene	25
4	Nmr spectrum of bicyclo[6.2.0]deca-2,4,6,9-tetraene	
5	Low temperature photolysis apparatus, cooling system	35
6	Low temperature photolysis apparatus, lamp	36
7	Low temperature photolysis apparatus, mirror	37
8	NMR spectrum of photolysate of bicyclo[6.2.0]deca-2,4,6,9-tetraene (-110° photolysis)	39
9	Nmr spectrum after warming sample shown in Figure 8	39
10	Nmr spectrum of photolysate of <i>cis</i> -9,10-dihydronaphthalene (-110° photolysis)	43
11	Nmr spectrum after warming sample shown in Figure 10	43
12	Nmr spectrum of photolysate of <i>cis</i> -9,10-dihydronaphthalene (-60° photolysis)	51

<u>Figure</u>		<u>Page</u>
13	Nmr spectrum after warming sample shown in Figure 12	52
14	Nmr spectrum after further warming sample shown in Figure 13	53
15	Uv spectrum of <i>trans</i> -9,10-dihydronaphthalene	61
16	Nmr spectra of <i>trans</i> -9,10-dihydronaphthalene	61
17	Temperature dependent nmr spectra of bicyclo[4.2.2]deca-2,4,7,9-tetraene	67
18	Temperature dependent nmr spectra of bicyclo[4.2.2]deca-2,4,7,9-tetraene	68
19	Thermolysis of bicyclo[4.2.2]deca-2,4,7,9-tetraene	73
20	Energy profile of the thermolysis of bicyclo[4.2.2]deca-2,4,7,9-tetraene	76

CHAPTER 1Introduction

A molecular formula $(CH)_x$, where x is an even integer for a neutral molecule, defines a set of C_xH_x compounds in which all member compounds have one and only one hydrogen atom directly bonded to each carbon atom. Because of this restriction only a portion of all C_xH_x compounds can be grouped in a $(CH)_x$ set. To illustrate, of the C_6H_6 compounds only five are $(CH)_6$ compounds: benzene, bicyclo [2.2.0] hexa-2,5-diene, benzvalene, prismane, and 3,3-bis(Δ' -cyclopropenyl). As x increases the number of set members increases dramatically and the $(CH)_8$ group is the limiting case where one can list the structures of all members "by hand" with a reasonable degree of certainty. Clearly for $x > 8$ a topological approach (graph theory) is desired. Fortunately such an analysis for the $x=10$ set has been carried out.¹ Subtracting geometrically impossible structures (crossed bonds, impossible bond lengths) from this listing of $(CH)_{10}$ isomers leaves approximately 50 feasible $(CH)_{10}$ structures (see Appendix I for a complete list of $(CH)_x$ compounds for $x=4,6,8,10$).

A prominent characteristic of these groups is interconvertibility of the set members. The carbon-hydrogen correlation imposed by the classification implies that interconversion of member compounds can be accomplished solely by carbon-carbon bond rearrangement. The energy barriers between a certain pair







of the member compounds (in either ground state or in excited state) may be unusually low. For example, it is now known that compounds of the C_6H_6 group are photochemically and thermally interconvertible.²

Before completion of the initial portion of the present work on $(CH)_{10}$ compounds, a total of nine $(CH)_{10}$ hydrocarbons had been synthesized. See p. 3 for a list of these hydrocarbons. Interconversion of all the $(CH)_{10}$ hydrocarbons, except "triquinacene" (II), to other $(CH)_{10}$ hydrocarbons, by either thermal or photochemical means, had also been reported. This introductory review pays particular attention to the compounds of central importance to the $(CH)_{10}$ isomerization reactions - that is, compounds III, IV, VI, VII, and IX.

i *cis*-9,10-Dihydronaphthalene (III)

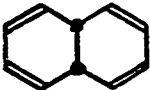
A rational synthesis carried out by van Tamelen and Pappas afforded compound III.⁵ The last step of their synthesis involved reductive debromination of a mixture of isomeric tetrabromides (2,5,7,9-tetrabromo-*cis*-bicyclo[4.4.0]deca-3,8-dienes) with 0.5% lithium amalgam in ether followed by purification by preparative glpc. The structure of III rests secure on spectral evidence (the nmr spectrum displays two groups of olefinic protons and one group of allylic protons and the uv spectrum shows λ_{max} 247 m μ) and by hydrogenation of III to *cis*-decalin.

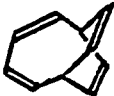
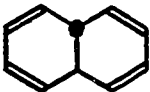
TABLE 1
(CH)₁₀ Compounds

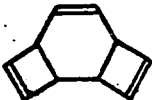
Structure No.	Name	Ref.
	I tricyclo[4.2.2.0 ^{2,5}]deca-3,7,9-triene	3
	II tricyclo[5.2.1.0 ^{4,10}]deca-2,5,8-triene	4
	III <i>cis</i> -9,10-dihydronaphthalene	5
	IV tricyclo[3.3.2.0 ^{4,6}]deca-2,7,9-triene	6
	V pentacyclo[4.2.2.0 ^{2,5} .0 ^{3,8} .0 ^{4,7}]deca-9-ene	7
	VI bicyclo[4.2.2]deca-2,4,7,9-tetraene	8
	VII <i>trans</i> -9,10-dihydronaphthalene	9
	VIII tetracyclo[4.4.0.0 ^{4,10} .0 ^{5,7}]deca-2,8-diene	10
	IX tricyclo[5.3.0.0 ^{4,8}]deca-2,5,9-triene	10
	IX'	

ii Tricyclo[3.3.2.0^{4,6}]deca-2,7,9-triene(IV)

Compound IV, now well known as bullvalene, was first prepared by irradiation of a cyclooctatetraene dimer by Schröder.⁶ Crystallization of the crude photolysate from ethanol removed by-products arising from the photolysis of bullvalene itself. Chemical evidence and fulfillment of predicted temperature-dependent nmr spectra (due to fluxional isomerization) make the structural assignment secure.

iii Bicyclo[4.2.2]deca-2,4,7,9-tetraene(VI)

Jones and Scott disclosed that pyrolysis of the dry sodium salt of bicyclo[6.1.0]nona-2,4,6-triene-*trans*-9-carboxaldehyde tosylhydrazone (XIVc) produced VI as the major product.⁸ (This reaction was disclosed when we had completed initial photochemical experiments on the same tosylhydrazone sodium salt. The two reactions will be discussed in detail later). The thermal stability of compound VI permitted its separation from the crude product mixture by preparative glpc. Hydrogenation of VI to bicyclo[4.2.2]-decane and the nmr spectra exhibited by VI are in agreement with its structural assignment.

iv *trans*-9,10-Dihydronaphthalene(VIII)

Compound VII was synthesized by van Tamelen and Burkoth following a route analogous to the one employed for the successful preparation of III.⁹ The last step was reductive debromination

of a mixture of isomeric tetrabromides (2,5,7,9-tetrabromo-*trans*-bicyclo[4.4.0]deca-3,8-dienes) with 0.5% lithium amalgam. They reported that purification was accomplished by preparative glpc. Although the reported nmr spectrum is in agreement with the structural assignment (singlet τ 4.2 (8H), singlet τ 7.2 (2H)), an atypical uv spectrum for this diene (λ_{\max} 231 m μ) emphasized the need for chemical proof of this structure. The chemical and physical properties of compound VII will be detailed later.

v Tricyclo[5.3.0.0^{4,8}]deca-2,5,9-triene (IX)

The preceding (CH)₁₀ compounds discussed were synthesized by a rational scheme. Compound IX illustrates the first preparation of new (CH)₁₀ compounds not employing an "entry" reaction in that it was formed by isomerization of an existing (CH)₁₀ compound. Photolysis of bullvalene produced a mixture of I, VI, VIII and IX which was separable by preparative glpc techniques.¹⁰ Another synthesis of this hydrocarbon was simultaneously reported from this laboratory. However, at the time neither structure IX nor IX' was conclusively demonstrated. Later, chemical evidence showed structure IX to be correct.¹¹ A detailed discussion of compound IX will be offered later.

As outlined previously, the structure proof followed two lines of evidence - spectral and chemical. The most powerful spectral tool was nmr because not only information such as the

ratios of the different groups of protons but also other data such as symmetry requirements were obtainable. Hydrogenation of the $(\text{CH})_{10}$ compounds to fully saturated authentic material usually comprised the chemical evidence. Since all the hydrocarbons except *trans*-9,10-dihydronaphthalene (VII) were stable enough to be purified by ordinary techniques (glpc or recrystallization), there is reasonable assurance that skeletal rearrangement did not obscure the chemical evidence. Compound VII was originally described as decomposing at room temperature to naphthalene⁹ (detailed description later).

Photochemical or thermal interconversions of $(\text{CH})_{10}$ compounds have been reported for all $(\text{CH})_{10}$ compounds except compound II. As more and more of these interconversions became documented, the publication of the Woodward-Hoffmann (orbital symmetry) rules¹² stimulated mechanistic interest in these transformations. The rules possessed the potential for a more significant interpretation of these reactions and also provided a valuable tool in evaluating the feasibility of intermediate compounds in these reactions.

Four probable intermediates that held the attention of those studying $(\text{CH})_{10}$ isomerizations were bicyclo[6.2.0]deca-2,4,6,9-tetraene (XI), tetracyclo[4.4.0.0^{2,10}.0^{5,7}]deca-3,8-diene (X), and the [10]annulenes (XII and XIII). Efforts were directed toward the synthesis of these compounds in order to demonstrate their presence (intermediacy) or absence in $(\text{CH})_{10}$ isomerizations.

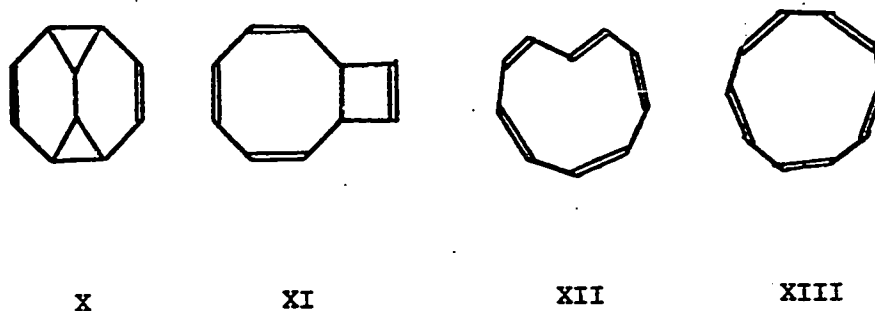

i Reaction(s) suspected to involve XI

Jones and Scott apparently attempted a rational synthesis of XI.⁸ Earlier work carried out by Kirmse on cyclopropyl carbene rearrangements¹³ indicated that the expected product of decomposition of the sodium salt of tosylhydrazone XIVc would be XI. However, the product obtained by thermal decomposition of this salt did not contain XI (see reaction 1).

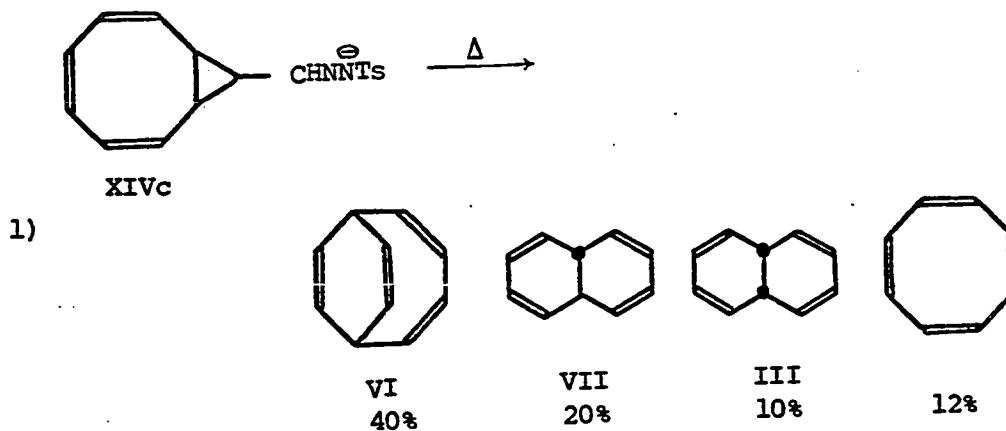

Mechanistically the authors favored the transformation of an intermediate XI to product VI by a sigmatropic suprafacial shift of order [1,5] (thermally allowed). From later work

on similar reactions¹⁴ these authors proposed formation of VII and III from an intermediate XI. With our synthesis of XI, its role in these type of reactions was elucidated and its true thermal behavior demonstrated.

ii Reactions suspected to involve X

A number of reactions in which X was mentioned as a possible intermediate were reported. Schröder had postulated that the thermal reaction of bullvalene to naphthalene involved the intermediacy of III and X (reaction 2).⁶

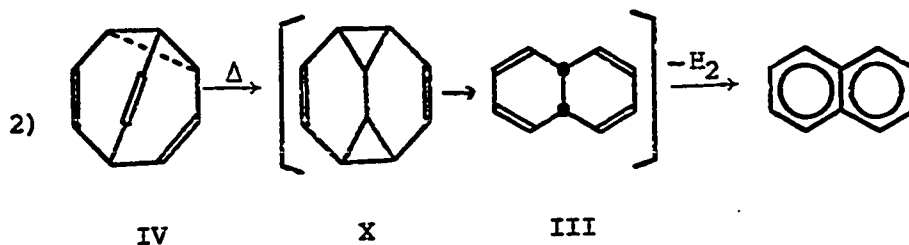

When bullvalene underwent thermolysis above 400° only naphthalene was observed. However, Doering and Rosenthal reported that pyrolysis of bullvalene in a flow system furnished III in good yield.¹⁵ The intermediacy of X still remained speculation. Even though a process from X to III is disallowed a mechanism involving X is not entirely discounted because of the extremely high temperatures required for this reaction.

The intermediacy of X in the photo-conversion of VI to bullvalene was mentioned by Jones and Scott (reaction 3).⁸

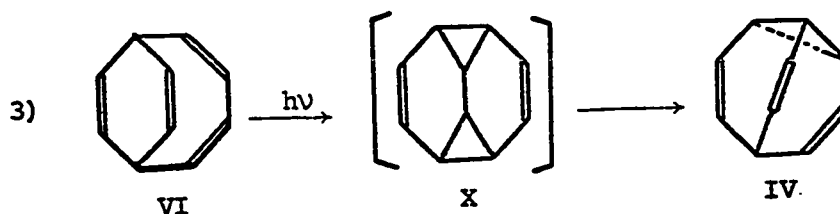

The first step in this mechanism is a photochemically effected intramolecular Diels-Alder reaction. Such a reaction is not disallowed by the Woodward-Hoffmann rules because a molecular orbital correlation can be carried out between the excited states. Reaction 3 also proceeds in reverse: photolysis of IV yielded a mixture containing major amounts of VI.

Photolysis of *cis*-9,10-dihydronaphthalene (III) produced bullvalene,¹⁵ VI¹⁶ and other products. Interpretation of this reaction by Doering and Rosenthal centered around X (reaction 4). These authors reasoned that the reaction was initiated by 4+4

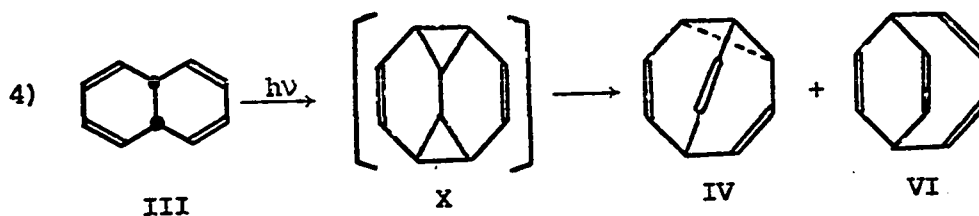

electrocyclic ring closure (photo-allowed with a plane of symmetry) of III to X. Though no further comments concerning reaction of X were offered, it can be seen that X \rightarrow IV is the same sequence offered in reaction 3.

One other $(\text{CH})_{10}$ isomerization reaction can be attractively explained in terms of intermediate X. Pyrolysis of VI produces III at slightly lower temperatures required for bullvalene pyrolysis (reaction 5).¹⁶ The intramolecular Diels-Alder reaction

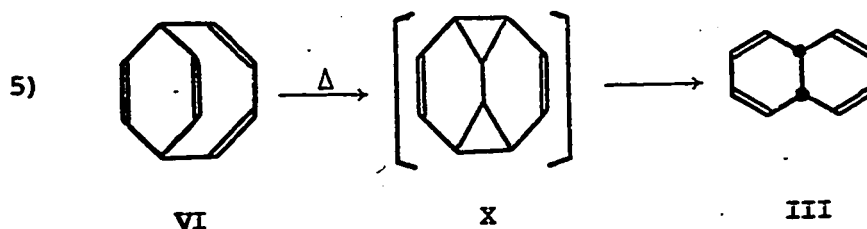

is thermally allowed (σ symmetry); however the opening of X to III is thermally disallowed. The very high temperatures necessary for the reaction might bring about this process.

iii Reaction(s) suspected to involve a [10]annulene

Existence of a [10]annulene in the photolysate of *trans*-dihydronaphthalene (VII) was implied from experiments performed by van Tamelen and Burkoth.⁹ Briefly, they state irradiation of VII in a glass at -190° with a Rayonet photochemical reactor (2537A) produced material that exhibited the "characteristic" uv absorption of III (247 m μ) *only after* warming and recooling the photosylate. They also claimed to have obtained cyclodecane in 40% yield by reducing a cold photosylate at -70° or warmer with diimide. The two experiments were interpreted by the authors as demonstrating the intermediacy of all *cis*-[10]annulene (XIII) (reaction 6).

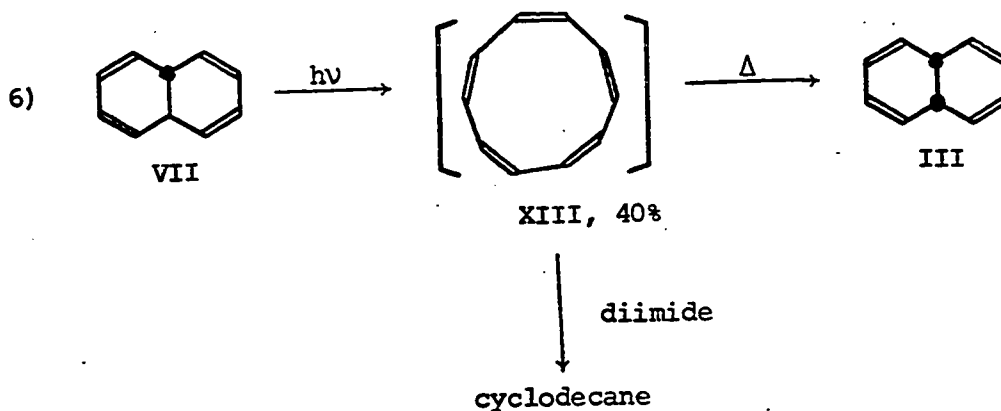

A straightforward application of the Woodward-Hoffmann rules dictates that VII photolytically opens (conrotatory, C_2 symmetry) to XIII which collapses thermally in a disrotatory mode to III.

Doering and Rosenthal attempted to detect a temperature dependent nmr spectra of III.¹⁷ They may have hoped to observe time averaging of the signals of III caused by disrotatory (σ symmetry) opening of III to all *cis*-[10]annulene (XIII). Their efforts at demonstrating a temperature dependent spectrum of III proved futile because another reaction set in at about 100°. Compound III underwent thermal reaction to four products (reaction 7).

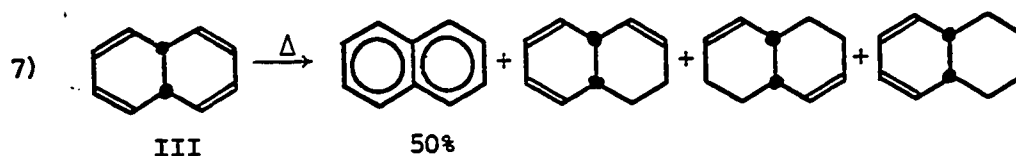

An elaboration of this reaction demonstrated *cis* transfer of hydrogen from III and the reaction was likened to diimide reduction (the driving forces being formation of naphthalene

and nitrogen for the two reactions).

The $(\text{CH})_{10}$ isomerization reactions, reviewed here because of pertinence to the results of this thesis, were in addition to many others¹⁸ that constituted an extensive documentation of the thermal and photochemical reactions of $(\text{CH})_{10}$ compounds. Clearly, many problems remained yet to be solved. In particular, the synthesis and characterization of compounds postulated as intermediates (X, XI, XII, and XIII) had not been accomplished. In addition to the mechanistic implications of these compounds, an added feature which aroused interest was the possibility of aromaticity in the [10] annulenes.

This thesis describes the synthesis of all four compounds: X, XI, XII, and XIII. Attention was directed towards the thermal and photochemical properties of these interesting compounds.

CHAPTER 2

RESULTS AND DISCUSSIONA. Synthesis of bicyclo[6.2.0]deca-2,4,6,9-tetraene (XI)³⁴

Several years ago it was found that a nitrene adduct of cyclooctatetraene underwent thermal rearrangement at 80° to provide a cyclobutene derivative (XV) (reaction 8).¹⁹

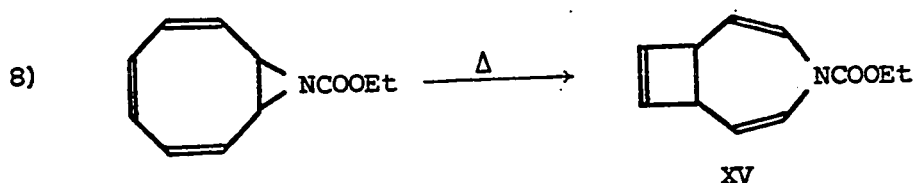

The nmr spectrum of this derivative is compatible with the structural assignment XV and further this compound was converted to a N-methyl derivative which was shown to be identical to one synthesized from the anhydride of cyclobutane-*cis*-1,2-diacetic acid²⁴ (reaction 9).

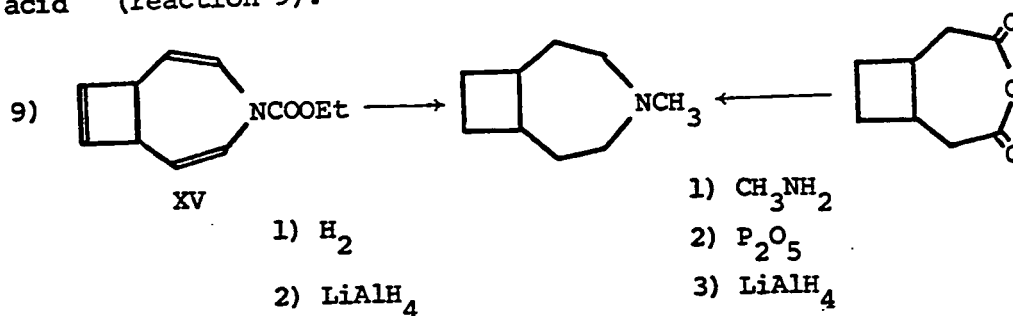

Initially, our investigation of valence bond rearrangements centered on XV. Heating the cyclobutene XV to 130° resulted in a complicated mixture of products. Hydrogenation of this mixture over palladium provided N-carboethoxy perhydroindole and N-carboethoxy indole (reaction 10). Separation of this mixture (presumably

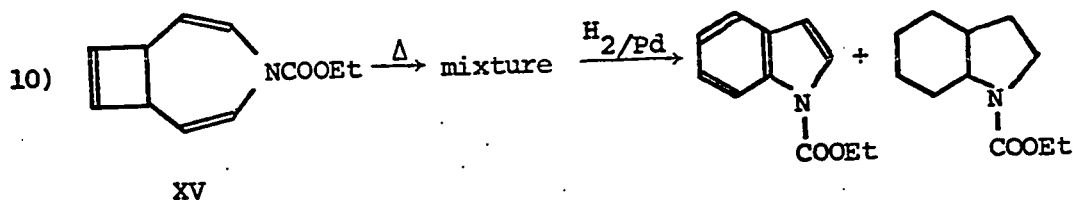

containing indole and dihydroindole derivatives) or further characterization of the components proved difficult. Furthermore, the photochemistry of XV was extremely complex partly because of the presence of a nitrogen atom.

At this point, it was felt that more interpretable results would be obtainable from a system that contained a carbon-carbon double bond in place of the nitrogen atom (possessing a lone pair of electrons). Replacement of the nitrogen atom in this manner should alleviate the experimental difficulties experienced with XV, and also theoretical treatment of results would be simplified.

In 1965 when the initial stages of this work were completed, the publication of the Woodward-Hoffmann rules allowed us to carry out a meaningful evaluation of the possible photochemical and thermal behavior of compound XI. Molecular orbital correlations (σ symmetry) are shown on p. 16. The energy levels for XI and III were calculated by the L.C.A.O. method.²² In addition, calculation of the levels of 10 annulene was carried out on the assumption of planar XIII ($E = \alpha - 2\beta \cos \frac{2\pi j}{n}$, $n=10$, $j=1, 2 \dots 10$).

Inspection of the levels indicates that XI photochemically

opens to all (*cis*)⁵ [10]annulene (XIII), which thermally collapses to III. The strain contained in the cyclobutene ring of XI should enhance its opening in this fashion.

Another reasonable expectation is that XI opens *thermally* in a conrotatory mode to a [10]annulene with one *trans* double bond in the ring. Such an intermediate (XII) or transition state would collapse to *trans*-9,10-dihydronaphthalene. This interpretation is less strict than the previous one because XI and VII do not contain a twofold axis of symmetry.

In addition to the above types of ring opening reactions, many other reasonable reactions could easily be envisioned. For instance, a 2 + 6 ring closure may be photochemically induced (reaction 11).

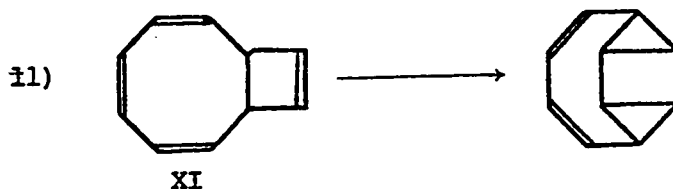

Degenerate suprafacial sigmatropic shift of order [3,3] may occur (reaction 12).

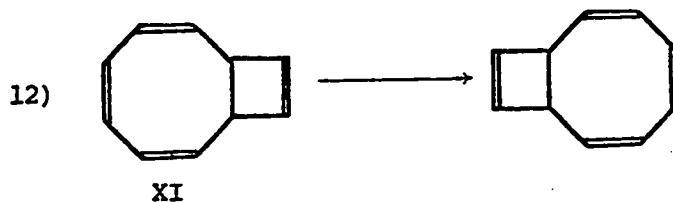

Also, other sigmatropic reactions could be envisioned.

Molecular Orbital Correlations (σ symmetry)

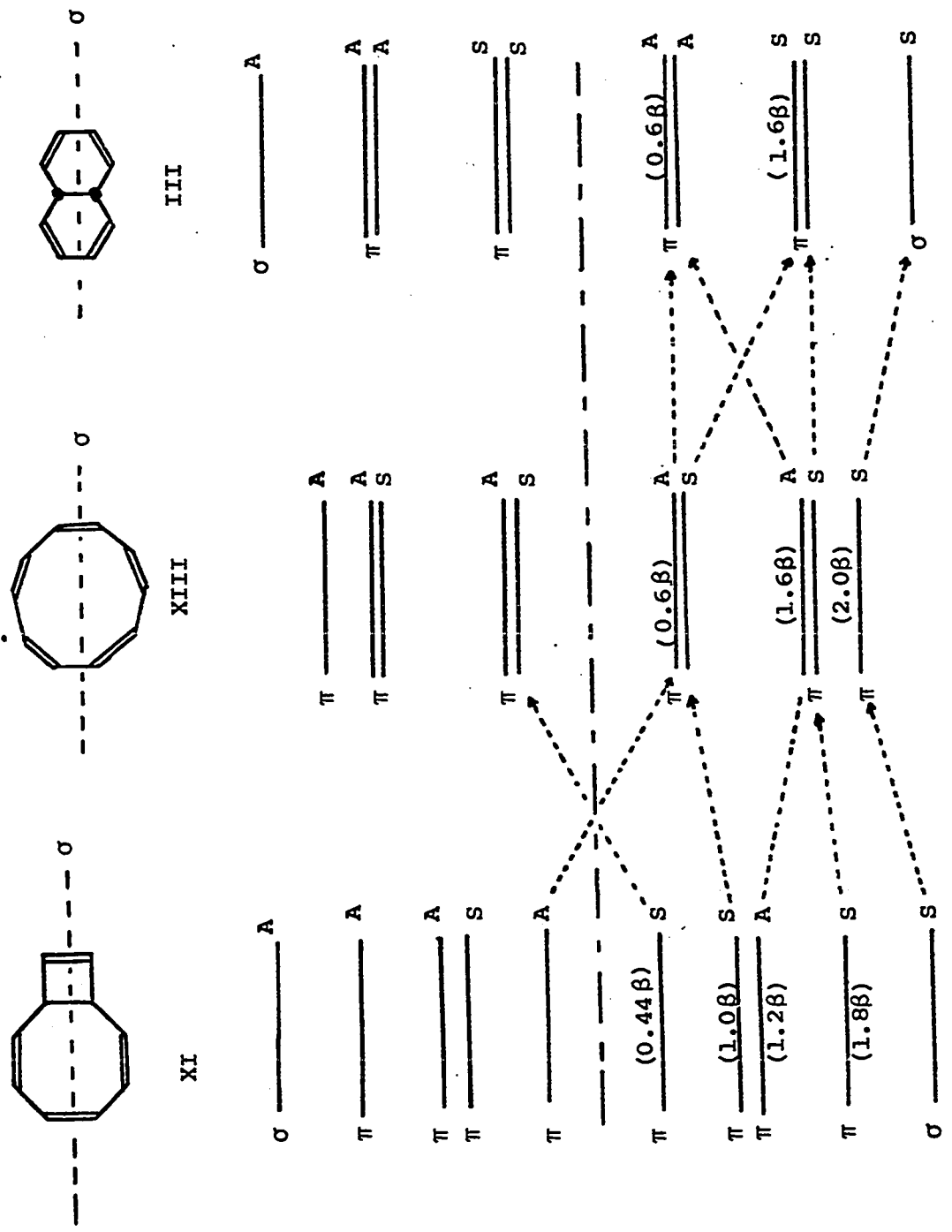

Because of all these potential reactions, our interest was aroused in XI and efforts were directed towards the synthesis and study of XI. An obvious synthetic route to XI utilizes the known cyclopropyl methylene expansion to cyclobutene. Investigation of this expansion reaction in bicyclic systems was carried out by Kirmse (reaction 13).¹³

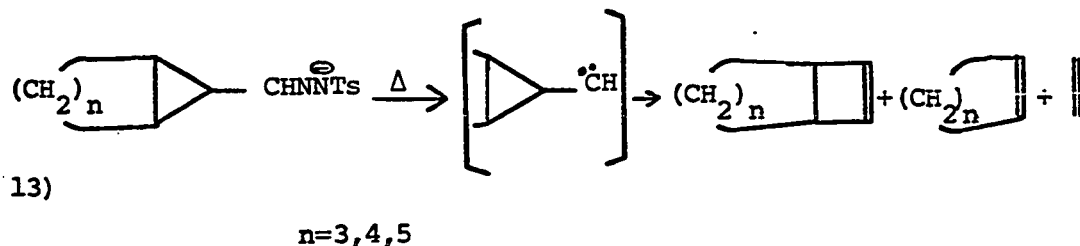

The synthesis of the suitable carbene precursor (bicyclo[6.1.0]nona-2,4,6-triene-*trans*-9 carboxaldehyde tosylhydrazone) proceeded in a straightforward manner.

Decomposition of ethyldiazoacetic ester with copper²⁰ in cyclooctatetraene gave good yields (70-80% by consumed cyclooctatetraene) of ethyl ester XIVa (reaction 14). Distillation rendered XIVa free from other by-products, chiefly diethyl maleate and other diethyl esters. Hydrolysis of ester XIVa by KOH in *tert*-butanol followed by recrystallization from methyl acetate provided pure *trans*-acid XIVb (reaction 15).

Pure *trans*-acid XIVb (mp 166-7°) exhibited nmr signals (CDCl₃) at τ -1.3 (1H), τ 4.1 (d, 6H), τ 7.83 (d, 2H), τ 8.60 (t, 1H). The signals due to the ring protons were similar to those exhibited by the methyl and ethyl esters and *p*-bromophenacyl

ester of XIVb. The nmr spectrum of the mother liquors collected from recrystallizations of XIVb revealed the presence of a new compound which was thought to be the stereo-isomer of XIVb. Chromatography of the mother liquors over silicic acid (chloroform, 5% methanol) or further direct recrystallization did not effect separation of this new compound from XIVb. Conversion of the entire mixture to the p-bromophenacyl esters provided a crystalline mixture from which was isolated two types of crystals on careful recrystallization from methyl acetate. The "first crop" crystals, mp 147-8°, regenerated *trans*-acid XIVb upon hydrolysis and the "second crop" crystals, mp 127-8°, regenerated an acid, mp 146-7°, which was assigned structure XIVb'. *cis*-Acid XIVb' exhibited nmr signals (CDCl₃) at τ -1.3 (1H), τ 4.1 (complex, 6H), τ 7.84 (s, 3H) and the signals due to the ring protons were the same exhibited by the methyl, ethyl and p-bromophenacyl esters of XIVb'.

The nmr spectra of methyl esters of XIVb and XIVb' are shown on p. 20. The stereochemical assignment of *cis*-acid XIVb' was demonstrated by permanganate-periodate oxidation to a cyclopropane-*all cis*-1,2,3-tricarboxylic acid derivative and the stereochemistry of the *trans*-acid XIVb was confirmed in the same manner (reactions carried out by N. Nakatsuka).

Effective separation of the two isomers was later achieved by utilizing the difference in rates of hydrolysis. The methyl esters

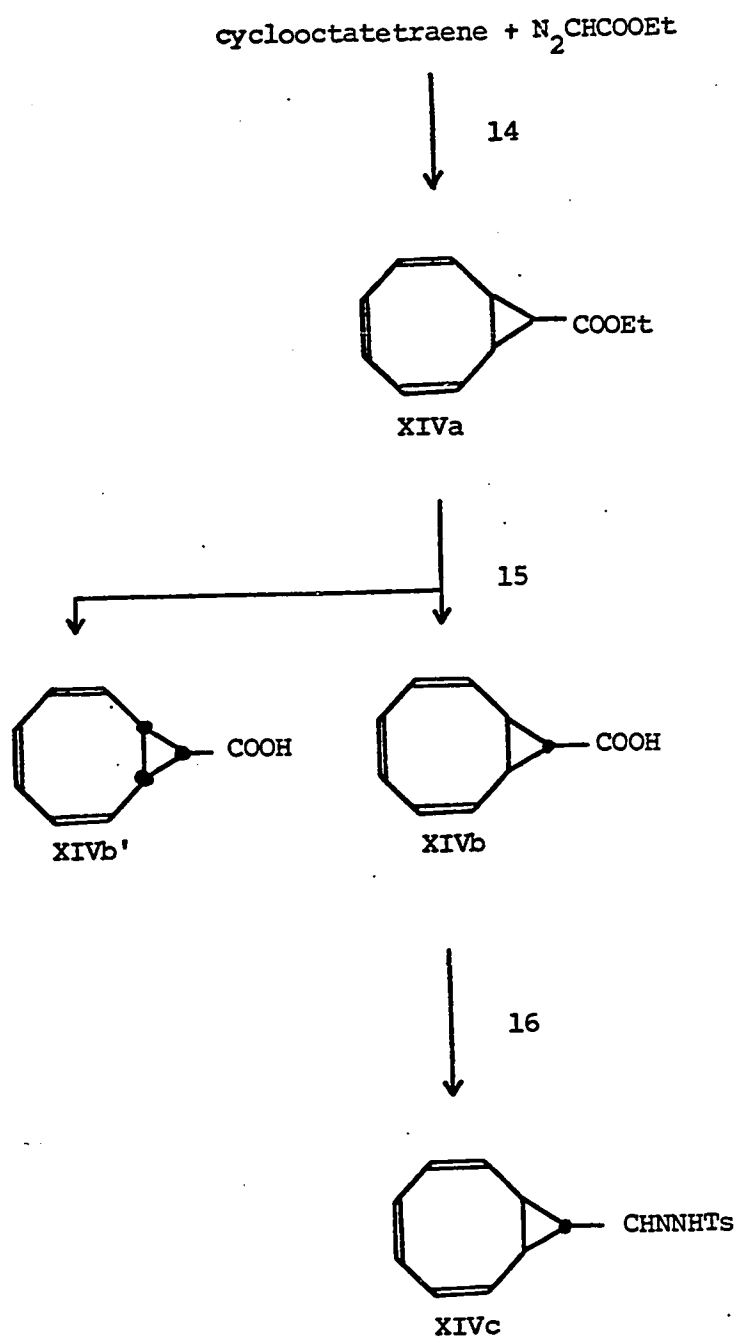

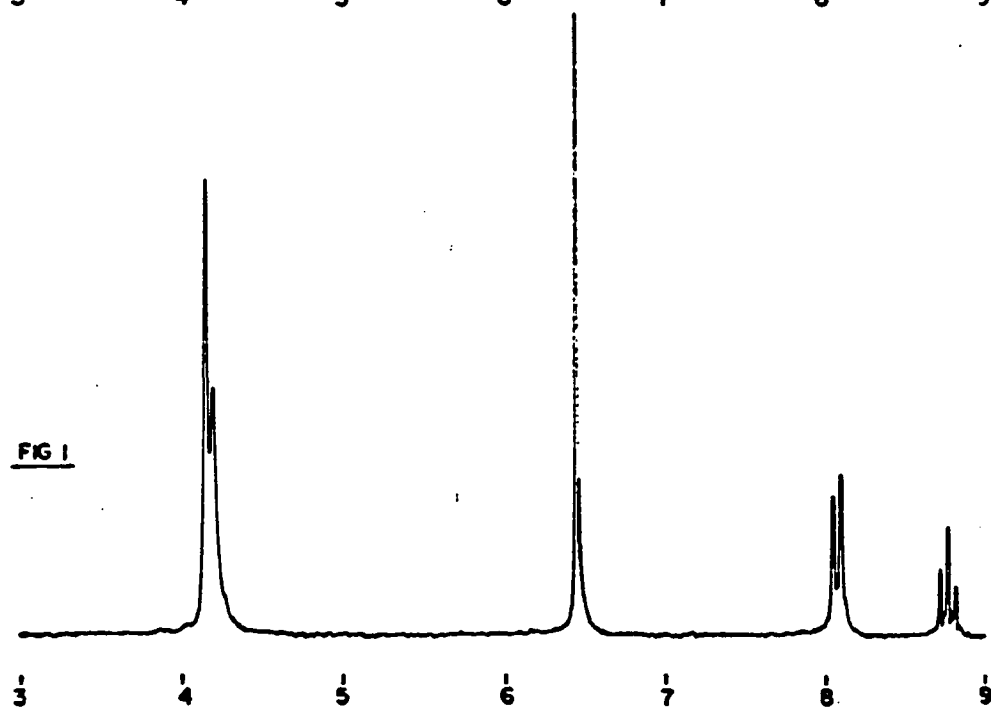
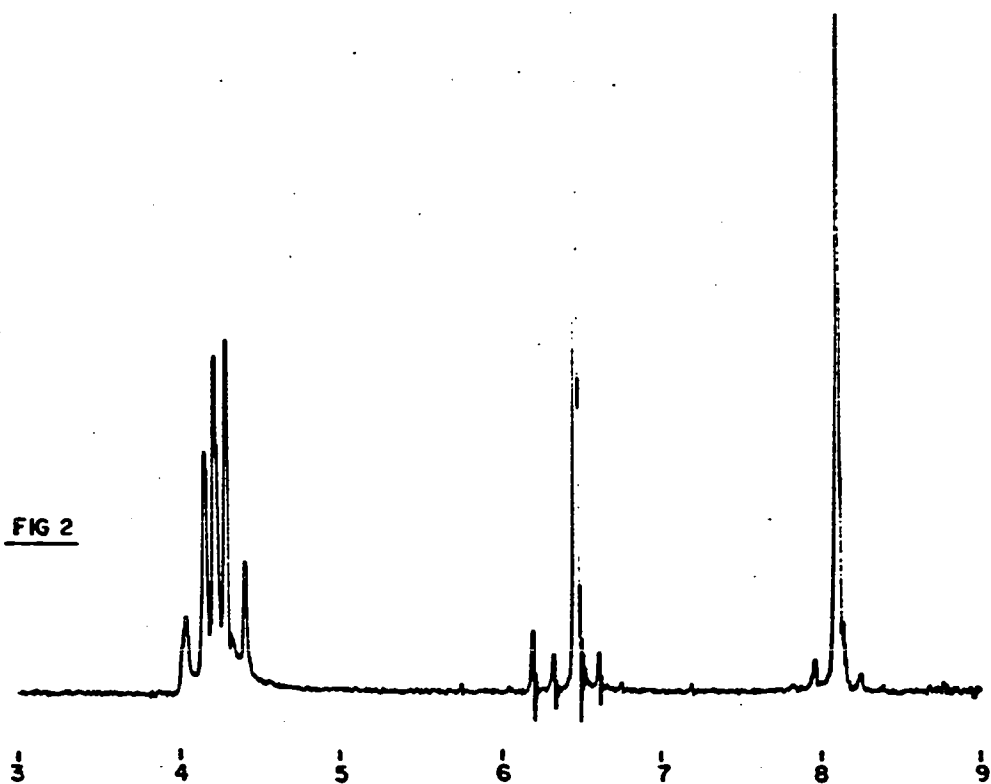

Figure 1: Nmr spectrum (100 MHz, CS_2) of XIVb-methyl ester.

Figure 2: Nmr spectrum (100 MHz, CS_2) of XIVb'-methyl ester.

of the two acids exhibited the following rates of alkaline hydrolysis in 85% (v/v) ethanol at 26.2° (these values were measured by H. Zenda):

$$k_{\text{trans}} = 81.5 \times 10^{-5} \text{ mole}^{-1} \text{ sec}^{-1}$$

$$k_{\text{cis}} = 5.9 \times 10^{-5} \text{ mole}^{-1} \text{ sec}^{-1}$$

In practice, the mixture of the two ethyl esters produced in reaction 14 was subjected to *partial* hydrolysis (80% KOH per esters). The hydrolysate was pure *trans*-acid while the neutral extract contained both isomers, the percentage of each readily determined by their nmr spectrum. This neutral extract, typically 70% *trans* isomer, was subjected to another partial hydrolysis (100% KOH per *trans* ester). The neutral extract of this reaction was mainly (> 95%) *cis*-ester.

Conversion of *trans*-acid XIVb to tosylhydrazone XIVc (reaction 16) proved to be unexceptional and could be carried out in 30-40% yield. Reaction of XIVb with oxalyl chloride (r.t. to 40°) afforded an acid chloride and reduction of the acid chloride with lithium tri-*tert*-butyloxy aluminum hydride afforded a mixture of an aldehyde and an alcohol. The percentage aldehyde was deduced from examination of the nmr spectra and was usually between 50-75%. Reaction of the aldehyde-alcohol mixture with tosylhydrazine afforded the tosylhydrazone XIVc. The nmr spectra of XIVb and XIVc exhibited similar vinylic and

cyclopropyl signals.

Kirmse had described the decomposition of bicyclic cyclopropyl tosylhydrazone sodium salts by thermal means. Since we were mainly interested in the synthesis of XI and were concerned about its survival in the reaction media, we originally decided to attempt decomposition of the sodium salt of XIVc by photolysis rather than thermolysis.

Photolysis (Pyrex filtered Hanovia arc) of the sodium salt of tosylhydrazone XIVc (XIVc + sodium methoxide in freshly distilled tetrahydrofuran) at or near 0° followed by a conventional work-up at room temperature provided a hydrocarbon mixture containing 40% VII, 25% cyclooctatetraene, 20% IX (structure IX is shown here although at the time of the report structure IX' could not be excluded - shown later), 10% VI, and traces (3-5%) of naphthalene, IV, and III as determined by glpc methods (reaction 17). Initially we did not detect the presence of III or IV in this reaction but later when a glpc of higher sensitivity and better resolution was available, the presence of small amounts of these compounds was apparent.

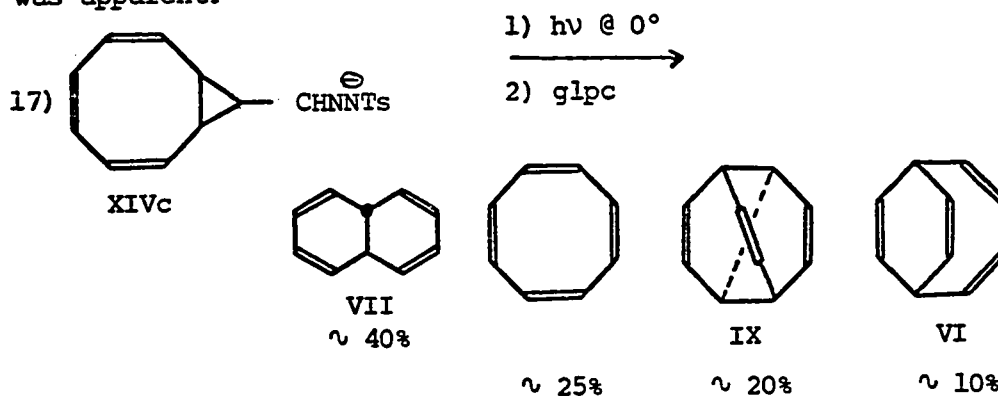

While this result was being evaluated, a report by Jones and Scott on the pyrolysis of the dry salt of XIVc was published (reaction 1, p. 7).⁸ The similarities of these two reactions (1 and 17) are noteworthy: 1) both reactions gave one expected product (cyclooctatetraene) but both did not give the other (XI) and 2) products VII and VI, although in reversed abundance, appeared in the two reactions. The production of a new (CH)₁₀ compound (IX) and the lack of a significant amount of III in reaction 17 marked the only notable difference between the two reaction sequences.

Since a later report¹⁰ described facile thermal conversion of IX to III, one might be tempted to state that IX was also formed in the pyrolysis of XIVc sodium salt but was not observed due to further thermal rearrangement to III (the observed product). Unfortunately, there is not sufficient evidence that would warrant full comment on this point at this time.

Regardless of whether IX is the precursor of the observed product III in the thermal decomposition of XIVc sodium salt or not, the photo-decomposition of XIVc sodium salt did result in trapping of a new thermally labile compound, by employing conventional glpc methods.

As previously shown from molecular orbital correlations (p. 15), compound XI was expected to undergo thermal rearrangement to VII. The formation of major amounts of VII in reaction 17 thus indicated probable direct formation of XI followed by thermal rearrangement to VII. Therefore an effort was made to carry out the entire work-up

procedure under milder conditions with the hope of detecting the desired product XI. By maintaining the temperature of the work-up procedure (distillations and extractions) at 0° followed by purification with chromatography over alumina (at 10 ~ 15°) our efforts were rewarded in the observation of a new (CH)₁₀ compound, assigned the structure of the desired product XI, at the expense of VII and naphthalene (reaction 18).

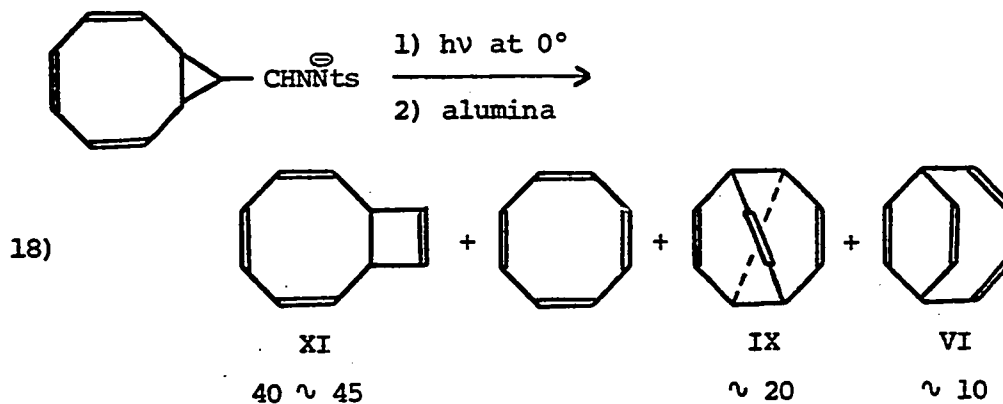

Both spectral and chemical evidences were compatible with the structure assignment of XI. (See p. 25 for the mass and nmr spectra of XI).

The new compound was C₁₀H₁₀ as demonstrated by its mass spectrum. The peak at *m/e* 130 was 20% as intense as the M-1 base peak and therefore only 50% of this 130 peak consisted of the parent ion (C₁₀H₁₀). In fact, the measured mass was *m/e* 130.1758 which corresponded to the weight average of C₉¹³CH₉ (calc'd. 130.0738) and C₁₀H₁₀ (calc'd. 130.0783). The base peak was measured as C₁₀H₉ (found, *m/e* 129.0704; calc'd. for C₁₀H₉, 129.0704).

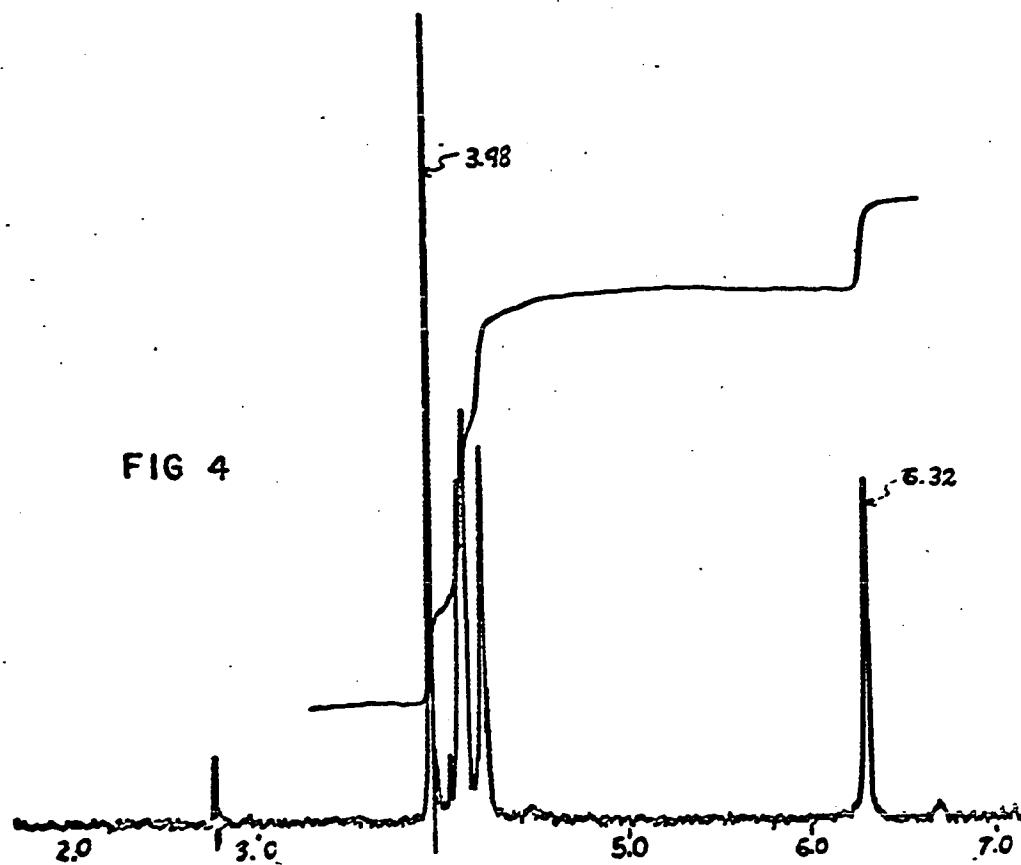
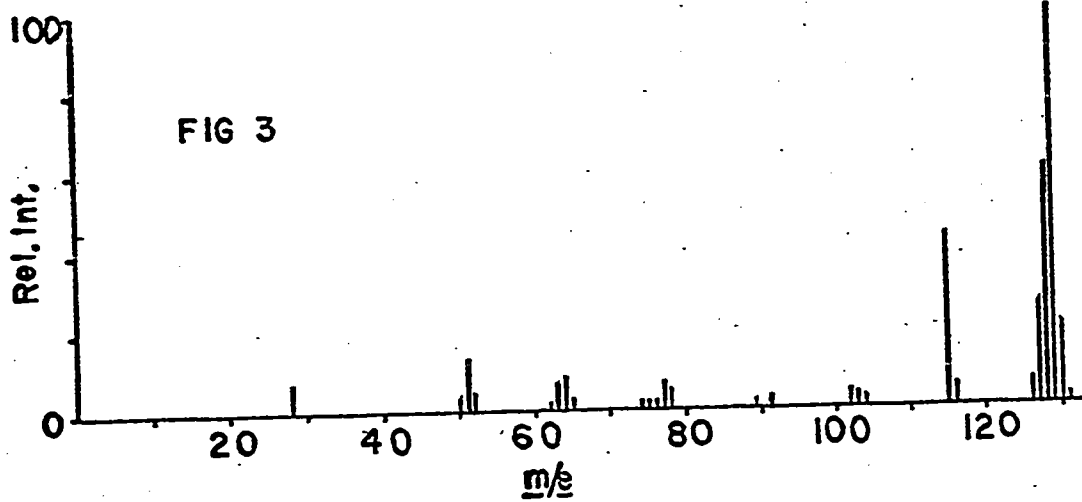

Figure 3: Mass spectrum (MS-9) of XI.

Figure 4: Nmr spectrum (100 MHz, CDCl_3) of XI.

The uv spectrum is compatible with structure XI. Compound XI exhibits absorption at $\lambda_{\text{max}}^{\text{methylcyclohexane}}$ 253 m μ , $\epsilon = 2050$. This value is considered more accurate than the preliminary one reported.

The nmr spectrum demonstrated XI to be bicyclic (8 olefinic protons and 2 allylic protons). Other noteworthy features of the nmr spectrum were a singlet ($\tau 3.98$, 2H) characteristic of symmetrically (σ) disposed cyclobutenes^{19,21} indicating σ molecular symmetry, and olefinic signals ($\tau 4.1$ 4.3, 6H) resembling all the triene precursors.

Catalytic hydrogenation of XI provided bicyclo[6.2.0]decane (reaction 19, carried out by C. Chin).

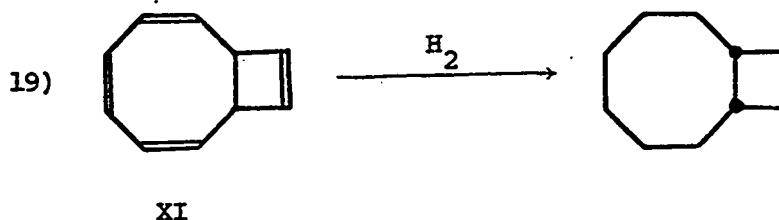

Authentic bicyclo[6.2.0]decane for comparison purposes was prepared by two separate routes. Catalytic hydrogenation of the major product of the pyrolysis of the sodium salt of bicyclo[6.1.0]nona-4-ene-9-carboxaldehyde tosylhydrazone and catalytic hydrogenation of bicyclo[6.2.0]deca-1,7,9-triene both provided material identical to that produced in reaction 19. Reactions 20 were carried out by C. Chin and K. Hojo.

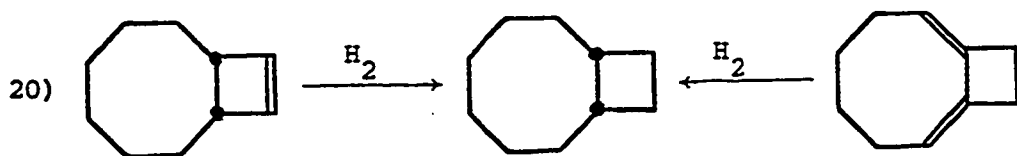

The structural elucidation of compound IX was more involved than that of XI. The nmr spectrum of IX consisted of five groups, all complex multiplets of equal intensity. The signal groups were centered at τ 3.32, 4.08, 4.40, 6.85 and 7.53. Irradiation of the two high field groups (due to allylic protons) caused the collapse of the τ 4.08 signal to a singlet and reduced the other olefinic signals to a typical AX pattern. Irradiation at τ 3.32 and τ 6.85 caused the τ 4.08 and τ 7.53 groups to exhibit symmetrical patterns typical of AA'XX' protons. Either structure, IX or IX', is compatible with this nmr spectrum as shown:

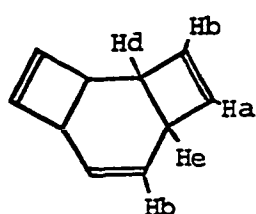

IX'

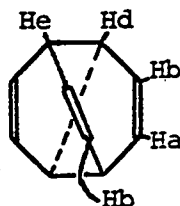

IX

Ha = τ 3.32Hb = τ 4.08Hc = τ 4.40Hd = τ 6.85He = τ 7.53

The original chemical evidence was insufficient to differentiate these two structures. Appearance of this compound in the photolysate containing XI as the major product favors structural

assignment IX'. However, formation of this compound by photolysis of bullvalene favors structural assignment IX.

In order to establish the structure of this compound, the corresponding hexahydro derivative was prepared by catalytic hydrogenation. This derivative was shown to be identical to the hydrocarbon prepared by reductive debromination of *cis*-2,6-dimethylenebromide-bicyclo[3.3.0]octane (reactions 21 carried out by M. Weisel).³⁷ This chemical sequence established the structural assignment IX for this compound.¹¹

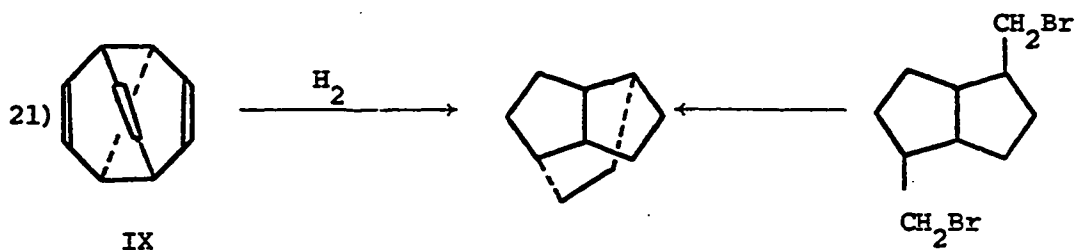

After isolation of the expected product (XI) and completion of the structural assignment for another product IX, attention was turned to a mechanistic interpretation of this photolytic decomposition of the sodium salt of XIVc. One unusual feature of this reaction is that in spite of the fact that XI is rapidly converted to VI and other products under the same photolytic conditions, XI was produced as the *major* product of the reaction. Doubling the reaction time did not appreciably affect the product distribution. Survival of XI in the reaction can be rationalized in the following manner. The formation of finely divided sodium

sulfinate as the reaction proceeded greatly reduced the transparency of the reaction media and prevented further photolysis of the products.

In the photolytic decomposition of XIVc sodium salt, a cyclopropyl carbene may be expected to undergo σ bond cleavage to a diradical species (XVI), which undergoes bond formation at different points on the eight member ring to form directly products XI, IX, and VI (reaction scheme 22):

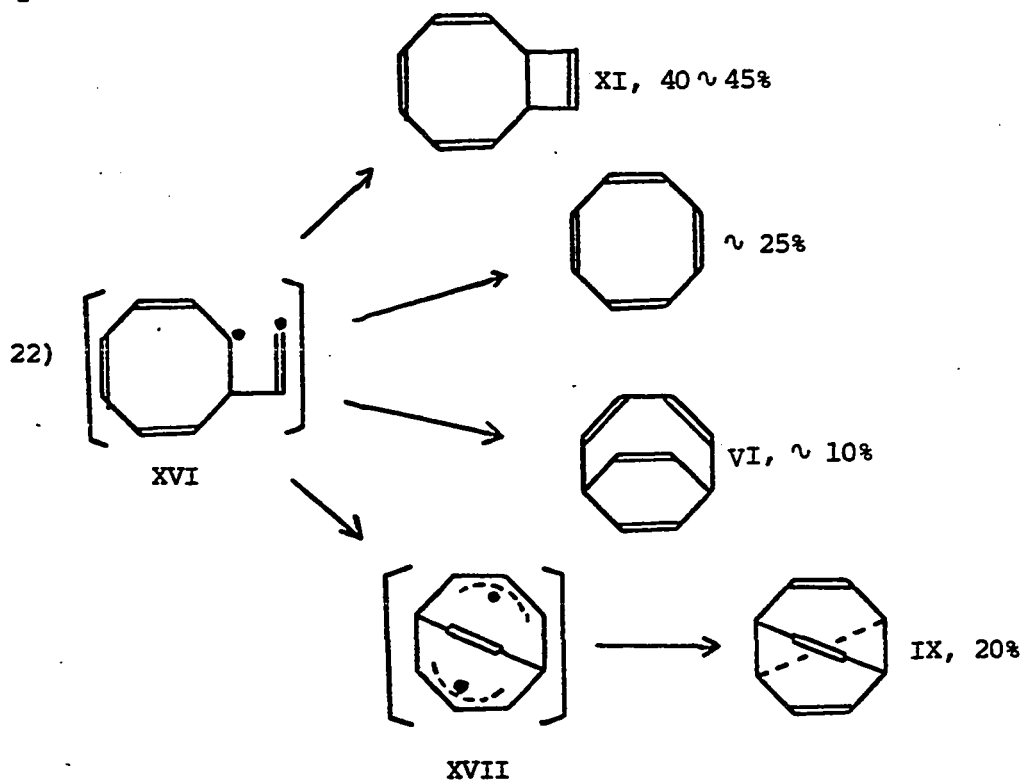

Later, other evidence was put forward for this mechanism by other workers in this laboratory. Use of deuterio-ethyl azoacetic ester in the reactions on p. 19 provided 9-deuterio tosylhydrazone XIVc. Photolysis of this specifically labeled

tosylhydrazone sodium salt yielded 9-deuterio-XI (by M. Wiesel) and 7-deuterio-VI (by N. Nakatsuka). Isolation of these *specifically* labeled compounds indicated their direct formation via diradical species XVI rather than formation by further photolysis of another directly formed product.

This reaction sequence proposed for the photolytic decomposition of XIVc sodium salt may possess superficial similarity to that eventually proposed by Jones¹⁴ for the *thermal* decomposition of this salt. Diradical intermediate XVI was proposed in both reactions. However, it should be noted that in the thermal reaction such diradical intermediates can only be vibrationally excited while in the photo-reaction they would probably be electronically excited. In particular, intermediate XVII *resembles* intermediates involved in thermal processes¹¹, but since it is probably electronically excited in reaction scheme 22 it undergoes collapse to IX rather than bullvalene. It must be emphasized that this is only a tentative account of the nature of the diradical XVII. Further work is in progress in this laboratory involving deuterium labeling experiments.

In order to carry out further investigations of compound XI, new purification methods had to be developed. The work-up procedure (alumina chromatography) was adequate for the initial work. However, it had drawbacks: large amounts of alumina were required (200 g. alumina per 100 mg. photolysate) and material loss was

noted in proportion to the amount of alumina used during chromatography.

Two techniques that proved complementary to the alumina chromatography procedure were fractional distillation and silver nitrate extraction. Fractional distillation could be accomplished with the apparatus described in Chapter 3 and provided fractions enriched in XI. The other procedure, silver nitrate extraction, also provided fractions further enriched in XI. Even though all the hydrocarbons in the photolysate formed silver nitrate complexes, by virtue of differing equilibrium values the complexes were preferentially formed or could be fractionally extracted with ether from aqueous solutions. The relative equilibrium constants for

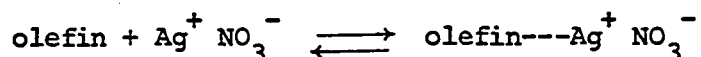

were deduced as $K_{\text{IX}} > K_{\text{cyclooctatetraene}} > K_{\text{XI}} > K_{\text{VI}}$. It is of interest that the order of equilibrium constants is opposite to the order of retention times on alumina (pentane).

Typically then, first the photolysate (14-18% hydrocarbon yield) was subjected to fractional distillation, silver nitrate complex formation, and then a final purification through a short column of alumina (50 g./600 mg. hydrocarbon) yielding pure XI (60% of the amount produced in the reaction).

B. Photochemical reactions of some (CH)₁₀ compounds³⁵

Our attention was originally directed towards the photochemical behavior of bicyclo[6.2.0]deca-2,4,6,9-tetraene (XI). However, as the project developed it became necessary to include examinations of the photochemical behavior of *cis*- and *trans*-9,10-dihydronaphthalenes (III and VII).

The preparation of XI has been described. Thermolysis of XI in a suitable solvent provided a solution of pure VII (as shown later). The reported synthesis of VII by van Tamelen and Burkoth⁹ was not reproducible in our hands. To prepare III, the procedure devised by Doering and Rosenthal¹⁵ was utilized (pyrolysis of bullvalene in a flow system) since the original synthesis of III reported by van Tamelen and Pappas⁵ was tedious and impractical. Although preparative glpc could be used to isolate III from the crude pyrolysis product, a faster and more reliable procedure proved to be fractional distillation. Remarkably good separation of III from 1,2-dihydronaphthalene and naphthalene was achieved (apparatus described in Chapter 3). However, if other thermal products were allowed to build up (reaction 7, p. 11) alumina chromatography could be employed with good results. Compound III was stored in solution at -40° in order to prevent reaction 7 (p. 11).

The preliminary work on the photochemical behavior of XI was carried out in a typical photo-apparatus consisting of a quartz

envelope around a spiral-shaped low pressure (2537A) mercury lamp fitted with a 200 ml vessel. Irradiation of XI at -35° for 6.0 minutes followed by distillation at 0° produced a 40% w/w yield of hydrocarbons. A similar photolysis was performed for a longer irradiation time (10.0 minutes). Analysis of the photo-product by nmr and glpc revealed the following product distribution (reaction 23). Both runs contained very little XI in the product mixture.

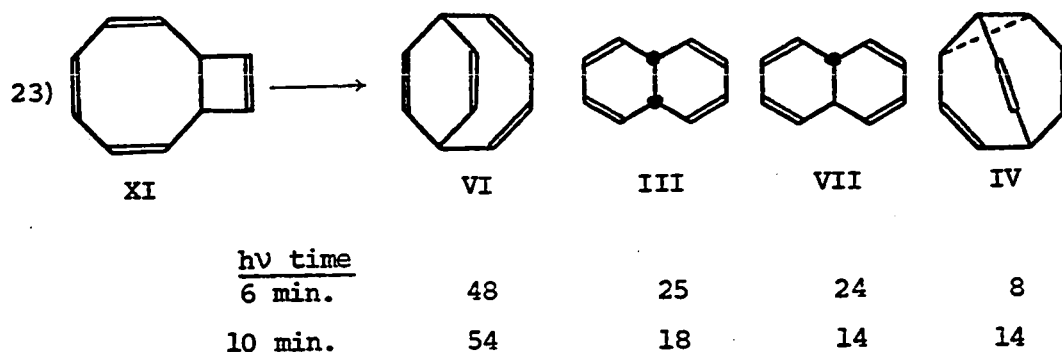

An interesting result of this photolysis to us, at this time, was the presence of both VII and III in the photo-product. The other noticeable feature of these reactions was the formation of VI in major amounts. Work in this laboratory and a report by Jones showed that photolysis of VI under these conditions proceeded very rapidly to provide bullvalene.⁸ If VI were present in this reaction while the lamp was on, one would expect little VI to survive. However, in both photolysis experiments (6.0 minutes and 10.0 minutes) the major portion of the product was VI. This result strongly suggested that there existed an

intermediate that was photochemically "inert" but which thermally isomerized to VI during the work-up procedure (at 0°).

Before carrying out further investigation of the photochemical behavior of these $(\text{CH})_{10}$ hydrocarbons, we had to refine the photolysis procedure to handle thermally unstable compounds. It was clear that a work-up procedure or means of detection had to be carried out at -35° or lower in order to identify the thermally unstable intermediate in this reaction. Also, for practical purposes a reasonably simple work-up procedure was desired. To fulfill these two needs, 1) reactions were carried out in quartz nmr tubes in order to observe directly the progress of the reaction, 2) a means of controlling the temperature of the nmr tube during photolysis was found, and 3) a spiral-type low pressure lamp and cylindrical mirror served to concentrate the light flux. This apparatus is shown on pp. 35, 36 and 37.

Typically, for an analytical experiment a $(\text{CH})_{10}$ compound was dissolved in a suitable solvent in a quartz nmr tube and was degassed by freeze-thaw cycles on a high vacuum rack and the tube sealed. Once the sample was so prepared, the procedure of a photolysis experiment was extremely simple - photolyze at an accurately determined temperature for a certain length of time and transfer the nmr tube to a pre-cooled nmr spectrometer. The utter simplicity of this experimental procedure allowed us to carry out seemingly delicate photolytical experiments with consistency.

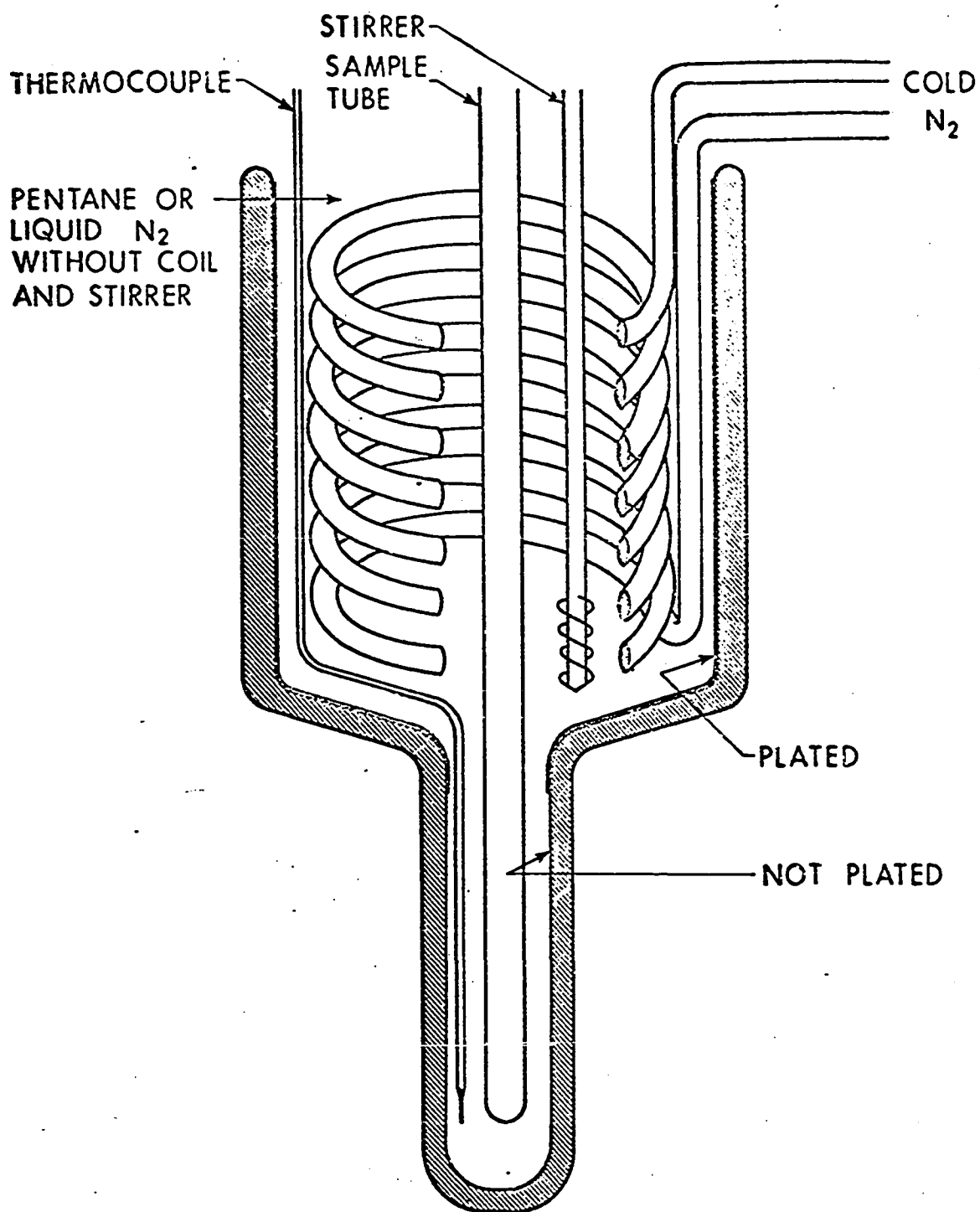

FIG 5 COOLING SYSTEM

(THIS DEWAR BOTTLE OR VARIAN VARIABLE TEMPERATURE ACCESSORY ASSEMBLY FOR V-4502 EPR)

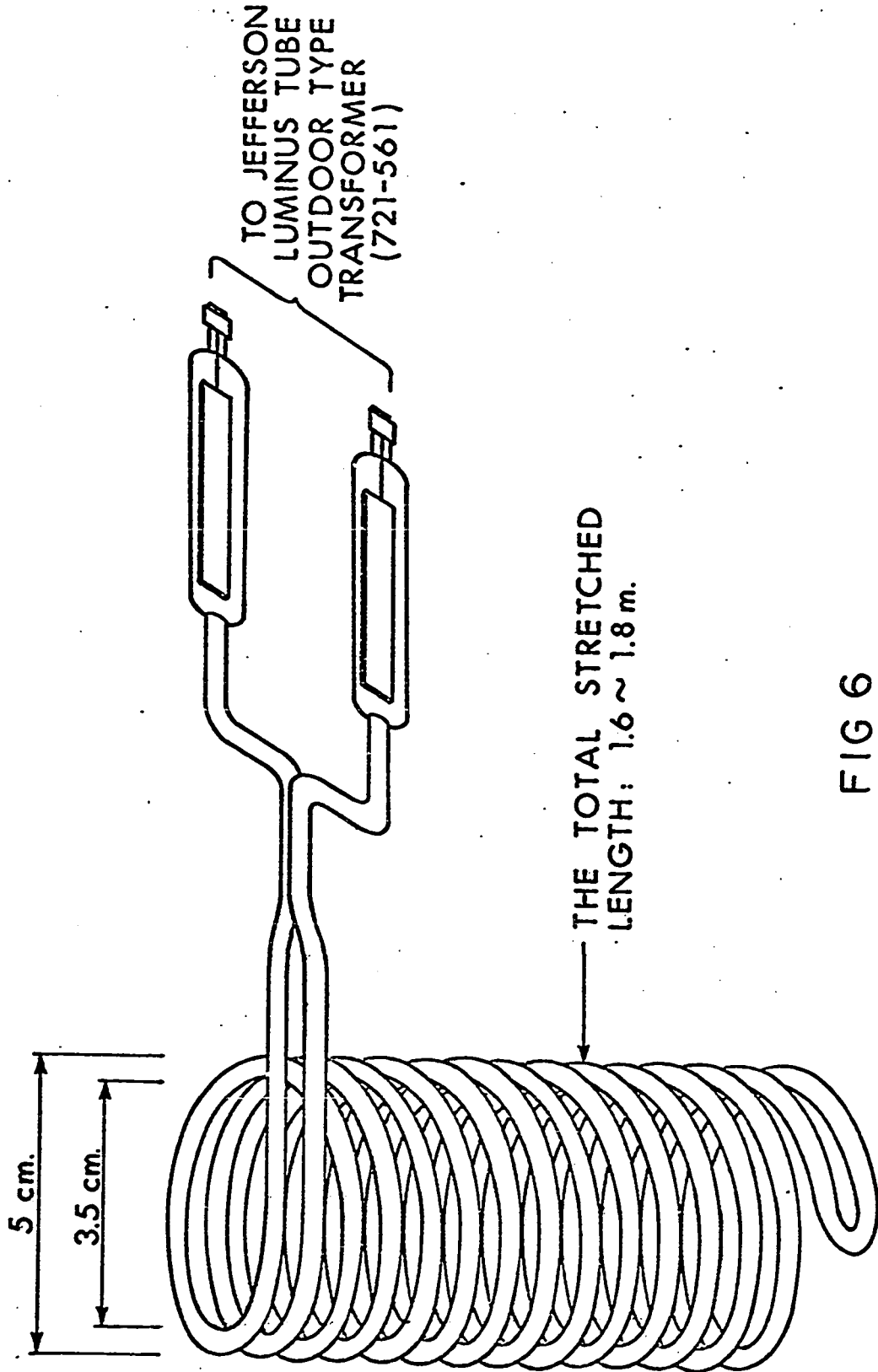

FIG 6
LOW PRESSURE MERCURY LAMP

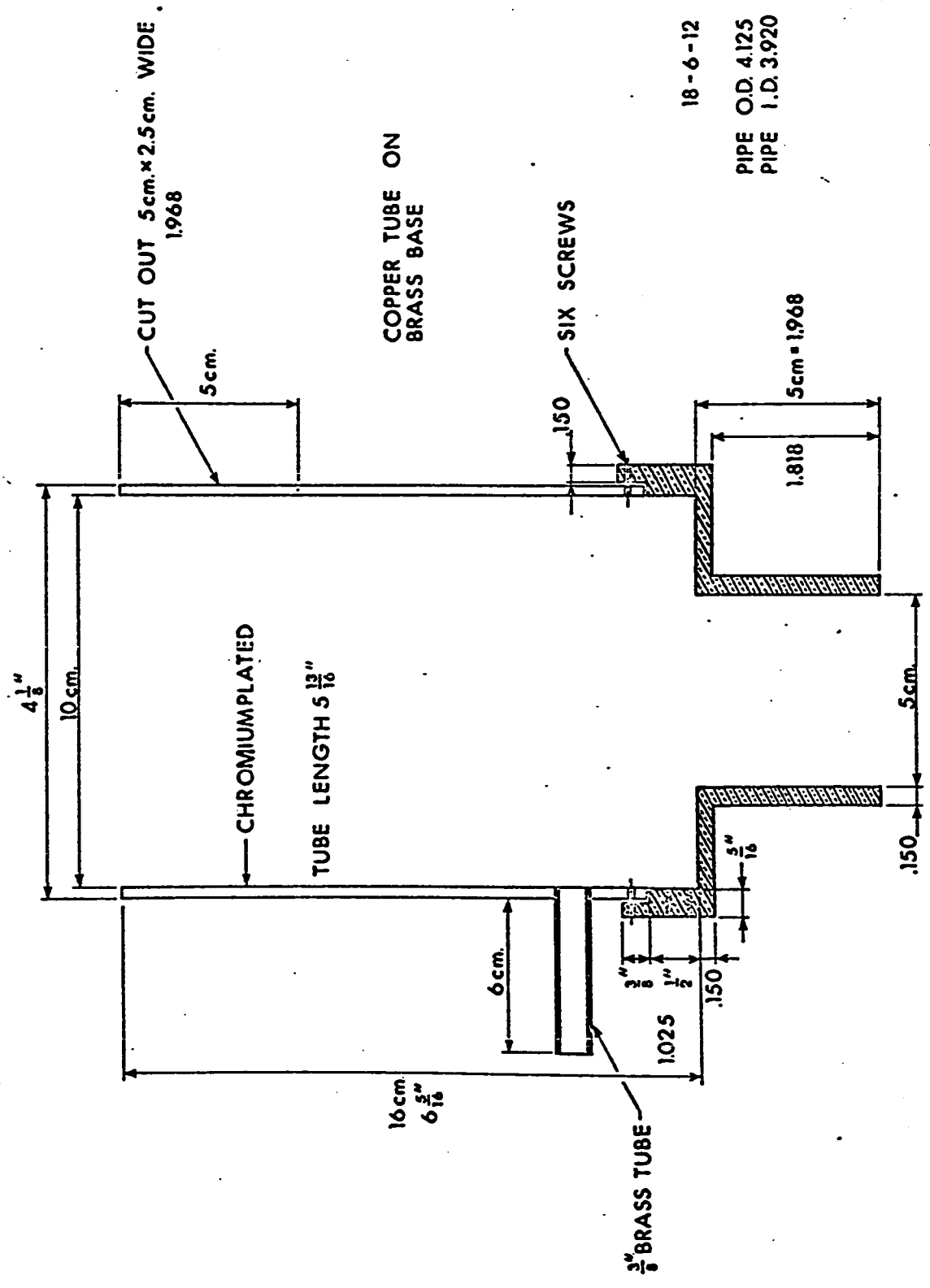

FIG 7 REFLECTION MIRROR

Irradiation at 2537Å of a 0.25 M solution of XI in d_8 -tetrahydrofuran with our new photolysis apparatus resulted in the disappearance of starting material as shown by nmr spectra taken periodically. When the photolysis reaction temperature was kept at -110° , compound XI disappeared with a first half life of approximately 30 minutes. At the point at which no further change was measurable, nmr spectra of the photolysate demonstrated the presence ($\pm 5\%$) of III (8%), VI (19%), IV (7%) and a *new compound* (65%). When the sample tube was warmed to 0° for a few minutes and the nmr spectrum rerun at -70° , the formation of VI (65%) was apparent at the expense of the new compound. (See p.39 for these two nmr spectra). The glpc trace of the photolysate showed the presence of III, VI, IV and VII in the same percentages. Thus, by carrying out the photolysis of XI in our new apparatus at low temperatures, observation of the thermally unstable precursor of VI was achieved.

Nmr and chemical evidence demonstrated that this new thermally unstable $(CH)_{10}$ compound was indeed tetracyclo[4.4.0.0^{2,10}.0^{5,7}]deca-3,8-diene (X). Subtraction from the nmr spectra of the photolysate of signals due to the minor products, leaves the nmr spectra of tetracyclo X. Compound X exhibited signals at $\tau 4.2$ (broad singlet, 4H), $\tau 8.5$ (complex, 2H), and $\tau 8.8$ (broad, 4H). Irradiation of the signal at $\tau 4.2$ affected the shape of the signal at $\tau 8.77$ without appreciably changing the signal at $\tau 8.47$. Conversely, irradiation of the high

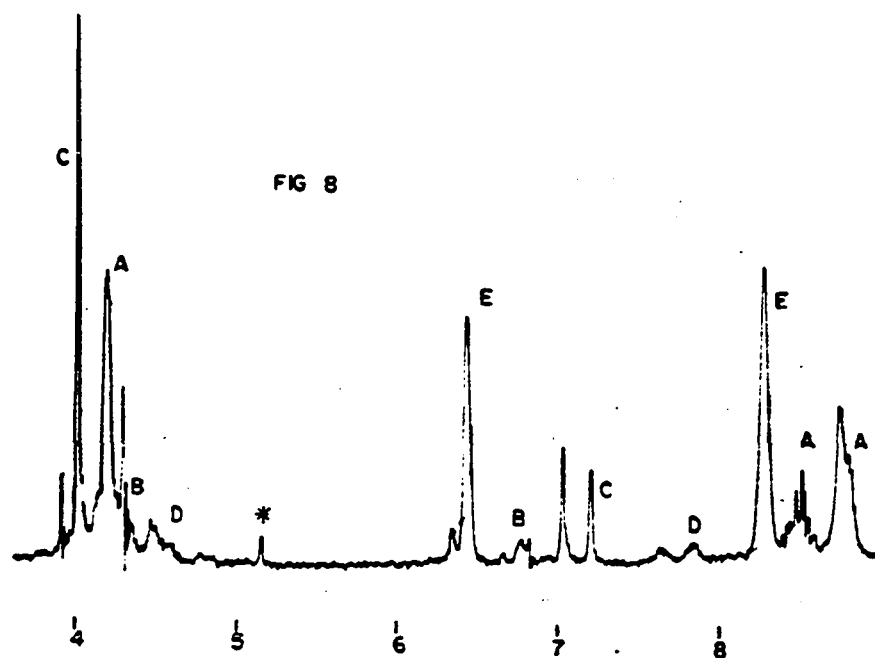
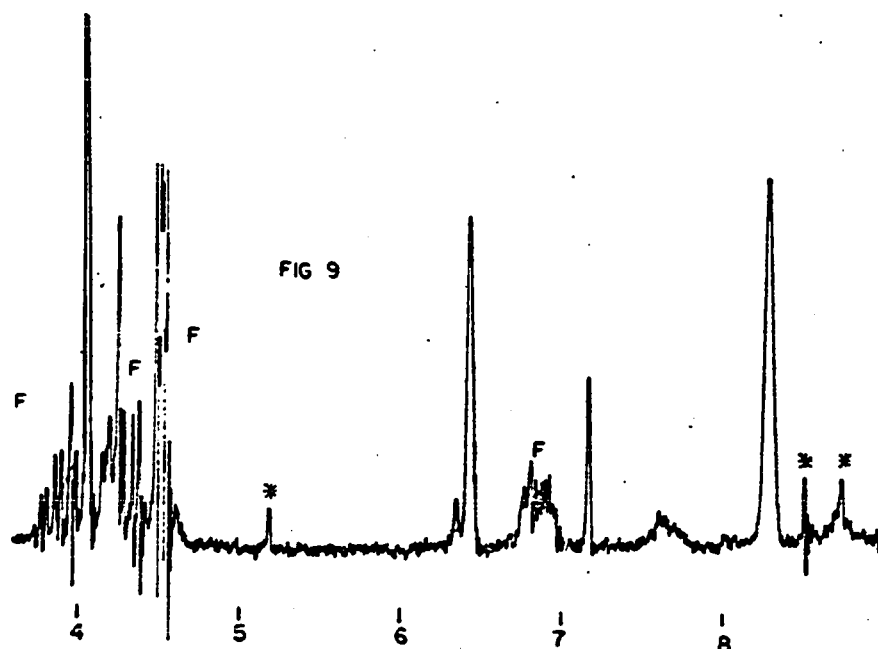
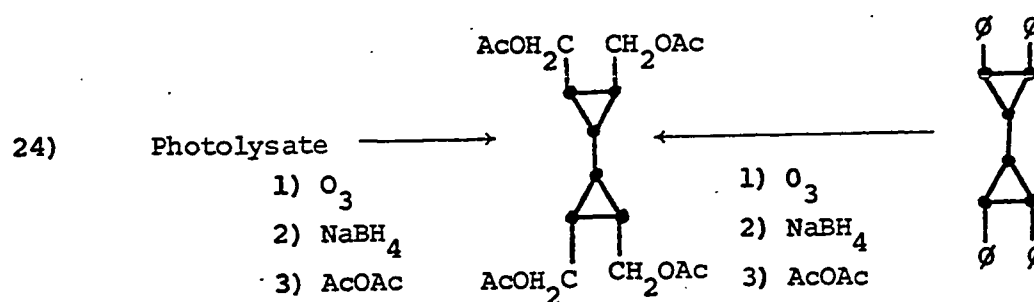

Figure 8: Nmr of photolysate of XI (100 MHz, d_8 -tetrahydrofuran),
A: X, B: III, C: VII, D: IV, E: partially deuterated
tetrahydrofuran.

Figure 9: Nmr of sample shown in Figure 8 after warming and
recoiling, F: VI, *: impurities.

field signals sharpened the singlet at $\tau 4.2$ to a width of 1Hz at half height. The double irradiation results exclude conjugated diene structures as possibilities for the new compound. Of the non-conjugated diene structures (both vinylic groups of hydrogens with the same chemical shift), only X appears compatible with facile thermal reaction of the new compound to VI.

Ozonolysis of the photolysate (at -80°) followed by reductive work-up provided an all-*cis*-tetraol-tetraacetate that was identical to one synthesized by ozonolysis of 3,3'-bis(Δ^1 -1,2-diphenylcyclopropyl) (reactions 24 carried out by M. Wiesel and N. Nakatsuka).³⁸



Only two $(CH)_{10}$ structures are compatible with the ozonolysis experiments: X and i



X

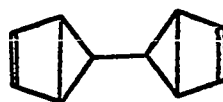

i

Obviously, facile thermal rearrangement of I to VI is extremely unlikely.

All attempts to reduce X to the corresponding saturated hydrocarbon, tetracyclo[4.4.0.0^{2,10}.0^{5,7}]decane, with diimide at low temperature proved futile. Preliminary experiments with reduction by diimide at low temperature had demonstrated limited effectiveness of this reagent. In fact, when bullvalene was subjected to diimide (100-fold molar, generated by $\text{KOOCN}=\text{NCOOK} + \text{acetic acid}$) reduction at -27° , only 50% yield of hexahydro-bullvalene could be isolated, while the completion of the reduction at room temperature required as much as 100-fold molar excess of diimide. In view of this result, we had reservations on the general effectiveness of diimide reduction especially at low temperature. With this in mind, the reduction of the material formed by photolysis of XI at -110° was attempted under conditions that would maximize the probability of reduction. Reductions of this photolysate were carried out with 200-fold molar diimide at two temperatures: -27° and -44° . Careful alumina chromatography and glpc work-up followed both these reactions. However, in neither of these reactions could a meaningful amount ($\geq 5\%$ yield) of tetrahydro-X be detected. Only fully and partially reduced VI, attributed to X, were isolated. Reaction of the double bonds in X with diimide could not compete with the facile thermal reaction of X to VI.

Although reduction of X to its corresponding saturated parent hydrocarbon (a usual structure proof procedure) with diimide was unsuccessful, ample other evidence had already been gathered for our structural assignment. To summarize our evidence for this structure, (1) the nmr spectrum and spin decoupling experiments demonstrate the compound to be non-conjugated and tetracyclic, (2) facile thermal isomerization to VI agrees with the assignment, and (3) ozonolysis experiments dictate X as the only structure agreeing with point (2).

With the structure of the major product secure, we turned our attention to how it was formed in the photolysis of XI. For initial experiments into this aspect, it was decided to photolyze the other major products of this reaction (III and IV). To our surprise, photolysis of both these compounds gave similar product distributions as in the photolysis of XI (reactions 25). (See p. 43 for the nmr spectra from the photolysis of III).

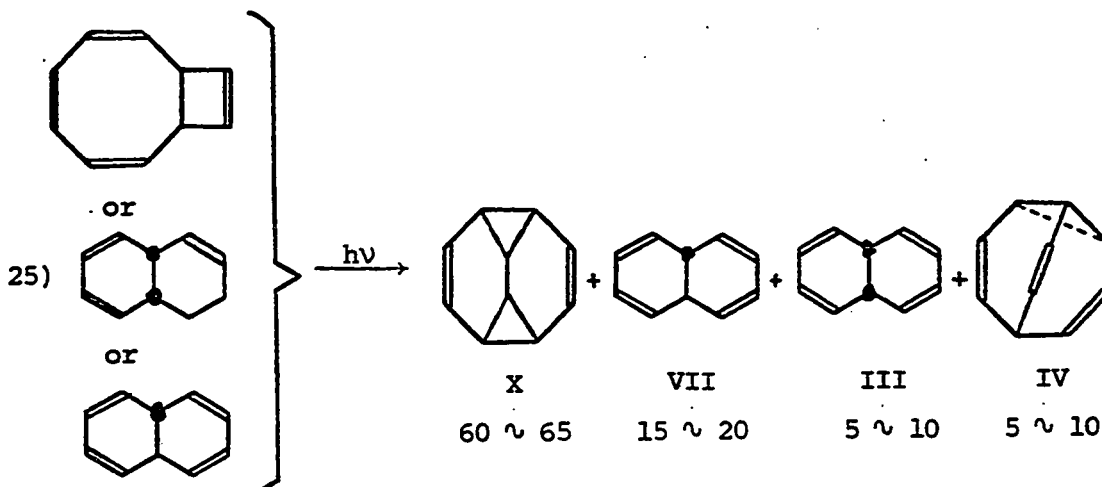

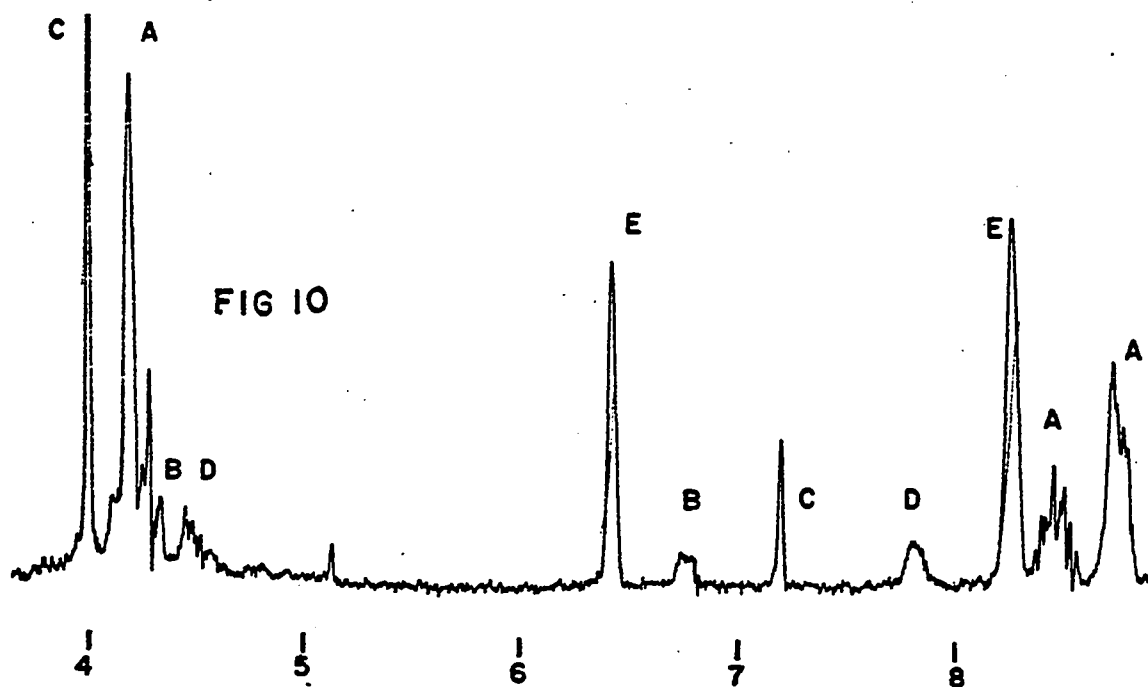
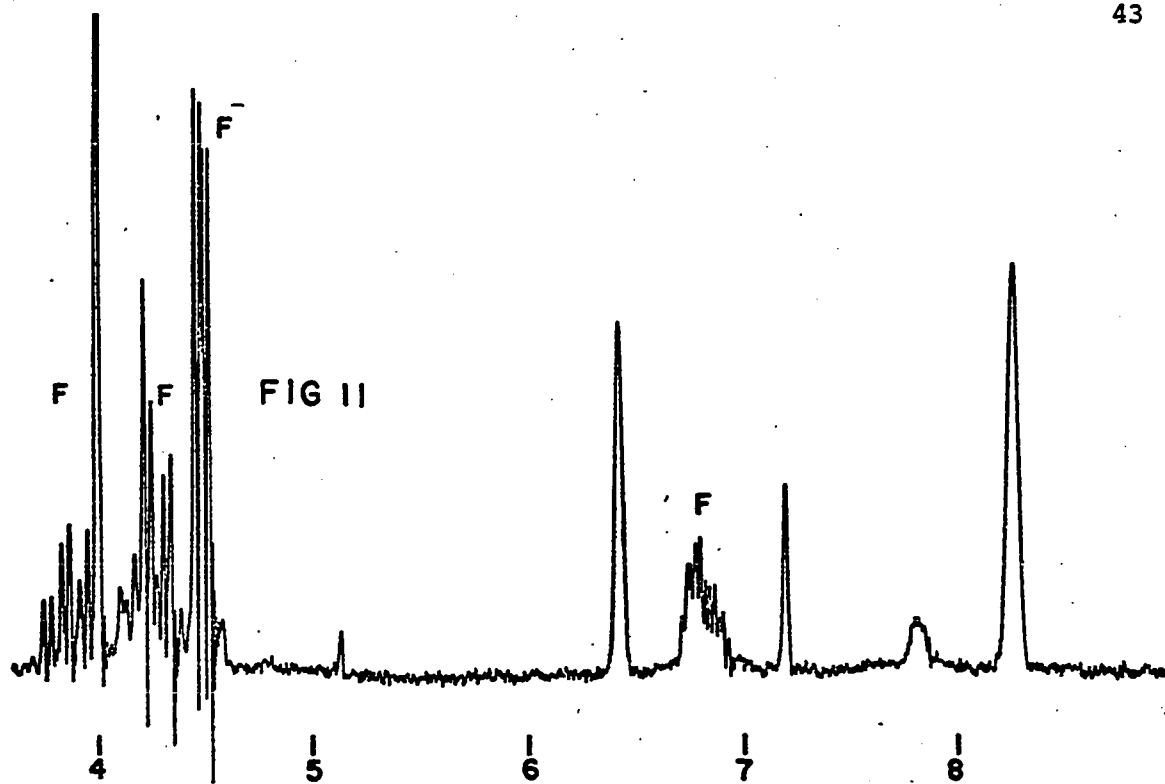

Figure 10: Nmr of photolysate of III (100 MHz, d_8 -tetrahydrofuran)
 A: X., B: III, C: VII, D: IV, E: partially deuterated tetrahydrofuran.

Figure 11: Nmr of sample shown in Figure 10 after warming and recooling, F: VI.

The relative photo-inertness of X easily accounts for its accumulation as the major product in the reaction media. Electrocyclic ring closure (4 + 4, σ symmetry) reaction of III offers the simplest and most reasonable explanation for its formation. Babad, Ginsburg and Rubin³⁰ observed 4 + 4 electrocyclic ring closure in a derivative of X. However, the appearance of both III and VII in the photolysate is less easily explained. By the same token, formation of X from XI and VII is not obvious. As can be seen from application of the Woodward-Hoffmann selection rules, no photochemical correlation can link III with VII (p. 45). But since no thermal reactions are occurring at temperatures below -50° (shown later), only photochemical reaction(s) can account for these results. Two alternative reaction types can rationalize such photochemical behavior:

i) If the reactions are occurring according to selection rules (p. 45), then these results (for instance, formation of III from VII) require that photo-induced interconversion of the [10]annulenes is occurring.

ii) If the reactions are not obeying the selection rules, then photochemical ring opening of III or VII would proceed in a non-stereospecific (random) manner. For instance, the molecular orbital correlations carried out on p. 16 indicate that opening of III to XIII (disrotatory) can occur not only thermally but also photochemically depending

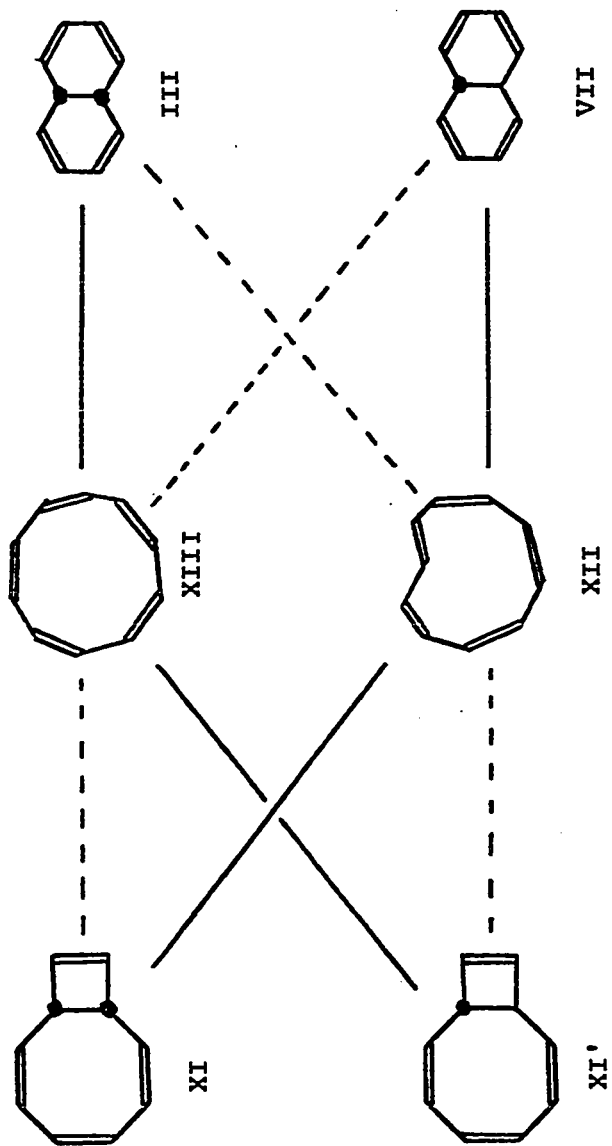

Selection Rules for Some (CH)₁₀ Reactions

----- photochemical transformations

----- thermal transformations

upon the relative heights of the energy levels. Logically, if random opening occurs with III (photochemical opening in conrotatory *and* disrotatory modes), random opening of VII cannot be excluded.

To elucidate these photochemical processes in reactions 25 and arrive at one of the two alternative explanations, the full flexibility of the photo-apparatus was tested. The photo apparatus offered three alternative options that could be employed in the investigative procedure. Using nmr spectroscopy the reaction could be easily followed throughout its course. Other lamp sources could be used without extensive modification, and different photolysis temperatures were readily attainable.

Examination by nmr of the early stages of the photolyses at -110° revealed no significant amounts of possible transitory intermediates. The lack of initial build up implied efficient photoconversion of these intermediates. Examination of the latter stages of the reactions where all three photolysates tended towards the same product distribution, (exact product distribution might be valuable to demonstrate a photoequilibrium) was hampered by gradual darkening of the photolysate to cyclooctatetraene yellow.

Irradiation of III or VII with Corex (0% transparent at 250 m μ , 50% transparent at 280 m μ) filtered light from a high pressure mercury arc (HBO 200W lamp), produced a photolysate

which contained only a negligible amount of VII. Since pure VII exhibits a λ_{max} 276 (shown later) as compared to III exhibiting a λ_{max} 247. The higher wavelength irradiation by Corex filtered light increases the photo efficiency of ring opening of VII and thereby more effectively competing with its formation.

Photolysis of compounds III, VII, and XI at different temperatures furnished by far the major amount of information about the photochemical processes occurring in this system. Of course, a photolysis experiment carried out above -35° should produce (at least) a significantly different product distribution due to the formation of VI in the photolysate. In addition, our experiments demonstrated two significant results (see p. 48 for a summary):

i) All compounds tested (III, VII and XI) exhibited temperature dependent rates of disappearance. The significantly different first half lives of each of these compounds under irradiation at -60° and -110° illustrates this. Also, signifying a consequence of temperature dependence, all compounds (III, VII and XI) were found to proceed extremely slowly when irradiation of these compounds in a clear glass (50% d_8 -tetrahydrofuran, 50% d_6 -ethanol) at -190° was performed. (Irradiation at -110° in 50% d_8 -tetrahydrofuran and 50% d_6 -ethanol was found to proceed at the same rate as the same irradiation in 100% d_8 -tetrahydrofuran).

Table 2
Photochemical Reactions of III, XI and VII

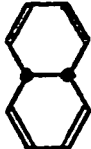
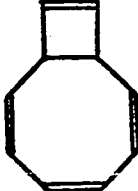
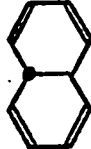
Starting Material*	Irrad. Temp.	First Half Life (Mins)	Product Distribution After x Mins' Irradiation**							x	
			X	III	VII	IV	XIII	XII			
	III	-190	-	0	100	0	0	0	0	0	420
	III	-110	35	65	8	19	7	tr.	0	240	
	III	-60	12	40	15	0	23	7	15	80	
	III	0	7	(40% of VI)	18	15	25	0	0	80	
	XI	-190	-	0	0	0	0	0	0	0	420
	XI	-110	40	63	11	13	10	tr.	0	180	
	XI	-60	16	60	10	17	6	1-2	0	85	
	VII	-190	-	0	0	100	0	0	0	0	480
	VII	-110	90	55	10	30	5	tr.	0	120	
	VII	-60	55	55	14	22	7	1-2	0	180	

* .35 to .45 M, in tetrahydrofuran-d₈ for -60° and -110° irradiation or in 1:1 tetrahydrofuran-d₈ ethanol-d₆ for -190° and -110° irradiation with a low pressure mercury lamp.

** by nmr integration and verified by g.l.c. (in consideration of reactions X → VI, XIII → III, XII → VII).

To account for temperature dependent rates, an energy barrier has to be surmounted. Thus, in the initial photochemical process(es) of compounds III, VII and XI there intervenes an energy barrier between the *excited state* of III, VII and XI and the *excited state* of their first photo product, and these photo process(es) are *not* isoenergetic.

ii) Appreciable amounts of two new $(\text{CH})_{10}$ compounds occurred *only* in the photolysis of III at -60° . We were extremely pleased to learn from nmr spectral and chemical evidence that these new compounds were *cis*⁵[10]annulene (XIII) and *trans-cis*⁴[10]annulene (XII).

In order to provide a sample enriched in these two new compounds, the irradiation of a concentrated deuterio-3-methylpentane solution of III (ca. 1.0 M) was carried out at -60° . Cooling the resulting photolysate to -100° produced crystalline precipitates. The mother liquors were withdrawn by a pre-cooled pipette and quickly transferred to a pre-cooled nmr tube. The wet crystalline precipitates were taken up in cold (-80°) d_8 -tetrahydrofuran and nmr and glpc analysis of the resulting solution indicated that these precipitates consisted of mainly X, IV and a small amount of III.

Examination of the nmr spectra of the deuterio-3-methylpentane mother liquors showed that suitable enrichment of the new compounds was achieved by precipitation and removal of

X and IV. The nmr spectrum taken at -40° of the mother liquors is shown on p. 51. In the region $\tau 0-10$ only two new peaks were apparent. A sharp singlet at $\tau 4.34$ attributed to compound B was temperature independent in the region -40° to -80° . A broad singlet at $\tau 4.16$ (-40°), attributed to another compound A, was reproducibly temperature dependent in that it tended to broaden and the peak top exhibited a slight upfield shift with lower temperatures. Upon warming the sample (-25° , 2 hr.), formation of VII ($\tau 4.11$ (8H), $\tau 7.2$ (2H)) occurred at the expense of A (p. 52). Further warming (-10° , 2 hr.) demonstrated the formation of VI at the expense of X and increased the intensity of III at the sacrifice of B at a slightly slower rate (p. 53). The final product distribution was confirmed by glpc.

Interpretation of the nmr spectra is as follows: signal B ($\tau 4.34$, sharp singlet) is due to (*cis*)⁵[10]annulene (XIII) and signal A ($\tau 4.16$, broad singlet) is due to *trans*-(*cis*)⁴[10]annulene (XII). The stereospecific reactions observed on gradual warming of the nmr samples were then reactions 26 and 27.

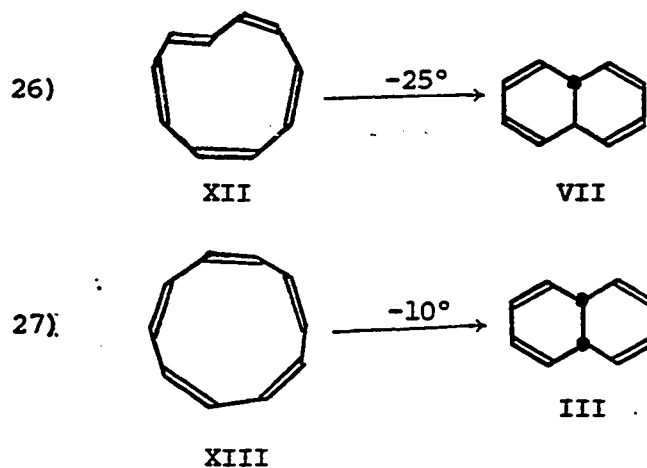

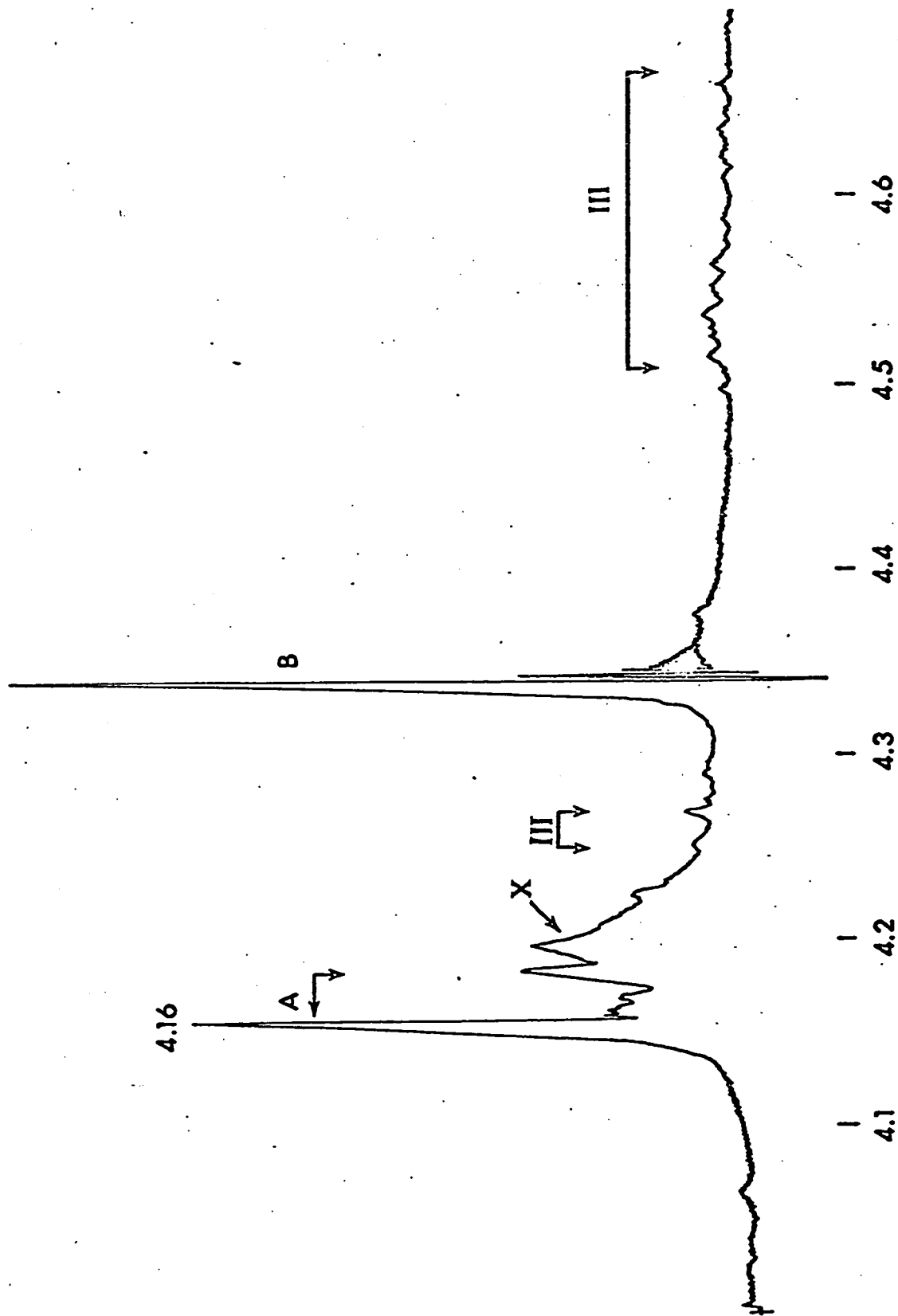

Figure 12: Nmr spectra (100 MHz, -40°) of mother liquors of photolysate of III (from -60° photolysis).

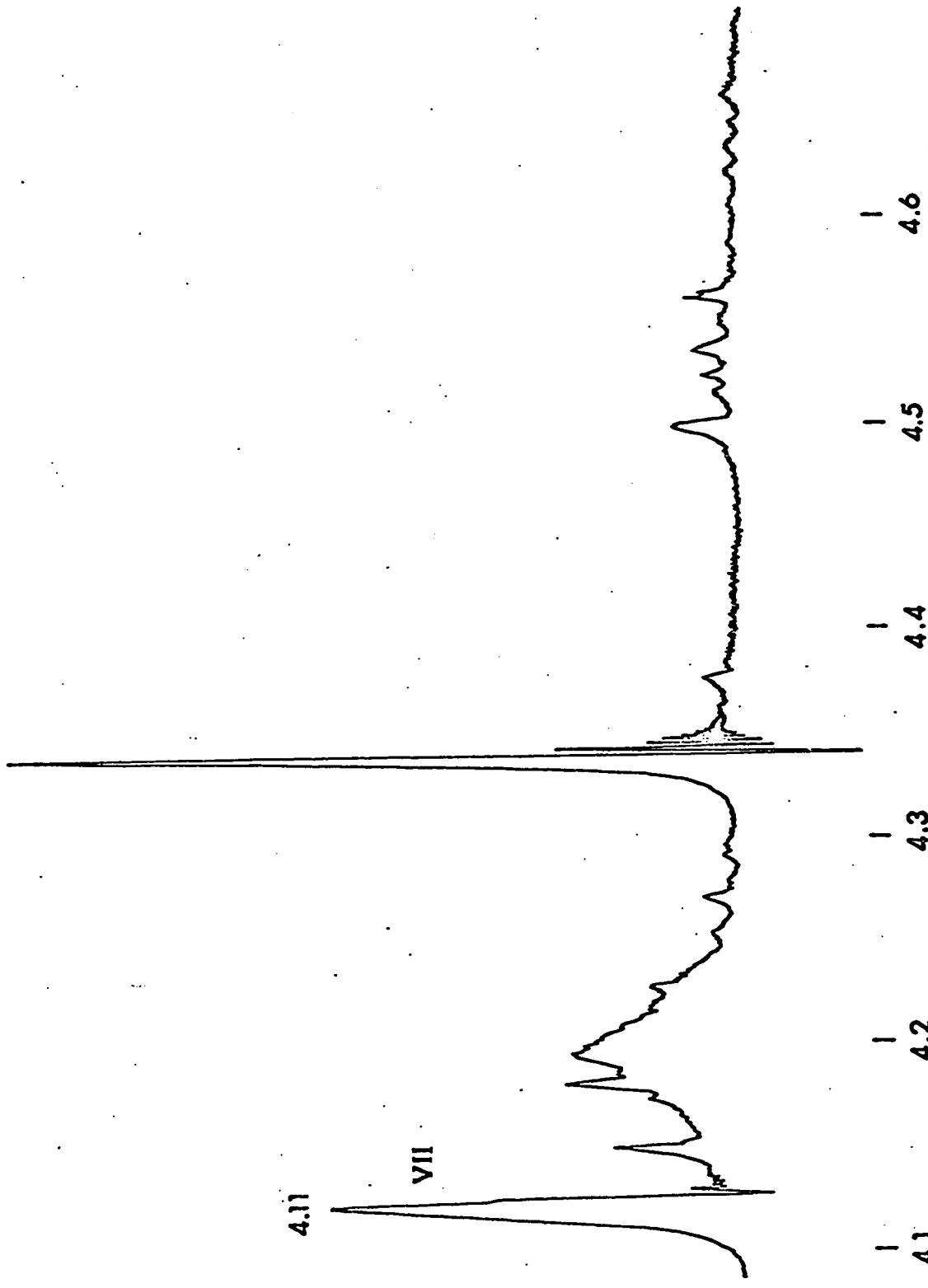

Figure 13: sample shown in figure 12 after being warmed at -25° for 2 hours.

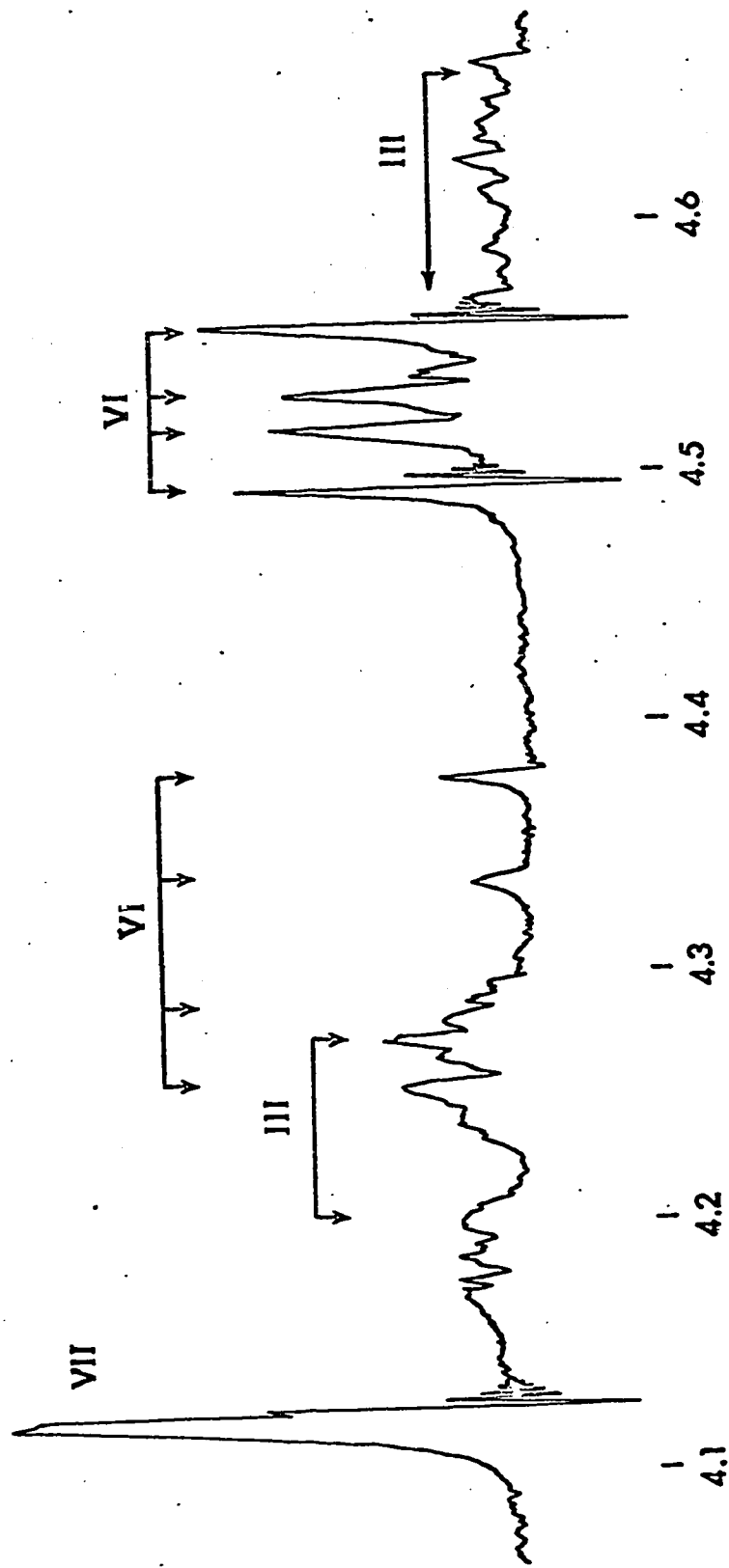

Figure 14: Sample shown in figure 13, after being warmed at -10° for 2 hours.

The stereochemical assignments of XIII and XII are compatible with the thermal behavior and nmr spectral properties of the compounds. Compound XII was much more unstable than XIII signifying the strain provided by one *trans* double bond in the 10-membered ring. The assignments agree with the selection rule and the thermal reactions of these compounds are stereospecific. An indication that the selection rule does apply to [10]annulenes, even though XII lacks proper symmetry for a molecular orbital correlation and XIII is probably *not* planar, stems from the observation that likely thermal generation of XII (from XI as shown later) results in production of VII. Also, the sharp singlet (τ 4.34) exhibited by XIII at -40° to -80° indicates that rapid fluxional isomerization of the type exhibited by cyclooctatetraene is occurring in (*cis*)⁵[10]annulene.

Noted previously (p. 12) was the *possibility* that the [10]annulenes were aromatic. Since both these compounds (XII and XIII) contain $4n+2$ π electrons, *if* sufficient delocalization were to be attained in the π system of the molecules, they should possess some aromatic character. The nmr spectra exhibited by both these compounds showed that there occurred no significant diamagnetic circulation around the ring system in either compound.

Diimide reduction (-80° to room temperature) of the photolysate followed by catalytic hydrogenation yielded only

2 ~ 3% cyclodecane in addition to *trans*-decalin, *cis*-decalin, bicyclo[4.2.2]decane, and traces of hydrogenated bullvalene products. That reduction with diimide was unable to compete favorably with the thermolysis of these two compounds stands in agreement with earlier comments (p.41) on the inefficiency of diimide reduction at low temperatures. Other means by which [10]annulenes could be intercepted by reduction before thermolysis were investigated. Of a number of catalysts examined, only finely dispersed rhodium²⁵ catalyzed hydrogenation proceeded at a reasonable rate at low temperatures. Cyclododecene exhibited a half life of α . 55 minutes under catalytic hydrogenation in the presence of rhodium at -80° .

Catalytic hydrogenation (rhodium) of the photolysate mother liquors yielded 1) cyclodecane (amount equal to both XII and XIII), 2) *cis*-decalin and bicyclo[4.2.2]decane (amount equal to X and the small amount of III present in the photolysate) and 3) hydrogenation products of the small amount of bullvalene. Reduction of *both* new $(CH)_{10}$ compounds to cyclodecane demonstrates that they are [10]annulenes.

Some comment is demanded concerning the results obtained by van Tamelen and Burkoth (see p. 10). Briefly, they claimed that i) *cis*-9,10-dihydronaphthalene (III) showed no promise as a [10]annulene precursor, ii) irradiation of the *trans*-isomer (VII) by unfiltered light (2537 Å) from a Rayonet photochemical

reactor at -190° for 2 minutes²⁶ provided cyclodecane precursor and iii) diimide reduction of the photoisolate afforded cyclodecane in as high as 40% over-all yield.

Our results conflict with theirs at least in these three respects. To summarize, our findings are: i) Only the *cis*-compound III, not VII or XI, provided in moderate yields [10]annulenes under carefully controlled conditions. ii) Photochemical reactions of III, VII and XI are temperature dependent and proceeded very fast at 0° , whereas these compounds were recovered *unchanged* after 420 minutes' irradiation at -190° . iii) As noted earlier (p. 41) diimide is not a particularly effective reducing agent at low temperatures and this type of reduction was found to be unable to compete favorably with thermolyses of [10]annulenes.

Also in the context of van Tamelen and Burkoth's report, it will be shown later that their sample of VII was highly impure (by a comparison of uv spectra). Thus their spectral experiment (see p. 10) would not only be complicated by the high number of $(CH)_{10}$ photo-products (at least IV, III and X) but was likely contaminated with other material (products arising from thermal reaction of VII).

Because the photo reactions of any of the three starting materials are complicated by concurrent photoisomerizations of subsequent photo-products, interpretation of these processes would be involved. Proof of a strict interpretation would be

exceedingly difficult to obtain. However, since interception and characterization of the [10]annulenes was accomplished, a mechanistic interpretation is offered.

In the case of III for instance, photo-induced ring opening competes with an efficient process leading to XI. In view of the instability (ring strain) of an open system, the ring opening process is *not* closely isoenergetic and therefore temperature dependent. At high temperature irradiation (-60°), this ring opening process favorably competes with formation of XI. That this process is stereospecific (conrotatory) has not been proven, but if it were not one would then reasonably expect the same result (accumulation of [10]annulenes in photolysate) from the high temperature (-60°) photolysis of VII which is not the case. Because no thermolysis of [10]annulene occurs in the system and because the reasonable assumption is stereospecific photo-induced ring opening, there must occur photo-induced interconversion of the [10]annulenes.

A summary of the photo-system is shown as reaction sequence 28. The heavy arrows denote *non*-isoenergetic processes while the regular arrows denote ordinary processes. According to this reaction mechanism, appreciable quantities of XII and XIII can only accumulate by an initially large concentration of III photolyzed at high temperature (-60°). This conforms with our observations. The photochemical reaction of X to IV

agrees with some recent observations in this laboratory (photolysis of IV under similar conditions results in formation of X and of minor amounts of III and VII).²³

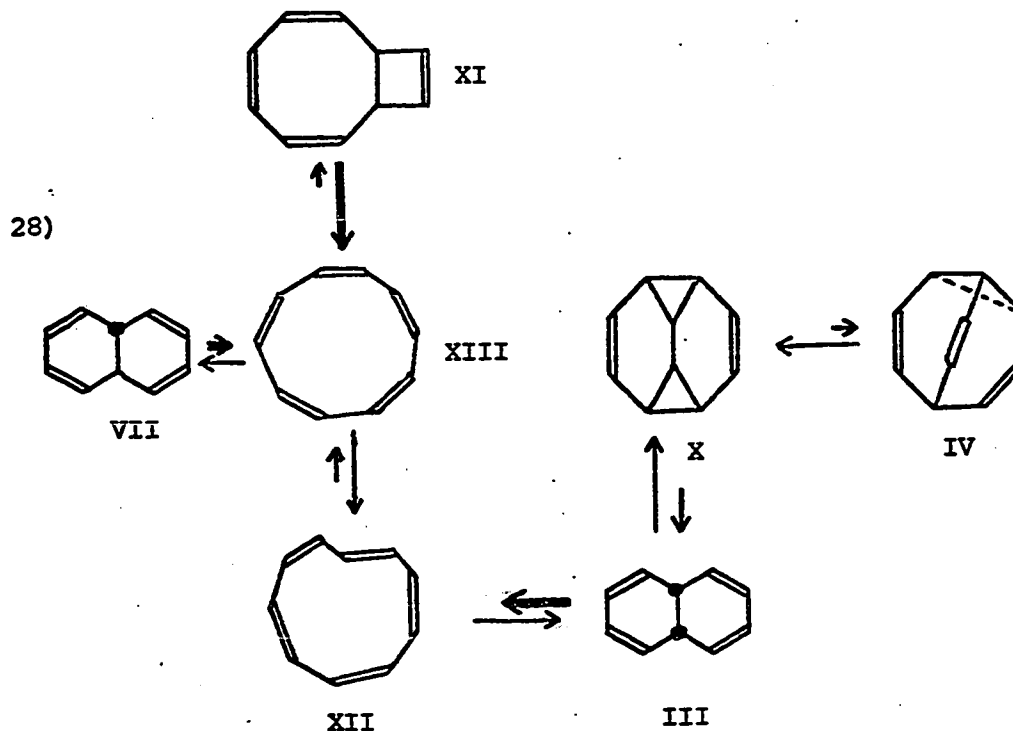

C. Thermal reactions of some (CH)₁₀ compounds^{34,35}

In addition to the photochemical studies previously outlined, we have investigated many thermal reactions of (CH)₁₀ compounds. These reactions were the thermolyses of i) bicyclo[6.2.0]deca-2,4,6,9-tetraene, ii) *trans*-9,10-dihydronaphthalene, iii) tetracyclo[4.4.0.0^{2,10}.0^{5,7}]deca-3,8-diene, iv) bicyclo[4.2.2]deca-2,4,7,9-tetraene, and v) bullvalene.

i) Thermolysis of bicyclo[6.2.0]deca-2,4,6,9-tetraene (XI)

As indicated before (isolation of XI in the photolysate of the sodium salt of XIVc occurred at the sacrifice of VII), XI thermally isomerizes to VII (reaction 29). A detailed study of this isomerization was carried out by nmr spectroscopy. Monitoring the integral of the allylic signals of X and VII provided relative concentrations throughout the reaction course. The rather facile isomerization occurred at relatively low temperature and we felt justified in using the probe temperature control unit of the nmr spectrometer (calibrated by a precalibrated ethylene glycol chemical shift). The highest temperature utilized was only 40° above normal probe temperature and the small gradients produced by this difference had negligible effect as the rates obtained were reproducible. This clean first order isomerization enabled the conversion of pure XI to a solution of pure VII (if the temperature was below 75° and the concentration was at or below 0.5 M). Treatment of the data provided the kinetic parameters for reaction 29:

$$k_{74.8} = (1.72 \pm 0.05) \times 10^{-3} \text{ sec}^{-1}$$

$$k_{46.8} = (6.9 \pm 0.2) \times 10^{-5} \text{ sec}^{-1}$$

$$\Delta H^{\ddagger} = 24.7 \pm 0.5 \text{ kcal/mole}$$

$$\Delta S^{\ddagger} = -0.4 \pm 1.4 \text{ e.u.}$$

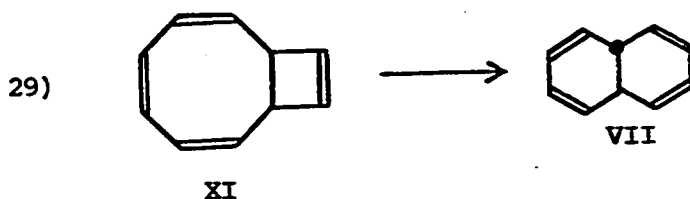

Thermal opening (conrotatory) of XI to intermediate XII followed by disrotatory collapse of XII to VII is the best proposal for this stereospecific reaction. Although the interpretation follows the Woodward-Hoffmann selection rules, it should be kept in mind that XI lacks C_2 symmetry and the proposed intermediate XII lacks σ symmetry so the Woodward-Hoffmann rules cannot be applied in a rigid sense to reaction 29.

ii) Thermolysis of *trans*-9,10-dihydronaphthalene (VII)

A dilute sample of VII generated by the first order thermolysis of XI underwent further thermal reaction to naphthalene at an observable rate only above 120° when the concentration was kept below 0.1 M. However, attempts to subject solutions of pure VII to preparative glpc in order to collect VII (to be taken up in another solvent for other work) were futile. The collected material showed considerable material loss (50 ~ 60%) and was contaminated with varying amounts (30 ~ 50%) of naphthalene and 1,2-dihydronaphthalene. However, we were able to study the properties of pure VII, simply by generating it in a suitable solvent. Thus we were able to take the uv spectrum of pure VII for the first time (see p. 61 for the nmr and uv spectra of VII). The uv spectrum of VII exhibited $\lambda_{\text{max}}^{\text{methylcyclohexane}}$ 276 m μ ($\epsilon = 3850$). (The nmr spectrum of the material we used for determining the uv spectrum showed no contamination). Comparing

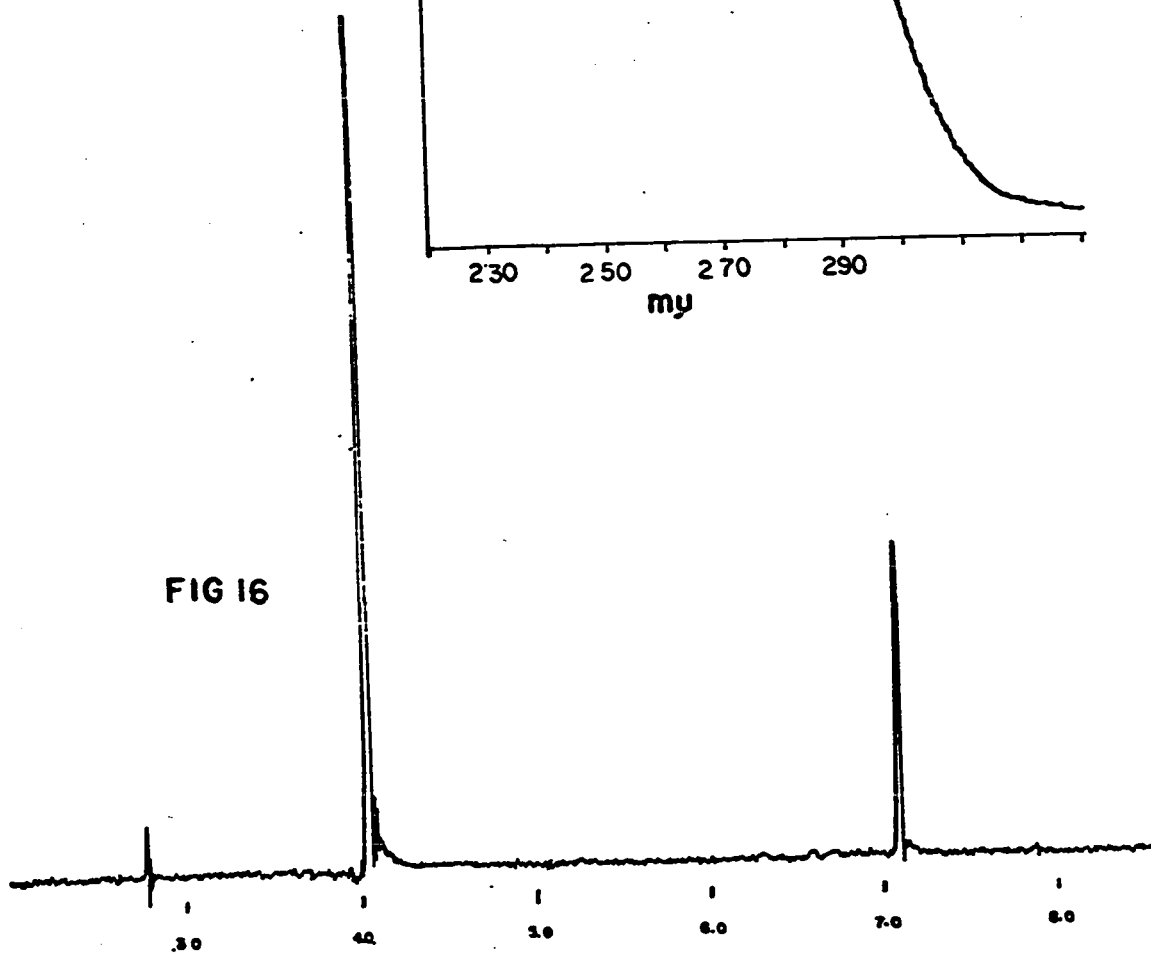
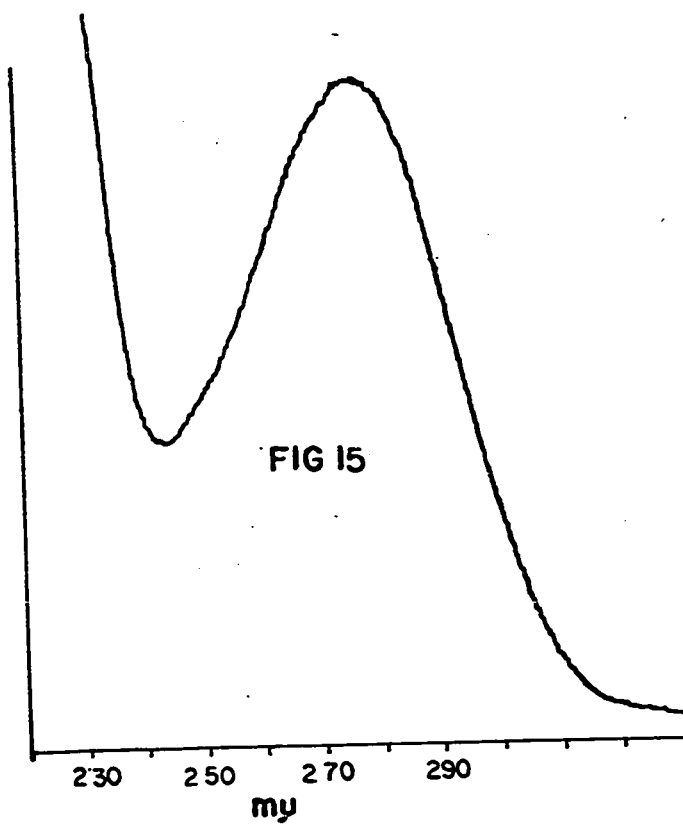

Figure 15: Uv spectrum of VII (methylcyclohexane).

Figure 16: Nmr spectrum of VII (100 MHz in CDCl_3).

this with material collected by glpc by van Tamelen and Burkoth ($\lambda_{\text{max}}^{\text{MeOH}}$ 231, no molar extinction coefficient reported) reflects the difference between the two preparative procedures.

The need for chemical proof of the structure of VII was noted earlier (p. 4). Repeated reduction of a methanol solution of VII with diimide (KOOCN=NCOOK + acetic acid) provided a mixture of hydronaphthalenes in which no VII was present (glpc). Catalytic hydrogenation converted this mixture to *trans*-decalin in greater than 90% yield. (In Burkoth's thesis, it was reported that hydrogenation of VII by catalytic means *or* by diimide produced *cis*-decalin).²⁶ This reduction was carried out by N. Nakatsuka.

The failure to isolate pure VII by ordinary work techniques (glpc) prompted a preliminary investigation into the thermal behavior of VII. In the concentration (0.01 to 1 M) and temperature ranges studied, VII yielded four thermal products: naphthalene, 1,2-dihydronaphthalene, an unidentified hydronaphthalene and hydrogen (the hydrogen was characterized by glpc retention time and by mass spectrum). The product distribution was concentration dependent (% naphthalene increased, % 1,2-dihydronaphthalene decreased, and % unknown product increased with increasing concentration). When the kinetic data were treated as second order, some of the derived plots ($kt = \frac{C_0 - C}{C_0 C}$) deviated positively (upward) from a straight line indicating other competing reactions.

Although the complete mechanistic interpretation of this reaction is not yet certain, enough data are available to offer a feasible, though by no means proven, preliminary explanation. A second order reaction of VII through "stacking" two molecules of VII in the transition state gives an ultimate [1,3]hydrogen shift to provide an intermediate tetraene (ii) by a thermally allowed process (reaction 30).

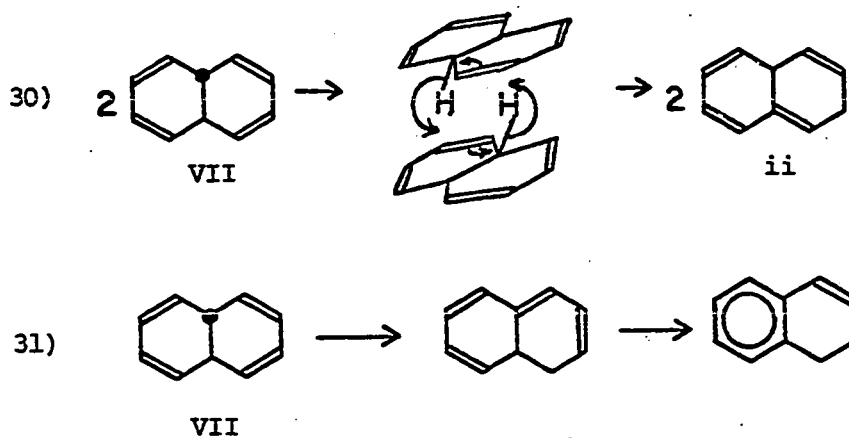

The most likely reaction course open to intermediate ii is 1,4 elimination of hydrogen (a thermally allowed and documented²⁷ process). This sequence then accounts for production of hydrogen and naphthalene in this reaction. Also, as the concentration of VII increases the percentage yield of naphthalene increases as this second order reaction becomes more favored over the competing first order process (reaction 31). Reaction 31 consists of a series of 1,5 hydrogen shifts (thermally allowed) to produce 1,2-dihydronaphthalene.

iii) Thermolysis of tetracyclo[4.4.0.0^{2,10}.0^{5,7}]deca-
3,8-diene(X)

Also mentioned before (p. 38), X thermally isomerizes at 0° to VI (reaction 32). Since the photolysate containing XI (65%) existed as an already prepared nmr sample, it was decided to carry out further investigation of this thermal reaction utilizing nmr spectroscopy. However, a few runs at an indicated probe temperature gave spurious kinetic data demonstrating a fluctuating and non-reproducible probe temperature. Presumably this unreliability resulted from the large temperature gradients around the probe. Temperatures of -35 ~ -15° (the range yielding measurable kinetic data) were 50 ~ 70° different from normal probe temperature and ~ 100° different from the initial cooling nitrogen flow. The temperature runs were carried out in a temperature controlled refrigerated liquid bath. Careful integration (-70°) of the appearing signals of VI and careful integration of the small amount of III present demonstrated clean first order kinetic conversion of X to VI. Treatment of the data provided the following kinetic characteristics for reaction 32.

$$k_{-14.9} = (1.25 \pm 0.1) \times 10^{-4} \text{ sec}^{-1}$$

$$k_{-29.9} = (9.5 \pm 0.7) \times 10^{-6} \text{ sec}^{-1}$$

$$\Delta H^\ddagger = 21.0 \pm 1.5 \text{ kcal/mole}$$

$$\Delta S^\ddagger = 5 \pm 6 \text{ e.u.}$$

32)

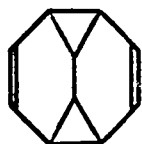

X

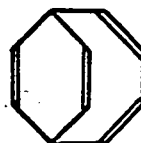
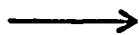

VI

Obviously the reaction can be explained as a reverse Diels-Alder reaction: that is, a 4 + 2 electrocyclic reaction that thermally proceeds with a plane of symmetry. Babad, Ginsburg and Rubin also reported this reverse Diels-Alder reaction in derivatives of X (reactions 33)³⁰ at the same time as we reported our observations on reaction 32.

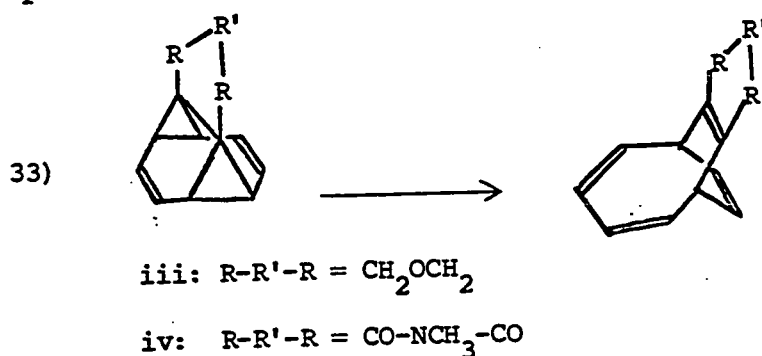

The bridgehead substitution exerts a notable stabilization on this system. The half lives exhibited by compounds X, iii, and iv were 1.7 hr. at -15° , 2 hr. at 22° , and 3 hr. at 60° , respectively.

iv Thermolysis of bicyclo[4.2.2]deca-2,4,7,9-tetraene(VI)

von Doering and Rosenthal had reported the thermal rearrangement of VI to III.¹⁷ This reaction held particular promise as proceeding through intermediate X because a realistic reaction mechanism involving X could be envisioned (reaction 34). Interest in such a reaction mechanism also stemmed from the fact that only a few intramolecular Diels-Alder reactions had been reported.²⁸

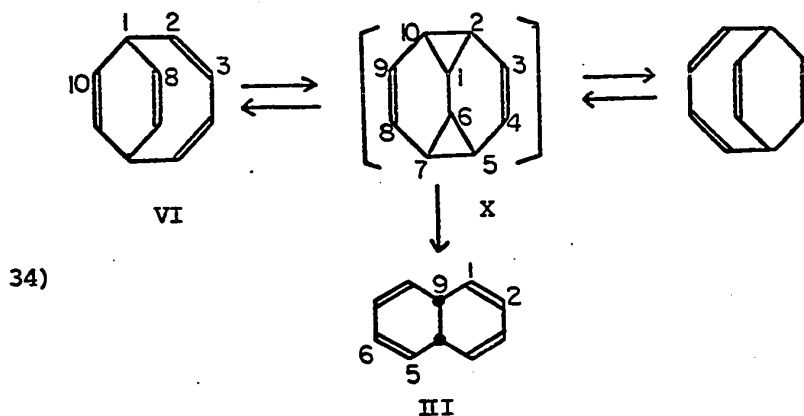

Suppose the intramolecular reverse Diels-Alder reaction does take place as shown in reaction 34. If this reaction occurs at a rate detectable by nmr spectroscopy then time averaging will occur between signals due to the H-1 and H-2 pairs and between signals due to the H-10, the H-8 and the H-3 pairs because the intermediate X can form III by either cleavage of C₁-C₂ and C₆-C₅ or cleavage of C₁-C₁₀ and C₆-C₇ bonds.

Nmr spectra of VI are shown on p. 67 (100 MHz). The one reasonable analysis for the signal groups of VI follows from inspection of the spectra and decoupling experiments. Group B (4H) displays a typical AA'XX' pattern and collapses to a singlet upon irradiation of signal A. The only proton signals that could possibly possess these properties are those from the H-8 and H-10 pairs. Enough chemical shift difference at 100 MHz lends primarily AA'XX' character to groups C and D. However, group D is complicated by further splitting with the allylic protons (group A) as shown by decoupling. Providing

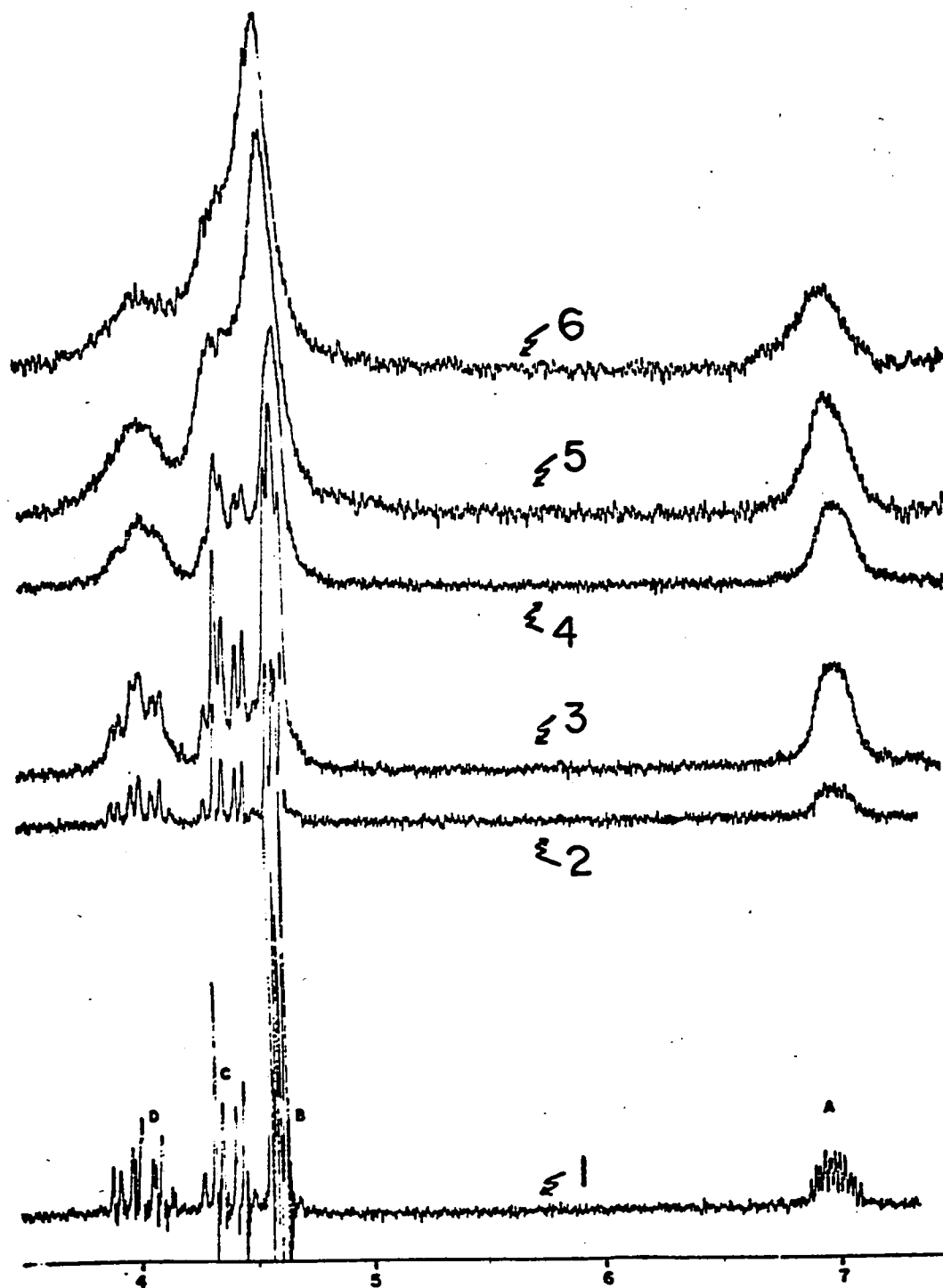

Figure 17: Nmr spectra (100 MHz, *n*-dodecane, hexamethyldisilane as internal standard) of VI (1) 40°, (2) 120°, (3) 140°, (4) 160°, (5) 170°, (6) 180°.

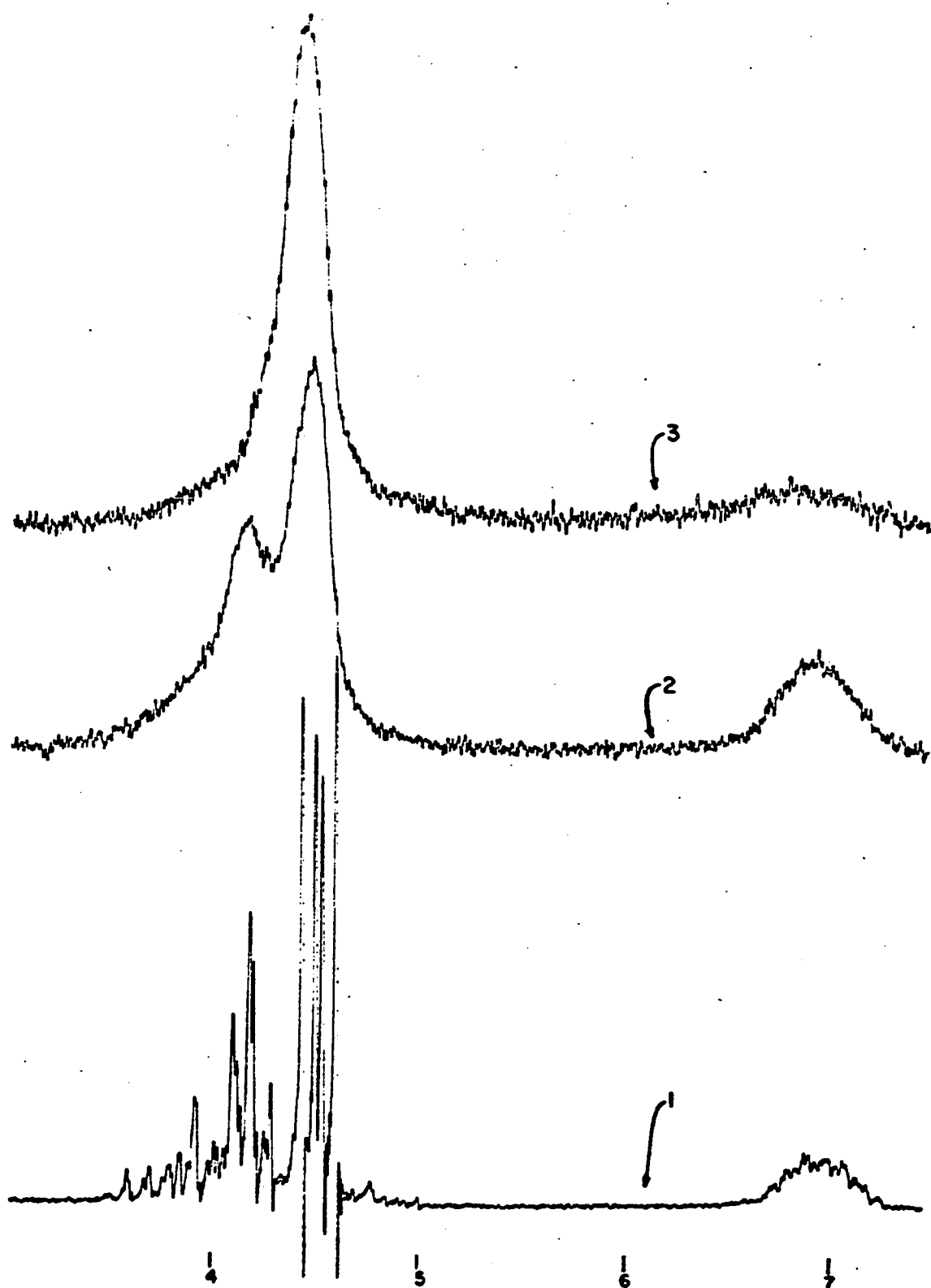

Figure 18: Nmr spectra (40 MHz, d_{28} -*n*-dodecane, hexamethyldisilane as internal standard) of VI, (1) 35°, (2) 160°, (3) 180°.

that $J_{12} > J_{13}$ and that the diamagnetic anisotropy of the double bond partially shields proton pairs H-3. These data permit the assignment of group C due to proton pairs H-3 and group D to proton pairs H-2. Therefore, averaging should occur between groups A and D and between groups B and C.

In temperature dependent nmr spectra at 100 MHz gradual collapse of couplings takes place as the temperature increases. For instance, the sharp quartet B had collapsed to a broad triplet at about 140° showing the small splitting (presumably $J \sim 1.0 \text{ H}_z$) had disappeared. At about 175°, the large coupling of group C had disappeared. At 180°, groups B and C had almost merged, but at this frequency (100 MH_z) demonstration of complete merging was impossible because reaction 5 (VI \rightarrow III) began to intercede at higher temperatures.

At 40 MHz, however, this effect was observed because of the smaller chemical shift differences between these groups.

A crude estimate of the energy required for the intramolecular Diels-Alder reaction was available from the 100 MH_z spectra (p. 67). Measurement of two couplings that disappeared at two temperatures and application of the formula²⁹

$$\sqrt{2} = \pi \tau \Delta\nu$$

where $\Delta\nu$ = separation between the two lines

τ = mean half life when the two lines coalesce

enabled calculation of two mean half lifes for the degenerate tautomerization of VI (reaction 35).

$$\tau_{140} \sim 0.5 \text{ sec}$$

$$\tau_{175} \sim 0.025 \text{ sec}$$

$$\Delta H^\ddagger \sim 30 \text{ kcal/mole}$$

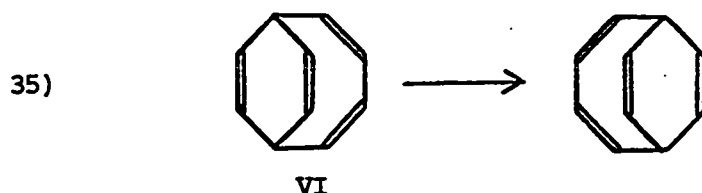

The nmr spectra of VI at 40 MHz showed complete coalescence of groups B and C at 180° (see p. 68). In addition the groups A and D at this temperature were almost washed out as coalescence began to occur over the wide distance.

In order to substantiate this interpretation of the temperature dependent nmr spectrum of VI, deuterium scrambling experiments were carried out in this laboratory. According to this interpretation preparation of specifically labeled VI from specifically labeled tosylhydrazone XIVc can only be accomplished under very limited (heat) conditions. Work in this laboratory (N. Nakatsuka) and simultaneous work by Grimme, Riebel and Vogel³¹ revealed that *pyrolysis* (100°) of specifically labeled XIVc (p. 29) sodium salt, followed by preparative glpc yielded VI in which deuterium had already been distributed

among the positions dictated by the Diels-Alder mechanism 34. In addition the specifically labeled VI, prepared by *photolysis* of a specifically labeled XIVc (p. 29) sodium salt underwent scrambling at 80-100° (S. Masamune and N. Nakatsuka).

However, one other work was in conflict with all our results (nmr interpretation and scrambling results). Jones and Fairless³² reported that they obtained specifically labeled VI by pyrolysis of specifically labeled XIVc sodium salt. They also reported that scrambling occurred only at 180°. Our results indicate that this intramolecular Diels-Alder reaction is occurring at a rate at least 10^5 faster than Jones and Fairless report.

All spectra and chemical data (deuterium scrambling and our earlier report on reaction 32 (X → VI)) are consistent with the Diels-Alder portion of mechanism 35. An additional experiment suggests the intermediacy of X in reaction 5. Pyrolysis of monodeuterio VI in a flow system ($\sim 400^\circ$) provided monodeuterio III and its nmr spectrum revealed that deuterium was distributed at C-9,10 (0.28D), and at C-2,3,6,7 (0.56D) and that none was at C-1,4,5,8 within experimental error (calculated integral ratio of signals 4.14, 4.49 and 6.71 for the complete H-2,3,6,7,9,10 scrambling 1:1.17:0.5, found, 1:1.16:0.5) (this

pyrolysis experiment was performed by M. Wiesel of this laboratory).

The thermolysis of VI in *n*-dodecane at 178.7 was studied. Products detected throughout the course of the reaction include naphthalene, III, and bicyclo[4.2.2]deca-2,4,8-triene (XIX) (reaction 36). Compound XIX was isolated, characterized by nmr and mass spectra, and converted to bicyclo[4.2.2]decane.

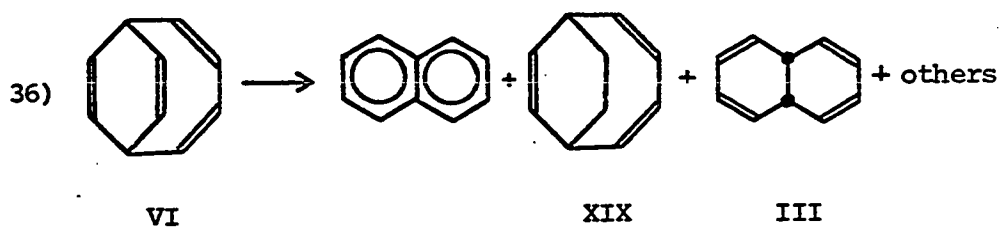

The product distribution exhibited concentration dependence (% III decreased, % XIX increased with increasing concentration). A plot of $\ln C/C_0$ (C: concentration of VI) against *t* generated a curve with a steep ($\sim 2k$) initial slope and an asymptotical approach to a straight line (*k*) (see p. 73). These results and the known chemical behavior of III (reaction 7, p. 11) led us to conclude that many reactions were operating in this system (see reactions 5, 37 and 38).

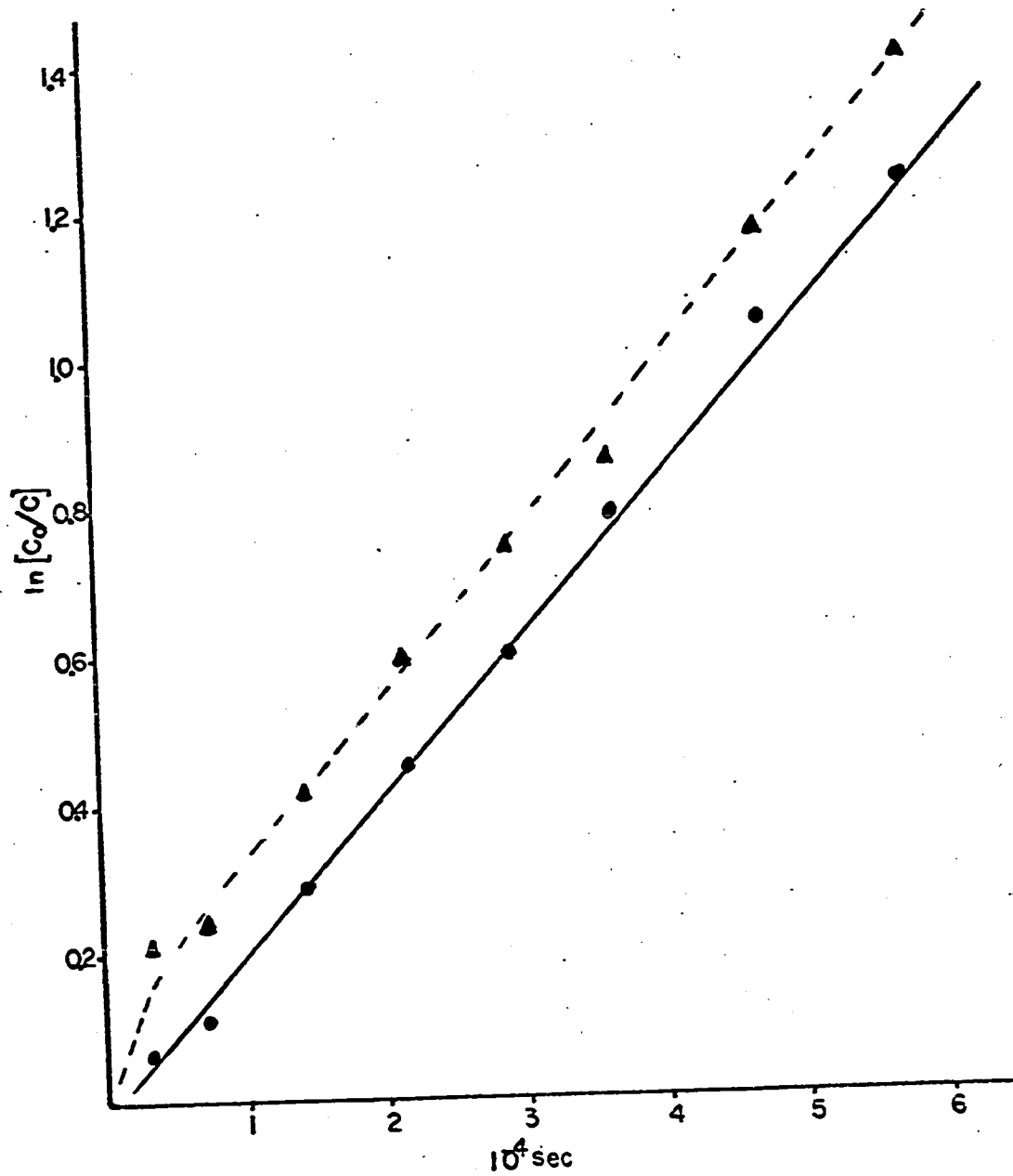
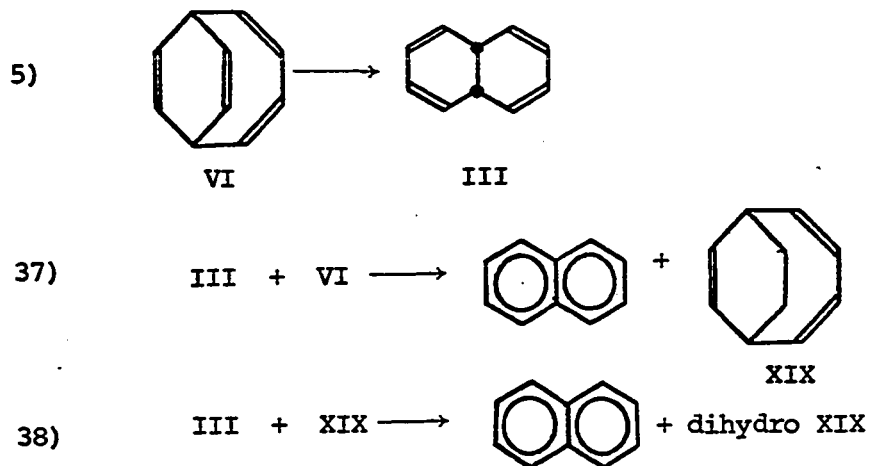

Figure 19: Thermolysis of VI at 178.7°.

▲ 0.4M VI in *n*-dodecane

● 0.64M VI in cyclooctene



Thus, the complexity of the resulting kinetic behavior of VI prevented us from further analysis of this system (*n*-dodecane).

However, use of cyclooctene as hydrogen acceptor and solvent, cleanly replaced all reactions except reaction 5, by cyclooctene + III \rightarrow naphthalene + cyclooctane, and the disappearance of VII followed first order kinetics. The followed parameters were deduced from the kinetic data for reaction 5.

$$k_{178.7} = (2.15 \pm .08) \times 10^{-5} \text{ sec}^{-1}$$

$$k_{201.8} = (1.45 \pm .05) \times 10^{-4} \text{ sec}^{-1}$$

$$\Delta H^{\ddagger} = 34.3 \pm 1.1 \text{ kcal/mole}$$

$$\Delta S^{\ddagger} = -4.8 \pm 2.4 \text{ e.u.}$$

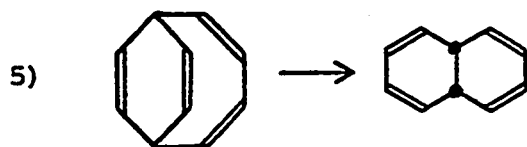

All evidence is compatible with mechanism 34. To summarize: 1) The temperature dependent nmr spectrum exhibited by VI is best explained by occurrence of a facile intramolecular Diels-Alder reaction. 2) The extremely facile thermal conversion of X to VI has been demonstrated. 3) Deuterium scrambling experiments demonstrate that the Diels-Alder equilibrium is operating in agreement with the nmr spectral interpretation. 4) Pyrolysis of labeled VI produced III that was labeled in accord with mechanism 34. 5) The energy required for the complete conversion of VI to III is higher than that required for the other reactions (32 and 35). From the activation energies measured for the three reactions 32, 35 and 6, a free energy profile can be constructed for the reaction course (see p. 76). From the diagram, one can deduce the energy required for the disallowed opening of XI. We feel this exemplifies an interesting comparison of the energy barriers involved in the allowed and disallowed thermal reactions of X.

v Thermolysis of bullvalene(IV)

Another thermal reaction investigated was the thermolysis of bullvalene IV to naphthalene. Schröder had earlier proposed the following reaction mechanism (p. 8).

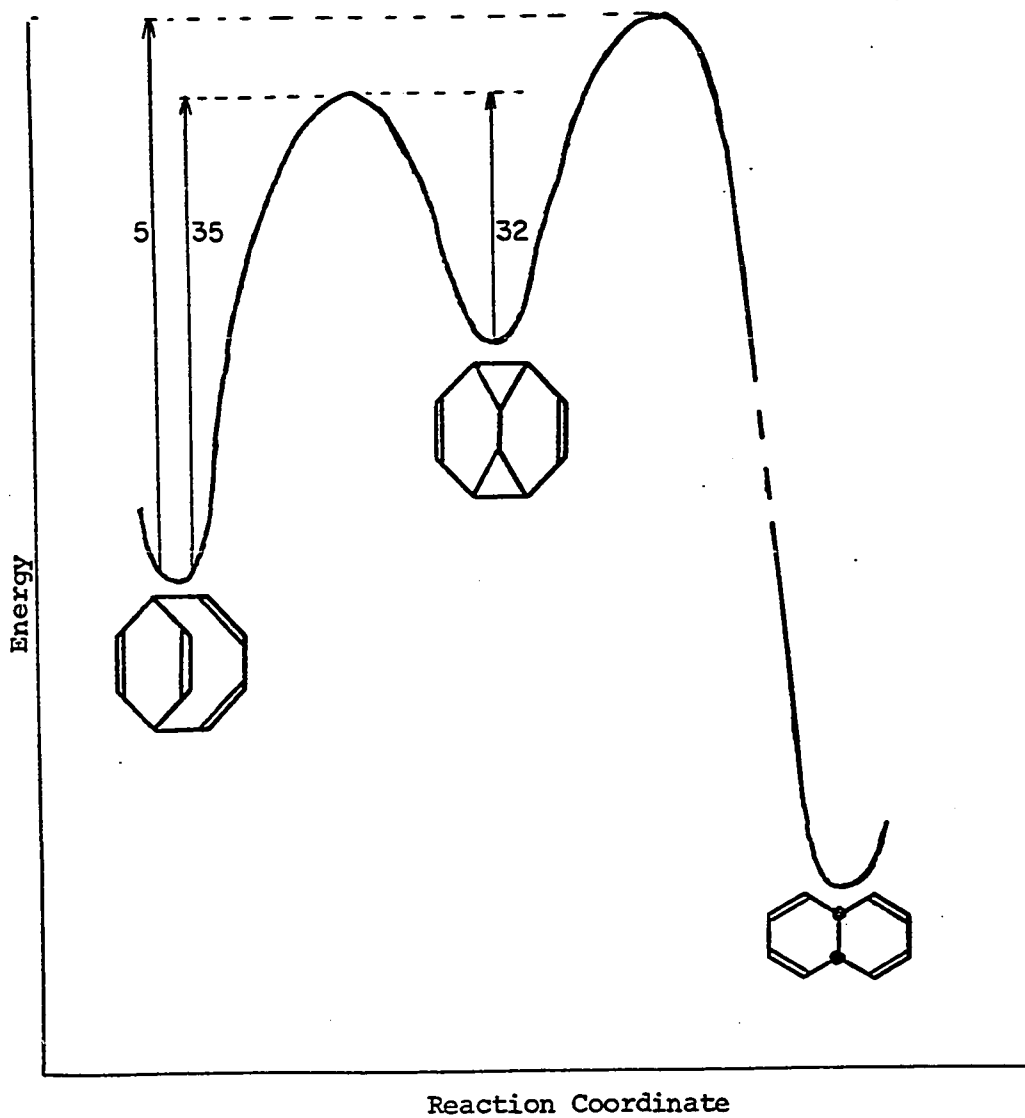
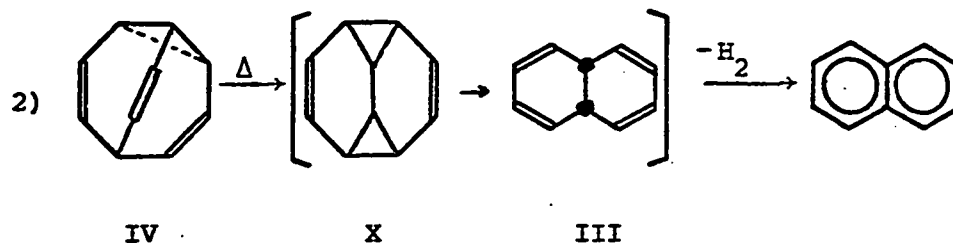

Figure 20: Energy profile for reactions 5, 32 and 35.



Thermolysis of bullvalene in *n*-dodecane proceeded as a first order reaction, presumably because the spherical geometry of the π -system of IV prohibited it from accepting hydrogen from III as in the case of reaction 36. Kinetic data permitted the following parameters to be deduced for reaction 39.

$$k_{296.5} = (1.89 \pm 0.2) \times 10^{-4} \text{ sec}^{-1}$$

$$k_{271.5} = (2.9 \pm 0.2) \times 10^{-5} \text{ sec}^{-1}$$

$$\Delta H^{\ddagger} = 45.1 \pm 3.3 \text{ kcal/mole}$$

$$\Delta S^{\ddagger} = 2.3 \pm 6 \text{ e.u.}$$

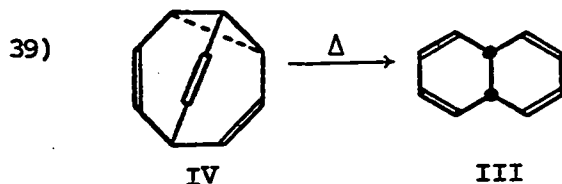

This reaction may well involve the potentially interesting diradical species XVII (mentioned earlier on p. 30). However, further comment on this reaction will have to be deferred until more data are gathered.

CHAPTER 3Experimental

All melting points and boiling points are uncorrected.

The ir spectra were obtained on a Perkin-Elmer model 21 infrared spectrometer (CHCl_3 unless otherwise stated). The nmr spectra were measured with Varian Associate A-60 and HR-100 spectrometers, tetramethylsilane being used as internal reference. The mass spectra were obtained on A.E.I. MS-2, MS-9 and MS-12 mass spectrometers. The uv spectra were obtained on a Cary model 14M recording spectrometer.

Three glpc systems were employed throughout this work:

Glpc-1 was a F&M model 700 containing a 10 ft. x $\frac{1}{4}$ in. column packed with 10% silicon rubber (S.E. 30) on Chromasorb P (30-60 mesh). Oven temperature = 100° , injector temperature = 160° , detector temperature = 180° .

Glpc-2 was an Aerograph model A-700 containing a 10 ft. x $\frac{3}{8}$ in. column packed with 10% silicon rubber (UCW 98) on Chromasorb WAW (80-100 mesh). Oven temperature = 100° , injector temperature = 160° , detector temperature = 180° .

Glpc-3 was a F&M model 5750 research chromatograph containing a 6 ft. x $\frac{3}{16}$ in. column packed with 10% silicon rubber (UCW 98) on Chromasorb WAW (80-100 mesh). Oven temperature = 100° , injector temperature = 160° , detector (flame) temperature = 350° .

Thermal rearrangement of XV

A solution of XV (1.1g, 5.7 mmole) in n-octane (5 ml) was heated under nitrogen at 120° for 45 minutes. The n-octane was removed by evaporation *in vacuo* and the residue distilled (bath 100°, .1 mm) to yield 850mg of material. This material was immediately subjected to catalytic hydrogenation (100mg, 10% palladium on carbon in ethylacetate). Hydrogen uptake stopped at 222 ml. After filtering off the catalyst and evaporating the filtrate, the material was subjected to chromatography over 15g silicic acid (CHCl₃). Ir and glpc showed that one product (160mg, 19%) was identical with N-carboethoxy indole and another product (120mg, 16%) was identical with N-carboethoxy perhydroindole.

N-methyl-4-azabicyclo[5.2.0] nonane1) From cyclobutane-*cis*-1,2-diacetic acid

The crude anhydride formed from reaction of this acid²⁴ (500mg, 2.9 mole) with acetic anhydride and pyridine, was dissolved in dioxane and methylamine. The resulting solution was sealed in a thick tube and heated at 140° for 2 hours. The evaporated residue was subjected to chromatography over silicic acid (5g) yielding a clear oil (260mg, 48%): ir 3400-2400 cm⁻¹, 1710 cm⁻¹, 1660 cm⁻¹. This oil was stirred in refluxing xylene with P₂O₅ (ca. 100mg) for 2.5 hr. The residual solution was taken up in ether and washed with water. The ether layer was

dried and evaporated. Distillation of the residue onto a cold finger apparatus (bath 100°, p 1.5mm) gave white crystals (115mg, 49%); mp 35°; ir 1710 cm^{-1} , 1670 cm^{-1} . This material was treated with excess LiAlH_4 in ether. Quenching the excess LiAlH_4 in the usual manner and evaporation of filtrate of the reaction mixture gave a clear oil (50mg, 50%). This material exhibited identical retention time (glpc - 1) to and an ir spectrum identical with material produced by route (2).

2) From N-carboethoxy-4-azabicyclo[5.2.0]nona-2,5,8-triene (XV)¹⁹

Catalytic hydrogenation of a solution of XV (210mg, 1.1 mmole) in ethyl acetate over palladium on charcoal (100mg, 10% Pd) resulted in 77.9 ml hydrogen uptake (90% at 700mm). The catalyst was filtered off and the filtrate evaporated. The residue was treated with excess LiAlH_4 in ether. Quenching the reaction with wet ether, and evaporation of the filtrate produced by filtering off the solids gave material (100mg). This material was subjected to preparative glpc (glpc-1) and the major peak (75%) collected. This product was identical with the material produced by reaction route (1).

Ethyl bicyclo[6.1.0]nona-2,4,6-triene-9-carboxylate (XIVa)²⁰

To a vigorously stirred suspension of finely divided copper (6.3g) in cyclooctatetraene (210g, 2.05 mole) maintained at a

temperature of 105-110° was added dropwise ethyldiazo-acetate (100g, .76 mole) over a period of *ca.* 2.5 hr. The dropping funnel was cooled with ice and arranged so that the drops fell directly into the hot reaction mixture. The total amount of nitrogen evolved was 19.5 L (85%). Stirring and heating were ended 10 minutes after nitrogen evolution ceased, and after cooling the reaction mixture to room temperature, it was filtered through Celite. Vacuum distillation of *three* combined filtrates produced three fractions: 1) bp 30-40°/.5mm, recovered cyclooctatetraene (490g, 4.7 mole), 2) bp 63-75°/.1mm, diethyl maleate (20g), and 3) bp 77-80°/.02mm, XIVa (190g, 69% calc'd. from cyclooctatetraene consumed). Fraction 3 exhibited signals in the nmr spectrum (CDCl₃) at τ4.1 (mainly d, 6H), τ5.85 (quartet, 2H), τ7.9 (unsymmetrical t, mainly 2H), τ8.70 (mainly t, mainly 4H). As shown by the hydrolysis product, the distillate was a mixture of ~ 95% *trans*-isomer and ~ 5% *cis*-isomer.

Bicyclo[6.1.0]nona-2,4,6-triene-9-*trans*- and *cis*-carboxylic acids (XIVb and XIVb', respectively)

To the distilled ester XIVa (55.8g, 0.29 mole) stirred under nitrogen in *tert*-butyl alcohol (200 ml) was added dropwise KOH solution (115 ml, 2.00N, 0.24 mole base) over a period of 30 minutes. Stirring was continued until the reaction medium became clear (*ca.* 15 hr.). Evaporation *in vacuo* reduced the reaction

volume to ca. 100 ml. The resulting turbid mixture was extracted with methylene chloride (4x100 ml) and the combined extracts (washed with water and salt water, dried over Na_2SO_4 , and evaporated) provided an oily residue that was enriched in *cis*-ethyl ester (25 ~ 50% by nmr). Recycling of this oily residue (reaction with an equivalent amount of base required to hydrolyze all the *trans*-ester provided an oily extract that was almost solely *cis*-ethyl ester (90 ~ 95% by nmr).

The aqueous portion of the methylene chloride extraction was cooled to 0° and acidified with 1N HCl. Extraction of the resulting precipitate with 3x300 ml methylene chloride (washed with water and salt water, dried over Na_2SO_4 and evaporated) provided a solid residue (38.5g, 100% calc'd. on the amount of consumed base). Recrystallization of this residue gave XIVb, as material of mp 163-165°. Recrystallization of the hydrolysis product of *cis*-diethyl ester gave XIVb', as material of mp 144-146°.

Pure samples of *cis* and *trans* acids and derivatives were obtained by recrystallization from methyl acetate:

	<u>p-bromophenacyl ester</u>
XIVb prisms, mp 165-6°	hexagonal plates, mp 147-8°
XIVb' needles, mp 146-7°	needles, mp 127-8°

In addition the two acids and derivatives were characterized by nmr spectra. Spectra of derivatives exhibited the same characteristic signals due to the ring protons for each isomer. The nmr spectra of the methyl esters for each isomer are shown on p. 20.

Bicyclo[6.1.0]nona-2,4,6-triene-9-carboxaldehyde

Tosylhydrazone XIVc

A solution of XIVb (5.0g, 31 mmole) and oxalyl chloride (10 ml, 110 mmole) in dry benzene was stirred for 1 hour at room temperature and 1 hour at 40°. Evaporation *in vacuo* removed all volatile materials leaving a pale yellow solid (5.53g, 31 mmole, 100%) as the acid chloride. The ir spectrum of this residue exhibited typical acid chloride absorption at 1800 cm^{-1} .

To a stirred solution of this acid chloride in dry tetrahydrofuran (50 ml) at -70 ~ -80° was added dropwise a solution of lithium aluminum tri-*tert*-butyloxy hydride (7.88g, 31 mmole) in dry tetrahydrofuran (50 ml) over a period of 1 hour. The reaction mixture was allowed to warm to room temperature with an additional 1 hour stirring. After reacting the tetrahydrofuran solution with wet ether, it was shaken with Celite and filtered. Removal of the solvents from the filtrate by rotary evaporator left a colorless oil (3.80g, 83%). Evaluation of the nmr and ir spectra of this residual oil revealed that it was a mixture of aldehyde and alcohol, typically 50 ~ 75% aldehyde.

To a solution of tosylhydrazine (5.8g, 30 mmole) in warm methanol (10 ml) containing one drop of acetic acid was added this residual oil in *ca.* 2 ml methanol. The reaction stood one half hour at 0°. Scratching initiated crystallization and the crystals were filtered off, washed with cold methanol, and dried to yield

the tosylhydrazone XIVc (3.20g, 30% yield calc'd. on acid XIVb) as a light grey powder: mp 133° dec.

Bicyclo[6.2.0]deca-2,4,6,9-tetraene(XI)

A solution of the tosylhydrazone (1.7g, 5.4 mmole) and sodium methoxide (440 mg, 1.8mmole) was prepared in freshly distilled tetrahydrofuran (200 ml). This solution, immediately cooled to 0° with nitrogen bubbling through it, was subjected to irradiation by Pyrex filtered light from a medium pressure mercury lamp while vigorous stirring was provided by a 1½ inch magnetic stirring bar. Irradiation was continued at or near 0° (external cooling provided by a large beaker of ice or by a methanol bath containing a copper heat exchanging coil through which was forced cold ethyleneglycol from a Colora bath) until nitrogen evolution ceased (usually 3 to 4 hours). CO₂ was bubbled through the reaction mixture for a few minutes and the reaction mixture was filtered through Celite to remove the sodium sulfinate. Distillation at 0°/20 mm reduced the volume to ca. 3 ml. To 10 batches, combined at this stage, was added ice water (300 ml) and the resulting turbid solution was extracted with pentane (3x200 ml). The combined pentane extracts (washed with 3x200 ml ice water and with cold salt solution and dried over Na₂SO₄) were evaporated at 0°/20 mm to a volume of ca. 3 ml. This residual solution was introduced into a cold finger apparatus (the "cold finger" was attached

with a small tray) and the remaining pentane was removed at 0°/20 mm. The apparatus was a usual cold finger apparatus with one added feature: a cooling jacket, through which was forced cold ethylene glycol from a refrigeration bath, was positioned between the bottom of the vessel and the "cold finger".

Analysis of the nmr spectra and the glpc-3 trace of this pentane extract (1.16g, 16.5% hydrocarbon) showed it to consist typically of 40% XI, 25% cyclooctatetraene, 20% IX, 10% VI, and ~ 5% others. Fractional distillation with the jacketed cold finger apparatus provided fractions enriched in XII as shown:

Fraction	Jacket Temp. °	Pressure, mm	Distillate
1)	- 10	.04 - .02	280 mg 90% cyclooctatetraene
2)	- 10	.02	365 mg 60% XI
3)	- 10	.02 - .01	400 mg 65% XI
4)	- 5	.01	120 mg 50% VI

Fraction 1 was discarded, fraction 4 saved for recycling, and fractions 2 and 3 combined. Fractions 2 and 3 were further enriched in XI by selective AgNO_3 complex formation and extraction. Reaction of the combined fractions (765 mg, 5.7mmole) with ice cold aqueous 1.0M AgNO_3 solution (6.2 ml, 6.2mmole AgNO_3) under argon produced a crystalline mass. After standing at 0° for 0.5 hr. the mother liquors were drawn off and reserved.

Reaction of the crystals with cold 5M NH_4OH until the aqueous portion was basic to litmus and extraction with a small amount of pentane gave material that was 80% XI (nmr and glpc-3). Extraction of the cold mother liquors with ether (5x5 ml) gave material that was 65% XI. Reaction of the cold mother liquors after this extraction with NH_4OH gave material in which very little XI was present.

The 65% material was reserved for recycling and the 80% material was subjected to alumina chromatography (50g Woelm, neutral, I, pentane eluant). The chromatography column was jacketed with ice water for cooling. Combination of fractions containing pure XI provided a clear oil (120 mg, 3% yield excluding material reserved for recycling). The nmr and mass spectra of XI are shown on p. 25.

Photolysis of XI at -35°

A solution of XI (50 mg) in pentane (\sim 200 ml) was equilibrated at -35° in a conventional photolysis apparatus (low pressure lamp within a quartz jacket surrounded by a 200 ml well) by cooling the outside in a large beaker of dry ice-acetone and circulating 20° methanol-water in the lamp jacket. Vigorous stirring was provided by a 2 inch magnetic stirring bar and a low rate of nitrogen bubbling was maintained through the solution. The lamp was turned on for 6.0 minutes. The pentane

was distilled off at 0°/20 mm) and distillation of this residue onto a cold finger condensor at -70° provided 20 mg material which consisted of 48% VI, 25% III, 24% VII, and 8% IV as determined by nmr and glpc-1 methods. Irradiation for 10.0 minutes followed by the same work-up procedure provided material that consisted of 54% VI, 18% III, 14% VII, and 14% IV. The order of retention times of these compounds on all the glpc systems employed was the same as that reported by Jones and Scott.⁸

Photolysis of III, VII and XI at the low temperatures

-60°, -110° and -190°

The various parts of the photo apparatus are shown on pp. 35, 36 and 37. A temperature control device was centered in the coiled lamp that was surrounded by the cylindrical reflection mirror. The photolysis vessel was either a large quartz tube (used in the Dewar bottle) for preparative work or a quartz nmr tube used either in the Dewar bottle or Varian temperature control assembly, for qualitative work.

All qualitative nmr work was carried out with vacuum degassed samples. Typically samples of either III or XI were prepared in a suitable solvent (usually d₈-tetrahydrofuran) and distributed among quartz nmr tubes that could be fitted (with a quartz joint) to a standard high vacuum rack capable of maintaining 3 microns pressure.

Ordinary freeze-thaw cycles were carried out on the samples and the tubes were sealed.

Detailed results are shown on p. 48. Since the photolysis rate exhibited concentration dependence, care was exercised in producing samples of the same concentration in order that the comparisons were valid. Initially first half lives were reported for these photochemical transformations of .2M samples (nmr spectra on pp. 39 and 43). The later detailed results shown on p. 48) were carried out on .4M samples. Regions in the nmr spectra of the photoproducts chosen for integration (against an internal standard) were $\tau 6.2$ (2H) for XI, $\tau 6.75$ (2H) for III, $\tau 7.2$ (2H) for VII, $\tau 7.8$ (3H) for IV, and $\tau 8.9$ (4H) for X. The final product distribution was verified by glpc-3.

Irradiation with Corex filtered light was accomplished by placing a 513-27-114 Engelhard Corex filter (0% 2500A, 50% 2800A, 95% 3600A) around a temperature control device. An air flow was maintained between the filter and the cooling device and a HBO-200W super pressure mercury lamp was placed 2.5 cm from the photolysis vessel. Aluminum foil surrounded the lamp and filter for reflection purposes. When low temperature (-110°) irradiation of III or VII was carried out under these conditions, only a negligible amount of VII was detected in the product (nmr and glpc-3). The product distribution also showed a larger amount of IV present (30%).

For irradiation of compounds III, VII and XI at -190° , the quartz Dewar bottle filled with liquid nitrogen was used to maintain the temperature. A suitable clear glass was provided by a solvent system comprised of 50% d_6 -ethanol and 50% d_8 -tetrahydrofuran (v/v).

Reduction of Bullvalene(IV) with Diimide

a) At room temperature

To a stirred suspension of potassium diazodicarboxylate³³ (4.85g, 25mmole) in a methanol (20 ml) solution of IV (33g, 0.25mmole) was added dropwise over a period of 1 hour a methanol (5 ml) solution of acetic acid (4.5g, 75mmole). Stirring was continued for an additional 1 hour until the yellow color disappeared and gas evolution ceased. The resulting white suspension was taken up in cold water (200 ml) and extracted with pentane (50 ml). The pentane extract (washed with 50 ml 5% NaHCO_3 , 50 ml H_2O , then 30 ml saturated salt solution and dried through Na_2SO_4) contained 10% bullvalene and 90% reduced hexahydro-IV (glpc-3). After removing the solvent by spinning band distillation, the residue was subjected to preparative glpc-2 and the hexahydro-IV collected to yield white crystals (10 mg): ir, identical with that reported by Schröder, mass spec. M^+ , $m/e = 136$.

b) At -27°

To a stirred suspension of potassium diazodicarboxylate (4.85g, 0.25mmole) in a methanol (20 ml) solution of IV (33 mg, 0.25mmole) at -27° (Colora bath) was added dropwise over a period of 2.5 hr. a cold methanol (5 ml) solution of acetic acid (4.5g, 75mmole). Stirring at -25° for 72 hr. was required until the suspension turned white. The same work-up as before produced a pentane extract that contained *ca.* 50% IV and *ca.* 50% hexahydro-IV (glpc-3).

Reduction of Photolysate of III (containing 60% X)with Diimide at -40° and -20°

In a quartz tube with the bottom end drawn out in a short thin capillary was placed a tetrahydrofuran (1.5 ml) solution of III (250 mg, 1.9mmole). After flushing with argon, the solution was irradiated at -80° until the photolysate contained 60% X (glpc-3). The quartz tube was placed in a methanol (200 ml) slurry of potassium diazodicarboxylate (76g, 390mmole) at -40°. The quartz tube was then broken with a pre-cooled glass rod. Stirring was started and a cold methanol (70 ml) solution of acetic acid (22g, 1.2 mole) was slowly added over a period of 4 hr. Stirring was continued for 36 hr. at -40°, 5 hr. at -30°, and 32 hr. at -10°. The resulting white suspension was taken up in cold water (1.5L) and extracted with pentane (3x200 ml). Spinning band distillation of the combined pentane extracts (washed

with 200 ml cold saturated NaHCO_3 , 200 ml cold H_2O , and 200 ml saturated salt solution and dried through Na_2SO_4) reduced the material to *ca.* 3 ml. Examination of this residue by glpc-3 revealed the presence of at least 16 products. Chromatography of the residue over alumina (200g, Woelm neutral, I, pentane) provided fractions that contained compounds separable by glpc-1. Collection of all major peaks (glpc-1) ($\geq 5\%$) and examination of their mass spectrum and nmr spectrum revealed no saturated $\text{C}_{10}\text{H}_{14}$ compound. The reduction was also carried out at -20° with the same *negative* result.

Reduction of the Photolysate of III (containing XII and XIII) with Diimide at -70° to Room Temperature

A solution of III (120 mg) in 3-methyl pentane (.6 cc) was irradiated for 3.5 hr. at -60° . The temperature was reduced to -80° and the mother liquors of the photolysate withdrawn with a pre-cooled pipette. Examination of these mother liquors (nmr and glpc-3) showed that they contained XII, XIII, X, and III (see. p. 51 for nmr). To a stirred and degassed (by bubbling argon) slush of methanol (40 ml), water (20 ml), sodium diazodicarboxylate (10g) and sodium carbonate (40 mg) at -80° was added *ca.* one fifth of a cold methanol (20 ml) solution of acetic acid (7.4g). The mother liquors were then quickly

transferred to this cold slush by means of a pre-cooled pipette. The rest of the acetic acid solution was then added (~ 5 minutes addition time). The dry ice bath was removed and the stirred slush allowed to warm to room temperature. Using the same work-up procedure as before (p. 90) produced a pentane extract which was reduced in volume and subjected to catalytic hydrogenation (Pd/C, tetrahydrofuran, 4 hr.). The product distribution was shown by glpc-3 to contain (in order of retention times) *trans*-decalin, *cis*-decalin, cyclodecane and bicyclo[4.2.2]decane. Traces of reduced bullvalene products were also noted. Each peak was identified by mass spectra (MS-12) and by co-injection with authentic materials. The amount of cyclodecane present was only 2 ~ 3% of this product mixture, corresponding to ca. 25% of the original amount of XIII.

Low Temperature Catalytic Hydrogenation of Cyclododecene
with Rhodium

A three-neck flask was provided with mechanical stirring (completely enclosed motor) and in one side arm was placed a small sintered glass (4~8 μ) tube connected to a hydrogen and argon source. In the flask was then placed rhodium trichloride-trihydrate (250 mg, 1mmole) and dry ethanol (40 ml). A few drops of water were added in order to dissolve the metal salt. After adding 1g Darco G-60 charcoal, an argon flow through the

sintered glass tube immersed in the liquid and stirring were started. Then, NaBH_4 (80 mg, *ca.* 2mmole) in a little dry ethanol was added dropwise. Hydrogen bubbling (6 ml/min.) was started and the temperature reduced to -80° by a dry ice acetone bath. The sample in cold ethanol was injected and reaction progress monitored by glpc. Samples could be withdrawn catalyst free utilizing pre-cooled sintered glass tubes. Under these hydrogenation conditions, cyclododecene underwent reduction with a half life of 55 minutes.

Low Temperature Catalytic Hydrogenation of the
Photolysate of III (containing XII and XIII) with Rhodium

A photolysate was prepared as before (p. 91) and at the same time finely dispersed rhodium was prepared (p. 92) and equilibrated at -80° . The mother liquors from the precipitated photolysate were transferred to the stirred rhodium catalyst. Hydrogen bubbling at -80° was continued for 30 hours. Examination of the product (glpc-3) showed it to contain *cis*-decalin, cyclodecane, and bicyclo[4.2.2]decane. Traces of reduced bullvalene products were also noted. Cyclodecane present in this product distribution is 25 ~ 30% which was equivalent to the amount of XII and XIII present by an evaluation of the nmr spectra (see p. 51).

Thermal Isomerization of XI to *trans*-9,10-dihydronaphthalene(VII)

To 0.6 ml CDCl_3 was added freshly distilled XI (15 mg) (resulting in *ca* 0.2M solution), tetramethylsilane, and 6 μl CH_2Br_2 . This solution was introduced into two nmr tubes and degassed by freeze-thaw cycles on a high vacuum line, and the tubes were sealed. The isomerization was carried out in a 100 MHz nmr spectrometer at two temperatures which were assigned by the chemical shift of ethylene glycol as calibrated by a thermocouple. The reaction course was followed by monitoring the integration of the decreasing signal at $\tau 6.32$ and the increasing signal at $\tau 7.13$. Throughout the reaction the ratio of the sum of the intensities of these signals to the intensity of the signal attributed to CH_2Br_2 remained constant and at 10 half lives the only signals observable were those attributed to VII and CH_2Br_2 . A plot of $\ln \frac{\text{intensity } 6.32 + 7.13}{\text{intensity } 6.32}$ versus time described a straight line throughout 3 half lives. Kinetic parameters for this reaction are shown on p. 59.

Thermal Reaction(s) of VII

When a solution of pure VII was subjected to glpc-2, the collected material showed not only considerable material loss (50 ~ 60%) but also was contaminated by varying amounts (30 ~ 50%) of naphthalene and 1,2-dihydronaphthalene (nmr). Compound VII exhibited concentration dependent rates and product distributions

when heated at 115° in methyl cyclohexane:

VII conc.	naphthalene	Final % 1,2-dihydronaphthalene	Unknown Product	First Half Life
1.2M	46	34	20	80 min.
.2M	27	60	13	
.01M	19	81	0	400 min.

The final product distributions were measured by glpc-1 and the rates were followed by nmr spectroscopy in the more concentrated runs and by glpc-1 in the dilute run. The samples were degassed on a high vacuum line before the kinetics were run.

A methyl cyclohexane solution of XI (15 mg/0.55 ml, 0.2M) was placed in a break seal flask and was degassed and sealed. The solution was then heated at 115° for 48 hours. The break seal vessel was joined to a high vacuum rack and an analysis of the gaseous contents were performed (this analysis was kindly carried out by Dr. Obi). Hydrogen was demonstrated to be present by characteristic retention time over molecular sieves 13x with argon carrier and by its mass spectrum.

Thermal Isomerization of Tetracyclo[4.4.0.0^{2,10}.0^{5,7}]

deca-3,8-diene (X) to Bicyclo[4.2.2]deca-2,4,7,9-tetraene (VI)

The photolysate of III (0.3 ml of 0.25M d₈-tetrahydrofuran solution in a degassed and sealed quartz nmr tube) was generated by

irradiation for 2.5 hr. at -110° until it contained *ca* 65% X. The thermal reaction was carried out in a refrigerated liquid bath (Colora Kälte-Thermostat Type KT40-4206) the temperature of which was determined by an iron constantan thermocouple (reference 0°) which was calibrated at $+10^{\circ}$ with a NBS calibrated thermometer. The tube was transferred to the pre-cooled spectrometer (-70°) in an ethanol-dry ice bath. The increase of signals due to VI was monitored at $\tau 4.48$ to $\tau 4.58$ (see p. 43) and in addition the signals due to *cis*-9,10-dihydronaphthalene (III) were also monitored but showed no increase. An internal standard was provided by a small amount of 1,2-dihydronaphthalene present as an impurity in III. Treatment of the kinetic data permitted assignment of the kinetic parameters shown on p. 64.

Temperature Dependent nmr Spectra of VI

A solution of VI (52 mg), hexamethyldisilane (30 μ l) and *n*-dodecane (0.5 ml) was divided between two nmr tubes. The solutions were degassed and the tubes sealed. The nmr spectra were run at 100 MHz and the ambient temperatures were determined from a pre-calibrated ethylene glycol chemical shift. For spectra run in the same manner at 40 MHz, a solution of VI (70 mg), hexamethyldisilane (30 μ l), and d_{26} -*n*-dodecane in one nmr tube was similarly prepared and used. The temperature dependent spectra which were obtained are shown on pp. 67 and 68.

Bicyclo[4.2.2]deca-2,4,7-triene (XIX)

A 1.0M solution of VI (65 mg, 0.5mmole) in n-dodecane (0.5 ml) was degassed, sealed in a small ampoule, and heated at 180° for 10 hours. Chromatography of the product mixture over alumina (200g, Woelm I, neutral, pentane) yielded fractions of XIX that were free from VI which eluted later. Preparative glpc-1 of these fractions produced pure XIX (5 mg, 7 ~ 8%):
 nmr (CDCl₃) τ3.8-4.4 (complex signals of two groups, 6H), τ7.3 (broad, 2H) and τ7.9-8.5 (complex, 4H); principal fragments in mass spectrum, M⁺, m/e 132.0939 (50) (calc'd. for C₁₀H₁₂: 132.0939), 117(67), 104(68), 91(100), 78(41). Catalytic hydrogenation (Pd/C, tetrahydrofuran) of XIX provided material that was identical to material provided by catalytic hydrogenation of VI (glpc-3 and mass spectrum).

Kinetic Runs of the Thermolysis of VI

Solutions of various concentrations of VI (.008M, .08M, .4M, and .8M) and cyclooctane (internal standard) *in n-dodecane* were prepared and distributed among small ampoules (40 μl each) which were then sealed under vacuum. The two concentrations of VI (.64M and .32M) and n-dodecane (internal standard) *in cyclooctene* were also prepared and similarly distributed among small ampoules.

The kinetic runs were carried out in a silicon oil bath

constructed from a Dewar flask placed in a wooden box with a door. The heat supplied to the bath was controlled by a proportioning controller and the temperature of the bath was measured with a NBS calibrated thermometer and monitored with a Leeds & Northrup #8686 potentiometer (iron-constantan thermocouple, 0° reference). The bath never varied more than $\pm 0.2^\circ$ from the set temperature of the runs.

Before analysis the ampoules were placed in liquid nitrogen and immediately broken open. Analysis of the contents was accomplished by glpc-3. Integration of the component peaks was carried out with a K & E compensating polar planimeter.

From examination of the glpc traces of the runs in *n*-dodecane the following summary of product yields was made:

Initial conc. of VI	Yield of III	Yield of XIX
.008M	7%	3%
.08M	4%	10%
.4M	1%	15%
.8M	trace	16%

Plots of $\ln \frac{C_0}{C}$ versus time in the more concentrated runs in *n*-dodecane generated lines typified by the example shown on p. 73. However, in the more dilute cases the data were rendered somewhat obscure as the glpc trace became cluttered with peaks.

The disappearance of II in cyclooctene was first order and the only products discernable were cyclooctane and naphthalene (glpc-3). Kinetic parameters measured for this reaction are shown on pp. 73 and 74.

Kinetic Runs of the Thermolysis of VI

A 0.33M solution of IV in d_{26} -*n*-dodecane containing *p*-di-*tert*-butylbenzene (internal standard) was prepared and distributed among several nmr tubes which were degassed and sealed. The runs were carried out in a bath similarly constructed as the one described on p. 98. Analysis of the product mixture of each run was accomplished by nmr spectroscopy performed at 100°. Treatment of the data enabled calculation of the parameters shown on p. 77.

REFERENCES

1. A.T. Balaban, Rev. Roumaine Chim., 11, 1097 (1966).
Also, J. Lederberg has carried out a tabulation of 10-vertex graphs that was kindly sent to our laboratory by R. Hoffmann.
2. As an example, for an extensive analysis of $(C-CH_3)_6$ thermal isomerizations see: J.F.M.Oth, Angew. Chem. internat. Edit., 7, 646 (1968).
3. M. Avram, E. Sliam and C.D. Nenitzescu, Ann., 636, 184 (1960).
4. R.B. Woodward, T. Fukunaga and R.C. Kelley, J. Am. Chem. Soc., 86, 3162 (1964).
5. E.E. van Tamelen and B. Pappas, J. Am. Chem. Soc., 85, 3296 (1963).
- 6 a) G. Schröder, Ber., 97, 3140 (1964).
b) G. Schröder and J.F.M. Oth, Angew. Chem. internat. Edit., 6, 414 (1967) and previous articles in this series.
7. S. Masamune, H. Cuts, and M. Hogben, Tetrahedron Letters, 1017 (1965).
8. M. Jones, Jr., and L.T. Scott, J. Am. Chem. Soc., 89, 150 (1967).
9. E.E. van Tamelen and T.L. Burkoth, J. Am. Chem. Soc., 89, 151 (1967).
10. M. Jones, Jr., J. Am. Chem. Soc., 89, 4236 (1967).















































11. S. Masamune, H. Zenda, M. Wiesel, N. Nakatsuka and G. Bigam, J. Am. Chem. Soc., 90, 2727 (1968).
12. R.B. Woodward and R. Hoffmann, J. Am. Chem. Soc., 87, 395 (1965). H.C. Longuet-Higgins and E.W. Abrahamson, J. Am. Chem. Soc., 87, 2045 (1965).
R.B. Woodward and R.H. Hoffmann, J. Am. Chem. Soc., 87, 2046 (1965).
R.B. Woodward and R. Hoffmann, J. Am. Chem. Soc., 87, 2511 (1965).
R. Hoffmann and R.B. Woodward, Accounts Chem. Res., 1, 17 (1968).
13. W. Kirmse and K.H. Pook, Chem. Ber., 4022 (1965).
14. M. Jones, Jr., and S.D. Reich, J. Am. Chem. Soc., 89, 3935 (1967). M. Jones, Jr., S.D. Reich, L.T. Scott and L.E. Sullivan, Angew Chem. internat. Edit., 7, 644 (1968).
15. W. von E. Doering and J.W. Rosenthal, J. Am. Chem. Soc., 88, 2078 (1966).
16. W. von E. Doering and J.W. Rosenthal, Tetrahedron Letters, 349 (1967).
17. W. von E. Doering and J.W. Rosenthal, J. Am. Chem. Soc., 89, 4534 (1967).
18. Other (CH)₁₀ isomerizations were reported in references 10, 11, 15 and 16.































































19. S. Masamune and N.T. Castellucci, Angew. Chem. internat. Edit., 3, 582 (1964).
20. S. Akiyoshi and T. Matsuda, J. Am. Chem. Soc., 77, 2476 (1955), K.F. Bangert and V. Boekelheide, J. Am. Chem. Soc., 86, 905 (1964). W. Kirmse and H. Dietrich, Chem. Ber., 4027 (1965).
21. E.A. Hill and J.D. Roberts, J. Am. Chem. Soc., 89, 2047 (1967).
22. J.D. Roberts, "Molecular Orbital Calculations", W.A. Benjamin, Inc., New York, 1962.
23. S. Masamune and K. Hojo, unpublished.
24. E. Vogel, Ann. Chem., 615, 1 (1958).
25. H.C. Brown and C.A. Brown J. Am. Chem. Soc., 84, 1494 (1962).
26. T.L. Burkoth, Ph.D. Thesis, Stanford University, 1967.
27. R.J. Ellis and H.M. Frey, J. Chem Soc. (A), 553 (1966).
S.W. Benson and R. Shaw, Trans. Faraday Soc., 985 (1967).
28. H.O. House and T.H. Crown, J. Org. Chem., 30, 1061 (1965).
29. J.D. Roberts, "Nuclear Magnetic Resonance", McGraw Hill Book Co. Inc., New York, 1959, p. 63.
30. E. Babad, D. Ginsburg, and M. Rubin, Tetrahedron Letters, 2361 (1968).
31. W. Grimme, H. Riebel and E. Vogel; Angew. Chem. internat. Edit., 7, 823 (1968).

32. M. Jones, Jr., and B. Fairless, Tetrahedron Letters, 4481 (1968).
33. J. Thiel, Ann. Chem., 271, 127 (1892).
34. S. Masamune, C.G. Chin, K. Hojo and R.T. Seidner, J. Am. Chem. Soc., 89, 4804 (1967).
35. S. Masamune, R.T. Seidner, H. Zenda, M. Wiesel, N. Nakatsuka and G. Bigam, J. Am. Chem. Soc., 90, 5286 (1968).
36. Material prepared by the three separate routes exhibited identical nmr, ir, and mass spectra and glpc retention times. See reference 34.
37. Material prepared by the two routes exhibited identical nmr, ir, and mass spectra and glpc retention times. See reference 11.
38. Material prepared by the two routes exhibited identical nmr, ir, and mass spectra and the same mp (no depression with a mixed mp). See reference 35.

APPENDIX I

Possible $(CH)_x$ structures¹ for $x = 4, 6, 8,$ and 10 :

No. of double bonds	0	1
4	 4-0-1	-
6	 6-0-1	 6-1-1
8	 8-0-1	 8-1-1
10	 10-0-1	 10-1-1
	 10-0-2	 10-1-2
	 10-0-3	 10-1-3
	 10-0-4	 10-1-4
	 10-0-5	 10-1-5
	 10-0-6	 10-1-6
	 10-0-7	 10-1-7
	 10-0-8	 10-1-8
	 10-0-9	 10-1-9
	 10-0-10	 10-1-10
	 10-0-11	 10-1-11
	 10-0-12	 10-1-12
	 10-0-13	 10-1-13
	 10-0-14	 10-1-14
	 10-0-15	 10-1-16
	 10-0-15	 10-1-17
	 10-0-17	 10-1-18
	 10-0-18	 10-1-19
	 10-0-19	 10-1-20
		 10-1-21
		 10-1-22
		 10-1-23

2	3	4	5
 4-2-1	-	-	-
 6-2-1  6-2-2	 6-3-1	-	-
 8-2-1  8-2-2  8-2-3  8-2-4  8-2-5	 3-3-1  8-3-2  8-3-3  8-3-4	 8-4-1	-
 10-2-1  10-2-2  10-2-3  10-2-4  10-2-5  10-2-6  10-2-7  10-2-8  10-2-9  10-2-10  10-2-11  10-2-12  10-2-13  10-2-14  10-2-15  10-2-16  10-2-17  10-2-18  10-2-19  10-2-20  10-2-21  10-2-22  10-2-23  10-2-24  10-2-25	 10-3-1  10-3-2  10-3-3  10-3-4  10-3-5  10-3-6  10-3-7  10-3-8  10-3-9  10-3-10  10-3-11  10-3-12  10-3-13  10-3-14  10-3-15  10-3-16	 10-4-1  10-4-2  10-4-3  10-4-4  10-4-5  10-4-6  10-4-7	 10-5-1

VITAE

The author was born on May 20th, 1942 in Alhambra, California where he obtained his elementary and high school education. In 1960 he entered the University of California at Riverside and in 1962 he transferred to the University of California at Los Angeles from which he graduated with a B.S. in 1964. That same year he entered the Faculty of Graduate Studies in the Department of Chemistry at the University of Alberta, Edmonton. From 1964 to 1969 he was employed as a Graduate Teaching Assistant by the Department of Chemistry.