



National Library
of Canada

Bibliothèque nationale
du Canada

Canadian Theses Service

Service des thèses canadiennes

Ottawa, Canada
K1A 0N4

NOTICE

The quality of this microform is heavily dependent upon the quality of the original thesis submitted for microfilming. Every effort has been made to ensure the highest quality of reproduction possible.

If pages are missing, contact the university which granted the degree.

Some pages may have indistinct print especially if the original pages were typed with a poor typewriter ribbon or if the university sent us an inferior photocopy.

Reproduction in full or in part of this microform is governed by the Canadian Copyright Act, R.S.C. 1970, c. C-30, and subsequent amendments.

AVIS

La qualité de cette microforme dépend grandement de la qualité de la thèse soumise au microfilmage. Nous avons tout fait pour assurer une qualité supérieure de reproduction.

S'il manque des pages, veuillez communiquer avec l'université qui a conféré le grade.

La qualité d'impression de certaines pages peut laisser à désirer, surtout si les pages originales ont été dactylographiées à l'aide d'un ruban usé ou si l'université nous a fait parvenir une photocopie de qualité inférieure.

La reproduction, même partielle, de cette microforme est soumise à la Loi canadienne sur le droit d'auteur, SRC 1970, c. C-30, et ses amendements subséquents.

University of Alberta

THE EFFECT OF TEMPERATURE ON PRODUCTION OF MONOCLONAL
ANTIBODIES FROM HYBRIDOMA CELLS

by

Jan Willem Bloemkolk



A thesis

submitted to the Faculty of Graduate Studies and Research
in partial fulfilment of the requirements for the degree of
Master of Science

Department of Chemical Engineering

Edmonton, Alberta

Fall, 1991



National Library
of Canada

Bibliothèque nationale
du Canada

Canadian Theses Service Service des thèses canadiennes

Ottawa, Canada
K1A 0N4

The author has granted an irrevocable non-exclusive licence allowing the National Library of Canada to reproduce, loan, distribute or sell copies of his/her thesis by any means and in any form or format, making this thesis available to interested persons.

The author retains ownership of the copyright in his/her thesis. Neither the thesis nor substantial extracts from it may be printed or otherwise reproduced without his/her permission.

L'auteur a accordé une licence irrévocable et non exclusive permettant à la Bibliothèque nationale du Canada de reproduire, prêter, distribuer ou vendre des copies de sa thèse de quelque manière et sous quelque forme que ce soit pour mettre des exemplaires de cette thèse à la disposition des personnes intéressées.

L'auteur conserve la propriété du droit d'auteur qui protège sa thèse. Ni la thèse ni des extraits substantiels de celle-ci ne doivent être imprimés ou autrement reproduits sans son autorisation.

ISBN 0-315-70193-5

Canada

UNIVERSITY OF ALBERTA
RELEASE FORM

NAME OF AUTHOR: J.W. Bloemkolk

TITLE OF THESIS: The Effect of Temperature on Production of
Monoclonal Antibodies from Hybridoma Cells

DEGREE: Master of Science

YEAR THIS DEGREE GRANTED: 1991

Permission is hereby granted to the UNIVERSITY OF ALBERTA LIBRARY to reproduce single copies of this thesis and to lend or sell such copies for private, scholarly or scientific research purposes only.

The author reserves all other publication and other rights in association with the copyright in the thesis, and neither the thesis nor extensive extracts from it may be printed or otherwise reproduced without the author's written permission.

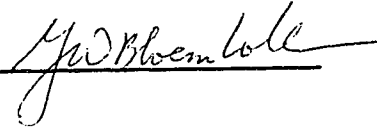
Signed: 

Permanent Address:
Prins Hendriklaan 126
2051 JH Overveen
The Netherlands

Date: Sept 5, 1991

THE UNIVERSITY OF ALBERTA

FACULTY OF GRADUATE STUDIES AND RESEARCH

The undersigned certify that they have read, and recommend to the Faculty of Graduate Studies and Research, for acceptance, a thesis entitled THE EFFECT OF TEMPERATURE ON PRODUCTION OF MONOCLONAL ANTIBODIES FROM HYBRIDOMA CELLS submitted by Jan Willem Bloemkolk in partial fulfillment of the requirements for the degree of Master of Science.

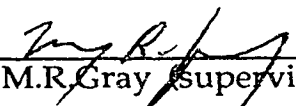

Dr. M.R. Gray (supervisor)

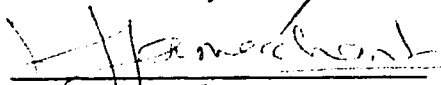

Dr. F. Merchant

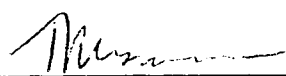

Dr. T.R. Mosmann



Dr. S.E. Wanke

Date: August 30, 1991

ABSTRACT

In vitro cultivation of hybridoma cells for the production of monoclonal antibodies is greatly affected by environmental conditions. The optimal condition for growth is not necessarily identical to the optimal condition for antibody formation. In addition, it is believed that antibody biosynthesis takes place in the G_1 -phase, or phase of no cell division, of the hybridoma cell cycle. Conditions that prolong the G_1 -phase could thus increase specific antibody production.

The effect of temperature has received little attention, yet temperature is likely to affect growth and antibody formation, as well as cell cycle events in hybridoma cells. In this study, the kinetics of growth and antibody formation of an anti-interleukin-2 producing hybridoma line was studied in suspension culture at temperatures ranging from 34 to 39°C. Flow cytometry was used to determine the effect of temperature on the cell cycle.

Maximum cell density and monoclonal antibody yield was observed at 37°C in non-agitated cultures. In agitated cultures, maximum cell density was obtained at 34°C, whereas maximum antibody yield occurred at both 34 and 37°C. Thus the optimum temperature for cell growth and antibody yield was identical. The specific monoclonal antibody production rate appeared to be constant throughout a batch experiment. Lower temperatures caused cells to stay longer in the G_1 -phase of the cell cycle, but temperature had a marginal effect on the specific antibody production rate. A non-growth associated relation that linked antibody formation to the fraction of cells in G_1 -phase described antibody formation equally well as a relation that linked antibody formation to the whole population. Arresting of cells in the G_1 -phase by means of temperature is therefore not suited for enhanced monoclonal antibody production. Rather, antibody production for this hybridoma was directly linked to viable cell concentration. In addition, the observations made in this study and comparison with literature data indicate that the biological differences between different hybridoma lines should be an important consideration in the scale-up of monoclonal antibody production.

ACKNOWLEDGEMENTS

I am very thankful to all those people who supported and assisted me throughout the work that resulted in this thesis, and who made my stay at the University of Alberta a pleasant and memorable one. Dr. Murray Gray, for his supervision, suggestions and valuable help in many ways. Dr. Fahar Merchant, for his assistance, support and the use of the facilities at the Alberta Research Council. Dr. Tim Mosmann, for all the time and effort he spent in assisting me at the Department of Immunology, and for introducing me to the many secrets of immunology. Rita Marcotte and Agnes Szczepek, for their help with experimental methods.

TABLE OF CONTENTS

Chapter		Page
1	INTRODUCTION	1
2	LITERATURE REVIEW	4
	2.1 Introduction	4
	2.2 Cell Biology and metabolism	5
	2.3 Antibody synthesis	7
	2.4 Division of mammalian cells: cell cycle theory	8
	2.5 Kinetics of growth and product formation	11
	2.6 Parameters affecting cell growth and antibody formation	19
	2.6.1 Shear	19
	2.6.2 Oxygen requirements	19
	2.6.3 Waste products, pH and osmolarity	20
	2.6.4 Temperature	21
	2.7 Production systems	24
3	EXPERIMENTAL METHODS AND MATERIALS	26
	3.1 Cell line and growth conditions	26
	3.1.1 Non-agitated cultures	26
	3.1.2 Agitated Spinner cultures	27
	3.1.3 Agitated Fermenter cultures	27
	3.2 Analytical methods	28
	3.2.1 Viable cell number	28
	3.2.2 Monoclonal antibody	29
	3.2.2.1 Enzyme Linked Immuno Sorbent Assay	29
	3.2.2.2 MTT Bioassay	30
	3.3 Flow Cytometry	31

Chapter	Page	
4	RESULTS AND DISCUSSION	32
4.1	Growth and antibody production in batch suspension culture	32
4.1.1	Cell growth in non-agitated cultures	32
4.1.2	Effect of medium enrichment	34
4.1.3	Effect of pH	35
4.1.4	Oxygen limitation	37
4.1.5	Time course antibody formation	38
4.1.6	Growth and antibody production with agitation	39
4.2	Experimental error analysis	43
4.3	Effect of temperature on growth and antibody production	45
4.3.1	Non-agitated cultures	48
4.3.2	Agitated cultures	53
4.3.3	Antibody production during cell-cycles	57
4.4	Effect of temperature on bioactivity	63
4.5	Temperature shift	68
5	SUMMARY AND CONCLUSIONS	71
	REFERENCES	73
	APPENDIX 1: Fortified media formulation	82
	APPENDIX 2: Repeated experiments: Agitated and non-agitated cultures of S4B6	83
	APPENDIX 3: Oxygen transfer in non-agitated cultures	102
	APPENDIX 4: Repeated experiments: Flow Cytometry data	103
	APPENDIX 5: Regression results	110
	APPENDIX 6: Repeated experiments: Bioassays	116

LIST OF TABLES

Table		Page
1	Typical cell mass and monoclonal antibody yield in batch culture	18
2	Bioreactor system characteristics for hybridoma cultivation (values reported are maximum attainable)	25
3	Effect of repeated fed-batch on viable cell number and approximate viability. Analysis was done 24 h after each sample	35
4	Effect of HEPES buffer supplementation (25 mM) on maximal cell density and pH buffering	37
5	Effect of temperature in non-agitated cultures	52
6	Effect of temperature in agitated cultures	53
7	Comparison of regression results between the models given by equation (4) and equation (7). Specific antibody production rates β and β' in pg/cell/h. The coefficient of determination is given for each fit. See also Appendix 5. The ratio β/β' represents the average fraction of cells in G_1 -phase.	61

LIST OF FIGURES

Figure		Page
1	Four successive phases of the cell cycle. After M phase, which consists of nuclear division and cytoplasmic division, daughter cells begin a new cycle. A new cycle starts with gap 1 phase (G_1 -phase), in which the cells, whose biosynthetic activities have been greatly slowed during mitosis, resume a high rate of biosynthesis. The S phase begins when DNA synthesis starts and ends when DNA content of nucleus has doubled. The cell then enters a second gap phase, G_2 , which ends when mitosis starts. Division will normally stop when the restriction point in late G_1 phase is reached, unless it is signaled to continue through another whole cycle. The cell stopping at late G_1 is called an arrested cell and symbolized by A.	9
2	Specific antibody production rate of cultures treated to inhibit growth but not mab synthesis: cultures were either treated with hydroxyurea or thymidine (Suzuki and Ollis, 1990).	16
3a	Monoclonal antibody and cell concentration through a batch of inhibitor-free culture (Suzuki and Ollis, 1990).	17
3b	Monoclonal antibody and cell concentration through a batch of growth-inhibited culture (Suzuki and Ollis, 1990).	17
4	Viable cell density and monoclonal antibody concentration during non-agitated batch culture at 37°C.	33
5	Viable cell density in non-agitated batch culture, using fortified medium. 5X amino acids, vitamins, glutamine, glucose and glutathione. Salt reduction as given.	36
6	Bioactivity of produced antibody during batch experiment at 37°C. Optical density (proportional to HT2 cell proliferation in presence of IL2) as function of sample dilution. IL2 standard represents the proliferation of HT2 as function of IL2 dilution (separate experiment). Samples from S4B6 culture supernatant were added and diluted at a constant IL2 concentration, yielding 50% of maximum HT2 proliferation as determined from standard curve.	40

Figure		Page
7	Viable cell density and monoclonal antibody concentration during batch experiment in agitated spinner flask at 37°C.	41
8	Viable cell density and monoclonal antibody concentration during batch experiment in agitated fermenter at 37°C.	42
9	Typical error from cell counting using hemocytometer. Error bars represent standard deviation from quadruplicate counts.	44
10a	Typical error in ELISA standard curve. Standard deviation resulting from triplicate sample measurement.	46
10b	Straight line approximation of ELISA standard curve for optical density between 0.1 and 0.8. Approximate error (standard deviation) resulting from triplicate sample measurement.	46
11	Typical error in measured antibody concentration.	47
12	Viable cell density and monoclonal antibody concentration during non-agitated batch culture at 34°C.	49
13	Viable cell density and monoclonal antibody concentration during non-agitated batch culture at 35°C.	50
14	Viable cell density and monoclonal antibody concentration during non-agitated batch culture at 38°C.	51
15	Viable cell density and monoclonal antibody concentration during batch experiment in agitated spinner flask at 34°C.	54
16	Viable cell density and monoclonal antibody concentration during batch experiment in agitated spinner flask at 38°C.	55
17	Fraction of cell population in G ₁ , S and G ₂ +M phase during batch experiment in agitated spinner at 34°C.	58
18	Fraction of cell population in G ₁ , S and G ₂ +M phase during batch experiment in agitated spinner at 37°C.	59
19	Fraction of cell population in G ₁ , S and G ₂ +M phase during batch experiment in agitated spinner at 38°C.	60
20	Comparison of bioactivity of final supernatant samples from agitated cultures at 34, 37 and 38°C. See text.	64

Figure	Page
21 Bioassay for 34°C agitated culture. Proliferation of HT2 cells (optical density) as function of sample dilution at constant IL2. Comparison of IL2 blocking activity between t=0 h and t=172 h. Ascites antibody 1:10 as positive control, non reacting hybridoma supernatant (chapter 2) as negative control.	65
22 Bioassay for 37°C agitated culture. Proliferation of HT2 cells (optical density) as function of sample dilution at constant IL2. Comparison of IL2 blocking activity between t=0 h and t=132 h. Ascites antibody 1:10 as positive control, non reacting hybridoma supernatant (chapter 2) as negative control.	66
23 Bioassay for 38°C agitated culture. Proliferation of HT2 cells (optical density) as function of sample dilution at constant IL2. Comparison of IL2 blocking activity between t=0 h and t=137 h. Ascites antibody 1:10 as positive control, non reacting hybridoma supernatant (chapter 2) as negative control.	67
24 Viable cell density and monoclonal antibody concentration during shift in temperature from T=37°C to T=34°C. Shift at t=72 h.	69
A2-1 Viable cell density and monoclonal antibody concentration during non-agitated batch culture at 34°C (1). Appeared as Figure 12 in text.	83
A2-2 Viable cell density and monoclonal antibody concentration during non-agitated batch culture at 34°C (2).	84
A2-3 Viable cell density and monoclonal antibody concentration during non-agitated batch culture at 35°C (1). Appeared as Figure 13 in text.	85
A2-4 Viable cell density and monoclonal antibody concentration during non-agitated batch culture at 35°C (2).	86
A2-5 Viable cell density and monoclonal antibody concentration during non-agitated batch culture at 37°C (1). Appeared as Figure 4 in text.	87

Figure	Page
A2-6 Viable cell density and monoclonal antibody concentration during non-agitated batch culture at 37°C (2).	88
A2-7 Viable cell density and monoclonal antibody concentration during non-agitated batch culture at 37°C (3).	89
A2-8 Viable cell density and monoclonal antibody concentration during non-agitated batch culture at 37°C (4).	90
A2-9 Viable cell density and monoclonal antibody concentration during non-agitated batch culture at 37°C (5).	91
A2-10 Viable cell density and monoclonal antibody concentration during non-agitated batch culture at 38°C (1). Appeared as Figure 14 in text.	92
A2-11 Viable cell density and monoclonal antibody concentration during non-agitated batch culture at 38°C (2).	93
A2-12 Viable cell density and monoclonal antibody concentration during batch experiment in agitated spinner flask at 34°C (1). Appeared as Figure 15 in text.	94
A2-13 Viable cell density and monoclonal antibody concentration during batch experiment in agitated spinner flask at 34°C (2).	95
A2-14 Viable cell density and monoclonal antibody concentration during batch experiment in agitated spinner flask at 37°C (1). Appeared as Figure 7 in text.	96
A2-15 Viable cell density and monoclonal antibody concentration during batch experiment in agitated spinner flask at 37°C (2).	97
A2-16 Viable cell density and monoclonal antibody concentration during batch experiment in agitated spinner flask at 38°C (1). Appeared as Figure 16 in text.	98
A2-17 Viable cell density and monoclonal antibody concentration during batch experiment in agitated spinner flask at 38°C (2).	99

Figure	Page
A2-18 Viable cell density and monoclonal antibody concentration during shift in temperature from T=37°C to T=34°C. Shift at t=72 h (1). Appeared as Figure 24 in text.	100
A2-19 Viable cell density and monoclonal antibody concentration during shift in temperature from T=37°C to T=34°C. Shift at t=72 h (2).	101
A4-1 Fraction of cell population in G ₁ , S and G ₂ +M phase during batch experiment in agitated spinner at 34°C (1). Appeared as Figure 17 in text.	103
A4-2 Fraction of cell population in G ₁ , S and G ₂ +M phase during batch experiment in agitated spinner at 34°C (2).	104
A4-3 Fraction of cell population in G ₁ , S and G ₂ +M phase during batch experiment in agitated spinner at 37°C (1). Appeared as Figure 18 in text.	105
A4-4 Fraction of cell population in G ₁ , S and G ₂ +M phase during batch experiment in agitated spinner at 37°C (2).	106
A4-5 Fraction of cell population in G ₁ , S and G ₂ +M phase during batch experiment in agitated spinner at 38°C (1). Appeared as Figure 19 in text.	107
A4-6 Fraction of cell population in G ₁ , S and G ₂ +M phase during batch experiment in agitated spinner at 38°C (2).	108
A4-7 Example of histogram from flow cytometric analysis.	109
A5-1 Regression results non-agitated cultures at 34 and 35°C. Determination of β .	110
A5-2 Regression results non-agitated cultures at 37 and 38°C. Determination of β .	111
A5-2 Regression results non-agitated cultures at 37 and 38°C. (continued). Determination of β .	112
A5-3 Regression results agitated cultures at 34, 37 and 38°C. Determination of β .	113
A5-4 Regression results agitated cultures at 34, 37 and 38°C. Determination of β' .	114

Figure	Page
A5-5 Regression results agitated cultures at 34, 37 and 38°C. Determination of β . Same number of samples as in A5-4.	115
A6-1 MTT assay duplicate results at 34°C.	116
A6-2 MTT assay duplicate results at 37°C.	117
A6-3 MTT assay duplicate results at 38°C.	118

NOMENCLATURE

A	Arrested phase	
D	Dilution rate	h^{-1}
D	Diffusion coefficient	m^2/s
G_1	Gap-1 phase of cell cycle	
G_2	Gap-2 phase of cell cycle	
K_s	Saturation constant	g/L
M	Mitosis	
P	Product concentration	g/L
S	Substrate concentration	g/L
S	DNA synthesis phase	
t	Time	h
X, x	Viable cell number	mL^{-1}
y_{G1}	Fraction of population in G_1 -phase	

Greek symbols

α	Yield factor	g/g
β	Specific production rate	$g/cell/h$
β'	Specific production rate based on G_1 -phase	$g/cell/h$
μ	Specific growth rate	h^{-1}
μ_{max}	Maximum specific growth rate	h^{-1}

CHAPTER 1

INTRODUCTION

In recent years the cultivation of mammalian cells has become increasingly important for production of a variety of proteins and hormones. A number of useful applications exist for the products that can be synthesized by these cells and this number has been rising rapidly (Spier, 1988; Gatz *et al.*, 1983; Mizrahi, 1986). Many of these products are being developed for human and animal health care and diagnosis, and the demand is likely to increase.

Mammalian cells are highly specialized and their products are often chemically complex and in biologically active form. Attempts are being made to obtain these products by other means such as chemical synthesis, or conventional microbial culture in combination with recombinant DNA technology. Examples of successes are interferon and interleukins, epidermal growth factor and hepatitis B vaccine. For other products (*e.g.* erythropoietin, human growth factor, tissue plasminogen activator, monoclonal antibodies) cell culture remains the exclusive means of synthesis (Anonymous, 1990). Both bacterial and yeast expression systems may not be suitable for synthesis of certain mammalian derived proteins. The process of translating the genetic code into proteins differs between mammalian cells and yeast or bacterial cells, and the product may not be secreted into the culture medium (Goochee and Monica, 1990; Spier and Fowler, 1985). Also U.S. federal regulations may restrict the use of certain expression systems unless proven safe (Anonymous, 1988; Thayer, 1991). As a result, cultivation of mammalian cells remains necessary in order to obtain those products that cannot be synthesized in any other way.

The technology of cultivation of microorganisms for the synthesis of biologicals and chemicals is well known and has been widely applied on a

large scale in industry. Bulk production of ethanol, antibiotics and recombinant proteins through fermentation has been well established.

On the other hand the cultivation of mammalian (animal) cells has introduced many new problems. A number of good reviews on potential and problems of mammalian cell culture have been published in recent years (see Chapter 2). Most problems are due to the sensitivity of the cells to environmental influences. Growth requirements may vary extremely for different type of cells and in some cases the cells must be attached to a solid support. Also the metabolism and growth requirements are often poorly understood. As a result, these cells are often cultured under conditions that are neither optimal for cell growth, nor for product formation.

One important product group derived from mammalian cells is the monoclonal antibody (mab) which is synthesized by hybridoma cells. A hybridoma is the fusion product of a single B-lymphocyte, responsible for antibody synthesis, and a single cancerous myeloma cell. The resulting hybrid cell benefits from the properties of the mother cells: antibody formation and rapid, indefinite division respectively. Antibodies produced by the offspring of a single hybridoma are called monoclonal. Its property of binding to a particular molecular structure (antigen) has resulted in a number of useful applications in diagnosis and treatment of disease, specific assays and affinity purification.

Specific product yields from hybridoma cultures in artificially formulated media in culture vessels (*in vitro*) are generally low (up to 100 mg mab per litre). *In vivo* production methods make use of the peritoneal cavity of host animals in which the hybridoma is cultured to yield up to 1 g/L of mab. However, the *in vitro* method is cleaner with respect to process and purification of the product and can be scaled up to larger volumes in a reproducible manner. In order to make the process economically feasible and in order to satisfy market demands, both cell growth and product synthesis must be improved.

Currently, hybridomas are mainly grown in suspension culture. Several strategies have already been developed to increase product formation by

hybridomas. These include assessment of growth requirements, improvement of oxygen transfer in a low shear environment and bioreactor development. A better insight in metabolism and kinetics of growth and product formation can possibly lead to a reduction of waste metabolite build up, a more efficient use of medium components as well as an overall increased product yield.

An aspect that has not received much attention is the effect of temperature on hybridoma growth and mab formation. This effect can be substantial and the optimum for growth may differ from the optimum for product formation. A known example from the fermentation industry is the production of penicillin in which the highest biomass density is achieved at 30°C, but the penicillin synthesis is enhanced at 15°C. Recognition of this aspect has led to the development of an optimal temperature profile during the course of the fermentation which has resulted in 20% yield improvement (Bailey and Ollis, 1986; Constantidines *et al.*, 1970). Other optimal temperature profiles have been determined for plant cell cultures of *Catharanthus roseus* (Bailey and Nicholson, 1989) and a recombinant *Escherichia coli* process in which plasmid expression depends on temperature (Hortascu, 1990). The fact that hybridoma cells are derived from B-lymphocytes also challenges the question whether one temperature would be optimal for both growth and antibody formation. The immune system must function under conditions of elevated body temperature and although the exact responses of the immune system under these conditions should be studied, this may serve as an indication that the effect of temperature is not trivial.

The main focus of the work presented in this thesis is to study the effect of temperature on growth and antibody production by a hybridoma cell line in suspension culture. Important aspects of hybridoma cell cultivation are briefly reviewed (Chapter 2) including culture methods and conditions, growth characteristics and kinetics. Also specific background material with regard to temperature effects is presented in this chapter. Experimental design in order to assess such effects and the obtained results can be found in Chapter 3 and Chapter 4. These results may possibly lead to improvement of product yield and form the basis for an optimal temperature control strategy.

CHAPTER 2

LITERATURE REVIEW

2.1 Introduction

It was not until 1975 that it became possible to produce an antibody directed against one particular antigen in the laboratory (Köhler and Milstein, 1975). Short living B-lymphocytes, obtained from the spleen of an immunized animal, are fused with their cancerous, non-producing, counterpart (myeloma) which is capable of virtually indefinite reproduction. The resulting hybrid cell is called a hybridoma. It can be cultured either *in vivo* in the peritoneal cavity of a host animal (for example rodents) or *in vitro* in a properly chosen culture medium. By previous selection of hybridomas in medium containing hypoxanthine, aminopterin and thymidine (HAT) and subsequent screening for antibody formation, the hybridoma clone of interest may be selected and propagated. The resulting antibody originates from one clone and is accordingly named a monoclonal antibody. Both Sikora and Smedley (1984) and Cathy (1988) give detailed information on techniques for selection of the proper hybridoma clone.

Propagation of hybridomas *in vivo* has several disadvantages. Purification of the product has to be rigorous in order to meet U.S. federal requirements (FDA) and will often be unacceptable for therapeutic use (Anonymous, 1988). The yield per animal, often a rodent, is low (50 mg/mouse) and therefore large quantities of animals must be sacrificed for a production of kilograms per year. This technique also introduces the problem of variability between batches. When dealing with human-derived product, these problems are even more apparent and animal derived antibody may not be suitable for human use. Consequently an *in vitro* culture method is preferred in which conditions may

be imposed upon the culture, reproducibility can be expected to be good and scaling to larger volumes is possible.

This chapter will review the main aspects of hybridoma culture *in vitro* that determine cell growth and antibody production. The effect of different growth parameters and environmental conditions on growth and product formation will be discussed. The last section deals briefly with bioreactors for hybridoma culture and some aspects of larger scale processes.

In this chapter the term mammalian (animal) cell will occur frequently. One should bear in mind that much literature that applies to mammalian (animal) cells, also holds for hybridomas. Material that applies specifically to hybridomas is treated as such. Also it must be realized that there is not "one" hybridoma. Each and every hybridoma clone is different and has its own specific characteristics, made up of the myeloma and B-lymphocyte properties that it inherited during fusion. Nevertheless it is possible to make generalizations with respect to many properties in a useful way. The information that is reviewed in this chapter comes from a variety of studies on different cell lines but a general trend is observed that holds for most hybridomas.

2.2 Cell biology and metabolism

Each of the aspects of animal cell culture discussed below follows from some problems that originate mainly from biological properties (Leist *et al.*, 1990). Hybridomas are large eucaryotic cells (10-100 times the size of bacteria) without cell wall and with a high degree of differentiation. The genome is bigger and more complex than procaryotic genomes; above all it is less explored than that of microorganisms. Unstable genotypes may occur and therefore constant quality control of cell and product is required. The metabolism is complex and a high degree of internal control is achieved through intermediate metabolites. Besides regular nutrients that provide the energy and building material for cell replication and product synthesis,

hybridoma cells are dependent on growth factors and other supplements; it is still unsolved what the exact needs are. Unlike most microbial cells, mammalian cells strictly require both glutamine and another carbohydrate source like glucose for the aerobic catabolic processes that produce the energy containing molecules ATP and NAD(P)H. These molecules in turn may drive energy consuming reactions for biosynthesis of cellular material and the antibody product of interest (Glacken, 1988). Thus oxygen is a requirement for growth. Amino acids act primarily as precursors for protein synthesis. Major end products of glutamine and glucose catabolism are ammonium, lactate and carbon dioxide, all secreted into the culture medium. Carbon dioxide itself is an additional requirement for proper growth (Freshney, 1987). Butler and Jenkins (1989) discuss the nutritional requirements of several animal cells in culture. The effects of nutrient concentration may vary considerably between cell lines but generally requirements for hybridomas are similar. Many investigators have addressed the problem of nutrient effects on the metabolism of hybridoma cells. Most of the work is very empirical.

The effects of various levels of glucose and glutamine have been studied by Miller *et al.* (1989 a&b), Luan *et al.* (1987) and Wohlpert *et al.* (1990). Excess glucose is mostly converted to lactate via the glycolytic pathway. In fact, the yield of lactate on glucose has been shown to be as high as 93% (Ray *et al.*, 1989). Conversion to lactate yields only 2 mole ATP/mole glucose as compared to 36 mole ATP/mole glucose via the TCA cycle. Glucose is mainly used to produce reducing equivalents (NADPH) and the ribose units for nucleotides. Glutamine is therefore an important carbon and energy source, entering the TCA cycle as glutamate. It was demonstrated that the ratio of glucose to glutamine greatly affects cell growth and the formation of lactate and ammonia. Glacken *et al.* (1986) describe possible strategies for reduction of these waste products which may inhibit growth via nutrient control, in order to maximize cell and product yields.

Although several formulated media have been developed for sustenance of hybridoma cultures and mammalian cells in general, the lack of knowledge of exact growth requirements has forced investigators to supplement culture

medium with blood serum, normally of bovine origin. The function of the serum has been to provide micronutrients and growth factors which may not be present in the basal medium. Such media are described by Freshney (1987). Effects of different serum concentrations have been published by Ozturk and Palsson (1991a) and Dalili and Ollis (1989). Most cell lines need at least 2-10% serum to sustain growth, but can sometimes be adapted to grow at lower concentrations. Serum introduces a problem in purification of the antibody product from cell culture supernatants because of the high contaminating protein content. In addition the cost is high. Some investigators have reported toxic effects of serum use and a negative effect on antibody formation. As a result industrial production is preferably done using specifically developed serum-free media (Seaver, 1991).

2.3 Antibody synthesis

Analogous to the antibody formation by B-lymphocytes, the main function of the hybridoma is also antibody synthesis. Five classes of antibodies (immunoglobulin) exist: IgA, IgD, IgE, IgG and IgM (Roitt *et al.*, 1989; Eisen, 1990). Antibodies are large globular glycoprotein molecules with molecular weight varying from 150,000 to 900,000. The antibody molecule consists of two heavy and two light chains, both having constant and variable regions. It has two identical antigen binding sites (Fab), formed by symmetrical combination of the variable regions of the heavy and light chain. The end of the constant regions of the two heavy chains form one non-antigen binding site (Fc), that can interact with other parts of the immune system. The chains are synthesized separately by translation of mRNA corresponding to different parts of the genome that code for the variable and constant regions. Post-translational modification, including joining of the chains into a three dimensional structure, and glycosylation are an important part of completing the antibody molecule. Sugar molecules can make up 3-12 % of the molecular weight. The effectiveness of the Fc receptor binding and complement activation by IgG and

IgM antibody molecules are dependent on glycosylation in the heavy chain part (Goochee and Monica, 1990). In general, glycosylation contributes to the stability of the molecule and can be an important factor in bioactivity of the molecule.

The entire molecule is secreted by the hybridoma into the surrounding environment. The intracellular antibody protein content is negligible (Kelly, 1985; Gardner *et al.*, 1990). Antibody in culture medium may be susceptible to degradation by proteases released by dead cells.

Recently an alternative method has been described for antibody synthesis by recombinant *Escherichia coli* (Burton, 1991). The variable fragments of heavy and light chains were cloned into the organism, so only the antigen binding side would be made available through this method. In the future this so called "repertoire cloning" may prove especially useful for human antibody production, since hybridoma production can be undesirable and animal antibody may not always suffice for human applications.

2.4 Division of mammalian cells: cell cycle theory

The process of mammalian cell division consists of two sequential processes as described by Alberts *et al.* (1983): nuclear division (mitosis) and cytoplasmic division (cytokinesis). Before a cell can divide it must double its mass and duplicate all of its contents. Most of the work in preparing for division goes on during the growth phase of the cell cycle and is denoted interphase. One complete cycle of division and interphase consists in fact of four successive phases (Figure 1). After the M-phase, which consists of nuclear division and cytoplasmic division, the daughter cells begin interphase of a new cycle. Interphase starts with the G₁-phase, in which the cells, whose biosynthetic activities have been greatly slowed during mitosis, resume a high rate of biosynthesis. The S-phase begins when DNA synthesis starts and ends when DNA content of the nucleus has doubled and the chromosomes have replicated. The cell then enters the G₂-phase which ends when mitosis starts.

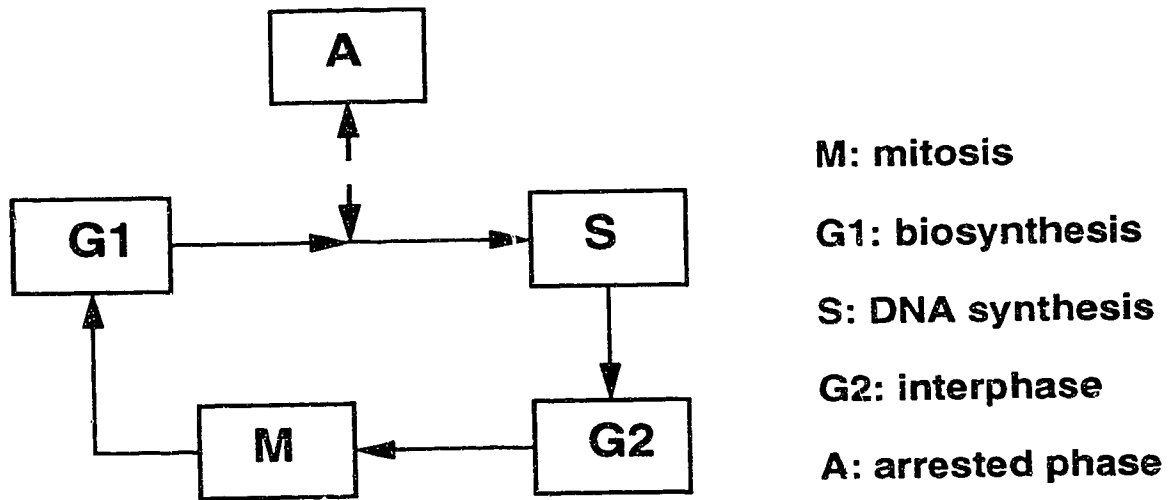

Figure 1. Four successive phases of the cell cycle. After M phase, which consists of nuclear division and cytoplasmic division, daughter cells begin a new cycle. A new cycle starts with gap 1 phase (G_1 phase), in which the cells, whose biosynthetic activities have been greatly slowed during mitosis, resume a high rate of biosynthesis. The S phase begins when DNA synthesis starts and ends when DNA content of nucleus has doubled. The cell then enters a second gap phase, G_2 , which ends when mitosis starts. Division will normally stop when the restriction point in late G_1 phase is reached, unless it is signaled to continue through another whole cycle. The cell stopping at late G_1 is called an arrested cell and symbolized by A.

Cell cycle times in higher eucaryotic cells vary widely (several hours to many years), with most variability being in the length of the G₁-phase. Cell division in culture can be slowed or stopped by limiting the supply of essential nutrients, by depriving the cells of essential protein growth factors, by adding low levels of protein synthesis inhibitors, or by allowing the cells to become overcrowded. In every instance, the cell cycle is arrested in the G₁-phase. This finding implies that once a cell has passed out of G₁ it is committed to complete the other phases. In fact experiments have shown that a point of no-return (restriction point) occurs in late G₁. After cells have passed this point, they will complete the rest of the cycle at the normal rate, regardless of external conditions.

Cell cycle analyses have been made much easier in recent years through the use of the fluorescence-activated cell analyzer/sorter ("Facs", "Flow Cytometer"). The Facs can determine the DNA content in each individual cell by using specific dyes that bind to DNA only and emit at a certain wavelength after excitation with a monochromatic light source. Thus the intensity of fluorescence by a single cell is a measure for the phase of the cell cycle that cells are in. By analyzing an entire cell population, the fraction of cells in any phase can be determined; as long as the population is asynchronous this reflects the phases that any individual cell traverses. Flow cytometric analysis has been performed on hybridoma cells by different investigators, with no particular objective other than testing the method and assessing cell cycle behavior (Schliermann *et al.*, 1987; Al-Rubeai *et al.*, 1991; Williams *et al.*, 1990; Dalili and Ollis, 1989). Flow cytometric methods are described by Shapiro (1985) who gives detailed information on equipment, capabilities and analyzing methods.

Biosynthesis occurs in the G₁-phase and therefore antibody synthesis would occur specifically in that phase (Suzuki and Ollis, 1989, 1990; Alberts *et al.*, 1983). For example, the rate of mouse myeloma light-chain synthesis was found to be 8 times as high in the late G₁-phase as in the late G₂-phase (Pryme *et al.*, 1976).

Griffiths and Riley (1985) describe the same principle of cell cycle theory, but

conclude that the concept of restriction is not totally accepted. A modification was proposed in which an initiator of DNA synthesis would be continuously synthesized and a threshold amount of this initiator is needed for DNA synthesis. If synthesis of the initiator is impaired, then cells become arrested after mitosis in G_1 .

2.5 Kinetics of growth and product formation

Hybridoma cultures have not been given as much attention as bacterial and yeast cultures with respect to mathematical description. One apparent reason is the lack of complete insight in the metabolism. Growth on a completely defined medium is necessary in order to be able to include the relevant nutrients and rate limiting processes into a model. Often however fetal bovine serum is included in the medium, which hinders quantitative assessment. Nevertheless, it is possible to come to a certain degree of understanding of kinetics of growth and product formation. A structured kinetic model for hybridoma growth can be useful in assessing the plausibility of proposed metabolic mechanisms and strategies for optimizing hybridoma viability and monoclonal antibody production.

Generally models are of the same form as those developed for microorganisms and include Monod-type terms to relate specific growth rate (μ) to substrate concentration (S) (see for example Roels, 1983):

$$\mu = \mu_{\max} \frac{S}{S + K_s} \quad (1)$$

Growth of biomass (X) in batch culture can be described by:

$$\frac{dX}{dt} = \mu X \quad (2)$$

The specific growth rate is however not constant. The usual way to describe batch growth (Harbour *et al.*, 1987) is in a number of growth phases during the

batch:

1. lag phase, or zero net growth
2. accelerating phase
3. exponential growth phase: $\mu = \mu_{max}$
4. stationary phase, or zero net growth
5. decreasing phase and death

Often kinetic studies are therefore performed in a continuous culture system in which concentrations of biomass, nutrients and products are constant at steady state by diluting the culture at dilution rate $D (= \mu)$. In this case there is a rate limiting substrate. Similar expressions can be derived for substrate utilization and product formation.

Batt and Kompola (1989) presented a structured kinetic model that describes the dynamics of hybridoma growth and the synthesis of antibody as well as metabolic waste products in suspension. The underlying assumption is that cell mass may be divided into four intracellular metabolic pools: amino acids, nucleotides, protein and lipids. These are derived from extracellular substrates: glucose, glutamine and amino acids. The secreted products are lactate, ammonia and monoclonal antibody. Monod type of rate expressions were used. The model consists of twelve differential equations and variables and an additional fifty-two parameters. It is capable of describing experimental results obtained by Miller *et al.* (1986) in continuous culture with regard to cell mass, glucose and glutamine uptake rates, antibody production, and ammonia and lactate formation rates. The elaborate form makes the model impractical for general use.

Formation of dead cells during growth is more significant than in microbial cultures and cannot be ignored. An interesting observation was made by Glacken *et al.* (1989); they found that the specific death rate of a culture was a reciprocal exponential function of the observed growth rate for both continuous and batch cultivation of hybridomas, and this result was confirmed for three different hybridoma lines.

With respect to product formation, typical kinetic responses have been characterized into three major types (Bailey and Ollis, 1986):

1. growth associated product formation

$$\frac{dP}{dt} = \alpha \frac{dX}{dt} \quad (3)$$

2. non-growth associated product formation

$$\frac{dP}{dt} = \beta X \quad (4)$$

3. combined growth/non-growth associated product formation

$$\frac{dP}{dt} = \alpha \frac{dX}{dt} + \beta X \quad (5)$$

Harbour *et al.* (1987) supports use of these models but concludes that in the case of antibody formation, some complexity could exist because of possible antibody degradation and because of difficulties in assessing which part of the biomass is actually responsible for product formation. Clearly, these models are highly unstructured and do not capture the nature of antibody synthesis, but relate product formation to overall cell growth and yield. Degradation has been accounted for by Gardner *et al.* (1990), who included a first order degradation term for antibody.

Harbour *et al.* (1987) studied a hybridoma line in continuous culture and found that antibody production was growth associated up to a critical specific growth rate, after which it was non-growth associated. It was suggested that antibody production places a significant anabolic load on a hybridoma and that this load reaches a maximum level at a critical growth rate less than the maximum specific growth rate. Consequently a saturated profile exists past this critical specific growth rate analogous to the bottleneck model for glucose oxidation by *Saccharomyces cerevisiae* (Sonnleiter and Kappeli, 1986). Miller *et al.* (1986), Dean *et al.* (1988), and Reuveny *et al.* (1986b) all report nearly two-fold

increased specific antibody production rate (q , expressed as pg/cell/h) at slower growth. Ramirez and Mutharasan (1990b) found a gradual decrease in specific antibody production rate from 0.20 to 0.05 pg/cell/h as the specific growth rate increased from 0.008 to 0.040 h⁻¹. Glacken *et al.* (1989) reported a constant specific antibody production rate of circa 1.2-2.2 pg/cell/h above a critical specific growth rate, whereas Birch *et al.* (1984) suggest that antibody formation is non-growth associated. Ray *et al.* (1989) observed that total production of antibody went through a maximum of 2.5 pg/cell/h at a specific growth rate of 0.020 h⁻¹. Also specific death rate was reported to be higher at lower growth rates (below 0.020 h⁻¹) in accordance with the findings of Glacken *et al.* (1989). They suggested that the rate of death for arrested and G₁ cells was higher than for cells in S phase. Consequently at lower specific growth rates more death occurs. The same authors found a decrease in specific antibody production rate from 2.5 to 1.5 pg/cell/h with an increase in specific growth rate from 0.020 to 0.040 h⁻¹. This trend would be in accordance with observations that biosynthesis takes place in the G₁ phase of the cell cycle, in which the cells spend more time at lower specific growth rates. Such dependency is in contrast to total cellular protein levels, which increase continuously through the cell cycle as observed by Lloyd *et al.* (1982).

Suzuki and Ollis (1989) proposed a cell-cycle model for antibody production kinetics, which relates the fraction of cells in each phase of the cycle to specific growth rate and specific antibody production rate. They applied the model to a continuous culture using data of Miller *et al.* (1986). They conclude that the model works based on three assumptions:

1. the cell-cycle time increases as μ decreases
2. at low μ , the total cell cycle time attains a constant maximum
3. the fraction of cells arrested in G₁ increases as μ decreases

Hence, the authors conclude that cells must become arrested in order to produce antibody. Results of this cell-cycle model, fitted to earlier reported data, strongly suggest that application of methods to arrest cells while retaining

a high viability and high cell concentration is likely to improve specific antibody productivity. Such methods include (Pryme *et al.*, 1976; Enger and Tobey, 1972):

- isoleucine deprivation
- serum depletion
- reaching of stationary state after exponential growth
- inhibition by drugs
- oxygen supply limitation

Clearly the protein synthesis machinery must be kept intact when cells are arrested.

Suzuki and Ollis (1990) carried out experiments in which growth was slowed by adding a DNA synthesis inhibitor. The addition of thymidine or hydroxyurea resulted in an increased specific antibody production rate at lower specific growth rates ("negatively growth associated") as can be seen in Figure 2. These inhibitors did not affect antibody synthesis. Other inhibitors that influenced growth through restriction of protein elongation or rRNA synthesis (cycloheximide and actinomycin respectively) produced non-growth or positive growth associated responses: slower growth was never beneficial. In addition the total antibody production of the thymidine treated culture was higher than of untreated cultures (Figure 3a and 3b).

Typical yield values for cell mass and monoclonal antibody in batch culture from several sources are presented in Table 1. An extensive study has been carried out by Lambert *et al.* (1987), who reported results for 35 cell lines with monoclonal antibody yields ranging from 40 - 500 mg/L.

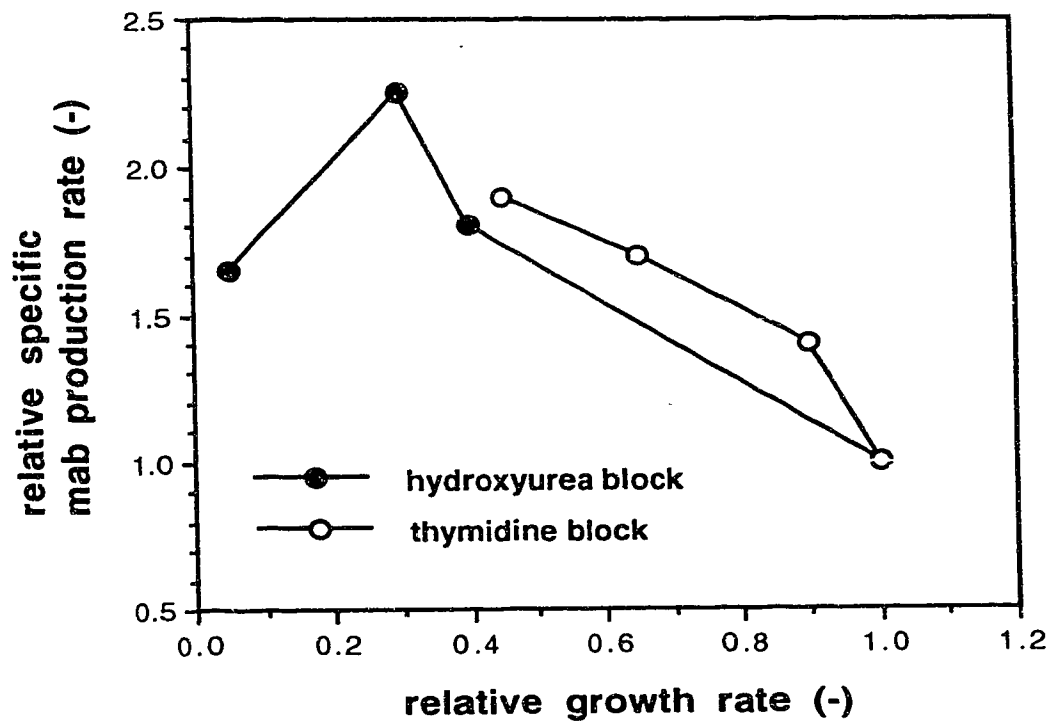

Figure 2. Specific antibody production rate of cultures treated to inhibit growth but not mab synthesis: cultures were either treated with hydroxyurea or thymidine (Suzuki and Ollis, 1990).

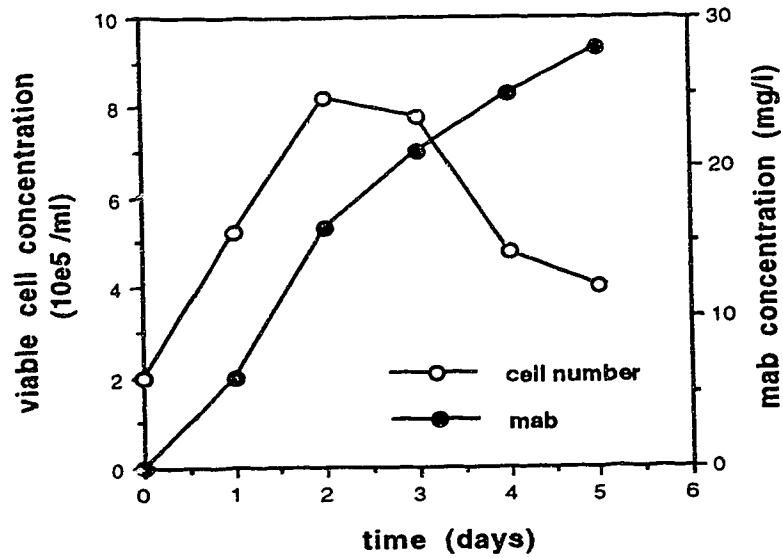

Figure 3a. Monoclonal antibody and cell concentration through a batch of inhibitor-free culture (Suzuki and Ollis, 1990).

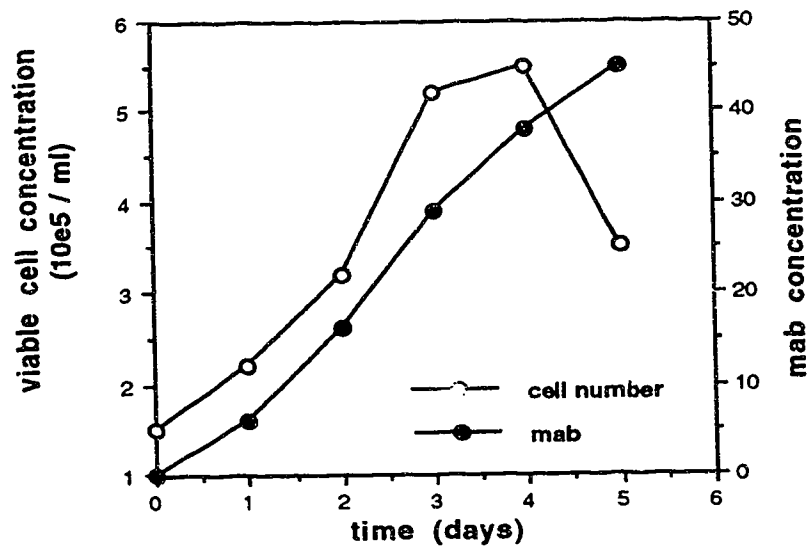

Figure 3b. Monoclonal antibody and cell concentration through a batch of growth-inhibited culture (Suzuki and Ollis, 1990).

Table 1. Typical cell mass and monoclonal antibody yield in batch culture

Reference	viable cell number (10 ⁶ /mL)	mab (mg/L)	scale of operation
Ozturk and Palsson (1991)	2	30	spinner, 50 mL
Wohlpart <i>et al.</i> (1990)	1.2	10	
Luan <i>et al.</i> (1987)	1.5	40	T-flask
Ray <i>et al.</i> (1989)	2	50-100	fermenter, 1 L
Sureshkumar and Mutharasan (1991)	3	50	T-flask
Reuveny <i>et al.</i> (1986a)	3	220	T-flask; fermenter, 1 L
Reuveny <i>et al.</i> (1986b)	1.3	120	spinner, 100 mL
Birch <i>et al.</i> (1985)	2	150	airlift, 1000 L
Lambert <i>et al.</i> (1987)	3.5	300	airlift, 100 L
Suzuki and Ollis (1990)	0.5-0.8	20-45	T-flask
Dalili and Ollis (1990)	0.8-2.0	5-20	T-flask
Dalili and Ollis (1989)	0.9	50	T-flask
Ramirez and Mutharasan (1990)	2.5-3.5	25	fermenter, 1 L

2.6 Parameters affecting cell growth and antibody production

2.6.1 Shear

Hybridomas are sensitive to shear effects in culture due to lack of a protective cell wall and because of their relative large size. Physical damage occurs relatively easily (Croughan *et al.*, 1989). Several mechanisms have been proposed for causing cell death and the problem of mechanical agitation in cultures has been addressed by many investigators (Tramper and Vlak, 1988; Gardner *et al.*, 1990; Ramirez and Mutharasan, 1990a; Petersen *et al.*, 1990; Oh *et al.*, 1989). Often the problem is treated in combination with air sparging for aeration of the culture (Oh *et al.*, 1989; Handa-Corrigan *et al.*, 1989; Gardner *et al.*, 1990). General belief is that collapsing of bubbles at the gas-liquid interface is the most likely mechanism for damage. However, shear stress by agitation at higher rates also has severe negative effects on viability and respiratory activity of cells. (Abu-Reesh and Kargi, 1989; Augenstein *et al.*, 1971). Agitation and sparging becomes especially a problem on larger scales and at higher cell densities, when mixing is necessary for a uniform distribution of the culture, and oxygen transfer becomes problematic without agitation or sparging. It has been demonstrated by Handa-Corrigan *et al.* (1989), Gardner *et al.* (1990) and Ramirez and Mutharasan (1990), that addition of serum can have a protective effect. Also the additive Pluronic F-68™ has been widely used as a protective agent.

Quantification and modeling of hydrodynamic forces and shear stress effects in cell cultures has received some attention. More information on this topic can be found in reviews by Tramper and Vlak (1988) and Prokop and Rozenberg (1989).

2.6.2 Oxygen requirements

Many investigators have been concerned with the problem of oxygen transfer in mammalian cell culture. Oxygen transfer through agitation and

aeration (sparging) has an adverse effect on hybridomas. Hence, oxygen supply is a major issue in scale up. Oxygen requirements for most cells fall in the range of 0.05 - 0.5 mmole O₂/10⁹ cells/h (maximum uptake rates) as reported by Prokop and Rozenberg (1989), Merten *et al.* (1987), and Birch *et al.* (1984). A typical reported value is between 0.2 and 0.4 mmole O₂/10⁹ cells/h (Boraston *et al.*, 1984; Fleischaker and Sinskey, 1981). This demand is one to two orders of magnitude lower than for bacterial and yeast cells, due to slower growth.

The effects of dissolved oxygen concentration on hybridoma growth and metabolism have been studied by Miller *et al.* (1987). Cell concentration decreases at lower dissolved oxygen because of incomplete glutamine oxidation. The optimum for antibody synthesis was found to be 50% of air saturation, whereas the optimum for cell viability was close to 1%. In contrast, Reuveny *et al.* (1986a) showed optimal cell growth at an oxygen level of 60%, whereas more antibody was produced at 25%. A similar profile was observed by Ozturk and Palsson (1990). Higher oxygen levels appeared to be toxic. Boraston *et al.* (1984) reported unaffected growth and antibody production over the range 8-100% dissolved oxygen. Type of cell line and differences in growth rate may explain this range.

Mano *et al.* (1990) compare several methods of oxygen supply for shear sensitive organisms, including free surface aeration with and without agitation, sparging with agitation, porous tubing and perfluorochemicals. Mass transfer expressions were derived for each case. Oxygen transfer data for agitated and sparged cultures are also given by Spier and Griffiths (1984). It is obvious that for cell densities of 10⁶ cells/mL (common value) unagitated, unsparged cultures can quickly become oxygen limited due to the poor solubility of air (oxygen) in water.

2.6.3 Waste products, pH and osmolarity

Most hybridomas are cultured within a pH range of 6.9 - 7.4 (Harbour *et al.*, 1987). Culture buffering is usually achieved by a bicarbonate buffer,

which is not very efficient above pH=7 in cases where lactate and carbon dioxide are produced. Due to the low dissociation constant of HCO_3^- (pKa=6.1 at 37°C) it reassociates readily with cations in the medium, thus leaving the medium acidic. The pH range in which one particular hybridoma functions normally is narrower than the above given range, but depends on the cell line. Other options for pH control are the addition of other buffers like HEPES (N-2-hydroxyethylpiperazine-N'-2-ethanesulfonic acid; pKa=7.3 at 37°) or addition of sodium hydroxide, and if necessary hydrochloric acid. Local high concentrations are, however, very toxic (Harbour *et al.*, 1989).

Ammonia is released upon conversion of glutamine and is toxic to cells (Reuveny *et al.*, 1987). The toxicity of ammonia has been related to culture pH by Doyle and Butler (1990). Inhibition of growth was demonstrated upon reduction of pH by one unit from the optimum. The pH optimum for growth shifted to lower pH as ammonia accumulates in the culture. Ammonia rather than the ammonium ion contributes to toxicity.

The toxic effect of lactate is thought to be solely due to pH decrease (Reuveny *et al.*, 1987; Glacken *et al.*, 1983) and could thus be neutralized by proper pH control.

Osmolarity of hybridoma culture media must be within a narrow range. The normal range for medium is 290-320 mOsm, which mimics blood serum. This restriction is caused by lack of cell wall. Ozturk and Palsson (1991b) have extensively studied the effect of osmolarity and found that increased stress levels may in some cases result in higher specific antibody production rate, but that growth is negatively affected. Addition of pH control agents may raise osmotic pressure to levels that inhibit growth.

2.6.4 Temperature

The effects that temperature may have on growth and antibody production have barely been studied. Often the optimal temperature is assumed to be 37°C. Yet it is a parameter that influences metabolism significantly

because all enzymatic activity is strongly dependent on temperature. Miller *et al.* (1988) already realized that environmental conditions non-optimal for growth of mammalian cells, may in some cases lead to higher per cell product formation.

All types of procaryotic and eucaryotic cells possess proteins whose expression is enhanced in response to certain types of stress. Passini and Gouchee (1989) discuss several types of stress related responses. In mammalian cells, two principle subsets of these stress proteins have been identified: the heat-shock proteins (HSP), and the glucose-regulated proteins. These proteins are induced by elevated temperature and glucose deprivation respectively, but also by a number of other stresses including non-optimal pH and hyperosmolarity. The authors confirmed the presence of such proteins in hybridomas after fusion from the mother cells. Miller (1989) reviews the function of heat-shock proteins, which may be involved in induction of thermotolerance in mammalian cells and a response of the cell to heat shock may be mediated by these proteins. Heat-shock proteins may have an immunological counterpart which is thought to be involved in the assembly of proteins. Heat-shock proteins may be induced by other factors, including heavy metals, organics and oxidants (Schlesinger, 1990).

For bacterial systems, several recombinant proteins have been expressed using stress-responsive promoters. Khosla *et al.* (1990) describe the use of an oxygen dependent promoter in *Escherichia coli* to express a protein product.

From the *Penicillium* fermentation it is well known that growth is optimal at 30°C, whereas the optimal temperature for penicillin synthesis is 15°C (Constantidines, 1970). Thus an optimal control policy was developed which has resulted in circa 20% improvement of yield.

An optimal temperature control policy was developed for a two-stage recombinant *Escherichia coli* fermentation, in which transcription of mRNA is induced by inactivation of a heat-sensitive repressor molecule at temperatures above 38°C (Hortascu and Ryu, 1990). The optimum for growth was 35°C (stage 1). Maximum protein expression would occur with a change in temperature from 40°C to 40.5°C in stage two. A model was used to describe product

formation as a function of both temperature and time. The optimal temperature profile was subsequently determined using the maximum-principle (see Bailey and Ollis, 1986). It is clear that this change in temperature would be too small for control on larger fermentation scales.

For a batch culture of the plant cell *Catharanthus roseus* a model for growth and product formation (intracellular alkaloid) with respect to temperature and time was developed by Bailey and Nicholson (1990). Product synthesis was maximal at 21.8°C, whereas growth was optimal at 31°C. A single temperature shift was shown to be optimal and the time period for each condition was calculated using the maximum-principle.

Merten *et al.* (1984) determined for a hybridoma line that a lower cultivation temperature stabilized the overall antibody production rate over a total culture period of 80 days, whereas cultivation at the temperature optimal for growth (37°C) resulted in 80% production loss over the same time period. Reduction of temperature decreased growth rate and thus the number of mitoses where loss of chromosome may occur. Hence, temperature was used as a means of slowing growth in order to stabilize an unstable hybridoma line.

The effects of temperature in the range of 31 - 39°C were studied in stirred cultures by Al-Rubeai *et al.* (1990). The sensitivity of cells to hydrodynamic forces increased with decreasing incubation temperatures. In contrast, cells grown at a higher temperature than optimal for growth, showed a much smaller change in sensitivity to high force conditions: Although higher yields were obtained at 37 and 34°C, rapid cell death occurred after the maximum had been reached. In contrast, at 39°C, cell yield is 40% of the maximum, but no rapid change was observed after the maximum had been reached. Metabolic activity at sub-optimal temperatures is considerably lower, enabling cells to survive longer. Specific antibody production rate was lower at both higher and lower temperatures than the optimum of 37°C.

Reuveny *et al.* (1986a) demonstrated that 37°C was optimal for total antibody concentration and specific antibody production rate, but cell death occurred within one day after maximum cell density was reached; whereas cells grown at 34°C remained viable for 4 days.

Sureshkumar and Mutharasan (1991) recently demonstrated optimal growth at 33°C in a studied range of 29 to 39°C. Final antibody concentration was optimal at 35°C, but specific antibody production rate was highest at 39°C. These results indicate that there is a need for optimizing temperature with respect to cell growth and antibody production.

So far no data are available that correlate cell-cycle events in mammalian cells with temperature. Temperature has not been proposed as a means to manipulate growth rate, thus changing the length of the G₁-phase. For hybridoma cultures no optimal temperature strategies have been developed, mainly because of lack of data on temperature effects. Thus a need for such data is recognized.

2.7 Production systems

Several bioreactor systems, other than batch suspension, have been used for the propagation of hybridomas. The general distinction is between homogeneous and heterogeneous systems (Handa-Corrigan, 1988).

Homogeneous systems are characterized by low cell densities and low product concentrations, but scale up is relatively easy. Such systems include stirred tanks and airlift fermenters. Advantages of batch suspension cultures are the simplicity, reliability, easy aseptic operation, sampling and monitoring. However, no sophisticated control is possible. Hence fed-batch systems for nutrient control were developed (Reuveny *et al.*, 1986b; Prokop and Rozenberg, 1989), resulting in higher monoclonal antibody yields. Continuous culture prevents waste product build up in addition to providing nutrient control.

Heterogeneous systems make use of some immobilization or retention technique for cell mass, thus resulting in higher cell densities and higher product concentrations. Often yields one or two orders of magnitude higher than for batch suspension cultures are possible. The main problems are the difficulty in monitoring cell density and viability, diffusional limitations with regard to nutrients and oxygen, as well as local concentration differences. These

are barriers for scale up and such processes have not emerged from the lab-scale. Table 2 summarizes the performance of several bioreactor systems. General bioreactor design for several systems is outlined by Prokop and Rozenberg (1989) and Pollard and Khosrovi (1978). Aspects of scale-up are covered by Merten (1987), who addresses many different systems, and Bliem and Katinger (1988a,b).

Table 2. Bioreactor system characteristics for hybridoma cultivation (values reported are maximum attainable)

	cell density (10 ⁶ cells/mL)	mab (mg/L)	commercial scale (L)	reference
Homogeneous				
batch				
airlift	0.5-3	50-500	1000	Birch <i>et al.</i> (1985)
stirred tank	0.5-3	50-500	300	Lebherz (1987)
continuous				
perfusion	10-30	600	lab	Feder and Tolbert (1983)
Heterogeneous				
hollow fiber	100	1000	lab	Wedel (1987)
ceramic matrix	100	1000	lab	Putnam (1987)
microcapsules	100	1000	lab	Posillico <i>et al.</i> (1987)

CHAPTER 3

EXPERIMENTAL METHODS AND MATERIALS

3.1 Cell line and growth conditions

Throughout this study the rat-mouse-mouse hybridoma line S4B6, kindly provided by Dr. T.R. Mosmann (Department of Immunology, University of Alberta, Canada), was used. This hybridoma produces an IgG_{2a} monoclonal antibody (Mosmann *et al.*, 1986), reactive with mouse interleukin-2 (IL2).

Unless otherwise stated, cells were grown in RPMI-1640 medium containing phenol red (Sigma), supplemented with 0.05mM 2-mercaptoethanol (Sigma) and 8% Fetal Bovine Serum (Jackson). All media were filter sterilized using a 0.22 micron filter (Millipore; Nalgene). Extreme care was taken with regard to aseptic operation, because hybridomas grow slowly and are easily overtaken by other microorganisms, if contaminated. Non-agitated and spinner flask cultures were incubated in a humidified incubator at 37°C, and purged with 6% CO₂ in air. Prior to inoculation medium was allowed to equilibrate with regard to pH and temperature.

3.1.1 Non-agitated cultures

Non-agitated cultures of 40 mL were grown in petri dishes (Falcon 1005) up to a cell density of circa 2×10^5 cells/mL using a 5% inoculum. In this way the cells were repeatedly transferred into fresh medium and kept in log or late log phase. After a period of circa 2 months, previously frozen fresh clones were thawed out and used to start new cultures. Periodically samples were taken aseptically and cells were counted using a hemocytometer as described

below. Culture samples were centrifuged at 700 g for 8 minutes and the supernatants were stored at -20°C for later analysis.

Non-agitated cultures of 40 mL were tested on a fortified medium as described by Jo *et al.* (1990). Standard RPMI was supplemented with 5X amino acids, 5X vitamins, 5X glutamine, 5X glucose and 5X glutathione. In the original experiments the increase in osmolarity was compensated for by reducing the NaCl concentration by 33%. In the experiments on fortified medium carried out in this study all salts were reduced by 16% and 33% in order to achieve similar results. A description of the media can be found in Appendix 1.

3.1.2 Agitated spinner cultures

Agitated cultures of 200 mL were carried out using 250 mL spinner flasks (Corning). All flasks were thoroughly cleaned and autoclaved for 30 minutes at 121°C. New glassware was treated for cell culture use as described by Freshney (1987). Cultures were started using a 15% inoculum (by volume) of non-agitated cultures in late log phase. Agitation was 60 rpm and gas exchange with the environment was made possible through two loose caps on the sidearms of the spinner flask.

3.1.3 Agitated fermenter cultures

Agitated cultures of 2000 mL were carried out in a 3.5 L fermenter (Chemap AG, type CF3000) equipped with a flat blade marine impeller at 37±0.1°C and 60 rpm. The head space of the fermenter was purged with a mixture of air and 6% CO₂, controlled by a mass flow controller at 2 L/min. Initially the entire fermenter was cleaned and autoclaved in situ with steam supplied from the main boiler in the building, but later no external steam was used to sterilize the fermenter as it was suspected that the steam condensate

contained elements that had an adverse effect on cell growth. The fermenter itself was filled with water obtained by reverse osmosis and autoclaved in situ for 25 minutes at 121°C by steam heating of the jacket of the vessel. The air inlet filter was sterilized separately and connected aseptically with the fermenter. The water condensate in the vessel was aseptically drained and filter sterilized medium was pumped into the vessel using a Masterflex peristaltic pump (Cole Parmer) and sterile silicone tubing (Masterflex, size 16). After adjusting airflow rate and CO₂ content, the fermenter was left overnight to equilibrate temperature and pH. Calibration of the pH probe (Ingold) was done before sterilizing and the pH-value of an aseptically removed sample was checked with a separate pH meter. The dissolved oxygen probe (Ingold) was calibrated in situ with nitrogen to 0% and in medium after equilibration with the overhead gases to 100%. Inoculum was prepared in a 250 mL spinner flask in duplicate (see above) and the fermenter was inoculated at 10% by volume with a culture in late log phase. Samples were periodically taken and analyzed for viable cell number. The remainder of a sample was centrifuged (700g, 8 min) and the supernatant was stored at -20°C.

Temperature, pH and dissolved oxygen were monitored on-line. The CO₂ content of the exhaust gas was determined using a mass-spectrometer (Dycor) and monitored on-line.

3.2 Analytical methods

3.2.1 Viable cell number

Cells were counted using a hemocytometer (Neubauer improved). A sample was taken and diluted 1:1 with 0.2% trypan blue solution, which leaves viable cells unstained, whereas dead cells and cell debris take up a blue color. The cells in all nine squares of one chamber were counted in order to obtain an accurate count. Normally between 20 and 200 viable cells were counted in this way, accounting for approximately 1×10^4 to 5×10^5 cells/mL. Although non-

viable cell counts have been reported in the literature using the trypan blue exclusion method, this method is not recommended, since dead cells disintegrate and the cell debris also takes up the blue dye. Hence, inaccurate counts for dead cells are obtained. Viable cell counts were performed at least in duplicate.

3.2.2 Monoclonal antibody

The monoclonal antibody content of culture supernatants was measured by two different methods. Firstly, an enzyme linked immunosorbent assay (ELISA) was developed, which could be used for rapid quantification of antibody levels by using a standard. Secondly the MTT bioassay was used for testing bioactivity of the secreted antibody, as described by Mosmann and Fong (1989).

3.2.2.1 Enzyme Linked Immunosorbent Assay (ELISA)

Polystyrene 96 well plates (Falcon, round bottom) were coated with polyclonal Goat-anti-Rat (G α R) antibody, reacting with heavy chains on rat IgG and with light chains common to most rat immunoglobulins (Jackson), but not with other proteins. After blocking the non occupied sites with Bovine Serum Albumin and washing with Phosphate Buffered Saline Tween (PBST) the samples were loaded resulting in S4B6 antibody binding to the G α R coat. Samples were titered threefold over 6 wells starting at a 1:10 dilution of supernatant in the first well. On every plate a standard was loaded which was titered threefold over 6 wells starting at 100 ng/mL purified antibody for the first well and ending at 0.4 ng/mL in the last well. Samples were loaded in either duplicate or triplicate. After washing a secondary layer of biotinylated G α R was added, sandwiching the S4B6 antibody. Streptavidin horseradish peroxidase was added as conjugate in order to catalyze the colorimetric reaction of the chromogen ABTS from colorless substrate to green oxidation

product. Optical density of the wells was read at a test wavelength of 405 nm and a reference wavelength of 490 nm in an ELISA-plate reader (Molecular Devices) and the data were stored in a Macintosh personal computer. Concentrations of coat, secondary antibody and conjugate were optimized resulting in a good working procedure: coat concentration was 1 µg/mL, secondary antibody concentration 0.05 µg/mL, and conjugate concentration 1 µL/mL.

Unknown antibody concentration was quantified using an internal standard of purified GL117 antibody, kindly provided by Dr. T.R. Mosmann (Department of Immunology, University of Alberta, Canada). This monoclonal antibody is an IgG_{2a} antibody and gives a similar reaction with GαR as the S4B6 antibody. Purified S4B6 at exactly known concentration was not available but purified S4B6 obtained from ascites at roughly known concentration confirmed the similar quantitative reaction of both antibodies. Optical density of the standard versus concentration was plotted to yield a straight line as a standard curve from which sample mab concentrations could be determined.

3.2.2.2 MTT Bioassay

The ELISA method measures antigenically active protein, but not necessarily biological activity. For this purpose a bioassay was used as developed by Mosmann and Fong (1989). The MTT assay tests the blocking activity of the S4B6 antibody. The basis of the assay is formed by the potential proliferation of HT2 cells in the presence of IL2 or IL4 and their capability of metabolizing the tetrazolium salt 3-(4,5-dimethylthiazol-2-yl)-2,5-diphenyltetrazoliumbromide (MTT) to the colored formazan product by mitochondrial succinic dehydrogenase activity in viable cells. Thus color change by actively growing cells is an indication of cell viability, which is dependent on the presence of IL2. Although the assay has been used to determine IL2 activity, similarly it may be used to measure activity of monoclonal antibody against the cytokine. In order to do so, the HT2 cells were provided with a constant amount of IL2, resulting in approximately 50% of maximum cell

growth and the supernatant samples containing the S4B6 to be tested was added; samples were titered eightfold or sixteenfold with doubling dilution. If an internal standard is available, the concentration of S4B6 can be exactly assessed, but in this case only qualitative comparisons were made between different samples.

3.3 Flow Cytometry

Flow cytometric analysis was carried out using a Becton-Dickinson FACScan fitted with an argon laser operating at 488 nm. DNA content of individual cells in a population was determined by using a selective staining procedure with the fluorescent molecule propidium iodide (PI) which binds to DNA and emits in red after excitation at 488 nm. Samples were fixed with 70% ethanol and treated with RNase (Boehringer Mannheim) to prevent false RNA readings. Fluorescence intensity is proportional to the DNA content of a single cell. Forward and side scatter measurement allowed to distinguish between debris, dead cell material and intact cells. A histogram was built up of 20,000 cells for which the individual fluorescence was determined. The fraction of cells in G₁, G₂+M and S phase of the cell cycle was assessed by fitting the histogram to single Gaussian curves for G₁ and G₂+M phase peaks, and multiple Gaussian curves to the S phase region. A software program by Becton-Dickinson was used to do the calculation.

CHAPTER 4

RESULTS AND DISCUSSION

4.1 Growth and antibody production in batch suspension culture

4.1.1 Cell growth in non-agitated cultures

Cultures were grown in unstirred 40 mL dishes at 37°C , using standard medium as described in Chapter 3. Typical growth and monoclonal antibody production profile is shown in Figure 4. A total of 5 data sets at these conditions were obtained in order to get an idea of reproducibility. All figures of repeat experiments are compiled in Appendix 2. Quoted cell numbers are viable cells only, as determined by the trypan blue exclusion method. The average cell number obtained from 5 runs was $4.68 \pm 0.66 \times 10^5$ cells/mL, within the range $3.8 - 5.4 \times 10^5$ cells/mL. The viability of such cultures was about 90%, but declined rapidly after the maximum cell density had been reached. Estimates of viability were approximate, because trypan blue exclusion is inaccurate for determination of non-viable cells. Average monoclonal antibody yield was 28.7 ± 3.2 mg/L, varying from 27.0 to 32.0 mg/L. No further increase in antibody yield was observed after the last shown sample time and total cell death was observed. The S4B6 hybridoma was said to be a low producer (Dr. T.R. Mosmann, personal communication) and the obtained cell number was much lower than reported values for other hybridomas in similar medium (Table 1). The monoclonal antibody yield was at the lower end of the reported range. Several reasons for low production were considered and are discussed below.

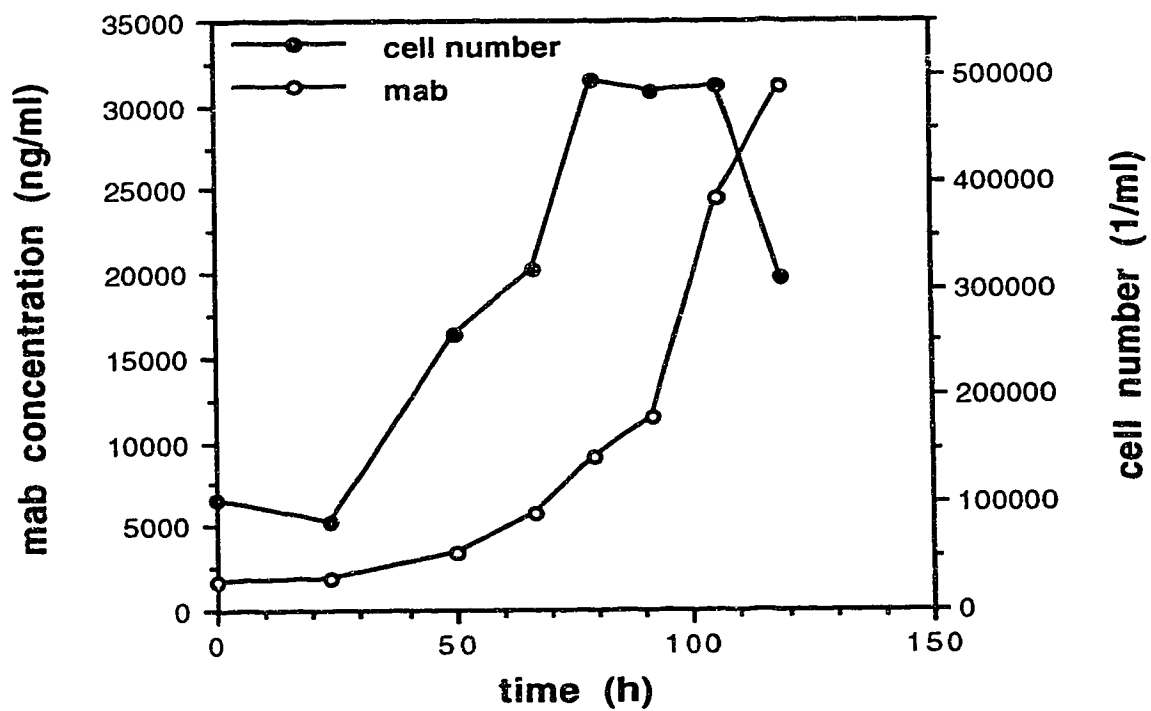

Figure 4. Viable cell density and monoclonal antibody concentration during non-agitated batch culture at 37°C.

4.1.2 Effect of medium enrichment

One possibility for low cell yield was that the initial medium was limiting in one or more components. Since an 8% serum concentration was used, it was not considered feasible to determine which component could be rate limiting. Instead two different approaches were followed to examine the effect of medium enrichment, increasing all component concentrations.

A repeated fed batch was simulated by collecting the supernatants of cultures that had reached maximum cell density and resuspending the centrifuged cell mass in 40 mL of fresh medium after 24 hours. This transfer was carried out three times in duplicate. The results are summarized in Table 3. An increase in cell density of $1 - 2 \times 10^5$ cells/mL can be seen, but also a great fraction of dead cells accumulated in the culture, accounting for as much as approximately 50% after the third transfer. Antibody levels were not measured. The pH dropped from 7.3 to 6.8 within 24 hours, indicating acid production and an inefficient use of substrate by conversion to lactate.

A second experiment involved the fortification of the entire medium as described in Chapter 3. Duplicate dishes were set up including a control. The results are given in Figure 5. Surprisingly the standard medium yields the best growth; a cell density of 5.3×10^5 cells/mL was obtained, which was in the expected range. Reduction of salts by 16 and 33% yielded 2.4×10^5 cells/mL and 1.6×10^5 cells/mL respectively. Simple addition of the extra components at 5X concentration without correcting the salt balance resulted in no growth at all.

The results of these nutrient addition experiments indicate that a more sophisticated and rigorous strategy must be developed for enhancement of growth of the S4B6 hybridoma; simple addition of components is not sufficient.

Table 3. Effect of repeated fed-batch on viable cell number and approximate viability. Analysis was done 24 h after each transfer.

culture	1	2	3
Transfer #1:			
cell number ($10^5/\text{mL}$)	6.6	6.2	6.9
viability (%)	70	70	65
Transfer #2:			
cell number ($10^5/\text{mL}$)	6.5	5.8	6.0
viability (%)	50	50	50
Transfer #3:			
cell number ($10^5/\text{mL}$)	7.0	5.8	7.3
viability (%)	50	50	50

4.1.3 Effect of pH

Under standard growth conditions the pH of cultures would drop from 7.3 to 6.7. Thus it was considered that the acidic pH could be inhibitory. HEPES supplementation of the medium at 25 mM was carried out to improve buffering capacity of the medium. Although better control of the pH was achieved, no improvement in final cell concentration was observed (Table 4). Schmid *et al.* (1990) have reported that by maintaining pH at 7.2 through HEPES buffering and NaOH addition, both growth and antibody production were reduced, whereas a steady drop to 6.7 enhanced growth and product formation. Similar results were also obtained by Harbour *et al.* (1989). In contrast, Miller *et al.* (1988) observed that growth was optimal at pH 7.1-7.2,

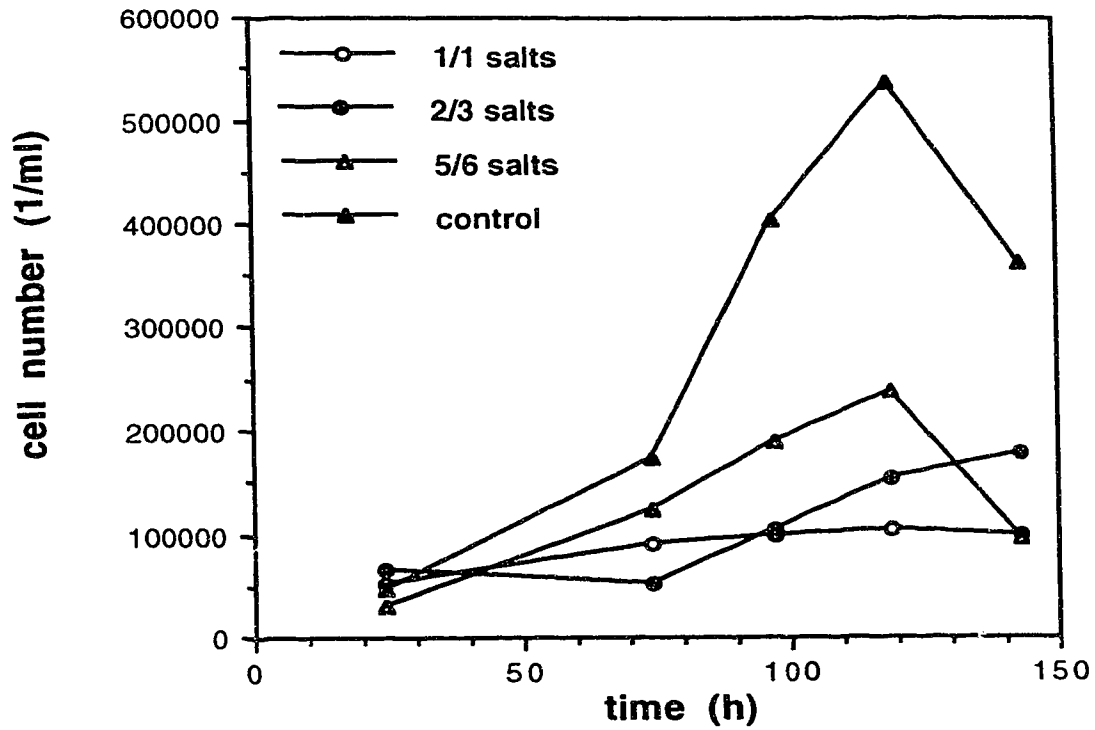

Figure 5. Viable cell density in non-agitated batch culture, using fortified medium. 5X amino acids, vitamins, glutamine, glucose and glutathione. Salt reduction as given.

but antibody production was higher at lower pH. The results in Table 4 indicate that pH change between 7.4 and 6.8 does not adversely affect growth of the S4B6 hybridoma.

Table 4. The effect of HEPES buffer supplementation (25 mM) on maximal cell density and pH buffering.

culture	pH	start (t=J h)	pH	end (t=96 h)
		cell number (10^5 /mL)		cell number (10^5 /mL)
HEPES	7.4	1.0	7.0	5.4
HEPES	7.4	1.1	7.0	5.6
control	7.4	1.2	6.7	5.0
control	7.4	1.0	6.7	5.4

4.1.4 Oxygen limitation

The possibility of oxygen limitation in the culture was evaluated, because in static cultures oxygen transfer is poor. With a simple mass balance it was shown that oxygen limitation could actually become a problem in the static cultures used for this study. An oxygen consumption rate was assumed between 1.6 and 33×10^{-17} mole O_2 /cell/s (Chapter 3). Assuming that the majority of cells were on the bottom of the dish, it was calculated (Appendix 3) that the maximum number of cells that can be sustained in steady state is between 1.5×10^4 and 3×10^5 cells/mL. Although the approximation with Fick's law is simplistic (some extent of mixing occurs during sampling; oxygen is consumed) it serves as a good first indication of possible limitation. Cultures were grown in the same dishes but in 10% of the volume, thus reducing the path length of oxygen transfer from the environment to the bottom of the dish and enhancing mass-transfer rate ten-fold. The measured maximal cell density

of such duplicate cultures was 6×10^5 cells/mL and 5.5×10^5 cells/mL, whereas the control cultures reached a similar value of 5.1×10^5 cells/mL. This increase was insignificant, thus the calculations were too pessimistic with regard to oxygen supply.

It still remains to be established as to why the S4B6 hybridoma displays poor growth behaviour in comparison with most reported data. Expected densities are in the range $0.5-3.0 \times 10^6$ cells/mL, indicating that S4B6 is at the lower end. It seems unlikely that nutrient and oxygen become limiting at the same moment, although this should be tested. Development of a fed-batch strategy has shown to result in enhanced growth in experiments by Reuveny *et al.* (1986b) and Ramirez and Mutharasan (1990) as well as reduction of waste metabolite build-up. However such hybridomas reached higher cell densities than S4B6 in batch cultures to start with. Waste product build-up is the most likely reason for reaching a maximum cell density, but the repeated transfer of cells into fresh medium indicated that this is probably not the only reason. Further investigation is needed to determine the growth limiting factors at the observed densities.

4.1.5 Time course antibody formation

Figure 4 shows a typical profile of antibody formation during an experiment in non-agitated culture. Antibody is produced during the growth phase, but also continues during the phase that cell density levels off and even decreases. This observation has also been made by Sureshkumar and Mutharasan (1991), Suzuki and Ollis (1990), and Reuveny *et al.* (1986a). The latter assumed that this effect was due to maintenance of a high viable cell density in the phase where cell density levels off and decreases. However Wohlpart *et al.* (1990), Luan *et al.* (1987), and Ramirez and Mutharasan (1990) showed that antibody yield leveled off as cell density became constant. Assuming that antibody production is non-growth associated, it will continue in the stationary phase and death phase as long as the remaining viable cells

are not inhibited.

One possible explanation for the increase in antibody concentration observed at the end of an experiment is the degradation of the intact molecule into separate heavy and light chains. The ELISA method would thus detect separate chains (Chapter 3), but not necessarily active antibody. Hence, the observed increase in antibody concentration would be an artefact. This problem may vary upon the ELISA method used, but it has not been addressed in the literature. In order to determine the bioactivity of produced antibody, the MTT assay, as described in Chapter 3, was used. The antibody quality was determined at several sample times during the experiment. No accurate quantification of antibody activity was obtained because an internal standard lacked, but a comparison with S4B6 antibody originating from ascites (unknown concentration) was made. The result is given in Figure 6. An increase in activity with time was observed during the experiment. This agrees qualitatively with the ELISA result (Figure 4). No negative control was included and also quite some variation of the maximal cell proliferation (optical density) can be seen. Maximal IL2 blocking activity occurs until approximately 1:32 dilution of the supernatant from the last sample (t=120 h). The ascites sample shows full inhibition up to 1:2000 dilution.

4.1.6 Growth and antibody production with agitation

Cultures grown in spinner flasks showed a slightly different behaviour from the non agitated cultures (Figure 7). The maximum cell density was only 3.0×10^5 cells/mL, significantly lower than the observed densities in non-agitated cultures. An experiment in a 2000 mL stirred fermenter gave a similar result (Figure 8) where a final density of 3.5×10^5 cells/mL was reached (no duplicate). Antibody concentrations were similar to those obtained in unstirred cultures, 32 mg/L and 28 mg/mL for spinner and fermenter respectively. However in the latter experiment a rapid drop in viable cell density was observed, during which the antibody concentration ceased to increase. The

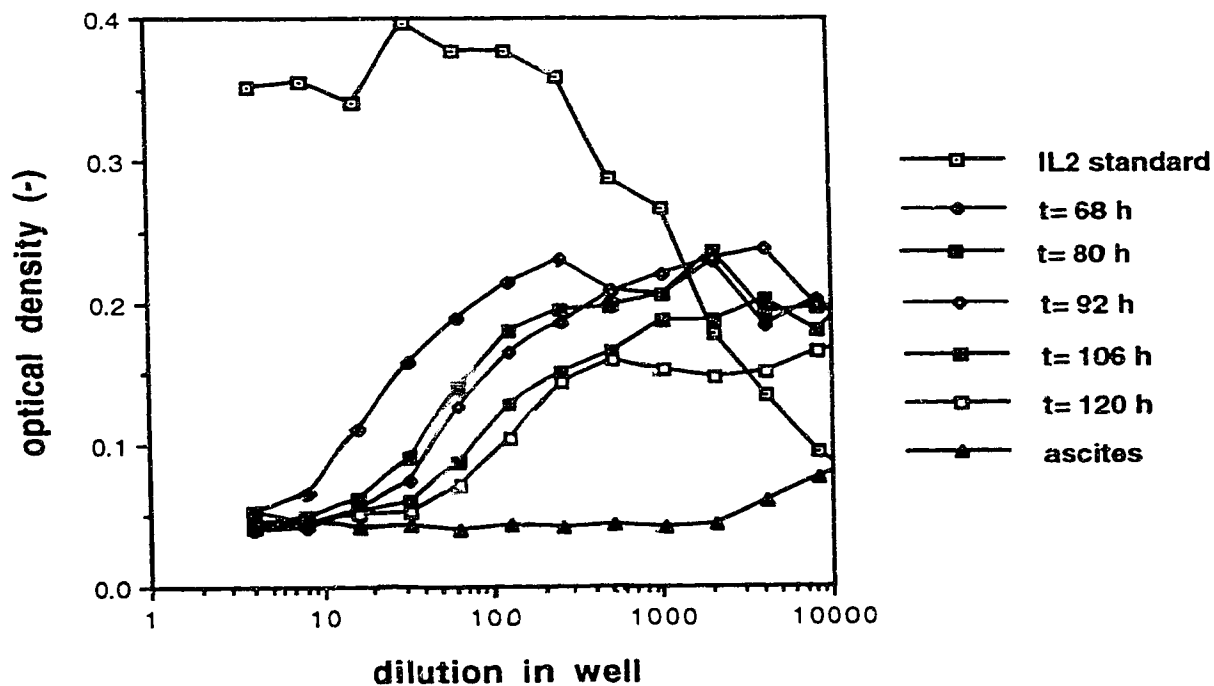

Figure 6. Bioactivity of produced antibody during batch experiment at 37°C. Optical density (proportional to HT2 cell proliferation in presence of IL2) as function of sample dilution. IL2 standard represents the proliferation of HT2 as function of IL2 dilution (separate experiment). Samples from S4B6 culture supernatant were added and diluted at a constant IL2 concentration, yielding 50% of maximum HT2 proliferation as determined from standard curve.

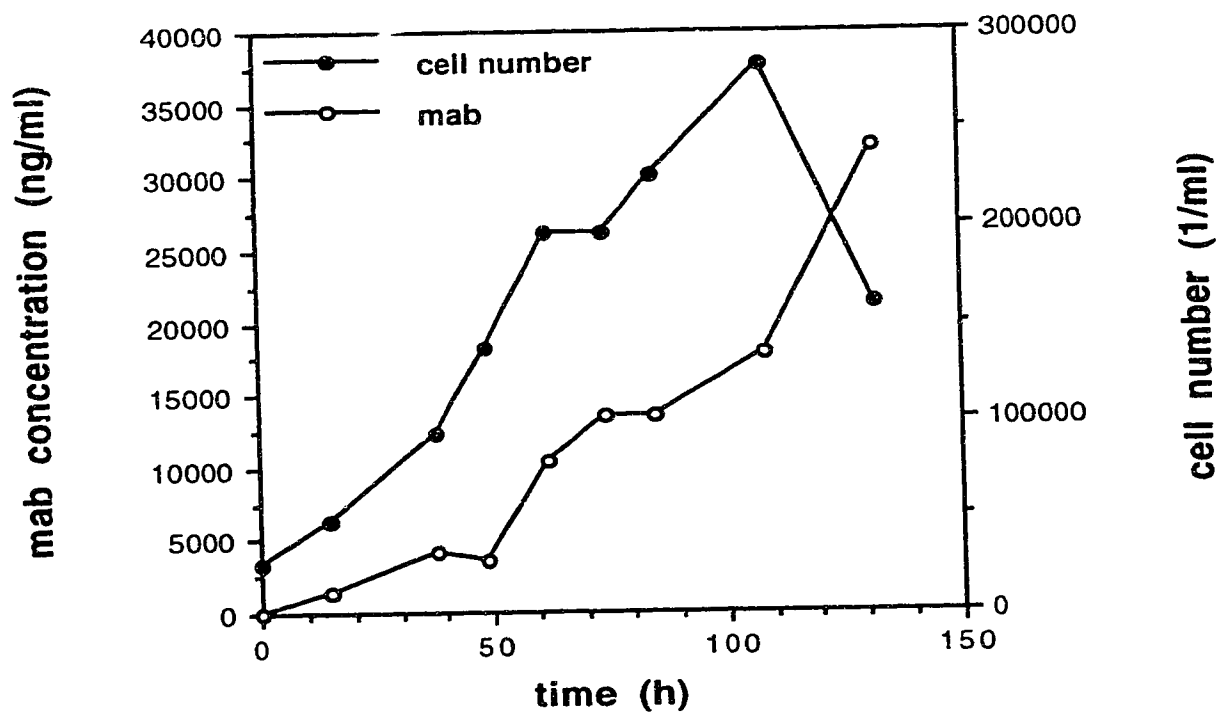

Figure 7. Viable cell density and monoclonal antibody concentration during batch experiment in agitated spinner flask at 37°C.

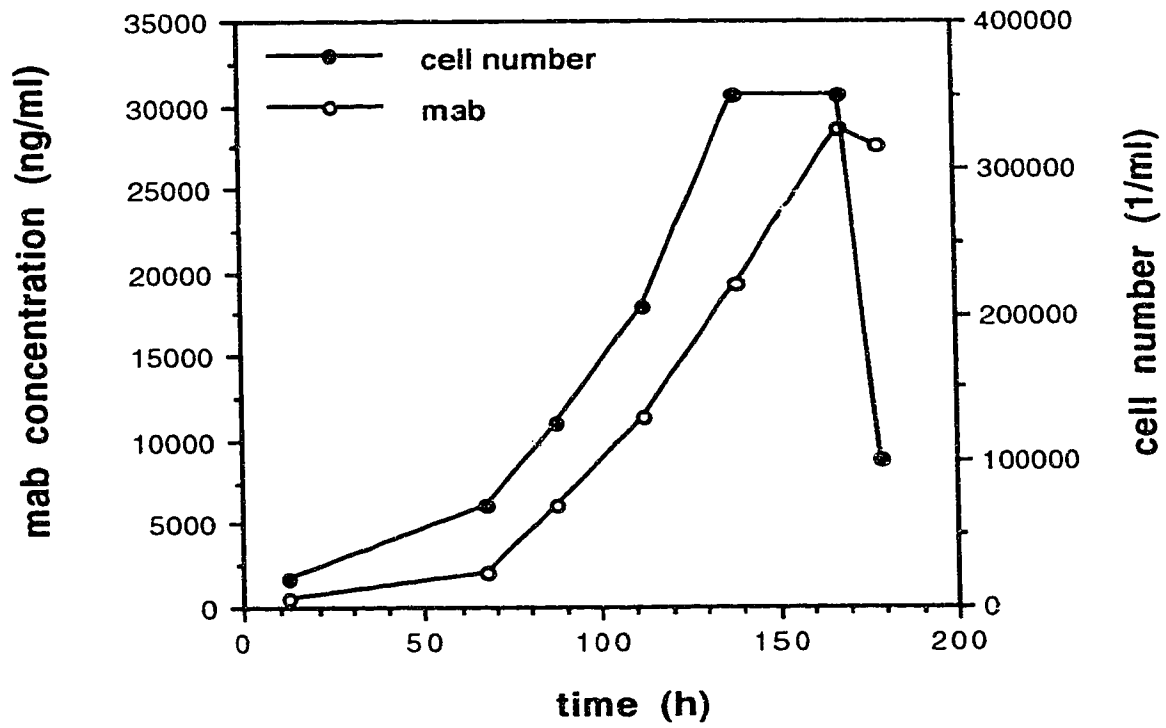

Figure 8. Viable cell density and monoclonal antibody concentration during batch experiment in agitated fermenter at 37°C.

fermenter experiment also showed that the dissolved oxygen concentration never went below 35%. The pH fell continuously from 7.4 to 6.8, similar to observations in non-agitated cultures. Oxygenation in the agitated fermenter is sufficient not to create any limitation. Therefore it is assumed that spinner cultures that gave similar cell density and antibody concentration, were also likely not to suffer from oxygen limitation.

The effect of agitation was demonstrated, although it is unclear if only shear was responsible for lower cell yields. Shear breakage of cells would be unlikely at the agitation speed of 60 rpm (Handa-Corrigan *et al.*, 1989). Other investigators showed relatively easy production in agitated systems (Table 1). Another factor could be the less denser cell culture in comparison with non-agitated cultures. Cells closely packed on the bottom of a culture dish may stimulate each other with unknown factors ("signaling").

4.2 Experimental error analysis

Determination of viable cell number using a hemocytometer gives an approximate error equal to the square root of the number of cells counted (Pringle and Mor, 1975). For cell counts of circa 200 this results in an error (standard deviation) of 7%, based on purely statistical variation. Other errors include sampling variations and human error. From quadruplicate counts for each sample in a time course experiment an estimate was made of the total error. An experiment in non-agitated culture (Appendix 2: A2-7) was used to achieve this. The error is shown as error bars (standard deviation) on each data point in Figure 9. The maximum error using this method is 18% at 50h. At the maximum cell density of 5.4×10^5 cells/mL the error was 6%. It is assumed that errors of similar magnitude occurred in all cell counts for each experiment.

The error in antibody analysis resulted from more sources. During preparation of the plates, multiple pipetting of small volumes (50 μ L) must be done. This procedure is subject to error, especially between the different wells in one plate. It is important that excess conjugate is rinsed out well and that

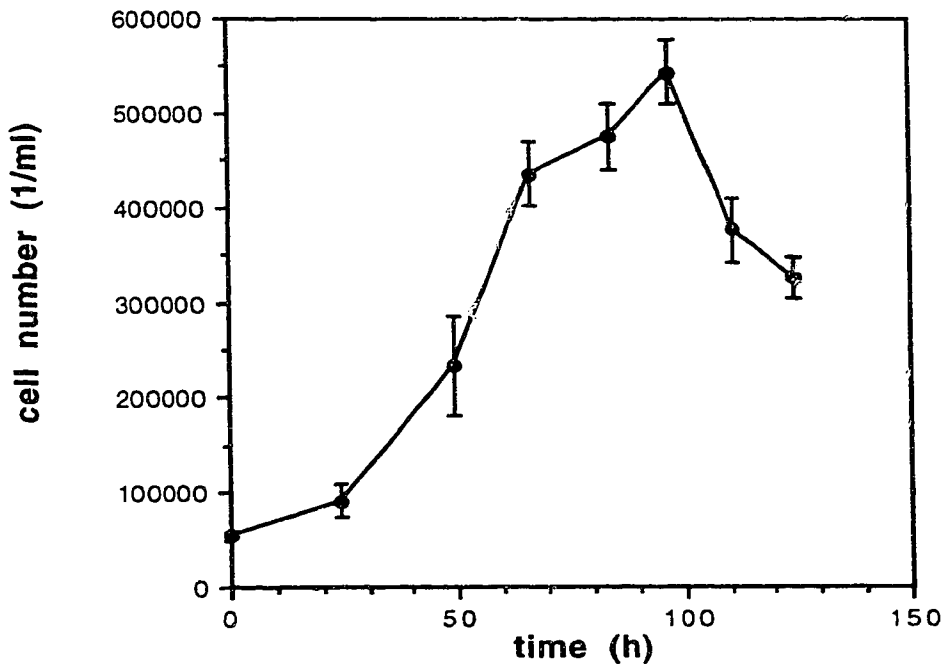

Figure 9. Typical error from cell counting using hemocytometer. Error bars represent standard deviation from quadruplicate counts.

the substrate addition step is done carefully and fast so that wells will develop color equally. Samples were loaded in triplicate to get an idea of the standard deviation involved in ELISA. For each sample three values for optical density were obtained plus a standard deviation. These data were used to calculate an average value for antibody concentration, and limits for minimum and maximum concentration using a standard curve. The points on the standard curve were equally susceptible to error plus an error resulting from regression. This error was small because the fits were generally good ($R^2 \cong 1$). By reading optical densities between 0.1 and 0.8, the error in the standard curve can be virtually neglected (Figure 10a) and a straight line approximation can be followed (Figure 10b). In order to determine the final antibody concentration in a sample, the optical density (concentration of standard) corresponding with an observed sample optical density, must be multiplied by the dilution factor for the specific well. This results in extra error due to multiple pipetting errors. Accurate techniques should keep these errors minimal.

In conclusion, the error in measured antibody concentration is assumed to be the result of statistical variation in optical density of the sample and thus concentration. Multiplication with the specific dilution factor for each sample increases the error proportionally with increasing concentration as expected. A representative error in determination of antibody concentration by ELISA can be found in Figure 11. The error varies between 0 and 16%.

4.3 Effect of temperature on growth and antibody production

The effect of temperature was studied in the range 34-39°C. In this range the growth is expected to vary (Sureshkumar *et al.*, 1991; Reuveny *et al.*, 1986a); lower or higher temperatures were expected to result in no growth at all.

Both non-agitated cultures and agitated cultures were used to study the effect of temperature on growth and antibody yield. In addition, agitated cultures were used to study the effects of temperature on cell cycle kinetics. Cultures were grown in duplicate. Data from the repeat experiments are given in Appendix 4.

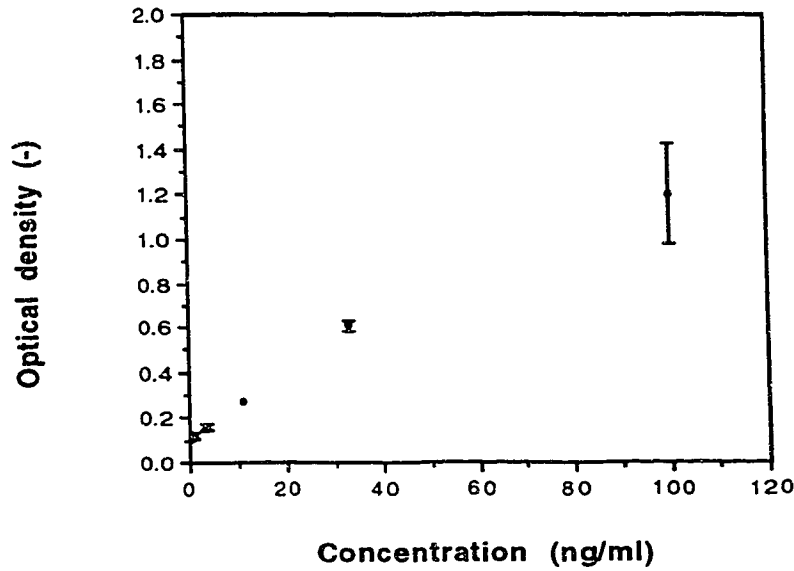

Figure 10a. Typical error in ELISA standard curve. Standard deviation resulting from triplicate sample measurement.

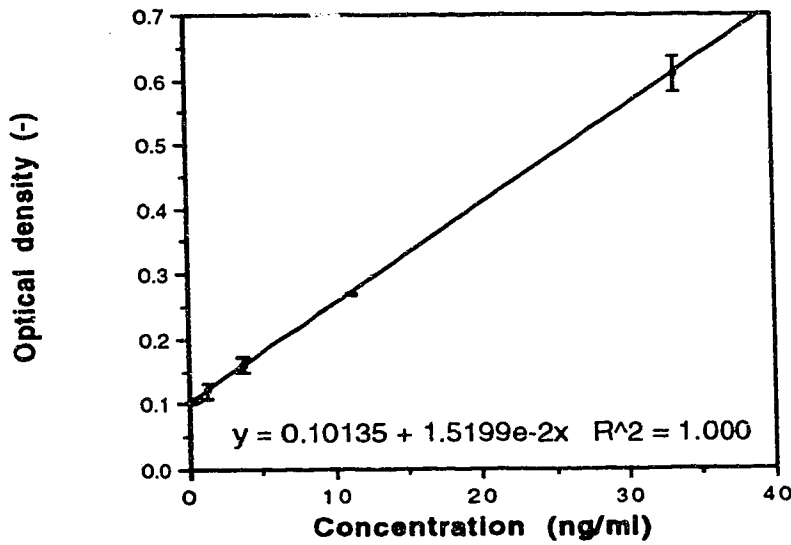

Figure 10b. Straight line approximation of ELISA standard curve for optical density between 0.1 and 0.8. Approximate error (standard deviation) resulting from triplicate sample measurement.

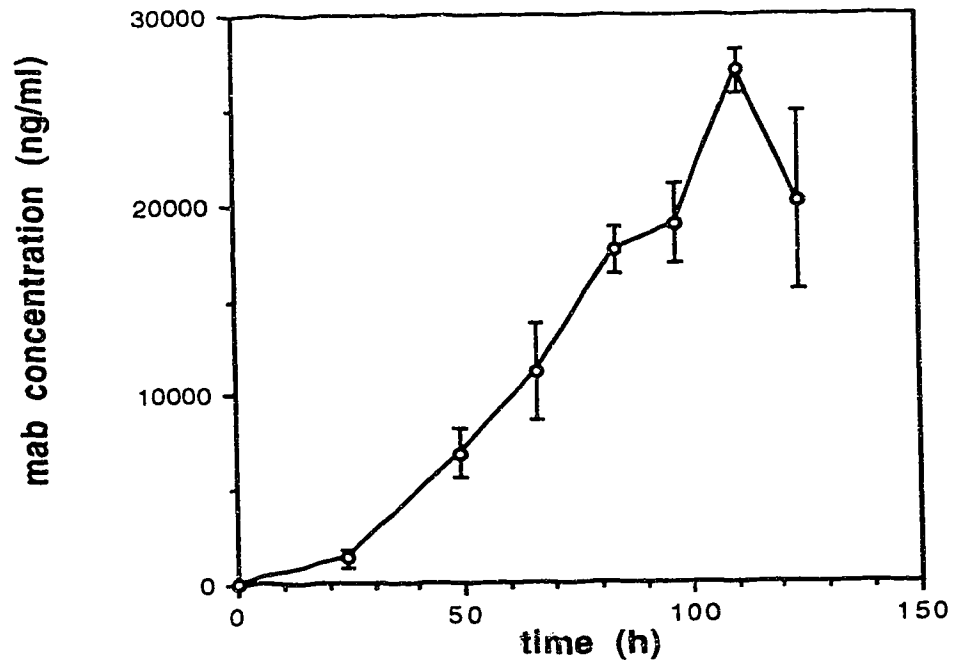

Figure 11. Typical error in measured antibody concentration.

4.3.1 Non-agitated cultures

Figures 12 through 14 show the results for non-agitated cultures at 34, 35, and 38°C. The data from the experiment at 37°C is given in Figure 4. Table 5 summarizes the maximal cell density, the maximal monoclonal antibody concentration (ELISA) and the maximum specific growth rate measured. The latter was calculated using equation (2) for the time interval where cell number increased the fastest. The figures show the generally observed phenomenon that production of antibody continues in the period that cell number leveled off or even decreased. Hence the production of antibody was not growth associated, as reported by other investigators (Chapter 2). Furthermore, the non-growth associated model for antibody production was applied (equation 4) to calculate the specific antibody production rates. Since the exact functions for growth and antibody production with time were unknown, discrete measurements for cell mass and antibody concentration were taken at each sample time. The specific production rate follows from integrating equation (4):

$$P(t) = \beta \int_0^t x(t)dt + P(0) \quad (6)$$

Hence a plot of $P(t)$ versus $\int_0^t x(t)dt$ yields a value for β . This calculation was

done for all experiments performed in the non-agitated cultures. The results are presented in Table 5. The original regression curves can be found in Appendix 5. In cases where mab production decreased during cell death, as occurred sometimes at the very end of a culture period, the datapoint was left out. The coefficient of determination is given as an indication of goodness-of-fit. The lines were not forced through the origin, because this would give a biased slope. An initial antibody concentration, caused by carry-over from the inoculum, will yield a small positive intercept. A small negative intercept may be caused due to an initial lag-period.

Alternatively, it is possible to calculate specific antibody production rates from the differentiated equation (4). This result is, however, more dependent

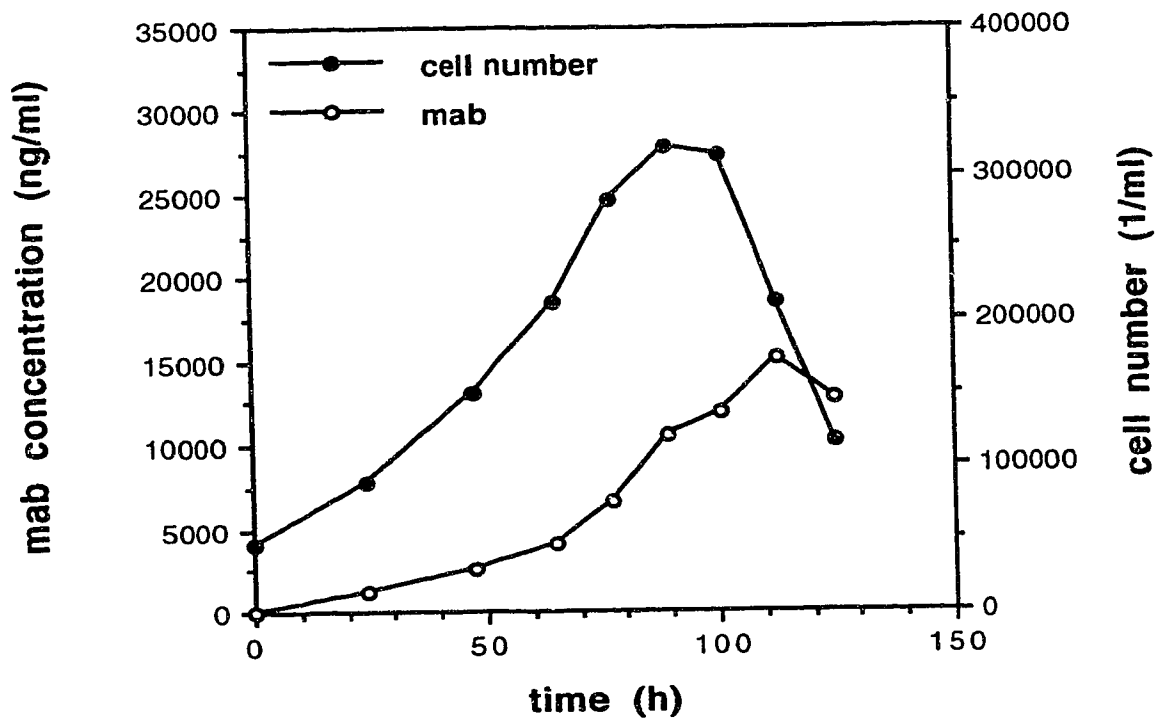

Figure 12. Viable cell density and monoclonal antibody concentration during non-agitated batch culture at 34°C.

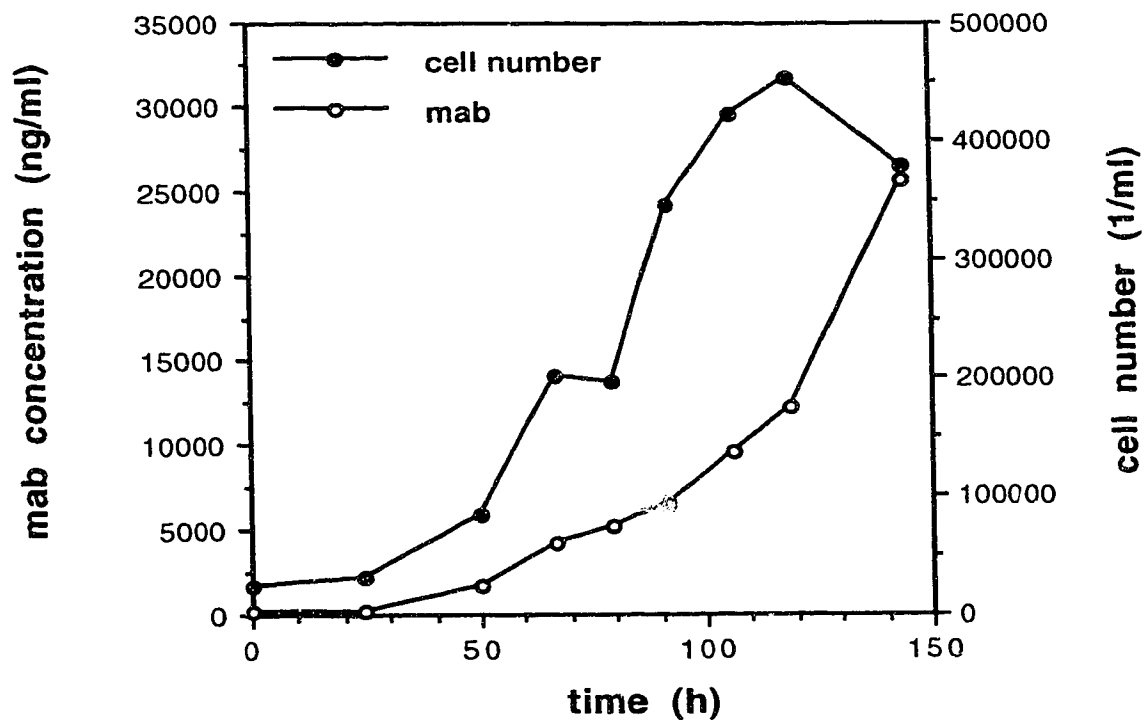

Figure 13. Viable cell density and monoclonal antibody concentration during non-agitated batch culture at 35°C.

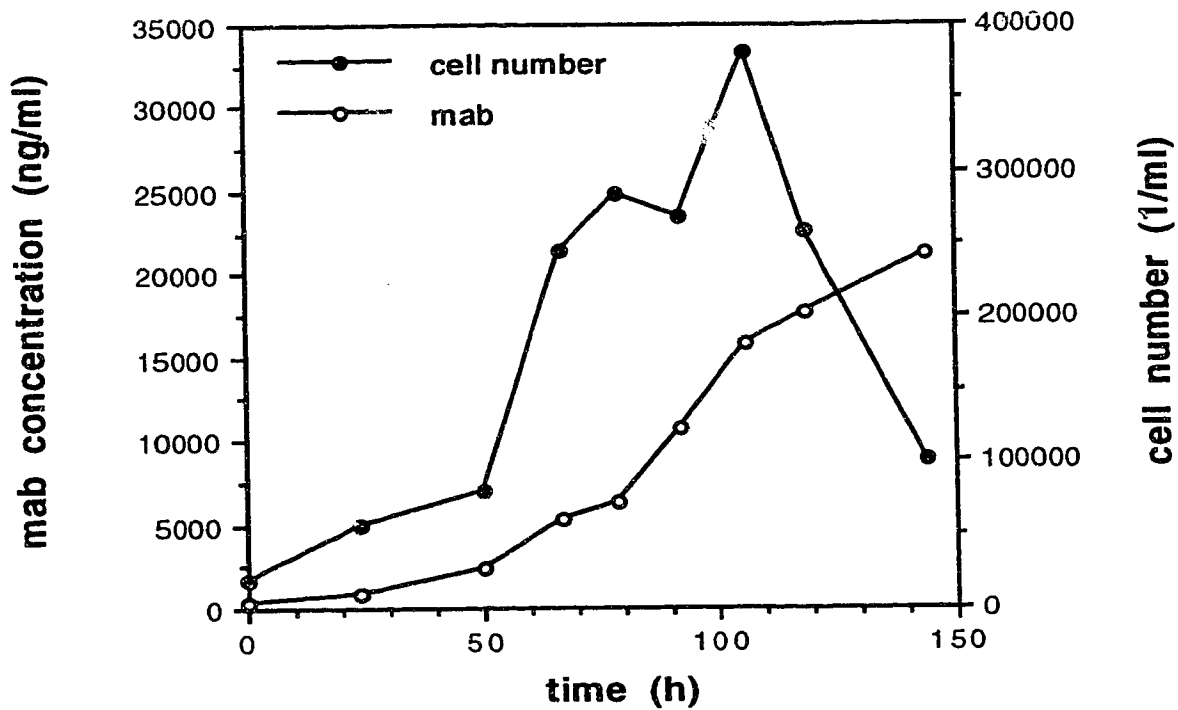

Figure 14. Viable cell density and monoclonal antibody concentration during non-agitated batch culture at 38°C.

on error in both measured cell density and antibody concentration at each sample time. The integrated equation (6) reduces the effect of the error in cell count by averaging out over time. Therefore this integral method is preferred over the alternative differential method.

Table 5. Effect of temperature in non- agitated cultures.

temperature (°C)*	max viable cell number (10 ⁵ /mL)	maximum mab (mg/L)	μ_{max} (h ⁻¹)	β (pg/cell/h)
34 (1)	3.2	15.0	0.022	0.95
34 (2)	3.2	15.0	0.021	0.71
35 (1)	4.5	26.5	0.034	0.74
35 (2)	4.0	23.5	0.041	0.86
37 (1)	4.9	32.0	0.030	0.90
37 (2)	5.1	25.0	0.025	0.76
37 (3)	5.4	27.0	0.038	0.85
37 (4)	4.2	32.0	0.025	1.27
37 (5)	3.8	27.5	0.029	0.93
38 (1)	3.8	21.0	0.060	0.85
38 (2)	3.5	31.0	0.048	1.23

* number of experiment shown in brackets

The results indicated that both cell density and monoclonal antibody yield were highest at 37°C. Growth rate was highest at 38°C (0.048-0.060 h⁻¹). Specific antibody production rate was circa 1.0 pg/cell/h at both temperatures. The average value at 37°C was 0.94 ± 0.20 pg/cell/h, indicating significant scatter. There was no trend observed that specific antibody production rate would be

higher at slower growth, nor at lower cell densities, as suggested by previous researchers (Suzuki and Ollis, 1989). At 34°C the specific growth was minimal (0.022 h⁻¹), yet the final monoclonal antibody concentration was also minimal (15 mg/L).

4.3.2 Agitated cultures

Similar experiments were performed in 200 mL agitated spinner flasks at 34, 37 and 38°C. An experiment at 39°C was cancelled prematurely because rapid cell death occurred after inoculation. Viable cell number and antibody concentration were measured at regular intervals. Also the fraction of the cell population in a particular phase of the cell cycle was measured as described in Chapter 3. These results can be found in Figures 15, 7 and 16. For each culture, the specific antibody production rate was calculated by equation (6) as for the non-agitated cultures. The results are compiled in Table 6. The regression curves for determination of β are included in Appendix 5.

Table 6. Effect of temperature in agitated cultures.

temperature (°C)*	max.viable cell number (10 ⁵ /mL)	maximum mab (mg/L)	μ_{max} (h ⁻¹)	β (pg/cell/h)
34 (1)	4.4	30.0	0.037	0.81
34 (2)	4.0	33.0	0.038	0.95
37 (1)	2.8	32.0	0.031	1.33
37 (2)	3.2	36.0	0.032	1.37
38 (1)	2.8	29.0	0.033	1.07
38 (2)	2.7	15.0	0.024	0.67

* number of experiment shown in brackets

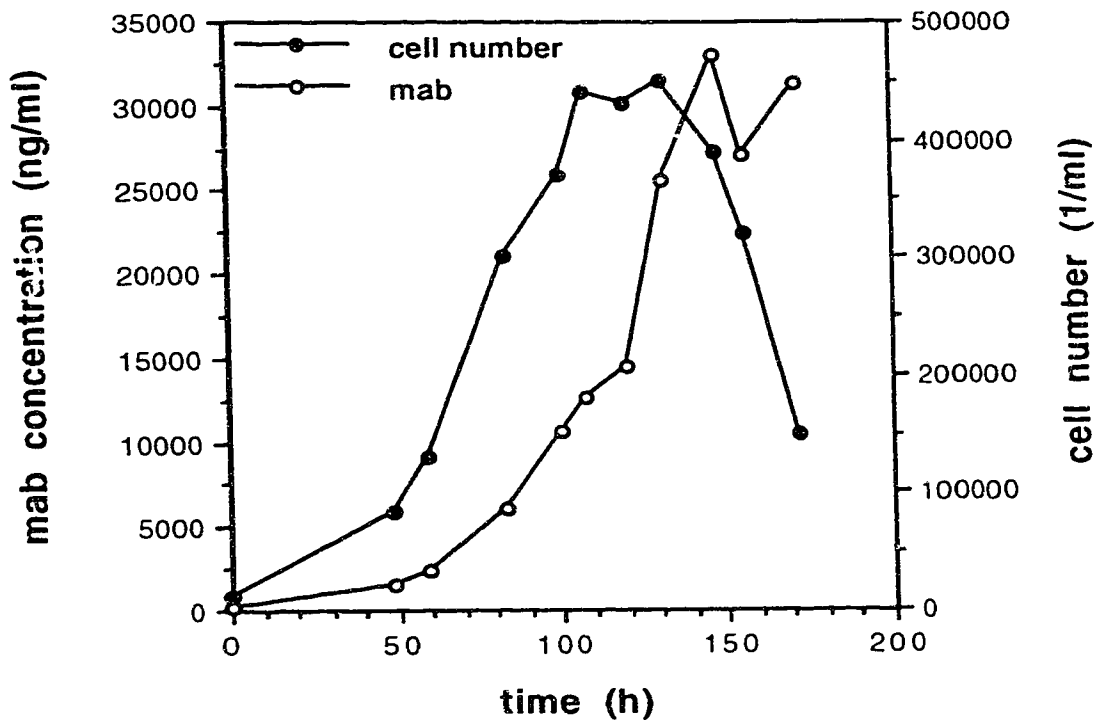

Figure 15. Viable cell density and monoclonal antibody concentration during batch experiment in agitated spinner flask at 34°C.

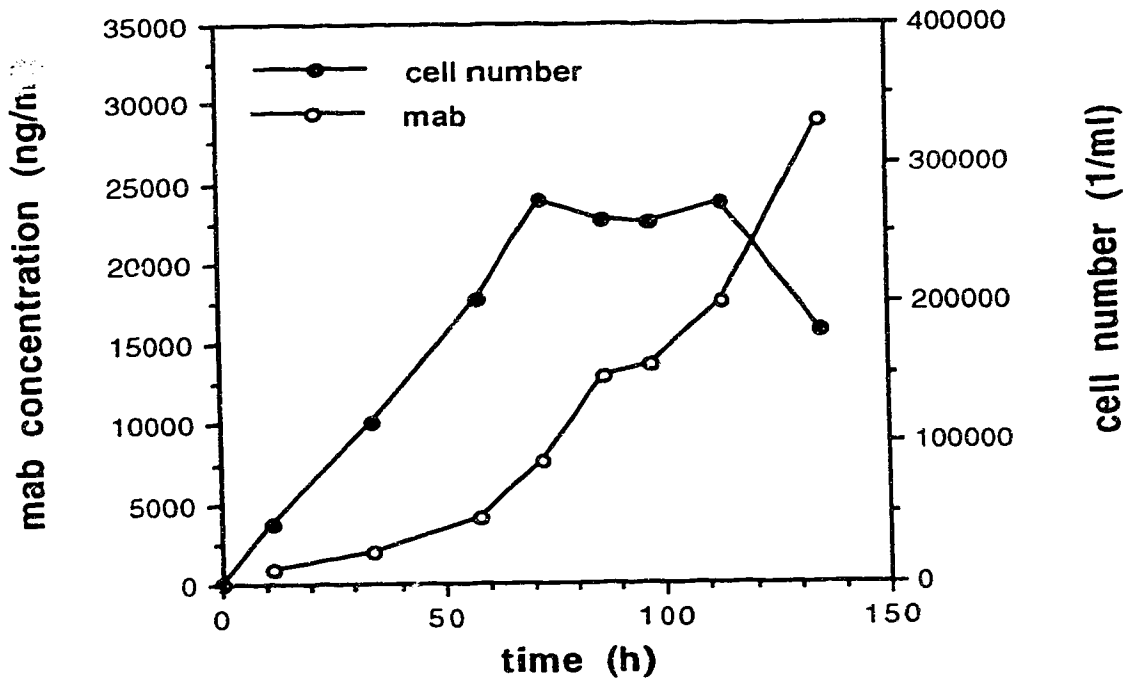

Figure 16. Viable cell density and monoclonal antibody concentration during batch experiment in agitated spinner flask at 38°C.

The highest cell density in agitated cultures was obtained at 34°C; a density of 4.4×10^5 cells/mL was achieved. It could be argued that lower temperatures would yield even higher cell densities, but this is not expected from the results in non-agitated cultures. This should be verified, however. The antibody levels of experiments at both 34 and 37°C were comparable, 30 mg/L and 32 mg/L respectively. The specific antibody production rate was not significantly different at different temperatures and within earlier reported data scatter. The run at 38°C was not very reproducible with respect to antibody yield. A possible explanation was that the duplicate culture showed more rapid cell death at the end of the experiment. Cell densities in agitated culture were $1-2 \times 10^5$ cells/mL lower than in non-agitated cultures at all temperatures except 34°C, where the density was 1.2×10^5 cells/mL higher. Antibody yields in the agitated cultures were 5-15 mg/L higher than the non-agitated cultures, except for the culture at 38°C. This result was in accordance with observations that induction of environmental stress was favourable for antibody production (Miller *et al.*, 1988). However this result was in contrast with observations made by Al-Rubeai *et al.* (1990), that resistance to hydrodynamic stresses is higher at high temperatures. Antibody production was not enhanced in either agitated or non-agitated cultures at slower growth rates as suggested by Suzuki and Ollis (1990).

The results from the experiments at constant temperature did not indicate a significant difference between the optimum temperatures for specific antibody production and cell growth. The slightly higher value obtained at 37°C could indicate that it would be advantageous to shift the temperature from 34°C to 37°C. Sureshkumar and Mutharasan (1991) found the highest total antibody concentration at 35°C (56 mg/L), and the highest cell density at 33°C (4×10^6 cells/mL). The maximum specific antibody production rate at 39°C (0.15 pg/cell/h) was more than 100% higher than at 33°C (0.07 pg/cell/h). On a per cell basis this latter value was much lower than observed for the S4B6 hybridoma, which did not reach high cell densities but did give relatively high monoclonal antibody concentrations.

The optimum temperatures for cell growth and antibody production are

apparently different for different hybridoma cell lines and S4B6. The maximal attainable values for cell density and monoclonal antibody concentration differ significantly for S4B6 and several other hybridoma cell lines (see also Table 1). These observations lead to the conclusion that biological differences must be considered in the scale-up and production of monoclonal antibodies.

4.3.3 Antibody production during cell cycles

An extension of equation (6) was made, relating cell growth and antibody formation with the cell cycle theory. It is based on the following assumptions (Suzuki and Ollis, 1989):

1. Antibody synthesis occurs during G_1 -phase of the cell cycle.
2. Antibody synthesis is non-growth associated.

Hence, an equation describing antibody formation under these constraints can be written as:

$$\frac{dP}{dt} = \beta' x(t)y_{G_1}(t) \quad (7)$$

where y_{G_1} is the fraction of cells in G_1 -phase at each time, and β' is the specific monoclonal antibody production rate based on the producing fraction of cells $x(t)y_{G_1}(t)$. A plot of $P(t)$ versus $\int_0^t x(t)y_{G_1}(t) dt$ should yield a straight line through the origin with slope β' if the model is valid.

Using the data for cell number and antibody yield, and the data from cell cycle analysis (Figure 17, 18 and 19), this hypothesis was tested. An example of a flow cytometric histogram, from which cell cycle data were calculated, is given in Appendix 4. Flow cytometer data were not available from every sample time because of occasional sample loss due to failure of the FACS and because samples taken at the end of a run contained much debris

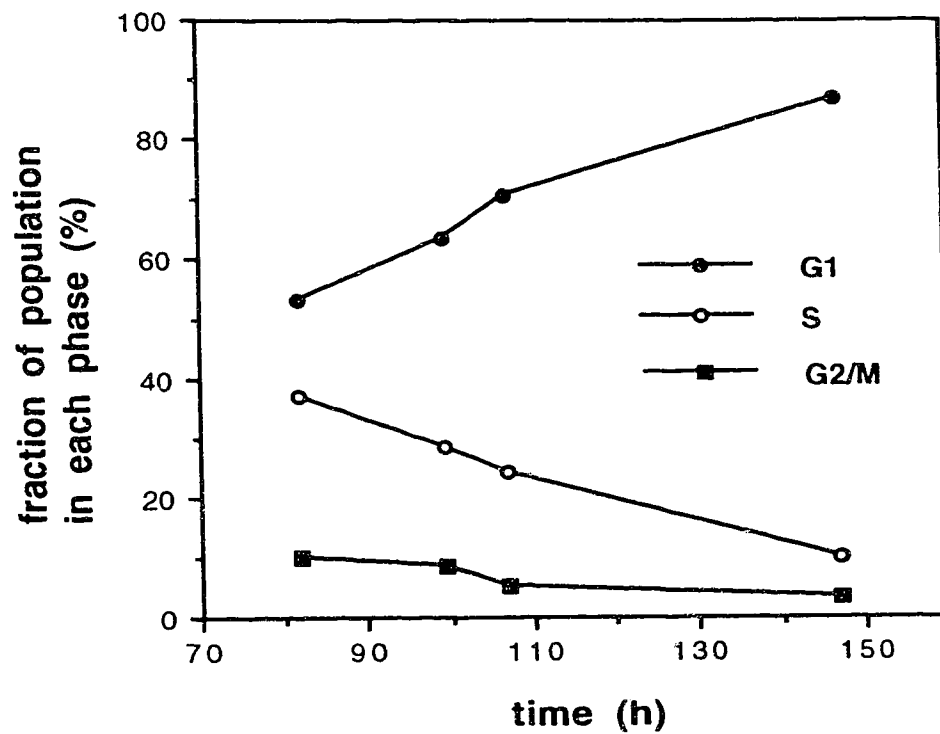

Figure 17. Fraction of cell population in G₁, S and G₂+M phase during batch experiment in agitated spinner at 34°C.

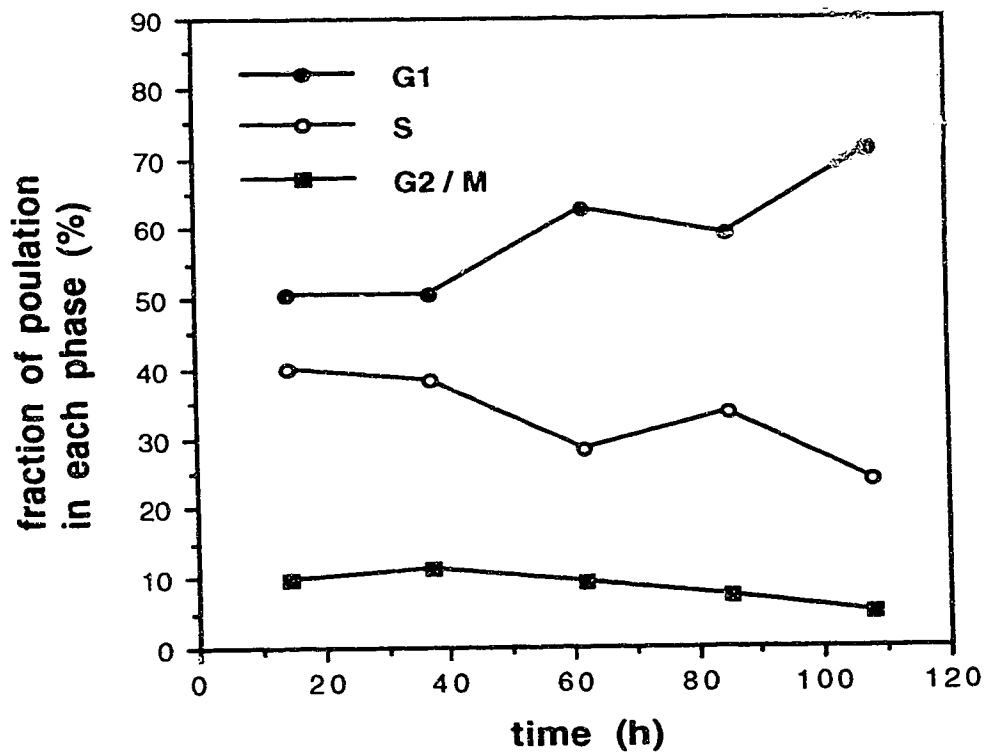

Figure 18. Fraction of cell population in G_1 , S and G_2+M phase during batch experiment in agitated spinner at 37°C .

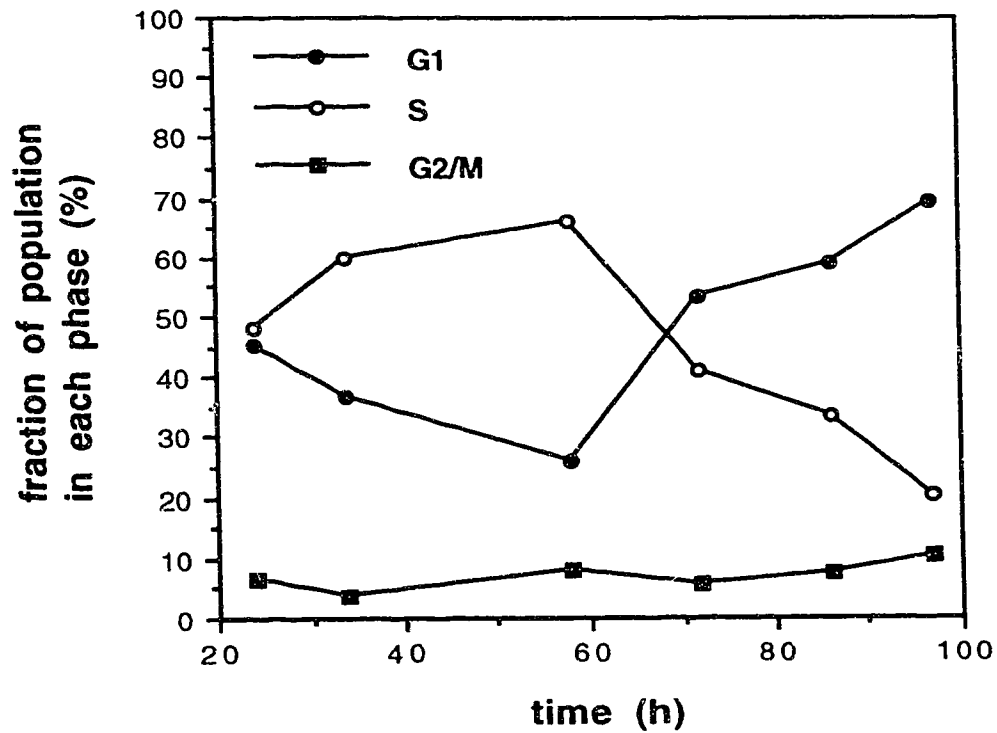

Figure 19. Fraction of cell population in G_1 , S and G_2+M phase during batch experiment in agitated spinner at 38°C .

and dead cells, resulting in noisy data. The results of the regression for each run are given in Appendix 5, including a goodness-of-fit indication (R^2). In Table 7 a comparison is made between the results of the two models (equation 4 and 7 respectively) used to determine specific antibody production rate. In order to be able to compare these model results, new values for β were calculated using equation (4) with the same number of samples as used for calculating β' with equation (7). A more reliable fit could be made with more points. The ratio of β and β' yields an average value for the fraction of cells in G_1 -phase during a particular experiment, that corresponds approximately with the time average value from figure 17, 18 and 19. It can be seen that both models fit the data very well as a straight line. On the basis of coefficient of determination no discrimination can be made.

Table 7. Comparison of regression results between the models given by equation (4) and equation (7). Specific antibody production rates β and β' in pg/cell/h. The coefficient of determination is given for each fit. See also Appendix 5. The ratio β/β' represents the average fraction of cells in G_1 -phase.

temperature (°C)*	number of samples	β'	R^2	β	R^2	β/β'
34 (1)	4	1.70	0.978	0.95	0.983	0.56
34 (2)	6	1.70	0.969	1.03	0.950	0.60
37 (1)	6	1.77	0.940	1.08	0.950	0.61
37 (2)	6	1.85	0.983	1.12	0.995	0.61
38 (1)	6	1.98	0.965	0.89	0.971	0.45
38 (2)	6	1.06	0.977	0.55	0.964	0.52

* number of experiment shown in brackets

The question arises whether the obtained β values were significantly different from each other at different temperatures. A valid answer can only be given if the experiments are carried out multiple times. A comparison test of means (*t*-test) is not recommended because of the small sample size. Duplicates, however, give an indication of the variability. The new values of β indicate that the specific antibody production rate at different temperatures is approximately equal. Hence, the earlier mentioned temperature shift would have no effect.

The G_1 fraction of cells made up 40-85% of a culture and increased steadily during the runs at 34 and 37°C. For the run at 38°C, the change in fraction of G_1 was slightly different, but this fraction was generally increasing. Also the fraction of S-phase cells was higher than in the experiments at 34 and 37°C. Because of the general increase of the G_1 fraction in all three experiments, the effect of the extra y_{G_1} term in equation (7) was not very significant. The fraction of the population in G_2+M remained relatively constant as expected. The population was assumed to be asynchronous and homogeneous, hence the increase in G_1 fraction of the population represented a prolonged G_1 -phase of the individual cell and a decrease in the specific growth rate. Temperature could thus be used as a means of arresting cells in the G_1 -phase. Nevertheless, no positive correlation of G_1 -phase length with specific antibody production rate was observed. This result was in contrast with observations by Suzuki and Ollis (1990), who clearly demonstrated the increased specific antibody production rate at slowed growth, caused by arresting cells. Obviously the mechanism which arrests cells in the G_1 -phase is an important factor. The results indicate that temperature may not be suitable as factor for enhanced production due to extended G_1 -phase.

Another flow cytometric study (Schliermann *et al.*, 1987) focused on the effect of initial serum concentration on the fraction of cells in G_1 -phase during a time course experiment. No link was made between antibody production and cell cycle phase. Furthermore the unexplained observation was made that specific antibody production rate dropped gradually during the experiment

from 10.0 to 0.8 pg/cell/h. No absolute antibody concentrations were reported, so this result could not be verified. Other investigators presenting flow cytometric studies on hybridoma cells (Dalili and Ollis, 1990; Ramirez and Mutharasan, 1990; Al-Rubeai *et al.*, 1991) did not link cell cycle phase changes to monoclonal antibody production either.

The results indicated that antibody production by the S4B6 hybridoma is non-growth associated. These results agreed with findings of Ozturk and Palsson (1991b) and Sureshkumar and Matharasan (1991). These results are, however, in contrast with observations by Ramirez and Mutharasan (1990) and Schliermann *et al.* (1987). Ray *et al.* (1989) observed a maximum value of 2.5 pg/cell/h at a specific growth rate of 0.020 h^{-1} , but a constant value of 1.5 pg/cell/h at growth rates between 0.025 and 0.040 h^{-1} . This confirms the importance of recognition of differences between hybridoma lines for scale-up and production.

4.4 Effect of temperature on bioactivity

In order to assess the effect of temperature on the bioactivity of produced antibody, assays were performed that compared the antibody quality at the start of a run with the quality at the end of a run. The two last samples of each culture were compared to check for degradation of antibody due to cell death and potential release of proteases. No accurate quantification of antibody activity was obtained, but a comparison with antibody originating from ascites was made. In Figure 20 the proliferation of HT2 cells (optical density) is shown as a function of IL2 concentration (dilution in well). From this curve the concentration at which circa 50% of maximum proliferation occurred was determined. Subsequently, at this constant IL2 concentration (10 units/well), sample supernatant was added and two-fold diluted over 16 wells.

Ascites antibody had a full blocking activity until approximately diluted 1:700. The supernatant of fully grown spinner flask cultures at 34, 37 and 38°C

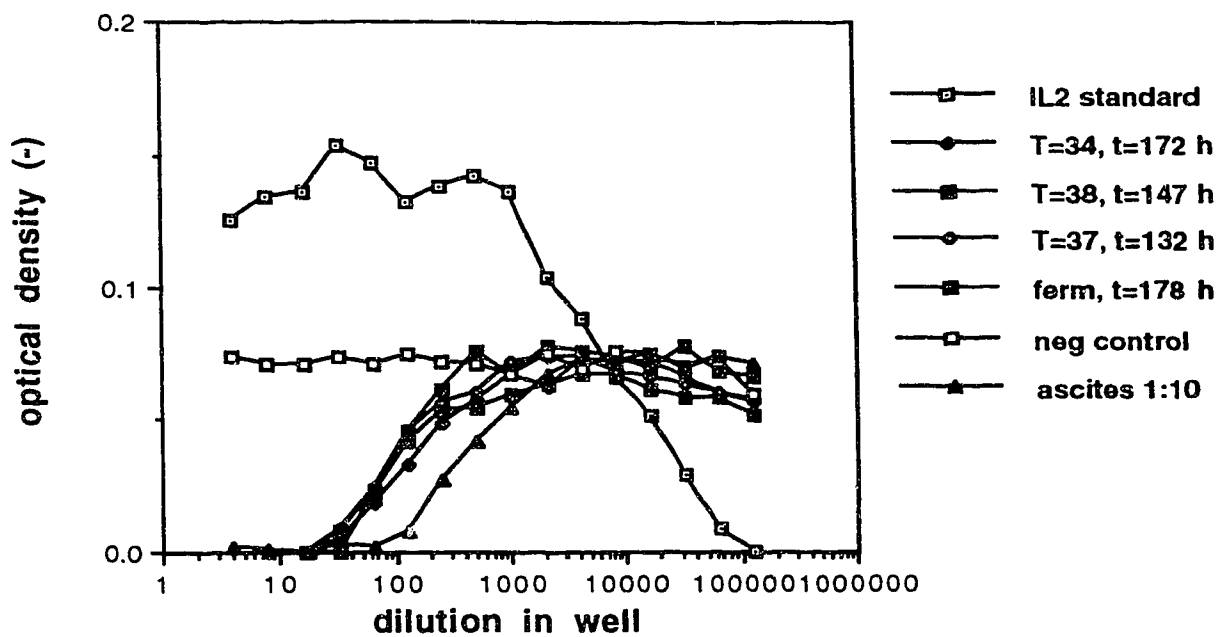

Figure 20. Comparison of bioactivity of final supernatant samples from agitated cultures at 34, 37 and 38°C. See text.

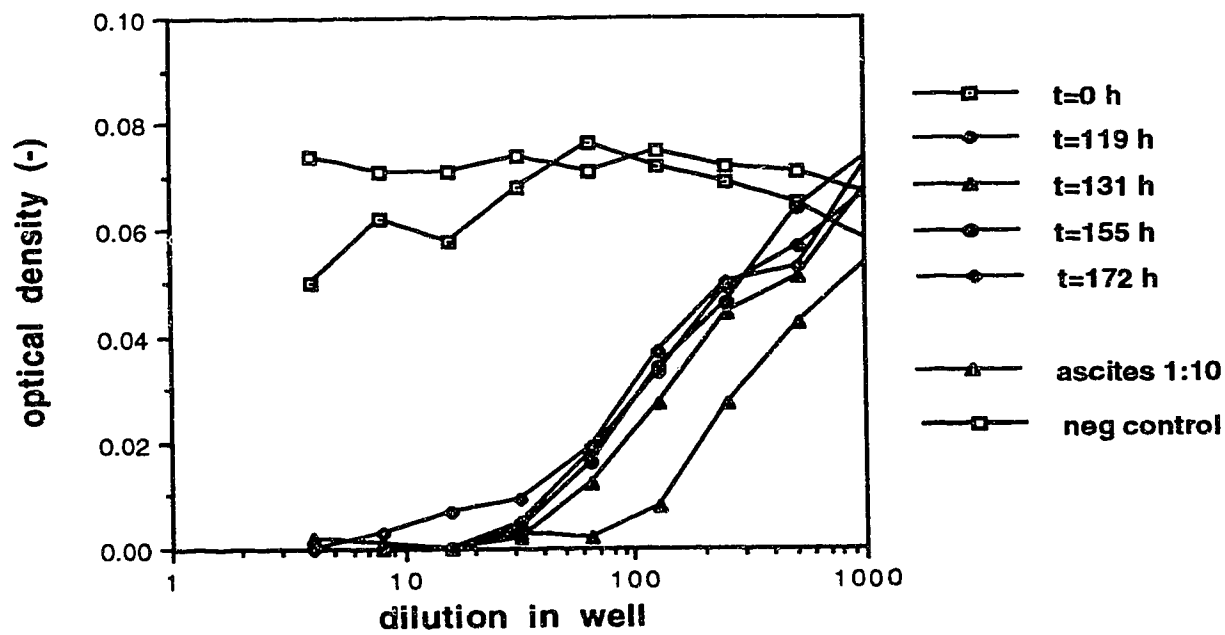

Figure 21. Bioassay for 34°C agitated culture. Proliferation of HT2 cells (optical density) as function of sample dilution at constant IL2. Comparison of IL2 blocking activity between t=0 h and t=172 h. Ascites antibody 1:10 as positive control, non reacting hybridoma supernatant (chapter 2) as negative control.

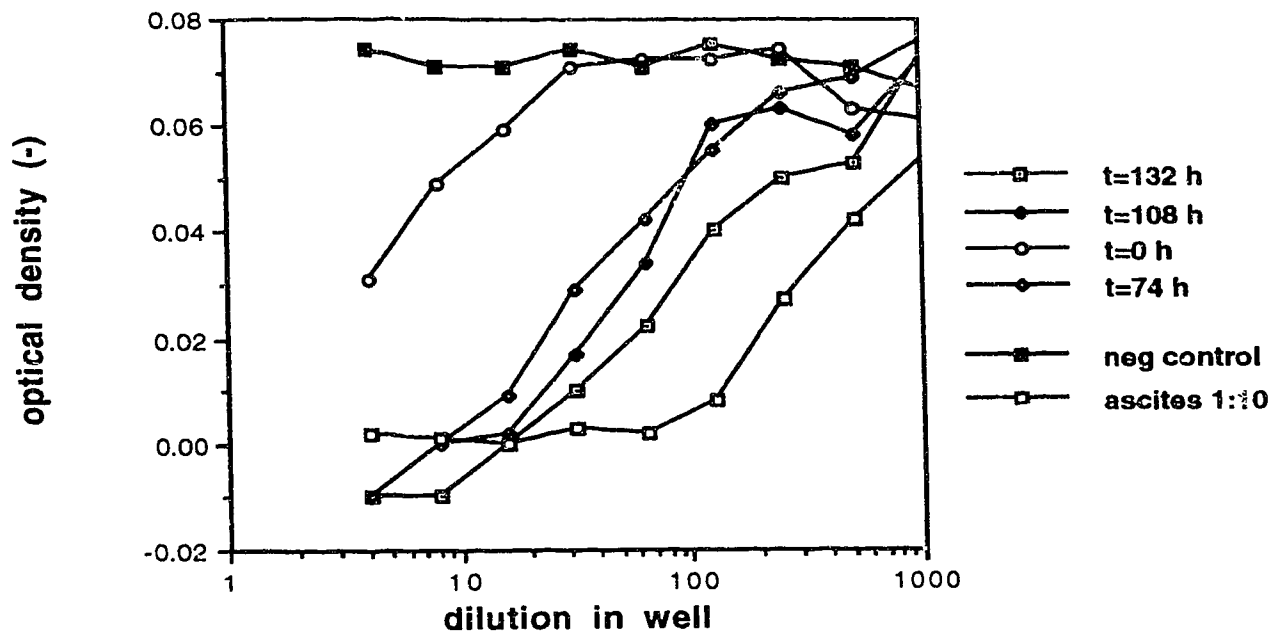

Figure 22. Bioassay for 37°C agitated culture. Proliferation of HT2 cells (optical density) as function of sample dilution at constant IL2. Comparison of IL2 blocking activity between t=0 h and t=132 h. Ascites antibody 1:10 as positive control, non reacting hybridoma supernatant (chapter 2) as negative control.

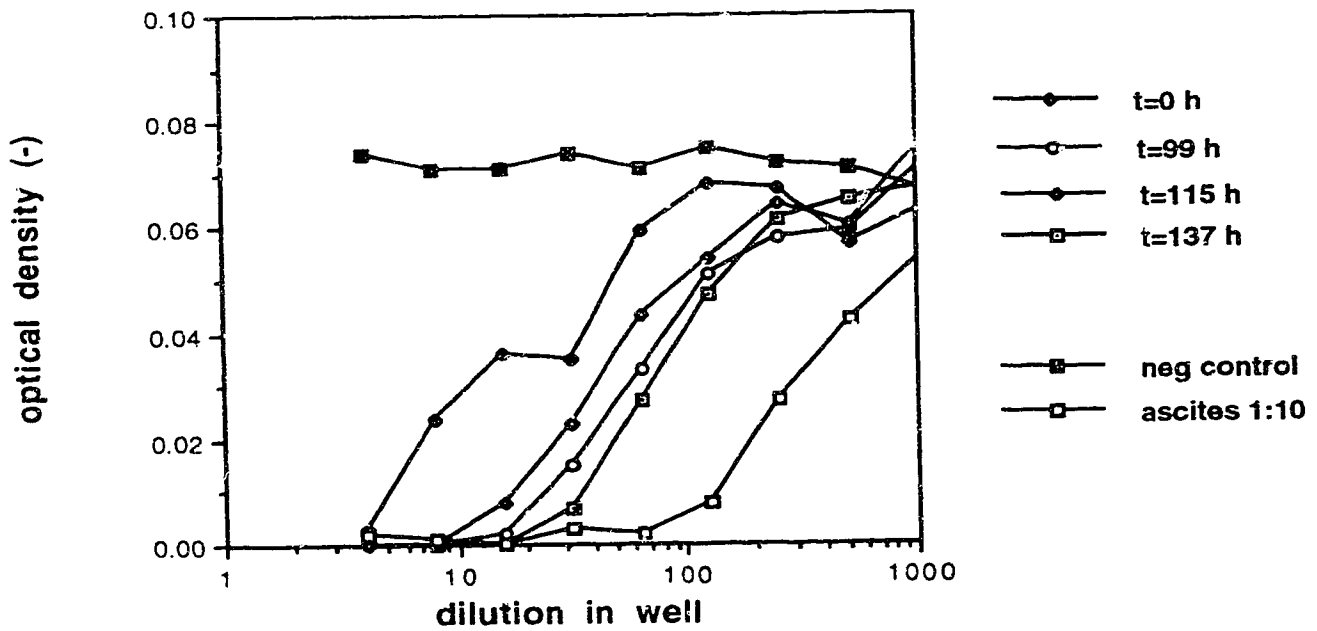

Figure 23. Bioassay for 38°C agitated culture. Proliferation of HT2 cells (optical density) as function of sample dilution at constant IL2. Comparison of IL2 blocking activity between t=0 h and t=137 h. Ascites antibody 1:10 as positive control, non reacting hybridoma supernatant (chapter 2) as negative control.

showed inhibition until approximately diluted 1:10 to 1:20 (Figures 21, 22 and 23). Hence the observed difference in activity was between 35- and 70-fold, which is roughly in accordance with an assumed concentration of 5 mg/L for the ascites used in this experiment, and a culture supernatant concentration of 20-30 µg/mL. The negative control did not show any inhibition, as expected. The bioactivity of antibody at the different temperatures as a function of time is also shown in Figures 21, 22 and 23. The duplicates (Appendix 6) show that the reproducibility of the MTT assay was within 2-fold dilution. The increase in antibody concentration in the agitated cultures at 34°C between 119h and 131h was seen in both the MTT assay (Figure 21) and the ELISA (figure 15). ELISA showed further increase with 5 mg/L after 119 h, but the MTT assay could not confirm this result because this increase fell within the reproducibility limits. The increase in antibody concentration during the experiments at both 37 and 38°C was detected by both ELISA and MTT assay (Figures 7 and 18, and 22 and 23 respectively). These results indicated that it is unlikely that antibody is degraded in the time interval where cell growth decreased. Hence, temperature had no effect on bioactivity.

4.5 Temperature shift

The results by Sureshkumar and Mutharasan (1991) indicated an optimal temperature for cell density and the highest specific production at 33 and 39°C respectively. Thus these investigators proposed a temperature shift in order to reach high cell density at 33°C, followed by a period of high specific production at 39°C. The total antibody concentration at the end of such an experiment was only 52 mg/L, as compared to a maximum observed value of 56 mg/L. However no optimization was done, so room for improvement exists. The authors did not discuss reproducibility of their results, which is an important factor

In this study, a temperature shift was carried out to test the arresting

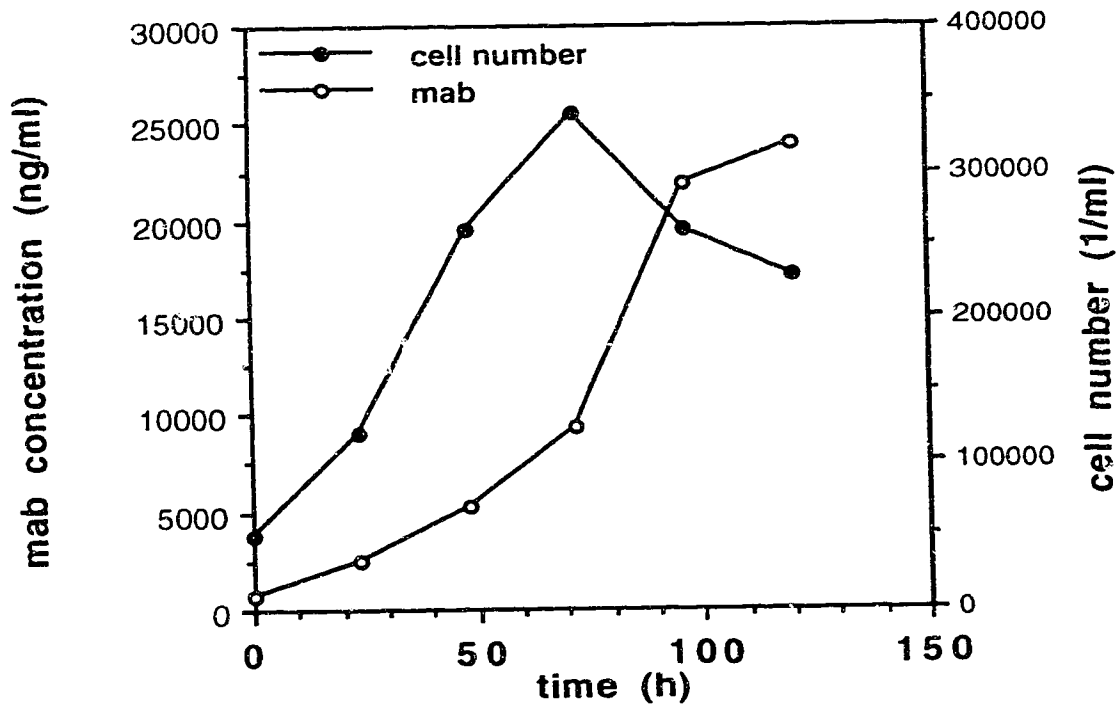

Figure 24. Viable cell density and monoclonal antibody concentration during shift in temperature from $T=37^{\circ}\text{C}$ to $T=34^{\circ}\text{C}$. Shift at $t=72$ h.

effect of temperature as a means of improving production. In non-agitated cultures, cells were grown at 37°C to late log phase at 72 h, after which the temperature was decreased to 34°C, causing the maximum specific growth rate to drop from 0.032 to 0.022 h⁻¹. As can be seen from Figure 24 this procedure did not result in enhanced production. The maximum cell density was 3.5 10⁵ cells/mL and final antibody concentration reached 24 mg/mL. No extra increase in antibody production was observed after 72 h in comparison with both runs at 34 and 37°C. This result was consistent with the observation that specific antibody production rate was not growth associated. It also agreed with the observation that optimal temperature for both growth and antibody production are equal for the S4B6 hybridoma.

CHAPTER 5

SUMMARY AND CONCLUSIONS

The effects of temperature on the hybridoma S4B6 were studied in the range 34 to 39°C. The results indicate that temperature is an important factor in hybridoma cultivation.

In non-agitated cultures, both cell density and monoclonal antibody yield were highest at 37°C. In agitated cultures the highest cell densities were measured at 34°C, maximum monoclonal antibody yield occurred at both 34 and 37°C. At 39°C no growth was observed. Hence, the optimum temperatures for growth and antibody yield were equal.

Maximal cell densities in non-agitated cultures were 20% higher than in agitated cultures. However monoclonal antibody formation was up to 20% higher in agitated cultures.

The effect of temperature on the cell cycle throughout a batch culture was demonstrated using flow cytometry. Lower temperatures caused the fraction of cells in G₁-phase to increase. Thus temperature had an effect on the arresting of cells in G₁-phase, however, no positive correlation of G₁-phase length with specific antibody production was observed, as suggested by previous investigators. The mechanism that causes cells to arrest in the G₁-phase appears to be important.

Two non-growth associated relations for antibody production were tested, one incorporating synthesis in G₁-phase, the other not discriminating between different phases. Both equations described the production of monoclonal antibody adequately and quantitatively no distinction could be

made between them. The specific antibody production rate was found to be constant throughout batch experiments under both agitated and non-agitated conditions. Temperature affected the specific antibody production rate only slightly. The effect of temperature was primarily on cell growth and the maintained viable cell concentration, and therefore indirectly on monoclonal antibody yield.

It is not expected that an optimal temperature profile will benefit the production of S4E6 antibody. The optimal temperature for both cell growth and antibody formation appeared to be identical. A temperature shift from 37°C to 34°C was imposed upon a batch culture to test the arresting effect of temperature on antibody production. No enhancement of production was observed.

The analytical methods applied in this study proved to be reproducible. The ELISA method worked quickly and accurately and the results were compatible with the results from the MTT bioassay. This result indicated that the formed antibody was not susceptible to degradation into heavy and light chains, and that the antibody, formed in the period of constant- or decreasing cell mass, was indeed active antibody. The bioactivity was not dependent on temperature.

The S4B6 hybridoma appeared to reach low cell densities compared to other hybridoma lines reported in the literature. The medium constituent concentrations, pH and oxygen supply were shown not to be growth limiting. Waste product secretion or limitation of some unknown factor could be a reason. Identification of the growth limiting factor requires further investigation.

The observations made in this study and comparison with literature data indicate that the biological differences between different hybridoma cell lines should be an important consideration in the scale-up of monoclonal antibody production.

REFERENCES

- Abu-Reesh, I. and F. Kargi. 1989. Biological responses of hybridoma cells to defined hydrodynamic shear stress. J. Biotechnol. 9: 167-178.
- Al-Rubeai, M., S.K.W. Oh, R. Musareb and A.N. Emery. 1990. Modified cellular metabolism in hybridomas subjected to hydrodynamic and other stresses. Biotechnol. Lett. 12: 323-328.
- Al-Rubeai, M., A.N. Emery and S. Chalder. 1991. Flow cytometric study of cultured mammalian cells. J. Biotechnol. 19: 67-82.
- Alberts, B., D. Bray, J. Lewis, M. Raff, K. Roberts, J.D. Watson. 1983. Molecular biology of the cell. pp 611-618.
- Anonymous. 1988. Guidelines on the production and quality control of monoclonal antibodies of murine origin intended for use in man. 1988. Trends in Biotechnol. 6: 65-68.
- Anonymous. 1990. Society for Industrial Microbiology. SIM News 40: 226-227.
- Anderson, W.R. and J.R. Birch. 1986. Large-scale cell culture in biotechnology. Science 232: 1390-1395.
- Augenstein, D.C., A.J. Sinskey and D.I.C. Wang. 1971. Effect of shear on the death of two strains of mammalian tissue cells. Biotechnol. Bioeng. 13: 409-418.
- Bailey, C.M. and H. Nicholson. 1990. Optimal temperature control for a structured model of plant cell culture. Biotechnol. Bioeng. 35: 252-259.
- Bailey, J.E. and D.F. Ollis. 1986. Biochemical Engineering Fundamentals 2nd ed. McGraw-Hill, New York. pp 704-717.
- Batt, B.C. and D.S. Kompola. 1989. A structured kinetic modelling framework for the dynamics of hybridoma growth and monoclonal antibody production in continuous suspension cultures. Biotechnol. Bioeng. 34: 515-531.
- Birch, J.R. and T. Cartwright. 1982. Environmental factors influencing the growth of animal cells in culture. J. Chem. Technol. Biotechnol. 32: 313-317.

- Birch, J.R., P.W. Thompson, K. Lambert, R. Boraston. 1984. The large scale cultivation of hybridoma cells producing monoclonal antibodies. In: Large scale mammalian cell culture, J. Feder and W.R. Tolbert eds., Academic Press, New York. pp 1.
- Birch, J.R., L. Wood and R. Boraston. 1985. Bulk production of monoclonal antibodies in fermenters. Trends in Biotechnol. 3: 162-166.
- Bliem, R. and H. Katinger. 1988a. scale-up engineering in animal cell technology: Part I. Trends in Biotechnol. 6: 190-195.
- Bliem, R. and H. Katinger. 1988b. scale-up engineering in animal cell technology: Part II. Trends in Biotechnol. 6: 224-230.
- Boraston, R., Birch, J.R., P.W. Thompson and S. Garland. 1984. Growth and oxygen requirements of antibody producing mouse hybridoma cells in suspension culture Develop. Biol. Standard. 55: 103-111.
- Butler, M. and H. Jenkins. 1989. Nutritional aspects of the growth of animal cells in culture. J. Biotechnol. 12: 97-110.
- Burton, D.R. 1991. Human and mouse monoclonal antibodies by repertoire cloning. Trends in Biotechnol. 9:169-174.
- Cathy, D. 1988. Antibodies Volume 1: A practical approach. IRI Press Oxford.
- Constantidines, A., J.L. Spencer and E.L. Gaden. 1970. Optimization of batch fermentation processes II. Optimum temperature profiles for batch penicillin fermentations. Biotechnol. Bioeng. 12: pp 1081
- Croughan, M.S., E.S. Sayre and D.I.C. Wang. 1989. Viscous reduction of turbulent damage in animal cell culture. Biotechnol. Bioeng. 33: 862-872.
- Dalili, M. and D.F. Ollis. 1989. Transient kinetics of hybridoma growth and monoclonal antibody production in serum limited cultures. Biotechnol. Bioeng. 33: 984-990.
- Dalili, M. and D.F. Ollis. 1990. A flow cytometric analysis of hybridoma growth and monoclonal antibody production. Biotechnol. Bioeng. 36: 64-73.
- Dean, R.C., S.B. Karkare, N.G. Ray, N.G. Rustadler and K.Verskatasubramanian. 1988. In: Bioreactor immobilized enzymes and cells. Ed. M. Moo-Young. Elsevier applied science, Essex, England, pp 125.

- Doyle, C. and M. Butler. 1990. The effect of pH on the toxicity of ammonia to a murine hybridoma. J. Biotechnol. 15: 91-100.
- Eisen, H.N. 1990. General Immunology, 3rd ed. Lipincott, pp 7.
- Enger, M.D. and R.A. Tobey. 1972. Biochemistry. 11: pp 269.
- Feder, J. and W.R. Tolbert. 1983. The large scale cultivation of mammalian cells. Scientific American 248: pp 36.
- Fleischaker, R.J. and A.J. Sinskey. 1981. Oxygen demand and supply in cell culture. Eur. J. Appl. Biotechnol. 12: 193-197.
- Freshney, R.I. 1987. Culture of animal cells: A manual of basic techniques, 2nd ed. Alan R. Liss, New York.
- Gardner, A.R., J.L. Gainer and D.J. Kirwan. 1990. Effects of stirring and sparging on cultured hybridoma cells. Biotechnol. Bioeng. 35: 940-947.
- Gatz, R.L., B.A. Young, T.F. Facklam and D.A. Scantland. 1983. Monoclonal antibodies: emerging product concepts for agriculture and food. Biotechnol. 1: 337-341.
- Glacken, M.W., R.J. Fleischaker and A.J. Sinskey. 1983. Large-scale production of mammalian cells and their products: engineering principles and barriers to scale up. Ann. N.Y. Acad. Sci. 113: 355-371.
- Glacken, M.W., R.J. Fleischaker and A.J. Sinskey. 1986. Reduction of waste product secretion via nutrient control: possible strategies for maximizing product and cell yields on serum in cultures of mammalian cells. Biotechnol. Bioeng. 28: 1376-1389.
- Glacken, M.W. 1988. Catabolic control of mammalian cell culture. Biotechnol. 6: 1041-1050.
- Glacken, M.W., C. Huang and A.J. Sinskey. 1989. Mathematical description of hybridoma culture kinetics III. Simulation of fed-batch reactors. J. Biotechnol. 10: 39-66.
- Goochee, C.F. and T. Monica. 1990. Environmental effects on protein glycosylation. Biotechnol. 8: 421-427.
- Griffiths, J.B. and P.A. Riley. 1985. Cell biology: basic concepts. In: Animal cell biotechnology vol.1. R.E. Spier and J.B. Griffiths eds., Academic Press, London, pp 17-48.

- Handa-Corrigan, A. 1988. Large-scale in vitro hybridoma culture: current status. Biotechnol. 6: 784-786.
- Handa-Corrigan, A, A.N. Emery and R.E. Spier. 1989. Effect of gas-liquid interfaces on the growth of suspended mammalian cells: mechanisms of cell damage by bubbles. Enz. Microb. Technol. 11: 230-235.
- Harbour, C., J.P. Barford and K.S. Low. 1987. Process development for hybridoma cells. Adv. Biochem. Eng. Biotechnol. 37: 1-40.
- Harbour, C., K.S. Low, C.P. Marquis and J.P. Barford. 1989. pH control options for hybridoma cultures. Biotechnol. Techniques 3: 73-78.
- Hortascu, A. and D.D.Y Ryu. 1990. Optimal temperature control policy for a two-stage recombinant fermentation process. Biotechnol. prog. 6: 403-407.
- Jo, E.U., H.J. Park, J.M. Park and K.H. Kim. 1990. Balanced nutrient fortification enables high density hybridoma cell culture in batch culture. Biotechnol. Bioeng. 36: 717-722.
- Katinger, M. and Scheier, W. 1985. In: Animal cell biotechnology vol.1, R.E. Spier and J.B. Griffiths eds. Academic Press, London. pp 167.
- Kelly, R.B. 1985. Science 230: pp 25.
- Khosla, C., J.E. Curtis, P. Bydalek, J.R. Schwatz and J.E. Bailey. 1990. Expression of recombinant proteins in *E. coli* using an oxygen responsive promoter. Biotechnol. 8: 554-558
- Köhler, G. and Milstein, C. 1975. Continuous cultures of fused cells secreting antibody of predefined specificity. Nature 256: 495-497.
- Lambert, K.J., R. Boraston, P.W. Thompson and J.R. Birch. 1987. Production of monoclonal antibodies using large scale cell culture. In: Developments in industrial microbiology, vol. 27, pp 101-106.
- Lebherz, W.B. 1987. Batch production of monoclonal antibodies by large scale suspension culture. In: S.S. Seaver ed., Commercial production of monoclonal antibodies. Marcel Dekker Inc., New York.
- Leist, C.H., H.P. Meyer and A. Fiechter. 1990. Potential and problems of animal cells in suspension culture. J. Biotechnol. 15: 1-46.

- Lloyd, D., R.K. Poole and S.W Edwards. 1982. The cell division cycle. Temporal organization and control of cellular growth and reproduction. Academic Press, New York.
- Luan, Y.T., R. Mutharasan and W.E. Magee. 1987. Effects of various glucose/glutamine ratios on hybridoma growth, viability and monoclonal antibody formation. Biotechnol. Lett. 9: 535-538.
- Mano, T., T.Kimura, S. Iijima, K. Takahashi, H.Takeuchi and T. Kobayashi. 1990. Comparison of oxygen supply methods for cultures of shear-stress sensitive organisms including animal cell culture. J. Chem. Tech. Biotechnol. 44: 259-271.
- Merten, O.W. 1987. Concentrating mammalian cells. I. Large-scale animal cell culture. Trends Biotechnol. 5: 230-237.
- Merten, O.W., S. Reiter and H. Katinger. 1984. Stabilizing effect of reduced cultivation temperature on human-mouse hybridomas. Develop. biol. standard. 60: 509-512.
- Miller, W.M., C.R. Wilke and H.W. Blanch. 1989a. Transient responses of hybridoma cells to nutrient additions in continuous culture: I. Glucose pulse and step changes. Biotechnol. Bioeng. 33: 477-486.
- Miller, W.M., C.R. Wilke and H.W. Blanch. 1989b. Transient responses of hybridoma cells to nutrient additions in continuous culture: II. Glutamine pulse and step changes. Biotechnol. Bioeng. 33: 487-499.
- Miller, W.M., C.R. Wilke and H.W. Blanch. 1987. Effects of dissolved oxygen concentration on hybridoma growth and metabolism in continuous culture. J. Cell. Physiol. 132: 524-530.
- Miller, W.M., C.R. Wilke and H.W. Blanch. 1986. Kinetic analysis of hybridoma growth in continuous suspension culture. ACS Natl. Meeting, september 11, 1986.
- Miller, W.M., C.R. Wilke and H.W. Blanch. 1988. Biotechnol.Bioeng. 32: 947-
- Miller, D. Heat shock proteins to the rescue. 1989. New Scientist, April, pp 47.
- Mizrahi, A. 1986. Production of biologicals from animal cells- an overview. Process biochemistry: 108-112.

- Mosmann, T.R., H. Cherwinski, M.W. Bond, M.A. Giedlin and R.L. Coffman. 1986. Two types of murine helper T cell clone. I. Definition according to lymphokine activities and secreted protein. J. Immunol. 136: pp 2348.
- Mosmann, T.R. and T.A.T. Fong. 1989. Specific assays for cytokine production by T-cells. J. Immunol. Meth. 116: pp 151.
- Oh, S.K.W., A.W. Nienow, M. Al-Rubeai and A.N. Emery. 1989. The effects of agitation intensity with and without continuous sparging on the growth and antibody production of hybridoma cells. J. Biotechnol. 12: 45-62.
- Ozturk, S.S. and B.O. Palsson. 1990. Effects of dissolved oxygen on hybridoma growth, metabolism, and antibody production kinetics in continuous culture. Biotechnol. prog. 6: 437-446.
- Ozturk, S.S. and B.O. Palsson. 1991a. Physiological changes during the adaptation of hybridoma cells to low serum and serum-free media. Biotechnol. Bioeng. 37: 35-46.
- Ozturk, S.S. and B.O. Palsson. 1991b. Effect of medium osmolarity on hybridoma growth, metabolism and antibody production. Biotechnol. Bioeng. 37: 989-993.
- Passini, C.A. and C.F. Gouchee. 1989. Response of a mouse hybridoma cell line to heat shock, agitation and sparging. Biotechnol. prog. 5: 175-188.
- Perry, R.H. and Chilton, C.H. 1973. Chemical Engineers' Handbook 5th ed. p 3-225.
- Petersen, J.F., L.V. McIntire and E.T. Papoutsakis. 1990. Shear sensitivity of hybridoma cells in batch, fed-batch and continuous cultures. Biotechnol. prog. 6: 114-120.
- Pollard, R and B. Khosrovi. 1978. Reactor design for fermentation of fragile tissue cells. Process biochemistry, may, pp 31.
- Posillico, E.G., M.S. Kallelis and J.M. George. 1987. Large-scale production and purification of monoclonal antibodies using cellular microencapsulation. In: S.S. Seaver ed., Commercial production of monoclonal antibodies. Marcel Dekker Inc., New York.
- Pringle, J.R. and J.R. Mor. 1975. Monitoring the growth of yeast cultures. In: D.M. Prescott ed., Methods in cell biology, vol.11. Ac. Press, New-York, pp 153.

- Prokop, A. and M.Z. Rozenberg. 1989. Bioreactor for mammalian cell culture. In: A. Fiechter, ed., Adv. Biochem. Eng. Biotechnol. 39: 29-67.
- Pryme, I.F., O. Garatun-Tjelsto, J.K. Weltman and R.M. Dowben. 1976. J. Cell. Biol. 68: pp 232.
- Putnam, J.E. 1987. Monoclonal antibody production in a ceramic matrix. In: S.S. Seaver, ed., Commercial production of monoclonal antibodies. Marcel Dekker Inc., New York.
- Ramirez, O.T. and R. Mutharasan. 1990a. The role of the plasma membrane fluidity on shear sensitivity of hybridomas grown under hydrodynamic stress. Biotechnol. Bioeng. 36: 911-920.
- Ramirez, O.T. and R. Mutharasan. 1990b. Cell cycle- and growth phase-dependent variations in size distribution, antibody productivity, and oxygen demand in hybridoma cultures. Biotechnol. Bioeng. 36: 839-848.
- Randerson, D.H. 1985. Large-scale cultivation of hybridoma cells. J. Biotechnol. 2: 241-255.
- Ratafia, M. 1987. Mammalian cell culture: worldwide activities and markets. Biotechnol. 5: 692-694.
- Ray, N.G., S.B. Karkare and P.W. Runstadler. 1989. Cultivation of hybridoma cells in continuous cultures: kinetics of growth and product formation. Biotechnol. Bioeng. 33: 724-730.
- Reuveny, S., D. Velez, J.D. Macmillan and L. Miller. 1986a. Factors affecting cell growth and monoclonal antibody production in stirred reactors. J. Immunol. meth. 86: 53-59.
- Reuveny, S., D. Velez, L. Miller and J.D. Macmillan. 1986b. Comparison of cell propagation methods for their effect on monoclonal antibody yield in fermenters. J. Immunol. meth. 86: 61-69.
- Reuveny, S., D. Velez, J.D. Macmillan and L. Miller. 1987. Factors affecting cell growth and monoclonal antibody production in culture. Develop. biol. standard. 66: 169-175.
- Roels, J.A. 1983. Energetics and kinetics in biotechnology. Elsevier Biomedical, Amsterdam.
- Roitt, I., J. Brostoff and D. Male. 1989. Immunology 2nd ed. Gower Medical Publishing, London.

- Schlesinger, M.J. 1990. Heat shock proteins. J. Biol. chem. 265: 12111-12114.
- Schliermann, M., C. Beckers and H.G. Miltenburger. 1987. Cell cycle analysis by flow cytometry in an antibody secreting cell line. Develop. biol. standard. 66: 101-109.
- Schmid, G., H.W. Blanch and C.R. Wilke. 1990. Hybridoma growth, metabolism and product formation in HEPES-buffered medium: II. Effect of pH. J. Biotechnol. 12: pp 633.
- Seaver, S. 1991. An industrial cell biologist's wish list. Can. J. Chem. Eng. 69: 403-408.
- Shapiro, H.M. 1985. Practical flow cytometry. Alan R. Liss, New York. pp 129-142.
- Sikora, K. and H.M. Smedley. 1985. Monoclonal antibodies. Blackwell, New York.
- Sonnleiter, B. and O. Kappel. 1986. Growth of *S. cerevisiae* is controlled by its limited respiratory capacity. Biotechnol. Bioeng. 28: 927-937.
- Spier, R. 1988. Animal cells in culture: moving into the exponential phase. Trends Biotechnol. 6: 2-6.
- Spier, R.E. and M.W. Fowler. 1985. Animal and plant cell cultures. In: M. Moo-Young, Comprehensive Biotechnology vol. 1. pp 301-327.
- Spier, R.E. and Griffiths. 1984. An examination of the data and concepts germane to the oxygenation of cultured animal cells. Develop. biol. standard. 55: 81-92.
- Sureshkumar, G.K. and R. Mutharasan. 1991. The influence of temperature on a mouse-mouse hybridoma growth and monoclonal antibody production. Biotechnol. Bioeng. 37: 292-295.
- Suzuki, E. and D.F. Ollis. 1989. Cell cycle model for antibody production kinetics. Biotechnol. Bioeng. 34: 1398-1402.
- Suzuki, E. and D.F. Ollis. 1990. Enhanced antibody production at slowed growth rates: experimental demonstration and a simple structured model. Biotechnol. prog. 6: 231-236.
- Taya, M., T. Mano and T. Kobayashi. 1986. Kinetic expression for human cell growth in a suspension culture system. J. Ferment. Technol. 64: 347-350.

- Thayer, A.M. 1991. Biopharmaceuticals overcoming market hurdles. Chem. Eng. news, february, 1991. pp 27-48.
- Tolbert, W.R., C. Lewis, P.J. White and J. Feder. 1985. Perfusion culture systems for the production of mammalian cell biomolecules. In: W.R. Tolbert and J. Feder, eds. Large-scale mammalian cell culture. Academic Press, New York.
- Tramper, J. and J.M. Vlak. 1988. Bioreactor design for growth of shear-sensitive mammalian and insect cells. In: Upstream processes: equipment and techniques. Alan R. Liss Inc. New York. pp 199-228.
- Tyo, M.A. and R.E. Spier. 1987. Dense cultures of animal cells at the industrial scale. Enz. Microb. Technol. 9: 514-520.
- Vanoni, M., M. Vai and G. Frascotti. 1984. Effects of temperature on the yeast cell cycle analyzed by flow cytometry. Cytometry 5: 530-533.
- Wedel, R.J. von. 1987. Mass culture of mouse and human hybridoma cells in hollow-fiber culture. In: S.S. Seaver ed. Commercial production of monoclonal antibodies. Marcel Dekker Inc., New York.
- Williams, L.S., R.A. Richieri, J.A. Nordberg and P.C. Chau. 1990. Cell cycle analysis with bromo-deoxyuridine pulse-labelling in asynchronous hybridoma cultures. Biotechnol. Techn. 4: 95-100.
- Wohlpert, D., D. Kirwan and J. Gainer. 1990. Effects of cell density and glucose and glutamine levels on the respiration rates of hybridoma cells. Biotechnol. Bioeng. 36: 630-635.

APPENDIX 1

FORTIFIED MEDIA FORMULATION

1. RPMI-1640, 5X fortified, salt reduction 33%

The recipe cuts all RPMI-1640 salts by 33%.

RPMI-1640 (Sigma, R 6504) powdered media for 1 litre. MQ-water. Add 3 g NaHCO₃ (Sigma, S 5761), 120 mL Fetai Bovine Serum (Jackson), 1.5 mL 2-mercaptoethanol (1:1000 stock, Sigma, M 7522). Final volume 1.5 L.

Per 200 mL include: - 8.7 mL 100X RPMI-1640 vitamins (Sigma, R 7256)
- 17.4 mL 50X Amino Acids (Sigma, R 7131)
- Glutathione, 0.9 mg (Sigma, G 2140)
- L-Glutamine, 260 mg (Sigma, G 5763)
- Glucose, 1.73 g (Sigma, G 8769)

2. RPMI-1640, 5X fortified, salt reduction 16%.

The recipe cuts all RPMI-1640 salts by 16%.

RPMI-1640 (Sigma, R 6504) powdered media for 1 litre. MQ-water. Add 2.4 g NaHCO₃ (Sigma, S 5761), 120 mL Fetal Bovine Serum (Jackson), 1.2 mL 2-mercaptoethanol (1:1000 stock, Sigma, M 7522). Final volume 1.2 L.

Per 200 mL include: - 8.3 mL 100X RPMI-1640 vitamins (Sigma, R 7256)
- 16.6 mL 50X Amino Acids (Sigma, R 7131)
- Glutathione, 0.8 mg (Sigma, G 2140)
- L-Glutamine, 250 mg (Sigma, G 5763)
- Glucose, 1.67 g (Sigma, G 8769)

3. RPMI-1640, 5X fortified, no salt reduction.

RPMI-1640 (Sigma, R 6504) powdered media for 1 litre. MQ-water. 2 g NaHCO₃ (Sigma, S 5761), 120 mL Fetal Bovine Serum (Jackson), 1 mL 2-mercaptoethanol (1:1000 stock, Sigma, M 7522). Final volume 1 L.

Per 200 mL include: - 8 mL 100X RPMI-1640 vitamins (Sigma, R 7256)
- 16 mL 50X Amino Acids (Sigma, R 7131)
- Glutathione, 0.8 mg (Sigma, G 2140)
- L-Glutamine, 240 mg (Sigma, G 5763)
- Glucose, 1.6 g (Sigma, G 8769)

APPENDIX 2

REPEATED EXPERIMENTS: AGITATED AND NON-AGITATED CULTURES OF S4B6

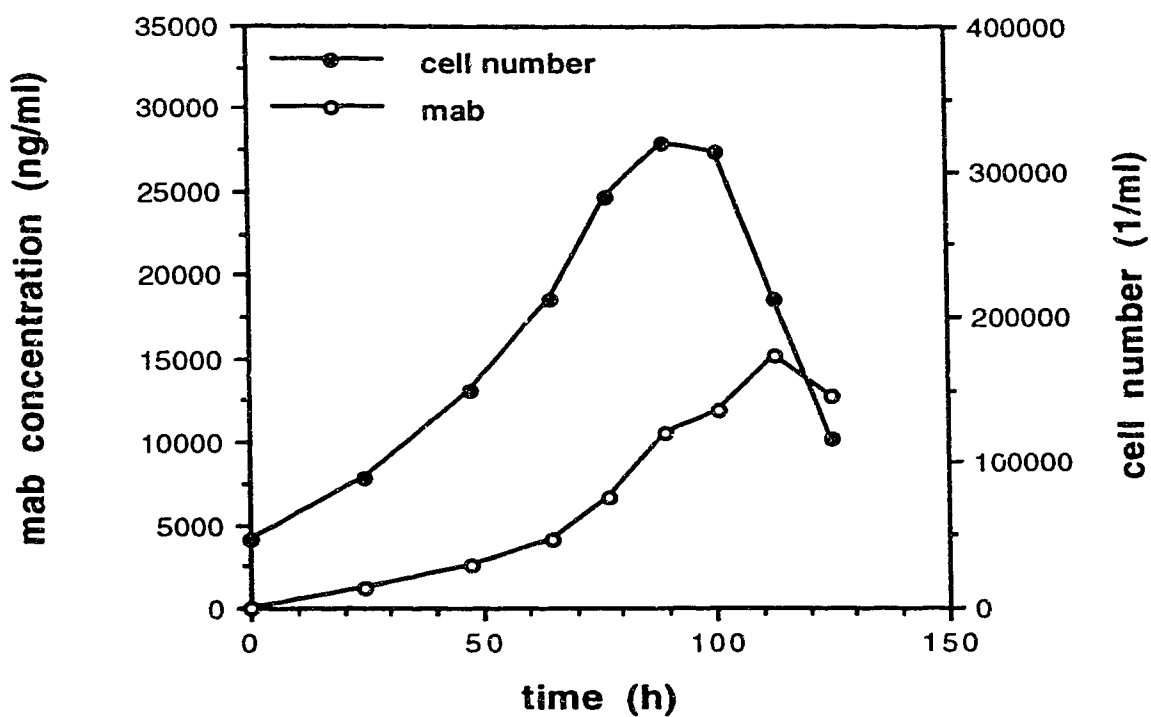

Figure A2-1. Viable cell density and monoclonal antibody concentration during non-agitated batch culture at 34°C (1). Appeared as Figure 12 in text.

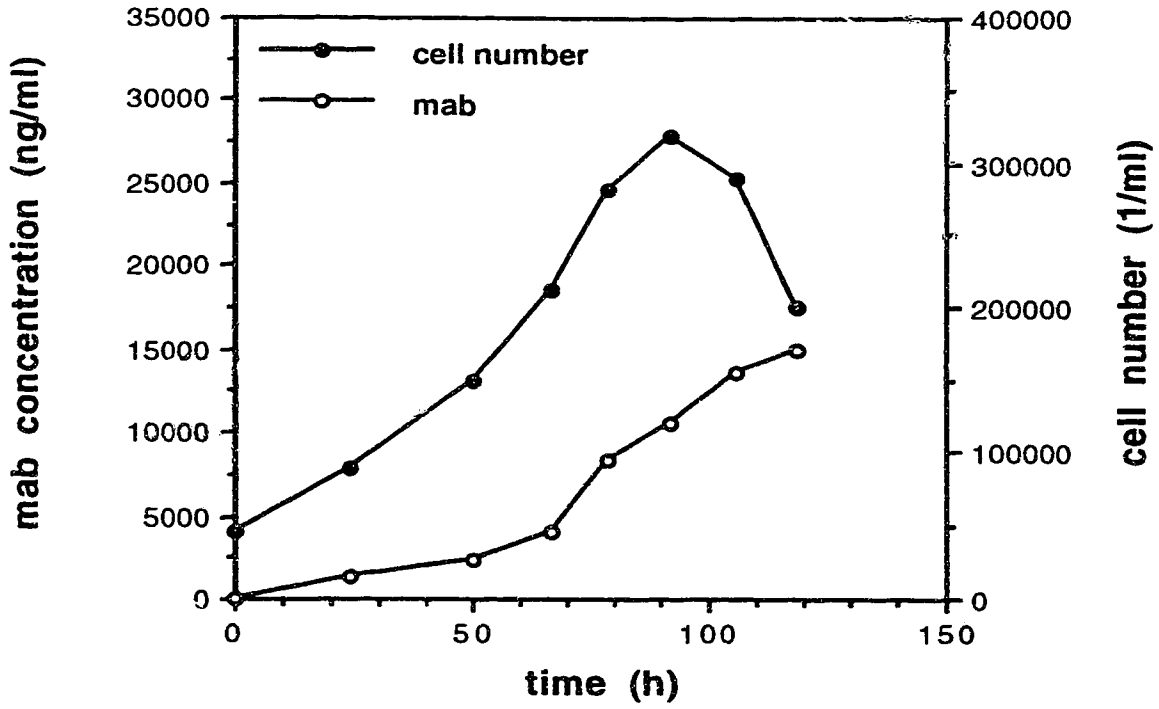

Figure A2-2. Viable cell density and monoclonal antibody concentration during non-agitated batch culture at 34°C (2).

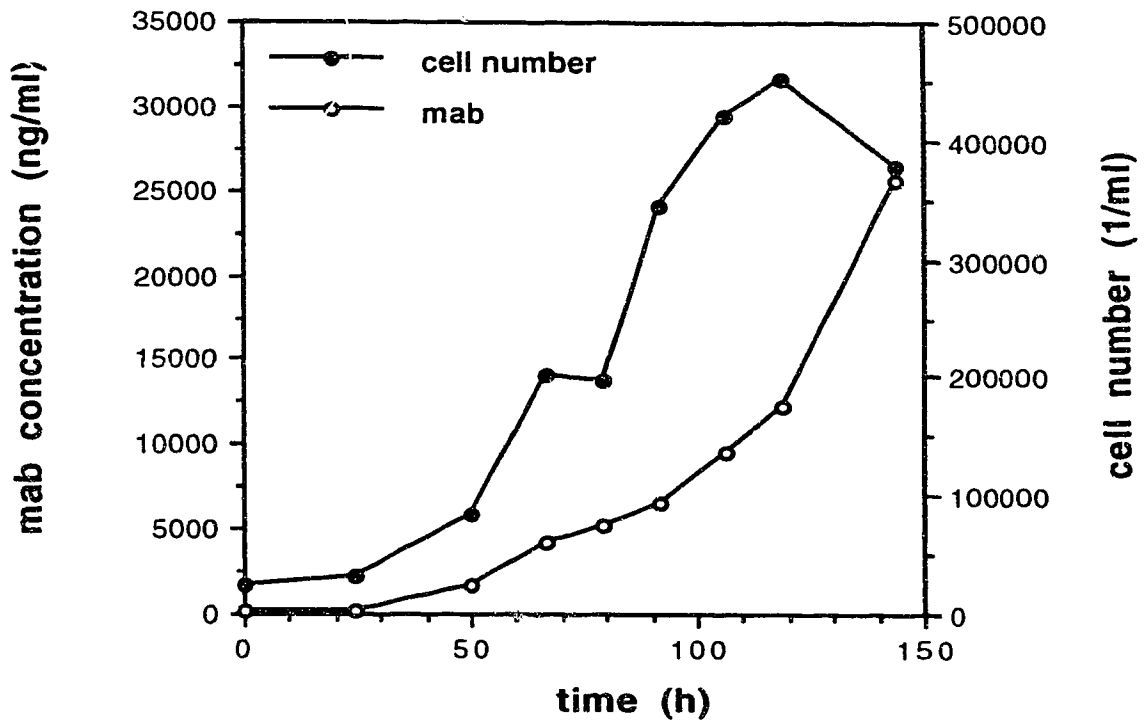

Figure A2-3. Viable cell density and monoclonal antibody concentration during non-agitated batch culture at 35°C (1). Appeared as Figure 13 in text.

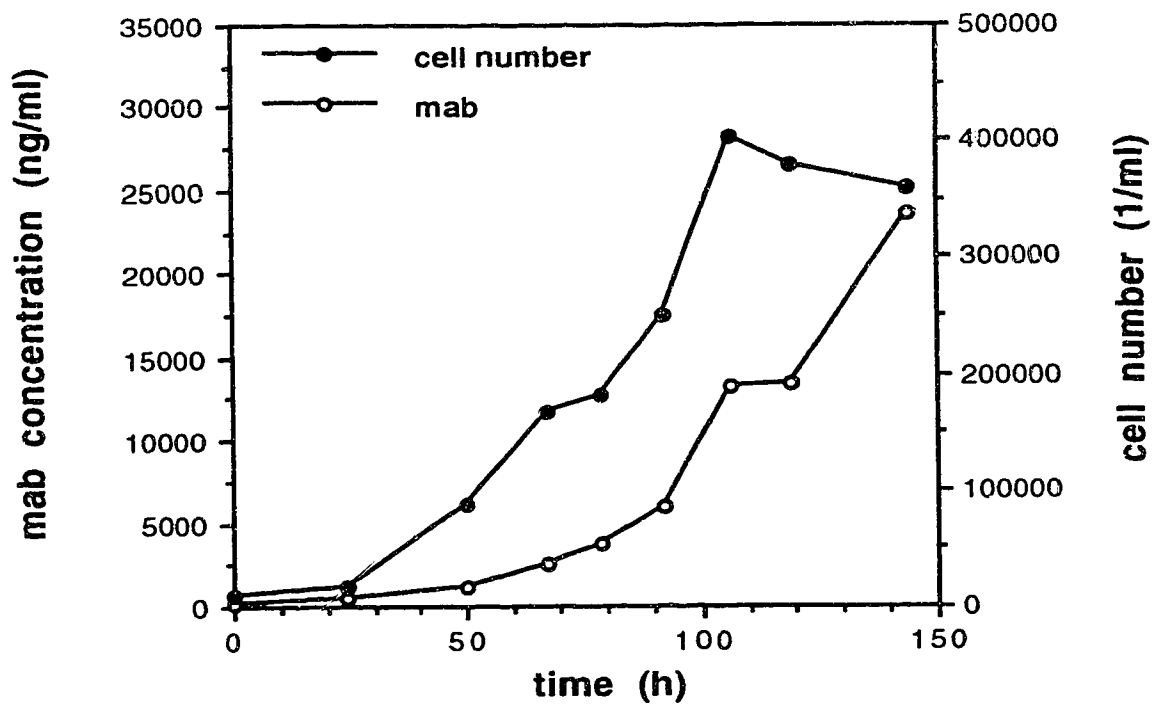

Figure A2-4. Viable cell density and monoclonal antibody concentration during non-agitated batch culture at 35°C (2).

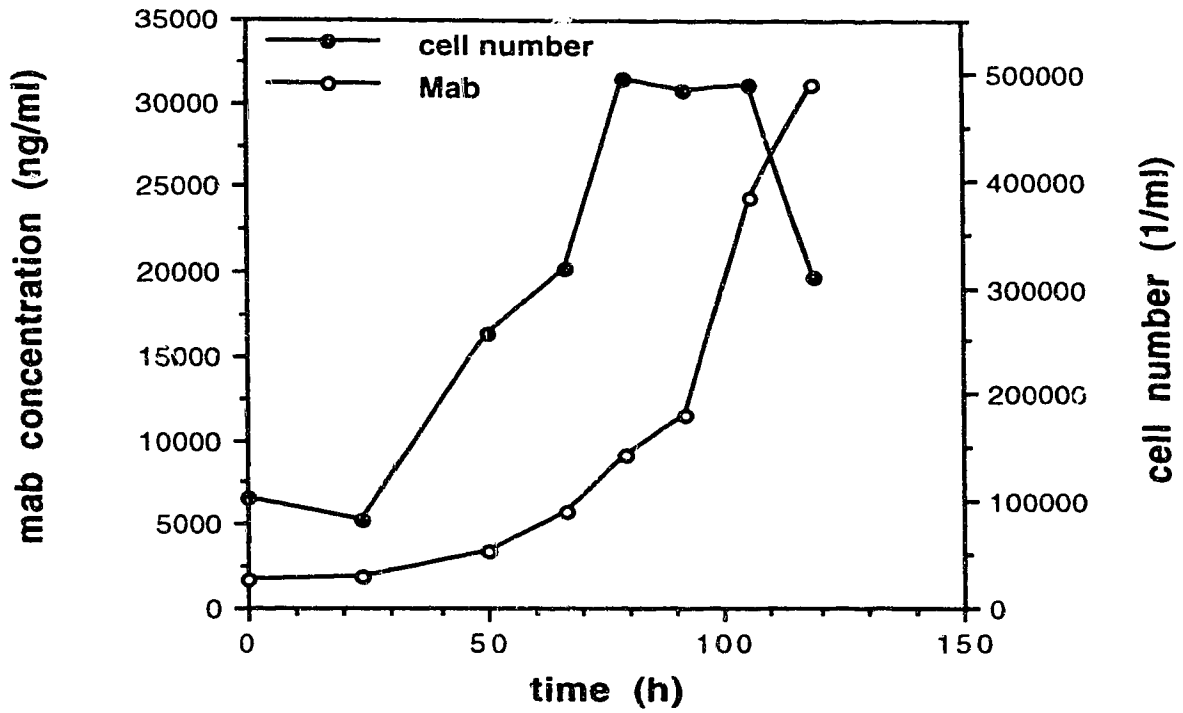

Figure A2-5. Viable cell density and monoclonal antibody concentration during non-agitated batch culture at 37°C (1). Appeared as Figure 4 in text.

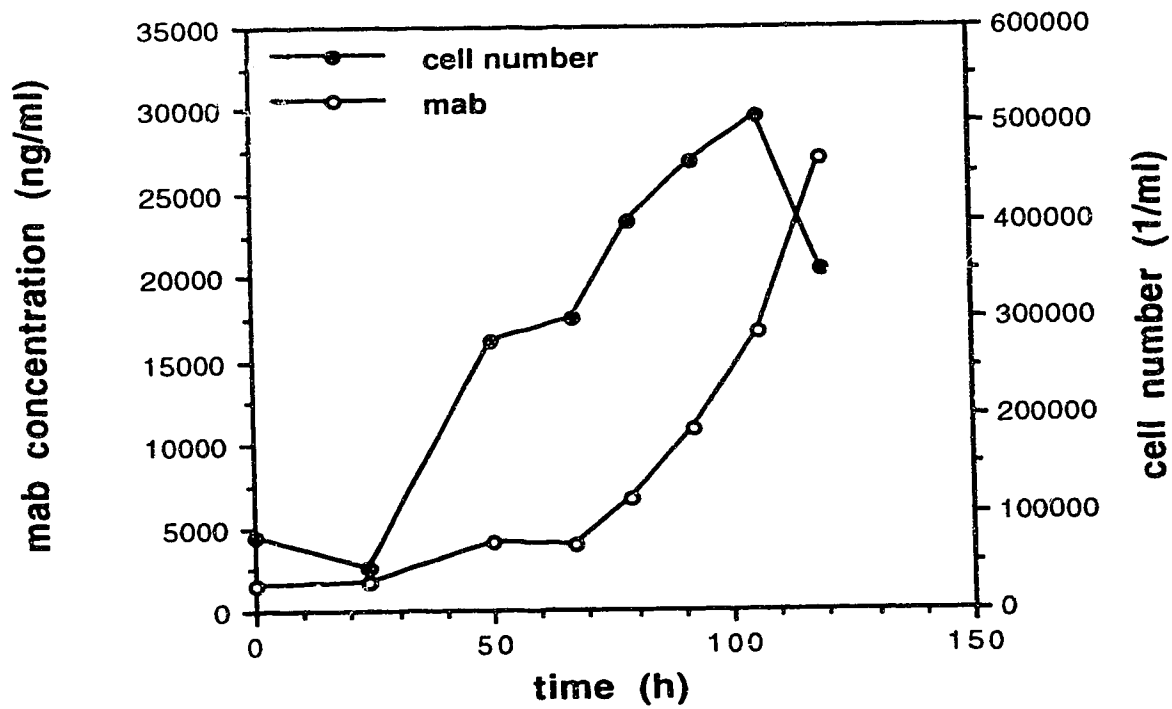

Figure A2-6. Viable cell density and monoclonal antibody concentration during non-agitated batch culture at 37°C (2).

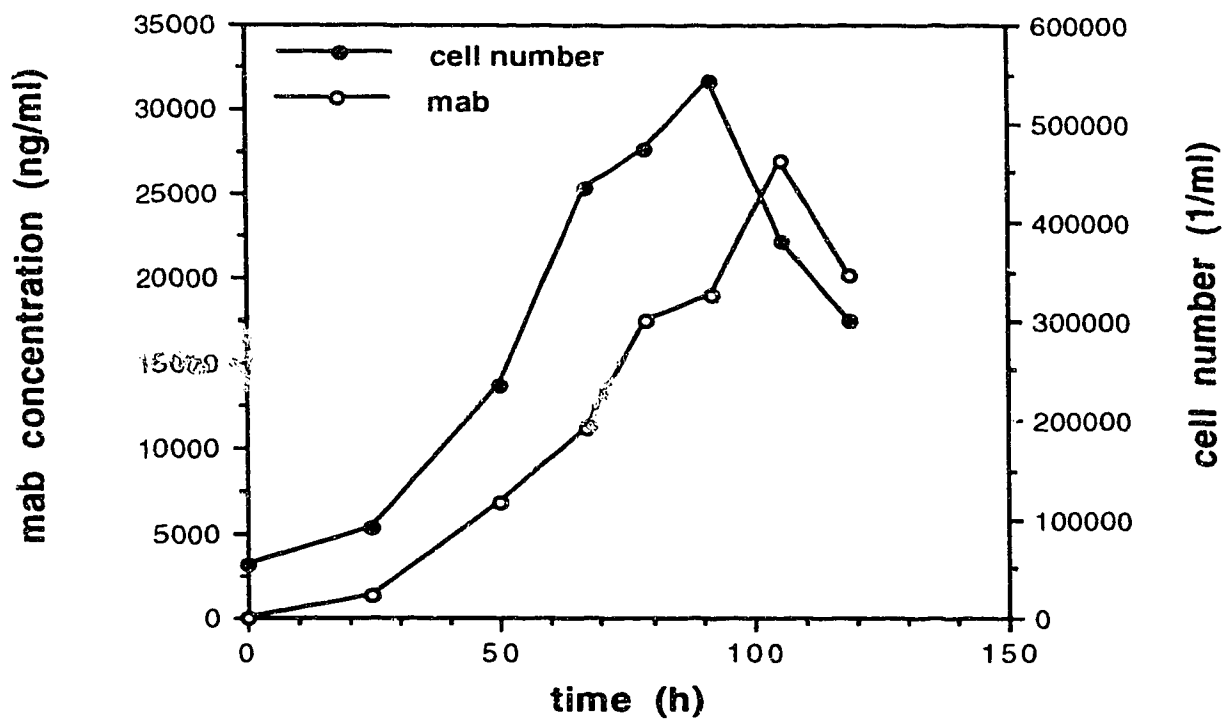

Figure A2-7. Viable cell density and monoclonal antibody concentration during non-agitated batch culture at 37°C (3).

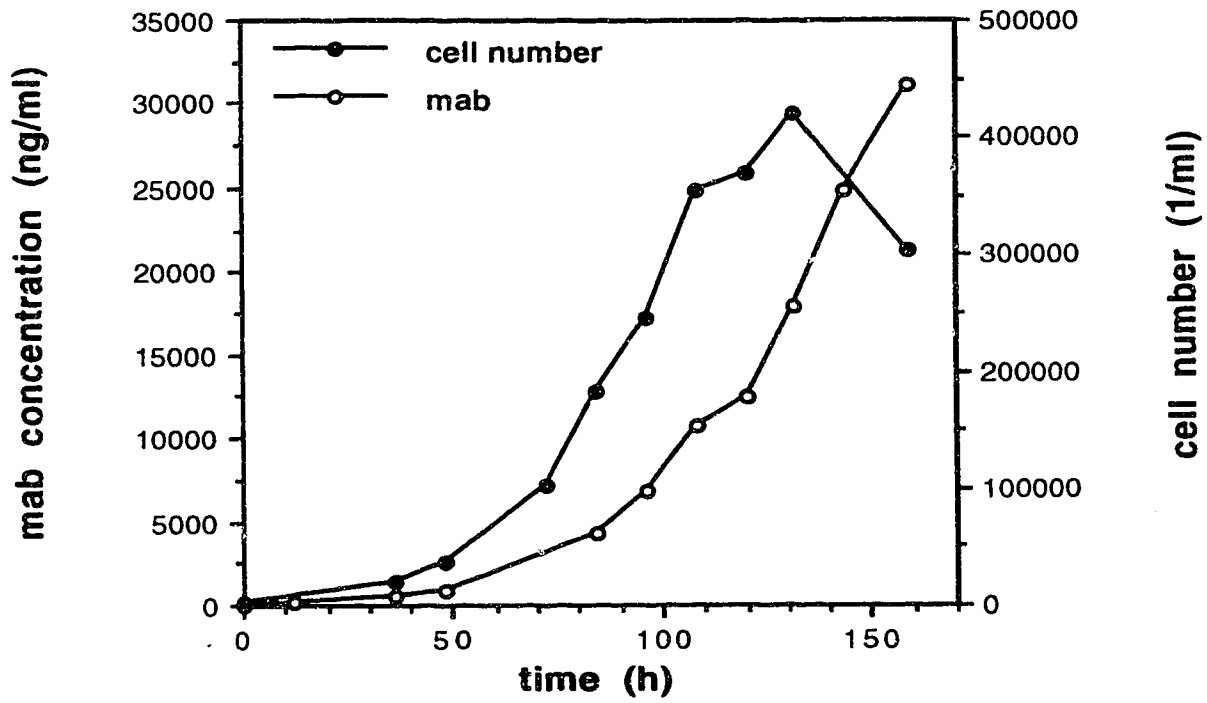

Figure A2-8. Viable cell density and monoclonal antibody concentration during non-agitated batch culture at 37°C (4).

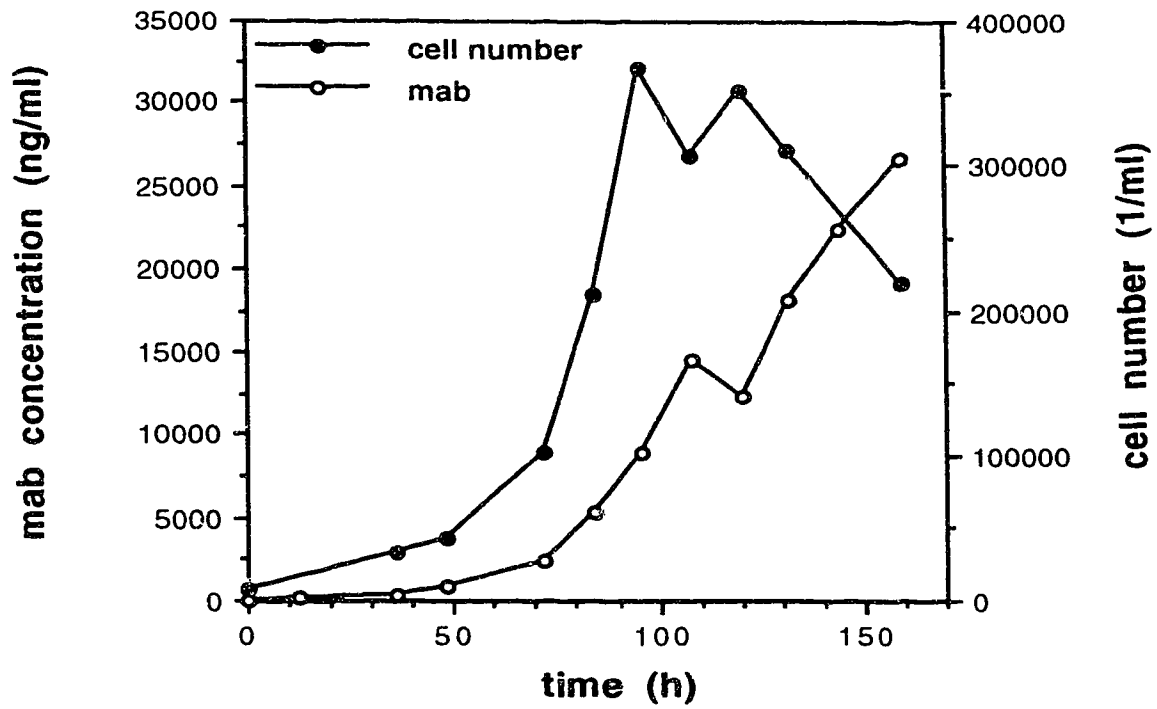

Figure A2-9. Viable cell density and monoclonal antibody concentration during non-agitated batch culture at 37°C (5).

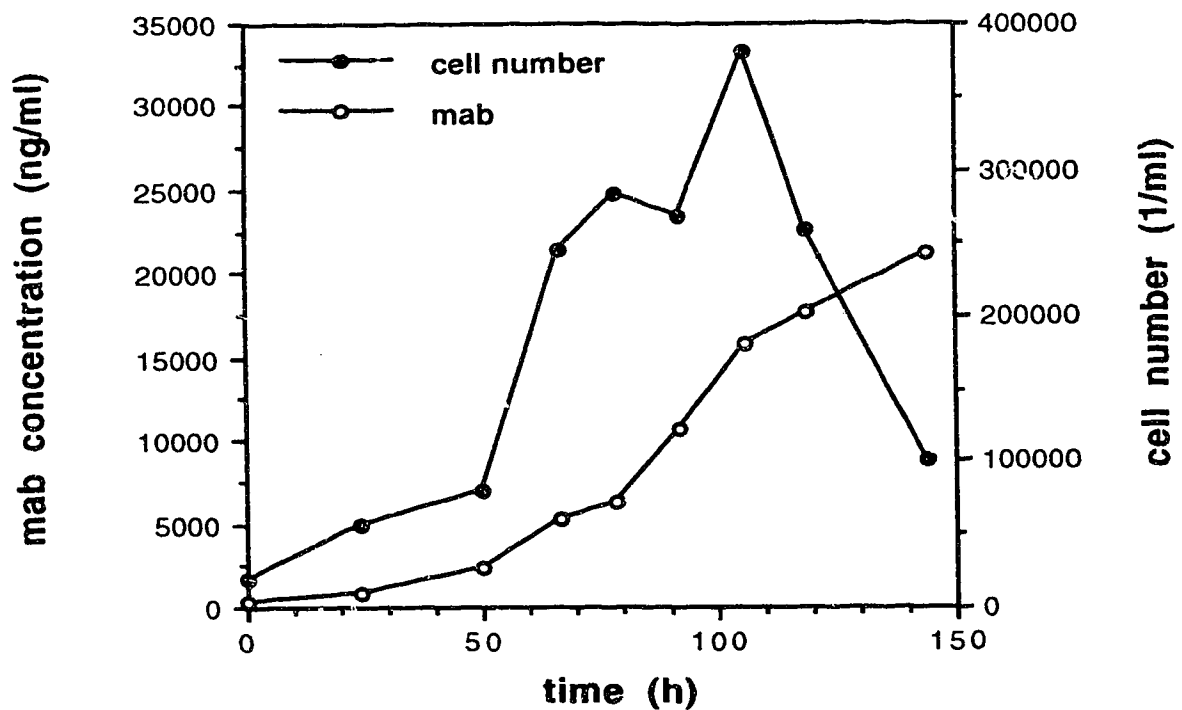

Figure A2-10. Viable cell density and monoclonal antibody concentration during non-agitated batch culture at 38°C (1). Appeared as Figure 14 in text.

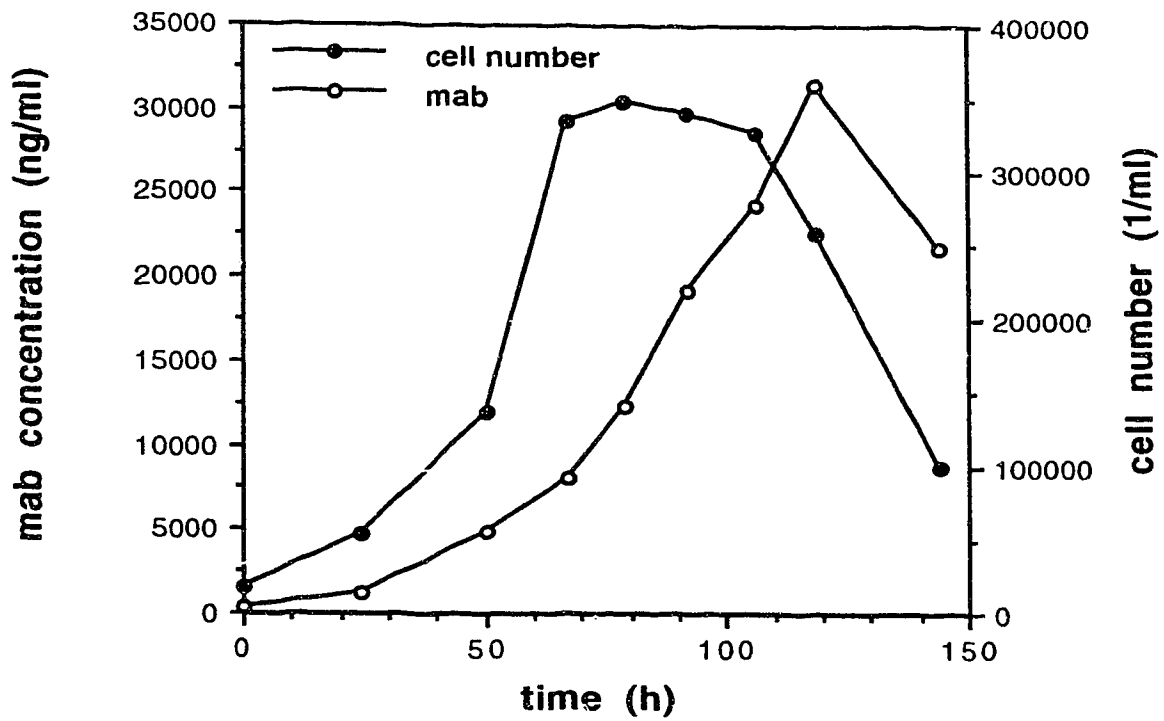

Figure A2-11. Viable cell density and monoclonal antibody concentration during non-agitated batch culture at 38°C (2).

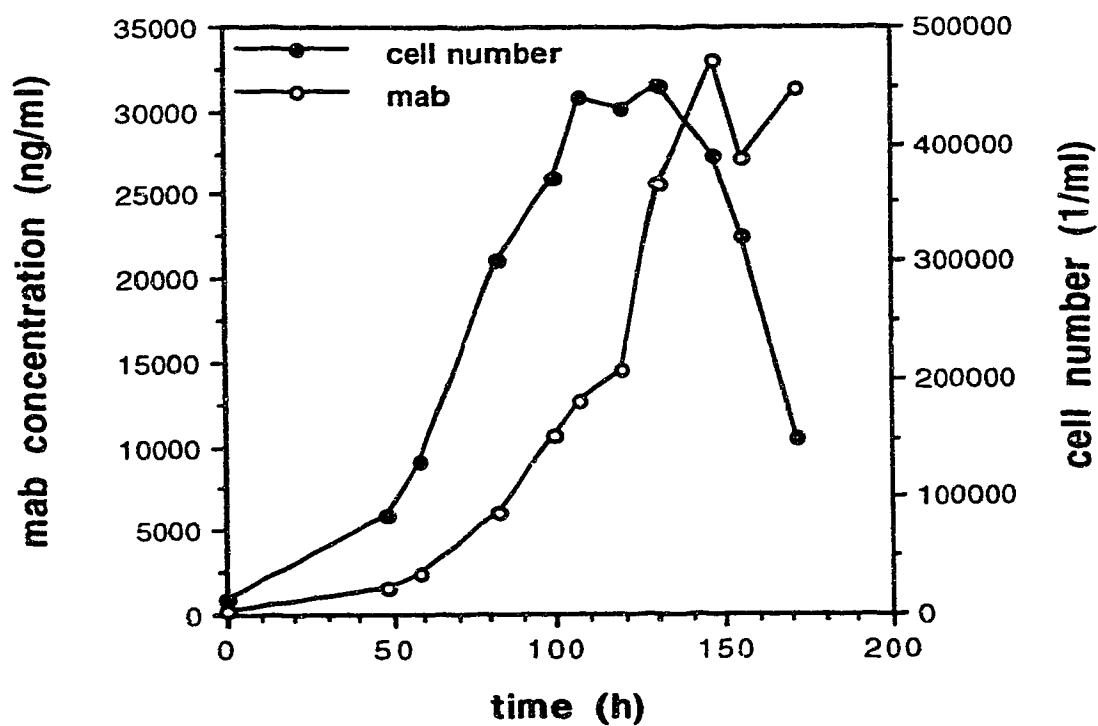

Figure A2-12. Viable cell density and monoclonal antibody concentration during batch experiment in agitated spinner flask at 34°C (1). Appeared as Figure 15 in text.

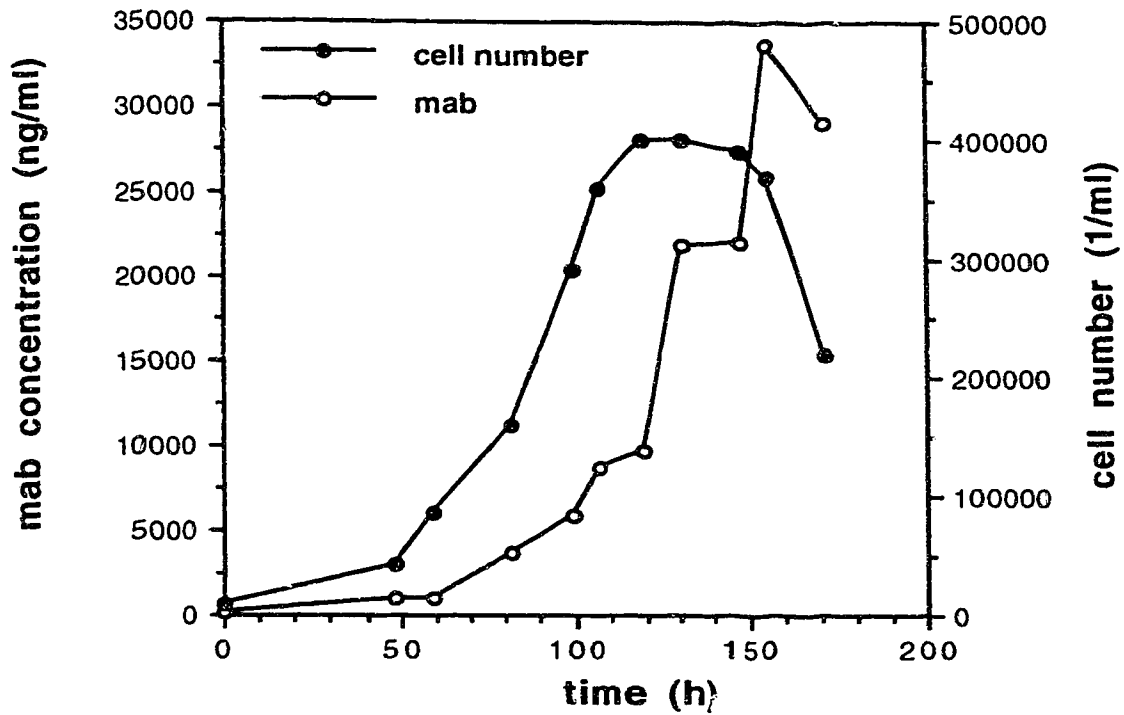

Figure A2-13. Viable cell density and monoclonal antibody concentration during batch experiment in agitated spinner flask at 34°C (2).

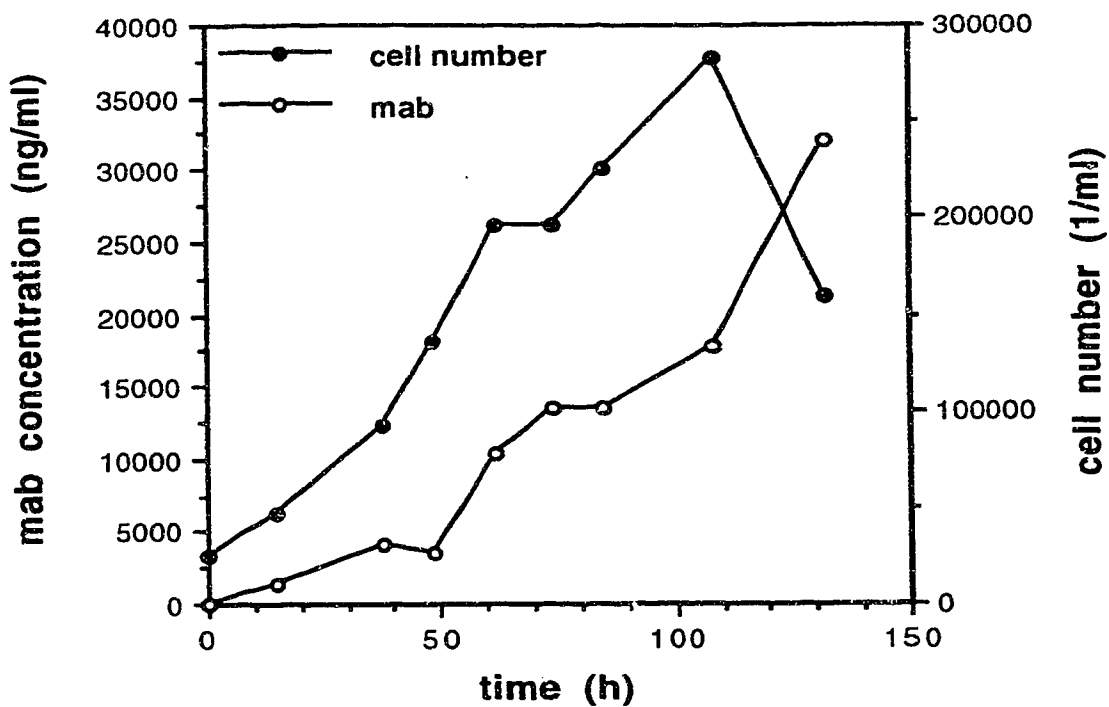

Figure A2-14. Viable cell density and monoclonal antibody concentration during batch experiment in agitated spinner flask at 37°C (1). Appeared as Figure 7 in text.

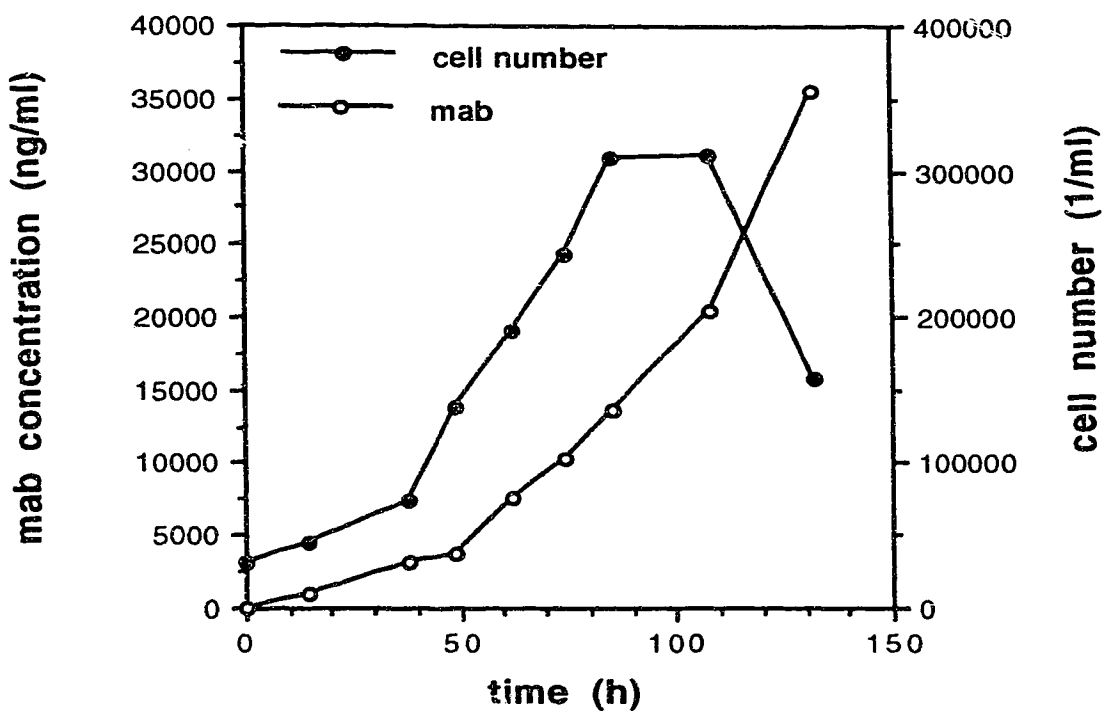

Figure A2-15. Viable cell density and monoclonal antibody concentration during batch experiment in agitated spinner flask at 37°C (2).

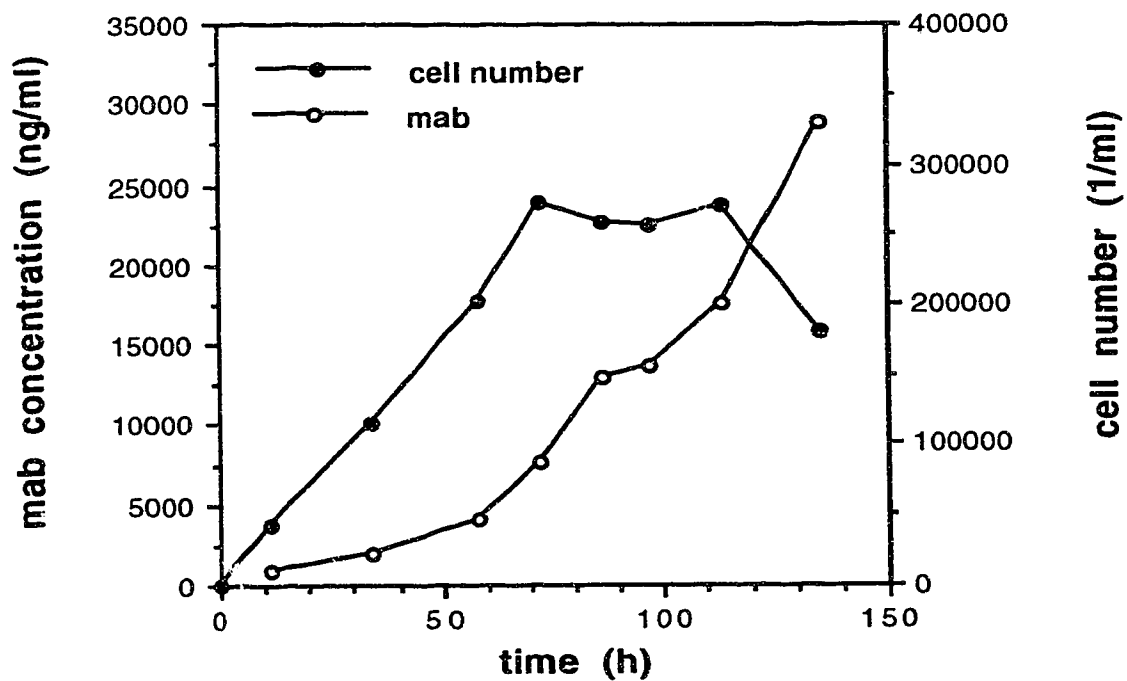

Figure A2-16. Viable cell density and monoclonal antibody concentration during batch experiment in agitated spinner flask at 38°C (1). Appeared as Figure 16 in text.

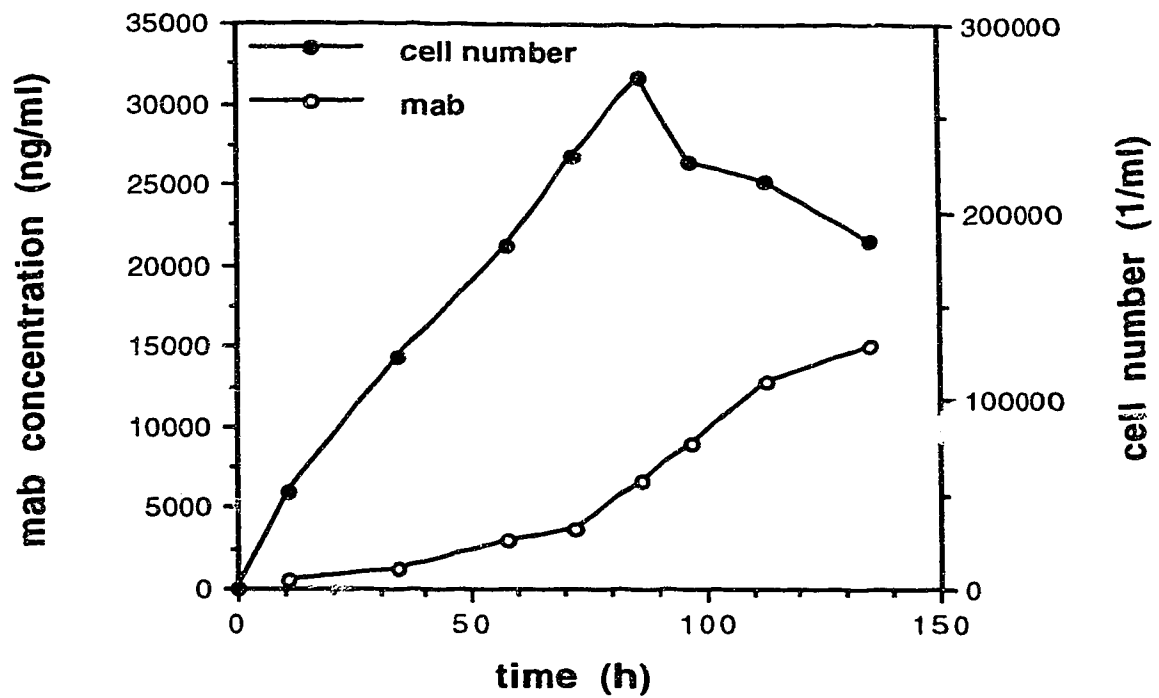

Figure A2-17. Viable cell density and monoclonal antibody concentration during batch experiment in agitated spinner flask at 38°C (2).

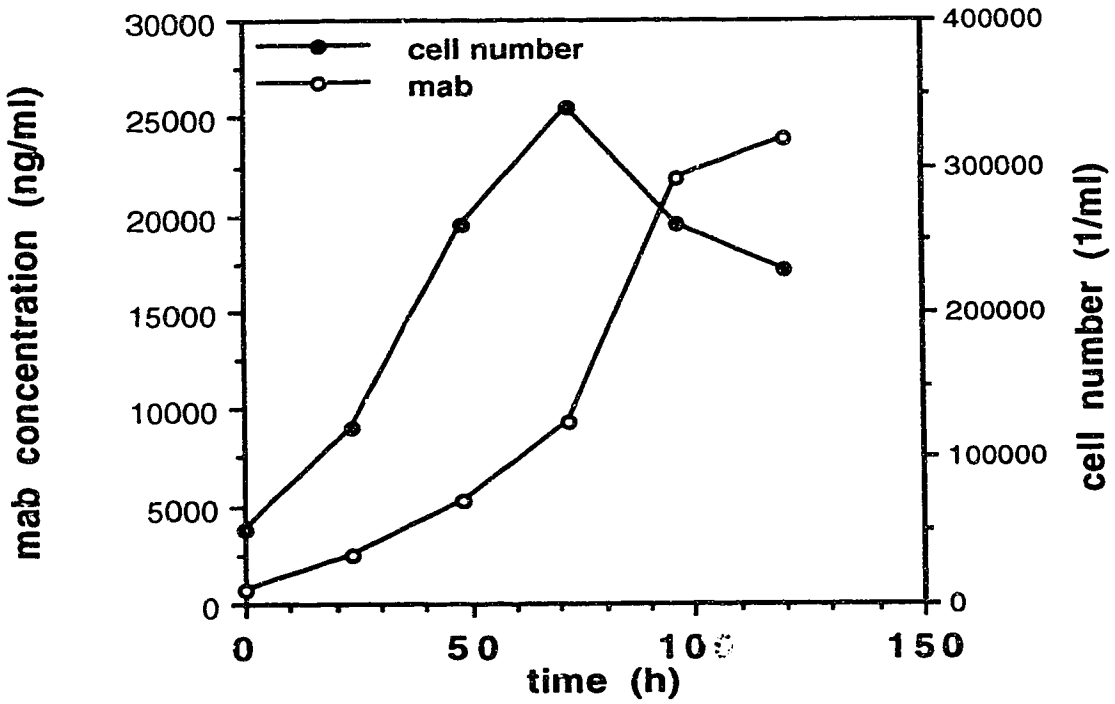

Figure A2-18. Viable cell density and monoclonal antibody concentration during shift in temperature from $T=37^{\circ}\text{C}$ to $T=34^{\circ}\text{C}$. Shift at $t=72$ h (1). Appeared as Figure 24 in text.

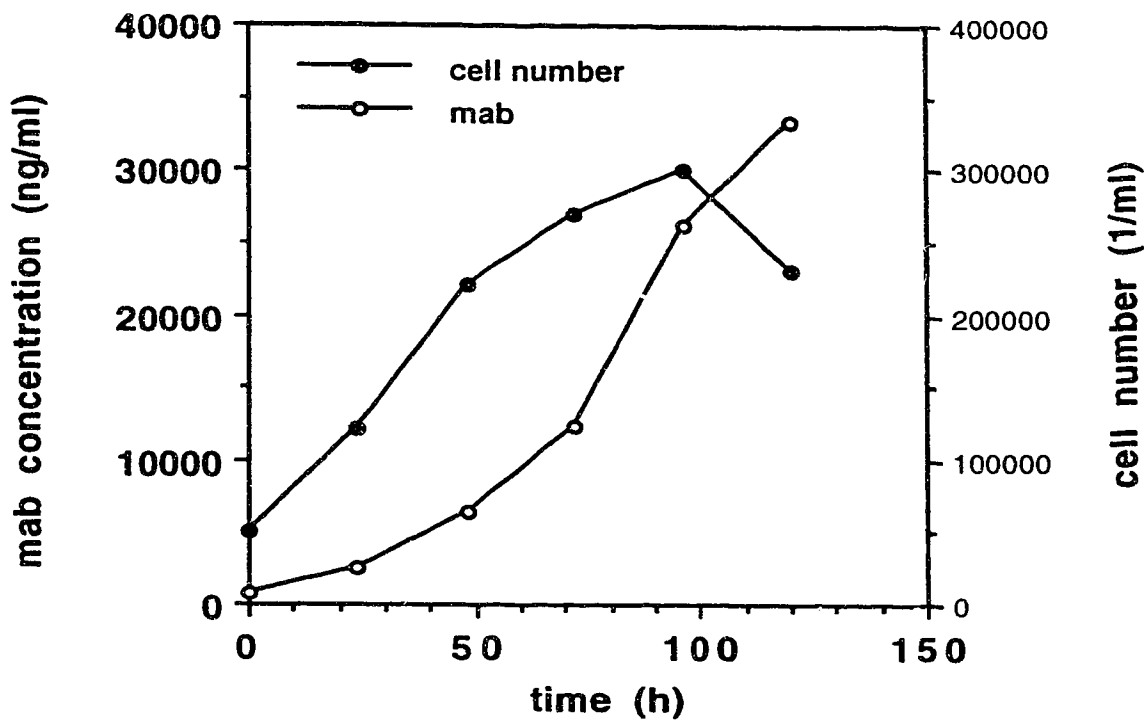

Figure A2-19. Viable cell density and monoclonal antibody concentration during shift in temperature from $T=37^{\circ}\text{C}$ to $T=34^{\circ}\text{C}$. Shift at $t=72$ h (2).

APPENDIX 3

OXYGEN TRANSFER IN NON-AGITATED CULTURES

Assumptions

- Culture volume, $V = 40$ ml
- Free surface area, $A = 0.0040$ m²
- Depth of culture dish, $\Delta x = 0.01$ m (cells on bottom of dish)
- Diffusion coefficient of oxygen in water (= in medium), $D = 2.5 \times 10^{-9}$ m²/s ($T = 25^\circ\text{C}$; Perry, 1973).
- Concentration of oxygen in water, in equilibrium with air: $c^* = 0.2$ mmol/L
- no mixing, concentration near cells, $c = 0$

The maximum oxygen transfer rate is given by:

$$\phi_{\text{mol}} = -D A \frac{\Delta c}{\Delta x} = 2.0 \times 10^{-10} \text{ mol/s}$$

The maximum uptake rate by hybridoma cells:

Miller *et al.* (1987): $1.38\text{--}13.8 \times 10^{-17}$ mole O₂/cell/s

Butler and Jenkins (1989): $1.1\text{--}14 \times 10^{-17}$ mole O₂/cell/s

Wohlpert *et al.* (1990): $1.6\text{--}33 \times 10^{-17}$ μmol O₂/cell/s

At minimum uptake rate of 1.6×10^{-17} mole O₂/cell/s, the number of cells that can be sustained in 40 ml is equal to $2 \times 10^{-10} / 1.6 \times 10^{-17} = 12.5 \times 10^6$ cells or 3×10^5 cells/mL.

At maximum uptake rate of 33×10^{-17} mole O₂/cell/s, this number is 1.5×10^4 cells/mL.

Theoretically oxygen limitation may occur at low cell densities in non-agitated cultures; in practice some extent of mixing is present.

APPENDIX 4

REPEATED EXPERIMENTS: FLOW CYTOMETRY DATA

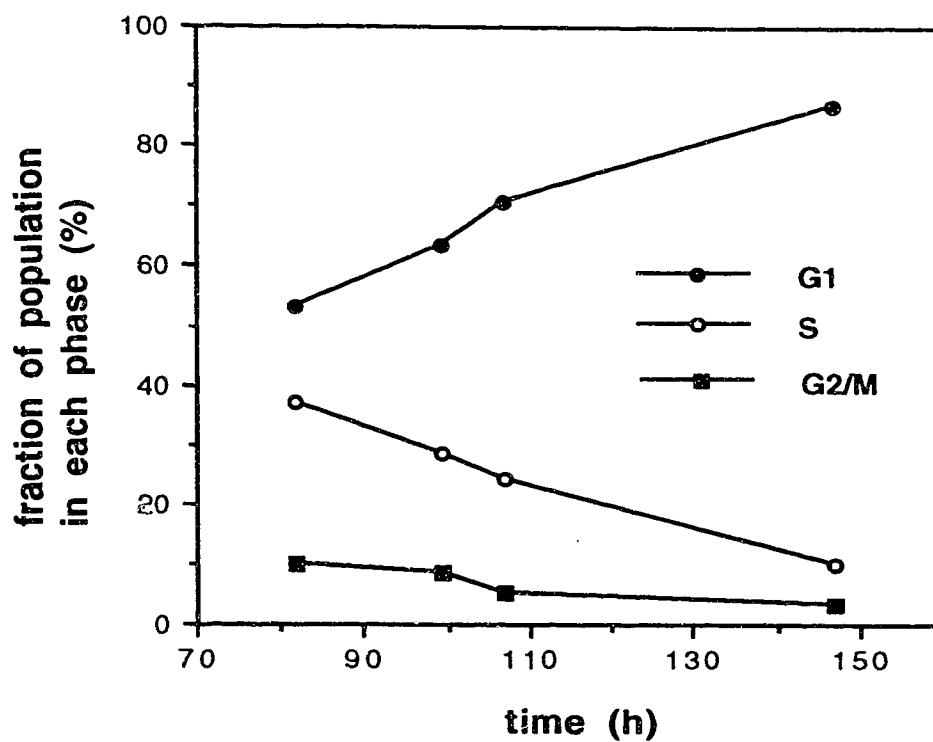

Figure A4-1. Fraction of cell population in G₁, S and G₂+M phase during batch experiment in agitated spinner at 34°C (1). Appeared as Figure 17 in text.

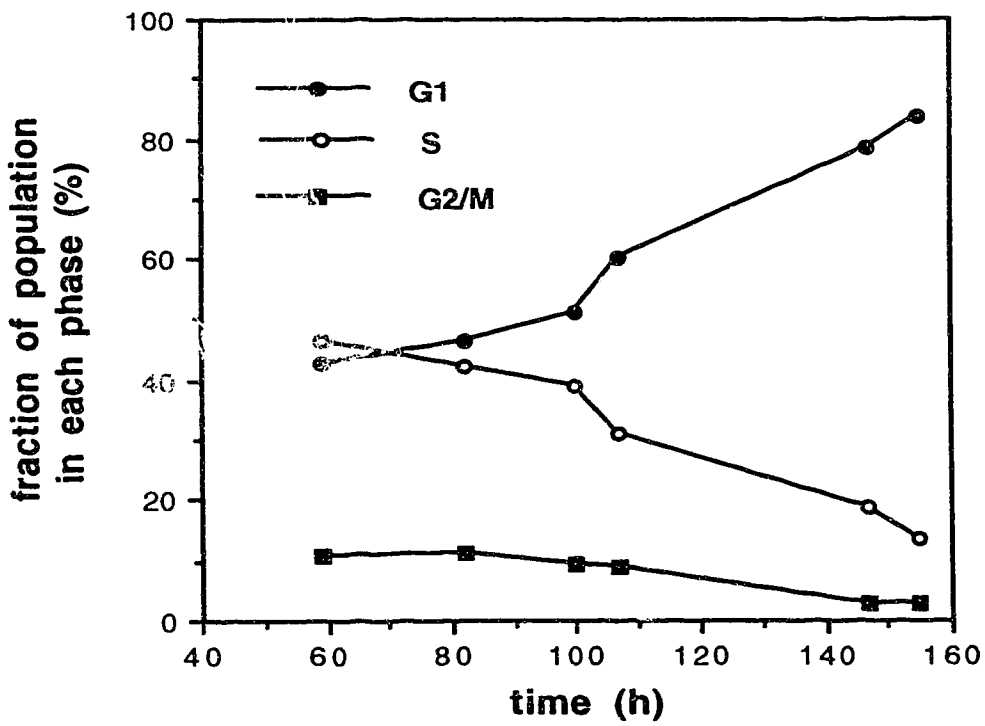

Figure A4-2. Fraction of cell population in G₁, S and G₂+M phase during batch experiment in agitated spinner at 34°C (2).

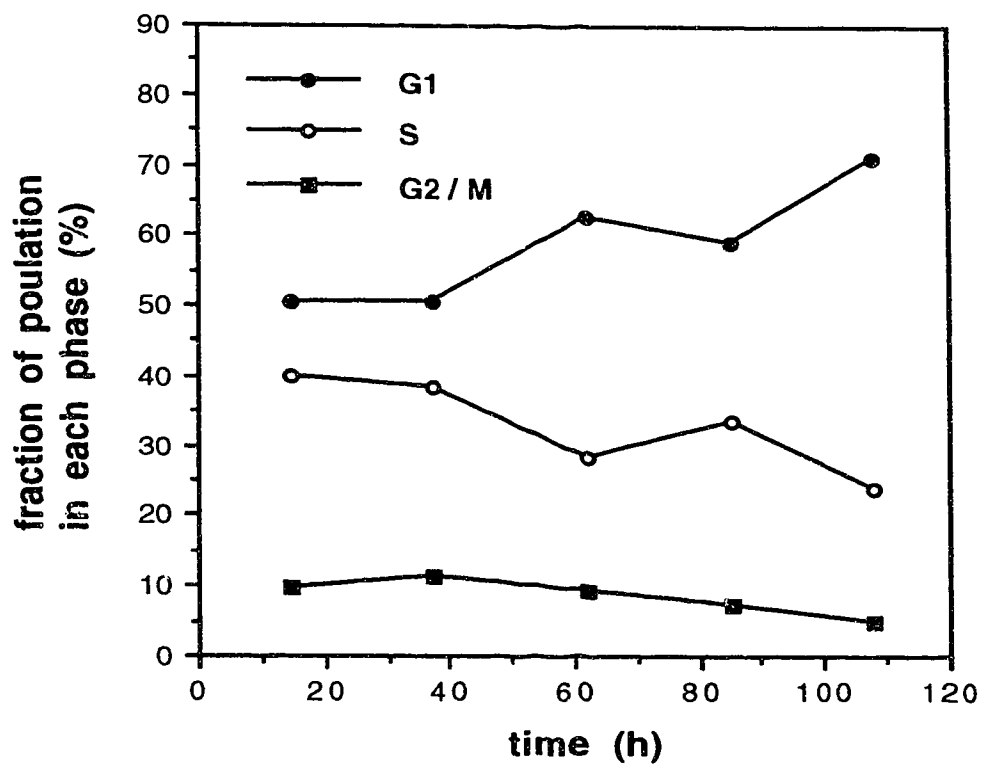

Figure A4-3. Fraction of cell population in G₁, S and G₂+M phase during batch experiment in agitated spinner at 37°C (1). Appeared as Figure 18 in text.

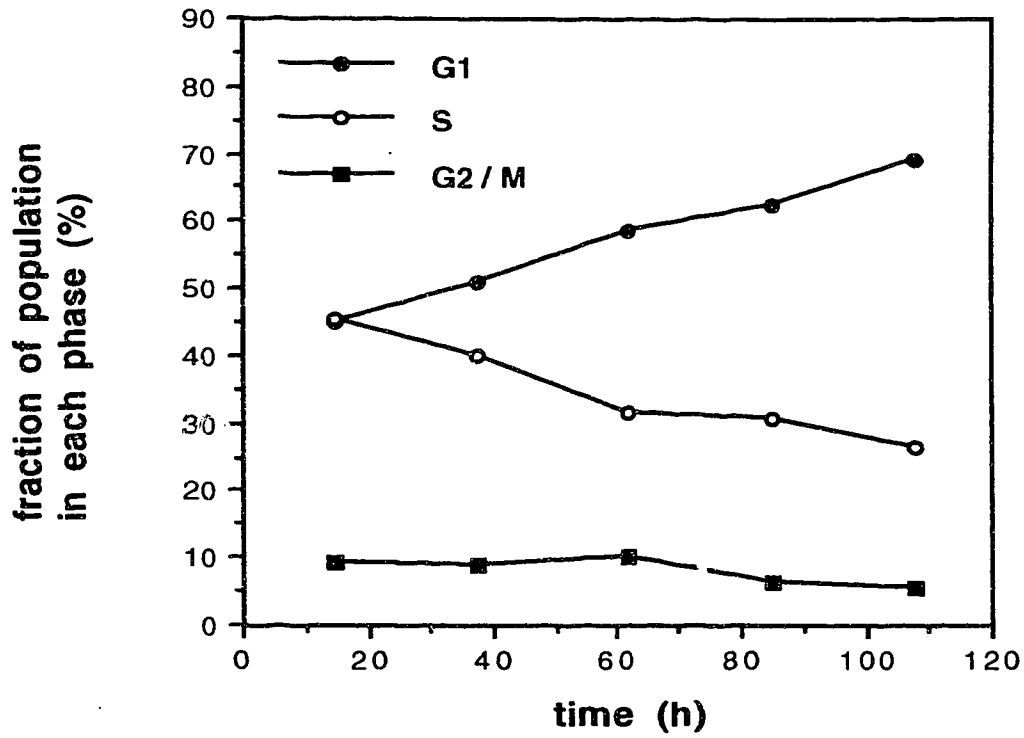

Figure A4-4. Fraction of cell population in G_1 , S and G_2+M phase during batch experiment in agitated spinner at 37°C (2).

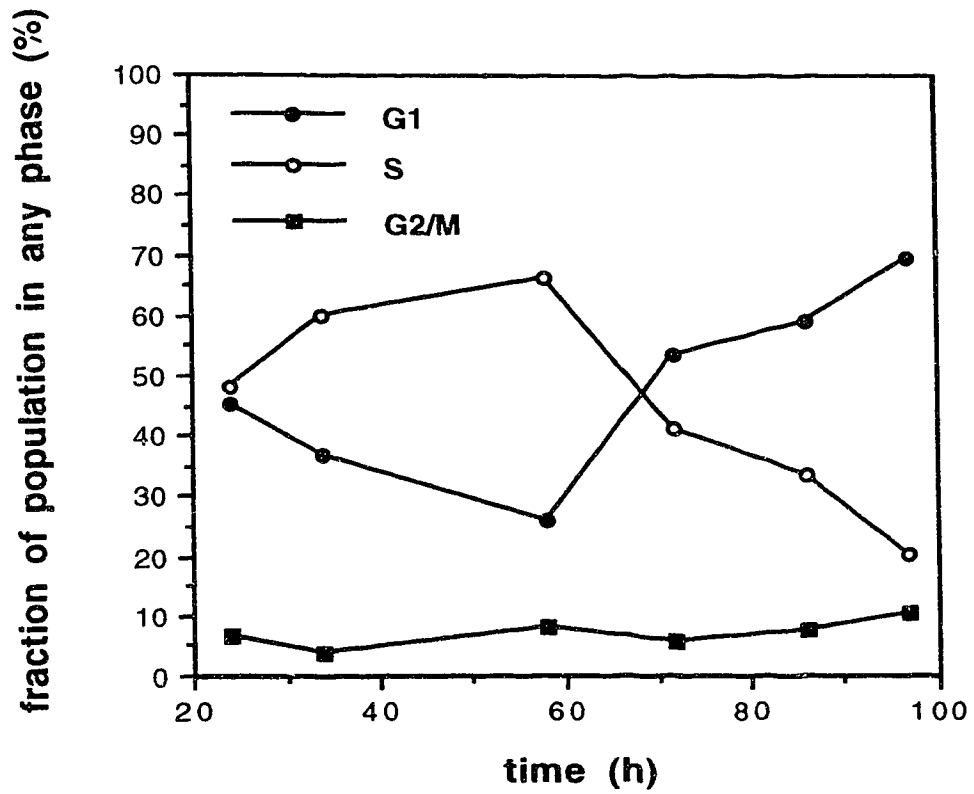

Figure A4-5. Fraction of cell population in G_1 , S and G_2+M phase during batch experiment in agitated spinner at 38°C (1). Appeared as Figure 19 in text.

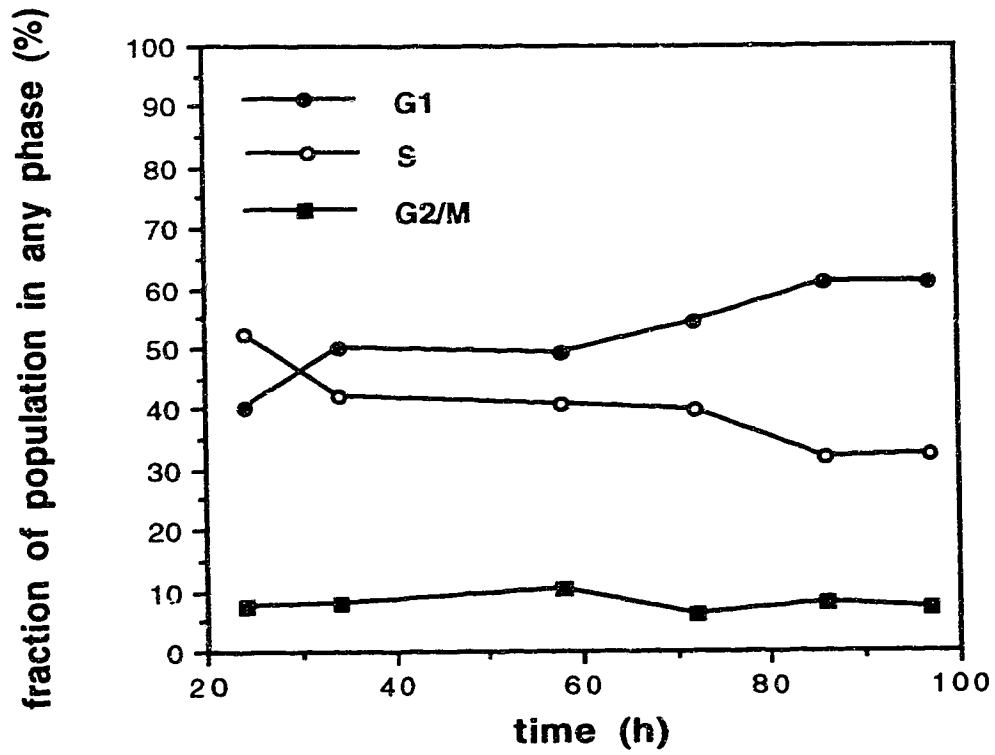
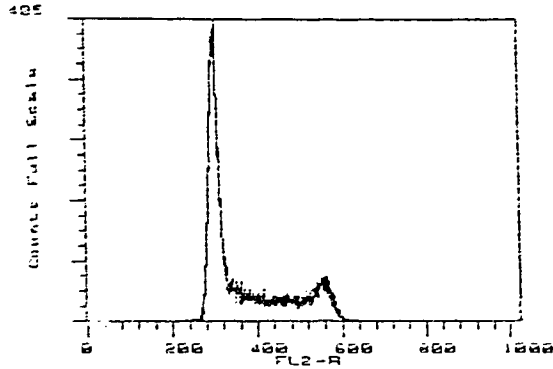

Figure A4-6. Fraction of cell population in G₁, S and G₂+M phase during batch experiment in agitated spinner at 38°C (2).

BECTON
DICKINSON

30-APR-91

13:33:36



Patient Name : F371-2
Case Number :
Tissue Type :
Preparation :
Preparation Date : 30-APR-91
Reagents :
File Name : #3:EXP1001
Collection Date : 30-APR-91
Lab :

Model : SCRR
Gate : OFF
Event Rate : 31
G2+M/G1 Ratio : 1.35
Goodness-of-Fit : 1.56
Number S Phase Peaks : 3

Calculation Parameters

	Initial	Final
G1 Peak :	304	299.3
G2+M Peak:	560	554.9
G1 CV :	4.2	3.7

Cell Cycle Statistics

Phase	Events	Percent	%SD
G1 :	9837	50.3	0.01
S :	7841	40.1	0.01
G2+M :	1876	9.6	0.03
Total:	19554	100.0	

Total Events in Histogram: 20000

FOR RESEARCH PURPOSES ONLY. NOT FOR USE IN
DIAGNOSTIC OR THERAPEUTIC PROCEDURES.

Figure A4-7. Example of histogram from flow cytometric analysis.

APPENDIX 5

REGRESSION RESULTS

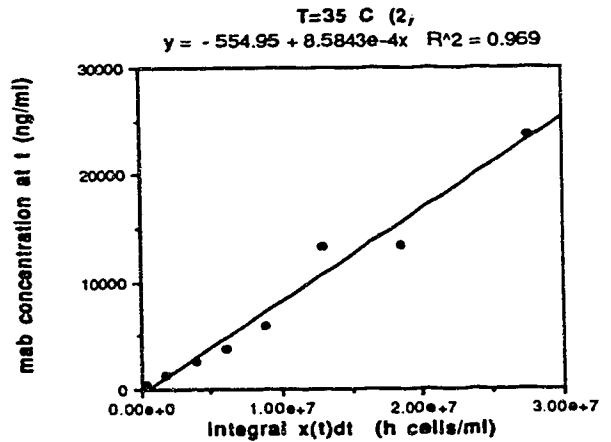
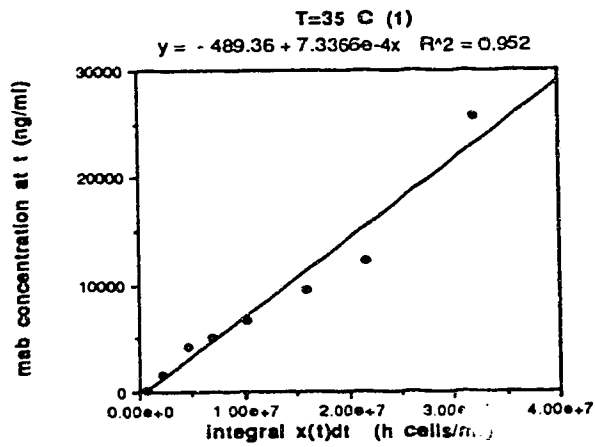
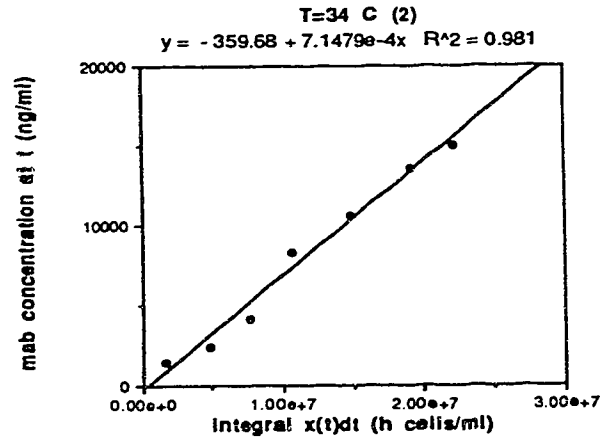
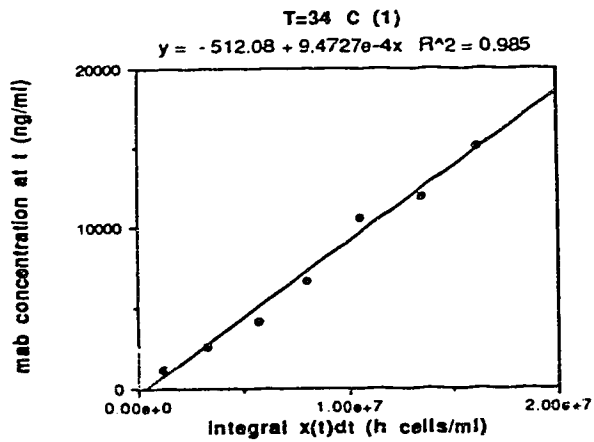

Figure A5-1. Regression results non-agitated cultures at 34 and 35°C.
Determination of β .

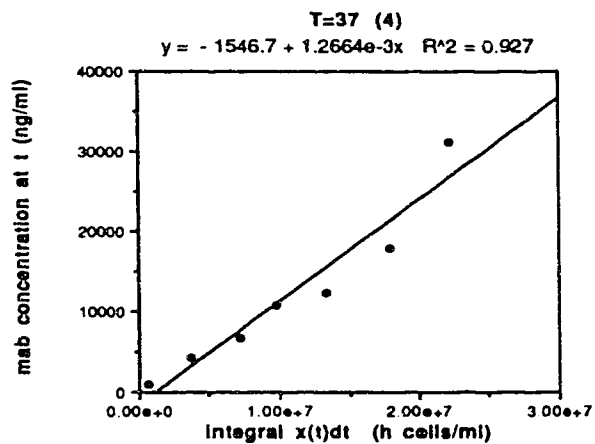
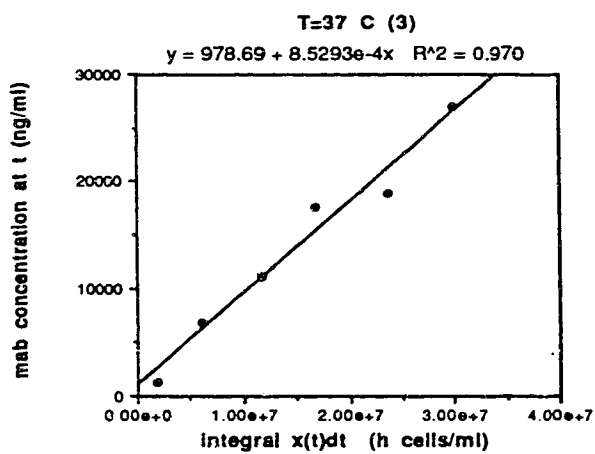
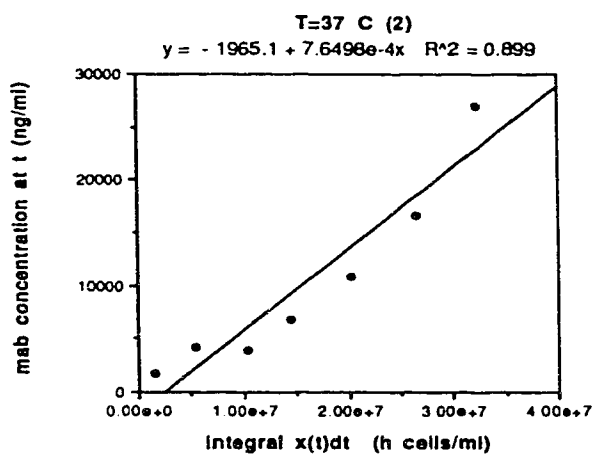
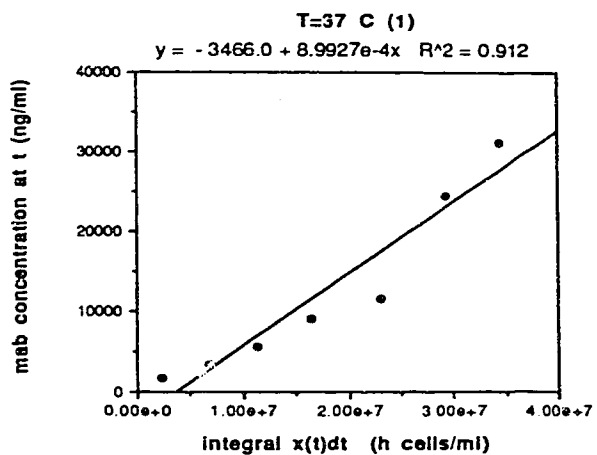

Figure A5-2. Regression results non-agitated cultures at 37 and 38°C.
 Determination of β .

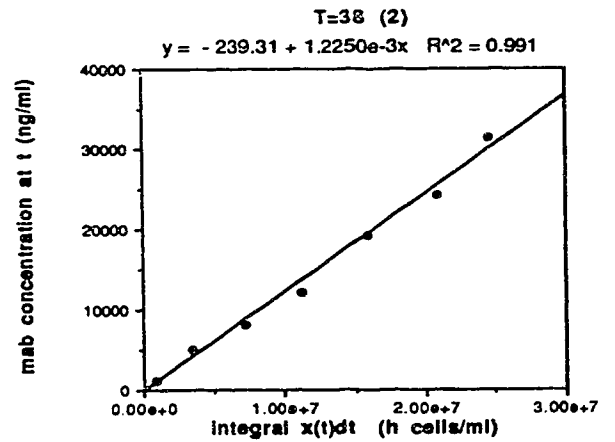
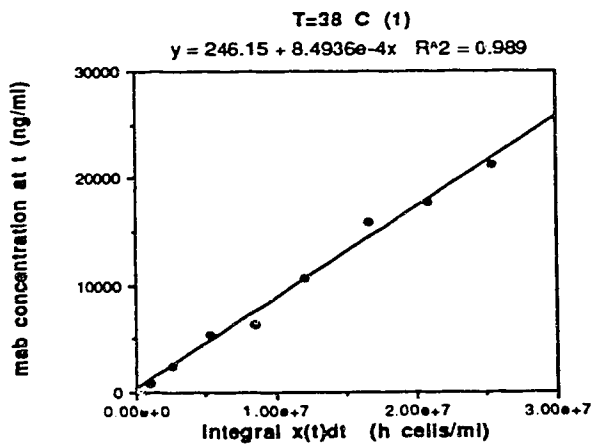
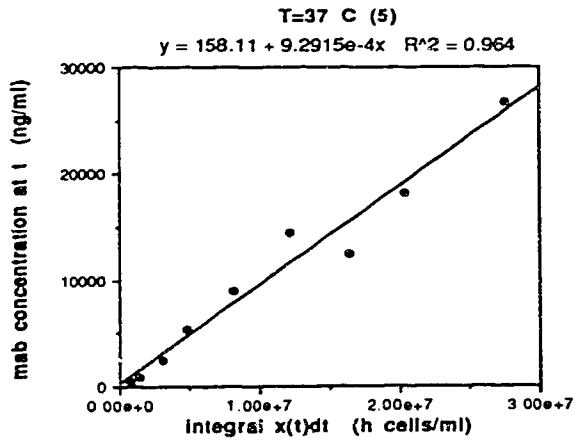

Figure A5-2. Regression results non-agitated cultures at 37 and 38°C.
 (continued). Determination of β .

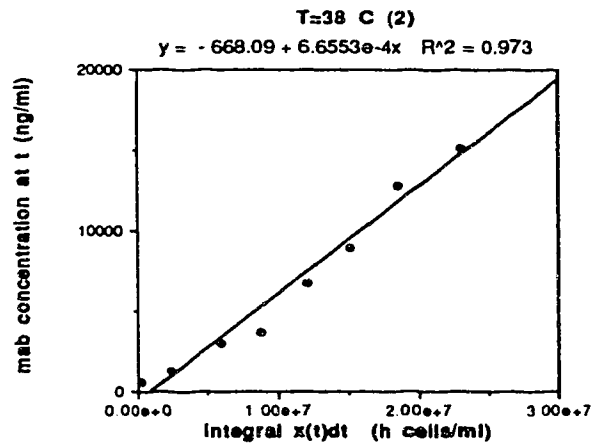
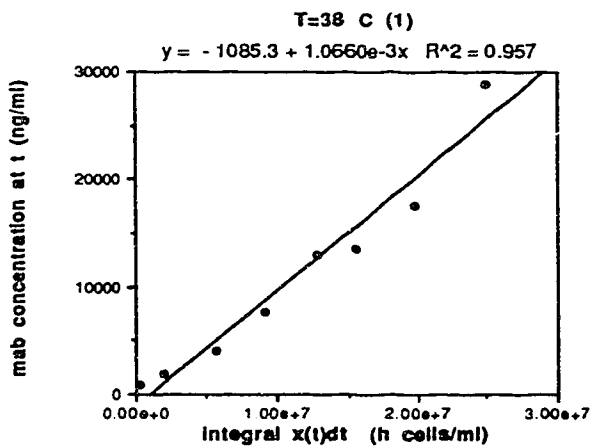
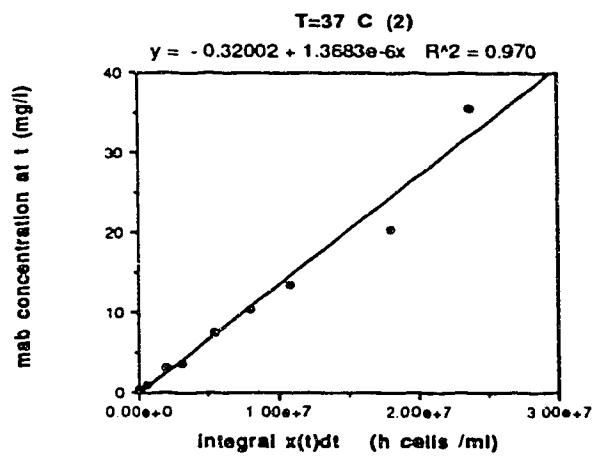
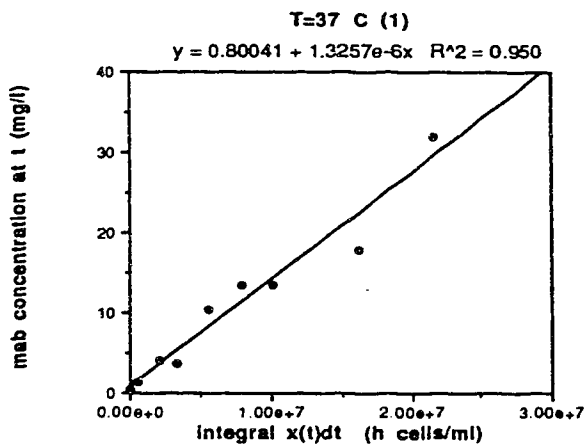
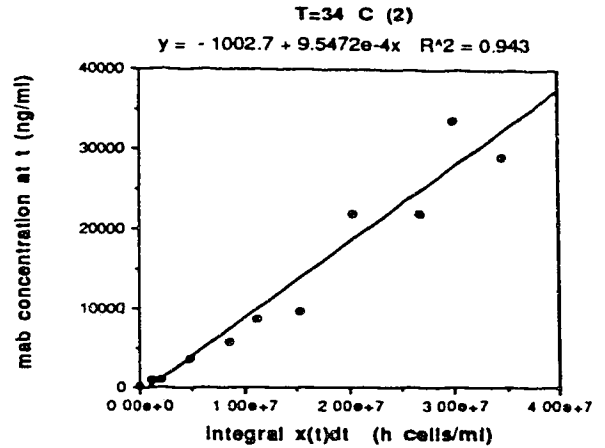
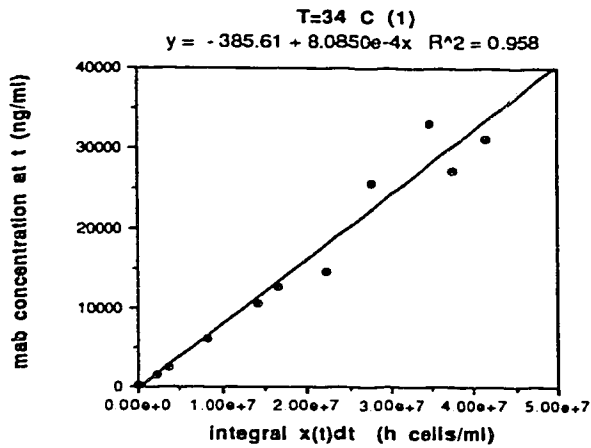

Figure A5-3. Regression results agitated cultures at 34, 37 and 38°C. Determination of β .

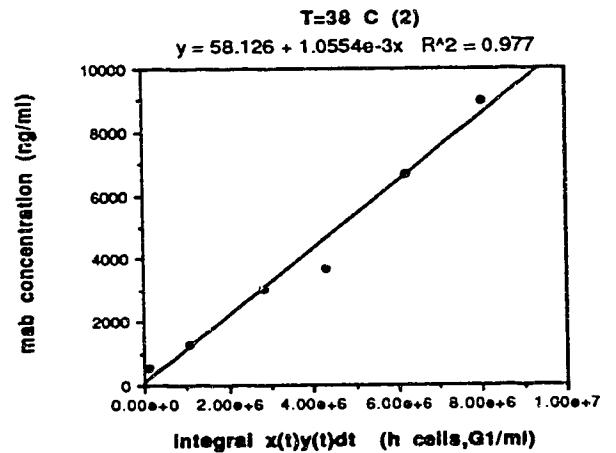
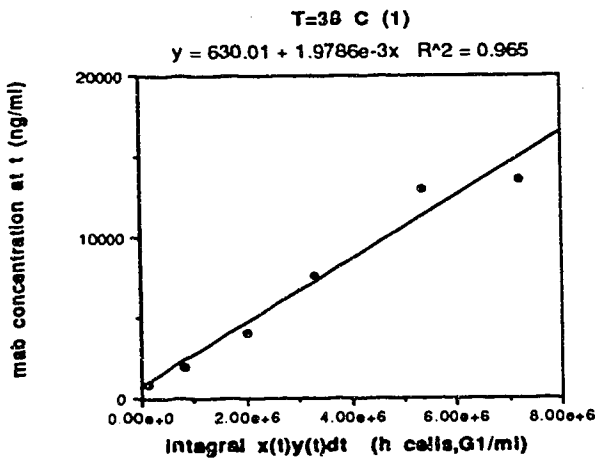
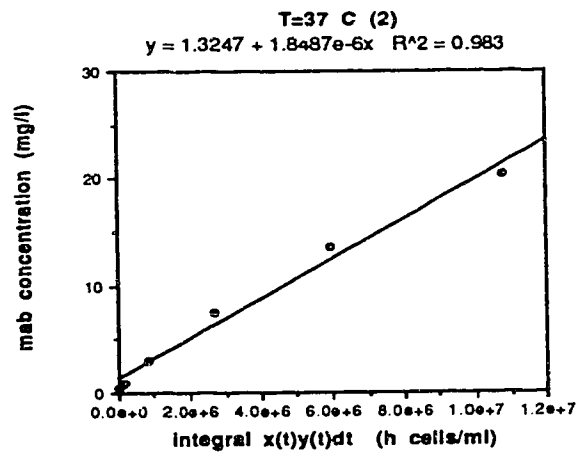
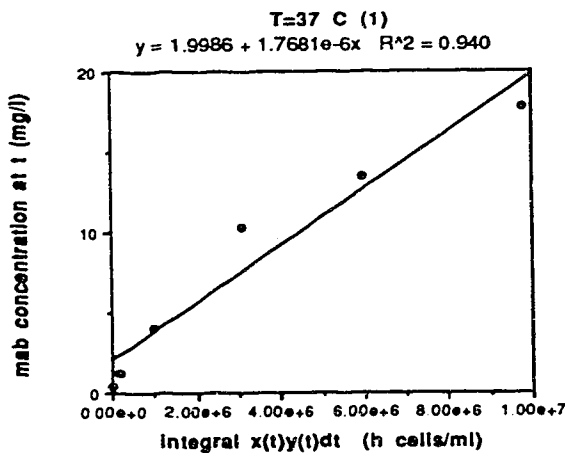
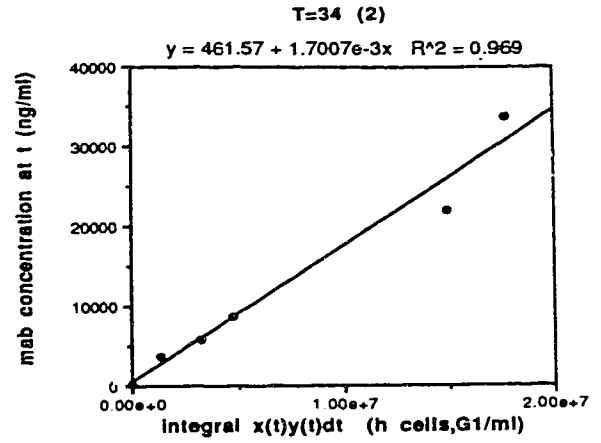
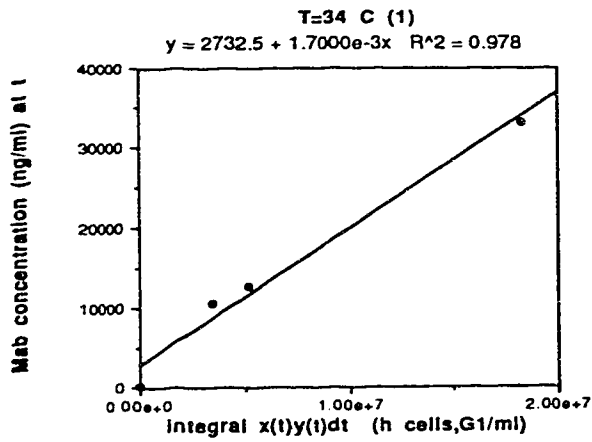

Figure A5-4. Regression results agitated cultures at 34, 37 and 38°C.
 Determination of β' .

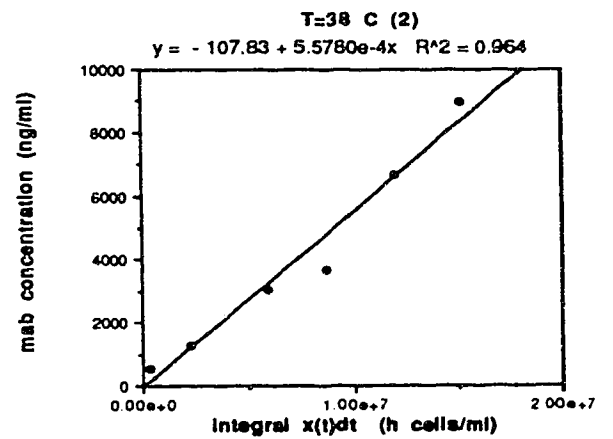
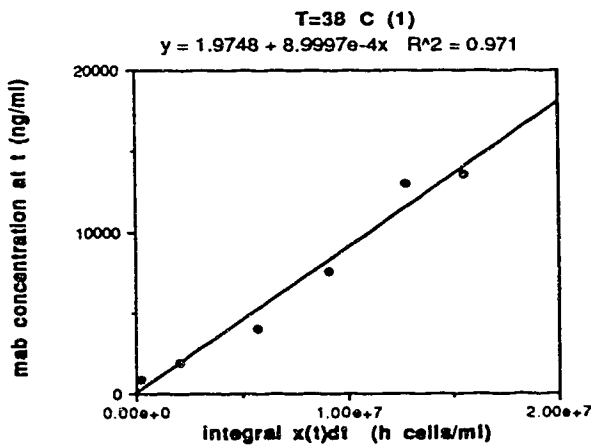
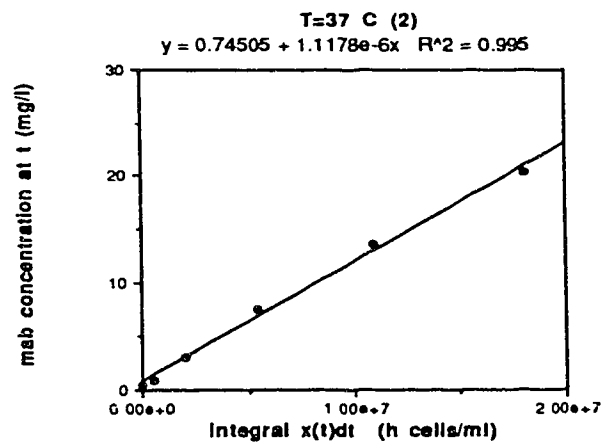
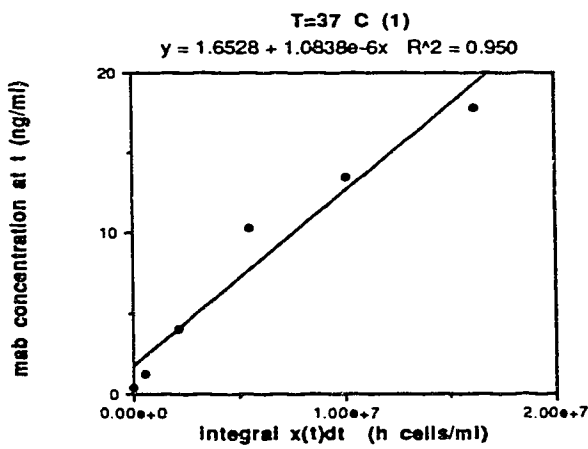
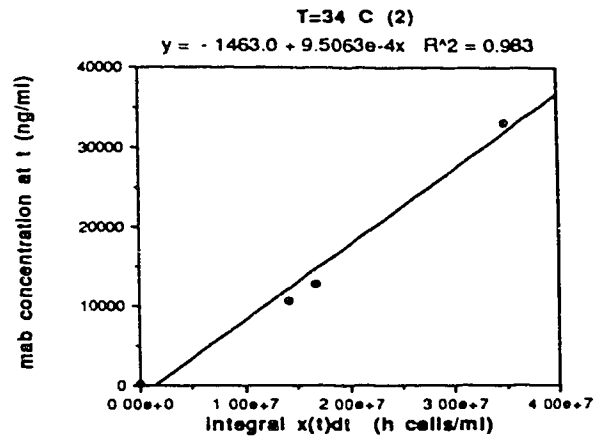
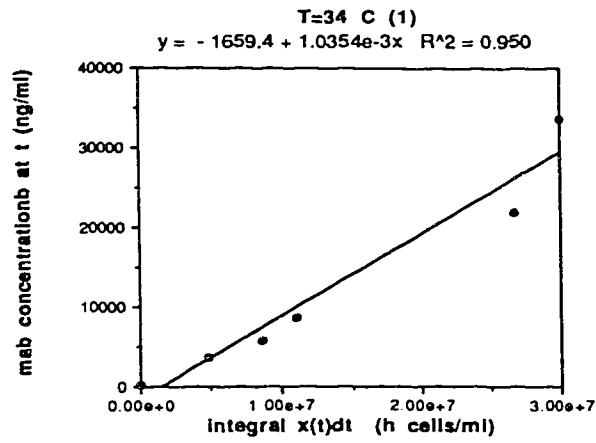

Figure A5-5. Regression results agitated cultures at 34, 37 and 38°C. Determination of β . Same number of samples as in A5-4.

APPENDIX 6

REPEATED EXPERIMENTS: BIOASSAYS

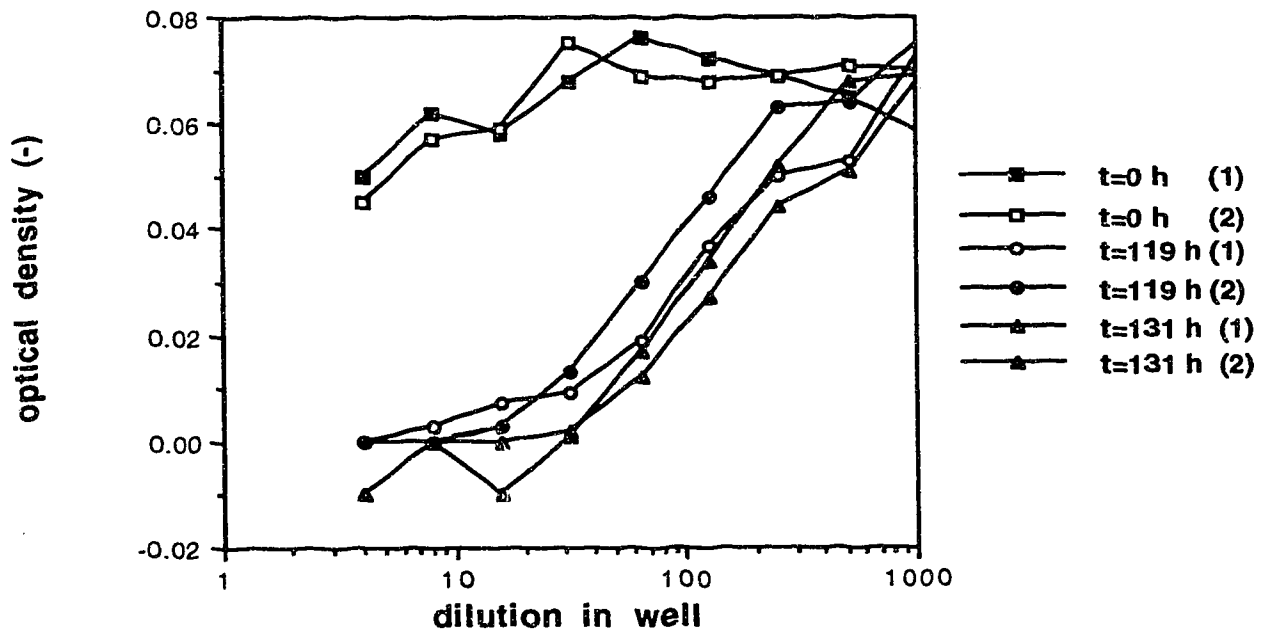

Figure A6-1. MTT assay duplicate results at 34°C.

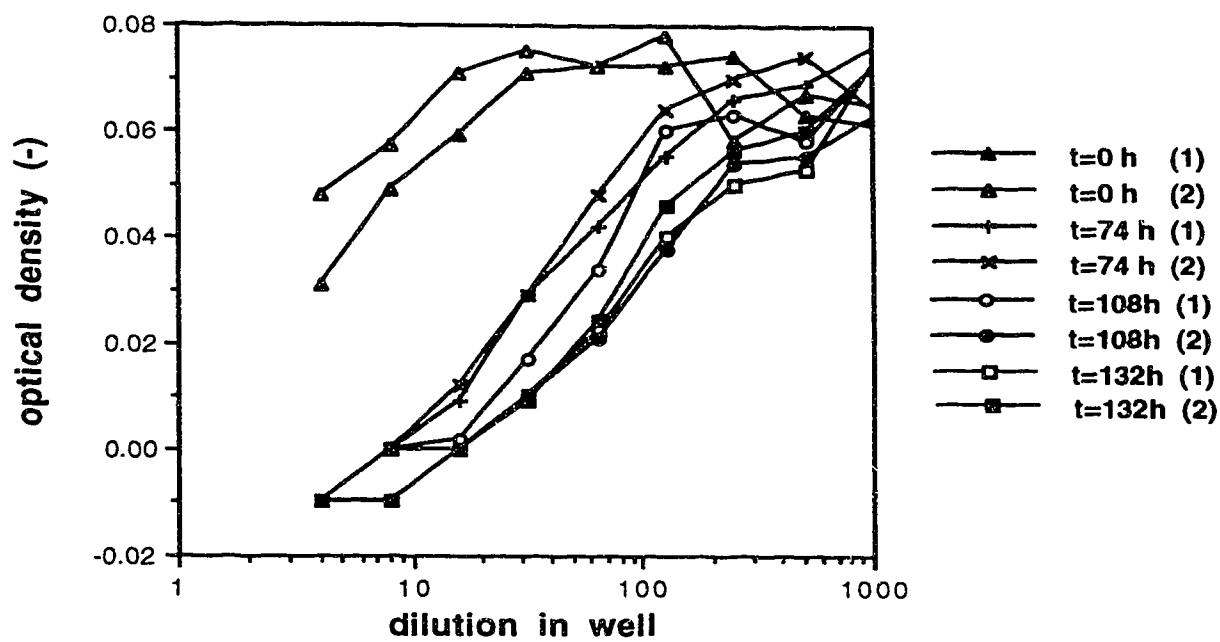

Figure A6-2. MTT assay duplicate results at 37°C.

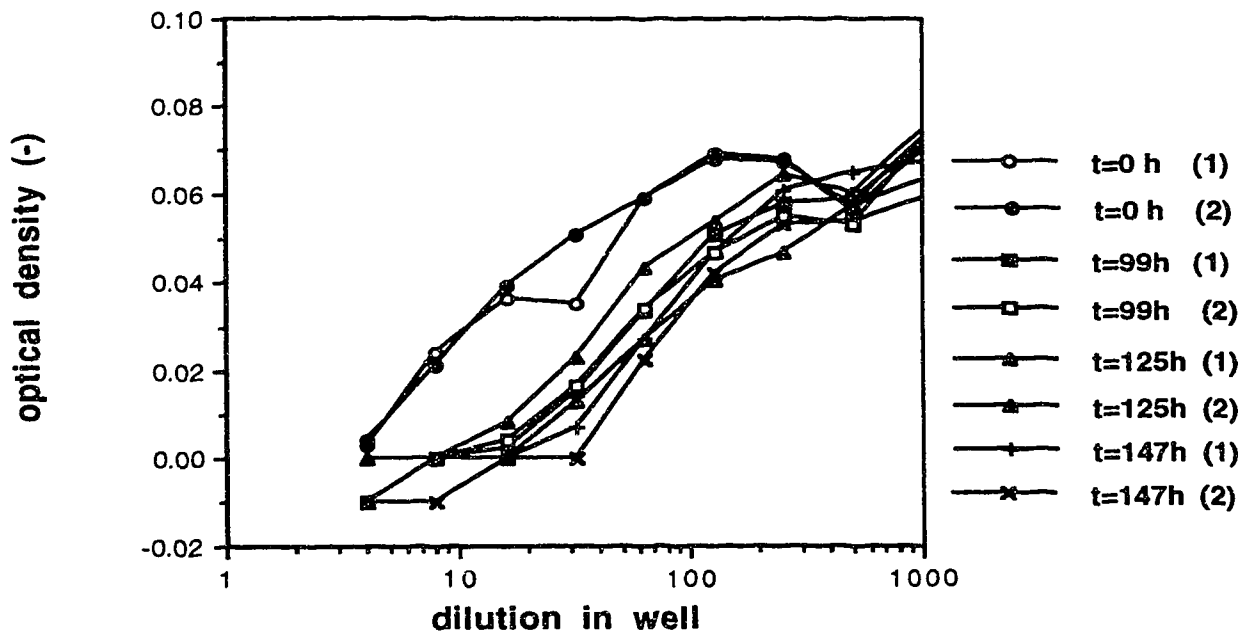

Figure A6-3. MTT assay duplicate results at 38°C.