

8116

NATIONAL LIBRARY  
OTTAWA



BIBLIOTHÈQUE NATIONALE  
OTTAWA

NAME OF AUTHOR.....PIMOL RIENVATANA.....  
 TITLE OF THESIS...A SPECTROSCOPIC, POLAROGRAPHIC  
 AND CONDUCTOMETRIC STUDY  
 OF THALLIUM(II) SALTS IN SOLUTION  
 UNIVERSITY...OF ALBERTA.....  
 DEGREE FOR WHICH THESIS WAS PRESENTED.....Ph. D.....  
 YEAR THIS DEGREE GRANTED.....1971.....

Permission is hereby granted to THE NATIONAL LIBRARY  
 OF CANADA to microfilm this thesis and to lend or sell copies  
 of the film.

The author reserves other publication rights, and  
 neither the thesis nor extensive extracts from it may be  
 printed or otherwise reproduced without the author's  
 written permission.

(Signed).....*P. Riewatana*.....

PERMANENT ADDRESS:

Dept. of Chemistry  
 Chiangmai University  
 Chiangmai, Thailand

DATED...8...April...1971

THE UNIVERSITY OF ALBERTA

A SPECTROSCOPIC, POLAROGRAPHIC AND CONDUCTOMETRIC  
STUDY OF THALLIUM (I) SALTS IN SOLUTION

by



PIMOL RIENVATANA

A THESIS

SUBMITTED TO THE FACULTY OF GRADUATE STUDIES  
IN PARTIAL FULFILMENT OF THE REQUIREMENTS FOR THE  
DEGREE OF DOCTOR OF PHILOSOPHY

DEPARTMENT OF CHEMISTRY

EDMONTON, ALBERTA

SPRING, 1971

THE UNIVERSITY OF ALBERTA  
FACULTY OF GRADUATE STUDIES

The undersigned certify that they have read, and recommend to the Faculty of Graduate Studies for acceptance, a thesis entitled A SPECTROSCOPIC, POLAROGRAPHIC AND CONDUCTOMETRIC STUDY OF THALLIUM (I) SALTS IN SOLUTION submitted by PIMOL RIENVATANA in partial fulfilment of the requirements for the degree of Doctor of Philosophy.

*W. Allen*  
.....  
Supervisor

*R. M. Bolyard*  
.....

*B. Kratochvil*  
.....

*[Signature]*  
.....

*J. Freeman*  
.....

*[Signature]*  
.....  
External Examiner

Date *March 26, 1971*

## ABSTRACT

Evidence is presented for the existence of two chemically distinct species of thallium (I) in solutions of thallium (I) acetate in acetonitrile, p-dioxane, and iso-propyl alcohol and binary mixtures of these solvents with water. These species are the solvated free thallium (I) ion and an ion-pair with acetate. Ultra-violet absorption spectra of the salt showed that the position of an absorption maximum due to ion-pairing occurs at lower energies than that due to the solvated free thallium (I) ion. The wavelength maximum of the TlOAc ion-pair band is sensitive to changes in the nature of solvent, added alkali perchlorates, and temperature, while that of solvated free thallium (I) ion is strongly solvent dependent but is not affected by added alkali perchlorates or temperature change. The absorption bands of the two absorbing species are attributed to a  $^3P_1 \leftarrow ^1S_0$  transition. Thallium (I) ion forms a stable ion-pair or 1:1 complex with acetate ion in acetonitrile. The formation constant of the ion-pair was determined in acetonitrile and the log K value was found to be  $5.7 \pm 0.2$  at  $25^\circ\text{C}$  and an ionic strength of 0.01.

The polarography of thallium (I) acetate, perchlorate and tetrafluoroborate was studied in acetonitrile, using Ag/AgNO<sub>3</sub> 0.01 M in acetonitrile as a reference electrode. The half-wave potentials of the TlOAc ion-pair and the solvated free thallium (I) ion were found to be -0.64 and -0.54 v., respectively. The perchlorate and tetrafluoroborate salts are reversibly reduced,

while the acetate shows some irreversibility. In acetonitrile/water mixtures thallium (I) ion is preferentially solvated by water. The half-wave potential of solvated free thallium (I) ion in acetonitrile appears to be slightly affected by the nature and concentration of supporting electrolytes.

Electrical conductances of thallium (I) acetate in water, and binary mixtures with acetonitrile, p-dioxane and iso-propyl alcohol, and of thallium (I) perchlorate in 86.8% (w/w) acetonitrile/water mixtures were determined at 25°C. The experimental results were analyzed by the Fuoss-Onsager theory. The conductometric behavior of thallium (I) acetate was compared with that of thallium(I) perchlorate in 86.8% (w/w) acetonitrile/water solutions. In this solvent system TlOAc behaves as a weak electrolyte existing largely as ion-pairs, whereas  $\text{TlClO}_4$  is completely dissociated. Solutions of TlOAc in 69.7% (w/w) p-dioxane/water showed significant association of ions into ion-pairs. The inconstancy of the Walden products for TlOAc in acetonitrile/water, p-dioxane/water and iso-propyl alcohol/water is discussed in terms of variations in the effective ionic radii of the primary solvation sheath with solvent composition. The association constants of thallium (I) acetate in 86.8% (w/w) acetonitrile/water and 69.7% (w/w) p-dioxane/water were determined and were found to be  $1.27 \times 10^3$  and  $1.12 \times 10^3$ .

## ACKNOWLEDGEMENTS

The author would like to express his deepest appreciation to Professor Willard F. Allen for his thoughtful guidance and encouragement during the course of this project.

The author would also like to thank Professor Byron Kratochvil for helpful discussions and comments on polarographic and conductometric studies.

Financial assistance from the University of Alberta is gratefully acknowledged.

## TABLE OF CONTENTS

	Page
Abstract . . . . .	iii
Acknowledgements . . . . .	v
List of Tables . . . . .	ix
List of Figures . . . . .	xi
Chapter 1 Introduction . . . . .	1
Chapter 2 Ultraviolet Spectroscopy of the Thallium (I) Ion	
Background . . . . .	7
Experimental . . . . .	16
Reagents and Apparatus . . . . .	16
Method of Association Constant	
Measurement . . . . .	18
Results and Discussion . . . . .	21
Absorption spectra of thallium (I) salts	
in polar solvents . . . . .	21
Absorption spectra of thallium (I) acetate	
in pure solvents and binary aqueous	
solvent mixtures . . . . .	23
Determination of Association Constant of	
Thallium (I) Acetate in Acetonitrile at	
25°C . . . . .	35

TABLE OF CONTENTS - Continued		Page
	The effect of added salts on the absorption spectrum of thallium (I) acetate in acetonitrile. . . . .	43
	The effect of temperature on the absorption spectrum of thallium (I) acetate in various solvent systems . . . . .	46
	Summary . . . . .	50
Chapter 3	The Polarographic Behavior of Some Thallium (I) Salts in Acetonitrile	
	Background. . . . .	51
	Experimental. . . . .	57
	Reagents and Apparatus . . . . .	57
	Results and Discussion . . . . .	62
	Summary . . . . .	74
Chapter 4	A Conductance Study of Thallium (I) Acetate in Water and Selected Binary Aqueous/Solvent Mixtures at 25°C	
	Background . . . . .	75
	Experimental . . . . .	77
	Salt and Solvent Preparation. . . . .	77
	Apparatus. . . . .	77
	Procedure . . . . .	83
	Results and Discussion . . . . .	86



TABLE OF CONTENTS - Continued	Page
Summary . . . . .	102
Bibliography . . . . .	103
Vita. . . . .	109

## LIST OF TABLES

Table		Page
I	Energy levels of gaseous free $Tl^+$ ion . . . . .	7
II	The spectral states of thallium (I) ion in a cubic field	11
III	Energies of absorption maxima for $^3P_1 \leftarrow ^1S_0$ transition for thallium (I) ion in various media . . .	13
IV	Absorption maxima of thallium (I) salts in acetonitrile . . . . .	22
V	Wavelength maxima of the absorption spectra of thallium (I) acetate in various solvents . . . . .	24
VI	Absorption maxima of $TlOAc$ and $TlClO_4$ in <u>p</u> -dioxane/water mixtures . . . . .	32
VII	Data for Determination of Association Constant of Thallium (I) Acetate Ion-Pair in Acetonitrile at $25^\circ C$ . . . . .	38
VIII	Physical properties of acetonitrile . . . . .	55
IX	Diffusion currents of thallium (I) perchlorate at various concentrations in $0.1 \underline{M}$ sodium perchlorate . . . . .	62
X	Half-wave potentials of thallium (I) salts in acetonitrile . . . . .	66
XI	Effect of water on diffusion currents and half-wave potentials of thallium (I) perchlorate in acetonitrile/ water mixtures as solvent and $0.1 \underline{M}$ sodium per- chlorate as supporting electrolyte . . . . .	71

## LIST OF TABLES - Continued

Table	Page
XII Effect of water on diffusion currents and half-wave potentials of thallium (I) acetate in acetonitrile as solvent and 0.1 <u>M</u> sodium perchlorate as supporting electrolyte . . . . .	72
XIII Properties of water and binary water/solvent mixtures at 25°C . . . . .	87
XIV Measured Equivalent Conductances of Thallium (I) Acetate in Water and Binary Water/Solvent Mixtures at 25°C . . . . .	88
XV Measured Equivalent Conductances of Thallium (I) Perchlorate in 86.8% (w/w) Acetonitrile/Water Mixture at 25°C . . . . .	89
XVI Limiting conductances and deviations from the Debye-Hückel-Onsager equation for TlOAc in various solvent mixtures at 25°C . . . . .	96
XVII Limiting equivalent conductances and Walden's products at 25°C for thallium (I) acetate in various solutions . . . . .	98
XVIII Association constants of thallium (I) acetate in binary water/solvent mixtures at 25°C . . . . .	101

## LIST OF FIGURES

Figure	Page
1 The Grotrian diagram of gaseous free $Tl^+$ ion . . . . .	8
2 Energy Level Diagram for $Tl^+$ ion . . . . .	10
3 Spectrophotometry cell used in association constant determinations . . . . .	19
4 Thallium (I) acetate spectrum in water, <u>p</u> -dioxane, methyl alcohol, iso-propyl alcohol, and aceto- nitrile at $20^\circ C$ . . . . .	25
5 Absorption spectrum of thallium (I) acetate in iso- propyl alcohol on addition of water at $20^\circ C$ . . . . .	27
6 Thallium (I) acetate spectrum in water, 25% ethyl alcohol/water and ethyl alcohol at $20^\circ C$ . . . . .	28
7 Absorption spectrum of thallium (I) acetate in iso-propyl alcohol on addition of methyl alcohol at $20^\circ C$ . . . . .	30
8 Absorption spectra of $TlClO_4$ , $TlClO_4$ with added acetate ion, and $TlOAc$ in acetonitrile at $20^\circ C$ . . . . .	34
9 Typical association constant determination plot . . . . .	41
10 Absorption spectrum of the $TlOAc$ ion-pair in acetonitrile at $25^\circ C$ . . . . .	42
11 Absorption spectrum of thallium (I) acetate in acetonitrile on addition of sodium perchlorate at $20^\circ C$ . . . . .	44

## LIST OF FIGURES - Continued

Figure	Page
12 Absorption spectrum of thallium (I) acetate in acetonitrile on addition of tetra-n-butylammonium perchlorate at 20°C. . . . .	45
13 Absorption spectra of thallium (I) acetate in acetonitrile at 20°C and at 60°C. . . . .	47
14 Absorption spectra of thallium (I) acetate in 10% (v/v) water/iso-propyl alcohol at 20°C and at 60°C. . . . .	48
15 Polarographic cell . . . . .	61
16 Typical polarogram of $6 \times 10^{-4}$ M thallium (I) perchlorate in 0.1 M NaClO <sub>4</sub> in acetonitrile at 25°C. . . . .	64
17 Typical polarograms of $7 \times 10^{-4}$ M thallium (I) acetate in 0.1 M NaClO <sub>4</sub> and in 0.1 M Et <sub>4</sub> NClO <sub>4</sub> in acetonitrile at 25°C . . . . .	65
18 Test for reversibility of the thallium (I) - (0) couple in acetonitrile at 25°C. Solution composition was $6 \times 10^{-4}$ M thallium (I) perchlorate in 0.1 M NaClO <sub>4</sub> . . . . .	69
19 One-liter conductance cell . . . . .	78
20 Salt cup dispensing device . . . . .	80
21 Electrical components for conductance measurements . . . . .	82
22 Equivalent conductance as function of concentration for TlOAc in water, 20.6% acetonitrile, 43.8% acetonitrile, 70.0% acetonitrile, and 86.8% acetonitrile . . . . .	90

## LIST OF FIGURES - Continued

Figure		Page
23	Equivalent conductance as function of concentration for TlOAc in 39.8% <u>p</u> -dioxane, 52.7% <u>p</u> -dioxane, and 69.7% <u>p</u> -dioxane . . . . .	91
24	Equivalent conductance as function of concentration for TlOAc in 38.5% iso-propyl alcohol, 49.8% iso-propyl alcohol, and 73.3% iso-propyl alcohol . .	92
25	Equivalent conductance as function of concentration for TlClO <sub>4</sub> and TlOAc in 86.8% acetonitrile/water mixtures. . . . .	93
26	Variation of $\Lambda_o$ with mole percent of acetonitrile for TlOAc in acetonitrile/water mixtures . . . . .	99

## Chapter 1

### Introduction

In 1861 Sir William Crookes<sup>1,2</sup> discovered spectroscopically a new element and named it 'thallium' from its light green line ( $\lambda$  535 m $\mu$ ) on the spectroscope (thallos, in Greek, means a green twig). Thallium is found in the earth's crust with estimated percentage of abundance to be about 1 g/metric ton. It occurs in few minerals such as lorandite TlAsS<sub>2</sub>, hutchinsonite (Tl,Cu,Ag)<sub>2</sub>As<sub>2</sub>S<sub>3</sub>, PbAs<sub>2</sub>S<sub>4</sub>, and crooksite (Tl,Cu,Ag)<sub>2</sub>Se.

Thallium, Tl, with atomic number of 81 and atomic weight of 204.37 is in group III of the Periodic table along with boron, aluminum, gallium, and indium. It is soft and of metallic appearance with a fairly high density (11.85 g/cm<sup>3</sup> at 20°); m.p. 303°, b.p. 1457°<sup>3</sup>. Freshly cut thallium metal has a metallic luster which rapidly dulls by reaction with oxygen to form thallium (I) oxide. In water containing air it is oxidized to thallium (I) hydroxide, but in oxygen-free water it does not react at ordinary temperature. There are two commonly found isotopes, i.e., Tl-203 and Tl-205 with the percentage of abundance being 29.5 and 70.5, respectively. Thallium has two comparatively stable states, i.e., univalent (Tl<sup>+</sup>) and trivalent (Tl<sup>3+</sup>). The more numerous and stable salts are of the univalent group. The Tl<sup>+</sup> and Tl<sup>3+</sup> ions differ markedly in many of their properties, e.g. Tl<sup>+</sup> has little tendency to form complexes whereas Tl<sup>3+</sup> shows strong tendency to do so.

It would be worthwhile to mention here the toxicity of thallium and its salts<sup>4,5,6</sup>. Contact of the metal with the skin is dangerous and should be avoided. Thallium salts are strong nerve and protoplasmic poisons; their action is similar to that of arsenic and lead compounds. The accidental ingestion of inorganic salts of thallium has induced prompt and severe gastroenteritis followed by respiratory difficulties, tremors, convulsions, motor weakness, polyneuritis, muscular paralysis, loss of hair, loss of nails and peeling of the skin of the feet. There is extensive medical literature dealing with the toxicity of thallium<sup>7</sup> and antidotes for acute thallium poisoning<sup>8</sup>. The maximum allowable concentration of soluble thallium salts in air is 0.1 mg/cubic meter<sup>4</sup>. The lethal dose has been reported to be about 0.2 g.<sup>5</sup> According to the toxicity mentioned above, the handling of thallium and its salts without protection should be prohibited.

Thallium itself has limited applications but its salts are widely used, for instance, as rodenticides and insecticides (now illegal in the United States), in photoelectric cells and detectors in the infra-red range and in making a monochromatic green flame. Certain thallium salts such as thallium (I) carbonate, bromide, and iodide are used in the manufacture of optical glass with a high refractive index, and also in the preparation of opaque black or brown glass. Thallium (I) sulphide has been used in semiconductor devices.



Since  $Tl^+$  ion has  $(Xe)4f^{14}5d^{10}6s^2$  ground state configuration, it is isoelectronic with atomic mercury. The spectroscopic notation of the ground state is  $6^1S_0$  for free  $Tl^+$  ion. The low lying excited configuration  $(6s)^1(6p)^1$ , obtained by promoting an electron from the occupied s to the unoccupied p orbital, consists of three triplet states ( $^3P_0$ ,  $^3P_1$ , and  $^3P_2$ ) and one singlet state ( $^1P_1$ ). The energy difference between the low lying excited state and the ground state is about 7 electron volts (eV).

Although  $Tl^+$  has about the same ionic radius as  $K^+$  and  $Rb^+$  ions (i.e.,  $Tl^+ = 1.44 \text{ \AA}$ ,  $K^+ = 1.33 \text{ \AA}$ ,  $Rb^+ = 1.48 \text{ \AA}$ ), its salts behave quite differently from the salts of  $K^+$  and  $Rb^+$  which are completely dissociated in aqueous solution. This anomalous behavior of thallium (I) salts has been attributed to the tendency of  $Tl^+$  to distort in an asymmetric field<sup>9</sup>.

During the last decade, the chemistry of  $Tl^+$  ion in aqueous solution has been studied extensively using electrical conductivity<sup>10,11</sup> and solubility<sup>11,12</sup> measurements, ultraviolet<sup>13,14,15</sup> and Raman<sup>16</sup> spectroscopy and N.M.R.<sup>17,18,19</sup>. Work has also been reported in other media such as in thallium-doped alkali-halide crystals<sup>20,21,22</sup> and in various kinds of glasses<sup>23,24,25</sup> using absorption and emission spectroscopy.

In water as solvent,  $Tl^+$  ion associates appreciably with anions of low charge, e.g. halides, thiocyanate and hydroxide. Chloride complexes of  $Tl^+$  ion in aqueous solution have been investigated by measuring the solubility of  $TlCl$  in solutions of

alkali metal chlorides and confirmed spectrophotometrically by Hu and Scott<sup>26,27</sup> who showed that  $TlCl$  and  $TlCl_2^-$  exist in the solutions. Scott and coworkers<sup>28</sup> studied the bromide complexes of  $Tl^+$  ion using optical absorption and solubility measurements. Kulba and Mironov<sup>29</sup> have shown that  $TlI$ ,  $TlI_2^-$  and  $TlI_4^{3-}$  exist in KI solutions containing  $TlI$ . Thiocyanate complexes of  $Tl^+$  ion have been studied potentiometrically<sup>30</sup> and their solubilities have been determined<sup>12</sup>. The association constants for the ion-pairs\* of  $TlCl$ ,  $TlOH$  and  $TlSCN$  have been reported by Bell and George<sup>12</sup>.

The spectroscopic method can be used to study ion-pairs and complex formation by observing the shifts of individual absorption bands provided that the free ions and the corresponding ion-pairs or complexes have different absorption maxima. Popov and Humphrey<sup>31</sup> and Kolthoff et al.<sup>32</sup> concluded that the spectra of the ion-pairs are identical with those of the free ions. Griffiths and Simons<sup>33</sup>, in opposition to this, observed that the absorption bands ascribed to contact ion-pairs of tetra-alkylammonium iodides in solvents of poor ion-solvating power occur at different wavelengths from those of separated solvent ion-pairs and solvated free iodide ions. Bell and Panckhurst<sup>14</sup> measured the ultraviolet absorption spectra of aqueous solutions containing  $Tl^+$  and  $OH^-$  ions and showed that there are two distinct absorbing species with different band maxima. Raman studies<sup>16</sup> showed no substantial evidence for

---

\* This term includes the contact, solvent-shared and solvent-separated ion-pairs and will be used throughout this thesis when distinctions between them cannot be made.

covalent binding in  $TlOH$ .

A comparison of the half-wave potentials obtained from polarographic measurements in two solvents yields information about the solvation energy of a given cation in the two solvents. For example, it has been found that alkali metal ions<sup>34</sup> and  $Tl^+$  ion<sup>35</sup> are easier to reduce in acetonitrile than in water, showing that the metal ions have lower solvation energies in the former solvent than in the latter one.

Since ion-pairs formed in a solution generally will not contribute to the conductivity of the solution, the measurement of electrical conductivity provides a valuable method of studying ion-pair formation, solvation and mobility trends of a given electrolyte. The conductivity of thallium (I) acetate has been measured at  $25^{\circ}C$  in water up to a concentration of  $0.01 M$  by Robinson and Davies<sup>10</sup> who reported the conductivity value at infinite dilution ( $\Lambda_0$ ) to be 115.63 and a dissociation constant of 1.3. In formamide as solvent, the equivalent conductances at infinite dilution for  $TlNO_3$  and  $TlOAc$  have been reported to be 33.18 and 27.75, respectively<sup>36</sup>. Yeager and Kratochvil<sup>37</sup> who made a conductance study of thallium (I) perchlorate and tetrafluoroborate in acetonitrile, reported the limiting equivalent conductances for the salts to be 195.2 and 199.1, respectively.

Measurements of N.M.R. chemical shift<sup>17,18,19</sup> for thallium (I) salts in aqueous solution indicated the existence of hydrated ion-pairs. The change in the hydration of the ion-pairs observed

by varying the anion concentration or by the addition of another constituent is believed to be responsible for the linear chemical shift<sup>17,18</sup>. The N.M.R. studies showed strong evidence that the ion-pairs of thallium (I) acetate in concentrated aqueous solutions are of a predominantly electrostatic character. Freeman and coworkers<sup>17</sup> reported that the value of the ion-pair dissociation constant for thallium (I) acetate in a concentrated aqueous solution cannot be obtained by spectroscopic methods because of the absorption of the acetate ion.

A limited number of investigations for thallium (I) salts have been done in non-aqueous solvents. For example, Scott and Hu<sup>27</sup> studied the effect of solvent properties on the absorption spectra of chloride complexes of  $Tl^+$  ion in water/alcohol mixtures. The electrical conductivities of  $TlNO_3$  and  $TlOAc$  in formamide<sup>36</sup> and of  $TlClO_4$  and  $TlBF_4$  in acetonitrile<sup>37</sup> have been measured at 25°C. Polarographic measurements of  $Tl^+$  ion have been made in acetonitrile<sup>38</sup>, alcohols<sup>39</sup>, ethylene glycol<sup>40</sup>, ethylenediamine<sup>41</sup>, formamide<sup>42</sup>, and dimethyl sulphoxide<sup>43</sup>. The solubilities of thallium (I) halides have been studied in dimethyl sulphoxide<sup>43,44</sup>, acetonitrile<sup>45</sup>, methyl alcohol<sup>46</sup> and ethyl alcohol<sup>47</sup>.

In this study it was proposed to examine the spectra of a number of thallium (I) salts in aqueous and non-aqueous solutions, and to correlate spectral data with polarographic and conductometric work. The work centered on the behavior of  $TlOAc$  in acetonitrile and water solutions: the formation of ion-pairs, and the interpretation of ultraviolet absorption spectra.

## Chapter 2

### Ultraviolet Spectroscopy of the Thallium (I) Ion

#### BACKGROUND

Thallium (I) ion,  $Tl^+$ , with 80 electrons and the ground state electronic configuration of  $(Xe)4f^{14}5d^{10}6s^2$ , is isoelectronic with atomic mercury ( $Hg^0$ ). The electronic absorption of isolated  $Tl^+$  ion which involves only the valence shell electron gives rise to 'Rydberg' spectra, typically the s-p transition. The ground state term of gaseous free  $Tl^+$  ion is  $^1S_0$  and the terms for the first low lying excited state of configuration  $6s^16p^1$  are in order of increasing energy,  $^3P_0$ ,  $^3P_1$ ,  $^3P_2$  and  $^1P_1$ . The energies of the five lowest levels for gaseous free  $Tl^+$  ion are given in Table I and the Grotrian diagram is shown in Fig. 1.

TABLE I  
Energy Levels of gaseous free  $Tl^+$  ion

Spectral term	Energy <sup>a, b</sup>	
	$E_{max}$ ( $cm^{-1}$ )	eV
$^1S_0$	0*	0
$^3P_0$	49,451	6.13
$^3P_1$	52,393	6.49
$^3P_2$	61,725	7.65
$^1P_1$	75,660	9.38

<sup>a</sup> See reference 48.    <sup>b</sup> See reference 49.

\* Value relative to limit of  $6s^1nd^1\ ^3D_1$  series  $164,800\ cm^{-1}$  or  $20.33\ eV$ .

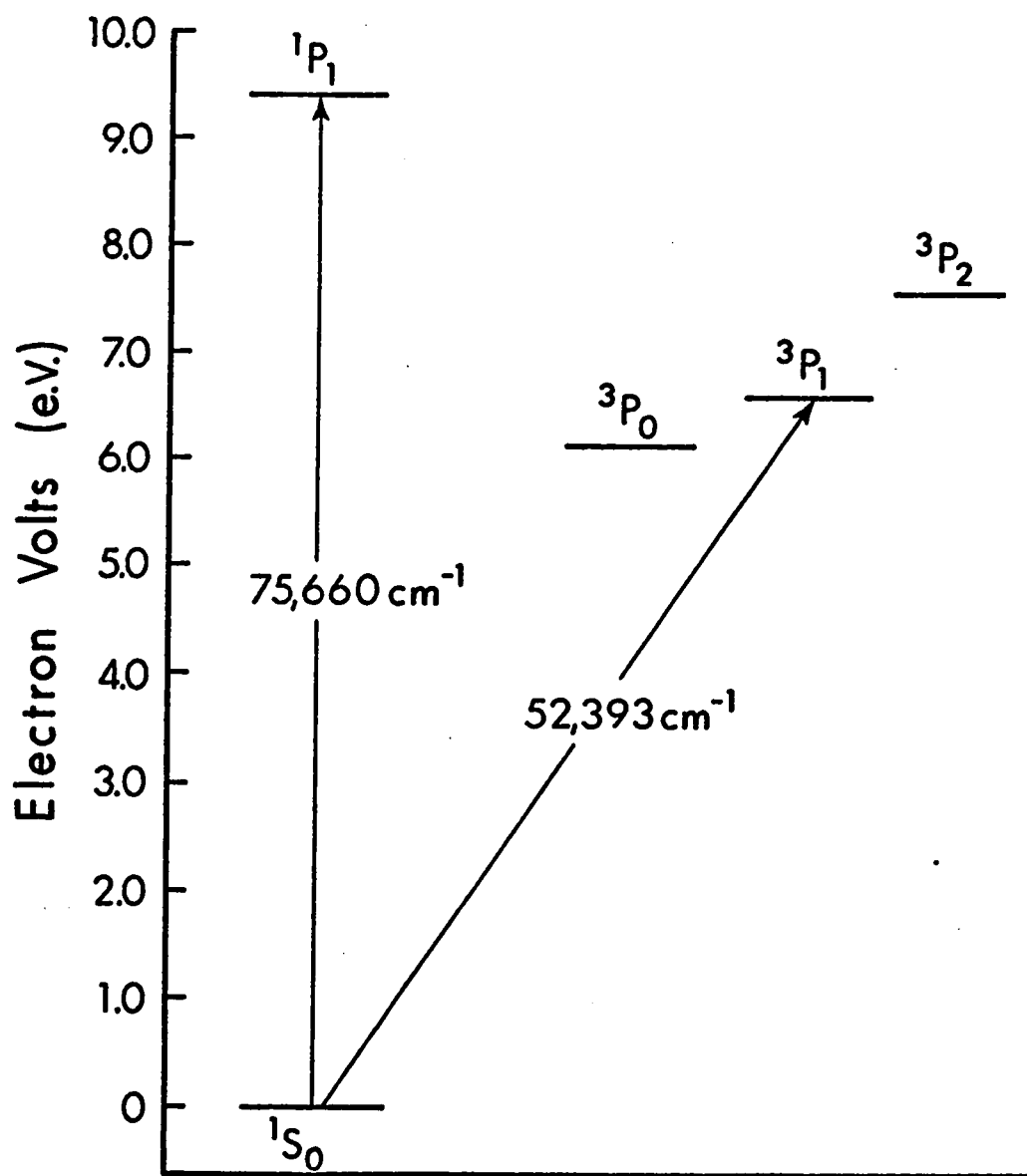

Figure 1. The Grotrian diagram of gaseous free  $Ti^+$  ion.

The allowed transitions from the ground states ( $^1S_0$ ) are to the  $^1P_1$  and  $^3P_1$  levels with strong and medium relative intensities, respectively, i.e., the  $^3P_1 \leftarrow ^1S_0$  transition has a smaller transition probability, owing to only partial mixing of the two terms by spin-orbit coupling, than that of the  $^1P_1 \leftarrow ^1S_0$  transition.

The absorption and emission spectra of  $Tl^+$  ion have been studied extensively in different media<sup>13,14,20-25</sup>. The spectra of thallium-doped alkali halides have been investigated by several workers<sup>20-22,50-52</sup>. The first theoretical explanation of the absorption spectra was interpreted by Seitz<sup>20</sup> in terms of electronic transitions within the  $Tl^+$  ion perturbed by the surrounding crystal field. Williams<sup>53,54</sup> calculated quantitatively the configurational coordinate model of the center.

Seitz<sup>20</sup> suggested a model based on the excited states of a free  $Tl^+$  ion in a cubic field, i.e., a single  $Tl^+$  ion occupying an alkali metal ion site in a sodium chloride type lattice. The schematic diagram showing the effect of the crystal field on the energy levels of  $Tl^+$  ion is shown in Fig. 2<sup>20,22</sup>. The allowed spectral transitions for  $Tl^+$  ion in a cubic field,  $O_h$ , are presented in Table II (see reference 55).

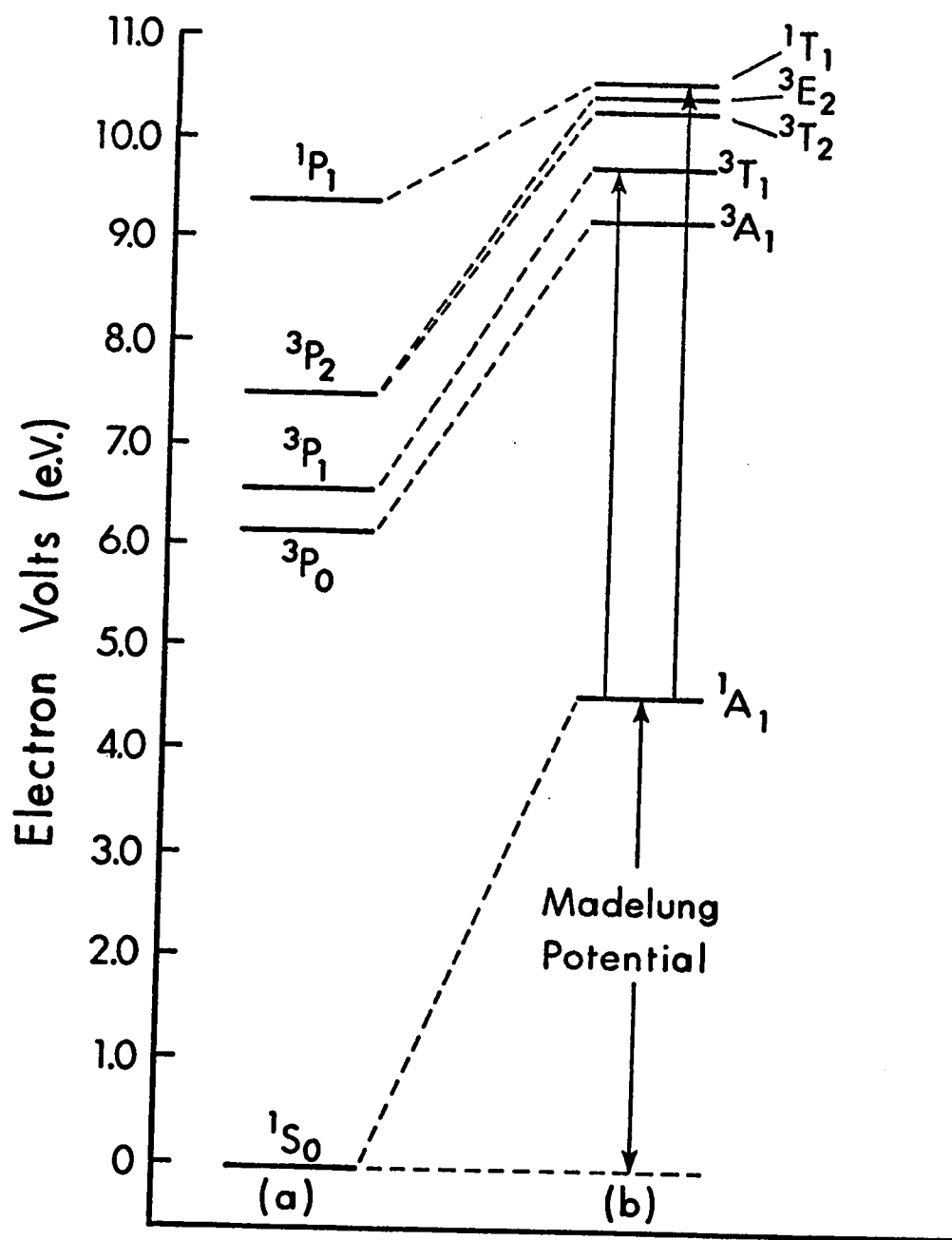

Figure 2. Energy Level Diagram for  $Tl^+$  ion.

(a) gaseous free  $Tl^+$  ion. (b) Cubic symmetry: a single  $Tl^+$  ion occupying a positive ion site in a sodium chloride type lattice.



TABLE II

The spectral states of thallium (I) ion in a cubic field

Spectral term	Representation	Observed relative intensity of transition to state
$^1S_0$	$^1A_1$	(ground state)
$^3P_0$	$^3A_1$	(not observed)
$^3P_1$	$^3T_1$	Medium <sup>†</sup>
$^3P_2$	$^3T_2$ and $^3E_2$	Very weak <sup>‡</sup>
$^1P_1$	$^1T_1$	Strong

<sup>†</sup> Appears as a medium shoulder ( $f \sim 0.1$ ) on the low energy side of the spectrum.

<sup>‡</sup> Observed only in the excitation spectra of  $Tl^+$  in alkali halides.

The study of a thallium-doped potassium chloride<sup>50-52</sup> spectrum showed that  $Tl^+$  ion replaces some  $K^+$  ions in the crystal structure, giving rise to the growth of two principal absorption bands at  $196 m\mu$  and  $247 m\mu$  with a subsidiary one at  $210 m\mu$ . The  $196 m\mu$  band has been attributed to a  $^1P_1 \leftarrow ^1S_0$  transition and the  $247 m\mu$  band to a  $^3P_1 \leftarrow ^1S_0$  transition in  $Tl^+$  ion<sup>53,54</sup>. The  $^3P_1 \leftarrow ^1S_0$  transitions for  $Tl^+$  ion in glasses, e.g. phosphate<sup>24,25</sup>, sulphate<sup>25</sup>, silicate<sup>23</sup>, aluminoborate<sup>24</sup>, and fused silica<sup>24</sup> occur in the region of  $208$  to  $250 m\mu$  (see Table III). Ghosh<sup>24</sup> concluded that a second band at about  $253 m\mu$ , observed from the spectra of  $Tl^+$  ion in fused silica and phosphate glass, is possibly due to a combination of dimers and higher aggregates of  $Tl^+$  ions. The frequency of

the  ${}^3P_1 \leftarrow {}^1S_0$  band for  $Tl^+$  ion in chloride-sulphate glasses has been observed to be blue shifted; the shift increases with an increase in the ratio of sulphate:chloride<sup>25</sup>. Duffy and Ingram<sup>25</sup> suggested that the blue shift can be regarded as corresponding to an increase in the s-p separation, indicative of increasing ionicity in the interaction between  $Tl^+$  ion and surrounding anions. Fromherz and Lih<sup>13</sup>, Fringham and Vogels<sup>56</sup>, Makishima et al.<sup>57</sup> studied the absorption and emission spectra of  $Tl^+$  ion in solutions. In water as solvent, an absorption band is observed at 213  $m\mu$  for thallium (I) salts<sup>13, 24</sup>. In aqueous alkali-halide solutions, the band at 213  $m\mu$  has been observed to shift to about 243  $m\mu$  in  $TlCl-CaCl_2$ <sup>57</sup>, 247  $m\mu$  in  $TlCl-KCl$ <sup>58</sup>, and 265  $m\mu$  in  $TlBr-KBr$ <sup>59</sup> solutions. For  $TlF-KF$  solution the band still remains at 213  $m\mu$ <sup>57</sup>. It is assumed<sup>24</sup> that the same type of thallium center,  $(TlX_n)^{(2n-1)-}$  (where X = anions neighboring the central  $Tl^+$  ion) is present in all systems, e.g.  $(TlO_n)^{(2n-1)-}$  configurations are formed in glasses and in aqueous solution,  $(TlCl_n)^{(2n-1)-}$  and  $(TlBr_n)^{(2n-1)-}$  complexes are formed in the  $TlCl-KCl$  and  $TlBr-KBr$  solutions. The absence of the low energy band in  $TlF-KF$  solution was taken to imply the absence of  $(TlF_n)^{(2n-1)-}$  complexes<sup>24</sup>. Ghosh<sup>24</sup> concluded that the absorption and emission spectra of  $Tl^+$  ion in fused silica, aluminoborate and phosphate glasses are similar to those of thallium-doped alkali halides and solutions. The energies of absorption maxima in different media for the long wavelength band which corresponds to the  ${}^3P_1 \leftarrow {}^1S_0$  transition are given in Table III.

TABLE III  
 Energies of absorption maxima for  $^3P_1 \leftarrow ^1S_0$  transition for thallium(I)  
 ion in various media

Medium	Absorption maxima		Reference
	$E_{\max}(\text{cm}^{-1})$	$\lambda_{\max}(\text{m}\mu)$	
Free ion	52,400	191	59
Sulphate glass	48,000	208	25
Phosphate glass	47,170	212	24
Silicate glass	40,000	250	23
Fused silica	46,948	213	24
Aluminoborate glass	46,296	216	24
KCl crystal	40,421	247	24
KBr crystal	38,162	262	20
KI crystal	34,692	288	20
NaCl crystal	39,291	255	20
NaBr crystal	37,355	268	20
NaI crystal	34,047	294	20
Water	46,948	213	24
KCl solution	41,667	240	13,58
KBr solution	37,736	265	28,58
KF solution	46,948	213	57
CaCl <sub>2</sub> solution	41,152	243	57

From the results shown in Table III, it can be concluded that the shift of the  ${}^3P_1 \leftarrow {}^1S_0$  band corresponds to the change of s-p separation in the energy diagram (see Fig. 2) which is due to the perturbation of  $Tl^+$  ion by the surrounding anions.

Although  $Tl^+$  ion has abnormally strong hydration<sup>60</sup>, it is believed that it is one of the few univalent cations which associate appreciably with anions of low charge<sup>61</sup>. Scott and Hu<sup>27</sup>, who measured the absorption spectra of luminescent  $TlCl$  in  $KCl$  solutions, reported that thallium may be present in the form of  $Tl^+$ ,  $TlCl$  or  $TlCl_2^-$ . The dissociation constants and molar absorptivities for  $TlBr$ ,  $TlBr_2^-$  and  $TlBr_4^{3-}$  were determined by Scott et al.<sup>28</sup>. The ultraviolet absorption spectra of solutions containing  $Tl^+$  and  $OH^-$  ions have been measured by Bell and Panckhurst<sup>14</sup> who showed that there are two distinct absorbing species, i.e., free  $Tl^+$  ion and the associated thallium (I) hydroxide, in the solutions. Association of  $TlClO_4$  in solutions of  $HClO_4$  and certain perchlorates has been found spectrophotometrically by Zagorets and Bulgakova<sup>15</sup>.

Freeman and coworkers<sup>17</sup> have reported that concentrated aqueous solutions of  $Tl^+$  ion and univalent anions may contain ion-pairs in which  $Tl^+$  and the anion are associated long enough to be treated in terms of an equilibrium. In non-aqueous solvents, thallium (I) salts, e.g.  $TlCl$ ,  $TlBr$ ,  $TlI$ ,  $TlOH$  and  $TlOAc$  etc., are probably present, even in dilute solution, largely as ion-pairs.

The various forms of ion-pairs may be shown by the following equilibria where S represents a solvent molecule:

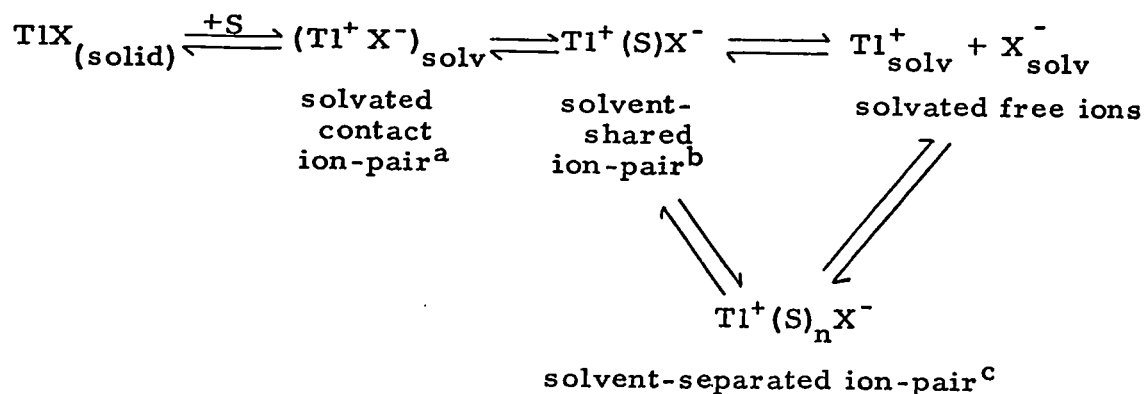

In this chapter thallium (I) acetate is examined spectroscopically, with a detailed study of the acetonitrile system and comparisons with a number of other solvent systems. Spectra are interpreted in terms of ion-pair formation, and the association constant for the ion-pair in acetonitrile is measured.

- 
- <sup>a</sup> Contact ion-pairs are two ions, cation and anion, linked electrostatically with no intervening solvent molecules<sup>33,62</sup>.
- <sup>b</sup> Solvent-shared ion-pairs are two ions, cation and anion, linked electrostatically through a solvent molecule, this molecule being part of the primary solvation shell of both ions<sup>33,62</sup>.
- <sup>c</sup> Solvent-separated ion-pairs are pairs of ions linked electrostatically but separated by more than one solvent molecule<sup>33,62</sup>.

## EXPERIMENTAL

Reagents and Apparatus

Deionized water was prepared by passing distilled water through a 1 m column of mixed bed ion-exchange. Deuterium oxide (Merck Sharp & Dohme) was used as received. The following spectrograde solvents (Matheson Coleman & Bell) were used: acetonitrile, p-dioxane, dichloromethane, bis-(2-methoxy ethyl) ether, methyl alcohol, iso-propyl alcohol, iso-butyl alcohol, iso-pentyl alcohol and n-butyl alcohol. Reagent grades n-propyl alcohol, 95% ethyl alcohol, tert-butyl alcohol, 3,5,5-trimethyl hexanol, cyclohexanol, cyclopentanol, and 1,2-dimethoxy ethane were purified by methods based upon Weissberger<sup>62a</sup>.

Reagent grades (99.9%) TlCl, TlBr, TlI, Tl<sub>2</sub>SO<sub>4</sub>, TlNO<sub>3</sub> (Fisher Scientific Co.); TlF, TlSCN, TlOH, Tl<sub>2</sub>CO<sub>3</sub>, and thallium (I) malonate (TlC<sub>3</sub>H<sub>2</sub>O<sub>4</sub>) (Alfa Inorganics, Inc.); thallium (I) formate, TlCHO<sub>2</sub> (J. T. Baker Chemical Co.) and TlClO<sub>4</sub> (Varlacoid Chemical Co.) were recrystallized from deionized water and properly dried. Ultra-pure grade (99.999%) thallium (I) acetate, TlC<sub>2</sub>H<sub>3</sub>O<sub>2</sub> (Alfa Inorganics, Inc.) was used without further purification; it was dried in a vacuum oven at 60°C for 2 hours and 110°C for 6 hours. Thallium (I) tetrafluoroborate, TlBF<sub>4</sub>, was prepared by the method of Yeager and Kratochvil<sup>37</sup>. In this method a slight excess of an equivalent of 40% fluoroboric acid (Baker and Adamson) was mixed with an equivalent of thallium (I) carbonate. The mixture was filtered and the resulting salt was washed several times with

absolute ethyl alcohol to remove excess acid. The salt was dried at room temperature in a vacuum oven for 1 hour and redried at 50°C for 3 hours and at 105°C for 7 hours. Thallium (I) propionate,  $\text{TlC}_3\text{H}_5\text{O}_2$ , was obtained by mixing a slight excess of an equivalent of propionic acid (J. T. Baker Chemical Co.) with an equivalent of  $\text{TlOH}$ . The resulting salt was washed with acetone to remove excess acid and was dried at 60°C for 2 hours and 105°C for 3 hours in a vacuum oven.

Sodium perchlorate,  $\text{NaClO}_4$  (G. F. Smith Chemical Co.), tetraethylammonium perchlorate,  $\text{Et}_4\text{NClO}_4$  and tetra-n-butylammonium perchlorate,  $(n\text{-Bu})_4\text{NClO}_4$  (Eastman Organic Chemicals) were recrystallized from deionized water and dried in a vacuum oven at 100°C. Tetramethylammonium acetate,  $\text{Me}_4\text{NOAc}$  (Eastman Organic Chemicals) was recrystallized from acetonitrile and dried at 40°C for 12 hours and 60°C for 3 hours in a vacuum oven.

### Spectrophotometry

Electronic absorption spectra were recorded by means of a Cary Model 14, a Jasco ORD-UV 5 and a Unicam SP 800 spectrophotometer. The latter spectrophotometer was used for absorbance measurements in the determination of the association constant of thallium (I) acetate in acetonitrile. All measurements except those designed to study the temperature effect were run at 20°C. Measurements of absorption spectra at fixed temperatures were carried out on the Cary spectrophotometer using a thermostatted cell-compartment; the temperatures were constant during measure-

ments to about  $\pm 0.1^\circ\text{C}$ . Quartz cells of 1 and 0.1 cm path lengths were used with a matched reference cell filled with solvent.

#### Determination of Association Constant of Thallium (I) Acetate in Acetonitrile

The Unicam SP 800 spectrophotometer was used to measure the absorption spectra of thallium (I) perchlorate and acetate in acetonitrile solutions. All solutions were prepared by weight, and thermostatted at  $25 \pm 0.1^\circ\text{C}$  during measurement. Tetra-n-butylammonium perchlorate (about 0.01 M) was used to maintain constant ionic strength. The density of acetonitrile is 0.7785 g./ml which was used to convert the concentration of all solutions to molarities. A mixing chamber shown in Fig. 3, designed by Long<sup>63</sup> was used to mix separate solutions and make spectral measurements without exposure to the atmosphere. A 200 ml volumetric flask was modified by addition of a side arm to which a conventional 1 cm rectangular quartz cell was connected by a lapped standard taper joint. The standard taper flask stopper was machined from Teflon and contained a silicone rubber septum through which solutions could be injected. The injections of tetramethylammonium acetate in acetonitrile solution to the solution of thallium (I) perchlorate were made by using a 100- $\mu\text{l}$  Hamilton gas-tight syringe equipped with a Teflon-tipped plunger, Chaney adaptor and platinum needle.

#### Method of Association Constant Measurement

The mole ratio method was used to determine the association constant of thallium (I) acetate in acetonitrile. This method



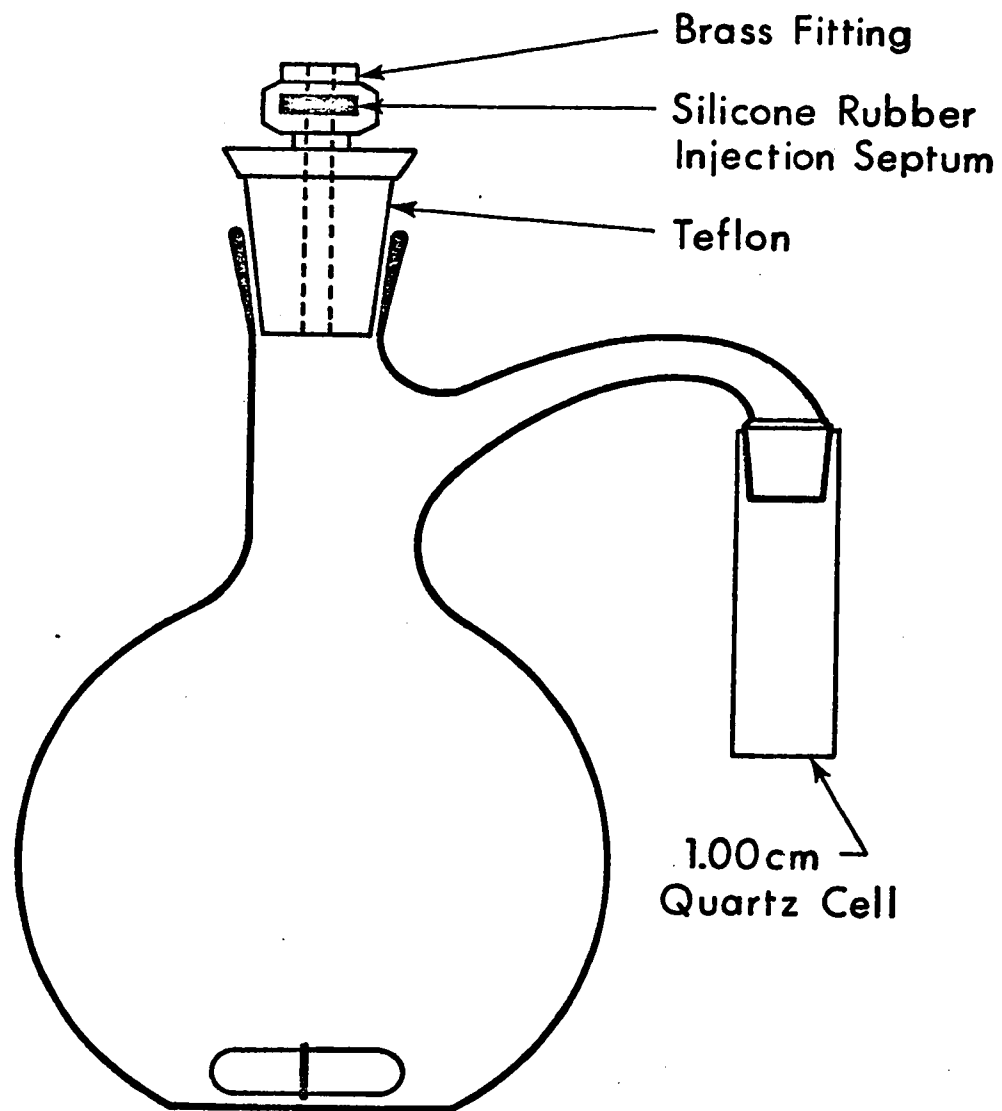

Figure 3. Spectrophotometry cell used in association constant determinations.

involves absorbance measurements of a solution in which the concentration of one species is held constant while that of a second is varied. The absorbance measurements were made at  $255\text{ m}\mu$  which was the wavelength maximum of the ion-pair of  $\text{TlOAc}$ .

In this experiment, about 10 to 15 mg of thallium (I) perchlorate was weighed in a Teflon cup (1/4 inch high x 1/4 inch I.D.) with a Sartorius analytical balance. The salt cup was placed in the mixing chamber along with the 1 cm cell and a Teflon stirring bar and a solution (about  $1.0 \times 10^{-2}\text{ M}$ ) of tetra-n-butylammonium perchlorate in purified acetonitrile (used to maintain constant ionic strength). The solution was stirred, and the absorption spectrum of  $\text{TlClO}_4$  in acetonitrile was run over the wavelength region between 200 and  $325\text{ m}\mu$ . At the same time a concentrated solution of tetramethylammonium acetate in acetonitrile was prepared and analyzed for accurate concentration by direct titration with standard perchloric acid in glacial acetic acid. The acetate solution was then injected into the chamber and the solution was stirred. The absorbance values of the ion-pair of  $\text{TlOAc}$  were measured at  $255\text{ m}\mu$  and plotted as a function of the acetate concentration.

## RESULTS AND DISCUSSION

Absorption spectra of thallium (I) salts in polar solvents

A survey of the absorption spectra of thallium (I) salts was made in water, methyl alcohol and acetonitrile. It was found that all of the salts used in this study gave a single absorption band at 213  $m\mu$  in water and 219  $m\mu$  in methyl alcohol. These bands are asymmetric and independent of the anions present. The absorption maxima of the salts in acetonitrile are summarized in Table IV.

The absorption bands in the region between 209-220  $m\mu$  shown in Table IV are attributed to solvated free  $Tl^+$  ion. This was confirmed by the presence of only one band in the same region as observed from thallium (I) perchlorate and tetrafluoroborate solutions. On the other hand, the low energy bands at 242-256  $m\mu$  region observed in acetonitrile are attributed to ion-pairs. As shown in Table IV, there is a red shift for the low energy bands as covalency increases in  $Tl^+$  ion-anion interaction (i. e. , on going from the hydroxide, chloride, formate to propionate ion-pairs), that is, a decrease in the s-p separation. Both absorption bands due to solvated free  $Tl^+$  ion and its ion-pairs are attributed to a  $^3P_1 \leftarrow ^1S_0$  transition.

It is seen that  $TlClO_4$  and  $TlBF_4$  show only single absorption band at 212  $m\mu$  whereas  $TlCl$ ,  $TlOH$  and  $TlOAc$  etc. have two bands in acetonitrile, i. e. , one band due to solvated free  $Tl^+$  ion and the

TABLE IV

Absorption maxima of thallium (I) salts in acetonitrile

Compound	$\lambda_{\max}$ (m $\mu$ )
TlF	210
TlCl	209 (sh), 245
TlBr	209 (sh), 246 <sup>a</sup>
TlI	209 (sh), 247 <sup>b</sup>
TlOH	209 (sh), 242
TlSCN	210 (sh), 260 <sup>c</sup>
TlNO <sub>3</sub>	210
TlClO <sub>4</sub>	212
TlBF <sub>4</sub>	212
TlOOCH (formate)	216 (sh), 254
TlOOCCH <sub>3</sub> (acetate)	218 (sh), 255
TlOOCCH <sub>2</sub> CH <sub>3</sub> (propionate)	220 (sh), 256

sh = shoulder

a,b,c Anion absorption interferences.

other to ion-pairs. It would seem that the first two salts are completely dissociated in acetonitrile while the latter salts are not. It has been reported<sup>37</sup> that  $TlClO_4$  and  $TlBF_4$  show some association in acetonitrile with the values of association constants of 32 and 14, respectively. However, the concentrations of associated  $TlClO_4$  and  $TlBF_4$  are probably not high enough to give rise to observable bands.

Absorption spectra of thallium (I) acetate in pure solvents and binary aqueous solvent mixtures

The wavelengths of maximum absorption ( $\lambda_{max}$ ) found for  $TlOAc$  in various solvents at 20°C are presented in Table V and some examples of change in absorption spectra with solvent are shown in Fig. 4.

From the results summarized in Table V, two classes of solvent can be distinguished as follows:

(i) solvents having dielectric constants greater than about 20, in which the solvated free  $Tl^+$  ion predominates,

(ii) solvents having dielectric constants less than about 20, in which ion-pairs can form.

Absorption bands occurring in solvents of class (i) were observed in the region of 210-220  $m\mu$  and those formed in solvents of class (ii) were found in the 238-264  $m\mu$  region; with the exception that solutions of p-dioxane and acetonitrile showed two absorption bands, one at 218-220  $m\mu$ , the other at 255-258  $m\mu$ . This anomaly will

TABLE V  
Wavelength maxima of the absorption spectra of thallium (I) acetate  
in various solvents

Solvent	Dielectric constant <sup>a</sup>	$\lambda_{\max}$ (m $\mu$ )
Water	80.4	213
Heavy water (D <sub>2</sub> O)	79.8	212
Methyl alcohol	33.6 <sup>b</sup>	219
Ethyl alcohol	25.0 <sup>b</sup>	220
n-Propyl alcohol	20.8 <sup>b</sup>	238
iso-Propyl alcohol	18.6 <sup>b</sup>	241
n-Butyl alcohol	17.8	239
iso-Butyl alcohol	17.7	239
tert.-Butyl alcohol	10.9	242
iso-Pentyl alcohol	14.7	239
3,5,5-Trimethyl hexanol	-	239
Cyclopentyl alcohol	-	242
Cyclohexyl alcohol	15.0	243
p-Dioxane	2.2	220 (sh), 258
1,2-Dimethoxy ethane	7.2	252
Bis-(2-methoxyethyl) ether	-	244
Dichloromethane	9.1	264
Acetonitrile	36.4 <sup>c</sup>	218 (sh), 255

<sup>a</sup>Reference 4.    <sup>b</sup>Reference 64.    <sup>c</sup>Reference 65.

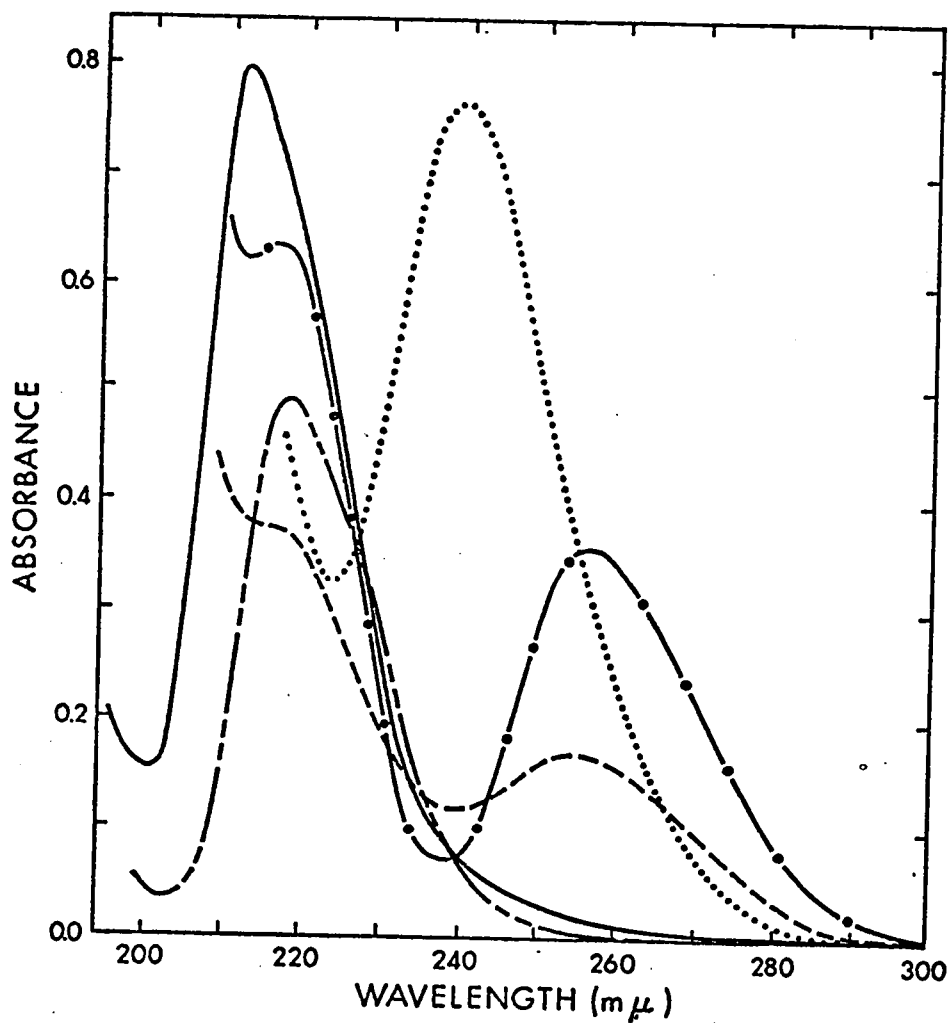

Figure 4. Thallium (I) acetate spectrum in water ( ——— ),  

p-dioxane (— · — · —), methyl alcohol (---), iso-propyl  
 alcohol (·····), and acetonitrile (- - - - -) at 20°C: 1-mm cell.

be discussed later.

It appears that solvent changes affect the absorption maximum of the band due to solvated free  $Tl^+$  ion, i.e., the more polar the solvent, the higher the energy (shorter wavelength) of the absorption band. Polar solvents interact electrostatically with  $Tl^+$  ion and tend to stabilize the ground state more than less polar solvents, giving rise to a decrease in s-p separation with decreasing polarity of the solvent. No similar trend was observed in the shift of bands due to ion-pairs. It should be noted that there is no simple correlation between the bulk dielectric constant of the solvent and the absorption maxima of the bands observed in the two classes.

Addition of water to a solution of  $TlOAc$  in iso-propyl alcohol resulted in the rise of one band and the diminution of the other as represented by a superimposition of the spectra; the relative amounts of each spectrum present being a function of the solvent composition (described as a 'band change'<sup>66</sup>). This is illustrated by the spectra shown in Fig. 5. These spectra indicate clearly the presence of two distinct absorbing species in the solvent system. This behavior is quite different from those found in ethyl alcohol/water and methyl alcohol/water mixtures. In these mixtures only a progressive shift of absorption band from its position in one solvent to its position in the other without any abrupt change in the band shape and intensity was observed (described as a 'band shift'<sup>66</sup>). Figure 6 shows the process examined in ethyl alcohol/water system. The band change process was also observed when small amounts of



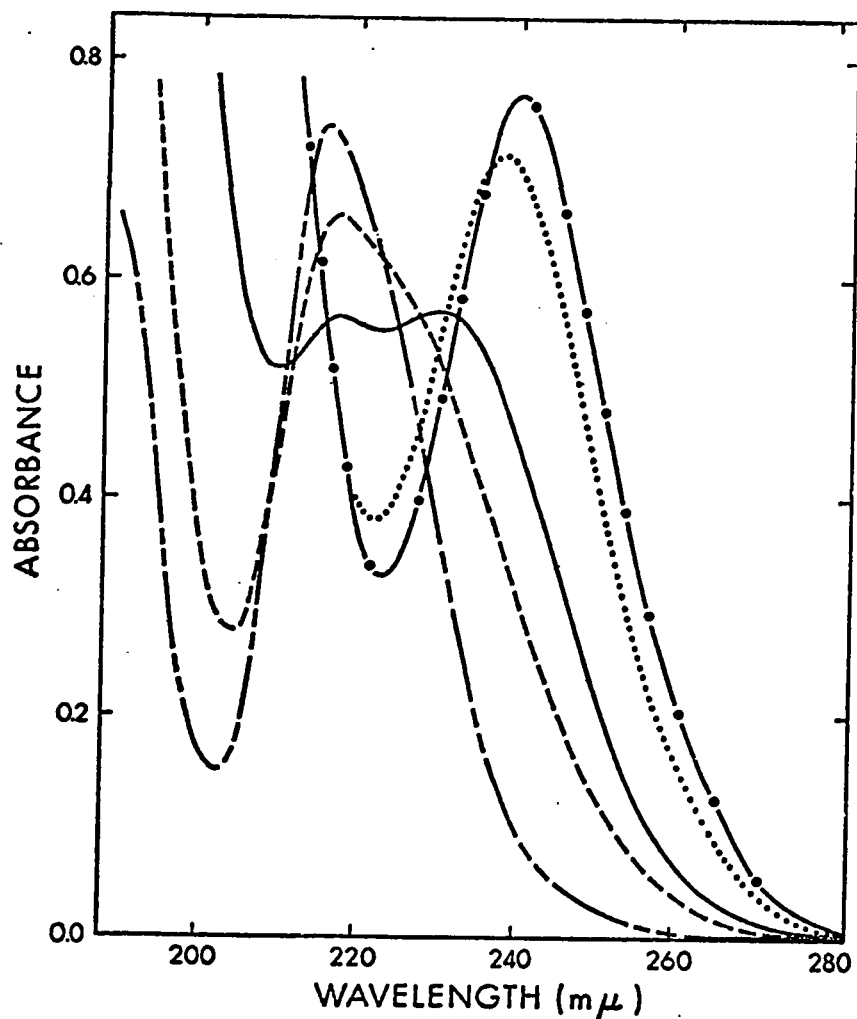

Figure 5. Absorption spectrum of thallium (I) acetate in iso-propyl alcohol on addition of water at 20°C.

$[Tl^+] = 2.0 \times 10^{-3} M$ ; 1 mm cell.

- · — · — · Pure iso-propyl alcohol
- 2.5% (v/v) water added
- 9.0% (v/v) water added
- 13% (v/v) water added
- 23% (v/v) water added

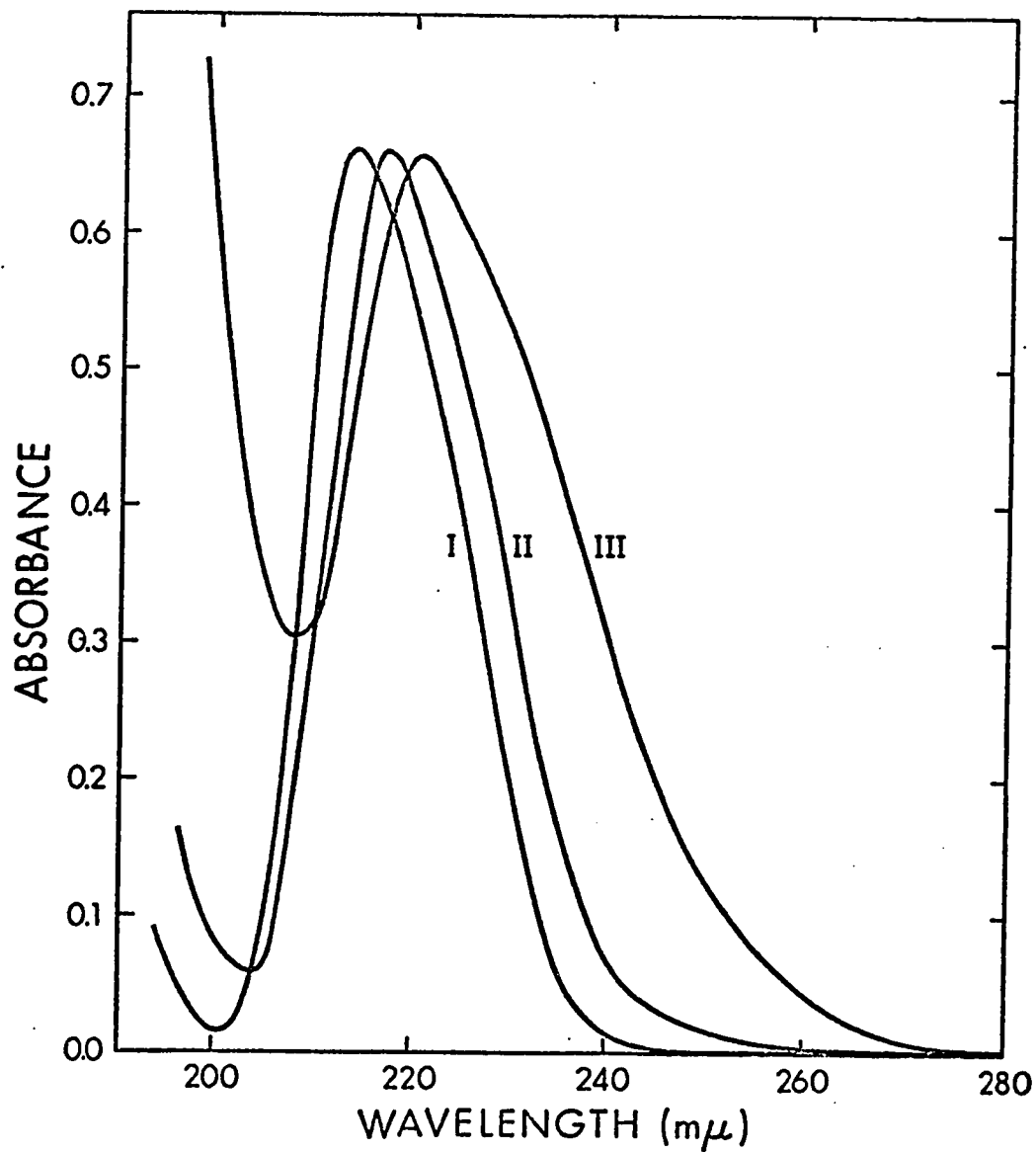

Figure 6. Thallium (I) acetate spectrum in water (curve I), 25% ethyl alcohol/water (curve II), ethyl alcohol (curve III) at 20°C in 1 mm cell:  $[Tl^+] = 1.4 \times 10^{-3} \text{ M}$ .

methyl alcohol were added to solutions of TlOAc in iso-propyl alcohol, indicating that the absorbing species present in methyl alcohol solutions is different from that existing in iso-propyl alcohol. The results are shown in Fig. 7. All of this is strong evidence that the absorbing species existing in water, methyl alcohol, and ethyl alcohol are of the same type, i. e. , solvated free  $Tl^+$  ion, while those found in iso-propyl alcohol and iso-propyl alcohol-rich systems are ion-pairs. In addition, the absorption bands in the 238-243  $m\mu$  region observed from other alcohols (e.g. tert.-butyl alcohol, iso-pentyl alcohol and cyclohexyl alcohol etc.) are assumed to be due to ion-pairs. In  $C_3$  and higher alcohols, however, the structure of the solvent appears to play a great role on the shift of the absorption bands due to ion-pairs; for example, in primary alcohols the bands were found in the 238-239  $m\mu$  region whereas secondary or tertiary alcohols shift the bands to longer wavelengths (e.g. 241-243  $m\mu$ ). These observations are consistent with the concept that the hydroxyl (OH) group in secondary and tertiary alcohols is hindered sterically by the alkyl (R-) groups.

Thallium (I) acetate behaves anomalously in p-dioxane and acetonitrile: in both solvents it shows two absorption bands at similar wavelengths (see Table V), in spite of the much lower dielectric constant of p-dioxane compared to acetonitrile.

In p-dioxane only contact ion-pairs might be expected because the solvent possesses a very low dielectric constant and appears to

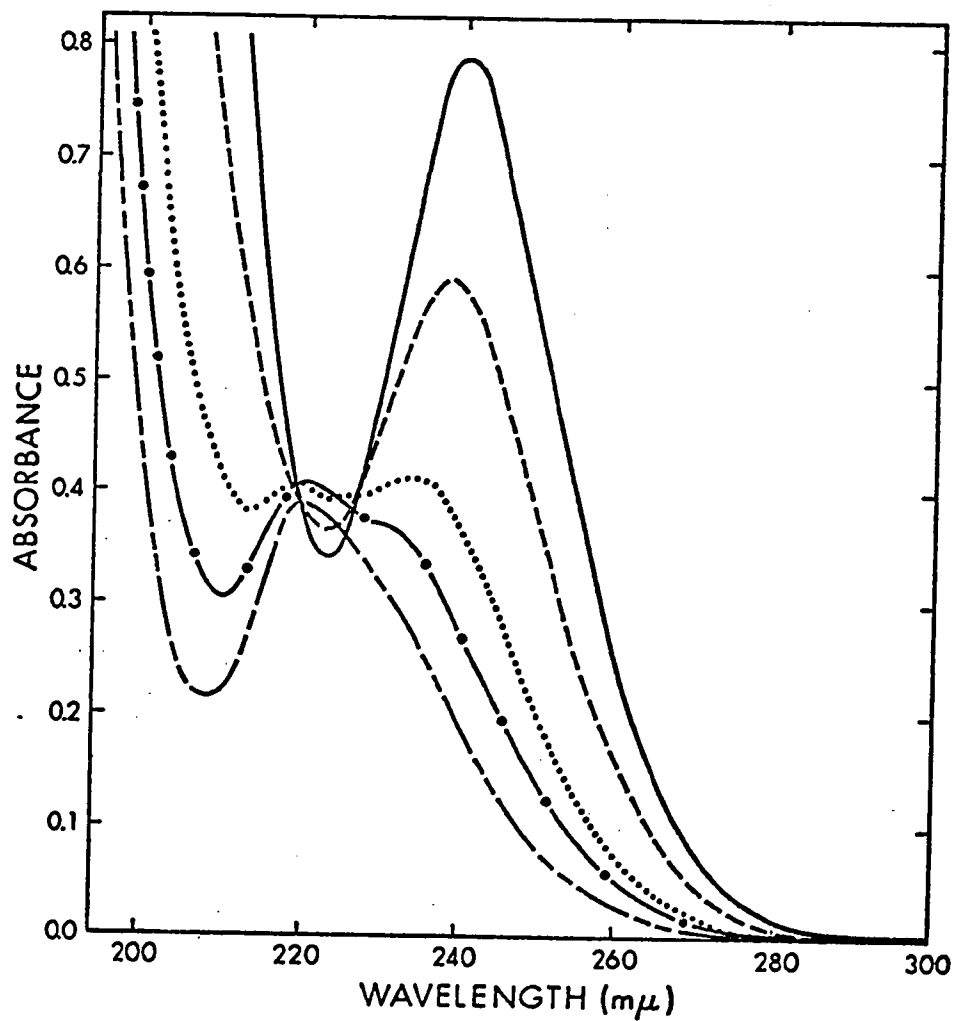
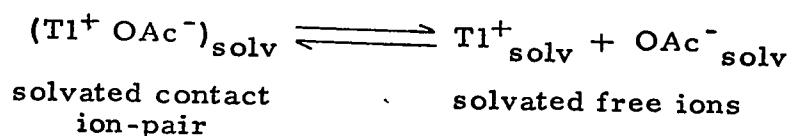

Figure 7. Absorption spectrum of thallium (I) acetate in iso-propyl alcohol on addition of methyl alcohol at 20°C.

$[Tl^+] = 2.1 \times 10^{-3} \text{ M}$ ; 1 mm cell

- Pure iso-propyl alcohol
- 16.6% (v/v) methyl alcohol added
- ..... 33.3% (v/v) methyl alcohol added
- · - · - · 41.1% (v/v) methyl alcohol added
- - - - - 50.0% (v/v) methyl alcohol added

be a poor solvating agent for cations. Hogen-Esch and Smid<sup>67</sup> reported that only contact ion-pairs of fluorenyl salts of alkali metals were found in the solvent. Thus, the observation of two absorption bands in the spectrum of TlOAc in p-dioxane is surprising. The most probable explanation for this anomaly is that the strong positive field of the Tl<sup>+</sup> ion may displace the chair-boat equilibrium for dioxane from its thermodynamically stable chair form to the boat conformation<sup>68</sup>, giving rise to bidentate coordination and a stable solvation of Tl<sup>+</sup> ion. Although the chair form of p-dioxane has a small molecular dipole moment, the C-O bonds are polar; and it is this fact which enables the solvent to retain contact ion-pairs in solution. The band due to contact ion-pairs was found at 258 m $\mu$ . The two absorbing species, e.g. solvated contact ion-pair and solvated free Tl<sup>+</sup> ion are presumably in equilibrium with each other in the solution as shown by



A strong dependence of the absorption spectra upon water concentration was observed for TlOAc but not for TlClO<sub>4</sub> in p-dioxane/water mixtures, suggesting that an equilibrium was occurring between free and associated species in TlOAc solutions. The changes in absorption maxima with solvent composition for TlOAc and TlClO<sub>4</sub> in p-dioxane/water mixtures are given in Table VI. A dramatic change was observed for TlOAc in the mixtures, for example, only 5% of water (see 95% dioxane solution) was

required to shift the low energy band due to contact ion-pairs at 258  $m\mu$  to 245  $m\mu$ ; when about 50% water was added, all of the ion-pairs appeared to be converted to solvated free  $Tl^+$  ion since only a single absorption band was observed at 216  $m\mu$ .

TABLE VI

Absorption maxima of  $TlOAc$  and  $TlClO_4$  in p-dioxane/water mixtures

% (w/w) <u>p</u> -Dioxane	Dielectric constant <sup>a</sup>	$\lambda_{max}$ ( $m\mu$ )	
		$TlOAc$	$TlClO_4$
100	2.2	220, 258	220
95	3.5	219, 245	219
80	11.5	216, 238	218
50	35.5	216	216
0	80.4	213	213

<sup>a</sup> Interpolated value at 20°C obtained from the data given in reference 69.

In comparison with  $TlOAc$ , no ion-pairs were observed from the solutions of  $TlClO_4$  in pure p-dioxane and in p-dioxane/water mixtures. The absorbing species responsible for the bands in the region between 213 to 220  $m\mu$  is the solvated free  $Tl^+$  ion. The effect of solvent, e.g. bulk dielectric constant, on the absorption maximum of  $TlClO_4$  is shown in column 4 of Table VI.

Hogen-Esch and Smid<sup>67</sup> and Chan and Smid<sup>70</sup> reported that in ethereal solvents, all fluorenyl salts of alkali ions are present

as ion-pairs. On this basis, the absorption bands of TlOAc observed at 252 and 244  $m\mu$  from the solutions of 1,2-dimethoxy ethane and bis-(2-methoxyethyl) ether, respectively, are attributed to ion-pairs.

In acetonitrile as solvent, the absorption band due to solvated free  $Tl^+$  ion was observed at 218  $m\mu$  and that due to ion-pairs observed at 255  $m\mu$ . Although acetonitrile has a reasonably high dielectric constant and high dipole moment, as a Lewis base it stabilizes cations moderately well, but does not solvate anions to any appreciable extent. The attraction, presumably partly covalent, between the solvated free  $Tl^+$  and  $OAc^-$  ions may approach or exceed the thermal energy of the ions, leading to association of the two ions to form an ion-pair or a complex.

Addition of tetramethylammonium acetate to a solution of thallium (I) perchlorate in acetonitrile resulted in a decrease of the intensity of the solvated free  $Tl^+$  band at 212  $m\mu$  and the simultaneous production of a new band identical with the low energy band of TlOAc in acetonitrile at 255  $m\mu$ . The intensity of the 255  $m\mu$  band increased with increasing quantities of added acetate ion. The high energy band appeared to shift from 212 to 218  $m\mu$  upon the addition of acetate ion, presumably due to the strong absorption of the acetate ion at the tail of the band on the high energy side. It is obvious that the band observed at 255  $m\mu$  is due to TlOAc ion-pairs. The similarity between the absorption spectrum of TlOAc in acetonitrile and that of  $TlClO_4$  with added acetate ion in the same solvent can be seen from the curves shown in Fig. 8.

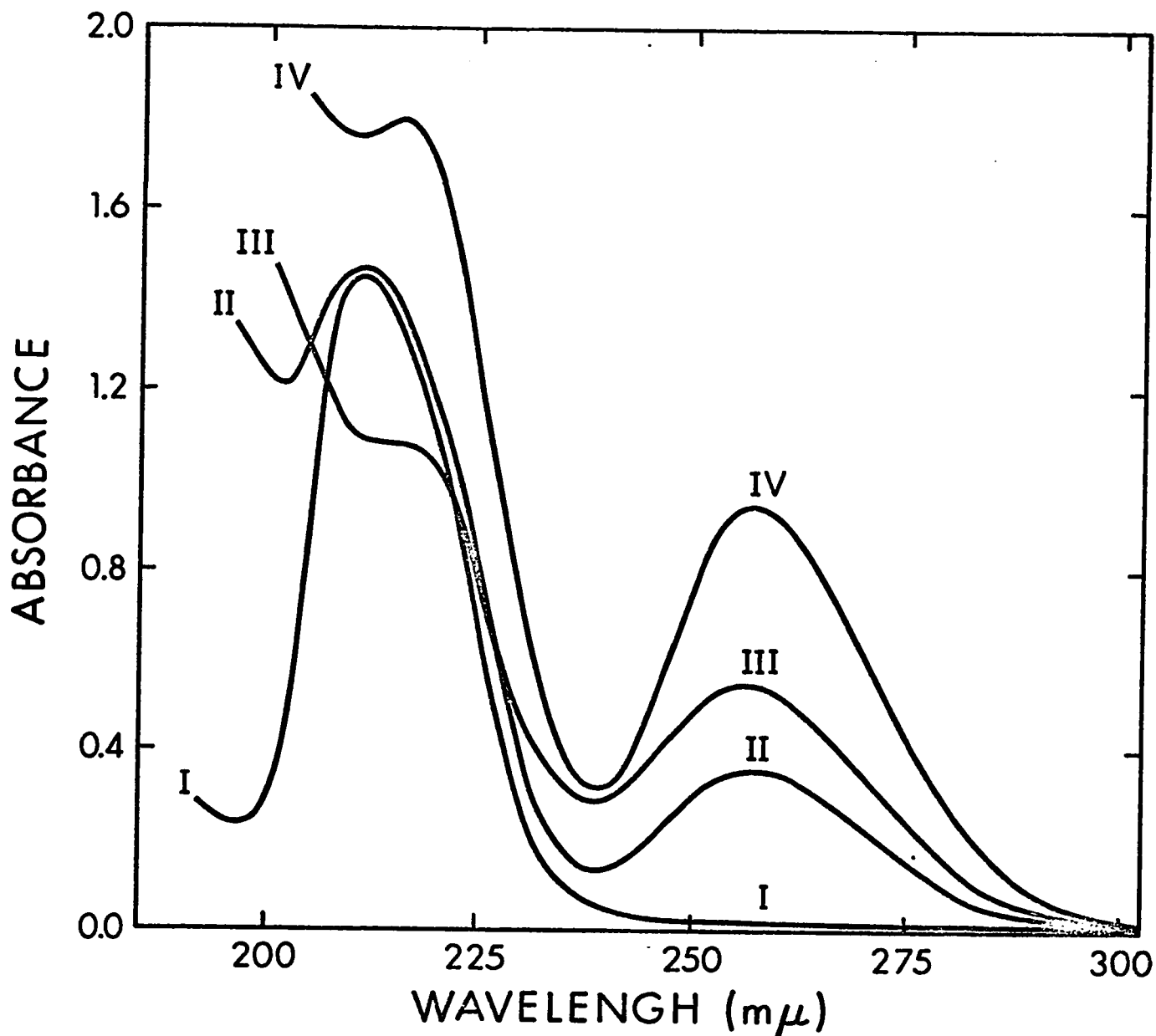

Figure 8. Absorption spectra of  $\text{TlClO}_4$ ,  $\text{TlClO}_4$  with added acetate ion, and  $\text{TlOAc}$  in acetonitrile at  $20^\circ\text{C}$ : 1 cm cell.

Curve I -  $\text{TlClO}_4$  ( $3.42 \times 10^{-4} \text{ M}$ )

Curve II  $\text{TlClO}_4$  ( $3.42 \times 10^{-4} \text{ M}$ ) +  $\text{Me}_4\text{NOAc}$  ( $1.42 \times 10^{-4} \text{ M}$ )

Curve III -  $\text{TlOAc}$  ( $1.90 \times 10^{-4} \text{ M}$ )

Curve IV -  $\text{TlClO}_4$  ( $3.42 \times 10^{-4} \text{ M}$ ) +  $\text{Me}_4\text{NOAc}$  ( $3.35 \times 10^{-4} \text{ M}$ )



The effect of added polar solvents, e.g. water and methyl alcohol on the absorption spectrum of TlOAc in acetonitrile was examined. Again, the band change phenomenon was observed, as in the addition of the two solvents to solutions of TlOAc in iso-propyl alcohol; i.e., the low energy band shifted to shorter wavelength with a decrease in intensity and simultaneously the intensity of the high energy band increased with increasing amounts of the two solvating agents. It was found that a smaller quantity of water than of methyl alcohol was required to convert the band due to ion-pairs of TlOAc in acetonitrile to the band due to solvated free  $Tl^{+}$  ion.

At this point, it is possible to conclude that the absorbing species existing in solvents of class (ii) (e.g. dielectric constant less than about 20) consist of two distinct types classified according to the location of the absorption bands; viz. solvent-shared or solvent-separated ion-pairs (238-244  $m\mu$ ) and contact ion-pairs (252-264  $m\mu$ ). In addition, it appears that the solvating properties of the solvent rather than its dielectric constant are of prime importance.

Determination of Association constant of Thallium (I) Acetate  
in Acetonitrile at 25°C.

Quantitative treatment of absorption spectra and data

Ion association in a solution of TlOAc may be expressed by the following equilibrium:

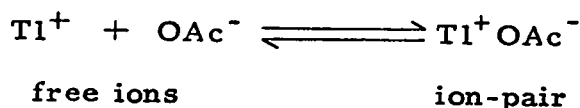

It is assumed that the ion-pair and free  $Tl^+$  ion have characteristic molar absorptivities at their wavelength maxima, and that the equilibrium between these species conform to the law of mass action. At a given concentration the 'thermodynamic association constant',

$$K_A = \frac{[Tl^+ OAc^-] f_{Tl^+ OAc^-}}{[Tl^+] [OAc^-] f_{Tl^+} f_{OAc^-}} \quad (1)$$

or

$$K_A \frac{f_{Tl^+} f_{OAc^-}}{f_{Tl^+ OAc^-}} = \frac{[Tl^+ OAc^-]}{[Tl^+] [OAc^-]}$$

where the bracket represents concentration in moles/liter,

$f_{Tl^+ OAc^-}$  = activity coefficient of the ion-pair (assumed to be unity),

$f_{Tl^+}$  and  $f_{OAc^-}$  = activity coefficients of free  $Tl^+$  and  $OAc^-$  ions, respectively.

Since at low concentrations the activity coefficients approach unity and in solutions of constant ionic strength are approximately constant, it is possible to write a 'concentration association constant',  $K'_A$ , as given by equation (2)

$$K'_A = \frac{[Tl^+ OAc^-]}{[Tl^+] [OAc^-]} \quad (2)$$

where  $K'_A$  is dependent upon total ionic strength. Then

$$K'_A = K_A \frac{f_{Tl^+} f_{OAc^-}}{f_{Tl^+ OAc^-}} \quad (3)$$

Since  $[Tl^+] = [Tl^+]_{Total} - [Tl^+OAc^-]$

and  $[OAc^-] = [OAc^-]_{Total} - [Tl^+OAc^-]$

therefore

$$K'_A = \frac{[Tl^+OAc^-]}{([Tl^+]_{Total} - [Tl^+OAc^-])([OAc^-]_{Total} - [Tl^+OAc^-])} \quad (4)$$

The association constant for the TlOAc ion-pair summarized in Table VII was obtained from the expression shown in equation (4). Absorbance values were measured at 255  $m\mu$  and a plot of absorbance against acetate concentration was made. A typical plot obtained from trial 1 of Table VII is shown in Fig. 9. The plot shows a straight-line relationship up to 1:1 mole ratio of  $Tl^+$  to  $OAc^-$  ions. The straight line starts to curve after a mole ratio of about 1:1 is reached owing to dissociation of the ion-pair, and indicating that the absorbing species observed at 255  $m\mu$  is a contact ion-pair or a 1:1 complex. The molar absorptivity of the ion-pair was obtained from the slope of the straight line. The slope value was measured at large  $[Tl^+]$  to  $[OAc^-]$  ratios and the concentration of the ion-pair at small ratios.

The absorption spectra of the TlOAc ion-pair were recorded at varying ratios of  $[Tl^+]$  to  $[OAc^-]$ , and are shown in Fig. 10. Results of the association constant determinations for the ion-pair are listed in Table VII. Overall average of  $\log K'_A$  for trials 1 through 3 is  $5.7 \pm 0.2$ .

TABLE VII

Data for Determination of Association Constant of Thallium (I) Acetate  
Ion-Pair in Acetonitrile at 25°C

## TRIAL I

$$[\text{Tl}^+]_{\text{Total}} = 3.42 \times 10^{-4} \text{ M}$$

Molar absorptivity = 3,000

$[\text{OAc}^-]$ $\times 10^4 \text{ M}$	$\frac{[\text{Tl}^+]}{[\text{OAc}^-]}$	$A_{255}$	$[\text{Tl}^+\text{OAc}^-]$ $\times 10^4 \text{ M}$	$K'_A$ $\times 10^{-5}$	$\log K'_A$
0.096	35.6	0.020			
0.383	8.93	0.100			
0.763	4.48	0.220			
1.14	3.00	0.330			
1.51	2.26	0.450			
1.90	1.80	0.560	1.87	4.02	5.60
2.26	1.51	0.670	2.23	6.25	5.80
2.64	1.30	0.780	2.60	7.93	5.90
3.00	1.14	0.880	2.93	8.54	5.93
3.35	1.02	0.930	3.10	3.87	5.59
3.53	0.969	0.930	3.10	2.25	5.35
Ave. $\log K'_A =$					5.69

Continued . . .

TABLE VII - Continued

## TRIAL 2

$$[Tl^+]_{\text{Total}} = 3.84 \times 10^{-4} \text{ M}$$

$$\text{Molar absorptivity} = 3,017$$

$[OAc^-]$ $\times 10^4 \text{ M}$	$\frac{[Tl^+]}{[OAc^-]}$	$A_{255}$	$[Tl^+OAc^-]$ $\times 10^4 \text{ M}$	$K'_A$ $\times 10^{-5}$	$\log K'_A$
0.096	40.0	0.020			
0.192	20.0	0.050			
0.384	10.0	0.110			
0.575	6.68	0.160			
0.765	5.02	0.220			
0.960	4.00	0.280			
1.33	2.89	0.400			
1.71	2.25	0.510			
2.08	1.85	0.620	2.05	3.82	5.58
2.45	1.57	0.730	2.42	5.68	5.75
2.82	1.36	0.840	2.78	6.56	5.82
3.18	1.21	0.940	3.11	6.09	5.78
3.54	1.08	1.03	3.41	6.10	5.79
3.72	1.03	1.06	3.51	5.06	5.70
Ave. $\log K'_A = 5.74$					

Continued . . .

TABLE VII - Continued

## TRIAL 3

$$[\text{Tl}^+]_{\text{Total}} = 4.32 \times 10^{-4} \text{ M}$$

Molar absorptivity = 3,000

$[\text{OAc}^-]$ $\times 10^4 \text{ M}$	$\frac{[\text{Tl}^+]}{[\text{OAc}^-]}$	$A_{255}$	$[\text{Tl}^+\text{OAc}^-]$ $\times 10^4 \text{ M}$	$K'_A$ $\times 10^{-5}$	$\log K'_A$
0.048	90.0	0.020			
0.144	30.0	0.040			
0.335	12.9	0.100			
0.574	7.53	0.170			
0.763	5.66	0.230			
0.953	4.53	0.290			
1.42	3.04	0.420			
1.89	2.29	0.560			
2.35	1.84	0.700	2.33	5.85	5.77
2.80	1.54	0.830	2.77	5.96	5.78
3.10	1.39	0.920	3.07	8.19	5.91
3.38	1.28	1.00	3.33	6.73	5.83
3.62	1.19	1.06	3.53	4.96	5.70
3.89	1.11	1.13	3.77	5.71	5.76
4.14	1.04	1.16	3.87	3.18	5.50
Ave. $\log K'_A$					5.75

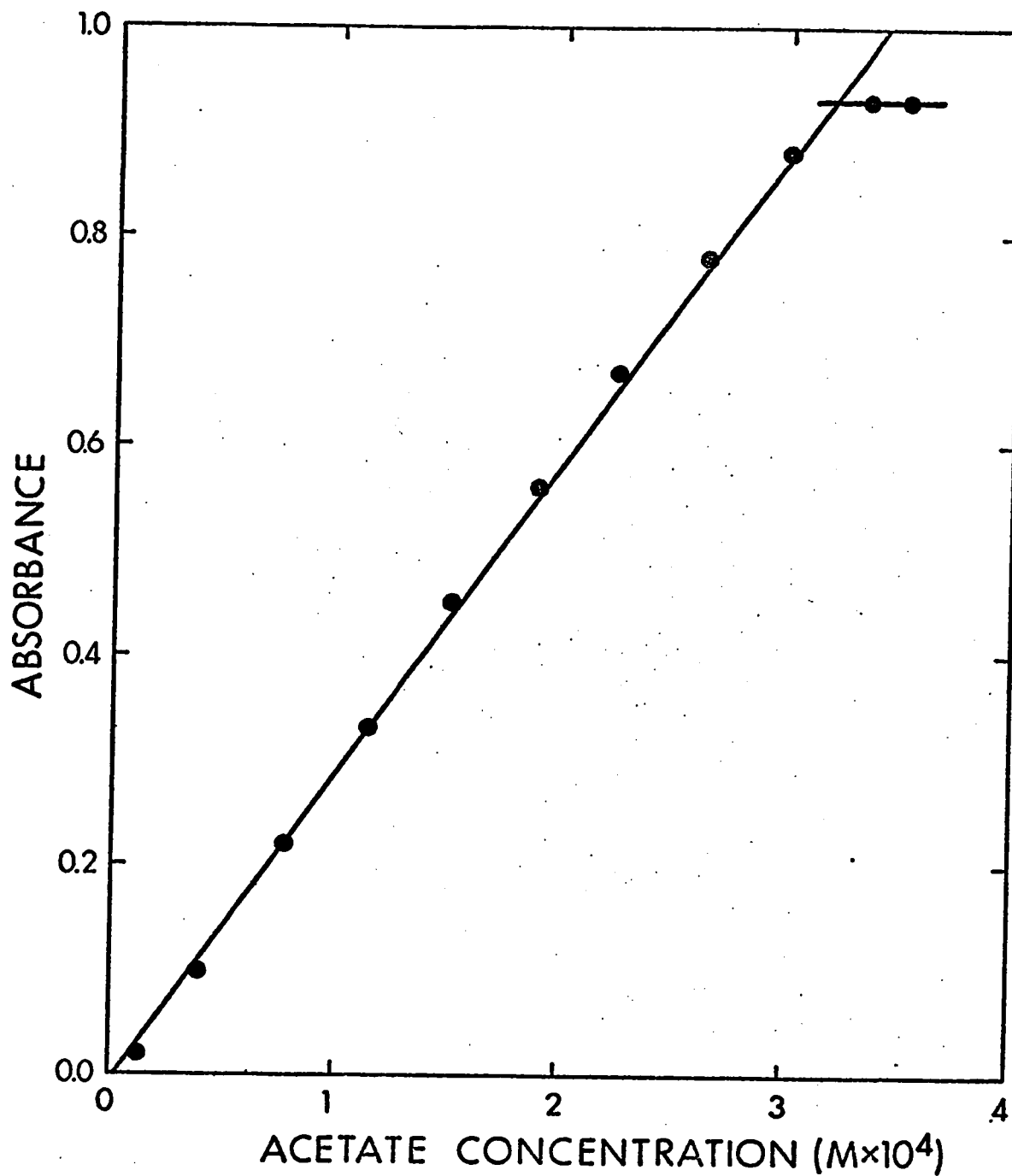

Figure 9. Typical association constant determination plot (acetate added to thallium (I) ion). Data from trial 1 of Table VII.

Figure 10. Absorption spectrum of the TlOAc ion-pair in acetonitrile at 25°C; ratio of  $[Tl^+]$  to  $[OAc^-]$  = 35.6, 8.93, 4.48, 3.00, 2.26, 1.80, 1.30, 1.02 for curves I to VIII.  $[Tl^+] = 3.42 \times 10^{-4}$  M; 1 cm cell.





The effect of added salts on the absorption spectrum of  
thallium (I) acetate in acetonitrile

When small amounts of alkali metal perchlorates, e.g.  $\text{NaClO}_4$  and  $\text{LiClO}_4$ , were added to a dilute solution of  $\text{TlOAc}$  in acetonitrile (ca.  $7 \times 10^{-4} \text{ M}$ ) the low energy band at  $255 \text{ m}\mu$  appeared to shift to higher energies with increasing salt concentration. The intensity of this band decreased whereas that of the high energy band increased with increasing amounts of the added salts. The absorption spectra shown in Fig. 11 illustrate the effect of added sodium perchlorate. No similar effect was observed when tetraalkylammonium perchlorates, e.g.  $\text{Et}_4\text{NClO}_4$  and  $(\text{n-Bu})_4\text{NClO}_4$  were added (Fig. 12). These effects may be interpreted in terms of ion-pair formation, i. e., cations of added salts form more stable acetate ion-pairs than  $\text{TlOAc}$  ion-pair. For example,  $\text{Li}^+$  and  $\text{Na}^+$  ions having smaller sizes than  $\text{Tl}^+$  ion, will compete successfully in forming new acetate ion-pairs, whereas those larger cations (e.g. tetraalkylammonium ions) will not be able to do so, owing to their bulky shapes. These processes may be shown by the following equilibria:

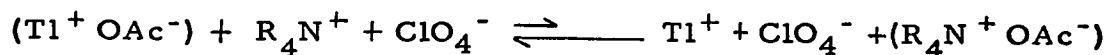

where  $\text{M}^+$  = alkali metal ion

and  $\text{R}_4\text{N}^+$  = tetraalkylammonium ion.

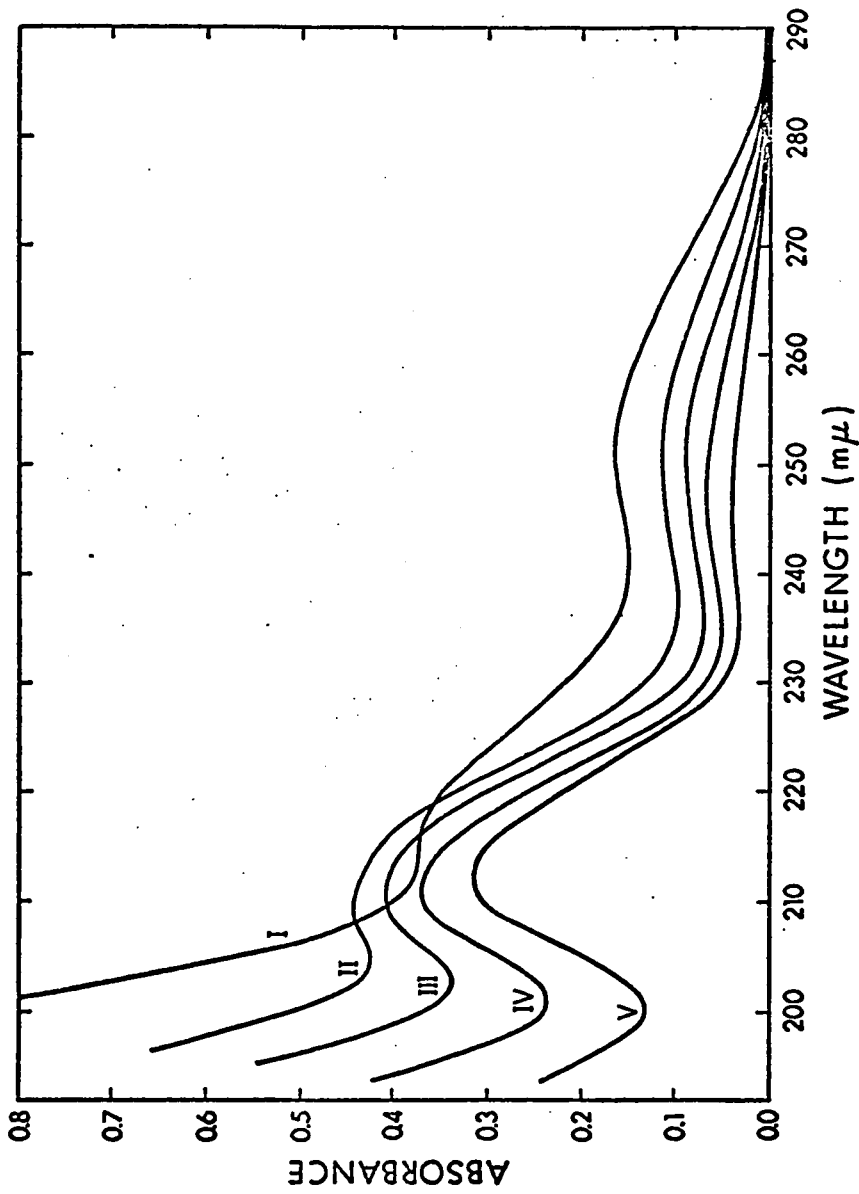

Figure 11. Absorption spectrum of thallium (I) acetate in acetonitrile on addition of sodium perchlorate at 20°C; ratio of  $[\text{ClO}_4^-]$  to  $[\text{Tl}^+]$  = 0.0, 28.6, 57.1, 100, 143 for curves I to V.  $[\text{Tl}^+] = 7.0 \times 10^{-4} \text{ M}$ ; 1 cm cell.

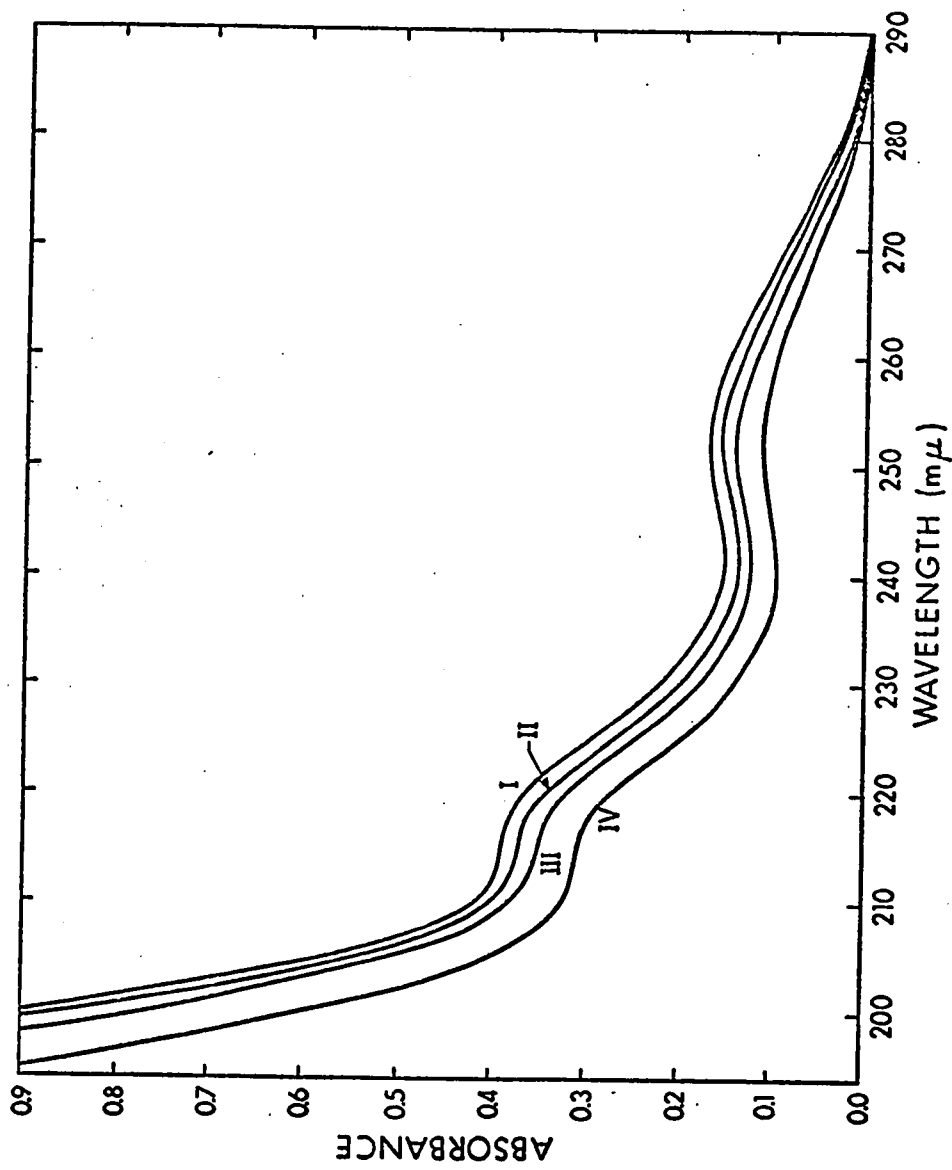

Figure 12. Absorption spectrum of thallium (I) acetate in acetonitrile on addition of tetra-n-butylammonium perchlorate at 20°C; ratio of  $[\text{ClO}_4^-]$  to  $[\text{Tl}^+]$  = 0.0, 28.6, 57.1, 100, 143 for curves I to V.

The effect of temperature on the absorption spectrum of thallium (I) acetate in various solvent systems

The absorption spectra of TlOAc in water, ethyl alcohol, iso-propyl alcohol, 10% (v/v) water/iso-propyl alcohol, and acetonitrile were run at 60°C and compared with those recorded at 20°C. It was found that the absorption band due to solvated free  $Tl^+$  ion (e.g. in water and ethyl alcohol) was temperature independent while those due to ion-pairs (e.g. in iso-propyl alcohol and acetonitrile) were sensitive to the change in temperature. The ion-pair bands appeared to shift to longer wavelengths (bathochromic shift) with increase in temperature. For example, the low energy band observed at 255  $m\mu$  from the solution of TlOAc in acetonitrile shifted to 260  $m\mu$  when the temperature was increased from 20° to 60°C. This is shown in Fig. 13. At 20°C, the solution of TlOAc in 10% (v/v) water/iso-propyl alcohol mixture showed two distinct bands due to solvated free  $Tl^+$  ion and its ion-pairs at 218  $m\mu$  and 230  $m\mu$ , respectively. On heating the solution to 60°C, the low energy band shifted from 230 to 235  $m\mu$ , while the band at 218  $m\mu$  appeared to be insensitive to the temperature change (Fig. 14).

In any case, the absorbance values decreased slightly with increasing temperature, presumably because solvent expansion more than compensated for cell expansion.

The cause of the band shift may be explained as a perturbation of the atomic energy levels of  $Tl^+$  ion within the ion-pair by the changes in ion-pair solvation and interionic distances between  $Tl^+$

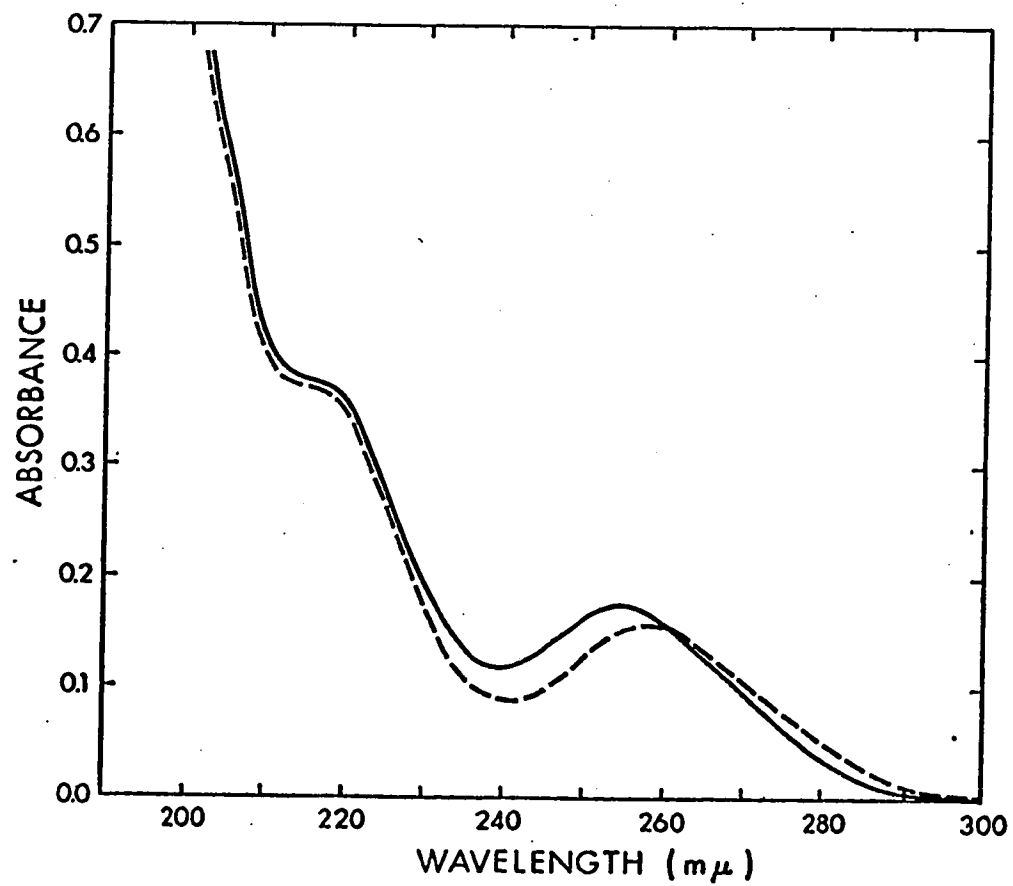

Figure 13. Absorption spectra of thallium (I) acetate in acetonitrile at 20°C (—) and at 60°C (---).

$[Tl^+] = 7.0 \times 10^{-4} M$ ; 1 cm cell.

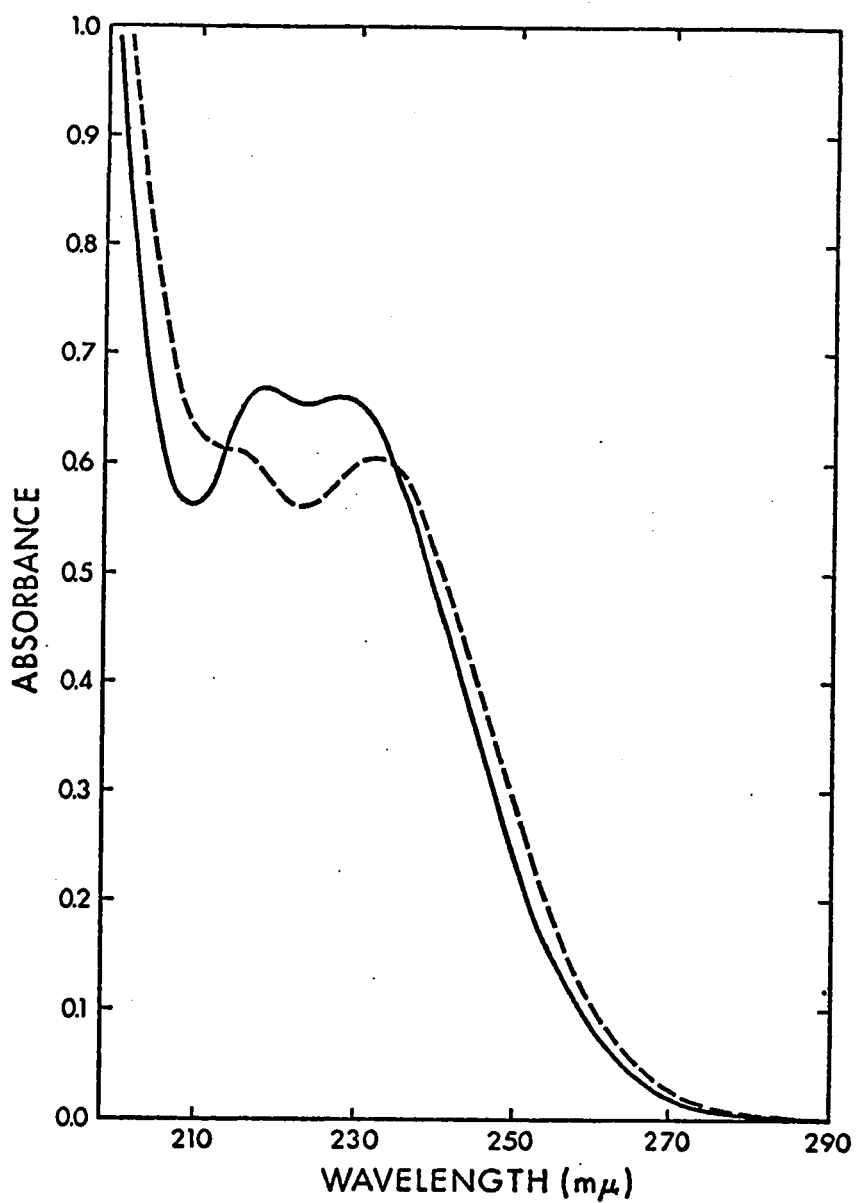

Figure 14. Absorption spectra of thallium (I) acetate in 10% (v/v) water/iso-propyl alcohol at 20°C (—) and at 60°C (-----).  
[Tl<sup>+</sup>] =  $2.0 \times 10^{-4}$  M; 1 cm cell.

and  $\text{OAc}^-$  ions upon the temperature change. It is possible to assume that, as temperature increased, the magnitude of ion-pair solvation would be less than that at lower temperature, giving rise to an increase in the interionic distance. Hence, increase in interionic distance destabilizes the ground state more than the excited state, leading to the observed bathochromic shift (i.e., the  $s-p$  separation decreases with increasing temperature). Temperature changes, however, do not noticeably affect the electronic absorption spectrum of solvated free  $\text{Tl}^+$  ion presumably because the magnitude of the destabilization energies of the ground and excited states are similar.



## SUMMARY

The experimental results of this study can be summarized as follows:

(i) The existence of TlOAc ion-pairs in acetonitrile, p-dioxane, secondary and tertiary alcohols, 1,2-dimethoxy ethane, Bis-(2-methoxyethyl) ether, dichloromethane, and some binary aqueous solvent mixtures (e.g. 95% p-dioxane and 90% iso-propyl alcohol etc.) has been confirmed spectroscopically. The absorption bands due to ion-pairs observed in the 238-264  $m\mu$  region are distinguishable from that due to solvated free  $Tl^+$  ion observed in the region of 212-220  $m\mu$ .

(ii) The ion-pair of TlOAc existing in acetonitrile has been found to be a contact ion-pair or 1:1 complex. The overall average logarithm of association constant of the ion-pair was determined and was found to be  $5.7 \pm 0.2$  at  $25^\circ C$  and an ionic strength of 0.01.

(iii) The location of absorption bands of TlOAc ion-pairs has been found to be sensitive to environmental changes, e.g. changes in solvent, concentration of added alkali perchlorates, and temperature. These results have been interpreted in terms of ion-pair solvation and interionic distances.

### Chapter 3

## The Polarographic Behavior of Some Thallium (I) Salts in Acetonitrile

### BACKGROUND

Polarographic analysis, invented in 1920 by Jaroslav Heyrovsky, has been used as a practical tool for many problems in inorganic and electroanalytical chemistry. Polarography involves the electrolysis of a solution of electro-reducible or electro-oxidizable substances with a dropping mercury electrode (d.m.e.) or other microelectrodes. Attention has been directed almost entirely to the interpretation of the current-potential curves (polarograms). The most important characteristic of the polarogram is that the current does not increase indefinitely with increasing applied electromotive force (e.m.f.) after the decomposition potential is exceeded, but reaches a more or less constant limiting value<sup>71</sup>. Under optimum conditions, the diffusion current is directly proportional to the concentration of the electroactive substance in the bulk of the solution.

By making several assumptions and applying Fick's Laws of diffusion, Ilkovic<sup>72</sup> derived the following equation for the diffusion current:

$$i_d = 0.627 n F D^{1/2} C m^{2/3} t^{1/6} \quad (5)$$

where  $i_d$  is the diffusion current in amperes;  $n$ , the number of faradays per mole of electroactive species;  $F$ , the faraday (96,487

coulombs);  $D$ , the diffusion coefficient of the reducible substance in  $\text{cm}^2/\text{sec.}$ ;  $C$ , the concentration of diffusion species in moles/ml;  $m$ , the rate of flow of mercury in  $\text{g}/\text{sec.}$ ;  $t$ , the drop time in seconds. MacGillavry and Rideal<sup>73</sup> have discussed the derivation of this equation. From equation (5), if all common factors such as temperature, pressure and concentration of supporting electrolyte are constant, the diffusion current of a given electroactive substance should be directly proportional to its concentration, that is

$$i_d = K \times C \quad (6)$$

The proportionality constant or the 'Diffusion current constant'<sup>74</sup>,  $K$ , is dependent upon the characteristics of the microelectrode, the properties of the substance undergoing reaction at the electrode and the nature of the solution.

The most useful form of the Ilkovic equation is expressed as follows:

$$i_d = 607 n D^{1/2} C m^{2/3} t^{1/6} \quad (7)$$

or 
$$i_d/C = 607 n D^{1/2} m^{2/3} t^{1/6}$$

and therefore 
$$K = 607 n D^{1/2} m^{2/3} t^{1/6} \quad (8)$$

where  $i_d$  is expressed in microamperes,  $C$  in millimoles per liter,  $D$  in  $\text{cm}^2/\text{sec.}$ ,  $m$  in  $\text{mg}/\text{sec.}$ , and  $t$  in seconds.

It has been shown<sup>72,74</sup> that at a given temperature and pressure the rate of flow of mercury,  $m$ , is practically constant and independent of the potential of the dropping mercury electrode. On the other hand, the drop time,  $t$ , depends on the medium in which the drops form and is directly proportional to the interfacial tension

which in turn depends on the potential of the dropping electrode<sup>71</sup>. The product  $m^{2/3} t^{1/6}$ , therefore, changes with the potential of the dropping electrode. The diffusion coefficient,  $D$ , is affected by the viscosity of the medium, and for this reason  $D$  is somewhat dependent upon the nature of solvent. Lingane<sup>74</sup> and Ilkovic<sup>75</sup> observed that the diffusion coefficient of a reducible ion increases with increasing temperature. For this reason, all data reported must include the temperature used; measurements are usually carried out in a constant temperature bath, e.g. in a water thermostat. Changes in the molecular or ionic state of the electro-active substance also lead to changes in the diffusion coefficient, e.g. a metal ion complex usually yields a considerably different diffusion current,  $i_d$ , than the solvated metal ion. The diffusion current is dependent on a number of factors such as the effective diffusion coefficient, viscosity, ionic strength, and complex formation.

Acetonitrile is an interesting solvent, now widely used as a non-aqueous medium for analytical applications and for solvation studies. Polarographic measurements in acetonitrile were first reported by Wawzonek and Runner<sup>76</sup>. Acetonitrile is an aprotic solvent which behaves as a weaker base and a much weaker acid than water. As a result of the weak base properties of acetonitrile, solvolytic reactions generally are less extensive in this solvent than water. Solubilities of inorganic salts such as perchlorates and tetrafluoroborates are much higher in acetonitrile than those of acetates, chlorides, bromides, iodides, thiocyanates

and nitrates. White sulphate salts are usually insoluble in acetonitrile. In general only salts of large or polarizable univalent anions (e.g.  $\text{ClO}_4^-$  and  $\text{BF}_4^-$ ) have reasonable solubilities<sup>77</sup>. Thallium (I) perchlorate and tetrafluoroborate are fairly soluble in acetonitrile in comparison with the other thallium (I) salts.

As a polar Lewis base, acetonitrile solvates inorganic cations moderately well, although solubilities of ionic salts are not always large because it does not solvate anions to any appreciable extent. Since acetonitrile is a much weaker base than water, cations have lower solvation energies in it than in water except for those cations such as  $\text{Ag}^+$  and  $\text{Cu}^+$  which have specific interactions with acetonitrile<sup>77</sup>. Consequently, the half-wave potentials,  $E_{1/2}$ , of reducible cations (excluding  $\text{Ag}^+$  and  $\text{Cu}^+$  ions etc.) are generally less negative in acetonitrile than in water<sup>34</sup>. For example,  $E_{1/2}$  for  $\text{Tl}^+$  ion has been reported to be -0.27 v. (vs S.C.E.) in acetonitrile as compared to -0.46 v. (vs S.C.E.) in water<sup>35</sup>. Some physical properties of acetonitrile are shown in Table VIII.

Polarographic studies of electroreducible cations of the alkali, alkaline-earth, transition and post-transition metals have been made in acetonitrile<sup>34,35,38</sup>. Coetzee<sup>78</sup> also reported comprehensive polarographic measurements of a number of metal cations in acetonitrile. Popov and Geske<sup>38</sup> studied the polarographic behavior of a number of metallic perchlorates in acetonitrile using  $\text{Ag}/\text{AgCl}$  as a reference electrode. The half wave potential of thallium perchlorate in acetonitrile has been reported to be -0.27 v. vs S.C.E.<sup>35</sup> and -0.55 v. vs  $\text{Ag}/\text{AgNO}_3$  0.01 M in acetonitrile<sup>38</sup>. Takahashi<sup>79</sup>

TABLE VIII

Physical properties of acetonitrile<sup>a</sup>

Dipole moment (Debye)	3.37
Dielectric constant (25°C)	35.95
Freezing point (°C)	-45.7
Boiling point (°C)	81.6
Viscosity (Cp at 25°C)	0.3412
Density (gm/cc at 25°C)	0.7767
Vapor pressure (mm of Hg at 25°C)	89.0
Spectral cut-off wavelength in 1 cm. quartz cell (m $\mu$ )	189

<sup>a</sup> Data obtained from reference 63.

determined the half-wave potential of  $Tl^+$  ion in water/acetonitrile mixtures with reference to the standard value in water. Changes in the half-wave potential, diffusion current and diffusion coefficient of  $Tl^+$  ion with increasing alcohol content in water/alcohol mixtures were observed by Lal and Srivastava<sup>39</sup>.

The purposes of this study are:

(i) to verify the existence of an ion-pair or 1:1 complex of  $TlOAc$  in acetonitrile, assuming that the half-wave potential of the ion-pair differs from that of solvated free  $Tl^+$  ion,

(ii) to study the solute-solvent interactions in aqueous/acetonitrile mixtures in order to examine the preferential solvation of  $Tl^+$  ion by water molecules,

(iii) to observe the effect of different supporting electrolytes of varying concentrations on the half-wave potential of  $Tl^+$  ion in acetonitrile.

## EXPERIMENTAL

Reagents and Apparatus

Matheson Coleman and Bell technical grade acetonitrile was purified by the method of O'Donnell, Ayres and Mann<sup>80</sup> as modified by Yeager and Kratochvil<sup>37</sup>. In this method about 2.5 liters of technical grade acetonitrile were distilled rapidly from 30 ml of benzoyl chloride. The distillate was mixed with 30 g. of anhydrous sodium carbonate and again distilled at the same rate while stirring. The distillate was redistilled at the same rate from 35 g. of potassium permanganate and 35 g. of sodium carbonate. This distillate was warmed, acidified with several drops of concentrated sulphuric acid to neutralize ammonia formed in the previous step, vacuum distilled rapidly, then distilled again at a high reflux ratio in a 30 plate column at 10-20 ml per hour. The first liter and the last 200 ml were discarded. The resulting acetonitrile showed zero absorbance down to  $225\text{ m}\mu$  in a 1 cm quartz cell and an absorbance of about 0.1 at  $200\text{ m}\mu$ . The water content as determined by Karl Fischer titration was about  $5 \times 10^{-4}\text{ M}$ .

Supporting electrolytes

Sodium perchlorate,  $\text{NaClO}_4$ , tetraethylammonium perchlorate,  $\text{Et}_4\text{NClO}_4$ , and tetra-n-butylammonium perchlorate,  $(\text{n-Bu})_4\text{NClO}_4$ , were used as supporting electrolytes in this experiment. G. F. Smith and Co. anhydrous sodium perchlorate was dried in a vacuum oven at  $100^\circ$  and used without further treatment. Tetraethyl-



ammonium perchlorate and tetra-n-butylammonium perchlorate from Eastman Organic Chemicals were recrystallized from deionized water and dried at 70° in a vacuum oven for 48 hours.

#### Thallium (I) salts

Varlacoid Chemical Co. thallium (I) perchlorate,  $TlClO_4$ , was recrystallized from deionized water and dried in vacuo at 100°. Thallium (I) acetate,  $TlOAc$ , ultra-pure grade obtained from Alfa Inorganics Inc. was used after drying at 60° for 2 hours and 110° for 3 hours in a vacuum oven. Thallium (I) tetrafluoroborate,  $TlBF_4$ , was prepared by the method of Yeager and Kratochvil<sup>37</sup> as described in chapter 2. All of the salts were kept in a desiccator over phosphorous pentoxide.

#### Preparation of solutions

Solutions of thallium (I) perchlorate and tetrafluoroborate in acetonitrile were prepared by weighing and dilution methods. The concentrations of the salts varied from about 0.2 to 4.0 millimolar.

A saturated solution of thallium (I) acetate in acetonitrile was prepared by stirring a mixture of excess solid  $TlOAc$  and acetonitrile in a flat bottom flask within a dry box for about 48 hours. Then excess undissolved salt was filtered off and the saturated solution was kept in the dry box. The concentration of thallium in the saturated solution was determined by measuring the diffusion current and comparing with a series of standard thallium (I) perchlorate in acetonitrile solutions. It was found to be about  $7 \times 10^{-4} \underline{M}$ .

Solutions of thallium (I) perchlorate in a series of acetonitrile/water mixtures were obtained by the addition of deionized water from a buret to a given known amount of a stock solution of thallium (I) perchlorate in acetonitrile. More acetonitrile was then added until the required percentage by volume (% v/v) of acetonitrile was reached.

#### The polarographic cell

All polarograms were run under nitrogen in the Teflon stoppered weighing bottle shown in Fig. 15. A three electrode system was used to compensate for a fairly high specific resistance of solutions of supporting electrolyte in acetonitrile. A Ag/0.01 M AgNO<sub>3</sub> in acetonitrile reference electrode was used throughout this study; it has a potential of 0.29 v. vs S.C.E.<sup>34</sup>. The couple is reversible, and its potential is relatively unaffected by those impurities commonly found in acetonitrile<sup>81</sup>. The reference electrode was isolated from the solution by using the following assembly: a glass tube ('A' in Fig. 15) containing 0.01 M AgNO<sub>3</sub> in acetonitrile and having a frit of ultra-fine porosity dipped into a slightly wider glass tube 'B' which was also fitted with an ultra-fine frit. Tube 'B' contained just sufficient acetonitrile solution of 0.1 M of the supporting electrolyte to make electrolytic contact with the 0.01 M AgNO<sub>3</sub> in acetonitrile solution. Nitrogen was saturated with purified acetonitrile at room temperature before being passed through the polarographic cell. High purity grade Linde nitrogen was used without further treatment.

### Recording of Current-Potential curves

Polarograms were obtained with a Metrohm Polarocord E-261 equipped with a Metrohm IR compensator. All potential values were corrected for both recorder lag and ohmic drop.

All measurements were made at  $25 \pm 0.1^{\circ}\text{C}$  by means of a water circulating constant temperature bath.

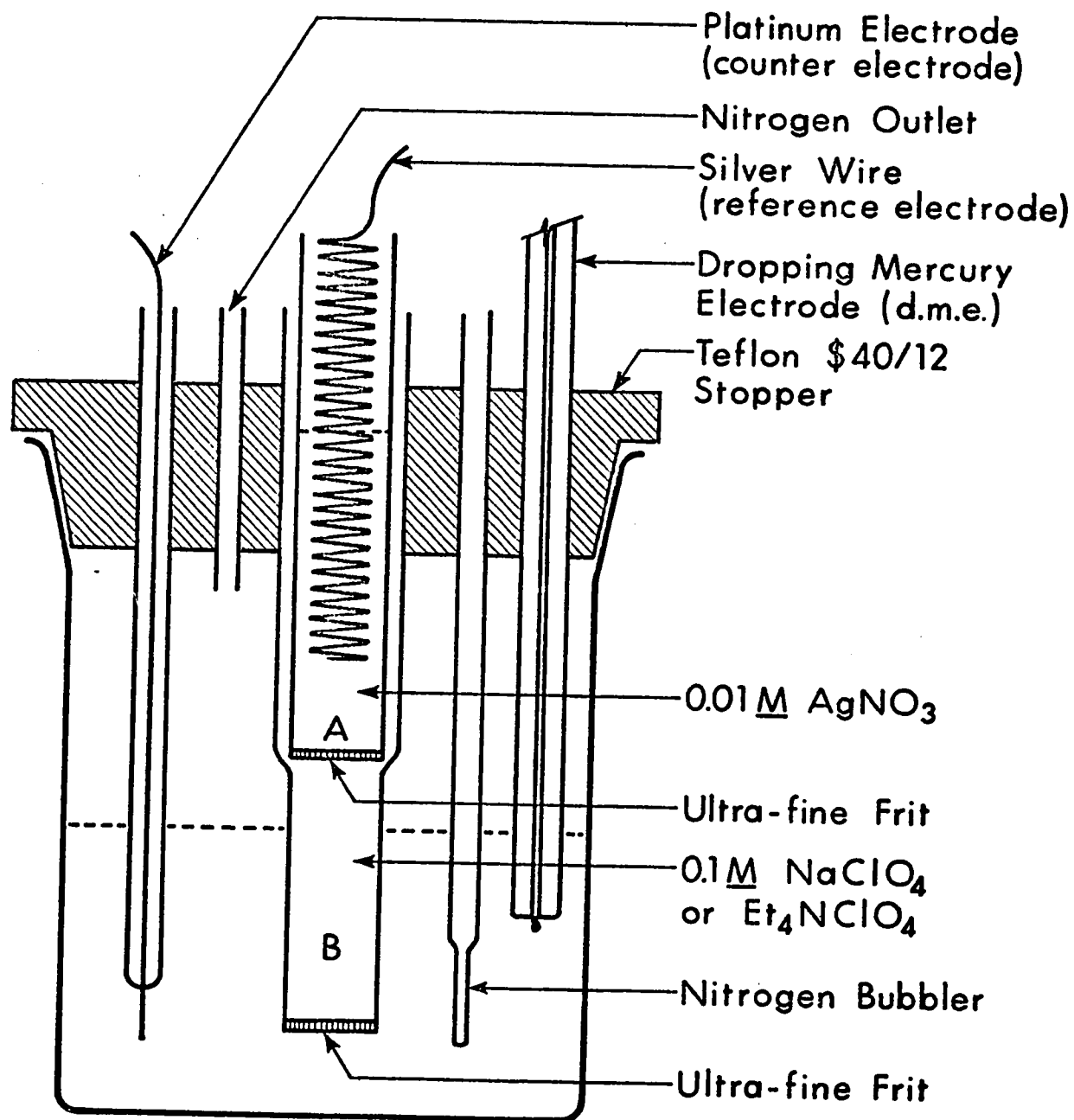

Figure 15. Polarographic cell.

## RESULTS AND DISCUSSION

The dropping mercury electrode had the following characteristics in a solution of 0.1 M  $\text{Et}_4\text{NClO}_4$  in acetonitrile:

$-E_{d.m.e.}, v.$	$m, \text{mg/sec.}$	$t, \text{sec.}$	$m^{2/3} t^{1/6}$
0.00	1.819	3.40	1.827
0.55	1.823	3.55	1.843

height of mercury column = 40.0 cm (uncorrected)

As mentioned previously the polarographic diffusion current ( $i_d$ ) is proportional to the concentration of electroactive substance. A typical set of data illustrating this for thallium (I) perchlorate is shown in Table IX.

TABLE IX

Diffusion currents of thallium (I) perchlorate at various concentrations in 0.1 M sodium perchlorate

Concentration, C $\times 10^3 \text{ M}$	Observed diffusion current <sup>a</sup> $i_d, \mu\text{A}$	$K = i_d/C^b$ $\mu\text{A}/\text{moles/liter}$
0.25	1.40	5.6
0.75	4.20	5.7
1.6	8.94	5.6
2.5	14.4	5.8
3.8	22.0	5.8
		Average K = 5.7

<sup>a</sup>Measured at  $E_{d.m.e.} = -0.544 v.$

<sup>b</sup>K = Diffusion current constant.

A plot of the diffusion current against the concentration of thallium (I) perchlorate showed a linear relation over a concentration range from 0.25 to  $3.8 \times 10^{-3}$  M.

In acetonitrile as solvent, the reduction of thallium (I) perchlorate, tetrafluoroborate and acetate showed well-defined waves in all of the three supporting electrolytes used in this study. No maximum suppressor was used throughout this experiment. Typical polarograms of  $TlClO_4$  in 0.1 M  $NaClO_4$ ,  $TlOAc$  in 0.1 M  $NaClO_4$  and  $TlOAc$  in 0.1 M  $Et_4NClO_4$  are presented in Figs. 16 and 17, respectively.

The half-wave potential of thallium from  $TlClO_4$  in 0.1 M  $NaClO_4$  was found to be -0.544 v., which is in agreement with the value -0.55 v. reported by Popov and Geske<sup>38</sup>. Using the Ilkovic equation shown in equation (7) of this chapter, the diffusion coefficient (D) of  $Tl^+$  ion was calculated; it was found to be  $7.18 \times 10^{-2}$   $cm^2/sec$ . The observed half-wave potentials of  $Tl^+$  ion for the three thallium (I) salts in supporting electrolytes of different nature and concentration is presented in Table X.

The results summarized in Table X can be explained as follows:

1. The half-wave potentials of  $Tl^+$  ion from  $TlClO_4$  and  $TlBF_4$  are less negative in tetra-n-butylammonium perchlorate and tetraethylammonium perchlorate solutions than in sodium perchlorate. It would seem that there are some specific interactions between some supporting electrolytes and acetonitrile. Frank and

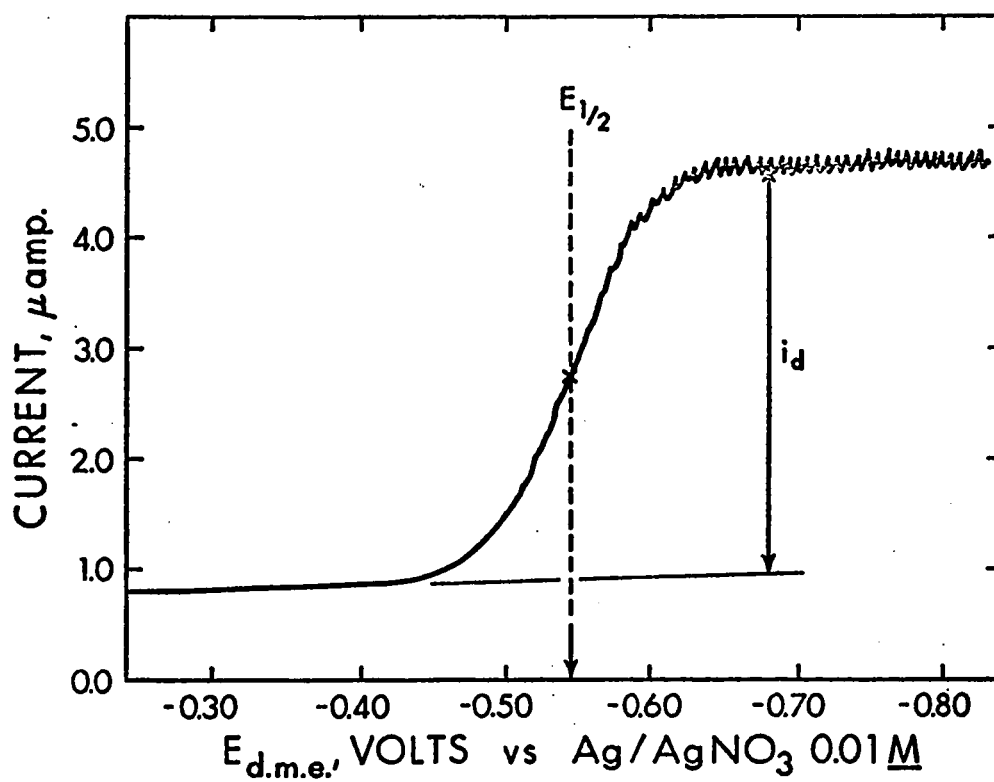

Figure 16. Typical polarogram of  $6 \times 10^{-4}$  M thallium (I) perchlorate in 0.1 M  $NaClO_4$  in acetonitrile at 25°C.

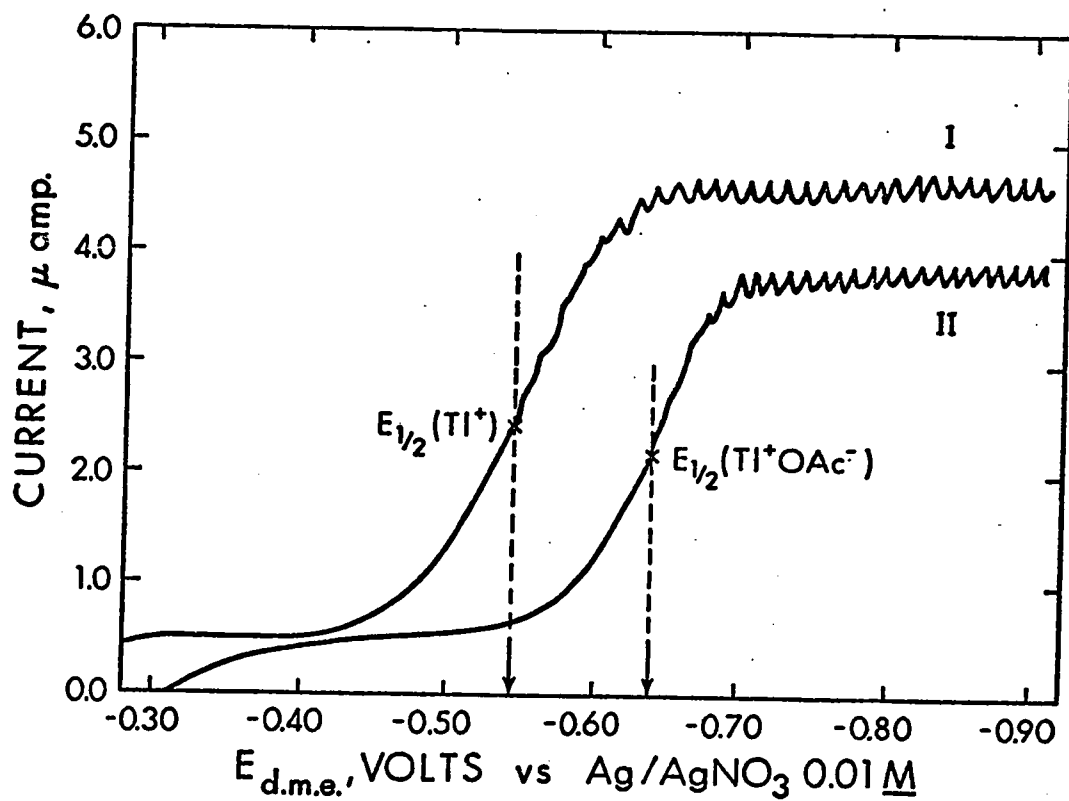

Figure 17. Typical polarograms of  $7 \times 10^{-4}$  M thallium (I) acetate in 0.1 M  $\text{NaClO}_4$  (curve I) and in 0.1 M  $\text{Et}_4\text{NClO}_4$  (curve II) in acetonitrile at  $25^\circ\text{C}$ .



TABLE X

Half-wave potentials of thallium (I) salts in acetonitrile

Salt	Supporting Electrolyte	$C_{\text{supp. elect.}}$ $\times 10^3 \text{ M}$	$-E_{1/2}$ volts
$\text{TlClO}_4^{\text{a}}$	$\text{NaClO}_4$	100	0.544
		30	0.530
	$\text{Et}_4\text{NClO}_4$	100	0.540
		30	0.525
	$(\text{n-Bu})_4\text{NClO}_4$	100	0.536
	$\text{TlBF}_4^{\text{a}}$	$\text{NaClO}_4$	100
30			0.534
$\text{Et}_4\text{NClO}_4$		100	0.536
		30	0.524
$(\text{n-Bu})_4\text{NClO}_4$		100	0.528
$\text{TlOAc}^{\text{b}}$		$\text{NaClO}_4$	100
	$\text{Et}_4\text{NClO}_4$	100	0.640
	$(\text{n-Bu})_4\text{NClO}_4$	100	0.636

<sup>a</sup> One millimolar solution.<sup>b</sup> Saturated solution (ca.  $7 \times 10^{-4} \text{ M}$ ).

Evans<sup>82</sup> reported that tetraalkylammonium ions have a strong 'structure-making' (polymerizing) influence on water structure. Coetzee et al.<sup>35</sup>, studying the reduction potentials of metal ions in various solvents (including acetonitrile), postulated that similar structure-making by the supporting electrolyte in these solvents will decrease the solvation energy of the electroactive species and cause a shift in the reduction potential to less negative values. This is in agreement with the results observed here. For example,  $E_{1/2}$  of  $TlClO_4$  in 0.1 M  $(n-Bu)_4NClO_4$ ,  $Et_4NClO_4$  and  $NaClO_4$  was found to be -0.536, -0.540 and -0.544 v., respectively. This trend shows that the effect of tetrabutylammonium ion is greater than that of tetraethylammonium or sodium ions (e.g.  $(n-Bu)_4N^+ > Et_4N^+ > Na^+$ ).

2. In the case of thallium (I) acetate a reversed trend was observed, i.e., the half-wave potential is more negative in  $Et_4NClO_4$  and  $(n-Bu)_4NClO_4$  than in  $NaClO_4$ . The most probable explanation of this anomaly is that solvated free  $Na^+$  (from  $NaClO_4$  in acetonitrile) being a smaller ion will successfully replace  $Tl^+$  ion to form a more stable acetate ion-pair (i.e.,  $Na^+OAc^-$ ), giving rise to solvated free  $Tl^+$  ion. The bulky tetraalkylammonium ions, on the other hand, would not be able to compete successfully with  $Tl^+$  ion in forming such ion-pairs. Therefore,  $TlOAc$  will exist largely as ion-pairs in solutions of  $Et_4NClO_4$  and  $(n-Bu)_4NClO_4$  while in  $NaClO_4$  solution the solvated free  $Tl^+$  ion will be found. As expected, the half-wave potential of the  $TlOAc$  ion-pair was found to be more negative than that of the solvated free  $Tl^+$  ion

because it is generally more difficult to reduce a complex than a solvated free ion. The probable reduction reaction of TlOAc at the d.m.e. is:  $Tl^+ OAc^- + e^- + Hg = Tl(Hg) + OAc^-$ .

3. The half-wave potential of  $Tl^+$  ion in a given supporting electrolyte with different concentrations varies with the concentration of the supporting electrolyte; e.g. the difference in half-wave potential ( $\Delta E_{1/2}$ ) was found to be -0.015 v. for  $TlClO_4$  in  $Et_4NClO_4$  for supporting electrolyte concentrations of 0.10 and 0.03 M. The dependence of the half-wave potential on the concentration of supporting electrolytes is shown by the following equation:

$$\Delta E_{1/2} = -0.03 \log C_2/C_1 \quad (9)$$

where C is the concentration of a given supporting electrolyte<sup>35</sup>. This relation is valid in several solvents, including acetonitrile, provided that the change in liquid junction potential is negligible and all electrolytes are completely dissociated. Therefore, when  $C_2/C_1$  is 10/3, the calculated  $\Delta E_{1/2} = -0.016$  v. is in close agreement with the observed value of -0.015 v. for  $TlClO_4$  in 0.10 and 0.03 M  $Et_4NClO_4$ .

The reversibility of the reduction waves for  $TlClO_4$  and  $TlBF_4$  in 0.1 M  $NaClO_4$  was tested by plotting values of  $\log i/(i_d - i)$  against the applied e.m.f. . The plot for  $TlClO_4$  is shown in Fig. 18 . As predicted by equation (10), the points of the log plots for  $TlClO_4$

$$E = E_{1/2} - \frac{0.059}{n} \log \frac{i}{i_d - i} \quad (10)$$

and  $TlBF_4$  form straight lines, whose slope values are both 0.062,

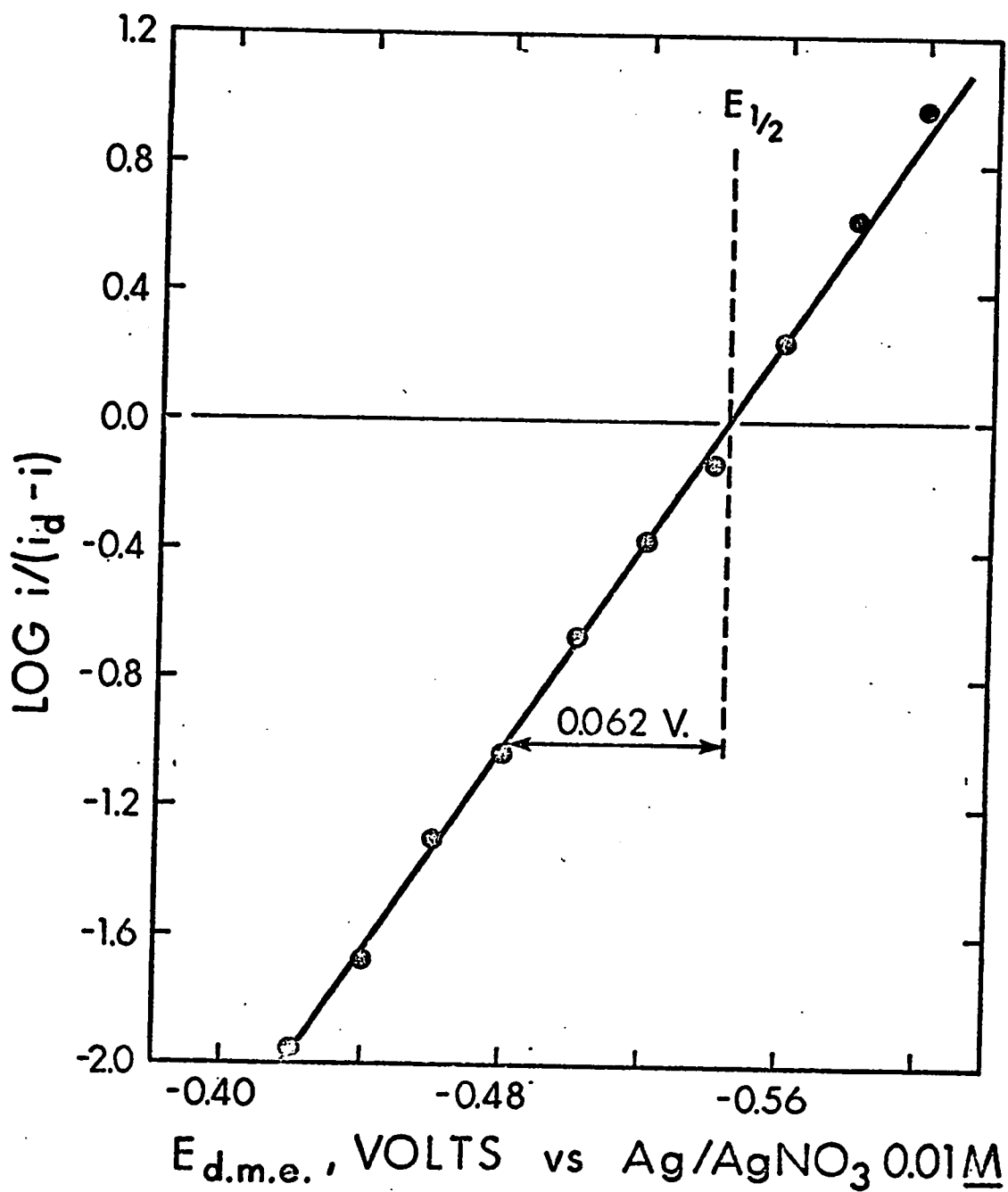

Figure 18. Test for reversibility of the thallium (I) - (0) couple in acetonitrile at 25°C. Solution composition was  $6 \times 10^{-4}$  M thallium (I) perchlorate in 0.1 M  $\text{NaClO}_4$ .

which is in close agreement with the theoretical value (within experimental error), 0.059, for  $n = 1$ . It is evident that the reduction of  $Tl^+$  ion from  $TlClO_4$  and  $TlBF_4$  solutions in acetonitrile proceeds reversibly at the dropping mercury electrode.

The reduction waves of  $TlOAc$  in  $0.1 \text{ M NaClO}_4$  and in  $0.1 \text{ M Et}_4\text{NClO}_4$  were well-defined, though the slope values were somewhat higher, 0.064 and 0.066, respectively. The reduction of  $TlOAc$  is probably reversible in these solutions.

The effect of water on the reduction waves of  $TlClO_4$  and  $TlOAc$  was investigated. The changes in diffusion currents and half-wave potentials of solutions containing constant concentrations of  $TlClO_4$  in  $CH_3CN/H_2O$  mixtures are shown in Table XI.

As shown in column 3 in Table XI, the slope values vary from 0.062 to 0.066; from this it can be concluded that the reduction waves of  $TlClO_4$  in acetonitrile and in acetonitrile/water mixtures are reversible. It is seen that the diffusion current ( $i_d$ ) decreases gradually with increasing amount of water in the solution. This can be attributed to the increasing viscosity of the solution or to changes in the nature of the diffusing species<sup>34</sup>. As previously mentioned, water is a stronger base than acetonitrile, so it should compete successfully for  $Tl^+$  ion in the following equilibrium:

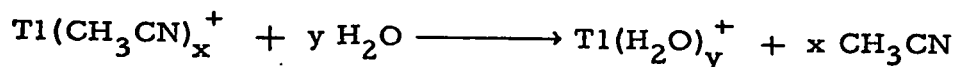

The results from this observation are summarized in Table XI. As shown in column 4, the reduction wave shifted to increasingly negative

TABLE XI

Effect of water on diffusion currents and half-wave potentials of thallium (I) perchlorate in acetonitrile/water mixtures as solvent and 0.1 M sodium perchlorate as supporting electrolyte

$$[\text{TlClO}_4] = 5 \times 10^{-4} \text{ M}$$

Solution	$i_d, \mu\text{A}^a$	Slope <sup>b</sup>	$-E_{1/2}, \text{volts}$
100% (v/v) CH <sub>3</sub> CN	2.80	0.062	0.544
80% (v/v) CH <sub>3</sub> CN	2.48	0.064	0.618 <sup>c</sup>
60% (v/v) CH <sub>3</sub> CN	2.35	0.064	0.634 <sup>c</sup>
40% (v/v) CH <sub>3</sub> CN	2.24	0.065	0.648 <sup>c</sup>
20% (v/v) CH <sub>3</sub> CN	2.16	0.066	0.658 <sup>c</sup>

<sup>a</sup> Diffusion currents measured at corresponding half-wave potentials ( $E_{1/2}$ ).

<sup>b</sup> Slope of  $-E_{d.m.e.}$  vs  $\log i/(i_d - i)$  plots.

<sup>c</sup> These values include unknown liquid junction potentials.

potentials with increasing water concentration. These results strongly indicate that water molecules in the outer solvation layer successfully replace acetonitrile molecules bound to  $Tl^+$  ions in the primary solvation sheath, giving rise to hydrated  $Tl^+$  ions and free acetonitrile molecules.

On the other hand, when water was added successively to saturated solutions of  $TlOAc$  in acetonitrile (ca.  $7 \times 10^{-4}$  M), the reduction wave also shifted to more negative potentials with increasing amount of water. The results are presented in Table XII.

TABLE XII

Effect of water on diffusion currents and half-wave potentials of thallium (I) acetate in acetonitrile as solvent and 0.1 M sodium perchlorate as supporting electrolyte

% (v/v) water added	$i_d, \mu A^a$	$-E_{1/2}, \text{volts}$
0.0	2.70	0.540
0.4	4.20	0.550 <sup>b</sup>
2.3	4.35	0.556 <sup>b</sup>
6.0	4.95	0.580 <sup>b</sup>
20	2.25	0.638 <sup>b</sup>

<sup>a</sup> Diffusion currents measured at corresponding half-wave potentials ( $E_{1/2}$ ).

<sup>b</sup> These values include unknown liquid junction potentials.

As shown in Table XII, it is seen that the diffusion current increases with increasing amount of added water up to about 6%. This is in the opposite direction to that of  $\text{TlClO}_4$  in these solvent mixtures (compared with Table XI). The increases in the diffusion currents even in the mixtures of higher viscosities may be attributed to a larger degree of dissociation of  $\text{TlOAc}$  in water-rich than in acetonitrile-rich mixtures, giving rise to more solvated free  $\text{Tl}^+$  ions which can be reduced at the d.m.e.. After about 20% water was added, the diffusion current dropped drastically to  $2.25 \text{ m}\mu$ , probably because of a combination of dilution effects and increasing viscosity of the solvent system.



## SUMMARY

1. The polarographic measurements of  $TlClO_4$ ,  $TlBF_4$  and  $TlOAc$  have been made in acetonitrile at  $25^\circ C$ , using  $Ag/AgNO_3$   $0.01 M$  in acetonitrile as reference electrode.
2. The existence of the ion-pair of thallium (I) acetate in acetonitrile has been confirmed. The half-wave potential of the  $TlOAc$  ion-pair or 1:1 complex has been found to be  $-0.64 v.$  compared with the value  $-0.54 v.$  of solvated free  $Tl^+$  ion.
3. The preferential solvation of  $Tl^+$  ion was studied in acetonitrile/water mixtures. It was found that the reduction waves of  $Tl^+$  ion from  $TlClO_4$  and  $TlOAc$  shifted to more negative potentials with increasing water concentration in these mixtures. It is evident that the  $Tl^+$  ion is preferentially solvated by water molecules.
4. It has been found that the half-wave potential of  $Tl^+$  ion exhibits a dependence upon the nature and concentration ( $0.03$  to  $0.1 M$ ) of supporting electrolyte.

## Chapter 4

### A Conductance Study of Thallium (I) Acetate in Water and Selected Binary Aqueous/Solvent Mixtures at 25°C

#### BACKGROUND

Spectroscopic and polarographic studies on thallium (I) acetate in acetonitrile discussed in chapters 2 and 3 have indicated that the salt undergoes ion-pair formation according to the equilibrium:

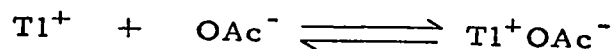

where  $\text{Tl}^+$  and  $\text{OAc}^-$  are solvated free ions and  $\text{Tl}^+\text{OAc}^-$  is an ion-pair which will not contribute to the conductivity of the solution. The ultraviolet absorption spectra of  $\text{TlOAc}$  in p-dioxane, iso-propyl alcohol, and in several binary mixtures of the two solvents with water also showed the existence of ion-pairs. However, since spectrophotometric and polarographic techniques do not yield precise information as to the extent of such association, it was decided to investigate the electrical conductance of the salt in binary aqueous solvent mixtures of acetonitrile, p-dioxane, and iso-propyl alcohol. The use of mixtures was necessary because the solubility of  $\text{TlOAc}$  is low in pure acetonitrile, p-dioxane and iso-propyl alcohol. The solvent mixtures also provide a range of dielectric constant from 20 to 80, thus permitting an assessment of the effect of dielectric constant on association. A conductance study of  $\text{TlOAc}$  was made in water at 25°C by Robinson and Davies in 1937<sup>10</sup>. This measurement was repeated in this work for comparison purposes.

A literature survey indicated that only a limited number of investigations of the electrical conductance of thallium (I) salts in

non-aqueous solvents have been made. The conductances of TlOAc, TlClO<sub>4</sub> and TlNO<sub>3</sub> in water at 25°C have been studied by Robinson and Davies<sup>10</sup>, who reported the conductivity values at infinite dilution for TlOAc and TlClO<sub>4</sub> to be 115.63 and 142.65, respectively. The dissociation constants of TlOAc, TlClO<sub>4</sub> and TlCl at 25°C, and of TlNO<sub>3</sub> at 18°C in water have been reported to be 1.2, 1.0, 0.37 and 0.39, respectively<sup>10</sup>. Nair and Nancollas<sup>11</sup> studied the conductivity of TlCl at 40°C, and TlBr at 25° and 40°C in aqueous solutions. Conductometric investigations for TlOAc and TlNO<sub>3</sub> in formamide, which has very high dielectric constant (109.5), have been made at 25°C by Tewari and Johari<sup>36</sup>. They reported the limiting equivalent conductances of TlOAc and TlNO<sub>3</sub> to be 31.02 and 20.00, respectively. The anomalous behavior of TlOAc and TlNO<sub>3</sub> as compared with alkali metal acetates and nitrates even in a high dielectric constant solvent such as formamide was attributed to ion association<sup>36</sup>. Yeager and Kratochvil<sup>37</sup> reported the limiting equivalent conductances for TlClO<sub>4</sub> and TlBF<sub>4</sub> in acetonitrile at 25°C to be 195.2 and 199.1, and gave values of the association constants for the salts to be 32 and 14, respectively. Conductance measurements of TlCl in dioxane/water mixtures at 25°C have been made by Panckhurst<sup>90</sup>.

It is the purpose of this study to examine the conductometric behavior of TlOAc in water and binary aqueous solvent mixtures of acetonitrile, along with other solvent systems such as p-dioxane/water and iso-propyl alcohol/water, in order to obtain information about ion solvation and ion-pair formation of the salt.

## EXPERIMENTAL

### Salt and Solvent Preparation

Ultra-pure grade thallium (I) acetate (Alfa Inorganics, Inc.) was used without further purification; it was dried at 120°C for 6 hours in a vacuum oven. Thallium (I) perchlorate (Varlacoid Chemical Co.) was recrystallized three times from deionized water and dried in a vacuum oven at 120°C for 12 hours.

Conductivity water was obtained by the method described in chapter 2. The specific conductance was of the order of  $8 \times 10^{-7}$  ohm<sup>-1</sup> cm<sup>-1</sup>.

Purified acetonitrile was prepared by the method of O'Donnell, Ayres and Mann<sup>80</sup>, with minor modifications by Yeager and Kratochvil<sup>37</sup>, as described in chapter 3. The specific conductance of the purified acetonitrile varied from 3 to  $10 \times 10^{-8}$  ohm<sup>-1</sup> cm<sup>-1</sup>.

Spectro-grade p-dioxane and iso-propyl alcohol from Matheson Coleman and Bell were used in the preparation of binary aqueous solvent mixtures.

### Apparatus

The conductance cell shown in Fig. 19 was used throughout this study. The cell originally designed by Daggett, Bair and Kraus<sup>83</sup>, with a minor modification by Yeager<sup>84</sup>, was constructed from a one-liter conical flask. The top 34/45 standard taper joint is for a salt cup dispenser, while the 24/40 side-arm connection is for solvent addition. The electrodes, constructed from 0.2 mm

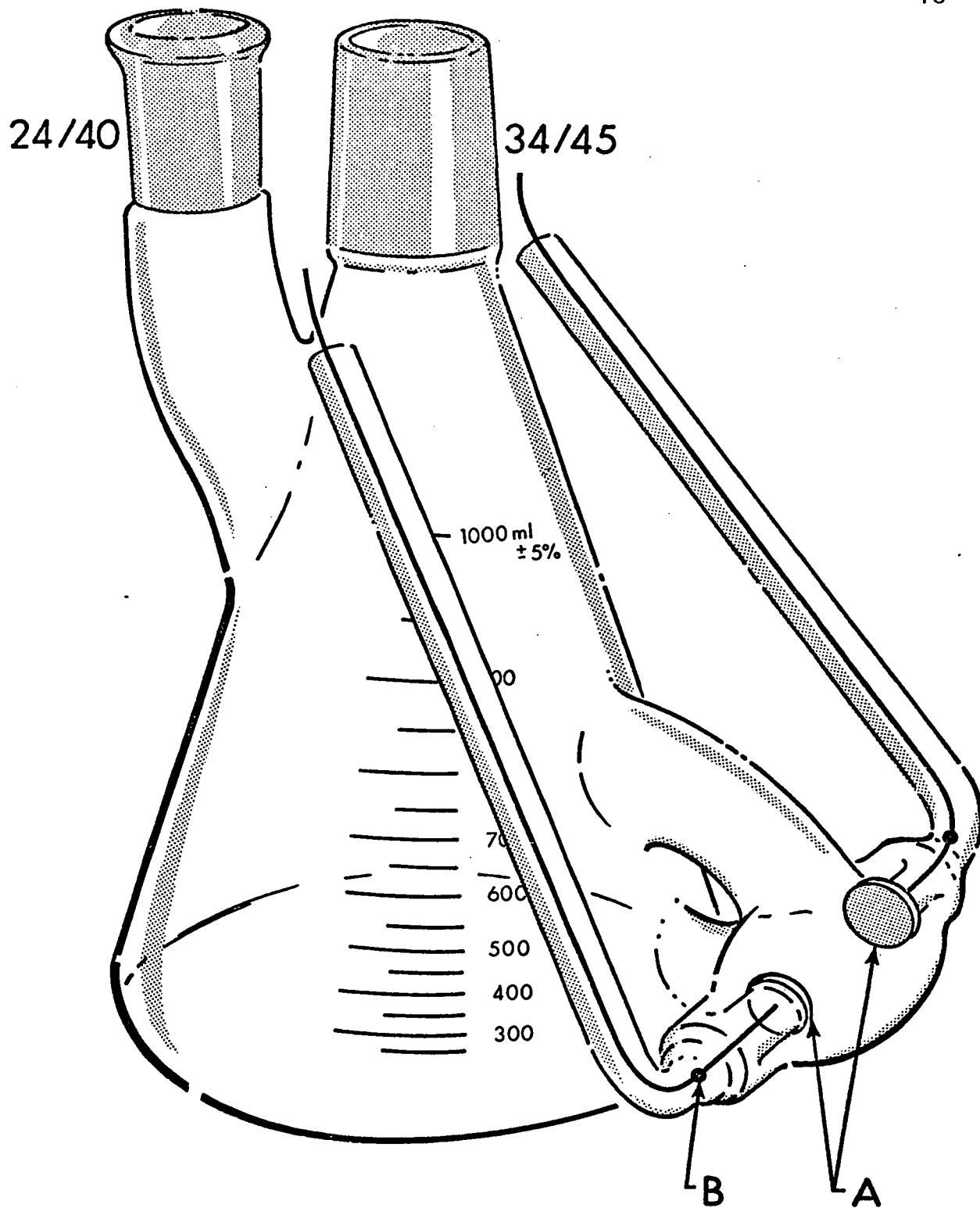

Figure 19. One-liter conductance cell.

thick platinum metal, were 14 mm in diameter and were backed with glass for extra rigidity (A). The electrode spacing was approximately 4 cm, giving a cell constant of about  $0.7 \text{ cm}^{-1}$ . The cell had copper wires silver-soldered directly to the platinum electrode leads (B). This cell used approximately 900 ml of solvent for a conductance run, was easy to handle and had a fairly stable cell constant. The cell was calibrated by the procedure of Lind, Zwolenik and Fuoss<sup>85</sup>, who calculated an averaged conductance equation for aqueous potassium chloride solutions using data of several workers. This equation has an estimated accuracy of 0.01% up to 0.012 M. The cell constant at several concentrations of potassium chloride was determined using this equation; the average cell constant was found to be  $0.6970 \text{ cm}^{-1}$ .

A diagram of the salt cup dispensing device for delivering salt samples to the conductance cell without exposing the cell contents to the atmosphere is shown in Fig. 20. The cup dispenser was originally designed by Kay, Hales and Cunningham<sup>86</sup>. The 60/50 standard taper joint and stopcock were lubricated with silicone grease. The tungsten metal pins B were sealed into glass and hold Teflon discs C and D in place. Disc D contains one hole and C eight. One end of steel pin A is fitted into a short piece of tubing sealed into the top of the dispenser and the other end fits into disc C. When the top of the dispenser is turned the upper Teflon disc rotates and successively drops eight salt sample cups into the solution. Pyrex glass cups (10 mm in height and 8 mm in diameter) were used.

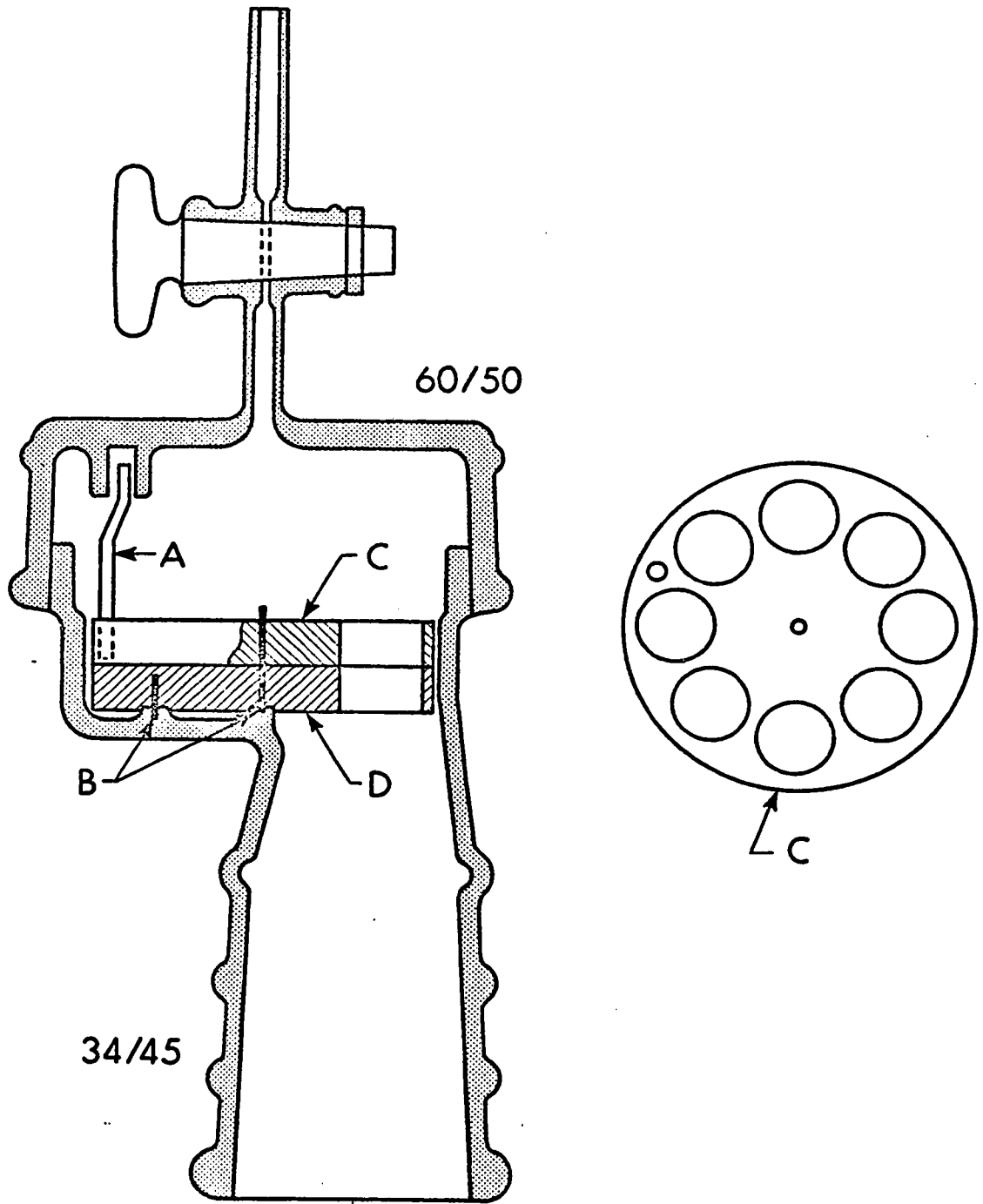

Figure 20. Salt cup dispensing device.

Electrical conductance was measured with a Leeds and Northrup Dike-Jones conductance bridge in conjunction with a General Radio Model 1310-A signal generator and Model 1323-A tuned amplifier -null detector. Fig. 21 illustrates a diagram of the electrical apparatus. The components were separated several feet from each other to prevent electrical interaction. All leads were electrically shielded and the shields as well as the Wagner earthing device on the bridge were grounded. The ground consisted of a heavy gauge insulated copper cable connected to a metal rod driven into the ground. A 30,000 ohm shunt arrangement was used for measuring very high resistances. The frequencies of the signals employed were 1, 2 and 5 KHz (kilocycles per second). The change in measured resistance between 1 and 5 KHz was generally about 0.1%. The resistances were corrected for a small frequency dependence by extrapolating measurements at 1, 2 and 5 KHz to infinite frequency.

Temperature control is extremely important in conductance measurements because conductance of an electrolyte is a function of temperature (e.g. the change is generally of the order of  $\pm 1$  to  $\pm 2\%$  per degree). Therefore, special care was taken to maintain a constant temperature near  $25^{\circ}\text{C}$  during all conductance measurements.

The thermostat bath consisted of a seven-gallon glass vessel insulated with 2 inches of fiberglass and filled with light paraffin oil (Fisher Scientific Co). A constant temperature of  $25^{\circ}\text{C}$  was



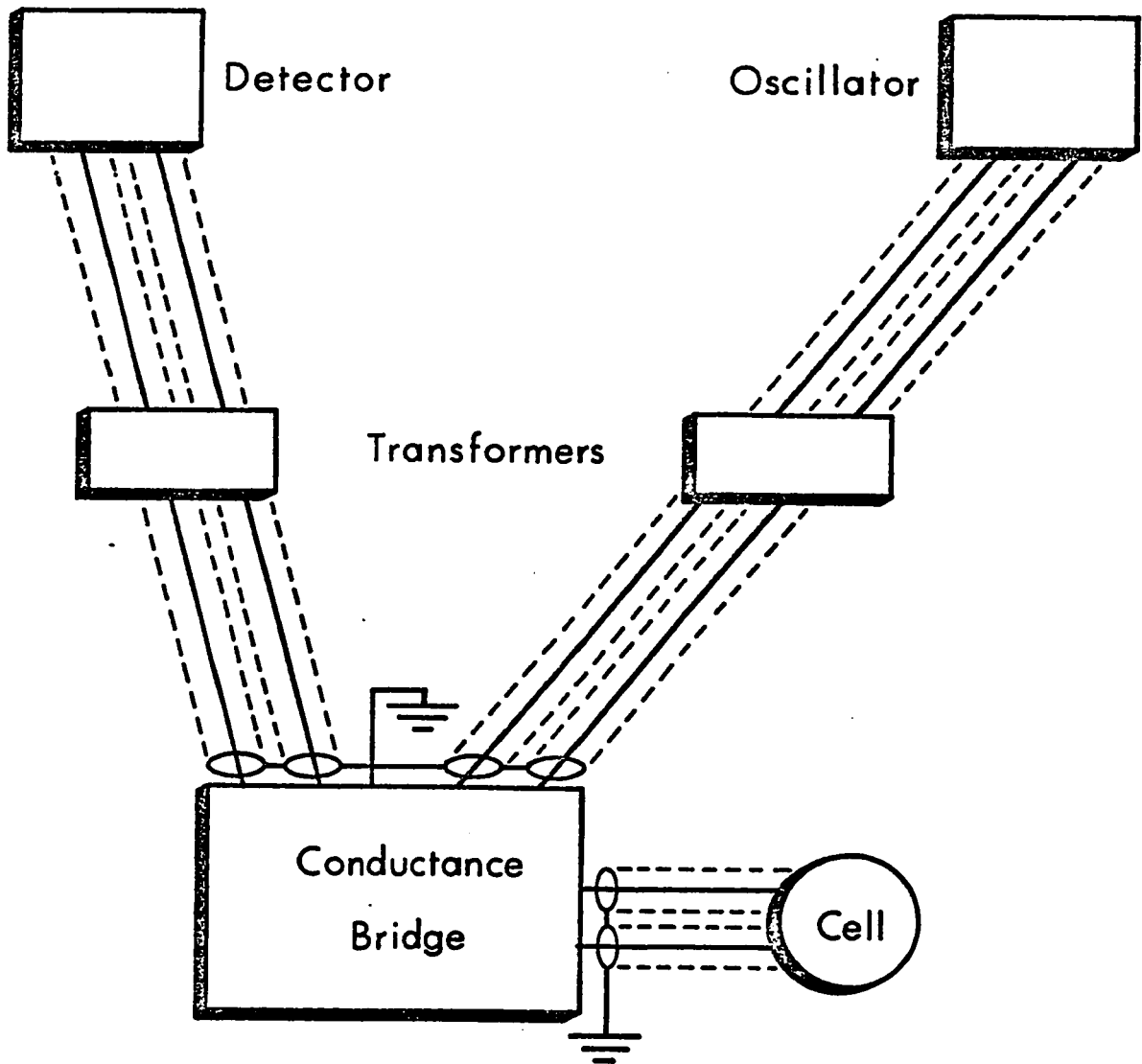

Figure 21. Electrical components for conductance measurements.

maintained. The bath was stirred with a heavy duty stirring motor (Fisher Catalog No. 14-501-5v1). A Fisher Proportional Temperature Control (Catalog No. 15-177-50) with a thermistor probe and a 300 watt heating element provided temperature control. The bath temperature was adjusted to  $25 \pm 0.003^{\circ}\text{C}$  with the use of a Beckmann differential thermometer calibrated by using a Leeds and Northrup platinum-resistance thermometer, type G-1 Mueller bridge and optical scale galvanometer. The temperature was maintained within 0.003 of  $25^{\circ}\text{C}$  during all measurements.

#### Experimental procedure

The salt cups and Teflon-coated stirring bar were cleaned with aqua regia, and then rinsed 8 to 10 times with distilled water and three times with conductance water to prevent impurities from being introduced into the experimental system. The conductance cell was cleaned with concentrated nitric acid, rinsed several times with distilled water and conductance water and dried at  $110^{\circ}$  for several hours. Frequently the salt cups and the conductance cell were treated with alcoholic sodium hydroxide, followed by 2 M hydrochloric acid solution as precaution against organic impurities which might have come from conductance water prepared by passage through an ion-exchange column.

Dried thallium (I) salts were weighed in the salt cups in air on a Sartorius Model 2462 analytical balance to  $\pm 0.0001$  g and placed in a desiccator over magnesium perchlorate desiccant until used.

To perform a conductance experiment in a binary aqueous mixture, the dry conductance cell was capped and weighed on a Sartorius Model 2250 top-loading balance to  $\pm 0.02$  g. Then a calculated amount of purified organic solvent was delivered from a buret to the cell, the cell was reweighed, and conductivity water of calculated volume was delivered from another buret until the required volume was reached. The cell was again reweighed. The compositions of binary aqueous solvent mixtures were reported as percentage by weight, % (w/w). When pure water was used as a solvent, the conductivity water was delivered to the weighed cell and the cell was reweighed. A  $1\frac{1}{2}$ -inch Teflon-coated magnetic stirring bar was added after the conductance cell and solvent had been weighed and the cell placed in the thermostat bath.

After the salt cup dispenser was mounted and temperature equilibrium attained, the solvent conductance was measured. This was done by placing 30,000 ohms of the bridge resistors in parallel with the cell resistance and measuring the equivalent resistance. The solvent resistance was then calculated from the measured value.

In order to keep solvent from condensing in the salt cup dispenser a heat lamp was directed on the dispenser as needed during the measurements. The salt cups were successively dropped into a solution being studied and the solution was stirred until no detectable change in the measured resistance was observed for 5 to 10 minutes.

Once equilibrium was attained the rate of stirring did not affect the resistance readings. The temperature was adjusted to  $25 \pm 0.003^{\circ}\text{C}$  before resistance readings were made for each cup. Resistance measurements were made at 1, 2 and 5 KHz.

## RESULTS AND DISCUSSION

Solvent properties at 25°C are listed in Table XIII, where  $D$  is dielectric constant,  $\eta$  is viscosity,  $d$  is density, and  $\alpha$  and  $\beta$  are constants. The constants  $\alpha$  and  $\beta$  are functions of the temperature, dielectric constant and viscosity of the solvent as well as the solute charge type. The values of  $\alpha$  and  $\beta$  can be obtained from the Debye-Hückel-Onsager equation, that is

$$\text{Slope (S)} = \frac{8.20 \times 10^5}{(D \times T)^{3/2}} \Lambda_o + \frac{82.5}{(D \times T)^{1/2} \eta} \quad (11)$$

$$= \alpha \Lambda_o + \beta \quad (12)$$

where  $\alpha = \frac{8.20 \times 10^5}{(D \times T)^{3/2}}$

$$\beta = \frac{82.5}{(D \times T)^{1/2} \eta}$$

$T$  = absolute temperature

The molar concentrations ( $c$ , moles liter<sup>-1</sup>) and measured equivalent conductances ( $\Lambda$ , ohm<sup>-1</sup> cm<sup>2</sup> equiv.<sup>-1</sup>) of thallium (I) acetate in water, acetonitrile/water, *p*-dioxane/water, and isopropyl alcohol/water mixtures are summarized in Table XIV. The data obtained from thallium (I) perchlorate in 86.8% (w/w) acetonitrile/water mixture is presented in Table XV. Typical plots of  $\Lambda$  against  $C^{1/2}$  (phoreograms<sup>88</sup>) for TlOAc and TlClO<sub>4</sub> are shown in Figures 22, 23, 24 and 25. The plot for TlOAc in water was a straight line which was extrapolated to the limiting molar conductance of 115.54 as compared with 115.63 reported by Robinson and

TABLE XIII

Properties of water and some binary water/solvent mixtures at 25°C

Solvent	D	$\eta \times 10^3$ (poise)	d (g/cm <sup>3</sup> )	$\alpha$	$\beta$
Water	78.54 <sup>a</sup>	10.00 <sup>a</sup>	0.9970 <sup>a</sup>	0.2281	60.14
20.6% (w/w) Acetonitrile	70.3 <sup>b</sup>	9.60 <sup>b</sup>	0.9622 <sup>b</sup>	0.2706	59.39
43.8% (w/w) Acetonitrile	59.8 <sup>b</sup>	8.00 <sup>b</sup>	0.9070 <sup>b</sup>	0.3445	77.25
70.0% (w/w) Acetonitrile	47.7 <sup>b</sup>	5.60 <sup>b</sup>	0.8440 <sup>b</sup>	0.4852	123.6
86.8% (w/w) Acetonitrile	41.1 <sup>b</sup>	4.10 <sup>b</sup>	0.8038 <sup>b</sup>	0.6029	181.7
39.8% (w/w) Dioxane	44.7 <sup>c</sup>	17.2 <sup>c</sup>	1.027 <sup>c</sup>	0.5325	41.56
52.7% (w/w) Dioxane	33.5 <sup>c</sup>	19.5 <sup>c</sup>	1.034 <sup>c</sup>	0.8208	42.39
69.7% (w/w) Dioxane	19.3 <sup>c</sup>	19.3 <sup>c</sup>	1.037 <sup>c</sup>	1.881	56.24
38.5% (w/w) Iso-PrOH	50.7 <sup>d</sup>	28.7 <sup>e</sup>	0.9300 <sup>e</sup>	0.4409	23.37
49.8% (w/w) Iso-PrOH	42.5 <sup>d</sup>	30.8 <sup>e</sup>	0.9040 <sup>e</sup>	0.5734	23.77
73.3% (w/w) Iso-PrOH	27.0 <sup>d</sup>	28.0 <sup>e</sup>	0.8440 <sup>e</sup>	1.136	32.87

a Reference 4.

b Interpolated values obtained from reference 65.

c Interpolated values obtained from reference 69.

d Interpolated values obtained from reference 64.

e Interpolated values obtained from reference 87.

TABLE XIV

Measured Equivalent Conductances of Thallium (I) acetate in Water  
and Binary Water/solvent Mixtures at 25°C

$C \times 10^4$	$\Lambda$	$C \times 10^4$	$\Lambda$
<u>In water</u>		<u>In 39.8% (w/w) p-dioxane</u>	
3.115	114.21	1.968	59.85
4.087	113.90	4.471	58.88
6.989	113.81	7.879	58.21
7.857	113.02	11.483	57.79
9.291	113.27	13.523	57.40
10.206	112.94	15.729	57.15
10.928	112.98		
15.368	112.53		
<u>In 20.6% (w/w) acetonitrile</u>		<u>In 52.7% (w/w) p-dioxane</u>	
1.517	99.92	2.309	49.35
3.319	99.86	5.368	48.00
5.461	99.78	8.287	47.03
7.762	99.49	11.587	46.09
9.757	99.44	15.031	45.05
		17.684	44.45
<u>In 43.8% (w/w) acetonitrile</u>		<u>In 69.7% (w/w) p-dioxane</u>	
1.470	97.52	3.743	31.55
3.005	97.07	6.328	28.69
4.660	96.18	8.887	26.72
6.061	95.90	12.127	24.97
7.137	95.24	15.754	23.43
<u>In 70.0% (w/w) acetonitrile</u>		<u>In 38.5% (w/w) iso-PrOH</u>	
2.174	97.16	1.826	41.75
4.244	94.64	4.515	41.05
6.238	92.91	5.962	40.89
7.508	91.86	9.822	40.43
8.633	90.97	14.017	40.09
		16.939	39.78

Continued . . . .

TABLE XIV - Continued

$C \times 10^4$	$\Lambda$	$C \times 10^4$	$\Lambda$
<u>In 86.8% (w/w) acetonitrile</u>		<u>In 49.8% (w/w) iso-PrOH</u>	
2.976	100.23	1.249	34.65
4.933	90.85	5.384	33.76
7.646	82.58	7.486	33.32
11.224	74.39	9.602	33.07
14.728	68.79	11.541	32.80
18.614	63.97		
		<u>In 73.3% (w/w) iso-PrOH</u>	
		1.407	24.64
		3.749	23.38
		5.695	22.50
		9.434	21.16
		12.564	20.29
		15.716	19.57

TABLE XV

Measured Equivalent Conductances of Thallium (I) perchlorate at  
25°C

$C \times 10^4$	$\Lambda$
<u>In 86.8% (w/w) acetonitrile</u>	
5.062	166.45
7.161	164.75
9.240	163.26
12.168	159.81
17.043	157.75
22.860	



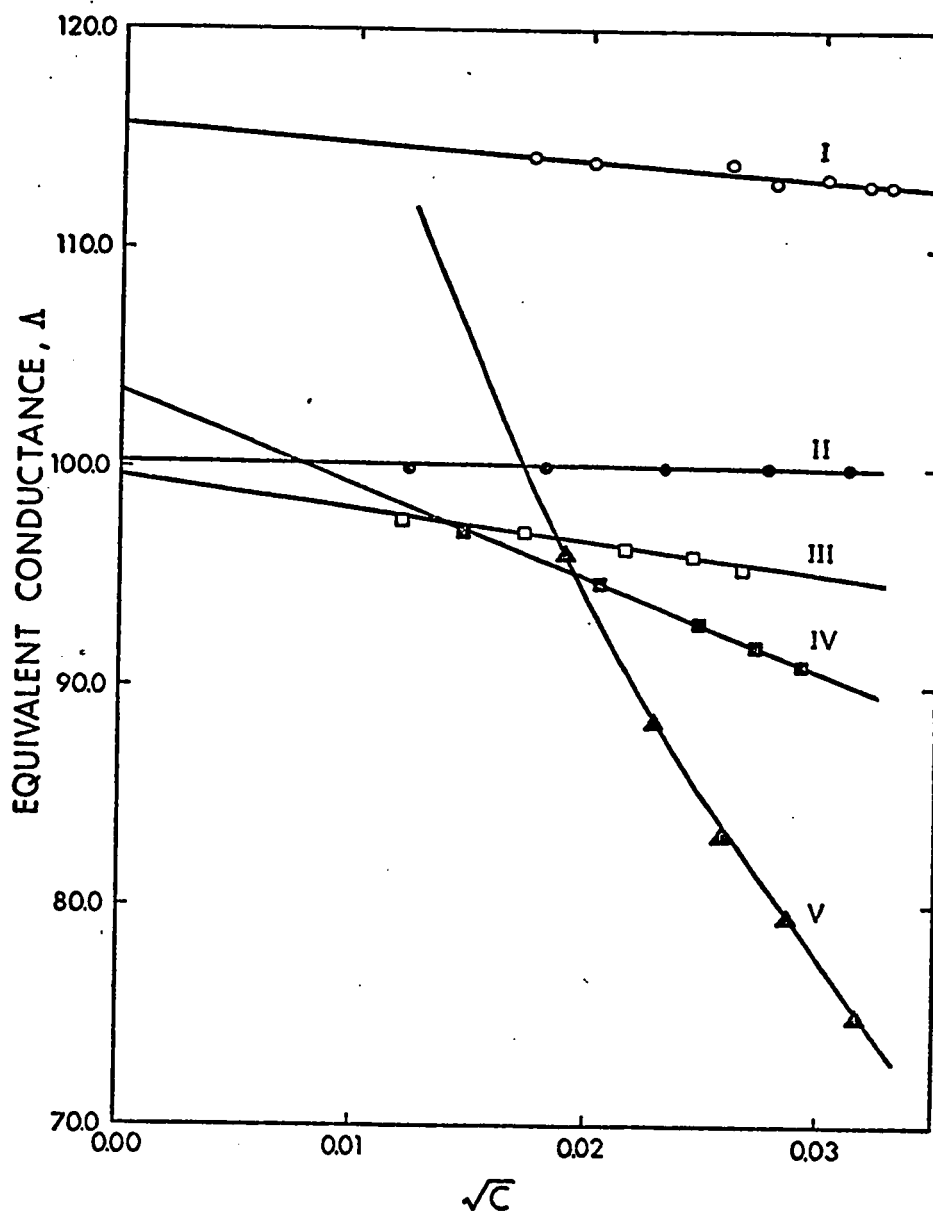

Figure 22. Equivalent conductance as function of concentration for TlOAc in : water (curve I), 20.6% acetonitrile (curve II), 43.8% acetonitrile (curve III), 70.0% acetonitrile (curve IV), and 86.8% acetonitrile (curve V).

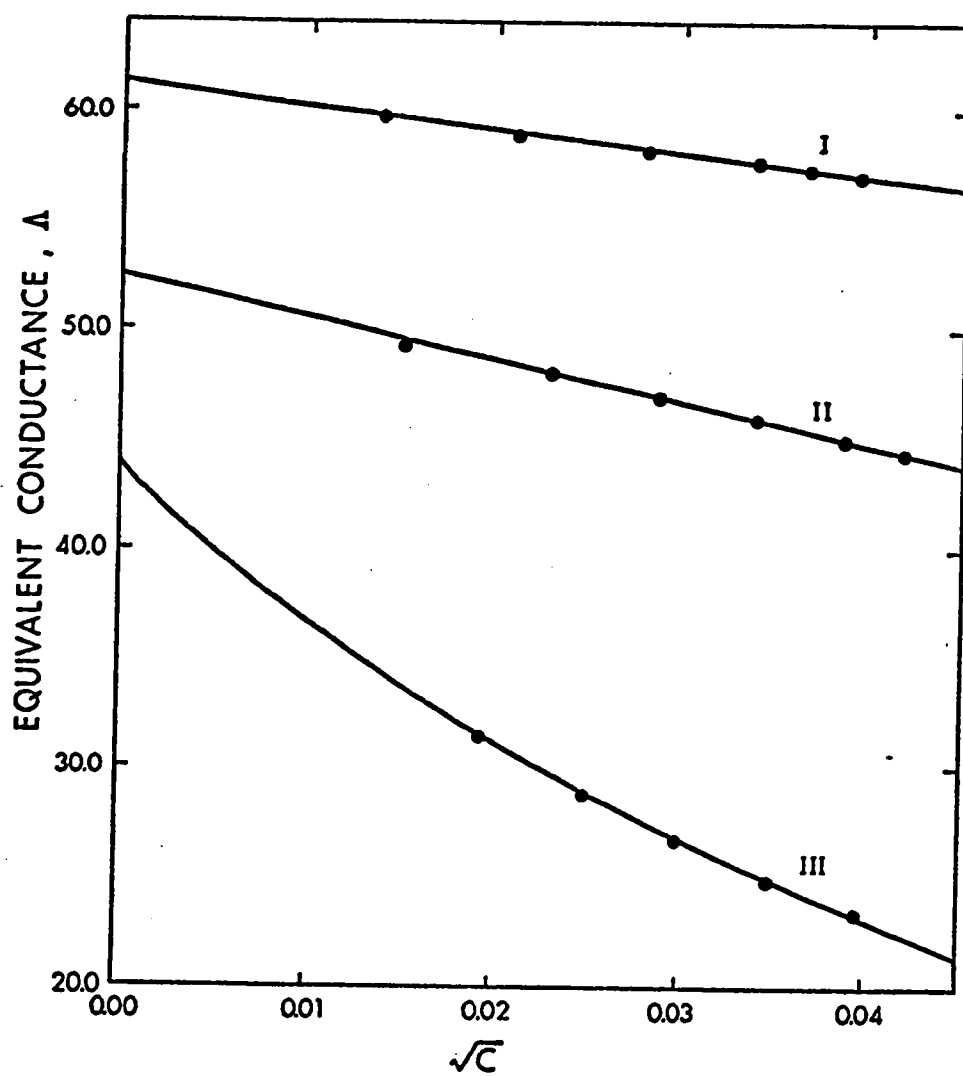

Figure 23. Equivalent conductance as function of concentration for TlOAc in: 39.8% p-dioxane (curve I), 52.7% p-dioxane (curve II), and 69.7% p-dioxane (curve III).

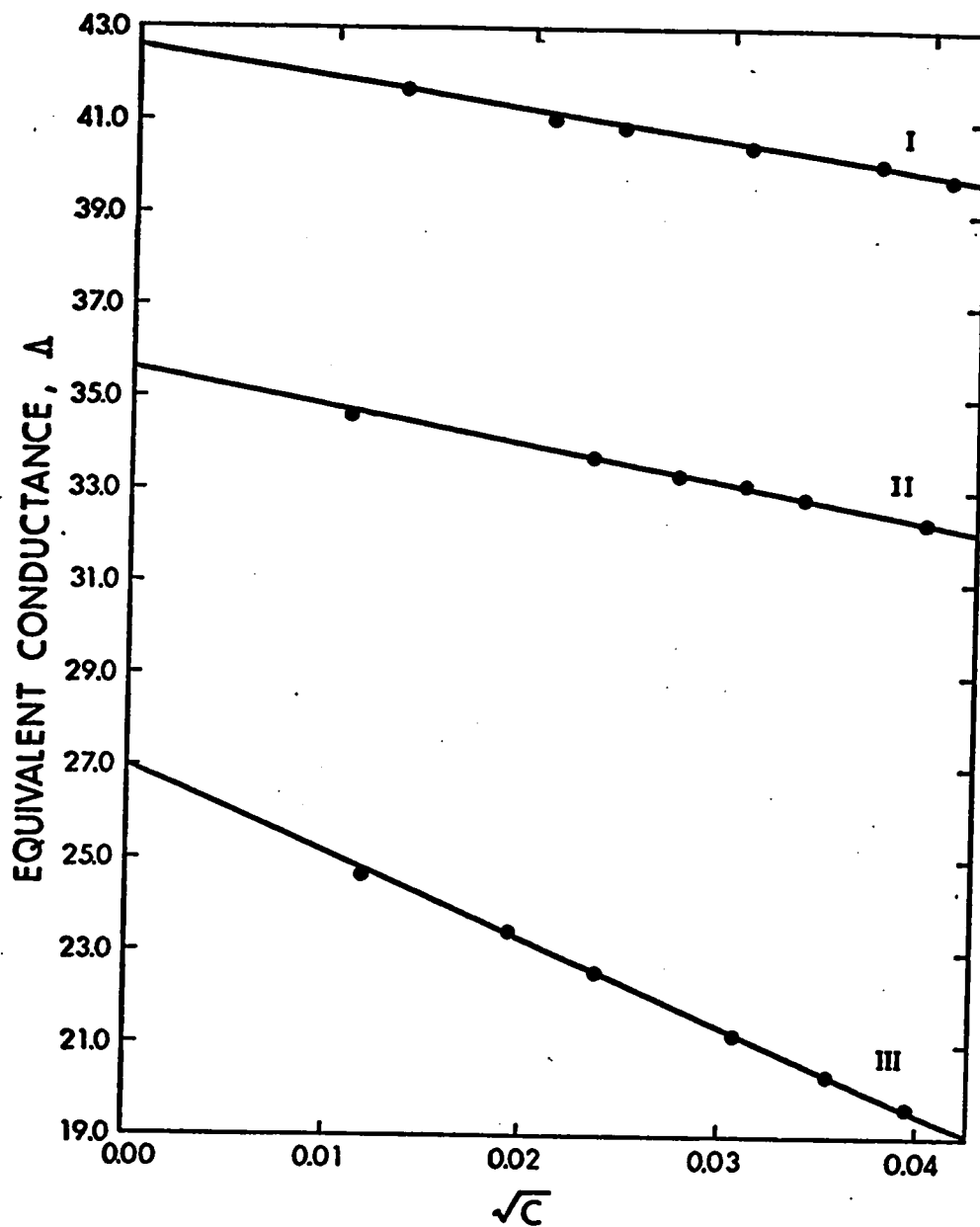

Figure 24. Equivalent conductance as function of concentration for TlOAc in: 38.5% iso-PrOH (curve I), 49.8% iso-PrOH (curve II), and 73.3% iso-PrOH (curve III).

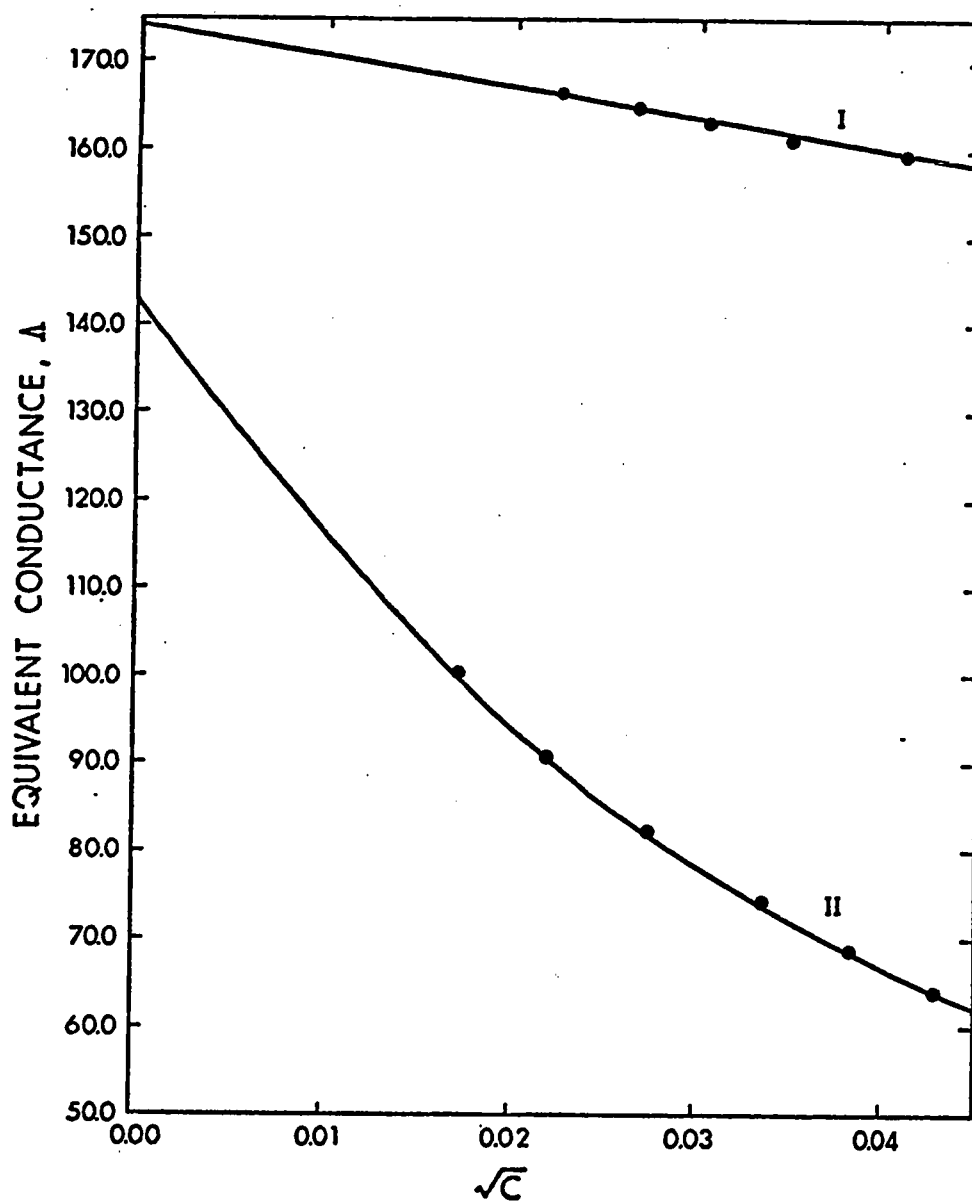

Figure 25. Equivalent conductance as function of concentration for  $\text{TlClO}_4$  (curve I) and  $\text{TlOAc}$  (curve II) in 86.8% acetonitrile/water mixture.

Davies<sup>10</sup>. The slope and the limiting equivalent conductance ( $\Lambda_0$ ) were calculated by the least-squares method.

Figure 22 illustrates the curves of  $\Lambda$  vs.  $C^{1/2}$  for TlOAc in water and in a series of acetonitrile/water mixtures. It is seen that the first four curves show a linear relationship while the fifth one (86.8% acetonitrile solution) has an upward curvature which clearly indicates ion-pair formation. The most interesting fact evident in Fig. 22 is the crossover that occurred in 70.0% (w/w) acetonitrile and 86.8% (w/w) acetonitrile solutions. This crossover observed in the low concentration region may be attributed to the decrease in viscosity of solution with increasing acetonitrile concentration, giving rise to high mobilities of  $Tl^+$  and  $OAc^-$  ions in the two mixtures. This is in contrast with the same curves in the high concentration region, where ion-pair formation overcomes the viscosity effect, resulting in relatively low values of conductance.

The phoreograms of TlOAc in a series of p-dioxane/water and iso-propyl alcohol/water mixtures are shown in Figures 23 and 24, respectively. Although the p-dioxane/water series has a dielectric constant range similar to that of the iso-propyl alcohol/water series (ca. 20 to 50), the latter series has a higher viscosity range. Therefore, the low values of conductance observed in iso-propyl alcohol/water solutions may be attributed to the effect of the viscosity of the solvent system. It should be noted that curve III of Fig. 23 in which the data was obtained from 69.7% (w/w) p-dioxane/water solution also shows an upward curvature as similar to curve V of

Fig. 22. It is obvious that extensive association of TlOAc is occurring in 69.7% (w/w) p-dioxane/water and 86.8% (w/w) acetonitrile/water solutions.

The limiting equivalent conductances and the comparison of the experimental slope with the Onsager slope for TlOAc are summarized in Table XVI. The limiting equivalent conductances in 86.8% (w/w) acetonitrile/water and in 69.7% (w/w) p-dioxane/water solutions could not be accurately determined because of the curvature of the phoreograms (see curve II, Fig. 25 and curve III, Fig. 23). Thus, the values of  $\Lambda_0$  reported for these two mixtures are only approximate. The definite curvature on the phoreograms clearly indicates significant association in the two solvent systems.

The last column of Table XVI gives the deviation of the experimental slope from the Onsager slope. The slight deviation observed from TlOAc in water showed essentially complete dissociation of the salt. As expected, in binary aqueous solvent mixtures the slopes are steeper (increasing values of  $\Delta S$ ) with increasing non-aqueous concentrations, indicating that TlOAc is somewhat associated in these solutions. It should be noted that the experimental slope for TlOAc is markedly different from the Onsager slope in 86.8% (w/w) acetonitrile/water mixture in comparison with that for TlClO<sub>4</sub> in the same mixture. Fig. 25 illustrates the phoreograms of the two salts in the solvent system. The comparison suggests that TlOAc behaves as a weak electrolyte in this solution, existing largely as ion-pairs, whereas TlClO<sub>4</sub> exhibits strong electrolyte behavior in the same solution.

TABLE XVI

Limiting conductances and deviations from the Debye-Hückel-Onsager equation for TIOAc in various solvent mixtures at 25°C

Solvent	$\Lambda_0$	$\alpha$	$\beta$	Slope		$\Delta S^a$
				Onsager	Experimental	
Water	115.54	0.2281	60.14	86.49	77.94	-9.885
20.6% (w/w) Acetonitrile	100.3	0.2706	59.39	86.53	27.10	-68.68
43.8% (w/w) Acetonitrile	99.52	0.3445	77.25	111.5	153.3	+36.19
70.0% (w/w) Acetonitrile	103.3	0.4852	123.6	173.7	418.9	+141.2
86.8% (w/w) Acetonitrile	ca. 143 <sup>b</sup>	0.6029	181.7	267.9	ca. 1500 <sup>c</sup>	+460
86.8% (w/w) Acetonitrile	173.8*	0.6029	181.7	286.5	340.3	+18.78
39.8% (w/w) Dioxane	60.65	0.5325	41.56	73.86	86.72	+17.41
52.7% (w/w) Dioxane	52.22	0.8208	42.39	85.25	183.4	+115.1
69.7% (w/w) Dioxane	ca. 44 <sup>b</sup>	1.881	56.24	129.4	ca. 450 <sup>c</sup>	+250
38.5% (w/w) Iso-PrOH	42.59	0.4409	23.37	42.15	68.31	+62.04
49.8% (w/w) Iso-PrOH	35.60	0.5734	23.77	44.18	84.21	+90.61
73.3% (w/w) Iso-PrOH	27.02	1.136	32.87	63.56	189.1	+197.5

$$a \quad \Delta S = \frac{100(S_{\text{expt}} - S_{\text{Onsager}})}{S_{\text{Onsager}}}$$

b

Approximate value.

c

Taken from straight-line region.

\*TlClO<sub>4</sub>

The limiting equivalent conductances ( $\Lambda_o$ ) and Walden's products of thallium (I) acetate in various solvent systems are listed in Table XVII. According to Walden's rule, the product is constant, i. e.,

$$\Lambda_o \cdot \eta = \text{constant}$$

which is derivable from Stokes' law. Applying the Stokes' law of ionic motion, the ' $\Lambda_o \cdot \eta$ ' product is inversely proportional to the effective ionic radius,  $r$ , as given by:

$$\Lambda_o \cdot \eta \propto \frac{1}{r}$$

As seen from Table XVII the limiting equivalent conductance-viscosity products (Walden's products) are obviously not constant, showing that Walden's rule is not valid in any of these cases. The inconstancy of the products, therefore, may be attributed to variations in the effective radii of  $Tl^+$  and  $OAc^-$  ions within the primary solvation sheath as the concentration of non-aqueous solvent increased, presumably owing to dehydration. From these results, it is seen that not only the viscosity of the medium, but also the degree of ion solvation plays a dominant role on the inconstancy in  $\Lambda_o$ .

A plot of the variation in  $\Lambda_o$  with the composition of acetonitrile for  $TlOAc$  in acetonitrile/water mixtures is presented in Fig. 26. The curve shows a flat region in the range between 10 and 40 mole percent of acetonitrile. The shape of this curve is similar to that reported by Frankel<sup>89</sup> who studied solvent selectivity of  $Cl^-$  ions in this solvent mixture by the N.M.R. technique.



TABLE XVII  
 Limiting equivalent conductances and Walden's products at 25°C  
 for thallium (I) acetate in various solutions

Solvent	$\Lambda_o$	$\eta$ (poise)	$\Lambda_o \cdot \eta$
Water	115.5	0.0100	1.16
20.6% (w/w) Acetonitrile	100.3	0.0096	0.963
43.8% (w/w) Acetonitrile	99.52	0.0080	0.796
70.0% (w/w) Acetonitrile	103.3	0.0056	0.578
86.8% (w/w) Acetonitrile	143 <sup>a</sup>	0.0041	0.586
39.8% (w/w) Dioxane	60.65	0.0172	1.04
52.7% (w/w) Dioxane	52.22	0.0195	1.02
69.7% (w/w) Dioxane	44 <sup>a</sup>	0.0193	0.849
38.5% (w/w) Iso-PrOH	42.59	0.0287	1.22
49.8% (w/w) Iso-PrOH	35.60	0.0308	1.09
73.3% (w/w) Iso-PrOH	27.02	0.0280	0.756

<sup>a</sup> Approximate value.

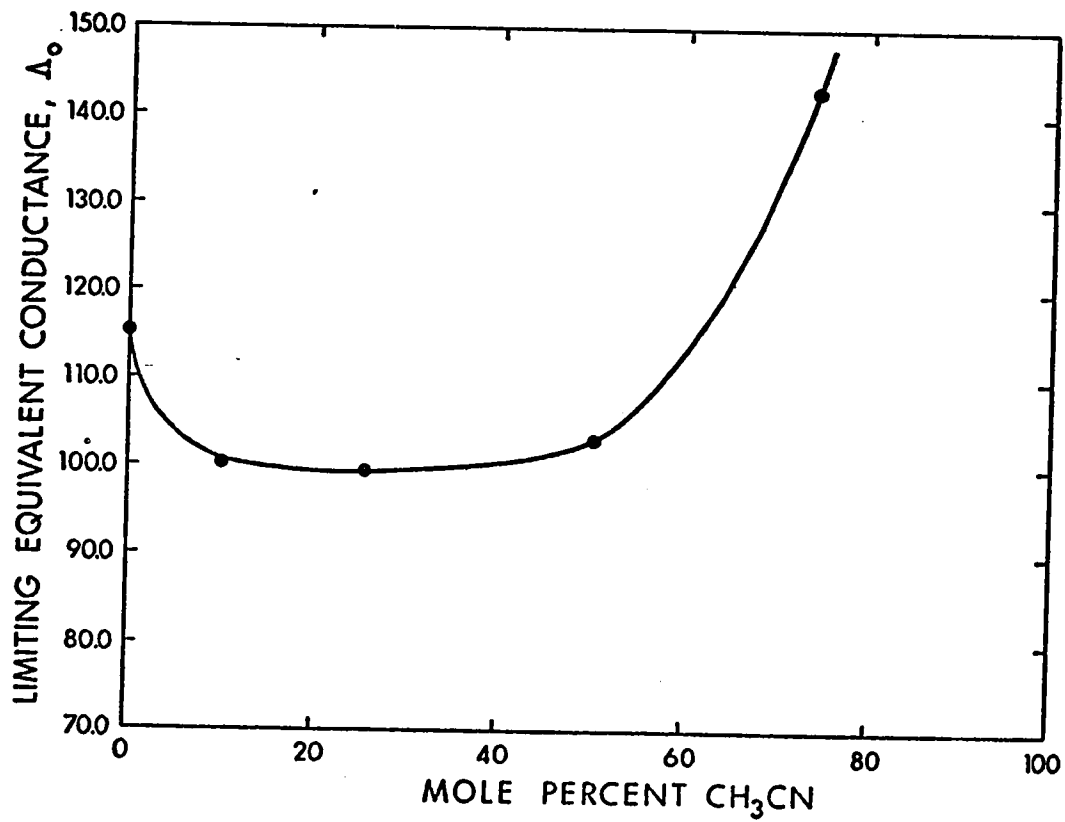

Figure 26. Variation of  $\Lambda_0$  with mole percent of acetonitrile for TlOAc in acetonitrile/water mixtures.

He reported that the activity coefficient of each component in acetonitrile/water system was relatively independent of the solvent composition in the plateau region, giving rise to an unusually small variation in the ratio of solvent activities in the region. It may be assumed that this effect is also the reason for the plateau region in Fig. 26.

The ion-pair association constants of thallium (I) acetate in a series of acetonitrile/water, p-dioxane/water and isopropyl alcohol/water mixtures are summarized in Table XVIII. These results were calculated by the Fuoss-Onsager theory, using the least-squares computer program employed by Yeager<sup>84</sup>.

The high values of the association constant for TlOAc in 86.8% acetonitrile and 69.7% p-dioxane solutions are obviously due to extensive formation of ion-pairs, as represented by the definite curvature on the phoreograms shown by curve II, Fig. 23 and curve III, Fig. 24, respectively.

TABLE XVIII  
 Association constants of thallium (I) acetate in binary water/  
 solvent mixtures at 25°C

Solvent	D	$K_A$
20.6% (w/w) Acetonitrile	70.3	0.0
43.8% (w/w) Acetonitrile	59.8	35.0
70.0% (w/w) Acetonitrile	47.7	$1.78 \times 10^2$
86.8% (w/w) Acetonitrile	41.1	$1.27 \times 10^3$
39.8% (w/w) Dioxane	44.7	0.0
69.7% (w/w) Dioxane	19.3	$1.17 \times 10^3$
38.5% (w/w) Iso-PrOH	50.7	77.0
49.8% (w/w) Iso-PrOH	42.5	$1.16 \times 10^2$
73.3% (w/w) Iso-PrOH	27.0	$1.86 \times 10^2$

## SUMMARY

1. The conductances at 25°C of thallium (I) acetate in water, acetonitrile/water, p-dioxane/water, and iso-propyl alcohol/water and of thallium (I) perchlorate in 86.8% (w/w) acetonitrile/water have been determined in the concentration range of  $10^{-4}$  to  $10^{-3}$  M.
2. It is shown that, in 86.8% (w/w) acetonitrile/water mixture, TlOAc behaves as a weak electrolyte, whereas TlClO<sub>4</sub> shows strong electrolyte behavior. The significant association observed for TlOAc in this solvent system is attributed to ion-pair formation.
3. The experimental slopes for the plots of  $\Lambda_o$  against  $C^{1/2}$  for TlOAc and TlClO<sub>4</sub> were compared with the Onsager slope. The large deviation from the theoretical values for TlOAc has been attributed to association into ion-pairs.
4. The variation of Walden's product values as a function of dielectric constant of the medium for TlOAc in the solvent systems studied is discussed. The inconstancy of the Walden products is explained in terms of variations in the ionic radii of the primary solvation sheath with solvent composition changes.
5. The association constants of TlOAc in 86.8% (w/w) acetonitrile/water and 69.7% (w/w) p-dioxane/water mixtures were found to be  $1.27 \times 10^3$  and  $1.12 \times 10^3$ , respectively.

## BIBLIOGRAPHY

1. W. Crookes, Chemical News, 3, 193, 303 (1861); 5, 349 (1862); 7, 145 (1863).
2. W. Crookes, J. Chem. Soc., 17, 142 (1864).
3. I. M. Korenman, "Analytical Chemistry of Thallium", Ann-Arbour Humphrey Science Publishers, London, 1969, p. 117.
4. R. C. Weast, Ed., "Handbook of Chemistry and Physics", 50th. ed., The Chemical Rubber Co., Ohio, 1969, p. B-51.
5. W. B. Deichmann and H. W. Gerarde, "Toxicity of Drugs and Chemicals", Academic Press, New York, N.Y., 1969, p. 582.
6. G. V. Samsonov, "Handbook of the Physicochemical Properties of the Elements", Plenum, New York, N.Y., 1968, p. 855.
7. G. Grunfeld and G. Hinostroza, Arch. Int. Med., 114, 132 (1964).
8. H. Heydlang, Eur. J. Pharm., 6, 340 (1969).
9. M. H. Panckhurst, Aus. J. Chem., 15, 194 (1962).
10. R. A. Robinson and C. W. Davies, J. Chem. Soc., 574 (1937).
11. V. S. K. Nair and G. H. Nancollas, ibid., 318 (1957).
12. R. P. Bell and J. H. B. George, Trans. Faraday Soc., 49, 619 (1953).
13. H. Fromherz and K. H. Lih, Z. Physik Chem., A153, 321 (1931).
14. R. P. Bell and M. H. Panckhurst, Recueil, 75, 725 (1956).
15. P. A. Zagorets and G. P. Bulgakova, Russ. J. Inorg. Chem., 12, 179 (1967).

16. H. B. George, J. A. Rolfe and L. A. Woodward, Trans. Faraday Soc., 49, 375 (1953).
17. R. Freeman, R. H. P. Gasser, R. E. Richards and D. H. Wheeler, Mol. Phys., 2, 75 (1959).
18. R. H. P. Gasser and R. E. Richards, ibid., 2, 357 (1959).
19. H. S. Gutowsky and B. R. McGarvey, Phys. Rev., 91, 81 (1953).
20. F. Seitz, J. Chem. Phys., 6, 150 (1938).
21. R. Hilsch, Phys. Soc., 49, 40 (1937).
22. P. H. Yuster and C. J. Delbecq, ibid., 21, 892 (1953).
23. K. Osada, J. Phys. Soc. Japan, 8, 226 (1953).
24. A. K. Ghosh, J. Chem. Phys., 44, 535 (1966).
25. J. A. Duffy and M. D. Ingram, ibid., 52, 3752 (1970).
26. Kuo-Hao Hu and A. B. Scott, J. Amer. Chem. Soc., 77, 1380 (1955).
27. A. B. Scott and Kuo-Hao Hu, J. Phys. Chem., 23, 1830 (1955).
28. A. B. Scott, R. G. Dartau and S. Sapsioonthorn, Inorg. Chem., 1, 315 (1962).
29. F. Ya Kulba and V. E. Mironov, Russ. J. Inorg. Chem., 2, 78 (1957); 3, 68 (1958).
30. R. O. Nilsson, Arkiv. Kemi, 10, 363 (1956).
31. H. I. Popov and R. E. Humphrey, J. Amer. Chem. Soc., 81, 2043 (1959).
32. I. M. Kolthoff, D. S. Stocesoca and T. S. Lee, ibid., 75, 1834 (1953).

33. T. R. Griffiths and M. R. C. Symons, Mol. Phys., 3, 90 (1960).
34. I. M. Kolthoff and J. F. Coetzee, J. Amer. Chem. Soc., 79, 870, 1852 (1957).
35. J. F. Coetzee, D. K. McGuire and J. L. Hedrick, J. Phys. Chem., 67, 1814 (1963).
36. P. H. Tewari and G. P. Johari, ibid., 67, 512 (1963).
37. H. L. Yeager and B. Kratochvil, J. Phys. Chem., 74, 963 (1970).
38. A. I. Popov and D. H. Geske, J. Amer. Chem. Soc., 79, 2074 (1957).
39. S. Lal and S. N. Srivastava, Acta Chim. Acad. Sci. Hung. Tomus, 53, 127 (1967).
40. C. H. R. Gentry, Nature, 157, 479 (1946).
41. W. B. Schaap, A. E. Messner and F. C. Smidt, J. Amer. Chem. Soc., 77, 2683 (1955).
42. H. Letaw and J. A. H. Gropp, J. Phys. Chem., 57, 964 (1953).
43. D. C. Luehrs, J. Inorg. Nucl. Chem., 31, 3517 (1969).
44. D. R. Cogley and J. N. Butler, J. Electro. Chem. Soc., 113, 1074 (1966).
45. J. F. Coetzee and J. J. Campion, J. Amer. Chem. Soc., 89, 2517 (1967).
46. P. S. Buckley and H. Hartley, Phil. Mag., 8, 320 (1929).
47. A. MacFarlane and H. Hartley, ibid., 13, 425 (1932).
48. J. C. McLennan and M. F. Crawford, Proc. Roy. Soc. London, (A) 132, 10 (1931).



49. C. E. Moore, "Atomic Energy Levels", The National Bureau of Standards, U.S.A., Vol. 3, 1958, p. 204.
50. R. Hilsch, Z. Physik, 44, 860 (1927).
51. M. Forro, ibid., 56, 235, 534 (1929); 58, 613 (1930).
52. P. Pringsheim, "Fluorescence and Phosphorescence", Interscience Publishers, Inc., New York, N.Y., 1949.
53. F. E. Williams, J. Chem. Phys., 19, 457 (1951).
54. P. D. Johnson and F. E. Williams, ibid., 20, 124 (1952).
55. E. A. Boudreaux, L. D. Dureau and H. B. Jonassen, Mol. Phys., 6, 377 (1963).
56. P. Pringsheim and H. Vogels, Physica, 7, 225 (1940).
57. S. Makishima, T. Tomotsu, M. Hirata, S. Hayakawa, K. Hasegawa, R. Kambe and S. Shionoya, "Luminescence of Organic and Inorganic materials", H. P. Kallmann and G. R. Spruch, Eds., John Wiley & Sons, Inc., New York, 1962, p. 443.
58. P. Pringsheim, Rev. Mod. Phys., 14, 132 (1942).
59. C. K. Jorgensen, "Absorption Spectra and Chemical Bonding in Complexes", Pergamon Press, New York, 1962, p. 186.
60. R. M. Noyes, J. Amer. Chem. Soc., 84, 513 (1962).
61. R. P. Bell and J. E. Prue, J. Chem. Soc., 362 (1949).
62. M. J. Blandamer and M. F. Fox, Chem. Rev., 59 (1970).
62. (a) A. Weissberger, Ed., "Technique of Organic Chemistry", Vol. VII, Organic Solvents, 2nd. ed., revised by Riddick and Toops Jr., Interscience Publishers Inc., New York, 1955.

63. R. A. Long, Ph.D. Thesis, University of Alberta, 1969.
64. G. Akerlof, J. Amer. Chem. Soc., 54, 4125 (1932).
65. V. H. Strehlow and H. M. Koeppe, Z. Elektrochem., 62, 373 (1958).
66. M. J. Blandamer, T. E. Gough and M. C. R. Symons, Trans. Faraday Soc., 62, 296 (1966).
67. T. E. Hogen-Esch and J. Smid, J. Amer. Chem. Soc., 88, 307 (1966).
68. J. B. Hyne, J. Amer. Chem. Soc., 85, 304 (1963).
69. T. L. Fabry and R. M. Fuoss, J. Phys. Chem., 68, 971 (1964).
70. L. L. Chan and J. Smid, ibid., 90, 4654 (1968).
71. J. J. Lingane and I. M. Kolthoff, ibid., 61, 825 (1939).
72. D. Ilkovic, Coll. Czech. Chem. Comm., 6, 498 (1934).
73. C. Macgillavry and E. K. Rideal, Rec. Trav. Chim., 56, 1013 (1937).
74. J. J. Lingane, Ph.D. Thesis, University of Minnesota, 1938.
75. D. Ilkovic, Coll. Czech. Chem. Comm., 10, 249 (1938).
76. S. Wawzonek and M. E. Runner, J. Electrochem. Soc., 99, 457 (1952).
77. J. F. Coetzee 'Ionic Reactions in acetonitrile', in "Progress in Physical Organic Chemistry", vol. 4, A. Streitwieser, Jr., R. W. Taft, Eds., Interscience, New York, N.Y., 1969.
78. J. F. Coetzee, Diss. Abs. (Minnesota), 16, 1071 (1956).

79. R. Takahashi, "Modern Aspects of Polarography", T. Kamfara, Ed., Plenum Press, New York, N.Y., 1966, p. 190.
80. J. F. O'Donnell, J. T. Ayres and C. K. Mann, Anal. Chem., 37, 1161 (1965).
81. B. Kratochvil, E. Lorah and C. Garber, ibid., 41, 1793 (1969).
82. H. S. Frank and M. W. Evans, J. Chem. Phys., 13, 507 (1945).
83. H. M. Daggett, E. J. Bair and C. H. Kraus, J. Amer. Chem. Soc., 73, 799 (1951).
84. H. L. Yeager, Ph.D. Thesis, University of Alberta, 1969.
85. J. E. Lind Jr., J. J. Zwolenik and R. M. Fuoss, J. Amer. Chem. Soc., 81, 1557 (1959).
86. R. L. Kay, B. J. Hales, and G. P. Cunningham, J. Phys. Chem., 71, 3925 (1967).
87. A. L. Olsen and R. R. Washburn, ibid., 42, 275 (1938).
88. R. M. Fuoss, J. Chem. Educ., 32, 527 (1955).
89. L. S. Frankel, J. Can. Chem., 48, 2432 (1970).
90. M. H. Panckhurst, J. Phys. Chem., 73, 2097 (1969).

VITA

The author was born in Thailand on November 6, 1940. In 1963, he received a B.Sc. (Honors) degree in chemistry from Chulalongkorn University, Bangkok. He served from 1963 to 1966 as an instructor at Chiangmai University in Thailand. At the Department of Chemistry of Chiangmai University, he also worked as a research chemist with Dr. A. F. Gaines from England. He came to the University of Alberta, Edmonton, Canada in September 1966 and did research for the Ph.D. degree under the supervision of Professor W. F. Allen. At this university he was a research and teaching assistant from 1966-1971. He was the president of the Thai Students' Association in Alberta from 1969-1970. At the present time, he is a member of the academic staff of the Department of Chemistry at Chiangmai University in Chiangmai, Thailand.