

Evidence-Based Quantitative Assessment for Geriatric Design

by

Mona Afifi

A thesis submitted in partial fulfillment of the requirements for the degree of

Doctor of Philosophy

in

Construction Engineering and Management

Department of Civil and Environmental Engineering
University of Alberta

© Mona Afifi, 2015

ABSTRACT

Poor design of indoor architectural spaces can contribute to an increased risk of falling for older adults. Thus, this research aims to provide an architectural design assessment system to integrate state-of-the-art evidence-based research into an assessment process by which to evaluate the risk of falling for older adults in residential dwellings. The developed assessment is implemented on bathroom design in order to improve the surrounding environment for older adults who are living independently in their homes. The methodology of this research is divided into five stages. In Stage 1, a systematic review is conducted to ensure that relevant and available literature is reviewed and analyzed. In Stage 2, bathroom design assessment is conducted based on the conceptual approach of the divide and conquer algorithm (DCA). For bathroom design, the DCA is divided into five design elements: bathtub, toilet, lavatory, lighting, and flooring. Each design element is divided into a number of features and then into scenarios that define its architectural specifications. In Stage 3, a rating system is developed for the proposed DCA of the bathroom elements and features; this rating system presents the degree to which each element and its features reduce the risk of falling. Equal interval scaling is adopted for the rating system to provide quantitative values for the ordinal-scaled scenarios developed in the previous stage. In Stage 4, a mathematical model is developed by which to calculate the rating number that reflects the risk of falling associated with the bathroom design. In Stage 5, characterization of the proposed assessment system is undertaken to identify the model output limits and ranges. In this research, a new concept of Block Schema (BS) is developed based on anthropometric considerations in order to provide a graphical representation of the surrounding free-zone associated with each design element.

Acknowledgements

First, I want to thank God for providing me with the strength and the knowledge light that I needed to finish my research work.

I would like to express my deepest gratitude to my supervisor, Dr. Mohamed Al-Hussein, for his continuous encouragement, support and valuable advice throughout all stages of this research. His vision and dedication were indispensable in my efforts towards finishing this research. I would also like to extend my gratitude to my co-supervisor, Dr. Ahmed Bouferguene, for his guidance, encouragement and assistance. I am also grateful to Mr. Jonathan Tomalty and other staff in the Department of Civil and Environmental Engineering at the University of Alberta.

Great thanks are due to my wonderful parents, Eng. Khalil Wahdan and Eng. Suzan Afifi, who always believed in me. Also, I want to thank my lovely husband, Dr. Ahmed Fotouh, for his encouragement and support all the way throughout this research.

CONTENTS

ABSTRACT	ii
Acknowledgements	iii
CONTENTS	iv
LIST OF TABLES	vii
LIST OF FIGURES	x
CHAPTER 1: INTRODUCTION	1
1.1 Research Motivation	1
1.2 Research Objectives	3
1.3 Thesis Organization.....	5
CHAPTER 2: LITERATURE REVIEW	7
2.1 Introduction	7
2.2 Background on Geriatric Home Design	7
2.3 Bathroom Design.....	11
2.3.1 Geriatric Bathroom design	14
2.4 Background on Falling for Older Adults.....	16
2.5 Systematic Review	18
2.6 Focus Group Discussion.....	19
2.7 Background on Geriatric Centered Design (GCD)	22
CHAPTER 3: PROPOSED METHODOLOGY	24

3.1	Introduction	24
3.2	Systematic Review Approach	25
3.3	Divide and Conquer Algorithm (DCA).....	28
3.4	The Concept of Block Schema Feature.....	32
3.5	Scaling and Quantitative Rating System.....	34
3.5.1	Rating factor.....	35
CHAPTER 4: FRAMEWORK DEVELOPMENT AND		
IMPLEMENTATION.....		
4.1	Introduction	37
4.2	Analysis of Bathroom Design Elements and Features.....	40
4.2.1	Element 1: Toilet/Water Closet (BT).....	40
4.2.2	Element 2: Bathtub	51
4.2.3	Element 3: Lavatory (sink)	64
4.2.4	Element 4: Lighting	67
4.2.5	Element 5: Bathroom floor	75
4.3	Assessment Using Mathematical Modelling.....	78
4.3.1	Model Algorithm	78
4.3.2	Mathematical Model for bathroom architectural design.....	81
4.4	Generalized Equation of the Assessment Mathematical Model.....	85
4.5	Ordinal/Equal-Interval Scaling Assessment Tables.....	86
4.5.1	Generalized Equations of Assessment Limits.....	86
4.5.2	Equal-Interval-Ordinal Assessment Tables for Bathroom Design .	88
4.6	Characterization of the Developed Mathematical Assessment Model...	93

4.6.1	Bathroom Assessment Model Characterization	93
4.6.2	Scatter Analysis of the Output Data.....	97
4.7	Verification and Validation of the Developed Assessment Model	105
4.7.1	Model Test Run Verification	105
4.7.2	Validation of the Developed Assessment Model.....	123
	CHAPTER 5: CONCLUSION	136
5.1	Research Conclusions	136
5.2	Research limitations	137
5.3	Research Contributions	139
5.4	Recommendations for Future Research	140
	REFERENCES	143

LIST OF TABLES

Table 4.1: Rating factors for toilet height scenarios	41
Table 4.2: Rating factors for toilet grab-bar configuration scenarios	43
Table 4.3: Rating factors for toilet grab-bar diameter and surface texture scenarios	45
Table 4.4: Rating factors for toilet grab-bar height scenarios.....	47
Table 4.5: Rating factors for toilet supporting equipment accessibility	48
Table 4.6: Rating factors for toilet block schema scenarios	49
Table 4.7: Rating factors for toilet dimension scenarios	51
Table 4.8: Rating factors for scenarios of the bathtub grab-bar configuration for the entrance feature	53
Table 4.9: Rating factors for scenarios of bathtub grab-bar configuration installed on back wall feature	56
Table 4.10: Rating factors for scenarios of bathtub grab-bar diameter and surface texture feature	58
Table 4.11: Rating factors for bathtub dimension scenarios.....	60
Table 4.12: Rating factors for bathtub seat scenarios	60
Table 4.13: Rating factors for bathtub block schema scenarios	62
Table 4.14: Rating factors for bathtub flooring and surface scenarios	63
Table 4.15: Rating factors for bathtub supporting equipment accessibility	64
Table 4.16: Rating factors for lavatory height scenarios	65
Table 4.17: Rating factors for lavatory supporting items accessibility.....	66
Table 4.18: Rating factors for lavatory block schema scenarios	67

Table 4.19: Rating factors for illumination level scenarios	69
Table 4.20: Rating factors for lighting switch scenarios	70
Table 4.21: Rating factors for balance of lighting amount scenarios	72
Table 4.22: Rating factors for bathroom night-light scenarios	74
Table 4.23: Rating factors for bathroom floor slip-resistance scenarios	76
Table 4.24: Rating factors for bathroom floor height scenarios	77
Table 4.25: Rating factors for floor entrance clearance scenarios	78
Table 4.26: Assessment table for toilet element design (BT) and bathtub element design (BB)	90
Table 4.27: Assessment table for lavatory element design (BS) and bathroom flooring element design (BF)	91
Table 4.28: Assessment table for bathroom lighting element (BL)	92
Table 4.29: Assessment table for bathroom total rating number (N_{CT})	93
Table 4.30: Alternative values of R scenarios for each feature and the corresponding optimal N_C of the element calculated at maximum R for remaining element features	95
Table 4.31: Alternative values of R scenarios for each feature and the corresponding minimal N_C of the element calculated at minimum R for remaining element features	96
Table 4.32: Optimized values of the constants in Equations 4.23-4.26 for different bathroom design elements	104
Table 4.33: Features of bathroom toilet/water closet element (BT)	107
Table 4.34: Features of bathroom bathtub element (BB)	108

Table 4.35: Features of bathroom lavatory element (BV)	109
Table 4.36: Features of bathroom lighting element (BL)	110
Table 4.37: Features of bathroom floor element (BF)	111
Table 4.38: Features of bathroom toilet/water closet element (BT)	116
Table 4.39: Features of bathroom bathtub element (BB)	117
Table 4.40: Features of bathroom lavatory element (BV)	118
Table 4.41: Features of bathroom lighting element (BL)	119
Table 4.42: Features of bathroom floor element (BF)	119
Table 4.43: Features of bathroom toilet/water closet element (BT)	125
Table 4.44: Features of bathroom bathtub element (BB)	126
Table 4.45: Features of bathroom lavatory element (BV)	127
Table 4.46: Features of bathroom lighting element (BL)	128
Table 4.47: Features of bathroom floor element (BF)	129
Table 4.48: Features of bathroom toilet/water closet element (BT)	130
Table 4.49: Features of bathroom bathtub element (BB)	131
Table 4.50: Features of bathroom lavatory element (BV)	132
Table 4.51: Features of bathroom lighting element (BL)	132
Table 4.52: Features of bathroom floor element (BF)	133
Table 4.53: Features of bathroom floor element (BF)	135

LIST OF FIGURES

Figure 2.1. Adding extra space and adjusting wall structure for future extension	11
Figure 2.2. Bathroom cabinet and closet included in the bathroom	12
Figure 2.3. The concept of outdoor bathroom gives the bathtub panoramic natural view.....	13
Figure 2.4. Body parts affected by fall-related injuries for older adults, aged 65 years and over (PHAC 2014).....	17
Figure 3.1. Proposed research approach for bathroom architectural design assessment.....	25
Figure 3.2. Flowchart representing the systematic review process for bathroom design assessment.	27
Figure 3.3. Flowchart representing the construction of recursion analysis for DCA.	29
Figure 3.4. Flowchart representing partial DCA for bathroom design.	31
Figure 3.5. Various bathroom architectural design plans.	33
Figure 3.6. Examples of block schema interference: (A) toilet-lavatory block schema interference; (B) toilet-lavatory block schema clear of interference.	34
Figure 4.1. Flowchart for bathroom elements and features.	39
Figure 4.2. Optimal toilet grab-bar configuration on the side wall of the toilet. ..	43
Figure 4.3. Toilet block schema (BT _b), dimensions in mm.	49
Figure 4.4. Bathtub grab-bar configuration for the entrance at sidewall of bathtub: (A) optimal scenario, (B) second-best scenario.	53

Figure 4.5. Bathtub grab-bar configuration installed in the back wall of bathtub: (A) and (B) are optimal scenario.	55
Figure 4.6. Bathtub dimensions based on anthropometric considerations.....	59
Figure 4.7. Bathtub block schema.....	61
Figure 4.8. Lavatory block schema.	67
Figure 4.9. (A) Imbalanced lighting: shaded area resulting from down-lighting. (B) Balanced lighting: modified lighting location.	71
Figure 4.10. Lighting the pathway to the toilet at night.....	74
Figure 4.11. (A) Single door block schema; (B) Pocket door block schema.....	78
Figure 4.12. Flowchart of the developed mathematical model algorithm.	80
Figure 4.13. The optimal N_C values for Toilet/Water Closet (BT) at different R values of: toilet height (BT_h), toilet grab-bar configuration (BT_{gc}), toilet grab-bar diameter and surface texture (BT_{gd}), toilet grab-bar height (BT_{gh}), toilet supporting equipment and accessories (BT_s), toilet block schema (BT_b), and toilet dimensions (BT_d).	98
Figure 4.14. The minimal N_C values for Toilet/Water Closet (BT) at different R values of: toilet height (BT_h), toilet grab-bar configuration (BT_{gc}), toilet grab-bar diameter and surface texture (BT_{gd}), toilet grab-bar height (BT_{gh}), toilet supporting equipment and accessories (BT_s), toilet block schema (BT_b), and toilet dimensions (BT_d). The red lines are to represent the scatter band of the plotted data points for minimal N_C	100

Figure 4.15. Scatter-band/plotting-range of N_C values for Toilet/Water Closet (BT). The red lines represent the scatter band of the plotted data points for minimal N_C . The vertical dotted line is the boundary of R..... 101

Figure 4.16. Scatter-band/plotting-range of N_C values for lavatory (BS) and flooring (BF)..... 102

Figure 4.17. Scatter-band/plotting-range of N_C values for bathtub design (BB). The red lines represent the scatter band of the plotted data points for minimal N_C . The vertical dotted line is the boundary of R..... 102

Figure 4.18. Scatter-band/plotting-range of N_C values for bathtub lighting (BL). The red lines represent the scatter band of the plotted data points for minimal N_C . The vertical dotted line is the boundary of R..... 103

Figure 4.19. (A) Perspective of the proposed case study bathroom design. (B) Floor plan for the proposed case study. 106

Figure 4.20. Block schema-related assessment. Toilet, bathtub, lavatory, and door block schema are clear from any interference. 110

Figure 4.21. (A) Perspective of the improved case study of bathroom design. (B) Floor plan for the improved case study..... 116

Figure 4.22. Floor plan for case study number 1. 125

Figure 4.23. (A) Floor plan shows the night light for case study number 1; 128

Figure 4.24. (A) Floor plan for case study number 2; (B) floor plan shows the lighting fixture for case study number 2 129

CHAPTER 1: INTRODUCTION

1.1 Research Motivation

As the so-called “baby boomer” generation approaches retirement, the current built-environment design paradigm is shifting toward elderly-friendly design. The older adult population (aged 65 and over) currently accounts for approximately 15% of Canada’s total population, and that proportion is projected to increase to approximately 23% by 2031 (HRSDC 2011). Although healthcare facilities play an important role in satisfying the accommodation requirements of older adults, 93% of older adults prefer to reside in their own homes rather than move to continuing care retirement communities, assisted living facilities, or other personal care facilities (Turcotte 2007). On the other hand, as people age, the risk of falling increases; at least 33% of older adults (65 years and over) experience falls annually while living independently in their homes (Donald and Bulpitt 1999; Kannus et al. 1999; Scott et al. 2005). This increased risk underscores the need for safe, aging-friendly environments (Edwards and Mawani 2006).

A set of information needs to be uploaded to each design object to achieve more efficient building information modelling (BIM) to serve purpose of creating aging-friendly environments. Interdisciplinary collaboration must be achieved between

gerontological and architectural research as the first step toward creating elderly-friendly design that enhances safety for older adults (Afifi et al. 2014). Developing this interdisciplinary collaboration will help to define the gap between users' requirements—in this case, older adults—and the architectural specifications that satisfy those requirements. This interdisciplinary collaboration requires reliable methods by which to integrate evidence-based research in order to form a framework for elderly-friendly architectural design, which is associated with the minimum risk of falling.

Home bathrooms have been found to be one of the most common fall areas for older adults (Devito et al. 1988; Nevitt et al. 1989). Studies have reported increased difficulty in performing Activities of Daily Living (ADL) in the home bathroom area as a person ages, such as sitting to standing from the toilet, and entering and exiting the bathtub (Sanford et al. 1995; Aminzadeh et al. 2000; Sveistrup et al. 2006; Buchman et al. 2014). Preceding studies have investigated bathroom design adjustments as part of home design assessment in order to reduce the possibility of falls for older adults (Hornbrook et al. 1994; Tinetti et al. 1994; Carter et al. 1997; Cumming et al. 1999; Gill et al. 1999; Stevens et al. 2001; Day et al. 2002; Morgan et al. 2005). Other studies have also identified the required bathroom design alterations that may reduce the risk of falling (Sanford et al. 1995; Clemson and Martin 1996; Murphy et al. 2006; Sveistrup et al. 2006; Capezuti et al. 2008).

1.2 Research Objectives

The objective of this research is to develop an integrated evidence-based assessment system to quantitatively evaluate the architectural residential dwelling design from the perspective of reducing the risk of falling to support geriatric design. This developed qualitative/quantitative assessment will facilitate the integration with BIM to promote safe design for older adults. In order to achieve the objective of the research, the following approach is taken:

- 1) ***Establish integrated evidence-based literature that combines various related aspects of architectural design.*** In this stage, a systematic review is conducted to ensure that various evidence-based relevant literature is reviewed. In order to conduct a systematic review, a focused research question and research scope are identified, in addition to a wide range of relevant data to ensure that all evidence-based studies in relation to the risk of falling for older adults have been considered.

- 2) ***Develop an analytical approach to investigate the collected evidence-based studies.*** In this stage, analysis of the collected data is carried out through the divide and conquer algorithm (DCA); this conceptual approach is utilized in order to break down the design problem into a number of smaller sub-components. These sub-components are then individually solved, with the combined results expected to solve the original problem (Messinger et al. 1991; Cormen et al. 2003; Skiena 2008). For example, by

applying the DCA to bathroom design, the bathroom is divided into a number of smaller sub-component “elements”: toilet (BT), bathtub (BB), lavatory or sink (BS), flooring (BF), and lighting (BL); each of these elements is in turn divided into a number of “features” that define its architectural specifications. For instance, the toilet design element is divided into seven features: (1) toilet height (BT_h); (2) toilet grab-bar configuration (BT_{gc}); (3) toilet grab-bar diameter and surface texture (BT_{gd}); (4) toilet grab-bar height (BT_{gh}); (5) toilet block schema (BT_b); (6) toilet supporting equipment accessibility (BT_s); and (7) toilet dimensions (BT_d). Each feature is then divided into a number of scenarios representing different architectural design alternatives for that feature. Additionally, in this stage, a new concept of Block Schema (BS) is developed based on anthropometric considerations in order to provide a graphical representation of the minimum surrounding free-zone associated with each design element.

3) *Develop scaling and quantitative rating system for DCA outcomes.* In this stage, from the DCA outcome, ordinal scaling is developed for the scenarios of different features. In order to incorporate the developed ordinal scaling into a mathematical model, equal interval scaling is adopted to provide quantitative values for the ordinal-scaled scenarios. Equal intervals are adopted, since it has not yet been established quantitatively in the scholarship the extent to which various design scenarios might reduce the risk of falling (Pynoos et al. 2006).

- 4) *Develop mathematical assessment model.* In this stage, an assessment algorithm is developed in order to reach a mathematical model that quantitatively assesses the risk of falling for older adults. The mathematical model is constructed through a set of equations that will deliver a rating number that reflects the risk of falling associated with the design. A generalized assessment mathematical model is developed to utilize a general implementation of the model. A set of assessment tables is generated in order to qualitatively evaluate the numerical output of the mathematical assessment model. These tables are built using both equal interval and ordinal scaling systems.
- 5) *Characterization of the proposed assessment model.* In this stage, ranges and limits of the assessment model output are characterized for each element using graphical representation. A set of generalized equations are then developed based on the graphical representations in order to identify the assessment model's limits for each design element. The proposed approach is applied for home bathroom design to assess the associated risk of falling for older adults.

1.3 Thesis Organization

This thesis consists of five chapters. Chapter 1 defines the research motivation and objectives, and outlines the thesis organization. Chapter 2 provides background on geriatric design and home design in relation to falls with older adults being discussed as the central focus of the design. This chapter consists of three sections:

(1) background on challenges, opportunities, and implications for home design for older adults; (2) background on falling for older adults within the home environment with a focus on bathroom design falls; (1) background on older adults/geriatric catered design; (2) background on geriatric bathroom design; (3) background on falling for older adults within the home environment with a focus on bathroom design falls; (4) background on the systematic review analysis; (5) background on the focus group discussion; and (6) background on geriatric centered design. Chapter 3 outlines the research methodology used to achieve the research goal through each of the objective areas. Chapter 4 develops and implements an integrated framework, followed by case studies and analysis. Chapter 5 summarizes the research, proposes the research contribution, and also recommends future areas of research.

CHAPTER 2: LITERATURE REVIEW

2.1 Introduction

This literature review provides a background on geriatric home design that addresses home architectural design to identify an integrated evidence-based design framework that may reduce the risk of falling for older adults. This chapter consists of the following subjects: (1) background on geriatric home design, which encompasses home challenges and opportunities for older adults; (2) background on bathroom design, which provides a background on bathroom history, bathroom trends, and bathroom design requirements for older adults; (3) background on falls for older adults, which addresses consequences, causes, and prevention of falls for older adults; (4) systematic review, which discusses an evidence-based research tool; (5) focus group discussion, which discusses a research method to gather expert judgments; (6) background on geriatric centred design (GCD), which discusses the conceptual approach of user-centred design with older adults being the centre of the proposed architectural design.

2.2 Background on Geriatric Home Design

A poorly designed home environment may have a detrimental effect on the risk of falling for older adults (Hornbrook et al. 1994; Carter et al. 1997; Tinetti 2003; Pynoos et al. 2006). Home falls are a common hazard with serious consequences for older adults aged 65 years and over. Among older adults who have experienced falls, about 10% have sustained serious injuries, such as severe head injury or hip

fracture (Tinetti et al. 1988; Nevitt et al. 1989; O'Loughlin et al. 1993; Tinetti et al. 1995). Falls have also been associated with a loss of confidence, activity restriction, functional decline, social withdrawal, and developing a fear of falling (Nevitt et al. 1991; O'Loughlin et al. 1993; Vellas et al. 1997; Tinetti and Williams 1998; Rogers et al. 2004; Kannus et al. 2005; Haslam and Stubbs 2006). The negative impact of falls is put into perspective when one considers that most fall-related injuries in the older adult population result in death (Kannus et al. 1999; Rogers et al. 2004). Causes of falls for older adults are often multifactorial, including physical and/or psychological impairment specific to the individual and/or poor architectural design of the living environment (Tinetti 2003; Rogers et al. 2004).

Randomized control trial studies for older adults have reported that a minimum of 25% of falls occur in the home environment (DeVito et al. 1988; Nevitt et al. 1989; Lord et al. 1993; Stevens et al. 2001). At least one out of three older adults living independently are subjected to home falls at least once a year (Donald and Bulpitt 1999; Kannus et al. 1999; Gillespie et al. 2003; Scott et al. 2005; Elliott et al. 2009). Although some older adults experience significant health deterioration as they age, others maintain a healthy life (Byerts et al. 1982; Martel et al. 2005). Therefore, challenges for older adults vary depending number of factors, such as, older adults' lifestyle, and physical and mental health level. Due to these various challenges, older adults risk of falling may rise up making it challenging to maintain a safe and independent lifestyle (Rogers et al. 2004). These challenges support the need for a design environment with a geriatric-focus. In the context of this research, *geriatric*

home design is defined as design that ensures safe and comfortable spaces for older adults, aged 65 years and over, so they can live independently in their homes.

Home architectural design improvements or home modifications have been recommended as fall prevention strategies to promote safety for older adults (Stevens et al. 2001; Lord et al. 2007). Cumming et al. (1999) have demonstrated positive results when home modifications are implemented by professionals. Stevens et al. (2001) have also reported a fall reduction as a result of home modification; however, it is yet to be determined the extent to which each of these home modifications may reduce the risk of falling (Pynoos et al. 2006). On the other hand, a study by Bayer (2000) to indicate the level of satisfaction of older adults with their home modification concluded that approximately 20% of older adults believed that the aesthetic of their home did not improve (Bayer 2000). Older adults felt uncomfortable with rearranging furniture, or adding new design objects to modify the original space (Lord et al. 2001). Geriatric home design is thus implemented to respect the original home style when modifying home design for older adults.

Alternatives for geriatric home design include home modification and universal home design. Home modification—redesigning the existing home in order to improve home functionality—is one of the common home alternatives for aging residents, as it supports the idea of independent living for older adults (Kim et al. 2014). Additionally, home modification has been proposed as a means to maintain safety in the home for older adults (Bakker 1999; Bayer 2000). Smart design

features emerged through the evolving technology as modifications to existing or new homes in the form of sensors to control lighting, temperature, or door openings that can be easily installed as required (Warren et al. 1999; Demiris et al. 2004). Another alternative for older adults is universal home design, which is also known as lifetime home design, or flexible homes (DCLG 2008).

Universal home design falls under the category of building to future demand, which is to accommodate older adult needs as they grow older (Ostroff and Preiser 2001). In other words, the initial home design allows for extra and adjustable space to meet future demand for an aging population. For instance, as illustrated in Figure 2.1, building non-structural walls between the bedroom and bathroom to allow for modifications such as an accessible entrance, or reserving extra space for an elevator shaft if one should be required (Barlow and Venables 2004; DCLG 2008). Although universal design is a relevant concept for new home design which is built to accommodate the needs of aging generations, it is argued that universal design lacks a cohesive systematic approach for older adults design (Ostroff and Preiser 2001; DCLG 2008).

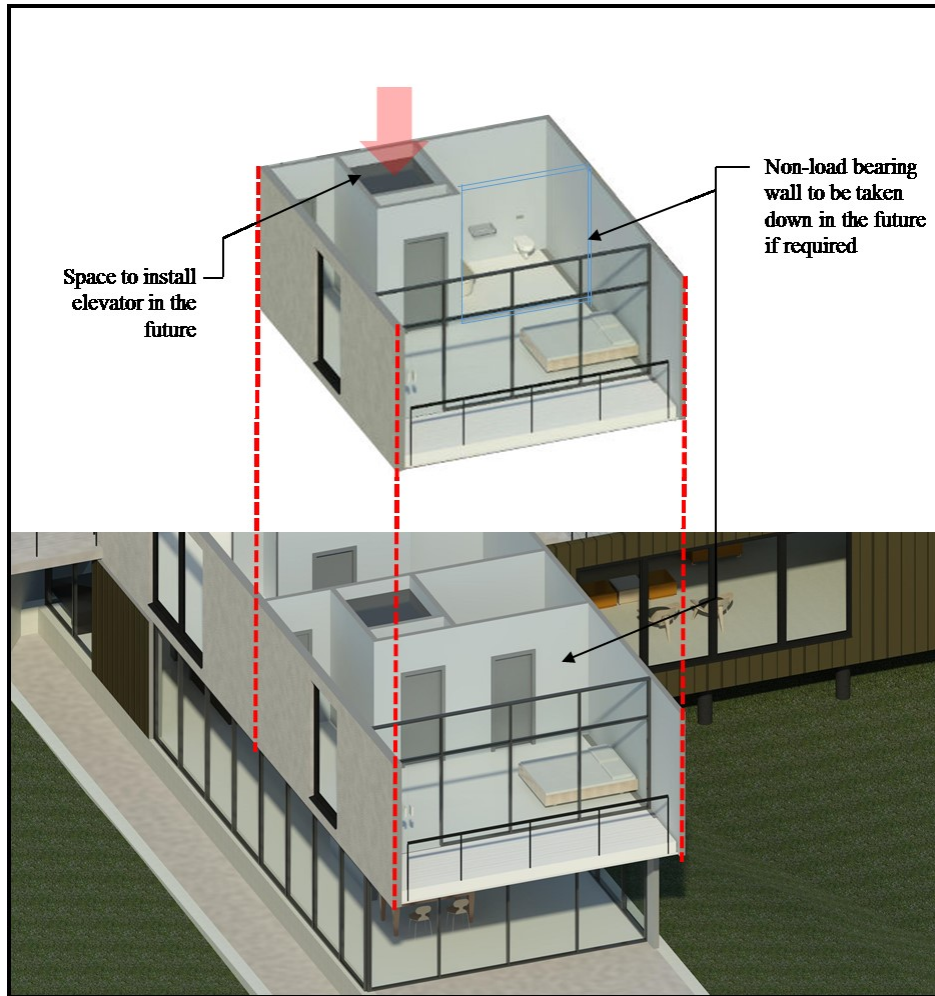

Figure 2.1. Adding extra space and adjusting wall structure for future extension

2.3 Bathroom Design

Modern day bathroom design space is the result of many changes and developments over time. Evidence shows that ancient Egyptians and residents of Crete, Greece's largest island, had in-home bathing spaces; the early “bath room” was used mainly for bathing (Parrott et al. 2013). In the early 1900s, family-style bathrooms

appeared with three standard fixtures: the pedestal lavatory, the water closet, and the claw-foot bathtub (Parrott et al. 2013). By the mid-1900s, various materials had been introduced such as fiberglass for bathtubs, and stainless steel for lavatory and countertops (Lupton and Miller 1996). By the end of the 1900s, bathrooms had become more spacious with themed faucet, bathtub, and lavatory designs (Parrott et al. 2013). Currently, universal design is affecting various bathroom designs, materials, and styles. Also, some furniture and additional spaces such as cabinets and closets have been added to the bathroom space (see Figure 2.2).

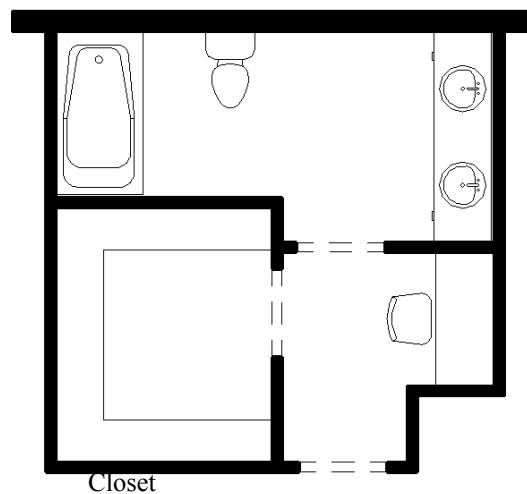

Figure 2.2. Bathroom cabinet and closet included in the bathroom

Bathroom design trends vary depending on the type of space available: (1) open spaces: previous bathroom designs have been minimal in size; however, consumers prefer spacious bathrooms that provide a sense of open space. This sense of open space in the bathroom can be achieved by increasing the size of the bathroom space, and higher ceilings; (2) outdoor access: as a new trend of being connected with

nature that **has** emerged lately as consumers preferred outdoor feeling that can be reflected through sunlight and lighting. The outdoor connection is usually implemented in the bathtub area through the use of larger windows for natural light; however, the water closet is included as private space with an access to the bathtub, as illustrated in Figure 2.3; (3) suites: combining the bathroom and the bedroom has become a popular idea to create a bathroom ensuite; and (4) two users bathroom: the bathroom may be designed for two users, including two lavatories for more functional space for individuals (West and Emmitt 2004; Parrott et al. 2013).

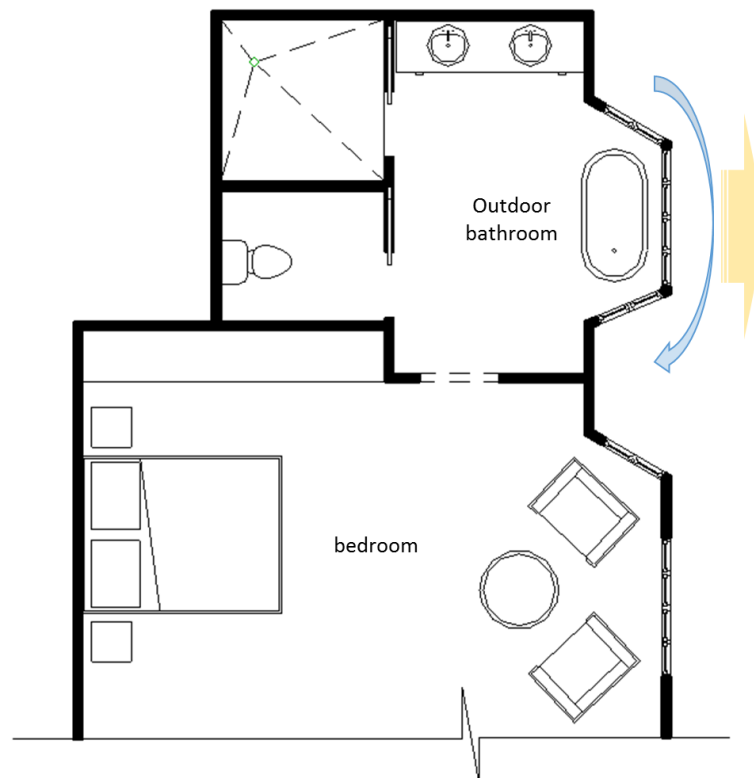

Figure 2.3. The concept of outdoor bathroom gives the bathtub panoramic natural view

2.3.1 Geriatric Bathroom design

Sit-to-Stand (STS) transfer is a locomotor activity that involves a shift in the center of mass and may increase the risk of falling for older adults (Tinetti et al. 1986; Campbell et al. 1989; Nevitt et al. 1989). For older adults aged 85 years and over, 50% have been found to lack the ability to perform a sit-to-stand transfer from the toilet (Clarke et al. 1984). The toilet height needs to be adjusted in relation to the individual's Lower Leg Length (LLL) in order to facilitate the toilet sit-to-stand motion (Capezuti et al. 2008). This increase in toilet height is often achieved by adding a toilet seat as an assistive device, which is a common assistive device (Dahlin Ivanoff and Sonn 2005). Another commonly used assistive device to assist older adults in performing toilet sit-to-stand transfers is a toilet grab-bar (Sanford et al. 1995; O'Meara and Smith 2005). Sanford et al. (1995) have found that the optimal combination for independent and safe toilet sit-to-stand transfer is the following specifications: (a) diagonal grab-bar: 1,220 mm length, 45° angle, and 500 mm distance from the end of the toilet; and (b) horizontal grab-bar: 500 mm length, and 300 mm distance from the end of the toilet.

A grab-bar surface texture that is too smooth or too rough may lead to a fall, as the grasping hand movement under the body weight may result in losing balance and consequently falling (Maki 1988; Templer 1992; Haslam and Stubbs 2006). Additionally, in order to facilitate the toilet grab-bar graspability, a circular handrail cross-section with a circumference between 100 mm and 160 mm (32 mm to 51 mm in diameter) is recommended (Maki 1988). According to the evidence-based

studies reviewed, entering or exiting the bathtub and sitting in or getting up from the bathtub are identified as difficult tasks for older adults (Edwards et al. 2003; Sveistrup et al. 2006). Sveistrup et al. (2006) have investigated different grab-bar configurations that facilitate older adults getting into and out of the bathtub, and sitting in and getting up from the bathtub. The study shows the optimal vertical and horizontal grab-bar configurations to support older adults' movement in relation to the bathtub.

Murphy et al. (2006) identifies the bathtub seat as an unsafe feature for older adults and a hazard that should be eliminated. Clemson and Martin (1996) have found bath mats to be commonly installed devices that reduce the possibility of falls for older adults. Adding a night-light feature has been found to improve postural stability, which is the ability to maintain one's body balance within the surrounding environment (Figueiro et al. 2008). The bathroom floor has also been considered as part of the home environment hazard assessment (Carter et al. 1997; Cumming et al. 1999; Stevens et al. 2001; Tinetti 2003; Lord et al. 2007). The bathroom floor may contribute to the increased risk of falling for older adults if the floor surface is slippery and/or if attached bath mats are loose or not secured to the floor (Stevens et al. 2001). Slippery floor surface can result from a non-slip resistant flooring that might be contaminated by water, cleaning material, or any other material that may affect the floor slip resistance (Pilla 2003).

2.4 Background on Falling for Older Adults

Tinetti et al. (1988) identified falls as “a sudden, unintentional change in position causing an individual to land at a lower level, on an object, the floor, or the ground, other than as a consequence of sudden onset of paralysis, epileptic seizure, or overwhelming external force.” Falls occur in various areas, both inside and outside the home environment (Mackenzie et al. 2002). In regard to the indoor home environment, evidence shows that bathrooms are associated with the highest level of common fall hazards for older adults (DeVito et al. 1988; Carter et al. 1997; Gill et al. 1999; Leclerc et al. 2010). Past studies have investigated the bathroom as part of the home hazardous environment (Carter et al. 1997; Cumming et al. 1999; Gill et al. 1999; Stevens et al. 2001; Morgan et al. 2005). Other studies have recommended bathroom modifications involving adding, eliminating, or adjusting the existing design, such as adding bath grab-bars, eliminating loose bathroom floor mats, and adjusting the bathroom task lighting (Sanford et al. 1995; Clemson and Martin 1996; O’Meara and Smith 2006; Sveistrup et al. 2006; Figueiro et al. 2008; Kinoshita 2012).

Physical impairment such as vision impairment, and psychological impairment such as the fear of falling (FOF), have been found to be participating factors in the risk of falling, the probability of falling, for older adults (Vellas et al. 1997; Rogers et al. 2004; Haslam and Stubbs 2006). Lord et al. (2001) acknowledged the risk of falling as the probability of falling for older adults. A study by Oh-Park et al. (2011) investigated the fear of falling for 380 older adult participants, and identified a

positive correlation between the risk factors and the number of older adults had fear of falling. Oh-Park et al. (2011) also concluded that in-depth investigation and understanding of risk factors in relation to fear of falling for the group of older adults is required (Oh-Park et al. 2011). According to Statistics Canada, falls are the leading cause of shoulder and knee injury that results in hospitalization for older adults (PHAC 2014). As illustrated in Figure 2.4, 17% of fall-related injuries for older adults are in the shoulder or upper arm, followed by 15% of fall-related injuries in the knee and lower leg. Ankle and foot injuries have been cited third at 10%. Also, 7% of fall-related injuries have been found to result in head injuries such as injuries to facial bones.

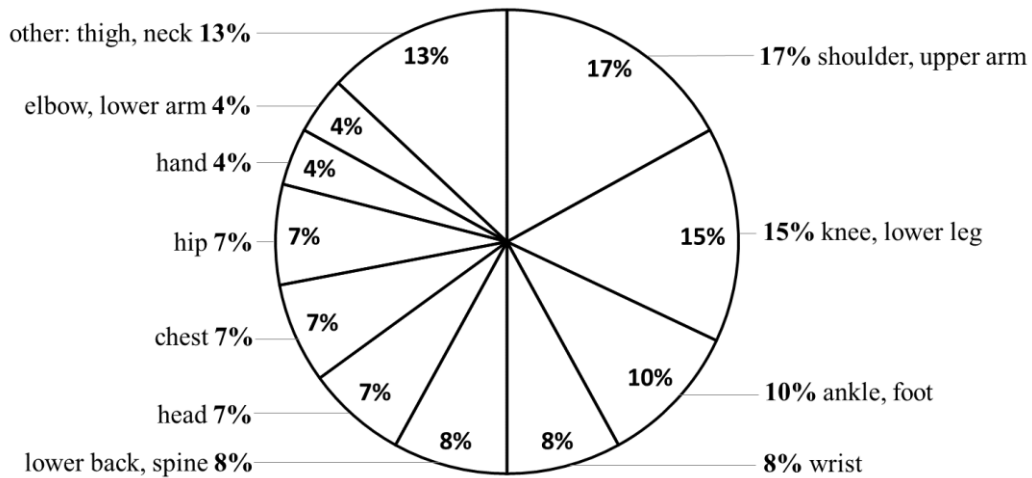

Figure 2.4. Body parts affected by fall-related injuries for older adults, aged 65 years and over (PHAC 2014)

2.5 Systematic Review

A systematic review is a research tool by which to review the available literature in a specific area by answering a focused research question (Grant and Booth 2009). The systematic review analysis ensures wide-ranging evidenced-based research on various data-bases, such as PubMed, CINAHL, MEDLINE, Abstracts in Social Gerontology, and Google Scholar. A focused research question is the first step in the systematic review analysis (Cronin et al. 2008). The scope of research is then identified based on the suggested focused question. Relevant data-bases in relation to the research question and scope are then secured for accessing. Systematic approach search within the selected data-bases is applied to ensure that relevant scholars are selected. A systematic review analysis is considered to be a strong tool to support evidence-based practice (Arksey and O'Malley 2005). In the systematic review analysis, various studies are examined and selected based on the research question and scope.

Previous studies have applied a systematic literature review as a fall prevention strategy for older adults. Chang et al. (2004) developed a systematic review for the prevention of falls for older adults. In this study, only randomized control trials were identified based on searching the databased of Medline, HealthSTAR, Embase, the Cochrane Library, and other health related data bases (Chang et al. 2004). Their study concluded that interventions to reduce the risk of falling for older adults are an effective method. Another systematic review that has been developed as a fall prevention strategy was presented by Van Haastregt et al. (2000) to

investigate the effect of preventive interventions to older adults in their homes. The aim of this study was to educate older adults about functional, psychological, and environmental aspects as a fall prevention strategy. Based on their study, which included 15 randomized control trials, no evidence was found to support the effectiveness of interventions to older adults in their homes as a fall prevention strategy.

2.6 Focus Group Discussion

A focus group is a tool used to collect expert opinions from an identifiable group based on a group interview technique (Kitzinger 1995). Krueger and Casey (1994) have described a focus group as a “carefully planned discussion designed to obtain perceptions on a defined area of interest in a permissive, non-threatening environment”. Focus groups combine the advantage of interviewing and participant observation by obtaining detailed information about the group personal responses, perceptions and opinions (Sinagub et al. 1996; Massey 2011). The focus group technique can be utilized as both a qualitative and a quantitative evaluation technique (Morgan 1997; Massey 2011). Focus groups have also been identified as an effective tool by which to obtain a varied range of information, given that the focus group technique is usually used to gather information similar to a one-to-one review but with the advantage that this information is collected within a group of experts, thereby allowing further explanations and discussions within the expert group of people (Morgan 1997; Armstrong and Massey 2002).

Greenbaum (1998) has identified three types of focus group techniques: (1) full group, (2) mini-group, and (3) telephone group (Greenbaum 1998). Full focus group discussion consists of an approximately 90- to 120-minute discussion that involves eight to ten people who are selected based on common attitudes and facilitated by a moderator. Each mini-group involves four to six people for approximately 60 minutes managed by a moderator, which is the most common as small groups of experts are recommended to insure that all members can effectively participate and researchers can gain in-depth information (Morgan 1997; Greenbaum 1998; Armstrong and Massey 2002; Awad 2009). A telephone group consists of participants that are selected for a telephone conference call led by a moderator for a minimum of 30 minutes and a maximum of two hours (Greenbaum 1998).

Systematic steps are followed to develop and manage the focus group; the development of the materials that will be discussed in the focus group may include a series of questions, or developed cases for discussion, followed by the selection of the group of experts to be included in the subject matter (Krueger and Casey 2009). The protocol to manage a focus group discussion is a systematic strategy that discusses each question and case study as follows: (1) introduction: the focus group discussion begins with a welcome introduction by the mediator followed by a brief introduction about the importance of the research and the importance of the participants' opinions as experts; (2) explain the process: the mediator explains the focus group objective and methodology and provides the material to be evaluated;

(3) systematically discuss each point: the mediator discusses each point with the experts and receive their feedback and expression, open ended questions are included to facilitate any clarification. The mediator then concludes the meeting and thanks everyone for participating (Krueger and Casey 2009). Data collected based on the focus group is then analyzed and included in the research process.

Previous studies have implemented a focus group discussion with a selected group of users, professionals, and industrial groups in order to gather information. Dillon and Barclay (1997) study have implemented the focus group discussion as an assessment technique of the proposed case study of student groups in a school environment. Also, the study concluded that the focus group is a useful assessment method for several programs as the focus group provides insights that are not available through other techniques (Dillon and Barclay 1997). The focus group technique has also been used in the industry to investigate the impact of information systems on the skills and knowledge of different stakeholders groups (Lee et al. 1995). A focus group consisting of five people has been implemented as an expert system technique that has been integrated with the fuzzy logic technique to help professionals to provide evaluation tools for contactors and project prequalification (Awad 2009). Given that construction can be considered an uncertain and risk environment, the focus group technique is selected to evaluate qualitative and quantitative conditions that comprise uncertainty and subjective judgment (Awad 2009).

2.7 Background on Geriatric Centered Design (GCD)

Geriatric-Centered Design (GCD) is an approach that is derived from the human-centered design to meet the need of the specific group of older adults and enable them to better function within a given space. Lawton and Nahemow (1973) have presented a framework to model the reciprocal relationship between users (in this case, older adults) and the environment (Lawton and Nahemow 1973). In the 1980s, the term universal design or life span design was used to refer to an approach to designing the built environment to function for different ages and abilities. Norman and Draper (1986) first introduced this user-centric design as a new practice through human computer integration (Norman and Draper 1986).

Human-centric design has been acknowledged by the International Organization for Standardization (ISO) 13407 (1999) standards as a process for system development. Human-centered design, in its most recent definition, includes optimizing the physical design of the surrounding environment in order to meet the needs and abilities of users. In 2012, three major design paradigms were identified by Giacomini (2012): (1) technology-driven design that focuses on technology implementation; (2) sustainability-driven design that focuses on human ecological footprint and impact on the surrounding environment; and (3) human-centered design that focuses on satisfying human needs (Giacomini 2012). This research falls under the third paradigm of human-centred design to support the specific group of older adults, which is represented as geriatric-centred design. The geriatric-centered design concept is proposed through an evidence-based analysis that is implemented

on bathroom design from the perspective of reducing the risk of falling for older adults.

CHAPTER 3: PROPOSED METHODOLOGY

3.1 Introduction

The purpose of this research is to develop a framework and an evidence-based assessment system by which to quantitatively evaluate the architectural design of bathroom design in order to decrease the risk of falling for older adults. This chapter describes the research methodology that facilitates the proposed objective, and discusses the following aspects: the systematic review approach, the developed algorithm for objective implementation of the DCA, the developed design supporting tools to facilitate the implementation of the assessment system, and the developed mathematical rating system to quantitatively represent the architectural design.

The developed framework is implemented to provide an integrated evidence-based assessment system for bathroom design with the aspect of reducing the risk of falling for older adults. Figure 3.1 illustrates the research methodology for the bathroom design. The methodology is divided into five stages as follows: systematic review of bathroom design with regard to falls for older adults; DCA approach to construct the bathroom elements and features analysis; scaling and rating system for the developed DCA outcome; mathematical assessment model for bathroom design; and characterization of the proposed assessment model.

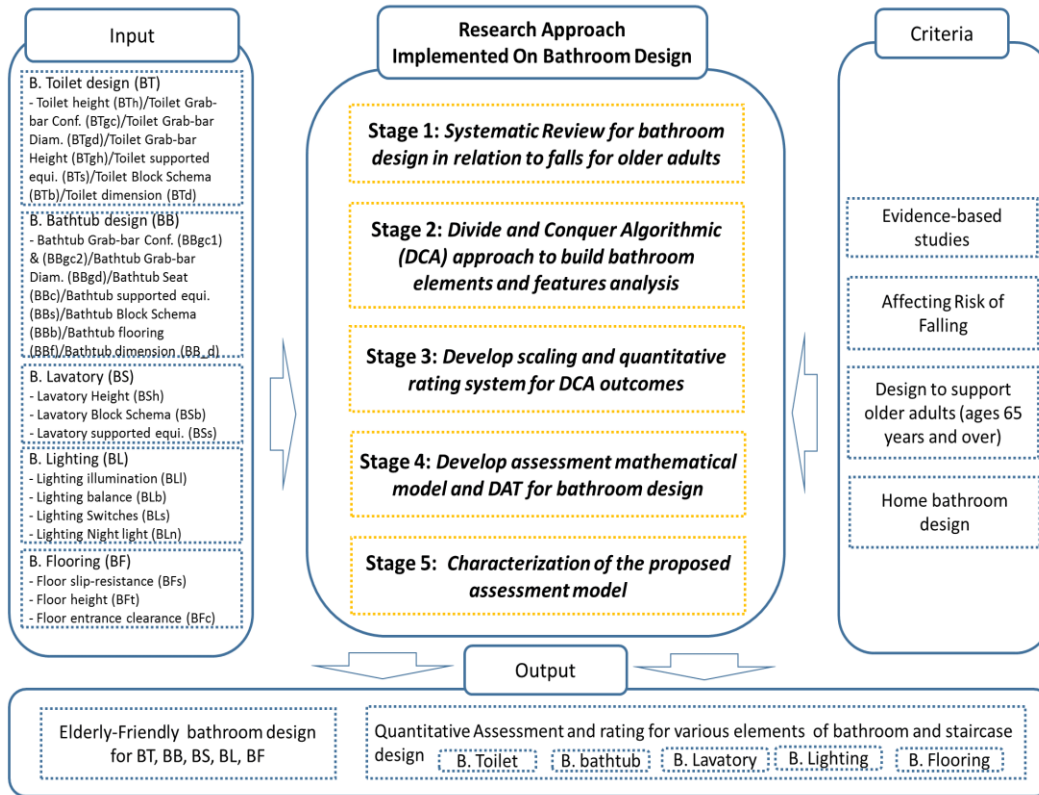

Figure 3.1. Proposed research approach for bathroom architectural design assessment.

3.2 Systematic Review Approach

A systematic literature review was adopted in this research in order to ensure a comprehensive search of various databases to build an integrated evidence-based assessment that accounts for all evidence-based studies in the area of bathroom design in relation to the risk of falling for older adults. The research question for the bathroom design is articulated as follows: “What are the bathroom architectural design specifications that might affect the risk of falling for older adults?”

The scope of this systematic review is defined by three criteria: (1) the age of the population group of older adults (65 years of age and over); (2) home bathroom design; and (3) evidence-based studies related to falling for older adults. Selected evidence-based studies comprise experimental studies, randomized control trials, and quasi-experimental studies, non-experimental descriptive studies all in relation to bathroom architectural design specifications that might affect the risk of falling for older adults. A wide range of research databases are accessed to ensure that a comprehensive literature of all relevant research was undertaken. These databases include: MEDLINE; PubMed; CINAHL; Abstracts in Social Gerontology; Google Scholar; The Cochrane Library; University of Alberta Library; and University of Calgary Library.

Potential relevant studies were identified based on the predefined search terms, which were systematically entered to each of the selected databases using: (1) person terms, (2) activity terms, and (3) architectural design terms. (1) Person search terms were implemented as follows: older adult, senior, age, aging, elderly, and older people. (2) Activity search terms were fall, bath, toilet, and wash. (3) Architectural design search terms were bathroom or washroom, toilet, bathtub, lavatory or sink, floor, and lighting. Basic search criteria were developed to ensure that only the relevant studies were selected; for instance, only those articles that are peer reviewed, were chosen. Figure 3.2 illustrates the systematic review process for bathroom design. Studies that do not meet the search criteria were excluded. The remaining studies were screened according to whether or not they are evidence-

based studies relevant to the research. In addition, papers from reference lists, conference proceedings, and manual searches of journals were also considered if relevant to the research.

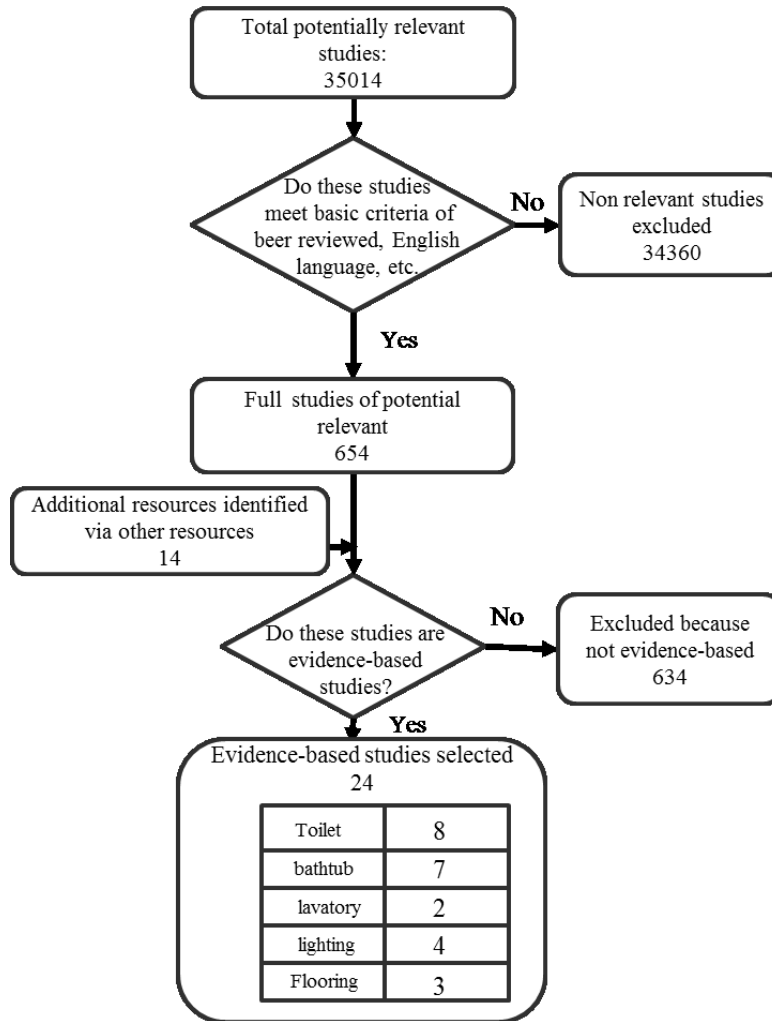

Figure 3.2. Flowchart representing the systematic review process for bathroom design assessment.

3.3 Divide and Conquer Algorithm (DCA)

Bathroom design assessment is implemented based on the conceptual approach of the divide and conquer algorithm (DCA). A typical DCA conceptual analysis dissects the design problem into a number of smaller sub-component that are then individually solved. The combination of the analyses of all these sub-components is expected to lead to a solution to the original problem (Messinger et al. 1991; Cormen et al. 2003; Skiena 2008). The DCA approach can be implemented through the following steps: (1) the design problem is divided into smaller levels of sub-components, represented through the construction of recursion analyses, as illustrated in Figure 3.3; (2) each of the root sub-components is conquered on an individual basis within the design paradigm theme; and (3) the root sub-components are combined to represent a solution to the original problem based on implementation of DCA principles (Cormen et al. 2003; Skiena 2008).

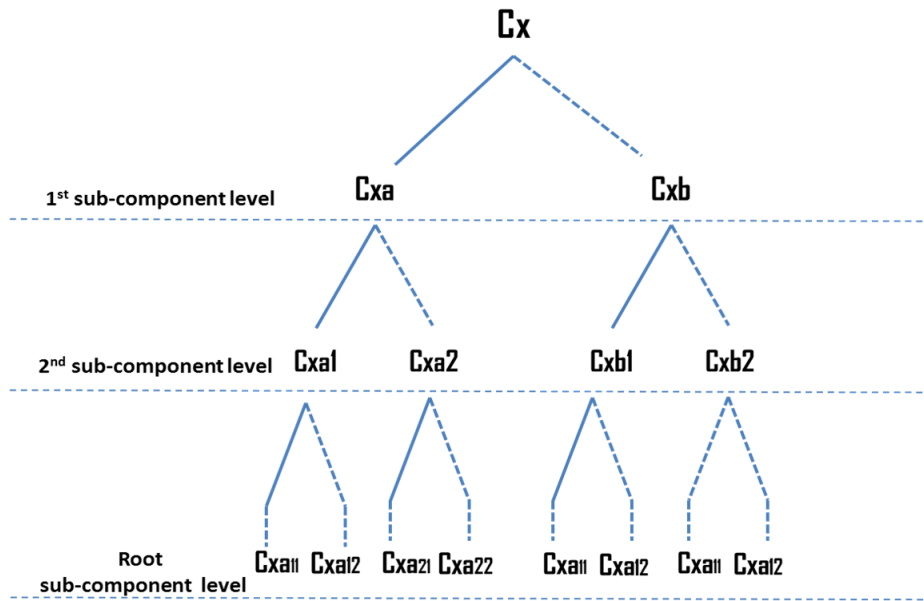

Figure 3.3. Flowchart representing the construction of recursion analysis for DCA.

In order to build an evidence-based assessment of bathroom architectural design specifications with the aim of reducing the risk of falling for older adults, the bathroom is divided into a number of first level sub-components. These sub-components represent the fundamental architectural design of the bathroom as an interior space, which have been evidenced that they may have an effect on the risk of falling for older adults (Sanford et al. 1995; Clemson and Martin 1996; Carter et al. 1997; Cumming et al. 1999; Gill et al. 1999; Stevens et al. 2001; Day et al. 2002; Figueiro et al. 2008). These first level sub-components, described in this research as bathroom design elements, comprise the following: (1) toilet, (2) bathtub, (3) lavatory, (4) lighting, and (5) floor.

Each design element is then divided into a second level of sub-components that represent the detailed architectural design specifications of each element. For example, the toilet design element is divided into toilet height, toilet dimensions, toilet block schema, toilet grab-bar height, toilet grab-bar diameter and surface texture, toilet grab-bar configuration, and toilet supporting equipment accessibility, which have been evidenced that they may affect the risk of falling for older adults (Panero and Zelnik 1979; Sanford et al. 1995; Gill et al. 1999; Dahlin Ivanoff and Sonn 2005; Talbot et al. 2005; Sveistrup et al. 2006; Kinoshita 2012). These detailed architectural design specifications of the element (second level sub-components) are referred to in this research as design features.

The design features are divided into a number of scenarios forming the root level of the bathroom recursion analysis, as illustrated in Figure 3.4. The root sub-components have been conquered on an individual basis by investigating the risk of falling associated with the proposed design scenarios for each design feature in order to support the elderly-friendly design theme. For example, the toilet grab-bar height design feature is divided into a number of design scenarios that are assessed from the perspective of reducing the risk of falling for older adults. The combination of various root sub-components represents the overall bathroom architectural design specifications.

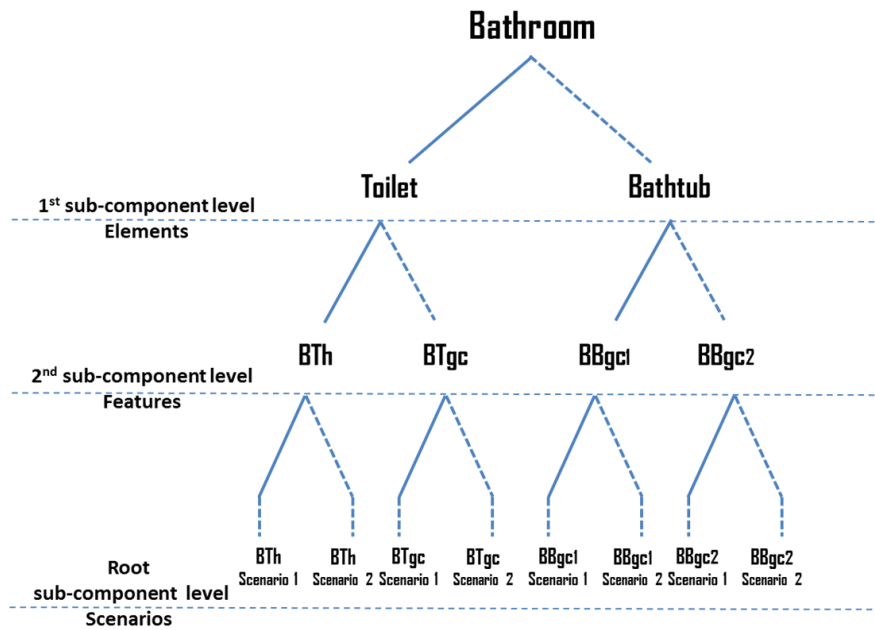

Figure 3.4. Flowchart representing partial DCA for bathroom design.

The DCA for bathroom design is expected to significantly contribute to the current elderly-friendly design paradigm, as each design scenario is loaded with its associated quantitative factor representing the degree of risk of falling for older adults. With a complete vision of the assessment of various design scenarios, choosing the optimal scenario associated with the greatest falling risk reduction will contribute to elderly-friendly design paradigm. In addition, this proposed DCA for bathroom design will enable the designer to assess any other proposed bathroom design scenario selected for an obligatory reason such as space limitations. Moreover, this technique will facilitate designers' assessments of obligatory or existing designs compared to the optimal design.

3.4 The Concept of Block Schema Feature

Space design has no limitations in terms of innovation and new creative ideas. The bathroom space can thus be formulated with an almost unlimited numbers of designs in terms of space formation and bathroom element arrangements (see Figure 3.5). Since this research proposes an assessment that needs to be applicable to this almost limitless number of designs, the concept of “block schema” is introduced as a feature by which to assess each design element individually, in addition to assessing its relationship with other design elements. In this research, each design element that affects the confined bathroom space is encapsulated based on anthropometric considerations and referred to as a “block schema”; as anthropometry is the study of the human’s body dimensions while forming different kinds of movement within individual’s surrounding environment (Panero and Zelnik 1979; Parrott et al. 2013). For example, an individual needs to perform the task of sit-to-stand from a toilet, which requires an adequate free distance in front of the toilet and on each side to accommodate human body movements.

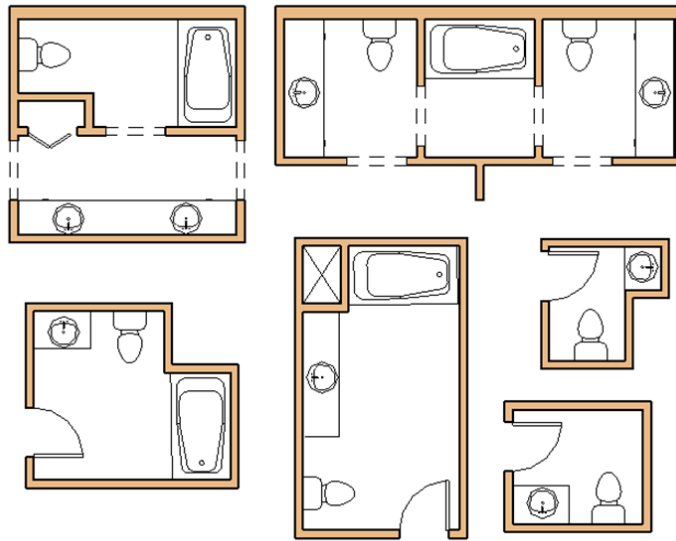

Figure 3.5. Various bathroom architectural design plans.

This toilet surrounding free zoning area is assigned based on an anthropometric study and is identified in the form of the toilet “block schema”. In other words, the concept of “block schema” represents the minimum free zoning area associated with each design element in which individuals can perform the associated task comfortably and safely. Additionally, the developed “block schema” for each element identifies the space relationship with other elements, as each block schema needs be clear of interference from any other block schema. Any element interference with another block schema will reduce the free-zoning area required by the anthropometric consideration, making it unsuitable for human use since the space will not be sufficient to perform the given task (Panero and Zelnik 1979; Parrott et al. 2013). This situation presents the potential hazard of bumping or tripping into the object, thereby increasing the risk of falling (Talbot et al. 2005). Figure 3.6A shows an example of a toilet block schema. The figure shows how the

toilet block schema interferes with another element resulted from unappropriated distance between bathroom equipment. This renders the bathroom unsuitable for human usage since the space created between the equipment is too small. Figure 3.6B shows a solution to the intersecting block schemas can be achieved by clearing interference for each design element.

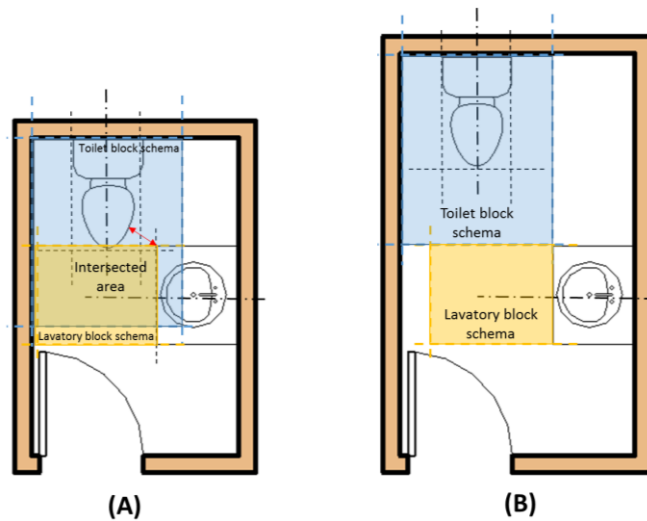

Figure 3.6. Examples of block schema interference: (A) toilet-lavatory block schema interference; (B) toilet-lavatory block schema clear of interference.

3.5 Scaling and Quantitative Rating System

Four scaling measurements are considered for the purpose of this research (Stevens 1946; Jackson 2011; Ware et al. 2013): nominal scale, ordinal scale, ratio scale, and equal interval scale. Nominal scaling and ordinal scaling identify items according to qualitative classifications (Stevens 1946; Ware et al. 2013), entailing that no logical or arithmetic operations can be conducted on nominal and ordinal scaling other than equal or not equal (Jackson 2011). On the other hand, ratio scaling is

represented by quantitative values that can relate ratios to one another (Jackson 2011), such as 2 meters is twice the length of 1 meter, or 2 hours is twice the time of 1 hour. The equal interval scale creates a quantitative relative degree of differences between items (Blaikie 2003), such as date and temperature. This scale encompasses the properties of identity (each value on the scale should have a distinctive meaning), magnitude (a certain hierarchy relationship exists among the values on the scale) and equal intervals (the values on the scale have scale units that are equal to one another) (Blaikie 2003; Jackson 2011). However, although both logical and arithmetic operations can be conducted on the interval scale, the ratio operation should not be applied (Jackson 2011), for example: it is not true that the heat associated with the temperature, 10°C, is “twice” the heat of 5°C. Moreover, in this research in order to build a scale measurement to assign quantitative value that represents the risk of falling for older adults, the concept of equal-interval scale is adopted; as yet to be determined is to what level each of various design scenarios might reduce the risk of falling (Pynoos et al. 2006).

3.5.1 Rating factor

Each bathroom design element is divided into a number of features. Each feature is then divided into a number of design scenarios that are arranged in a hierarchical list according to the degree to which each scenario reduces the risk of falling for older adults. A rating factor (R) is assigned to each design scenario to quantitatively represent the risk reduction calculated based on evidenced-based analysis of bathroom design features. A scenario of R that is equal to 1.00 represents the design

alternative associated with optimal risk reduction, while R that is equal to 0.0 represents the case of a non-existing design feature. An equal-interval scale has been applied to develop scaling interval values between the hierarchized design scenarios for each feature. Implementing the equal-interval scaling serves to generate scaled rating factors that represent the evidence-based hierarchical list of design scenarios. The Solver in Microsoft Excel was used to generate the rating factors associated with each design scenario in the scaled hierarchy, and these factors were rounded to the nearest hundredth.

CHAPTER 4: FRAMEWORK DEVELOPMENT AND IMPLEMENTATION

4.1 Introduction

This chapter details each of the proposed bathroom design elements based on the systematic review analysis, the DCA, and the developed rating system. A typical home bathroom contains three elements—toilet, bathtub, and lavatory (Aminzadeh et al. 2000; Parrott et al. 2013). These three elements, as well as lighting, are identified in the building code as sub-divisions of building planning (ICC 2012). Previous studies provided evidence that these bathroom design elements may have an effect on the risk of falling for older adults (Sanford et al. 1995; Clemson and Martin 1996; Gill et al. 1999; Stevens et al. 2001; Day et al. 2002; Figueiro et al. 2008). The bathroom floor, also considered a design element, is described in the literature as an architectural space formation that has been found to have an effect on the risk of falling for older adults (Carter et al. 1997; Cumming et al. 1999). Therefore, in this study, the home bathroom is divided into five design elements: (1) toilet, (2) bathtub, (3) lavatory, (4) lighting, and (5) floor.

Following the conceptual approach of DCA, each one of these design elements is then divided into a number of design features that define its architectural design and that have evidenced to affect the risk of falling for older adults, as illustrated in Figure 4.1. Commonly used assistive devices that have been found to affect the risk

of falling for older adults, such as bathmat, grab-bars, and bath-seat, are also considered as design features (Sonn and Grimby 1994; Trickey et al. 1994; Clemson and Martin 1996; Edwards and Jones 1998; Dahlin Ivanoff and Sonn 2005). For example, the bathtub element is divided into: (1) bathtub grab-bar configuration for entrance (BB_{gc1}); (2) bathtub grab-bar configuration installed on back wall (BB_{gc2}); (3) bathtub grab-bar diameter and surface texture (BB_{gd}); (4) bathtub dimensions (BB_d); (5) bathtub seat (BB_c); (6) bathtub block schema (BB_b); (7) bathtub flooring and surface (BB_f); and (8) bathtub supporting equipment accessibility (BB_s). Each one of these features is divided into a number of design scenarios arranged in a hierarchical list based on the level of risk of falling associated with each scenario. The developed hierarchical lists of design scenarios for each feature are arranged according to the evidence-based studies from the systematic review. For example, the toilet grab-bar height feature (BT_{gh}) has three scenarios:

- (1) $900 \text{ mm} \leq \text{horizontal toilet grab-bar height} \leq 1,100 \text{ mm}$ and $750 \text{ mm} \leq \text{vertical or diagonal toilet grab-bar height} \leq 950 \text{ mm}$;
- (2) $600 \text{ mm} \leq \text{horizontal toilet grab-bar height} < 900 \text{ mm}$ and $450 \text{ mm} \leq \text{vertical or diagonal toilet grab-bar height} < 750 \text{ mm}$; and
- (3) $\text{horizontal toilet grab-bar height} > 1,100 \text{ mm}$ or $\text{horizontal toilet grab-bar height} < 600 \text{ mm}$ and $\text{vertical toilet grab-bar height} > 950 \text{ mm}$ or $\text{vertical toilet grab-bar height} < 450 \text{ mm}$.

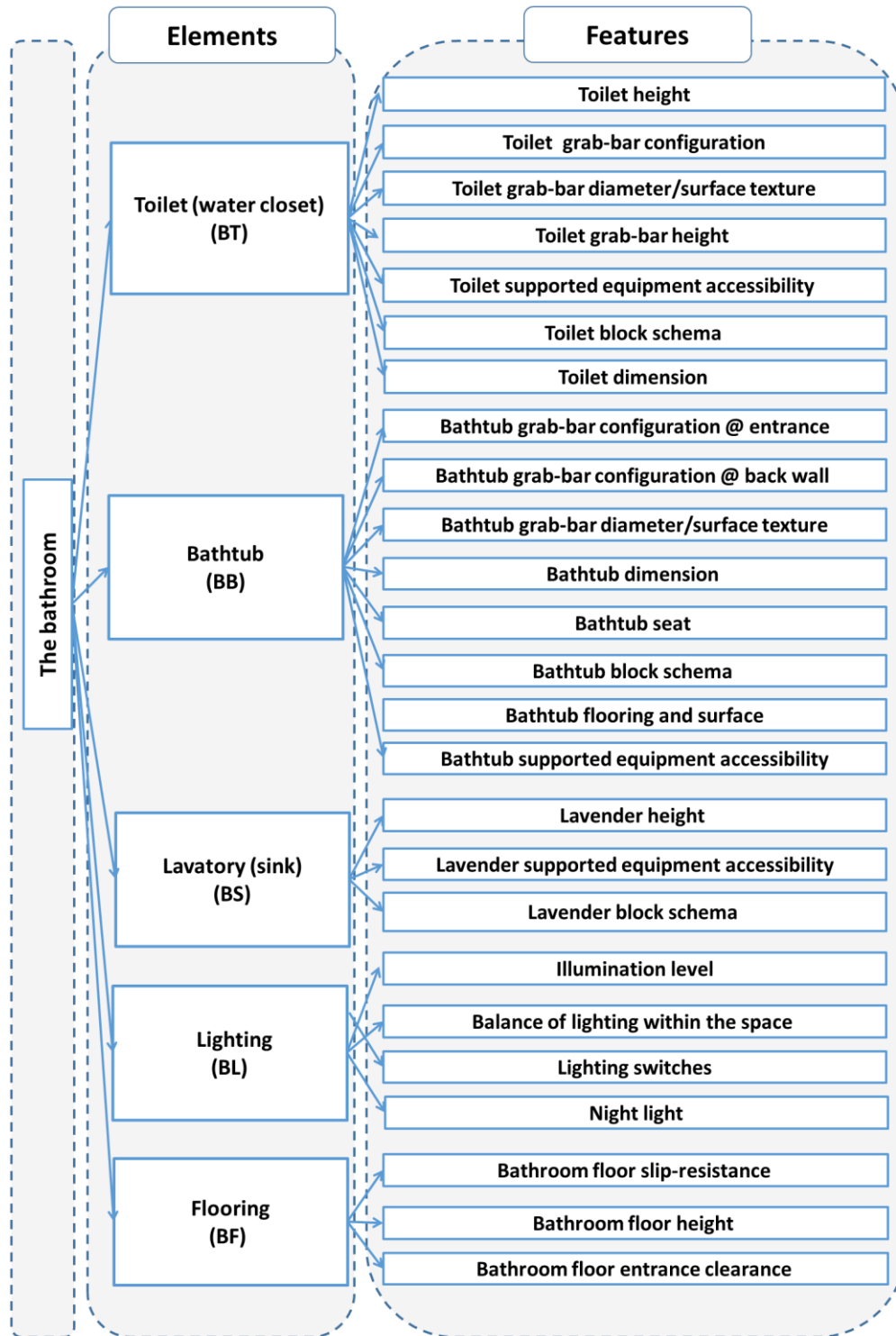

Figure 4.1. Flowchart for bathroom elements and features.

4.2 Analysis of Bathroom Design Elements and Features

4.2.1 Element 1: Toilet/Water Closet (BT)

4.2.1.1 Feature 1: Toilet height (BT_h)

Standing up and sitting down tasks have been found to be associated with a significant risk factor for falling among older adults (Campbell et al. 1989; Nevitt et al. 1989; Riley et al. 1991). Evidence shows that over 50% of older adults aged 85 and over have difficulties to perform the task of sitting down and standing up from the toilet (Clarke et al. 1984). In a cross-sectional study of 1,533 older adult participants aged 85 years and over, raised toilet seat was found to be the most common assistive device used by older adults, having been used by 69% of users in the toileting task (Dahlin Ivanoff and Sonn 2005). Therefore, toilet height has been recommended to be raised in order to reduce the degree of hip and knee flexion (Harman and Craigie 2011).

Harman and Craigie (2011) have stated that the toilet height should be adjusted according to individual-specific factors. In a study by Capezuti et al. (2008), Lower Leg Length (LLL) has been identified as an individual factor in relation to the toilet height. In this study, toilet height that optimally reduces the risk of falling for older adults has been found to be 100% to 120% of LLL. Toilet height that is higher than 120% and lower than 100% of LLL are associated with higher risk of falling (Capezuti et al. 2008). As the focus of this research is on identifying functional bathroom architectural design features, once identified, these features can be

implemented depending on the market availability of these products. Adjustment of toilet height can be achieved by various methods, such as adding a toilet seat on top of the existing toilet, toilet frame, or mobile commode (Harman and Craigie 2011). A hierarchical list of the proposed scenarios for the “toilet height” feature, starting from the optimal scenario that contributes most to reducing the risk of falling for older adults, is provided in Table 4.1.

Table 4.1: Rating factors for toilet height scenarios

Scenario order number	Toilet height	Rating factor
1	100% of (LLL) ≤ toilet height ≤ 120% of (LLL)	1.00
2	toilet height > 120% of (LLL) and toilet height < 100% of (LLL)	0.50

4.2.1.2 Feature 2: Toilet grab-bar configuration (BTgc)

Evidence shows that performing the task of standing up becomes more difficult as people age (Riley et al. 1991; Sanford et al. 1995; Lord et al. 2007). In order to support independence and safety for older adults, toilet grab-bars are necessary devices that support standing up transfer (Sanford et al. 1995; O'Meara and Smith 2005). Toilet grab-bars have been reported to be the second-most commonly installed toileting assistive device (Dahlin Ivanoff and Sonn 2005). A grab-bar design which combines horizontal and diagonal elements has been shown to be the most effective design based on the level of ease and safety with which older adults are able to sit down on and stand up from the toilet (Sanford et al. 1995). In the

Sanford et al. (1995) study, four different grab-bar configurations have been evaluated on two toilet seat heights, using a videotaped recording to track the pattern of grab-bar usage in the toileting task. The aim of their study was to evaluate the effect of different grab-bar configurations on the ability of older adults to toilet independently and safely (Sanford et al. 1995).

The best combination of grab-bars for older adults based on their study is the diagonal grab-bar (45° angle, 1,220 mm in length, 500 mm away from the perpendicular wall) with a horizontal grab-bar (500 mm in length, and 300 mm away from the perpendicular wall) configuration on the wall beside the toilet. This is found to be the easiest to use and safest configuration for over 50% of the participants. Other grab-bar configurations rate lower in comparison. The diagonal/horizontal grab-bar combination thus earns the optimal rating number, as illustrated in Figure 4.2. Other combinations are rated lower than the optimal configuration. The case of non-existence of a grab-bar is assigned a rating factor of 0.00, as the design feature does not exist, which is illustrated in Table 4.2.

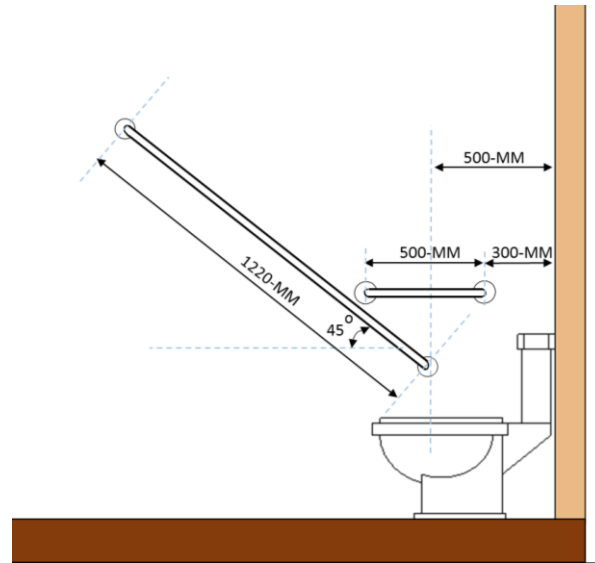

Figure 4.2. Optimal toilet grab-bar configuration on the side wall of the toilet.

Table 4.2: Rating factors for toilet grab-bar configuration scenarios

Scenario order number	Toilet grab-bar configuration	Rating factor
1	On the sidewall of the toilet, existence of diagonal grab-bar (45° angle, 1,220 mm in length, 500 mm away from perpendicular wall), and horizontal grab-bar (500 mm, and 300 mm away from the perpendicular wall)	1.00
2	Other toilet grab-bar combination	0.50
3	No toilet grab-bar installed	0.00

4.2.1.3 Feature 3: Toilet grab-bar diameter and surface texture (BTgd)

Grab-bars are long round tubes that enable older adults to maintain balance during transfers, such as a sit-to-stand transfer or a stand-to-sit transfer (Sanford et al.

1995; O'Meara and Smith 2006; Sveistrup et al. 2006; Kinoshita 2012). Inappropriate grab-bar diameter or texture may result in the inability to fully grasp the grab-bar, thereby increasing the risk of falling for older adults (Maki 1988; Templer 1992; Haslam and Stubbs 2006). Toilet grab-bar diameter is recommended by the Barrier-Free Design Guide to be 30 mm to 43 mm (SCC 2008). In addition, most studies have considered the handrail diameter to range from 30 mm to 43 mm in diameter (O'Meara and Smith 2005; Sveistrup et al. 2006).

Therefore, the optimal grab-bar diameter is considered to range from 30 mm to 43 mm. A grab-bar that is too smooth or too rough might result in unfixed grasping hand, as the grasping hand might move under the body's weight, resulting in a loss of balance that may lead to a fall (Maki 1988; Templer 1992; Haslam and Stubbs 2006). Therefore, the optimal grab-bar must have a surface texture which is not too rough or too smooth. A hierarchical list of the proposed scenarios for the "toilet grab-bar diameter and surface texture" feature, starting with the scenario that contributes most to reducing the risk of falling for older adults, is provided in following Table 4.3.

Table 4.3: Rating factors for toilet grab-bar diameter and surface texture scenarios

Scenario order number	Toilet grab-bar diameter and surface texture	Rating factor
1	30 mm ≤ Grab-bar diameter ≤ 40 mm And grab-bar surface texture is not too smooth or too rough	1.00
2	30 mm ≤ Grab-bar diameter ≤ 40 mm And grab-bar difficult to grasp (surface texture is too smooth or too rough) or Grab-bar diameter > 40 mm or Grab-bar diameter < 30 mm and grab-bar surface texture is not too smooth or too rough	0.67
3	Grab-bar diameter > 40 mm or Grab-bar diameter < 30 mm And grab-bar difficult to grasp (surface texture is too smooth or too rough)	0.33
4	No toilet grab-bar is installed	0.00

4.2.1.4 Feature 4: Toilet grab-bar height (BTgh)

Kinoshita et al. (2012) examined two different horizontal handrail heights, based on the level of safety and effective usage, on 25 older adults participants (65 years and older) performing the sit-to-stand task: (1) an upper height of range of 900 to 1,100 mm; and (2) a lower height range of 600 to 800 mm. This study found that the higher grab-bar height range of 900 to 1,100 mm reduces the torque in the lower limbs.

This study also found a higher grab-bar to necessitate less time to perform the sit-to-stand task than does the short grab-bar. Therefore, the optimal horizontal grab-bar height range for older adults is considered to be 900 mm to 1,100 mm. The second-best scenario is the height range from 600 mm to 900 mm. The worst-case scenarios are the height range lower than 600 mm or higher than 1,100 mm. Regarding the vertical direction of the grab-bar, a study by O'Meara et al. (2006) has considered the minimum height for the perpendicular grab-bar, defined as the distance from the floor to the bottom of the grab-bar, to be 150 mm lower than the horizontal grab-bar. The rating of the "toilet grab-bar height" feature, starting with the scenario that most reduces the risk of falling for older adults, is proposed in Table 4.4.

Table 4.4: Rating factors for toilet grab-bar height scenarios

Scenario order number	Toilet grab-bar height	Rating factor
1	900 mm \leq horizontal toilet grab-bar height \leq 1,100 mm And 750 mm \leq vertical or diagonal toilet grab-bar height \leq 950 mm	1.00
2	600 mm \leq horizontal toilet grab-bar height $<$ 900 mm And 450 mm \leq vertical or diagonal toilet grab-bar height $<$ 750 mm	0.67
3	horizontal toilet grab-bar height $>$ 1,100 mm or horizontal toilet grab-bar height $<$ 600 mm and vertical toilet grab-bar height $>$ 950 mm or vertical toilet grab-bar height $<$ 450 mm	0.33
4	no toilet grab-bar installed	0.00

4.2.1.5 Feature 5: Toilet supporting equipment accessibility (BTs)

Toilet supporting equipment needs to be accessible or reachable, since an exaggerated body position, such as extra bending or stretching, may lead to a fall (Gill et al. 1999). Two items of equipment in relation to the toilet are necessary to complete the toileting task: (1) the toilet tank, which is reached through toilet flush; and (2) the toilet paper disposal receptacle, which required to be easy to reach without bending or stretching (Panero and Zelnik 1979; Parrott et al. 2013).

Therefore, the optimal scenario is to have the frequently used toilet equipment within reach without exaggerating the body position, as outlined in Table 4.5.

Table 4.5: Rating factors for toilet supporting equipment accessibility

Scenario order number	Toilet supporting equipment accessibility	Rating factor
1	Toilet supporting equipment is easy to reach without exaggerating body position	1.00
2	Toilet supporting equipment is not easy to reach without exaggerating body position	0.50

4.2.1.6 Feature 6: Toilet block schema (BTb)

In order to reduce the falling risks within the surrounding environment that could result from bumping, tripping or stumbling into an object (Talbot et al. 2005), anthropometric considerations pertaining to different objects are taken into account in seeking a solution to eliminate the possibility of interference (Panero and Zelnik 1979; Parrott et al. 2013). The concept of toilet block schema is developed based on the anthropometric consideration; this results in forming the free-zone area around the toilet in order to reduce the possibility of bumping into the toilet or any other nearby equipment while performing the associated toileting tasks, such as sit-to-stand, stand-to-sit, accessing the toilet paper disposal receptacle, or turning the body to flush the toilet (Harman and Craigie 2011). Based on anthropometric considerations for the individual in relation to the toilet (Panero and Zelnik 1979;

Parrott et al. 2013), the toilet block schema is illustrated in Figure 4.3. Rating of the “toilet block schema” is given Table 4.6.

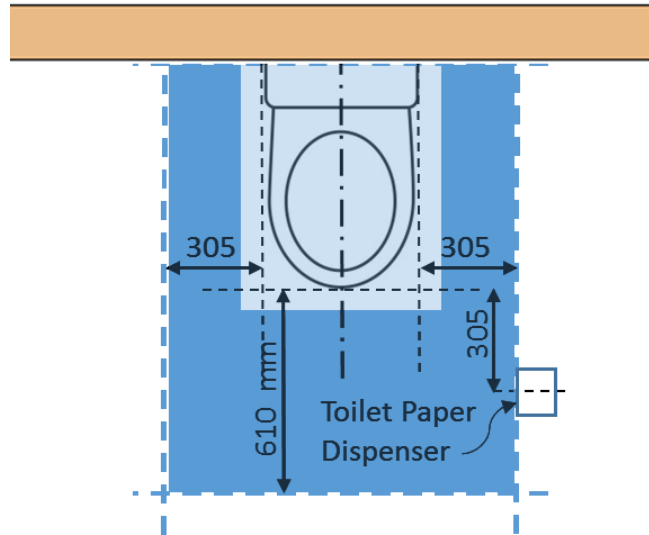

Figure 4.3. Toilet block schema (BT_b), dimensions in mm.

Table 4.6: Rating factors for toilet block schema scenarios

Scenario order number	Toilet block schema	Rating factor
1	Toilet block schema is clear from any other fixed object	1.00
2	Toilet block schema intersects with a minimum of one fixed object	0.50

4.2.1.7 Feature 7: Toilet dimensions (BT_d)

Modifications of the home environment have been introduced as part of fall-prevention strategies (Stevens et al. 2001; Lord et al. 2007). Inappropriate design

dimensions for the interior space objects are expected to reduce the ability of individuals to function properly within the interior space, which may increase the risk of falling (Panero and Zelnik 1979; Taira and Carlson 1999; Lord et al. 2007). A study by Rashid et al. investigating design object dimensions based on the anthropometric measurements of older adults concluded that anthropometric consideration for individuals needs to be taken into account in order to increase the level of comfort and safety within the interior space for older adults (Rashid et al. 2008). For example, the toilet, an item of interior space equipment used for the private task of toileting, might be designed with inappropriate dimensions that are unsuitable to the measurements of the human body.

Equipment dimensions must therefore be based on anthropometric considerations, which involves the study of human body measurements and actions required to complete a certain task within the given space (Panero and Zelnik 1979; Ramsey et al. 2000). Toilet depth and width vary depending on the type of toilet and space availability. Therefore, the optimal toilet depth and width is represented by a range as follows: the optimal range of toilet depth is 650 mm to 790 mm, and the optimal range of toilet width is 410 mm to 550 mm (Neufert et al. 2000; Ramsey et al. 2000). A hierarchical list of the proposed scenarios for the “toilet dimensions” feature, starting with the scenario which most contributes to reducing the risk of falling for older adults, is provided in Table 4.7.

Table 4.7: Rating factors for toilet dimension scenarios

Scenario order number	Toilet dimensions	Rating factor
1	Toilet depth ranges from 650 mm to 790 mm, and toilet width ranges from 410 mm to 550 mm	1.00
2	Toilet depth or width is outside the optimal range	0.50

4.2.2 Element 2: Bathtub

4.2.2.1 Feature 1: Bathtub grab-bar configuration for the entrance (BBgc1)

A cross-sectional study by Aminzadeh et al. has found that over 50% of bathroom-related falls occur while performing the bathing activity. Among the various causes, bathtub transfers accounted for 70% of falls (Aminzadeh et al. 2000). Bath grab-bars have been introduced as a bathroom safety device that supports independent living for older adults (Lord et al. 2007; Tideiksaar 2010). Evidence indicates that two bathing tasks are difficult for older adults and require installation of an appropriate grab-bar: (1) bathtub entrance/exit, or getting into or out of the bathtub; and (2) sitting into or getting up from the bottom of the bathtub (Edwards et al. 2003; Sveistrup et al. 2006).

In Sveistrup et al. (2006), an experimental study for grab-bar configuration evaluation, the optimal bath grab-bar configuration to support safe bathtub entrance/exit by older adults has been found to be one long, vertical grab-bar, (1,200

mm in length and mounted from 180 mm to 280 mm above the rim). They also found that in the optimal configuration the grab-bar would be located on the bathtub side wall from where older adults usually enter the bathtub, as illustrated in Figure 4.4A. They found the second-best grab-bar configuration to be the horizontal grab-bar, (minimum 610 mm length measured from the outer edge of the bathtub and mounted approximately 475 mm above the rim), located on the bathtub sidewall from where older adults usually enter the bathtub, as illustrated in Figure 4.4B.

The third configuration is to have inappropriately or awkwardly located grab-bars, while having no grab-bars at all would result in the worst possible configuration. These awkwardly placed grab-bars increase the probability of losing balance, slipping or falling while older adults try to grasp the grab-bars (Sveistrup et al. 2006), because falls might occur during unsuccessful transfers while entering or exiting the bathtub (Aminzadeh et al. 2000; Sveistrup et al. 2006). A hierarchical list of the proposed scenarios for the “bathtub grab-bar configuration for the entrance” feature, starting with the scenario that most reduces the risk of falling for older adults, is given in Table 4.8.

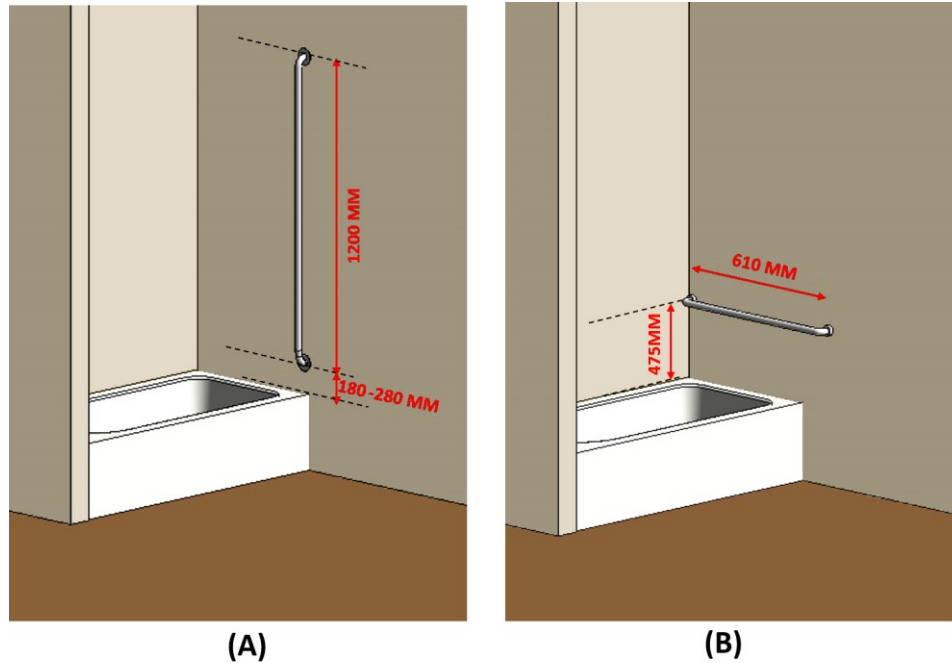

Figure 4.4. Bath tub grab-bar configuration for the entrance at sidewall of bathtub: (A) optimal scenario, (B) second-best scenario.

Table 4.8: Rating factors for scenarios of the bathtub grab-bar configuration for the entrance feature

Scenario order number	Bathtub grab-bar configuration	Rating factor
1	one long vertical grab-bar (1,200 mm in length and mounted from 180 to 280 mm above the rim), located from where older adults usually enter the bathtub	1.00
2	horizontal grab-bar (min 610 mm length measured from the outer edge of the bathtub and mounted approximately 475 mm above the rim) located on the bathtub side wall from where older adults usually enter the bathtub	0.67
3	other bath grab-bar configurations (inappropriate/awkward located grab-bars)	0.33
4	no bath grab-bar installed to support bathtub entrance/exit	0.00

4.2.2.2 Feature 2: Bathtub grab-bar configuration installed on back wall (BBgc2)

Evidence shows that the absence of bath grab-bars increases the risk of falling among older adults (Aminzadeh et al. 2000; Sveistrup et al. 2006). In order to identify the optimal grab-bar configuration, different bath grab-bar configurations have been evaluated in Sveistrup et al. (2006), an experimental study of 103 older adults aged 60 years and over. In their study, bath grab-bar configurations were analyzed based on safety, ease of use, comfort, and helpfulness (Sveistrup et al. 2006). Based on their study, the optimal bath grab-bar configuration to support sitting into or getting up from the bathtub is either long horizontal, (min 1,200 mm in length and mounted from 180 to 280 mm above the rim), or angled grab-bar, (minimum of 600 mm in length, mounted at approximately a 45° angle, with the top of the grab-bar located at approximately 300 mm from the faucet wall, and the bottom of grab-bar located approximately 150 mm above the rim), located on the back wall of the bathtub (Sveistrup et al. 2006), as illustrated in Figure 4.5.

The second-best grab-bar configuration to support sitting into or getting up from the bathtub is either (a) two parallel horizontal grab-bars, (minimum of 610 mm in length, mounted a maximum of 305 mm from the faucet wall, where the first grab-bar is mounted approximately 230 mm above the rim and the second grab-bar is mounted approximately 475 mm), or (b) an L-shaped grab-bar, (a minimum of 900 mm in length for each bar, with the horizontal bar of the “L” located 150 mm to 200 mm above the rim, and the vertical bar of the “L” located 300 mm to 450 mm

from the faucet wall of the bathtub). Both configurations are located in the back wall of the bathtub. Any other scenario than those described above would be considered the third-case, as it may increase the possibility of losing balance, slipping, or falling as the older adult attempts to reach inappropriately located grab-bars (Sveistrup et al. 2006). This is followed by the worst case in which the grab-bar does not exist, where falls may result from unsuccessful transfers while attempting to sit into or get up from the bottom of the bathtub (Aminzadeh et al. 2000; Sveistrup et al. 2006). A hierarchical list of the proposed scenarios for the “bathtub grab-bar configuration installed in the back wall” feature, starting from the scenarios which contribute most to reducing the risk of falling for older adults, is provided in Table 4.9.

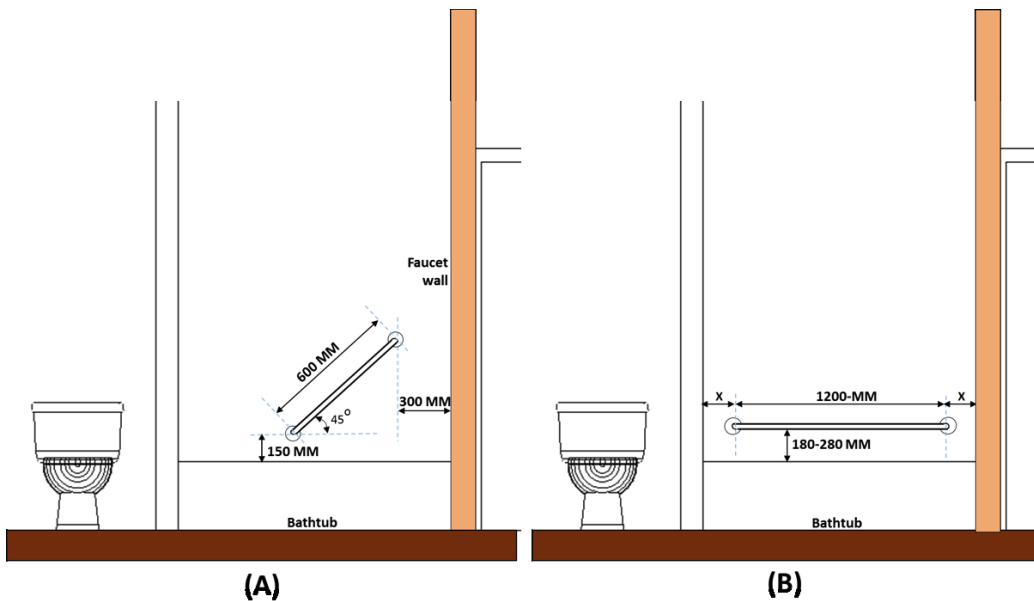

Figure 4.5. Bathtub grab-bar configuration installed in the back wall of bathtub: (A) and (B) are optimal scenario.

Table 4.9: Rating factors for scenarios of bathtub grab-bar configuration installed on back wall feature

Scenario order number	Bathtub grab-bar configuration	Rating factor
1	<p>Long horizontal grab-bar (min 1200 mm in length and mounted from 180 mm to 280 mm above the rim)</p> <p>or</p> <p>Angled grab-bar (min 600 mm in length, mounted at approximately a 45° angle, top of grab-bar located at approximately 300 mm from the faucet wall, and bottom of grab-bar located approximately 150 mm above the rim), both located on the back wall of the bathtub</p>	1.00
2	<p>Two parallel horizontal grab-bars (min 610 mm in length, mounted 305 mm max from the faucet wall, where first grab-bar mounted approximately 230 mm above the rim and the second grab-bar mounted approximately 475 mm)</p> <p>or</p> <p>L-shaped grab-bar (min 900 mm length for each bar, the horizontal bar of the “L” located in 150 mm to 200 mm above the rim, and the vertical bar of the “L” located 300 mm to 450 mm from the faucet wall of the bathtub), both located in the back wall of the bathtub.</p>	0.67
3	<p>Other bath grab-bar configurations (inappropriate/awkward located grab-bars)</p>	0.33
4	<p>No bath grab-bar installed to support getting in and out of bathtub</p>	0.00

4.2.2.3 Feature 3: Bathtub grab-bar diameter and surface texture (BBgd)

Grab-bars are round tubes mounted on the wall in order to assist older adults in maintaining balance during various transfers, such as sit-to-stand from toilet or entering the bathtub (Sanford et al. 1995; O’Meara and Smith 2006; Sveistrup et al. 2006; Kinoshita 2012). Specifications for bathtub grab-bar diameter and surface texture are considered to be the same as the toilet grab-bar diameter and surface texture, as they share the same action of grasping with the hand. However, the configuration (length and direction) and the location of installation differ between bathtub and toilet grab-bars, which is related to their respective functions (Sanford et al. 1995; Sveistrup et al. 2006).

For example, bathtub grab-bars assist the sit-to-stand transfer into and out from the bottom of the bathtub and bathtub entrance/exit (Sveistrup et al. 2006). Toilet grab-bars, on the other hand, assist the sit-to-stand or stand-to-sit transfer from the toilet seat (Sanford et al. 1995). This affects the grab-bar configuration and location; however, it does not affect the diameter or surface texture of the grab-bar, since the grab-bar diameter and surface texture are built to facilitate graspability regardless of the configuration or location of the grab-bar (Maki 1988; Templer 1992; Haslam and Stubbs 2006). A hierarchical list of the proposed scenarios for the “bathtub grab-bar diameter and surface texture” feature is provided in Table 4.10.

Table 4.10: Rating factors for scenarios of bathtub grab-bar diameter and surface texture feature

Scenario order number	Bathtub grab-bar diameter and surface texture	Rating factor
1	$30 \text{ mm} \leq \text{Grab-bar diameter} \leq 40 \text{ mm}$ And grab-bar surface texture is not too smooth or too rough	1.00
2	$30 \text{ mm} \leq \text{Grab-bar diameter} \leq 40 \text{ mm}$ And grab-bar difficult to grasp (surface texture is too smooth or too rough) Or Grab-bar diameter $> 40 \text{ mm}$ or Grab-bar diameter $< 30 \text{ mm}$ and grab-bar surface texture is not too smooth or too rough	0.67
3	Grab-bar diameter $> 40 \text{ mm}$ or Grab-bar diameter $< 30 \text{ mm}$ And grab-bar difficult to grasp (surface texture is not too smooth or too rough)	0.33
4	No grab-bar installed	0.00

4.2.2.4 Feature 4: Bathtub dimensions (BBd)

For the reason that inappropriate interior space objects may increase the risk of falling by reducing the functional usage of the space (Panero and Zelnik 1979; Taira and Carlson 1999; Lord et al. 2007), bathtub dimensions must accommodate the

human measurements in order for the bathtub to function properly for the bathing activity (Panero and Zelnik 1979). Bathtub length, width, and height vary depending on the type of bathtub and space availability.

Based on anthropometric considerations, the standard bathtub, or tub/shower combination, dimension ranges are as follows: length from 1,422 mm to 1,524 mm, width from 700 mm to 815 mm, and height from 381 mm to 559 mm (Panero and Zelnik 1979; Neufert et al. 2000; Ramsey et al. 2000). These bathtub dimension ranges are illustrated in Figure 4.6. A hierarchical list of the proposed scenarios for the “bathtub dimensions” feature, starting from the scenarios which contribute most to reducing the risk of falling for older adults, is given in Table 4.11.

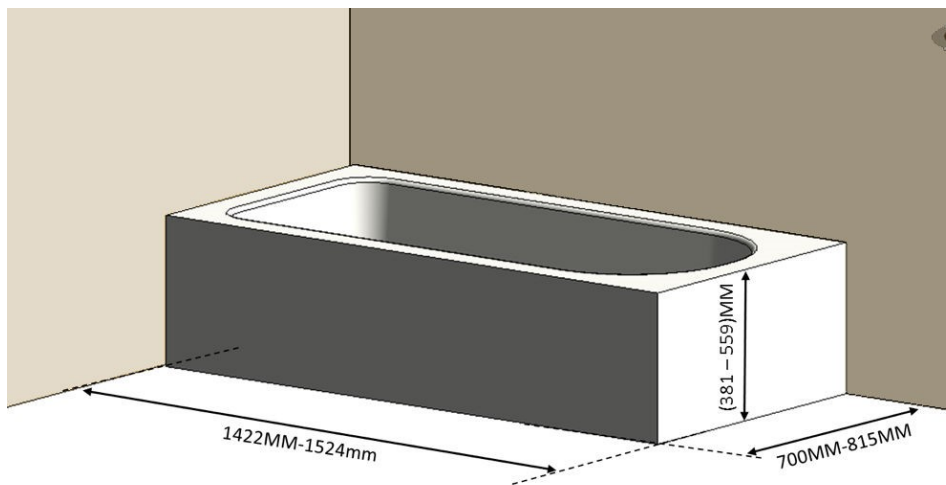

Figure 4.6. Bathtub dimensions based on anthropometric considerations.

Table 4.11: Rating factors for bathtub dimension scenarios

Scenario order number	Bathtub dimensions	Rating factor
1	Bathtub length ranges from 1,422 mm to 1,524 mm, width ranges from 700 mm to 815 mm, and height ranges from 381 mm to 559 mm	1.00
2	Bathtub length, width, or height is outside the optimal range	0.50

4.2.2.5 Feature 5: Bathtub seat (BBc)

Although a bathtub seat is a commonly installed feature (Dahlin Ivanoff and Sonn 2005), the bathtub seat is classified as an unsafe feature (Murphy et al. 2006). In a cross-sectional analysis conducted by Murphy et al., more than half of participants fall or “plop” onto the installed tub seat (Murphy et al. 2006). Given the associated risk of this kind of motion for older adults, the optimal scenario will be a bathtub without a seat. A hierarchical list of the proposed scenarios for the “bathtub seat” feature, starting with the scenario which contributes most to reducing the risk of falling for older adults, is provided in Table 4.12.

Table 4.12: Rating factors for bathtub seat scenarios

Scenario order number	Bathtub seat	Rating factor
1	Bathtub seat is not installed	1.00
2	Bathtub seat is installed	0.50

4.2.2.6 Feature 6: Bathtub block schema (BBb)

In order to mitigate the risk of falling by reducing the possibility of bumping or tripping into an object (Talbot et al. 2005), anthropometric consideration has been taken into account for the optimization of the space (Panero and Zelnik 1979; Parrott et al. 2013). Based on this, the bathtub block schema is generated to accommodate the human measurements in relation to the built environment after completing the bathing task. As illustrated in Figure 4.7, a free-zone of a minimum of 530 mm is required in front of the bathtub (Panero and Zelnik 1979; Parrott et al. 2013), and a minimum width of 610 mm in order to accommodate human body dimensions during bathtub entrance/exit (Panero and Zelnik 1979). This is considered the optimal case. A hierarchical list of the proposed scenarios for the “bathtub block schema” feature, starting with the scenario that contributes most to reducing the risk of falling for older adults, is provided in Table 4.13.

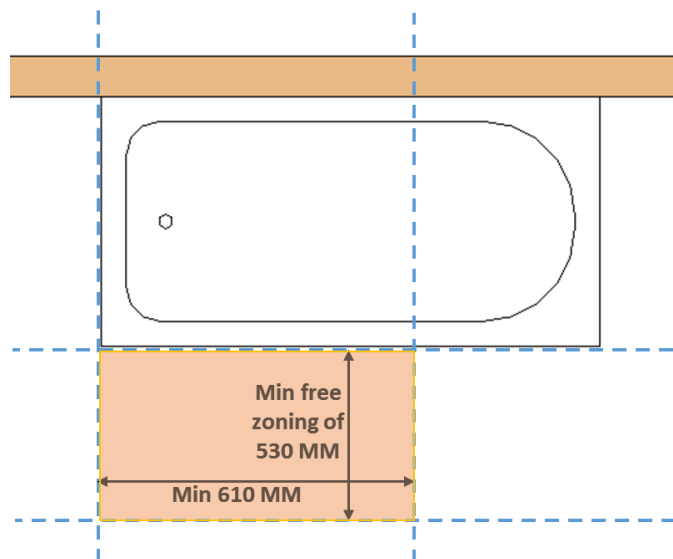

Figure 4.7. Bathtub block schema.

Table 4.13: Rating factors for bathtub block schema scenarios

Scenario order number	Bathtub block schema	Rating factor
1	bathtub block schema is clear from other fixed objects	1.00
2	bathtub block schema intersects with a minimum of one other fixed object	0.50

4.2.2.7 Feature 7: Bathtub flooring and surface (BBf)

Bath mats have been found to be one of the most commonly installed devices for bathing activities (Clemson and Martin 1996). In a Clemson and Martin (1996) study, 88% of 66 participants used the bath mat as a long-term safety measure for bathing by which to reduce the possibility of slipping or falling. Non-slip bathtub floors are also regarded as a measure which is critical for regaining one's balance after entering or exiting the bathtub (Guitard et al. 2007). In addition, in a study by Sveistrup et al. (2006) study, 99% of participants used the bathtub rim/edge to perform the tasks of sitting into or getting out from the bathtub. Their study thus suggested that a non-slip surface is required as a safety feature to reduce the risk of falling for older adults.

A uniform non-slip surface for the bathtub floor and edges is therefore required in order to prevent slipping (Clemson and Martin 1996; Sveistrup et al. 2006). The optimal case of providing a non-slip bathtub floor can be implemented by applying non-slip bath mats. A hierarchical list of the proposed scenarios for the “bathtub

flooring and surface” feature, starting with the scenario that contributes most to reducing the risk of falling for older adults, is illustrated in Table 4.14.

Table 4.14: Rating factors for bathtub flooring and surface scenarios

Scenario order number	bathtub flooring surface	Rating factor
1	Bathtub floor has a uniform non-slip surface, and non-slip rim/edges	1.00
2	Bathtub floor has a uniform non-slip surface, and slippery rim/edges	0.75
3	Bathtub has slippery floor surface, and non-slip rim/edges	0.50
4	Bathtub has a slippery floor surface and rim/edge surface	0.25

4.2.2.8 Feature 8: Bathtub supporting equipment accessibility (BBs)

Bathtub supporting equipment/items which are necessary to perform the bathing task, such as faucet and soap holder (Murphy et al. 2007) is required be easily accessible since the possibility of falling is expected to increase as the individual attempts to reach across the bathtub to acquire the necessary equipment (Sveistrup et al. 2006). Therefore, bathtub supporting equipment that is accessible is considered to be the optimal case. The worst-case scenario is if they are not accessible. A hierarchical list of the proposed scenarios for the “bathtub supporting equipment accessibility” feature is provided in Table 4.15.

Table 4.15: Rating factors for bathtub supporting equipment accessibility

Scenario order number	Bathtub supporting equipment	Rating factor
1	Bathtub supporting equipment is easy to reach without exaggerating body position	1.00
2	Bathtub supporting equipment is not easy to reach without exaggerating body position	0.50

4.2.3 Element 3: Lavatory (sink)

4.2.3.1 Feature 1: Lavatory height (BSh)

Lavatory dimensions vary depending on the design and space availability (Panero and Zelnik 1979; Parrott et al. 2013). However, regardless of planned lavatory dimensions, the lavatory height needs to accommodate the human body measurements to ensure safe performance of the associated tasks, since inappropriate design dimensions for the interior space objects are expected to reduce the ability of the individual to function properly within the interior space while interacting with the given object, which may participate to the increased risk of falling (Panero and Zelnik 1979; Lord et al. 2007). Based on anthropometric considerations, the optimal lavatory height range is 813 mm to 1,092 mm (Panero and Zelnik 1979; Parrott et al. 2013). Heights outside this range are considered to constitute a hazardous configuration. A hierarchical list of the proposed “lavatory height” scenarios is provided in Table 4.16.

Table 4.16: Rating factors for lavatory height scenarios

Scenario order number	Lavatory height	Rating factor
1	813 mm ≤ lavatory height ≤ 1092 mm	1.00
2	toilet height > 1,092 mm and toilet height < 813 mm	0.50

4.2.3.2 Feature 2: Lavatory supporting items accessibility (BSs)

Frequently used items which requires the individual to assume an exaggerated body position such as extra bending or stretching has been identified as a hazard within the home environment that may lead to falls (Gill et al. 1999). Therefore, items frequently used to complete washing tasks or any other tasks in relation to the lavatory, such as soap dishes/dispensers, are required to be easily accessible to older adults (Panero and Zelnik 1979; Parrott et al. 2013). A lavatory area in which frequently used items are easy to reach without exaggerating body position is thus considered to be the optimal scenario. A hierarchical list of the proposed “lavatory supporting items accessibility” scenarios, starting with the scenario that contributes most to reducing the risk of falling for older adults, is provided in Table 4.17.

Table 4.17: Rating factors for lavatory supporting items accessibility

Scenario order number	Frequently used lavatory items	Rating factor
1	Frequently used lavatory items are easy to reach without exaggerating body position	1.00
2	Frequently used lavatory items are not easy to reach without exaggerating body position	0.50

4.2.3.3 Feature 3: Lavatory block schema (BSb)

As mitigating the possibility of tripping or bumping into an object is expected to participate in the risk of falling reduction for older adults (Talbot et al. 2005), anthropometric aspects are considered in optimizing the usage of space (Panero and Zelnik 1979; Parrott et al. 2013). Based on this, the lavatory block schema shown in Figure 4.8 is proposed, which is based on the human body measurements in relation to the built environment while standing in front of the lavatory to complete any task (Panero and Zelnik 1979; Parrott et al. 2013). A free-zone of a minimum 686 mm in front of the lavatory is required, with a width of 267 mm measured from the faucet center, as illustrated in Figure 4.8, in order for a human to be able to bend, stand, or lean slightly down for the use of the lavatory (Panero and Zelnik 1979). A hierarchical list of the proposed “lavatory block schema” scenarios is given in Table 4.18.

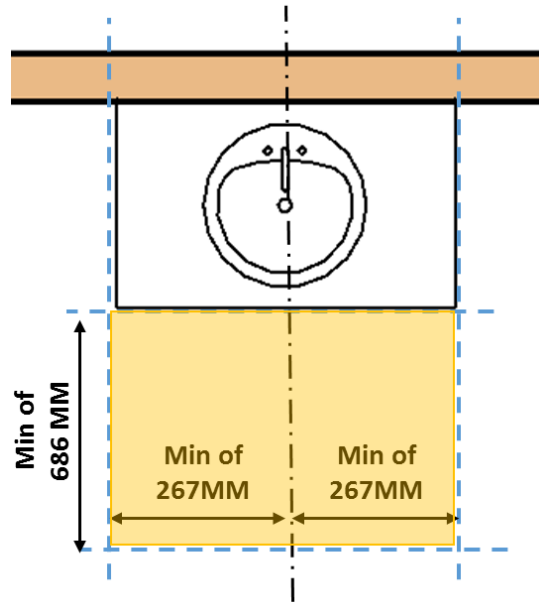

Figure 4.8. Lavatory block schema.

Table 4.18: Rating factors for lavatory block schema scenarios

Scenario order number	Lavatory block schema	Rating factor
1	Lavatory block schema is clear from all other fixed object	1.00
2	Lavatory block schema intersects with a minimum of one other fixed object	0.50

4.2.4 Element 4: Lighting

4.2.4.1 Feature 1: Illumination level (BLI)

Given that vision is the sensory that is used to gather information about the surrounding environment to enable safe performance and interaction within the

space (Mann and Helal 2006), poor vision has been identified as a contributing factor to the risk of falling (Carter et al. 1997; Lord and Dayhew 2001). In the randomized control trial conducted by Stevens et al. (2001) that investigated the effect of home safety modifications on reducing the risk of falling, it was found that the risk of falling might be reduced by improving the home lighting. An adequate amount of lighting is required in order to permit older adults to maneuver safely among different space surfaces in the bathroom (Lord and Dayhew 2001; IESNA 2007).

Lighting in bathrooms is divided into two categories: (1) ambient or general lighting, which is required to exist in order to provide bathroom space lighting, and (2) task lighting, which is the specialized lighting for various bathroom tasks, such as washing at the lavatory or bathing in the bathtub (IESNA 2007; Parrott et al. 2013). The Lighting for the Aged and Partially-Sighted Committee of the Illuminating Engineering Society of North America (IESNA) has recommended a minimum of 300-lux for the ambient lighting of the bathroom, and a minimum of 600-lux for task lighting (IESNA 2007). Therefore, the optimal illumination level in the bathroom is considered to be a minimum of 300-lux for ambient lighting and a minimum of 600-lux for the task level. A hierarchical list of the proposed “illumination level” scenarios is given in Table 4.19.

Table 4.19: Rating factors for illumination level scenarios

Scenario order number	Illumination level scenarios	Rating factor
1	Illumination level for ambient lighting ≥ 300 -lux And illumination level for task lighting ≥ 600 -lux	1.00
2	Illumination level for ambient lighting ≥ 300 -lux And illumination level for task lighting < 600 -lux Or Illumination level for ambient lighting < 300 -lux And illumination level for task lighting ≥ 600 -lux	0.67
3	Illumination level for ambient lighting < 300 -lux And Illumination level for task lighting < 600 -lux	0.33

4.2.4.2 Feature 2: Lighting switches (BLs)

Lighting switches is required to be located outside the bathroom in order to facilitate accessing the switch without the need to walk in the dark to reach it, which would increase the possibility of older adults tripping and falling (Carter et al. 1997; IESNA 2007; Parrott et al. 2013). In addition, lighting switch locations which are difficult to reach (too high or low) have been identified as a hazard in the home environment that may lead to a fall when the older adult stretches or strains to operate the switch (Carter et al. 1997). The optimal bathroom switch height has been found to be approximately 1,200 mm above the floor (Panero and Zelnik 1979; Parrott et al. 2013). Therefore, the optimal scenario is to have the lighting switch

situated outside the bathroom door at an easy to reach location with a height of 1,200 mm above the floor. A hierarchical list of the proposed “lighting switches” scenarios, starting with the scenario that contributes most to reducing the risk of falling for older adults, is provided in Table 4.20.

Table 4.20: Rating factors for lighting switch scenarios

Scenario order number	Lighting switch scenarios	Rating factor
1	Bathroom lighting switch situated outside the bathroom door and in easy to reach location with a height of 1,200 mm above the floor	1.00
2	Bathroom lighting switch is situated outside the bathroom door and in a difficult to reach location or Bathroom lighting switch is situated inside the bathroom door and in an easy to reach location	0.67
3	Bathroom lighting switch situated inside the bathroom door And is in a difficult to reach location	0.33

4.2.4.3 Feature 3: Balance of lighting within the space (BLb)

Bathroom lighting must be balanced within the entire space (IESNA 2007; Parrott et al. 2013). Imbalanced lighting, such as shaded areas or bright spots that create glare, has been found to cause visual discomfort and may increase the risk of falling

for older adults (Carter et al. 1997; IESNA 2007). IESNA has recommended balanced lighting amount with no shaded or bright areas for both ambient lighting and task lighting in the bathroom (IESNA 2007). For example, Figure 4.9A shows a shaded area created as a result of the down-lighting in the ceiling; however, in Figure 4.9B the shaded area is eliminated by modifying the lighting location. Therefore, the optimal design will have balanced lighting within the bathroom space, without shaded areas. A hierarchical list of the proposed “Balance of lighting within the space” scenarios, starting with the scenario that contributes most to reducing the risk of falling for older adults, is provided in Table 4.21.

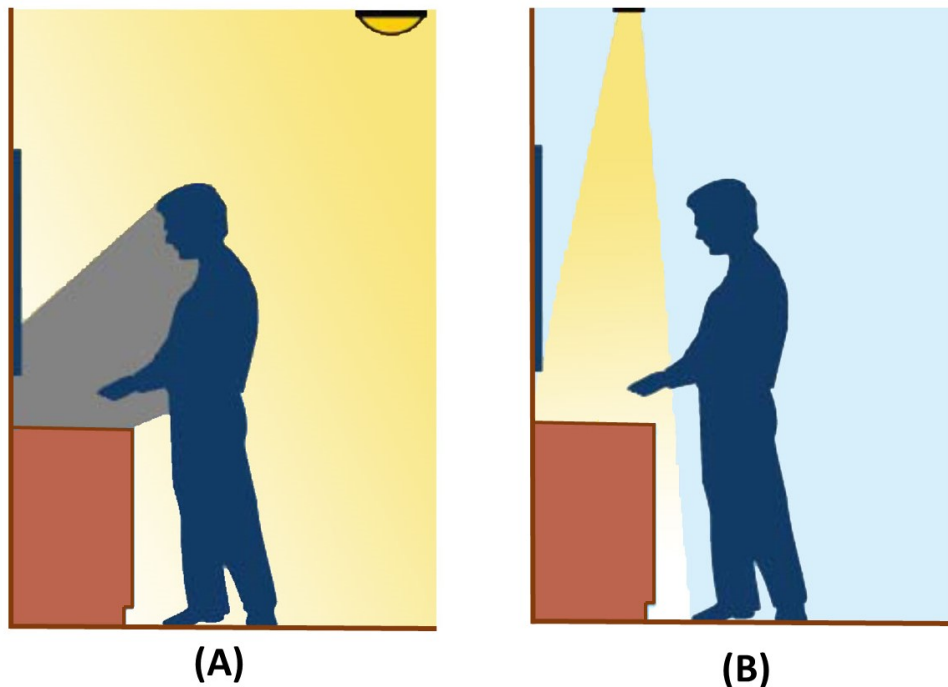

Figure 4.9. (A) Imbalanced lighting: shaded area resulting from down-lighting. (B) Balanced lighting: modified lighting location.

Table 4.21: Rating factors for balance of lighting amount scenarios

Scenario order number	Balance of lighting amount scenarios	Rating factor
1	Bathroom lighting is balanced without shaded or bright areas	1.00
2	Bathroom lighting is not balanced with shaded or bright areas are created	0.50

4.2.4.4 Feature 4: Night-light (BLn)

The absence of night-lights has been identified as an environmental risk factor which increases the likelihood of a fall (Moss 1992; Carter et al. 1997; Tinetti 2003; Figueiro et al. 2008). Older adults are expected to wake up at night in order to use the bathroom, and some may try to use the bathroom without turning on the light, which increases the risk of falling (Moss 1992; Figueiro et al. 2008). In addition, it has been found that with aging the eyes require more time to adjust to changing light levels from bright to dark, which may also increase the risk of falling during the recovery of being exposed to bright light (Figueiro et al. 2008).

Therefore, it is recommended to change the environment to support better vision for older adults, which can be provided through a night-light. In Figueiro et al. (2008), an experimental study on twelve older adult participants (aged 65 years and over), it has been found that using night-lights may improve postural control and stability for older adults. As well, the study showed that use of a night-light is commonly accepted among older adults. Based on this study, a rope light of a warm

colour (yellow) around the bathroom door frame is recommended in order for older adults to define the bathroom door location, and a night-light of a maximum of 1-Lux is recommended to be located in the junction between the floor and the wall (Figueiro et al. 2008).

IESNA (2007) has also recommended adding low-wattage fixtures located as low as possible to the floor and on the wall in order to light the individual's way. Therefore, the optimal night-light for the bathroom is to have a rope light of a warm colour (yellow) around the bathroom door frame and a night-light of low-wattage fixtures and a maximum of 1-Lux located as close as possible to the floor and on the wall to light the way to the toilet (see Figure 4.10). Other scenarios, such as having a bright colour of night light, or a night-light located at the counter level height, are associated with a higher probability of falling. A hierarchical list of the proposed "Night-light" scenarios, starting with the scenario that contributes most to reducing the risk of falling for older adults, is provided in Table 4.22.

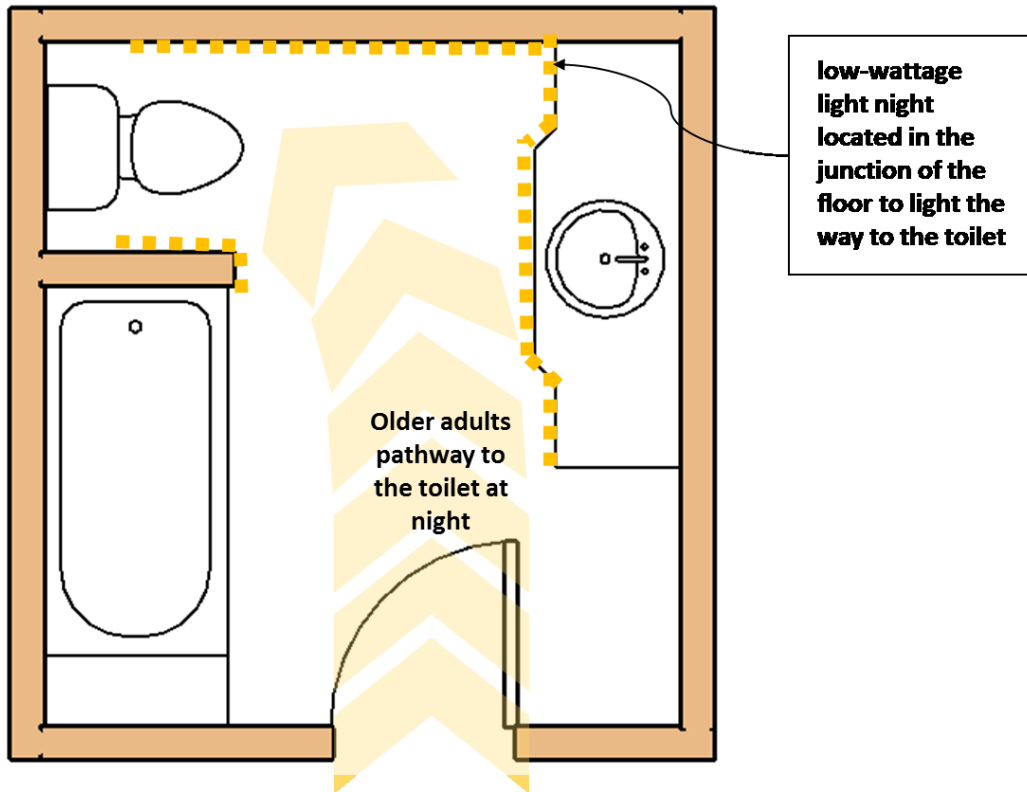

Figure 4.10. Lighting the pathway to the toilet at night.

Table 4.22: Rating factors for bathroom night-light scenarios

Scenario order number	Night-light scenarios	Rating factor
1	Rope light of a warm colour (yellow) around the bathroom door frame and a night-light of low-wattage fixtures with max of 1-Lux located as low as possible to the floor and on the wall to light the way to the toilet	1.00
2	Any other scenario	0.50

4.2.5 Element 5: Bathroom floor

4.2.5.1 Feature 1: Bathroom floor slip-resistance (BFs)

Evidence suggests that installation of home safety modifications, such as non-slippery rugs, may reduce the risk of falling for older adults (Plautz et al. 1996; Carter et al. 1997). In a cross-sectional survey of 425 older adults (aged 70 years and over) hazards relating floor slip-resistance such as slippery floor surfaces, non-slip mats, loose mats, and wet floors, has been found to be prevalent, which may increase the probability of falling for older adults (Carter et al. 1997). In addition, the most commonly recommended home modification is to remove any loose floor carpet and use non-slip bathroom mats in order to create a safe gait location (Carter et al. 1997; Cumming et al. 1999; Stevens et al. 2001; Tinetti 2003; Lord et al. 2007). Therefore, the optimal scenario is to have a uniform slip-resistant floor surface, such as having a floor with non-slip mats, in order to reduce the risk of falling (Carter et al. 1997). The worst-case scenario is to have a bathroom floor that has a non-uniform slip-resistant floor surface. A hierarchical list of the proposed “bathroom floor slip-resistance” scenarios, starting with the scenario that most reduces the risk of falling for older adults, is given in Table 4.23.

Table 4.23: Rating factors for bathroom floor slip-resistance scenarios

Scenario order number	Bathroom floor slip-resistance scenarios	Rating factor
1	Bathroom floor has a uniform slip-resistant floor surface for the entire bathroom floor	1.00
3	Bathroom floor has a non-uniform slip-resistant floor surface in any part of the bathroom floor	0.50

4.2.5.2 Feature 2: Bathroom floor height (BFt)

Existence of uneven floor surfaces, such as a step in the middle of the bathroom, has been found to be a hazard within the home environment that may greatly increase the risk of falling for older adults (Carter et al. 1997). In a randomized control trial by Stevens et al. (2001), they have recommended that floor mats be secured along their edges to avoid causing any tripping (Stevens et al. 2001). Tripping floor obstacles caused from non-uniform floor height, such as uneven mat edges or uneven floor surfaces like steps, may cause imbalanced foot placement; this, in turn, causes the risk of a fall to increase exponentially (Carter et al. 1997; Stevens et al. 2001; Haslam and Stubbs 2006). Therefore, the optimal case is a uniform floor height for the entire bathroom without any tripping obstacles. A hierarchical list of the proposed “bathroom floor height” scenarios is shown in Table 4.24.

Table 4.24: Rating factors for bathroom floor height scenarios

Scenario order number	Bathroom floor height scenarios	Rating factor
1	Bathroom floor has a uniform height for the entire bathroom floor	1.00
2	Bathroom floor does not has a uniform height	0.50

4.2.5.3 Feature 3: Bathroom floor entrance clearance (BFc)

The door block schema is the door rotating/moving path that is subtracted from the floor area. This path must be free of obstacles to accommodate safe entrance into or exit from the door opening (Panero and Zelnik 1979). Floor entrance clearance is identified in the form of the door block schema, which must allow an individual to enter and exit the bathroom space safely without any possibility of interference with any of the bathroom fixed objects. The door block schema dimensions and configuration have been identified based on anthropometric considerations with a minimum bathroom door width of 760 mm (Panero and Zelnik 1979; Neufert et al. 2000), as illustrated in Figure 4.11. The door block schema is defined by 90° of rotation of the door (see Figure 4.11A), and a linear path for the pocket door (see Figure 4.11B). A hierarchical list of the proposed “floor entrance clearance” scenarios is illustrated in Table 4.25.

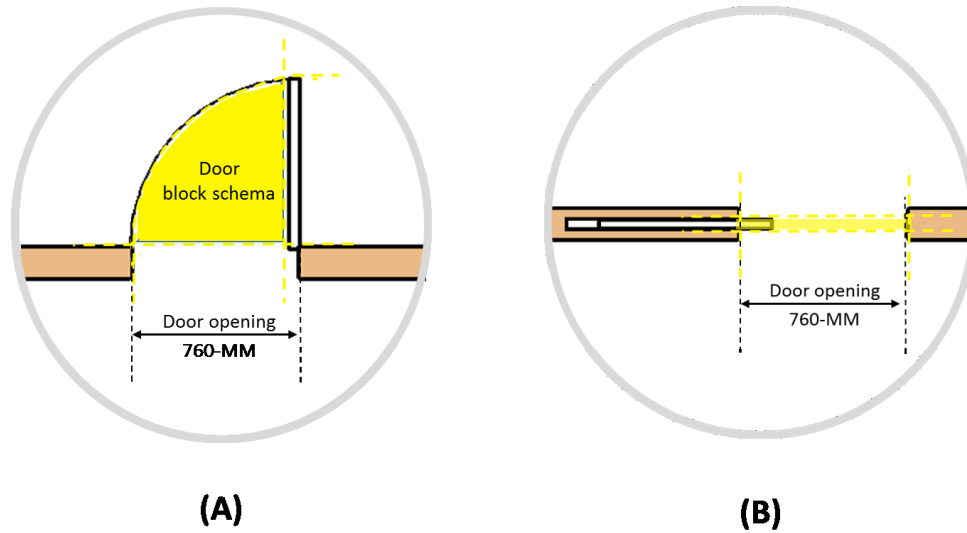

Figure 4.11. (A) Single door block schema; (B) Pocket door block schema.

Table 4.25: Rating factors for floor entrance clearance scenarios

Scenario order number	floor entrance obstacles	Rating factor
1	Door block schema is clear from other fixed object and	1.00
2	Door block schema intersects with a minimum of one other fixed object	0.50

4.3 Assessment Using Mathematical Modelling

4.3.1 Model Algorithm

A flowchart of the assessment algorithm is provided in Figure 4.12. The developed assessment model can be applied for the purpose of interior (bathroom) evaluation

or optimization. To correctly perform the assessment process using the developed mathematical model, the following procedures are followed:

1. Define the bathroom design elements, features, and scenarios through systematic review analysis and DCA implementation;
2. Assign the rating factor (R) associated with each design scenario;
3. Calculate an average rating factor (\bar{R}) for each design element;
4. Calculate a corrective rating number for each element (NC);
5. Calculate an overall total rating number for the bathroom design (NCT); and
6. Assess the bathroom design using the evaluated NC and NCT.

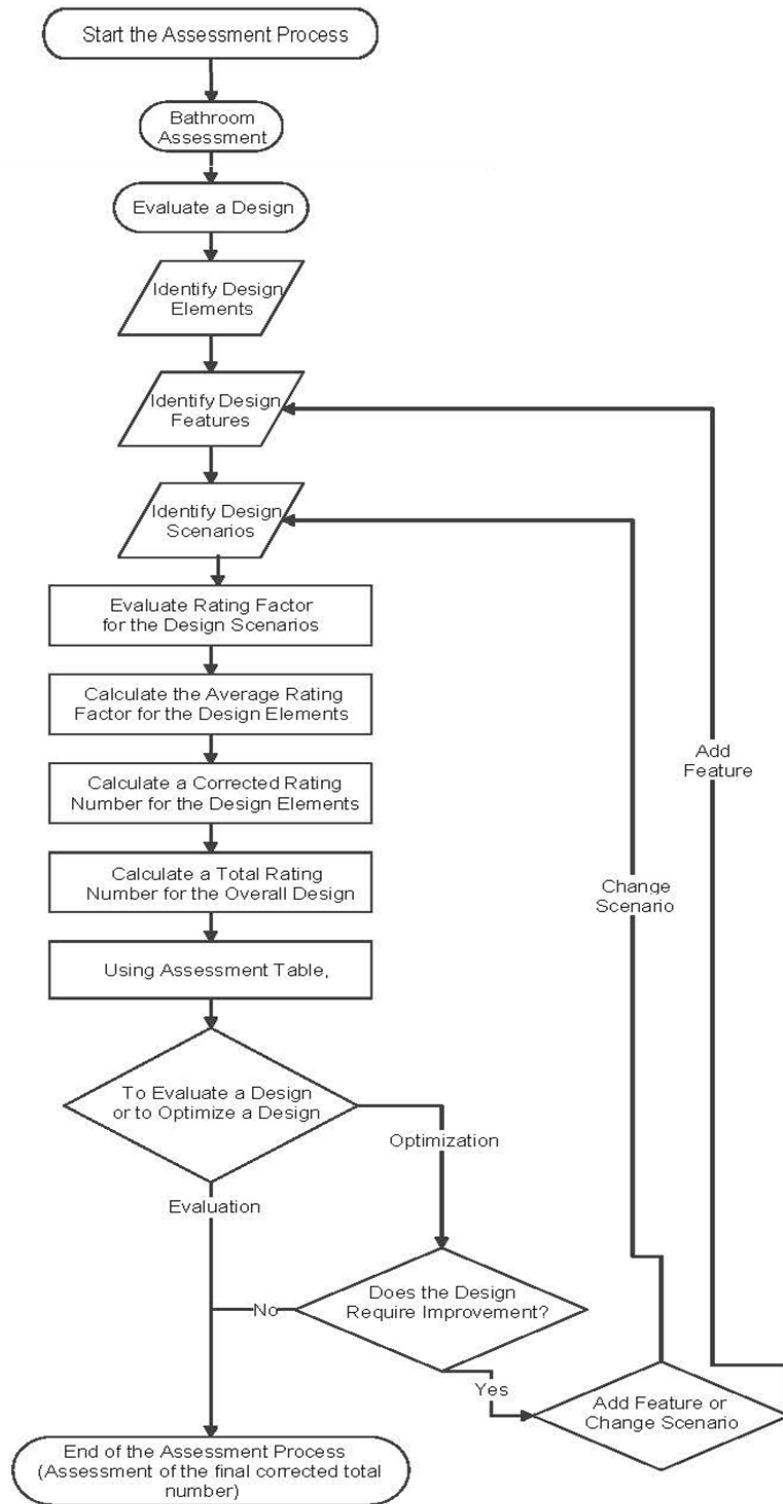

Figure 4.12. Flowchart of the developed mathematical model algorithm.

4.3.2 Mathematical Model for bathroom architectural design

After developing the analysis of design elements and features, a rating factor (R) is assigned to each scenario to represent the risk reduction. For any proposed design, using these hierarchical tables developed in Section 4.2, “Analysis of bathroom design elements and features”, a rating factor (R) is assigned to each bathroom design feature depending on the degree to which the design scenario affects the risk of falling for older adults. In order to assess each design element, an average quantitative rating factor (\bar{R}) is calculated using the assigned feature rating factors to reflect the effect of each proposed element on the risk of falling for older adults. Equations 4.1, 4.2, 4.3, 4.4, and 4.5 are used to calculate the value of \bar{R} for toilet design (BT), bathtub design (BB), bathroom lavatory (BS), bathroom lighting (BL), and bathroom flooring (BF), respectively.

For different bathroom design elements, the values of \bar{R} is calculated using the following equations:

$$\bar{R}(BT) = \left[\frac{R(BT_h) + R(BT_{gc}) + R(BT_{gd}) + R(BT_{gh}) + R(BT_s) + R(BT_b) + R(BT_d)}{7} \right] \dots\dots\dots 4.1$$

where, $\bar{R}(BT)$: is the average rating factor for bathroom toilet design; $R(BT_h)$: is the rating factor for toilet height; $R(BT_{gc})$: is the rating factor for toilet grab-bar configuration; $R(BT_{gd})$: is the rating factor for toilet grab-bar dimensions; $R(BT_{gh})$: is the rating factor for toilet grab-bar height; $R(BT_s)$: is the rating factor for Toilet

supporting equipment; $R(BT_b)$: is the rating factor for toilet block schema; and $R(BT_d)$: is the rating factor for toilet dimensions;

$$\bar{R}(BB) = \frac{R(BB_{gc1}) + R(BB_{gc2}) + R(BB_{gd}) + R(BB_d) + R(BB_s) + R(BB_b) + R(BB_f) + R(BB_c)}{8} \dots\dots\dots 4.2$$

where, $\bar{R}(BB)$: is the average rating factor for bathtub design; $R(BB_{gc1})$: is the rating factor for bathtub grab-bar configuration for the entrance; $R(BB_{gc2})$: is the rating factor for bathtub grab-bar configuration on the back wall; $R(BB_{gd})$: is the rating factor for bathtub grab-bar diameter and surface texture; $R(BB_d)$: is the rating factor for bathtub dimensions; $R(BB_s)$: is the rating factor for bathtub supporting equipment; $R(BB_b)$: is the rating factor for bathtub block schema; $R(BB_f)$: is the rating factor for bathtub flooring; and $R(BB_c)$: is the rating factor for bathtub seat.

$$\bar{R}(BS) = \frac{R(BS_h) + R(BS_s) + R(BS_b)}{3} \dots\dots\dots 4.3$$

where, $\bar{R}(BS)$: is the average rating factor for bathroom lavatory; $R(BS_h)$: is the rating factor for lavatory height; $R(BS_s)$: is the rating factor for lavatory supporting equipments; and $R(BS_b)$: is the rating factor for lavatory block schema;

$$\bar{R}(BL) = \frac{R(BL_l) + R(BL_s) + R(BL_b) + R(BL_n)}{4} \dots\dots\dots 4.4$$

where, $\bar{R}(BL)$: is the average rating factor for bathroom lighting; $R(BL_l)$: is the rating factor for lighting illumination; $R(BL_s)$: is the rating factor for lighting switches; $R(BL_b)$: is the rating factor for lighting balance; and $R(BL_n)$: is the rating factor for lighting night light;

$$\bar{R}(BF) = [R(BF_s) + R(BF_t) + R(BF_c)] / 3 \dots\dots\dots 4.5$$

where, $\bar{R}(BF)$: is the average rating factor for bathroom flooring; $R(BF_s)$: is the rating factor for floor slip-resistance; $R(BF_t)$: is the rating factor for floor tripping obstacles; and $R(BF_c)$: is the rating factor for floor entrance clearance;

Assuming that the optimal bathroom design has an optimal total rating number of 100 points, a number of 20 points is assigned to each one of the five bathroom design elements as an optimal rating number (N_o); N_o thus represents the optimal design for each element. By multiplying \bar{R} and N_o for each element, the resultant corrected rating number (N_c) describes the extent to which each element affects the risk of falling for older adults. N_c for different bathroom design elements can be calculated using Equations 4.6 to 4.10.

$$N_c(BT) = \bar{R}(BT) N_o(BT) \dots\dots\dots 4.6$$

where, $N_c(BT)$: is the corrected rating number for bathroom toilet design; and $N_o(BT)$: is the optimal rating number for bathroom toilet design.

$$N_c(BB) = \bar{R}(BB) N_o(BB) \dots\dots\dots 4.7$$

where, $N_c(BB)$: is the corrected rating number for bathtub design; $N_o(BB)$: is the optimal rating number for bathtub design.

$$N_c(BS) = \bar{R}(BS) N_o(BS) \dots\dots\dots 4.8$$

where, $N_c(BS)$: is the corrected rating number for bathroom lavatory; and $N_o(BS)$: is the optimal rating number for bathroom lavatory.

$$N_c(BL) = \bar{R}(BL) N_o(BL) \dots\dots\dots 4.9$$

where, $N_c(BL)$: is the corrected rating number for bathroom lighting; and $N_o(BL)$: is the optimal rating number for bathroom lighting.

$$N_c(BF) = \bar{R}(BF) N_o(BF) \dots\dots\dots 4.10$$

where, $N_c(BF)$: is the corrected rating number for bathroom flooring; and $N_o(BF)$: is the optimal rating number for bathroom flooring. For equally weighted 5 bathroom elements, $N_o(BT)$, $N_o(BB)$, $N_o(BS)$, $N_o(BL)$ and $N_o(BF)$ are equal to 20 points.

The total overall bathroom design rating number (N_{CT}) is calculated by adding together all the corrected rating numbers (N_C) for the five elements, as illustrated in Equation 4.11.

$$N_{CT} = N_C(BT)+N_C(BB)+N_C(BS)+N_C(BL)+N_C(BF) \dots\dots\dots 4.11$$

4.4 Generalized Equation of the Assessment Mathematical

Model

The previously developed mathematical model of the assessment mathematical model can be generalized to assess any design space that contains any number of design elements and features. The generalized equation of each element average rating factor (\bar{R}) can be stated as shown in Equation 4.12

$$\bar{R}(Y)=\left(\sum_{i=1}^n R(X_i)\right)/n \dots\dots\dots 4.12$$

where i is a counting index for the features in the element; Y is an index for the element symbol; X_i is an index for the feature symbol; $\bar{R}(Y)$ is the average rating factor (\bar{R}) for element “ Y ”; $R(X_i)$ is the rating factor (R) for feature “ X_i ”; and n is the number of features in the element “ Y ”.

For each design element, the generalized equation to calculate the corrective rating number can be written as follows:

$$N_c(Y) = \bar{R}(Y) N_o(Y) \dots\dots\dots 4.13$$

where $N_c(Y)$ is the corrected rating number (N_c) for element “Y”, and $N_o(Y)$ is the optimal rating number (N_o) for element “Y”. $N_o(Y)$ is calculated using Equation 4.14.

$$N_o(Y) = 100/S \dots\dots\dots 4.14$$

where S is the total number of the space design elements.

The total rating number of the space design (N_{CT}) is calculated using the generic formula represented in Equation 4.15.

$$N_{CT} = \sum_{i=1}^S N_c(Y_i) \dots\dots\dots 4.15$$

where i is a summation counting index, $N_c(Y_i)$ is the corrected rating number (N_c) for element “ Y_i ”, and S is the total number of elements in the bathroom design; in this case, S is equal to five for bathroom design.

4.5 Ordinal/Equal-Interval Scaling Assessment Tables

4.5.1 Generalized Equations of Assessment Limits

For each element, in order to scale and assess the calculated values of the average rating factor (\bar{R}) and the corrected rating number (N_c) as well as the total rating

number (N_{CT}) for overall design, related scaling limits must be identified. The first scaling limits are the ranging limits of \bar{R} : (1) the maximum average rating factor (\bar{R}_{max}), and (2) the minimum average rating factor (\bar{R}_{min}). \bar{R}_{max} and \bar{R}_{min} can be calculated using Equations 4.16 and 4.17, respectively. By applying Equations 4.18 and 4.19, another set of scaling limits can be identified as the limits of N_C for each element: (1) the maximum corrected rating number (N_{Cmax}), and (2) the minimum corrected rating number (N_{Cmin}), respectively. The scaling limits of N_{CT} can be calculated using Equations 4.20 and 4.21.

$$\bar{R}_{max}(Y) = \left(\sum_{i=1}^n R_{max}(X_i) \right) / n \dots\dots\dots 4.16$$

where $\bar{R}_{max}(Y)$ is the maximum average rating factor (\bar{R}_{max}) for element “Y”, and $R_{max}(X_i)$ is the maximum rating factor (R_{max}) for feature “ X_i ”. As $R_{max}(X_i)$ is always equal to 1, $\bar{R}_{max}(Y)$ is equal to 1 for all design elements.

$$\bar{R}_{min}(Y) = \left(\sum_{i=1}^n R_{min}(X_i) \right) / n \dots\dots\dots 4.17$$

where $\bar{R}_{min}(Y)$ is the minimum average rating factor (\bar{R}_{min}) for element “Y”, and $R_{min}(X_i)$ is the minimum rating factor (R_{min}) for feature “ X_i ”. The values of R_{min} for each feature are represented in the hierarchical lists in Section 4.2.

$$N_{Cmax}(Y) = \bar{R}_{max}(Y) N_o(Y) \dots\dots\dots 4.18$$

where $N_{Cmax}(Y)$ is the maximum corrected rating number (N_{Cmax}) for design element, “Y”. $\bar{R}_{max}(Y)$ is always equal to one; therefore, $N_{Cmax}(Y)$ is always equal to $N_O(Y)$.

$$N_{Cmin}(Y) = \bar{R}_{min}(Y) N_O(Y) \dots\dots\dots 4.19$$

where $N_{Cmin}(Y)$ is the minimum corrected rating number (N_{Cmin}) for design element, “Y”.

$$N_{CTmax} = \sum_{i=1}^S N_{Cmax}(Y_i) \dots\dots\dots 4.20$$

where N_{CTmax} is the maximum total rating number, and $N_{Cmax}(Y_i)$ is the maximum corrected rating number (N_{Cmax}) for element, “ Y_i ”. N_{CTmax} is always equal to 100.

$$N_{CTmin} = \sum_{i=1}^S N_{Cmin}(Y_i) \dots\dots\dots 4.21$$

where N_{CTmin} is the minimum total rating number, and $N_{Cmin}(Y_i)$ is the minimum corrected rating number (N_{Cmin}) for element “ Y_i ”.

4.5.2 Equal-Interval-Ordinal Assessment Tables for Bathroom Design

By applying the equal interval scale on the ranges $\bar{R}_{max} - \bar{R}_{min}$, $N_{Cmax} - N_{Cmin}$, and $N_{CTmax} - N_{CTmin}$, sub-equal interval ranges were generated within these maximum

and minimum values. These ranges can be evaluated to assess the extent to which the elements and the overall design of the bathroom affect the risk of falling for older adults (Saaty 2008; Afifi et al. 2014). The generated sub-equal interval ranges were developed to represent five levels of ordinal scale: optimal design, strong design, moderate design, under-moderate design, and weak design. Tables 4.26, 4.27, and 4.28 represent the developed equal-interval-ordinal assessment for a bathroom's different design elements. As the developed equal-interval ranges of \bar{R} were the same for both the toilet element design and bathtub element design, the corresponding values were represented by the same ordinal scale as shown in Table 4.26. Similarly, the interval ranges of \bar{R} for both the lavatory element design and flooring element design were the same as shown in Table 4.27. Table 4.29 represents the developed equal-interval-ordinal assessment for a bathroom's overall design.

Table 4.26: Assessment table for toilet element design (BT) and bathtub element design (BB)

Design designation	\bar{R} range (Equal interval scale)	Corresponding N_c range	Explanation (Ordinal scale)
Optimal Design	$1.0 \geq \bar{R} > 0.83$	$20 \geq N_c > 16.6$	The risk of falling for older adults is optimally reduced (Optimal design)
Strong Design	$0.83 \geq \bar{R} > 0.66$	$16.6 \geq N_c > 13.2$	The risk of falling for older adults is strongly reduced (Strong design)
Moderate Design	$0.66 \geq \bar{R} > 0.49$	$13.2 \geq N_c > 9.8$	The risk of falling for older adults is moderately reduced (Moderate design)
Under-Moderate Design	$0.49 \geq \bar{R} > 0.32$	$9.8 \geq N_c > 6.4$	The risk of falling for older adults is promoted (Under-moderate design)
Weak Design	$0.32 \geq \bar{R}$	$6.4 \geq N_c$	The risk of falling for older adults is highly promoted (Weak design)

Table 4.27: Assessment table for lavatory element design (BS) and bathroom flooring element design (BF)

Design designation	\bar{R} (Equal interval scale)	Corresponding N_C range	Explanation (Ordinal scale)
Optimal Design	$1.0 \geq \bar{R} > 0.98$	$20 \geq N_C > 17.6$	The risk of falling for older adults is optimally reduced (Optimal design)
Strong Design	$0.98 \geq \bar{R} > 0.76$	$17.6 \geq N_C > 15.2$	The risk of falling for older adults is strongly reduced (Strong design)
Moderate Design	$0.76 \geq \bar{R} > 0.64$	$15.2 \geq N_C > 12.8$	The risk of falling for older adults is moderately reduced (Moderate design)
Under-Moderate Design	$0.64 \geq \bar{R} > 0.52$	$12.8 \geq N_C > 10.4$	The risk of falling for older adults is promoted (Under-moderate design)
Weak Design	$0.52 \geq \bar{R}$	$10.4 \geq N_C$	The risk of falling for older adults is highly promoted (Weak design)

Table 4.28: Assessment table for bathroom lighting element (BL)

Design designation	\bar{R} (Equal interval scale)	Corresponding N_c range	Explanation (Ordinal scale)
Optimal Design	$1.0 \geq \bar{R} > 0.96$	$20 \geq N_c > 17.2$	The risk of falling for older adults is optimally reduced (Optimal design)
Strong Design	$0.96 \geq \bar{R} > 0.82$	$17.2 \geq N_c > 14.4$	The risk of falling for older adults is strongly reduced (Strong design)
Moderate Design	$0.82 \geq \bar{R} > 0.68$	$14.4 \geq N_c > 11.6$	The risk of falling for older adults is moderately reduced (Moderate design)
Under-Moderate Design	$0.68 \geq \bar{R} > 0.44$	$11.6 \geq N_c > 8.8$	The risk of falling for older adults is promoted (Under-moderate design)
Weak Design	$0.44 \geq \bar{R}$	$8.8 \geq N_c$	The risk of falling for older adults is highly promoted (Weak design)

Table 4.29: Assessment table for bathroom total rating number (N_{CT})

Design designation	N_{CT} range (Equal interval scale)	Explanation (Ordinal scale)
Optimal Design	$100 \geq N_{CT} > 85$	The risk of falling for older adults is optimally reduced (Optimal design)
Strong Design	$85 \geq N_{CT} > 70$	The risk of falling for older adults is strongly reduced (Strong design)
Moderate Design	$70 \geq N_{CT} > 55$	The risk of falling for older adults is moderately reduced (Moderate design)
Under-Moderate Design	$55 \geq N_{CT} > 40$	The risk of falling for older adults is promoted (Under-moderate design)
Weak Design	$40 \geq N_{CT}$	The risk of falling for older adults is highly promoted (Weak design)

4.6 Characterization of the Developed Mathematical Assessment

Model

4.6.1 Bathroom Assessment Model Characterization

4.6.1.1 Model output data analysis

All possible R-values of each feature and the corresponding optimal N_C values for each element are calculated under the assumption of having the optimal design

scenario for the rest of the element features (i.e., $R = 1$ for the rest of the features), and they are illustrated in Table 4.30. On the other hand, Table 4.31 shows the corresponding minimal N_C values for each element, assuming the weakest design scenario exists for the rest of the element features. The data in Table 4.30 demonstrates that, by increasing the number of features for each design element, the effect of reducing the R-value of a single feature on the calculated optimal N_C of the element is reduced.

For example, at R equal to 0.0 for an element with 7 features, such as the toilet grab-bar dimensions (BT_{gd}), the value of the optimal N_C for the bathroom toilet element (BT) is equal to 17.1 out of 20; while, for an element with three features, such as the bathroom lavatory (BS), the optimal N_C is equal to 16.7 at R equal to 0.50. This can be attributed to the fact that the value of N_C for each element depends on the average value of R of that element's features. Therefore, by increasing the number of element's features that have an R-value of 1.0, the effect of reducing the R-value for a single feature on N_C is minimized. Contrary to the data in Table 4.30, the values represented in Table 4.31 utilizing the same elements and features demonstrate that the effect of reducing the value of R on the calculated minimal N_C is increased by increasing the number of features for each element. This is due to the fact that the remaining R-values, used to calculate the minimal N_C for the element, are assumed to be the minimum R-values (R_{min}) of the other features in the same element.

Table 4.30: Alternative values of R scenarios for each feature and the corresponding optimal N_c of the element calculated at maximum R for remaining element features

Element Symbol	Feature Symbol	Alternative R scenarios And corresponding optimal N _c *							
		R	N _c	R	N _c	R	N _c	R	N _c
BT Bathroom: Toilet design	BT _h : Toilet height	1	20	0.50	18.6	-	-	-	-
	BT _{gc} : Toilet Grab-bar conf.	1	20	0.50	18.6	0.00	17.1	-	-
	BT _{gd} : Toilet Grab-bar dim.	1	20	0.67	19.1	0.33	18.1	0.00	17.1
	BT _{gh} : Toilet Grab-bar height	1	20	0.67	19.1	0.33	18.1	0.00	17.1
	BT _s : Toilet supporting equi.	1	20	0.50	18.6	-	-	-	-
	BT _b : Toilet block schema	1	20	0.50	18.6	-	-	-	-
	BT _d : Toilet dimension	1	20	0.50	18.6	-	-	-	-
BB Bathroom: Bathtub design	BB _{gc1} : bathtub grab-bar conf.1	1	20	0.67	19.2	0.33	18.3	0.00	17.5
	BB _{gc2} : bathtub grab-bar conf.2	1	20	0.67	19.2	0.33	18.3	0.00	17.5
	BB _{gd} : bathtub grab-bar diam.	1	20	0.67	19.2	0.33	18.3	0.00	17.5
	BB _d : bathtub dimension	1	20	0.50	18.8	-	-	-	-
	BB _s : bathtub supporting equi.	1	20	0.50	18.8	-	-	-	-
	BB _b : bathtub block schema	1	20	0.50	18.8	-	-	-	-
	BB _f : bathtub flooring	1	20	0.75	19.4	0.50	18.8	0.25	18.1
BB _c : bathtub seat	1	20	0.50	18.8	-	-	-	-	
BS Bathroom: Lavatory	BS _h : lavatory height	1	20	0.50	16.7	-	-	-	-
	BS _s : lavatory supporting equi.	1	20	0.50	16.7	-	-	-	-
	BS _b : lavatory block schema	1	20	0.50	16.7	-	-	-	-
BL Bathroom: Lighting	BL _i : lighting illumination	1	20	0.67	18.4	0.33	16.7	-	-
	BL _s : lighting switches	1	20	0.67	18.4	0.33	16.7	-	-
	BL _b : lighting balance	1	20	0.50	17.5	-	-	-	-
	BL _n : lighting night light	1	20	0.50	17.5	-	-	-	-
BF Bathroom: Floor	BF _s : floor slip-resistance	1	20	0.50	16.7	-	-	-	-
	BF _t : floor height	1	20	0.50	16.7	-	-	-	-
	BF _c : floor entrance clearance	1	20	0.50	16.7	-	-	-	-

* R is the rating factor for the design feature; N_c is the corrective rating number for the element.

Table 4.31: Alternative values of R scenarios for each feature and the corresponding minimal N_C of the element calculated at minimum R for remaining element features

Element Symbol	Feature Symbol	Alternative R scenarios And the corresponding optimal N _C							
		R	N _C	R	N _C	R	N _C	R	N _C
BT Bathroom: Toilet design	BT _h : Toilet height	1	7.1	0.5 0	5.7	-	-	-	-
	BT _{gc} : Toilet Grab-bar conf.	1	8.6	0.5 0	7.1	0.0 0	5. 7	-	-
	BT _{gd} : Toilet Grab-bar dim.	1	8.6	0.6 7	7.6	0.3 3	6. 7	0.0 0	5. 7
	BT _{gh} : Toilet Grab-bar height	1	8.6	0.6 7	7.6	0.3 3	6. 7	0.0 0	5. 7
	BT _s : Toilet supporting equi.	1	7.1	0.5 0	5.7	-	-	-	-
	BT _b : Toilet block schema	1	7.1	0.5 0	5.7	-	-	-	-
	BT _d : Toilet dimension	1	7.1	0.5 0	5.7	-	-	-	-
BB Bathroom: Bathtub design	BB _{gc1} : bathtub grab-bar conf.1	1	8.1	0.6 7	7.3	0.3 3	6. 5	0.0 0	5. 6
	BB _{gc2} : bathtub grab-bar conf.2	1	8.1	0.6 7	7.3	0.3 3	6. 5	0.0 0	5. 6
	BB _{gd} : bathtub grab-bar diam.	1	8.1	0.6 7	7.3	0.3 3	6. 5	0.0 0	5. 6
	BB _d : bathtub dimension	1	6.9	0.5 0	5.6	-	-	-	-
	BB _s : bathtub supporting equi.	1	6.9	0.5 0	5.6	-	-	-	-
	BB _b : bathtub block schema	1	6.9	0.5 0	5.6	-	-	-	-
	BB _f : bathtub flooring	1	7.5	0.7 5	6.9	0.5 0	6. 3	0.2 5	5. 6
BB _c : bathtub seat	1	6.9	0.5 0	5.6	-	-	-	-	
BS Bathroom: Lavatory	BS _h : lavatory height	1	13. 3	0.5 0	10. 0	-	-	-	-
	BS _s : lavatory supporting equi.	1	13. 3	0.5 0	10. 0	-	-	-	-
	BS _b : lavatory block schema	1	13. 3	0.5 0	10. 0	-	-	-	-
BL Bathroom:	BL _i : lighting illumination	1	11. 7	0.6 7	10. 0	0.3 3	8. 3	-	-

Lighting	BL _s : lighting switches	1	11. 7	0.6 7	10. 0	0.3 3	8. 3	-	-
	BL _b : lighting balance	1	10. 8	0.5 0	8.3	-	-	-	-
	BL _n : lighting night light	1	10. 8	0.5 0	8.3	-	-	-	-
BF Bathroom: Floor	BF _s : floor slip-resistance	1	13. 3	0.5 0	10. 0	-	-	-	-
	BF _t : floor height	1	13. 3	0.5 0	10. 0	-	-	-	-
	BF _c : floor entrance clearance	1	13. 3	0.5 0	10. 0	-	-	-	-

* R is the rating factor for the design feature; N_c is the corrected rating number for the element.

4.6.2 Scatter Analysis of the Output Data

For the toilet element (BT), the data in Table 4.30 is plotted on a graphic representation; this, in turn, reveals a perfect linear relationship, as shown in Figure 4.13. To evaluate the linear relationship illustrated in Figure 4.13, Pearson's product-moment coefficient (P_m) is applied. This coefficient measures the departure of two numerically valued variables from being independent or dependent on each other (Pestman and Alberink 1998; Lomax 2001; Stamatis 2001). Equation 4.22 is used to determine P_m (Spiegel 1992).

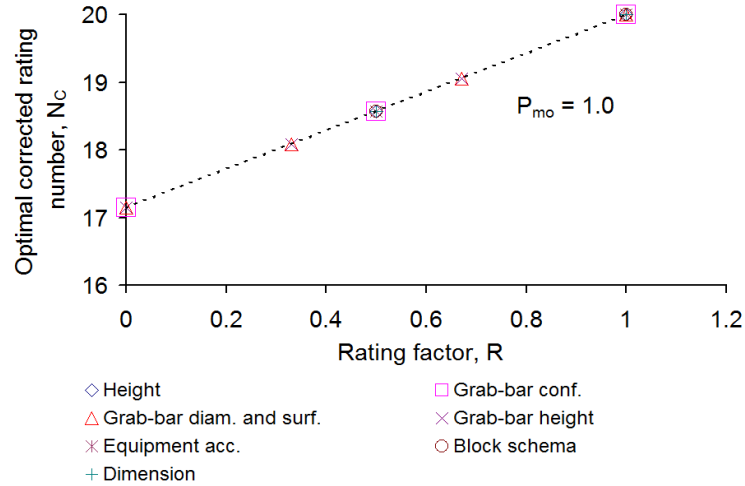

Figure 4.13. The optimal N_c values for Toilet/Water Closet (BT) at different R values of: toilet height (BT_h), toilet grab-bar configuration (BT_{gc}), toilet grab-bar diameter and surface texture (BT_{gd}), toilet grab-bar height (BT_{gh}), toilet supporting equipment and accessories (BT_s), toilet block schema (BT_b), and toilet dimensions (BT_a).

$$P_m(x,y) = \frac{\sum_{i=1}^n (x_i - \bar{x})(y_i - \bar{y})}{\sqrt{\sum_{i=1}^n (x_i - \bar{x})^2 \sum_{i=1}^n (y_i - \bar{y})^2}} \dots\dots\dots 4.22$$

where P_m is Pearson's product-moment coefficient for parameters x and y , n is the number of readings, \bar{x} is the mean value of parameter x readings, \bar{y} is the mean value of parameter y readings, x_i is counting number i for parameter x , and y_i is counting number i for parameter y .

The perfect correlation between two parameters is when P_m takes the value of 1.0; alternatively, a perfect inverse correlation is obtained at P_m value of -1.0. When P_{pm} is equal to 0.0, there is no correlation between the evaluated two parameters. For the linear relationship between the optimal N_C and R points represented in Figure 4.13, the Pearson's product-moment coefficient (P_{mo}) is equal to 1.0, which denotes a perfect linear correlation. This is due to the fact that at any R-value for any feature, the remaining R-values used to calculate the optimal N_C are always assumed to be 1.0 (i.e., the rest of the features are assumed to have an optimal design to achieve maximum reduction in the risk of falling for older adults).

For the minimal N_C represented in Table 4.31, the plotted minimal N_C and R relationship points are scattered, (i.e., they do not form a perfect linear relationship), as shown in Figure 4.14 for the Toilet/Water Closet (BT). This can be attributed to the fact the minimum R-values of the features within each element are not the same, which is a result of applying the equal interval scale on the feature's scenarios. However, due to the fact that the average rating factor (\bar{R}) is the variable used to calculate N_C , the effect of the variation in the minimum values of R is minimized. Therefore, the minimal N_C and R relationship can still be represented in a linear form with a high Pearson's product-moment coefficient (P_{mm}) equal to 0.85, as shown in Figure 4.14. This ensures the ability of the developed mathematical assessment model that incorporate the equal interval scale to effectively assess bathroom design.

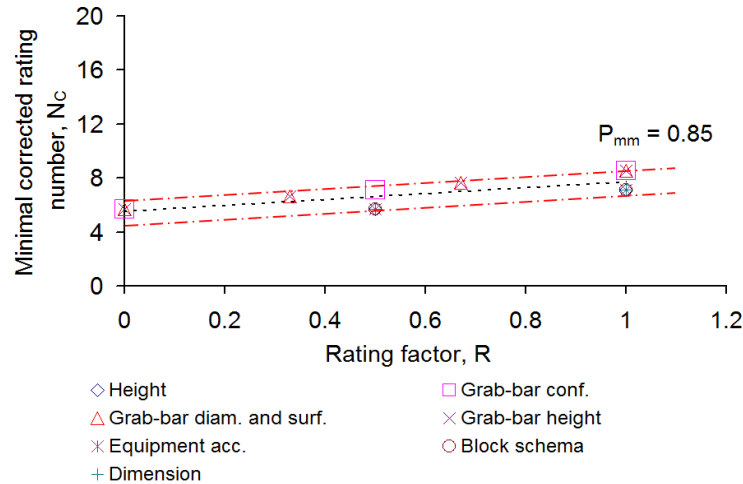

Figure 4.14. The minimal N_C values for Toilet/Water Closet (BT) at different R values of: toilet height (BT_h), toilet grab-bar configuration (BT_{gc}), toilet grab-bar diameter and surface texture (BT_{gd}), toilet grab-bar height (BT_{gh}), toilet supporting equipment and accessories (BT_s), toilet block schema (BT_b), and toilet dimensions (BT_a). The red lines are to represent the scatter band of the plotted data points for minimal N_C

The optimal and the minimal N_C boundaries can be identified as the linear boundaries from Figures 4.13 and 4.14. These boundaries identify a scatter-band/plotting-range that contains all possible N_C values for Toilet (BT), as shown in Figure 4.15. The number of scenarios, as well as the number of features, is the same for the bathroom lavatory (BS) and the bathroom flooring (BF); as such, the two can be represented in one figure (Figure 4.16).

The minimal N_C plotted points in Figure 4.16 form a perfect linear relationship, resulting from the minimum values of R (R_{min}) having the same number (i.e., 0.50)

for all features. The boundaries of N_C for bathtub design (BB) are shown in Figure 4.17, while the N_C boundaries for the bathroom lighting (BL) are shown in Figure 4.18.

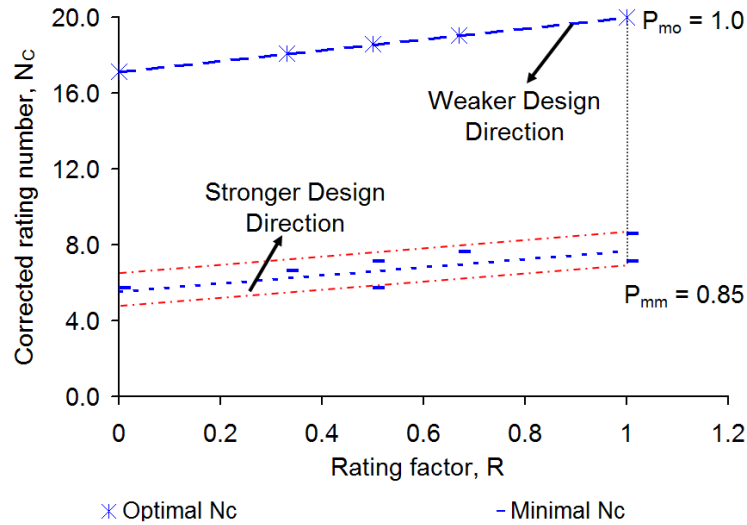

Figure 4.15. Scatter-band/plotting-range of N_C values for Toilet/Water Closet (BT). The red lines represent the scatter band of the plotted data points for minimal N_C . The vertical dotted line is the boundary of R

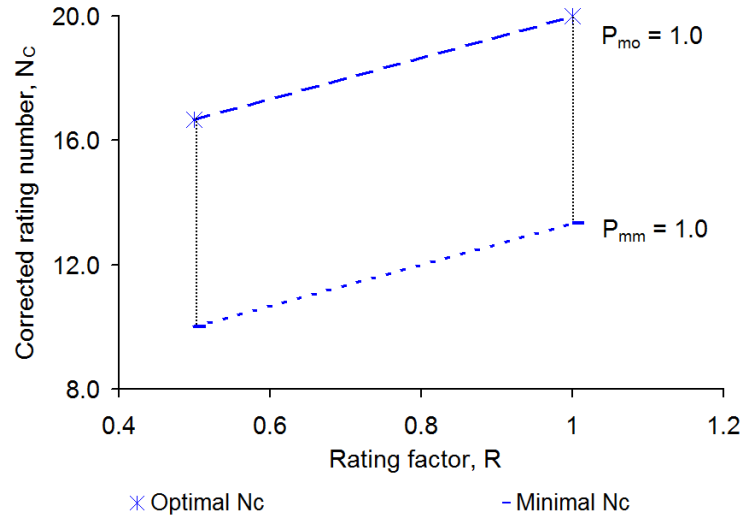

Figure 4.16. Scatter-band/plotting-range of N_C values for lavatory (BS) and flooring (BF)

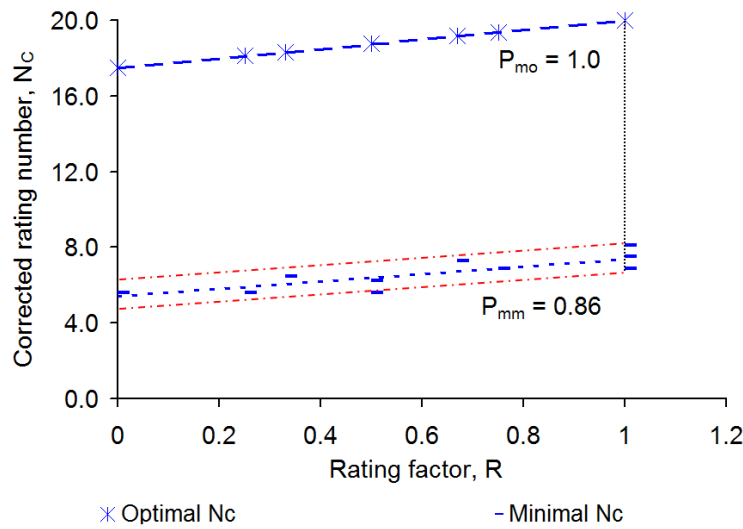

Figure 4.17. Scatter-band/plotting-range of N_C values for bathtub design (BB). The red lines represent the scatter band of the plotted data points for minimal N_C . The vertical dotted line is the boundary of R

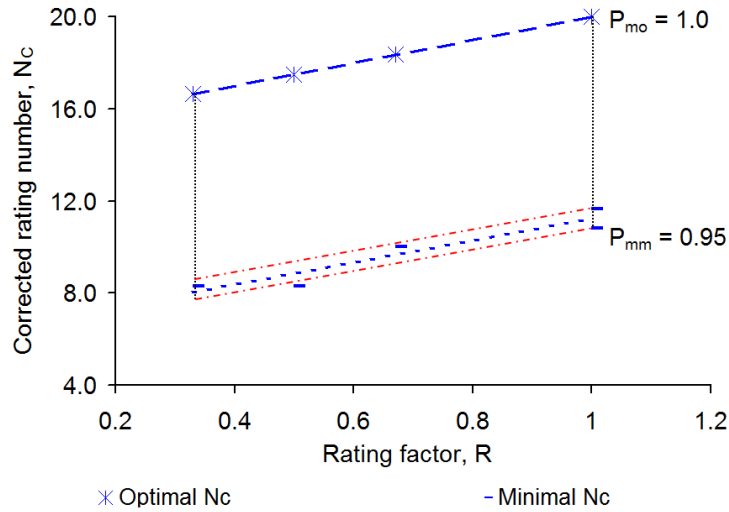

Figure 4.18. Scatter-band/plotting-range of N_C values for bathtub lighting (BL). The red lines represent the scatter band of the plotted data points for minimal N_C . The vertical dotted line is the boundary of R

There are four main equations, Equations 4.23-4.26, that define the N_C boundaries illustrated in Figures 4.15-4.18. Using the linear regression analysis, the constants that define Equations 4.23-4.26 are represented in Table 4.32.

$$R_r = \alpha \dots\dots\dots 4.23$$

where R_r is the maximum R-value (i.e., R_{max} of the feature, or the right vertical boundary), and α is a constant.

$$R_l = \beta \dots\dots\dots 4.24$$

where R_l is the minimum R-value, (i.e., R_{min} of the feature, or the vertical left boundary), and β is a constant.

$$N_{Copt} = \chi + \delta R \dots\dots\dots 4.25$$

where N_{Copt} is the optimal N_C value forming the upper boundary, and χ and δ are constants.

$$N_{Cmin} = \varepsilon + \eta R \dots\dots\dots 4.26$$

where N_{Cmin} is the minimal N_C value forming the lower boundary, and ε and η are constants.

Table 4.32: Optimized values of the constants in Equations 4.23-4.26 for different bathroom design elements

Design element	Constant Estimated Value					
	α	B	χ	δ	ε	η
Toilet/Water Closet (BT)	1.00	0.00	-5.94	0.35	-1.20	0.30
Bathtub Design (BB)	1.00	0.00	-6.98	0.40	-1.46	0.31
Bathroom Lavatory (BS)	1.00	0.50	-2.03	0.15	-1.02	0.15
Bathroom Lighting (BL)	1.00	0.33	-3.05	0.20	-1.17	0.19
Bathroom Flooring (BF)	1.00	0.50	-2.03	0.15	-1.02	0.15

4.7 Verification and Validation of the Developed Assessment

Model

The verification process of the assessment model are branched into two phases: (1) development phase at which the verification is achieved through developing the hierarchal list of different design scenarios based on an evidence-based systematic review; and (2) post development phase at which verification is achieved through a test run that will be executed to assess a practical design case and trace the model capability to detect the design improvement in this case. Regarding model validation, two existing case studies have been evaluated using the assessment system. The results are then validated through a focus group discussion with number of experts in field.

4.7.1 Model Test Run Verification

The developed assessment model is implemented using a practical case study of bathroom design to be evaluated. This practical case study has been developed based on an existing bathroom design from Landmark Group of Companies, a homebuilder based in Edmonton, Canada. The assessment is conducted from the perspective of reducing the risk of falling for older adults. The bathroom design of the implemented case study is then improved to a modified bathroom design which has a higher rating associated with a lower risk of falling for older adults.

4.7.1.1 Assessment of case study using the mathematical model

The proposed bathroom design, illustrated in Figure 4.19, is for a full home bathroom design, including lavatory, toilet, and bathtub. The bathroom has the following specifications: a toilet height of 420 mm; no toilet grab-bar installed; a toilet paper disposal receptacle which is not accessible; toilet depth and width of 690 mm x 360 mm; no grab-bar installed to support bathtub entrance/exit; a grab-bar installed in the back wall of the bathtub with diameter of 40 mm; bathtub dimensions of 1,524 mm (length) x 750 mm (width) x 480 mm (height); bathtub seat not installed; a slippery floor and rim surface in bathtub; bathtub and lavatory supporting equipment is accessible; lavatory height is 900 mm; bathroom illumination level ≤ 300 -lux; bathroom lavatory illumination level for task lighting ≤ 600 -lux; shaded area is created around the lavatory; bathroom lighting switch is situated inside the bathroom door and is difficult to reach; no night-light is installed; and bathroom floor has non-slip floor mats and uneven mat edges.

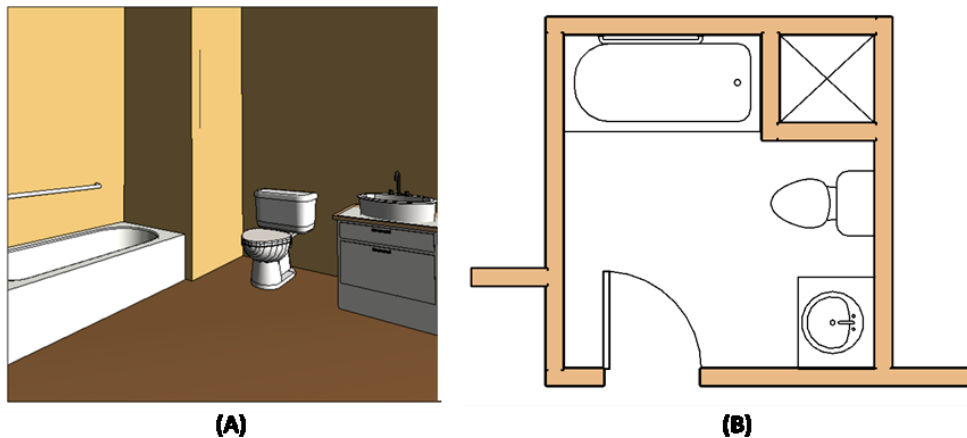

Figure 4.19. (A) Perspective of the proposed case study bathroom design. (B)

Floor plan for the proposed case study.

The following Tables (4.33, 4.34, 4.35, 4.36, and 4.37) illustrate: (1) the different features under each design element; (2) the R-values for all design features; and (3) the tables used to obtain values of R.

Table 4.33: Features of bathroom toilet/water closet element (BT)

Feature No.	Feature	Feature symbol	Proposed design	Rating factor (R)	Table used to obtain (R)
1	Toilet height	BT _h	BT _h = 420 mm	0.50	Table 4.1
2	Toilet grab-bar configuration	BT _{gc}	No grab-bar installed	0.00	Table 4.2
3	Toilet grab-bar diameter and surface texture	BT _{gd}	No grab-bar installed	0.00	Table 4.3
4	Toilet grab-bar height	BT _{gh}	No grab-bar installed	0.00	Table 4.4
5	Toilet supporting equipment accessibility	BT _s	Toilet paper disposal receptacle is not easy to reach without assuming an exaggerated body position	0.50	Table 4.5

6	Toilet block schema	BT _b	Toilet block schema is clear from all other fixed object, as illustrated in Figure 4.20	1.00	Table 4.6
7	Toilet dimension	BT _d	Toilet depth and width = 690 mm x 360 mm	0.50	Table 4.7

Table 4.34: Features of bathroom bathtub element (BB)

Feature No.	Feature	Feature symbol	Proposed design	Rating factor (R)	Table used to obtain (R)
1	Bathtub grab-bar configuration for the entrance	BB _{gc1}	No grab-bar installed to support bathtub entrance/exit	0.00	Table 4.8
2	Bathtub grab-bar configuration installed in back wall	BB _{gc2}	BB _{gc2} = (1,200 mm in length, 200 mm above the rim)	1.00	Table 4.9
3	Bathtub grab-bar diameter and surface texture	BB _{gd}	BB _{gd} = 40 mm	1.00	Table 4.10
4	Bathtub dimensions	BB _d	BB _d = 1,524 mm (length) x 750 mm (width) x 480 mm (height)	1.00	Table 4.11

5	Bathtub seat	BB _c	Bathtub seat is not installed	1.00	Table 4.12
6	Bathtub block schema	BB _b	Bathtub block schema is clear from all other fixed objects, as illustrated in Figure 4.20	1.00	Table 4.13
7	Bathtub flooring and surface	BB _f	Bathtub has a slippery floor and rim surface	0.25	Table 4.14
8	Bathtub supporting equipment accessibility	BB _s	Bathtub supporting equipment is easy to reach without exaggerating body position	1.00	Table 4.15

Table 4.35: Features of bathroom lavatory element (BV)

Feature No.	Feature	Feature symbol	Proposed design	Rating factor (R)	Table used to obtain (R)
1	Lavatory height	BV _h	BV _h = 900 mm	1.00	Table 4.16
2	Lavatory supporting items accessibility	BV _s	Lavatory supporting items is easy to reach without exaggerating the body position	1.00	Table 4.17
3	Lavatory block schema	BV _b	Lavatory block schema is clear from all other fixed object, as illustrated in Figure 4.20	1.00	Table 4.18

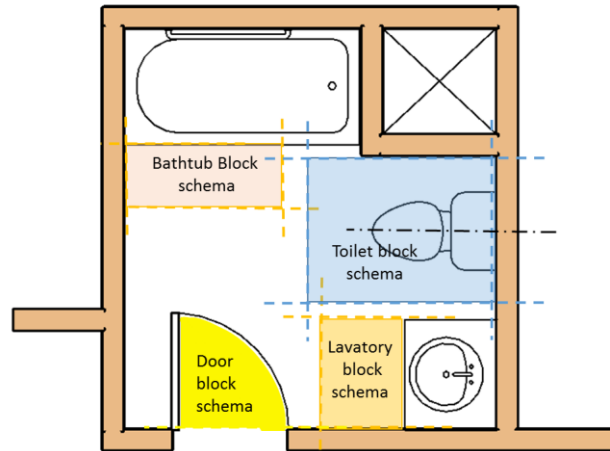

Figure 4.20. Block schema-related assessment. Toilet, bathtub, lavatory, and door block schema are clear from any interference.

Table 4.36: Features of bathroom lighting element (BL)

Feature No.	Feature	Feature symbol	Proposed design	Rating factor (R)	Table used to obtain (R)
1	Illumination level	BL _l	Illumination level \leq 300-lux, and Illumination level for task lighting \leq 600-lux	0.33	Table 4.19
2	Lighting switches	BL _s	Bathroom lighting switch situated inside the bathroom door, and it is difficult to reach	0.33	Table 4.20
3	Balance of lighting within the space	BL _b	Bathroom lighting is not balanced; shaded area created	0.50	Table 4.21
4	Night-light	BL _n	No night-light installed	0.50	Table 4.22

Table 4.37: Features of bathroom floor element (BF)

Feature No.	Feature	Feature symbol	Proposed design	Rating factor (R)	Table used to obtain (R)
1	Bathroom floor slip-resistance	BF _s	Bathroom floor has non-uniform slip-resistant floor surface: non-slip floor mats	0.50	Table 4.23
2	Bathroom floor height	BF _t	Floor height is uneven: uneven mat edges	0.50	Table 4.24
3	Bathroom floor entrance clearance	BF _c	Door block schema is clear from all other fixed object	1.00	Table 4.25

The average rating factor (\bar{R}) for bathroom toilet/water closet element (BT) is calculated by satisfying Equation 4.12 as follows:

$$\bar{R}(BT) = (0.5 + 0.0 + 0.0 + 0.0 + 0.5 + 1.0 + 0.5)/7 = 0.36 \dots\dots\dots 4.27$$

The average rating factor (\bar{R}) for the bathroom bathtub element (BB) is calculated by satisfying Equation 4.12 as follows:

$$\bar{R}(BB) = (0.0 + 1.0 + 1.0 + 1.0 + 1.0 + 1.0 + 0.25 + 1.0)/8 = 0.78 \dots\dots 4.28$$

The average rating factor (\bar{R}) for the bathroom lavatory element (BV) is calculated by satisfying Equation 4.12 as follows:

$$\bar{R}(BV) = (1.0 + 1.0 + 1.0) / 3 = 1.0 \dots\dots\dots 4.29$$

The average rating factor (\bar{R}) for the bathroom lighting element (BL) is calculated by satisfying Equation 4.12 as follows:

$$\bar{R}(BL) = (0.33 + 0.33 + 0.50 + 0.50) / 4 = 0.42 \dots\dots\dots 4.30$$

The average rating factor (\bar{R}) for the bathroom floor element (BF) is calculated by satisfying Equation 4.12 as follows:

$$\bar{R}(BF) = (0.5 + 0.5 + 1.0) / 3 = 0.67 \dots\dots\dots 4.31$$

The corrected rating number for the bathroom toilet/water closet element (BT) is calculated by satisfying Equation 4.13 as follows:

$$N_c(BT) = \bar{R}(BT) N_o(BT) = 0.36 * 20 = 7.2 \dots\dots\dots 4.32$$

The corrected rating number for the bathroom toilet/water closet element ($N_c(BT)$) is 7.2; from Table 4.26, this means that the risk of falling for older adults is under-moderate (Under-moderate design) for the associated design element.

The corrected rating number for the bathroom bathtub element (BB) is calculated satisfying Equation 4.13 as follows:

$$N_c(H) = \bar{R}(BB) N_o(BB) = 0.78 * 20 = 15.6 \dots\dots\dots 4.33$$

The corrected rating number for the bathroom bathtub element ($N_c(BB)$) is 15.6; from Table 4.26, this means that the risk of falling for older adults is strongly reduced (strong design) for the associated design element.

The corrected rating number for the bathroom lavatory element (BV) is calculated by satisfying Equation 4.13 as follows:

$$N_c(BV) = \bar{R}(BV) N_o(BV) = 1.0 * 20 = 20 \dots\dots\dots 4.34$$

The corrected rating number for the bathroom lavatory element ($N_c(BV)$) is 20; from Table 4.27, this means that the risk of falling for older adults is optimally reduced (optimal design) for the associated design element.

The corrected rating number for the bathroom lighting element (BL) is calculated by satisfying Equation 4.13 as follows:

$$N_c(BL) = \bar{R}(BL) N_o(BL) = 0.42 * 20 = 8.4 \dots\dots\dots 4.35$$

The corrected rating number for the bathroom lighting element ($N_c(BL)$) is 8.4; from Table 4.28, this means that the risk of falling for older adults is increased (weak design) for the associated design element.

The corrected rating number for the bathroom floor element (BF) is calculated by satisfying Equation 4.13 as follows:

$$N_c(BF) = \bar{R}(BF) N_o(BF) = 0.67 * 20 = 13.4 \dots\dots\dots 4.36$$

The corrected rating number for the bathroom floor element ($N_c(BF)$) is 13.4; from Table 4.27, this means that the risk of falling for older adults is moderate design for the associated element.

The general rating number (N_{CT}) for the whole bathroom architectural design is calculating by satisfying Equation 4.15 as follows:

$$\begin{aligned}
 N_{CT} &= N_c(BT)+N_c(BB)+N_c(BV)+N_c(BL)+N_c(BF) \dots\dots\dots 4.37 \\
 &= 7.2+15.6+20+8.4+13.4 = 64.6
 \end{aligned}$$

The N_{CT} total rating number of the proposed bathroom architectural design, is 64.6; from Table 4.29, this means that the risk of falling for older adults is moderately reduced (Moderate design) for the overall architectural design of the proposed bathroom.

4.7.1.2 Improvement of case study using the mathematical model

Since the previous overall rating for the case bathroom’s architectural design is found to be under-moderate design, the proposed case study is subjected to improvements. In order to modify the proposed design to reduce the risk of falling for older adults, the hierarchical list tables in Section 4.2 are used to upgrade each design scenario to a higher possible rated scenario based on the proposed design and space limitations. For example, in order to modify the interference of the door and lavatory block schemas, a major design change of shifting a wall is required. Major design changes of this magnitude are not considered. However, the toilet

grab-bar installation does not require a major design change, and is therefore considered. Application of the mathematical assessment model to the modified design serves to assess the improved design.

The bathroom case study's architectural specifications are improved as outlined in Tables 4.38, 4.39, 4.40, 4.41, and 4.42 (see Figure 4.21). These specifications illustrated how the mathematical assessment model is utilized to modify and improve the design of the bathroom. The following is a summary of the modifications: (1) a specialized bathroom toilet seat is installed, so the total toilet height becomes 490 mm; (2) one horizontal grab-bar is installed (500 mm in length) to suit the space design; the diameter of the installed grab-bar is 40 mm, and it is located at 950 mm height; (3) the toilet paper disposal receptacle is relocated to a more accessible location; (4) a bathtub grab-bar with a length of 1,200 mm is installed 200 mm above the tub rim at the back of the bathtub; (5) the bathtub and rim surface are modified using uniform non-slip material; (6) bathroom lighting fixtures are upgraded to an illumination level for ambient lighting ≥ 300 -lux and an illumination level for tasking lighting ≥ 600 -lux; (7) the bathroom lighting switches are still situated inside the bathroom door; however, the location of the switch is adjusted to make it easier to reach; (8) a night-light is installed; and (9) non-slip floor mats are installed to ensure the bathroom floor has a uniform slip-resistant floor surface; these mats have even edges to ensure that the floor height is even.

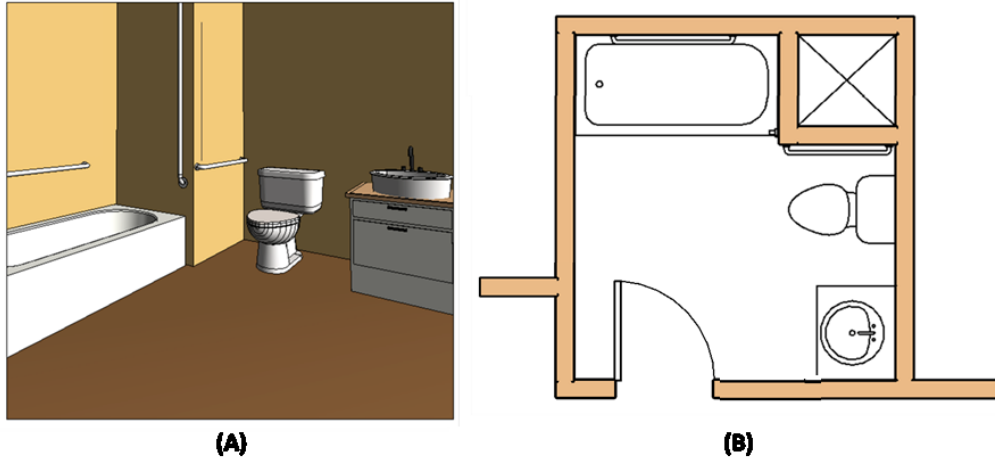

**Figure 4.21. (A) Perspective of the improved case study of bathroom design.
(B) Floor plan for the improved case study.**

Table 4.38: Features of bathroom toilet/water closet element (BT)

Feature No.	Feature	Feature symbol	Proposed design	Rating factor (R)	Table used to obtain (R)
1	Toilet height	BT _h	BT _h = 490 mm, toilet seat is installed	1.00	Table 4.1
2	Toilet grab-bar configuration	BT _{gc}	One horizontal grab-bar installed (500 mm in length)	0.50	Table 4.2
3	Toilet grab-bar diameter and surface texture	BT _{gd}	BT _{gd} = 40 mm	1.00	Table 4.3
4	Toilet grab-bar height	BT _{gh}	BT _{gh} = 950 mm	1.00	Table 4.4

5	Toilet supporting equipment accessibility	BT _s	Toilet paper disposal receptacle is accessible	1.00	Table 4.5
6	Toilet block schema	BT _b	Toilet block schema is clear from all other fixed object, as illustrated in Figure 4.20	1.00	Table 4.6
7	Toilet dimensions	BT _d	Toilet depth and width = (690x360) mm	0.50	Table 4.7

Table 4.39: Features of bathroom bathtub element (BB)

Feature No.	Feature	Feature symbol	Proposed design	Rating factor (R)	Table used to obtain (R)
1	Bathtub grab-bar configuration for the entrance	BB _{gc1}	BB _{gc1} = (1,200 mm in length vertical grab-bar, mounted at 200 mm above the rim)	1.00	Table 4.8
2	Bathtub grab-bar configuration installed in back wall	BB _{gc2}	BB _{gc2} = (1,200 mm in length, 200 mm above the rim)	1.00	Table 4.9
3	Bathtub grab-bar diameter and surface texture	BB _{gd}	BB _{gd} = 40 mm	1.00	Table 4.10

4	Bathtub dimensions	BB _d	BB _d = 1,524 mm (L) x 750 mm (W) x 480 mm (H)	1.00	Table 4.11
5	Bathtub seat	BB _c	Bathtub seat is not installed	1.00	Table 4.12
6	Bathtub block schema	BB _b	Bathtub block schema is clear from all other fixed object, as illustrated in Figure 4.20	1.00	Table 4.13
7	Bathtub flooring and surface	BB _f	Bathtub has a uniform non-slip floor and rim surface	1.00	Table 4.14
8	Bathtub supporting equipment accessibility	BB _s	Bathtub supporting equipment is easy to reach without exaggerating body position	1.00	Table 4.15

Table 4.40: Features of bathroom lavatory element (BV)

Feature No.	Feature	Feature symbol	Proposed design	Rating factor (R)	Table used to obtain (R)
1	Lavatory height	BV _h	BV _h = 900 mm	1.00	Table 4.16
2	Lavatory supporting items accessibility	BV _s	Lavatory supporting items is easy to reach without exaggerating body position	1.00	Table 4.17
3	Lavatory block schema	BV _b	Lavatory block schema is clear from all other fixed object, as illustrated in Figure 4.20	1.00	Table 4.18

Table 4.41: Features of bathroom lighting element (BL)

Feature No.	Feature	Feature symbol	Proposed design	Rating factor (R)	Table used to obtain (R)
1	Illumination level	BL _l	Illumination level for ambient lighting ≥ 300 -lux And illumination level for task lighting ≥ 600 -lux	1.00	Table 4.19
2	Lighting switches	BL _s	Bathroom lighting switch situated inside the bathroom door, and it is easy to reach	0.67	Table 4.20
3	Balance of lighting within the space	BL _b	Bathroom lighting is not balanced; shaded area created	0.50	Table 4.21
4	Night-light	BL _n	Night-light installed	1.00	Table 4.22

Table 4.42: Features of bathroom floor element (BF)

Feature No.	Feature	Feature symbol	Proposed design	Rating factor (R)	Table used to obtain (R)
1	Bathroom floor slip-resistance	BF _s	Bathroom floor has uniform slip-resistant floor surface: non-slip floor mats installed	1.00	Table 4.23
2	Bathroom floor height	BF _t	Floor height is even: mat edges are even	1.00	Table 4.24
3	Bathroom floor entrance clearance	BF _c	Door block schema is clear from all other fixed object	1.00	Table 4.25

The average rating factor (\bar{R}) for the bathroom toilet/water closet element (BT) is calculated by satisfying Equation 4.12 as follows:

$$\bar{R}(\text{BT}) = (1.0 + 0.5 + 1.0 + 1.0 + 1.0 + 1.0 + 0.5)/7 = 0.86 \dots\dots\dots 4.38$$

The average rating factor (\bar{R}) for the bathroom bathtub element (BB) is calculated by satisfying Equation 4.12 as follows:

$$\bar{R}(\text{BB}) = (1.0 + 1.0 + 1.0 + 1.0 + 1.0 + 1.0 + 1.0 + 1.0)/8 = 1.0 \dots\dots\dots 4.39$$

The average rating factor (\bar{R}) for the bathroom lavatory element (BV) is calculated by satisfying Equation 4.12 as follows:

$$\bar{R}(\text{BV}) = (1.0 + 1.0 + 1.0)/3 = 1 \dots\dots\dots 4.40$$

The average rating factor (\bar{R}) for the bathroom lighting element (BL) is calculated by satisfying Equation 4.12 as follows:

$$\bar{R}(\text{BL}) = (1.0 + 0.67 + 0.50 + 1.0)/4 = 0.79 \dots\dots\dots 4.41$$

The average rating factor (\bar{R}) for the bathroom floor element (BF) is calculated by satisfying Equation 4.12 as follows:

$$\bar{R}(\text{BF}) = (1.0 + 1.0 + 1.0)/3 = 1.0 \dots\dots\dots 4.42$$

The corrected rating number for the bathroom toilet/water closet element (BT) is calculated by satisfying Equation 4.13 as follows:

$$N_c(BT) = \bar{R}(BT) N_o(BT) = 0.86 * 20 = 17.2 \dots\dots\dots 4.43$$

The corrected rating number for the bathroom toilet/water closet element ($N_c(BT)$) is 17.2. From Table 4.26, this means that the risk of falling for older adults is improved from under-moderate design to optimal design for the associated design element, entailing that the improved design optimally reduces the risk of falling for older adults.

The corrected rating number for the bathroom bathtub element (BB) is calculated by satisfying Equation 4.13 as follows:

$$N_c(H) = \bar{R}(BB) N_o(BB) = 1.0 * 20 = 20 \dots\dots\dots 4.44$$

The corrected rating number for the bathroom bathtub element ($N_c(BB)$) is 20. From Table 4.26, this means that the risk of falling for older adults is improved from under-moderate design to optimal design for the associated design element, entailing that the improved design optimally reduces the risk of falling for older adults.

The corrected rating number for the bathroom lavatory element (BV) is calculated by satisfying Equation 4.13 as follows:

$$N_c(BV) = \bar{R}(BV) N_o(BV) = 1.0 * 20 = 20 \dots\dots\dots 4.45$$

The corrected rating number for the bathroom lavatory element ($N_c(BV)$) is 20. From Table 4.27, this means that the risk of falling for older adults is optimally reduced (optimal design) for the associated design element.

The corrected rating number for the bathroom lighting element (BL) is calculated by satisfying Equation 4.13 as follows:

$$N_c(BL) = \bar{R}(BL) N_o(BL) = 0.79 * 20 = 15.8 \dots\dots\dots 4.46$$

The corrected rating number for the bathroom lighting element ($N_c(BL)$) is 15.8. From Table 4.28, this means that the risk of falling for older adults is improved from weak design to strong design for the associated design element, entailing that the improved design strongly reduces the risk of falling for older adults.

The corrected rating number for the bathroom floor element (BF) is calculated by satisfying Equation 4.13 as follows:

$$N_c(BF) = \bar{R}(BF) N_o(BF) = 1.0 * 20 = 20 \dots\dots\dots 4.47$$

The corrected rating number for the bathroom floor element ($N_c(BF)$) is 20. From Table 4.27, this means that the risk of falling for older adults is improved from moderate design to optimal design for the associated design element, entailing that the improved design optimally reduces the risk of falling for older adults.

The total rating number (N_{CT}) for the whole bathroom architectural design is calculating by satisfying Equation 4.15 as follows:

$$N_{CT} = N_c(BT) + N_c(BB) + N_c(BV) + N_c(BL) + N_c(BF) \dots\dots\dots 4.48$$

$$= 17.2 + 20 + 20 + 15.8 + 20 = 93$$

N_{CT} , the total rating number of the proposed improved bathroom architectural design is 93. From Table 4.29, this means that the risk of falling for older adults is improved from moderate design to optimal design for the associated design element, entailing that the improved design optimally reduces the risk of falling for older adults.

4.7.2 Validation of the Developed Assessment Model

The focus group technique was implemented in this research to gather expert opinion based on two existing bathroom case studies extracted from Landmark Group of Companies. The two developed bathroom case studies were first rated based on the developed assessment system. Then, printed materials and power point slides were developed describing the specifications of each element of each case of bathroom design. A focus group of four experts with a minimum of ten years of experience in the field of design for older adults were selected to participate in the focus group discussion. One of the participants was from Alberta Health Service specializing in older care, the other three participants were professional architects with specialized experience (each with no less than ten years of experience) in housing for older adults and housing for people with physical and mental

disabilities. The experts had no previous knowledge of the assessment output generated using developed assessment model.

The focus group discussion were managed as follows: (1) welcoming and a brief introduction about the research in addition to an illustration of the importance of their participation to the research; (2) the process of the focus group technique was explained and each participant was encouraged to be part of the discussion. Supporting material was also provided, which included the specifications for the two bathroom case studies; (3) opinions of experts on each element specifications were systematically discussed. The experts were then asked to provide a rating number on a scale similar to the one used in the assessment system that reflects the expert assessment for each design element as well as the assessment of the overall design of each case. The focus group discussion was then concluded. The expert opinion was compared to the outcome of the developed assessment system in order to validate to which level the developed system outcome is compatible with the expert opinions.

4.7.2.1 Design specifications of case studies

Bathroom floor plans and bathroom lighting for case study number one are illustrated in Figure 4.22 and Figure 4.23. Bathroom architectural specifications for case study number one are illustrated in Tables 4.43, 4.44, 4.45, 4.46, and 4.47. Bathroom floor plans and bathroom lighting for case study number two are

illustrated in Figure 4.24. Bathroom architectural specifications for case study number two are illustrated in Tables 4.48, 4.49, 4.50, 4.51, and 4.52.

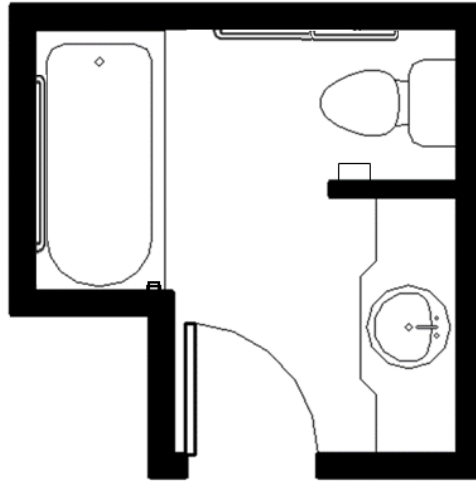

Figure 4.22. Floor plan for case study number 1.

Table 4.43: Features of bathroom toilet/water closet element (BT)

Feature No.	Feature	Feature symbol	Case #1
1	Toilet height	BT_h	$BT_h = 480$ mm, toilet seat is installed, LLL is 470mm
2	Toilet grab-bar configuration	BT_{gc}	<p>diagonal grab-bar (45° angle, 1,220 mm in length , 500 mm away from perpendicular wall), and horizontal grab-bar (500 mm, and 300 mm away from the perpendicular wall)</p> <p>The diagram shows a side view of a toilet. A diagonal grab-bar is attached to the wall at a 45° angle. Its length is 1,220 mm. The distance from the wall to the end of the diagonal bar is 500 mm. A horizontal grab-bar is also shown, with a length of 500 mm and a distance of 300 mm from the wall to its end. The toilet is shown in profile, and the floor is indicated by a thick brown line at the bottom.</p>

3	Toilet grab-bar diameter and surface texture	BT _{gd}	BB _{gd} = 40 mm, Smooth
4	Toilet grab-bar height	BT _{gh}	BT _{gh} for horizontal grab bar = 980 mm BT _{gh} for vertical grab bar = 760 mm
5	Toilet supporting equipment accessibility	BT _s	Toilet paper disposal is easy to reach without extra body bending or exaggerating body position.
6	Toilet block schema	BT _b	Toilet block schema is clear from any other fixed object
7	Toilet dimension	BT _d	Toilet depth ranges from 700 mm, and toilet width ranges from 460 mm

Table 4.44: Features of bathroom bathtub element (BB)

Feature No.	Feature	Feature symbol	Case #1
1	Bathtub grab-bar configuration for the entrance	BB _{gc1}	BB _{gc1} = (1,200 mm in length vertical grab-bar, mounted at 200 mm above the rim)
2	Bathtub grab-bar configuration installed in back wall	BB _{gc2}	BB _{gc2} = (1,200 mm in length horizontal grab-bar, 200 mm above the rim)



3	Bathtub grab-bar diameter and surface texture	BB _{gd}	BB _{gd} = 40 mm, Smooth
4	Bathtub dimensions	BB _d	Bathtub length ranges from 1,450 mm, width ranges from 715 mm, and height ranges from 420 mm
5	Bathtub seat	BB _c	Bathtub seat is not installed
6	bathtub block schema	BB _b	bathtub block schema is clear from other fixed objects
7	bathtub flooring surface	BB _f	Bathtub floor has a uniform non-slip surface, and non-slip rim/edges
8	Bathtub supporting equipment accessibility	BB _s	Bathtub supporting equipment is easy to reach without extra body bending or exaggerating body position?

Table 4.45: Features of bathroom lavatory element (BV)

Feature No.	Feature	Feature symbol	Case #1
1	Lavatory height	BS _h	BS _h = 800 mm
2	Lavatory supporting items accessibility	BS _s	Frequently used lavatory items are easy to reach without exaggerating body position
3	Lavatory block schema	BS _b	Lavatory block schema is clear from all other fixed object

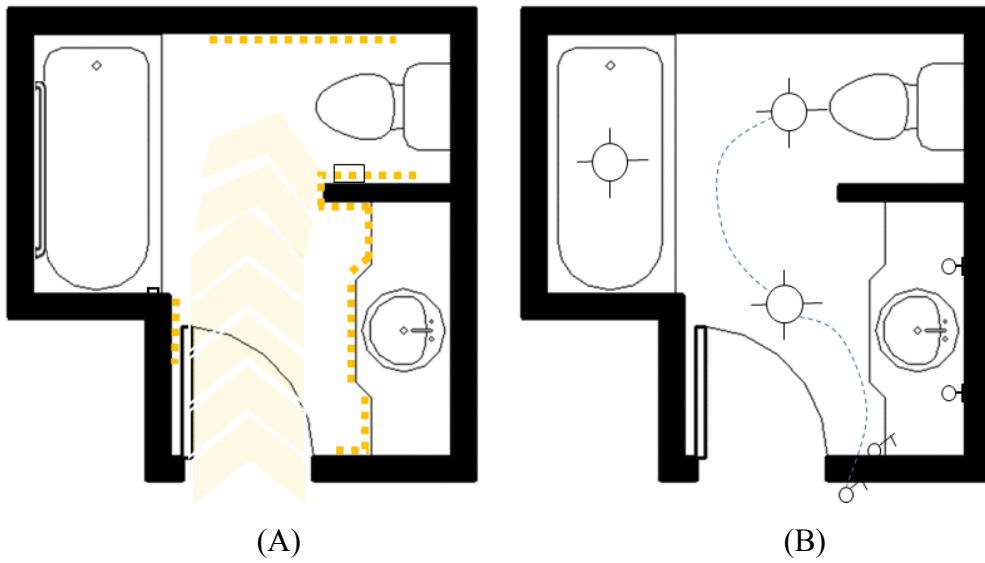

**Figure 4.23. (A) Floor plan shows the night light for case study number 1;
 (B) floor plan shows the lighting fixture for case study number 1**

Table 4.46: Features of bathroom lighting element (BL)

Feature No.	Feature	Feature symbol	Case #1
1	Illumination level	BL _l	Illumination level ≥ 300 -lux, and Illumination level for task lighting ≥ 600 -lux
2	Lighting switches	BL _s	Bathroom lighting switch situated outside the bathroom door
3	Balance of lighting within the space	BL _b	Bathroom lighting is not balanced. Shaded areas are created.
4	Night-light	BL _n	Night light installed (see Figure 4.23(A))

Table 4.47: Features of bathroom floor element (BF)

Feature No.	Feature	Feature symbol	Case #1
1	Bathroom floor slip-resistance	BF _s	Bathroom floor has a non-uniform slip-resistant floor surface in any part of the bathroom floor
2	Bathroom floor height	BF _t	Bathroom floor has a uniform height for the entire bathroom floor
3	Bathroom floor entrance obstacles	BF _c	Door block schema is clear from other fixed object and

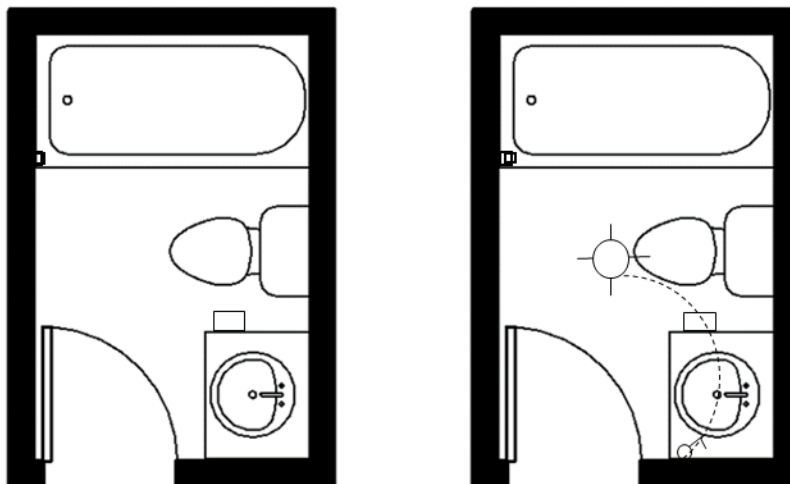

Figure 4.24. (A) Floor plan for case study number 2; (B) floor plan shows the lighting fixture for case study number 2

Table 4.48: Features of bathroom toilet/water closet element (BT)

Feature No.	Feature	Feature symbol	Case #2
1	Toilet height	BT _h	BT _h = 400 mm, toilet seat is installed, LLL is 470mm
2	Toilet grab-bar configuration	BT _{gc}	No grab-bar
3	Toilet grab-bar diameter and surface texture	BT _{gd}	No grab-bar
4	Toilet grab-bar height	BT _{gh}	No grab-bar
5	Toilet supporting equipment accessibility	BT _s	Toilet paper disposal is easy to reach without extra body bending or exaggerating body position.
6	Toilet block schema	BT _b	Toilet block schema is clear from any other fixed object
7	Toilet dimensions	BT _d	Toilet depth is 700 mm, and toilet width is 460 mm

Table 4.49: Features of bathroom bathtub element (BB)

Feature No.	Feature	Feature symbol	Case #2
1	Bathtub grab-bar configuration for the entrance	BB _{gc1}	No grab-bar
2	Bathtub grab-bar configuration installed in back wall	BB _{gc2}	No grab-bar
3	Bathtub grab-bar diameter and surface texture	BB _{gd}	No grab-bar
4	Bathtub dimensions	BB _d	Bathtub length is 1,450 mm, width is 715 mm, and height is 420 mm
5	Bathtub seat	BB _c	Bathtub seat is installed
6	bathtub block schema	BB _b	bathtub block schema is clear from other fixed objects
7	bathtub flooring surface	BB _f	Bathtub has a slippery floor surface and rim/edge surface
8	Bathtub supporting equipment accessibility	BB _s	Bathtub supporting equipment is easy to reach without extra body bending or exaggerating body position.

Table 4.50: Features of bathroom lavatory element (BV)

Feature No.	Feature	Feature symbol	Case #2
1	Lavatory height	BS _h	BS _h = 800 mm
2	Lavatory supporting items accessibility	BS _s	Frequently used lavatory items are easy to reach without exaggerating body position
3	Lavatory block schema	BS _b	Lavatory block schema is clear from all other fixed object

Table 4.51: Features of bathroom lighting element (BL)

Feature No.	Feature	Feature symbol	Case #2
1	Illumination level	BL _l	Illumination level \leq 300-lux, Illumination level for task lighting \leq 600-lux
2	Lighting switches	BL _s	Bathroom lighting switch situated inside the bathroom door, and it is difficult to reach.
3	Balance of lighting within the space	BL _b	Bathroom lighting is not balanced. Shaded area created.
4	Night-light	BL _n	No night-light not installed

Table 4.52: Features of bathroom floor element (BF)

Feature No.	Feature	Feature symbol	Case #2
1	Bathroom floor slip-resistance	BF _s	Bathroom floor has a non-uniform slip-resistant floor surface in any part of the bathroom floor
2	Bathroom floor height	BF _t	Bathroom floor does not has a uniform height
3	Bathroom floor entrance obstacles	BF _c	Door block schema is clear from other fixed object and

4.7.2.2 Assessment of developed case studies

The outcomes of the experts' evaluations and the research assessment are shown in Table 4.53. For case number one, by applying the assessment Tables 4.26, 4.27, 4.28, and 4.29, the outcomes of the developed system and the focus group fall under the same assessment category as follows:

1. Optimal design for toilet bathroom design (NC range: $20 \geq N_C > 16.6$);
 2. Optimal design for bathtub design (NC range: $20 \geq N_C > 16.6$);
 3. Strong design for lavatory design (NC range: $17.6 \geq N_C > 15.2$);
 4. Optimal design for bathroom lighting (NC range: $20 \geq N_C > 17.2$);
 5. Strong design for bathroom flooring (NC range: $17.6 \geq N_C > 15.2$);
- and

6. Optimal design for overall bathroom design (N_{CT} range: $100 \geq N_{CT} > 85$).

For case number two, a similar observation of the compatibility between the outcomes of the assessment system and the results of the focus group is identified in Table 4.53. From Tables 4.26, 4.27, 4.28, and 4.29, the assessment categories found for case number two are as follows:

1. Moderate design for toilet bathroom design (NC range: $13.2 \geq NC > 9.8$);
2. Under-moderate design for bathtub design (NC range: $9.8 \geq NC > 6.4$);
3. Strong design for lavatory design (NC range: $17.6 \geq NC > 15.2$);
4. Weak design for bathroom lighting (NC range: $8.8 \geq NC$);
5. Moderate design for bathroom flooring (NC range: $15.2 \geq NC > 12.8$);
and
6. Moderate design for overall bathroom design (NCT range: $70 \geq NCT > 55$).

As a result, the developed assessment system is successfully validated through being compatible with the outcome of the focus group.

Table 4.53: Features of bathroom floor element (BF)

Bathroom Elements	Expert evaluation		Research assessment	
	Case #1	Case #2	Case #1	Case #2
Toilet design (20)	17	12	18.57	10.00
Bathtub design (20)	18	7	18.75	9.37
Lavatory design (20)	16	16	16.67	16.67
Lighting (20)	18	5	17.50	8.30
Flooring (20)	17	14	16.67	13.33
Overall rating (100)	90	60	88.15	57.67

CHAPTER 5: CONCLUSION

5.1 Research Conclusions

An evidence-based assessment system was developed in this research in order to quantitatively assess architectural home design from the perspective of evaluating the risk of falling associated with bathroom design. The developed evidence-based quantitative assessment was represented through a mathematical model to promote the design assessment procedures to be incorporated efficiently within building information modelling (BIM) to support elderly-friendly design. An evidence-based systematic review was conducted in order to create a database that encompasses relevant evidence-based studies for both bathroom design in relation to the risk of falling for older adults.

The divide and conquer algorithm (DCA) conceptual approach was applied in order to study and analyze the outcomes of the systematic review. Based on the developed DCA, bathroom design was divided into elements and associated features. Each feature was then divided into a number of design scenarios that represent various design alternatives for the given feature. New fundamental concepts were introduced in order to facilitate the evaluation process, such as the concept of Block Schema (BS). Based on the systematic review, scenarios for each feature were ordinally arranged according to the associated risk of falling. Using an equal-interval scaling system, a rating factor scale was developed to quantitatively represent the risk of falling associated with each design scenario.

Sets of constitutive equations were developed by which to construct a mathematical assessment model. The developed mathematical model was used to generate a corrected rating number (N_C) associated with each element, reflecting the risk of falling associated with the design. A total rating number (N_{CT}) was also calculated using the mathematical model to reflect the risk of falling associated with the overall design of the bathroom.

A set of assessment tables was generated using both ordinal and equal interval scaling in order to assess both N_C and N_{CT} from the perspective of reducing the risk of falling for older adults. A comprehensive analysis was conducted to characterize the limits and ranges of the mathematical model. A graphical representation was developed to illustrate the model characteristics and limits associated with each element. A family of generalized equations was then developed, from the graphical boundary representations, to mathematically identify the boundaries limits of the mathematical model. Using linear regression analysis, the constants of the developed equations were then optimized to fully identify the boundary equation of the mathematical model.

5.2 Research limitations

The methodology described in this research involves the retrieval of evidence-based specifications for home design, and provides an assessment approach that can be implemented based on user requests. The retrieved studies are limited to evidence-based studies for home bathroom in relation to falls. This research has investigated

five bathroom elements: toilet, bathtub, sink, lighting, and flooring. A quantitative assessment system has been proposed with the assumption of equal interval scaling, as yet to be determined is the degree to which the risk of falling can be reduced. However, further experimental research can be conducted to determine the possibility of having different interval values to assess the risk of falling for older adults.

The proposed research methodology can be implemented for a proposed draft design or for an existing design. The implementation at the draft design stage is limited in terms of architects' knowledge of the proposed assessment system in identifying the optimal case scenarios for each bathroom feature and the other possible scenarios. For example, if an architect is proposing a limited space design for bathroom to be applied in a home design for older adults, if the architect is aware of the proposed design assessment for the "toilet block schema" feature, they can modify the design easily in the early stages to allow for more space for the bathroom, in order to reduce the risk of falling for older adults. It is therefore recommended that the information in this research be integrated into a building code for older adult residential facilities.

Regarding implementation of the proposed assessment system, there is a lack of awareness among older adults of the importance of home modifications to reduce the risk of falling, which is a potential limitation of this research. Community and family support may be required to raise the level of awareness among older adults, so that they are open to effective home modifications that will reduce the risk of falling. In terms of modifications to the existing design, the limitations of the

current space, structure, and budget must be considered as well. For example, if the toilet does not have an attached side wall, the options for grab-bar installations are limited based on the space limitations. Therefore, in practice, a space limitation might not permit optimal modification of the bathroom. A better alternative might be chosen from the proposed scenarios which better suits the existing space design. Structural limitations may not allow for installing additional task lighting in the optimal location. In such a case, other lower rated alternative scenarios may be considered in order to promote an age-friendly living environment. Additionally, budget limitations might allow for compensating between design features based on the associated costs.

5.3 Research Contributions

This research provides a number of contributions for the academic research paradigm; listed as follows:

1. The research framework generates an inter-disciplinary approach in both architecture and gerontology by creating an applicable linkage between the latest achievement in science and the best practice that enhance safely for older adults.
2. This research provide a utilized tool for architects, designers, developers and older adults to assess an existing or draft home architectural design from risk of falling perspective.

3. The proposed framework quantitatively assesses architectural home design from the perspective of evaluating the risk of falling associated with bathroom design;
4. The conducted evidence-based systematic review in this research creates a database that encompasses relevant evidence-based studies for both bathroom design in relation to the risk of falling for older adults;
5. The concept of divide and conquer algorithm (DCA) has been systematically applied to divide the architectural space into elements and associated features;
6. A new concept of “block schema” was developed in order to count for various design scenarios;
7. A mathematical assessment model has been conducted in this study in order to numerically evaluate the risk of falling for older adults, which facilitates the assessment to be incorporated as a part of the BIM;
8. A generalized assessment model equations has been developed to facilitate further implementation on various architectural space design.

5.4 Recommendations for Future Research

This research has demonstrated an evidence-based framework to assess the bathroom design in order to reduce the risk of falling for older adults in residential dwelling. Also, the developed mathematical model forms a foundational tool to assess various architectural spaces. This work can be extended to several areas for future research including but not limited to:

- Analyzing other residential dwelling spaces and various building design: the proposed framework and mathematical model can be widely implemented in the future to reduce the risk of falling for older adults within various residential dwelling spaces, such as kitchen, entrance, living room, and landscape design. Also, the proposed framework can be implemented on various building types, such as hospitals, public buildings and assisted living facilities. Additionally, rating systems other than the equal-interval system, such as the Euclidean distance, can be experimentally investigated.
- Including other occupying groups: the research focuses on older adults groups; however, future research might select different groups of older adults such as older adults with dementia, or older adults with a disability. Also, this research focuses on the risk of falling for older adults, which can be alternated in the future to any specific kind of risk that face older adults group such as the risk of injures. The proposed research mathematical model and framework can also be implemented on different groups of people in different building types, such as children in schools, patients in hospitals, workers in factors, and employees in offices. Also, a specific group can be chosen based on selected criteria, such as reducing the risk of injuries for toddlers in the home, and reducing the risk of injuries for workers in a factory environment.
- Incorporating the assessment system into BIM: as this research proposes a quantitative assessment system that can be evaluated based on specific measurements, the quantitative evaluation system and model can be

incorporated as part of BIM. The developed quantitative assessment representation can be introduced to a computer aided design (CAD) program in order to assess the risk of falling associated with a proposed design. Introducing this assessment system to CAD program will facilitate the assessment and optimization of various design solutions.

- Evaluating other systems rather than space design: the proposed technique and model can be altered, by changing the elements as well as the purpose, to evaluate other systems rather than space design. There is a wide variety of other systems that can be evaluated from the perspective of achieving certain objective. To illustrate, some of the systems that can be assessed include, but are not limited to:

- Assessing different treatments dealing with an environmental situation.
- Evaluation of different isolation techniques and materials on the sustainability of buildings.
- Assessing the level of building sustainability.
- Evaluation of certain actions on the residential carbon footprint.
- Assessing the effect of different production elements on the productivity of certain product.

REFERENCES

- Affi, M., Parke, B. and Al-Hussein, M. (2014). "Integrated approach for older adult friendly home staircase architectural design." *Automation in Construction* 39(0): 117-125.
- Aminzadeh, F., Edwards, N., Lockett, D. and Nair, R. C. (2000). "Utilization of bathroom safety devices, patterns of bathing and toileting, and bathroom falls in a sample of community living older adults." *Technology and Disability* 13(1): 95-103.
- Arksey, H. and O'Malley, L. (2005). "Scoping studies: towards a methodological framework." *International Journal of Social Research Methodology* 8(1): 19-32.
- Armstrong, K. and Massey, O. (2002). "Building a safe school: Evaluation findings from the clearview avenue elementary school." Tampa, FL: The Louis de la Parte Florida Mental Health Institute, University of South Florida. FMHI Publication: 207-205.
- Awad, A. (2009). *Intelligent Contractor Default Prediction Model for Surety Bonding in the Construction Industry* Department of Civil and Environmental Engineering university of Alberta. PhD.
- Bakker, R. (1999). "Elderdesign: Home Modifications for Enhanced Safety and Self-Care." *Care Management Journal* 1(1): 47-54.
- Barlow, J. and Venables, T. (2004). "Will Technological Innovation Create the True Lifetime Home?" *Housing Studies* 19(5): 795-810.
- Bayer, A. H. (2000). *Fixing to Stay: A National Survey of Housing and Home Modification Issues*. Washington, D.C., AARP.
- Blaikie, N. W. H. (2003). *Analyzing quantitative data : from description to explanation*. London ; Thousand Oaks, CA, Sage Publications Ltd.
- Buchman, A. S., Wilson, R. S., Yu, L., James, B. D., Boyle, P. A. and Bennett, D. A. (2014). "Total daily activity declines more rapidly with increasing age in older adults." *Archives of Gerontology and Geriatrics* 58(1): 74-79.

- Byerts, T. O., Lawton, M. P. and Windley, P. G. (1982). *Aging and the Environment: Theoretical Approaches*. New York, Springer.
- Campbell, A. J., Borrie, M. J. and Spears, G. F. (1989). "Risk factors for falls in a community-based prospective study of people 70 years and older." *Journal of Gerontology* 44(4): M112-117.
- Capezuti, E., Wagner, L., Brush, B. L., Boltz, M., Renz, S. and Secic, M. (2008). "Bed and toilet height as potential environmental risk factors." *Clinical Nursing Research* 17(1): 50-66.
- Capezuti, E., Wagner, L., Brush, B. L., Boltz, M., Renz, S. and Secic, M. (2008). "Bed and toilet height as potential environmental risk factors." *Clinical Nursing Research* 17(1): 50-66.
- Carter, S. E., Campbell, E. M., Sanson-Fisher, R. W., Redman, S. and Gillespie, W. J. (1997). "Environmental hazards in the homes of older people." *Age and Ageing* 26(3): 195-202.
- Chang, J. T., Morton, S. C., Rubenstein, L. Z., Mojica, W. A., Maglione, M., Suttorp, M. J., Roth, E. A. and Shekelle, P. G. (2004). "Interventions for the prevention of falls in older adults: systematic review and meta-analysis of randomised clinical trials." *BMJ* 328(7441): 680.
- Clarke, M., Clarke, S., Odell, A. and Jagger, C. (1984). "The elderly at home: health and social status." *Health Trends* 16: 3-7.
- Clemson, L. and Martin, R. (1996). "Usage and effectiveness of rails, bathing and toileting AIDS." *Occupational Therapy in Health Care* 10(1): 41-59.
- Cormen, T. H., Leiserson, C. E., Rivest, R. L. and Stein, C. (2003). *Introduction to algorithms*. Cambridge, Mass. ; London, MIT Press.
- Cronin, P., Ryan, F. and Coughlan, M. (2008). "Undertaking a literature review: a step-by-step approach." *British Journal of Nursing* (Mark Allen Publishing)(17): 38-43.
- Cumming, R. G., Thomas, M., Szonyi, G., Salkeld, G., O'Neill, E., Westbury, C. and Frampton, G. (1999). "Home visits by an occupational therapist for assessment and modification of environmental hazards: a randomized trial of falls prevention." *Journal of the American Geriatrics Society* 47: 1397-1402.

- Dahlin Ivanoff, S. and Sonn, U. (2005). "Assistive devices in activities of daily living used by persons with age-related macular degeneration: a population study of 85-year-olds living at home." *Scandinavian Journal of Occupational Therapy* 12(1): 10-17.
- Day, L., Fildes, B., Gordon, I., Fitzharris, M., Flamer, H. and Lord, S. (2002). "Randomised factorial trial of falls prevention among older people living in their own homes." *BMJ* 325(7356): 128.
- DCLG (2008). *Lifetime Homes, Lifetime Neighbourhoods: A National Strategy for Housing in an Ageing Society*. London, DCLG (Department for Communities and Local Government).
- Demiris, G., Rantz, M. J., Aud, M. A., Marek, K. D., Tyrer, H. W., Skubic, M. and Hussam, A. A. (2004). "Older Adults' Attitudes Towards and Perceptions of 'Smart Home' Technologies: a Pilot Study." *Informatics for Health and Social Care* 29(2): 87-94.
- DeVito, C., Lambert, D., Sattin, R. W., Bacchelli, S., Ros, A. and Rodriguez, J. (1988). "Fall injuries among the elderly. Community-based surveillance." *Journal of the American Geriatrics Society* 36(11): 1029-1035.
- Devito, C. A., Lambert, D. A., Sattin, R. W., Bacchelli, S., Ros, A. and Rodriguez, J. G. (1988). "Fall injuries among the elderly. Community-based surveillance." *Journal of the American Geriatrics Society* 36(11): 1029-1035.
- Dillon, G. J. and Barclay, L. A. (1997). "Student focus groups as an assessment technique: A case study." *Journal of Accounting Education* 15(3): 457-468.
- Donald, L. P. and Bulpitt, C. J. (1999). "The Prognosis of Falls in Elderly People Living at Home." *Age and Ageing* 28: 121 - 125.
- Edwards, N., Lockett, D., Aminzadeh, F. and Nair, R. C. (2003). "Predictors of Bath Grab-Bar Use among Community-Living Older Adults." *Canadian Journal on Aging/La Revue canadienne du vieillissement* 22(02): 217-227.
- Edwards, N. I. and Jones, D. A. (1998). "Ownership and use of assistive devices amongst older people in the community." *Age and Ageing* 27(4): 463-468.
- Edwards, P. and Mawani, A. (2006). "Healthy Aging in Canada: A New Vision, A Vital Investment From Evidence to Action. A Background Paper Prepared

for the Federal, Provincial and Territorial Committee of Officials (Seniors)."

Elliott, S., Painter, J. and Hudson, S. (2009). "Living alone and fall risk factors in community-dwelling middle age and older adults." *Journal of Community Health* 34(4): 301-310.

Figueiro, M., Gras, L., Qi, R., Rizzo, P., Rea, M. and Rea, M. (2008). "A novel night lighting system for postural control and stability in seniors." *Lighting Research and Technology* 40(2): 111-126.

Giacomin, J. (2012). *What is Human Centred Design?* . Uxbridge, Middlesex, United Kingdom Human Centred Design Institute, Brunel University

Gill, T. M., Williams, C. S., Robison, J. T. and Tinetti, M. E. (1999). "A population-based study of environmental hazards in the homes of older persons." *American Journal of Public Health* 89(4): 553-556.

Gillespie, L. D., Gillespie, W. J., Robertson, M. C., Lamb, S. E., Cumming, R. G. and Rowe, B. H. (2003). "Interventions for preventing falls in elderly people." *Cochrane Database Systematic Review* 4.

Grant, M. J. and Booth, A. (2009). "A typology of reviews: an analysis of 14 review types and associated methodologies." *Health Information & Libraries Journal* 26(2): 91-108.

Greenbaum, T. L. (1998). *The handbook for focus group research*. California, Sage Publications.

Guitard, P., Sveistrup, H., Lockett, D., Edwards, N. and Ottawa, U. o. (2007). *How Effective Are Bathtub Grab Bars for Stopping a Fall When You Lose Your Balance?*

Harman, D. and Craigie, S. (2011). "Gerotechnology series: Toileting aids." *European Geriatric Medicine* 2(5): 314-318.

Haslam, R. and Stubbs, D. (2006). *Understanding and Preventing Falls*. Boca Raton, Fla. ; London, Taylor & Francis.

Hornbrook, M. C., Stevens, V. J., Wingfield, D. J., Hollis, J. F., Greenlick, M. R. and Ory, M. G. (1994). "Preventing falls among community-dwelling older persons: results from a randomized trial." *The Gerontologist* 34(1): 16-23.

- HRSDC. (2011). "Human Resources and Skills Development Canada, Indicators of Well-being in Canada, Canadians in Context - Aging Population " Retrieved August 2nd, 2011, from <http://www4.hrsdc.gc.ca/.3ndic.1t.4r@-eng.jsp?iid=33>.
- ICC (2012). International Residential Code (IRC): for one- and two-family dwellings, International code council, Inc.
- IESNA (2007). Recommended Practice for Lighting and the Visual Environment for Senior Living IESNA(Illuminating Engineering Society of North America).
- Jackson, S. L. (2011). Research methods and statistics : a critical thinking approach. [S.l.], Wadsworth/Cengage.
- Kannus, P., Parkkari, J., Koskinen, S., Niemi, S., Palvanen, M., Järvinen, M. and Vuori, I. (1999). "Fall-Induced Injuries and Deaths Among Older Adults." *American Medical Association* 281(20): 1895-1899.
- Kannus, P., Sievanen, H., Palvanen, M., Jarvinen, T. and Parkkari, J. (2005). "Prevention of falls and consequent injuries in elderly people." *Lancet* 366(9500): 1885-1893.
- Kim, H., Ahn, Y. H., Steinhoff, A. and Lee, K. H. (2014). "Home modification by older adults and their informal caregivers." *Archives of Gerontology and Geriatrics* 59(3): 648-656.
- Kinoshita, S. (2012). "Handrail position and shape that best facilitate sit-to-stand movement." *Journal of Back and Musculoskeletal Rehabilitation* 25(1): 33-45.
- Kitzinger, J. (1995). "Qualitative research. Introducing focus groups." *British Medical Journal* 311(7000): 299.
- Krueger, R. A. and Casey, M. A. (1994). *Focus groups: A practical guide for applied research*. California, Sage Publications.
- Krueger, R. A. and Casey, M. A. (2009). *Focus groups: A practical guide for applied research*. California, Sage Publications.

- Lawton, M. P. and Nahemow, L. (1973). *The psychology of adult development and aging (Ecology and the Aging Process)*. Washington, American Psychological Association.
- Leclerc, B. S., Bégin, C., Cadieux, É., Goulet, L., Allaire, J. F., Meloche, J., Leduc, N. and Kergoat, M. J. (2010). "Relationship between home hazards and falling among community-dwelling seniors using home-care services." *Revue d'Épidémiologie et de Santé Publique* 58(1): 3-11.
- Lee, D. M., Trauth, E. M. and Farwell, D. (1995). "Critical skills and knowledge requirements of IS professionals: a joint academic/industry investigation." *MIS Quarterly*: 313-340.
- Lomax, R. G. (2001). *An Introduction to Statistical Concepts for Education and Behavioral Sciences*. Mahwah, N.J., Lawrence Erlbaum Associates.
- Lord, S. R. and Dayhew, J. (2001). "Visual Risk Factors for Falls in Older People." *Journal of the American Geriatrics Society* 49(5): 508-515.
- Lord, S. R., Sherrington, C. and Menz, H. B. (2001). *Falls in Older People: Risk Factors and Strategies for Prevention*. Cambridge ; New York, Cambridge University Press.
- Lord, S. R., Sherrington, C., Menz, H. B. and Close, J. (2007). *Falls in older people : risk factors and strategies for prevention*. Cambridge, Cambridge University Press.
- Lord, S. R., Ward, J. A., Williams, P. and Anstey, K. J. (1993). "An epidemiological study of falls in older community-dwelling women: the Randwick falls and fractures study." *Australian Journal of Public Health* 17(3): 240-245.
- Lupton, E. and Miller, J. A. (1996). *Bathroom, the Kitchen, and the Aesthetics of Waste*. Cambridge, Princeton Architectural Press.
- Mackenzie, L., Byles, J. and Higginbotham, N. (2002). "A prospective community-based study of falls among older people in Australia: frequency, circumstances, and consequences." *OTJR: Occupation, Participation and Health* 22(4): 143.
- Maki, B. E. (1988). *Influence of Handrail Shape, Size and Surface Texture on the Ability of Young and Elderly Users to Generate Stabilizing Forces and Moment*. Ottawa, Editorial Office, Division of Electrical Engineering, National Research Council of Canada.

- Mann, W. C. and Helal, A. A. (2006). Promoting independence for older persons with disabilities: lighting your way into home modifications. Amsterdam, IOS Press.
- Martel, L., Belanger, A., Berthelot, J.-M. and Carrière, Y. (2005). Healthy Today, Healthy Tomorrow? Findings from the National Population Health Survey. Ottawa, Statistics Canada Catalogue.
- Massey, O. T. (2011). "A proposed model for the analysis and interpretation of focus groups in evaluation research." *Evaluation and Program Planning* 34(1): 21-28.
- Messinger, E. B., Rowe, L. A. and Henry, R. R. (1991). "A divide-and-conquer algorithm for the automatic layout of large directed graphs." *Systems, Man and Cybernetics, IEEE Transactions on* 21(1): 1/2.
- Morgan, D. L. (1997). Focus groups as qualitative research. California, Sage Publications.
- Morgan, R. O., DeVito, C. A., Stevens, J. A., Branche, C. M., Virnig, B. A., Wingo, P. A. and Sattin, R. W. (2005). "A self-assessment tool was reliable in identifying hazards in the homes of elders." *Journal of Clinical Epidemiology* 58(12): 1252. e1251-1252. e1221.
- Moss, A. B. (1992). "Are the elderly safe at home?" *Journal of Community Health Nursing* 9(1): 13-19.
- Murphy, S. L., Gretebeck, K. A. and Alexander, N. B. (2007). "The bath environment, the bathing task, and the older adult: a review and future directions for bathing disability research." *Disability and Rehabilitation* 29(14): 1067-1075.
- Murphy, S. L., Nyquist, L. V., Strasburg, D. M. and Alexander, N. B. (2006). "Bath Transfers in Older Adult Congregate Housing Residents: Assessing the Person-Environment Interaction." *Journal of the American Geriatrics Society* 54(8): 1265-1270.
- Neufert, E., Neufert, P., Baiche, B. and Walliman, N. (2000). Architects' data. Oxford, Blackwell Science.
- Nevitt, M. C., Cummings, S. R. and Hudes, E. S. (1991). "Risk factors for injurious falls: a prospective study." *Journal of Gerontology* 46(5): M164-170.

- Nevitt, M. C., Cummings, S. R., Kidd, S. and Black, D. (1989). "Risk factors for recurrent nonsyncopal falls. A prospective study." *Jama* 261(18): 2663-2668.
- Norman, D. A. and Draper, S. W. (1986). *User Centered System Design: A new perspective on Human-Computer Interaction*, LAWRENCEERLBAUM & Associates, Hillsdale, N.J.
- O'Loughlin, J. L., Robitaille, Y., Boivin, J. F. and Suissa, S. (1993). "Incidence of and risk factors for falls and injurious falls among the community-dwelling elderly." *American Journal of Epidemiology* 137(3): 342-354.
- O'Meara, D. M. and Smith, R. M. (2005). "Differences between grab rail position and orientation during the assisted sit-to-stand for able-bodied older adults." *Journal of Applied Biomechanics* 21(1): 57-71.
- O'Meara, D. M. and Smith, R. M. (2006). "The effects of unilateral grab rail assistance on the sit-to-stand performance of older aged adults." *Human Movement Science* 25(2): 257-274.
- Oh-Park, M., Xue, X., Holtzer, R. and Verghese, J. (2011). "Transient Versus Persistent Fear of Falling in Community-Dwelling Older Adults: Incidence and Risk Factors." *Journal of the American Geriatrics Society* 59(7): 1225-1231.
- Ostroff, E. and Preiser, W. F. E. (2001). *Universal design handbook*. New York, McGraw-Hill.
- Panero, J. and Zelnik, M. (1979). *Human dimension & interior space : a source book of design reference standards*, New York : Whitney Library of Design.
- Parrott, K. R., Beamish, J., Emmel, J. and Peterson, M. J. (2013). *Bath planning : guidelines, codes, standards*. Hoboken, New Jersey, Wiley.
- Pestman, W. R. and Alberink, I. B. (1998). *Mathematical Statistics : Problems and Detailed Solutions*. Berlin, New York, Walter de Gruyter.
- PHAC (2014). *Seniors' falls in Canada: second report*. Public Health Agency of Canada, Beaconsfield, Quebec.
- Pilla, S. D. (2003). *Slip and Fall Prevention: A Practical Handbook*.

- Plautz, B., Beck, D. E., Selmar, C. and Radetsky, M. (1996). "Modifying the environment: a community-based injury-reduction program for elderly residents." *American Journal of Preventive Medicine* 12(4 Suppl): 33-38.
- Pynoos, J., Rose, D., Rubenstein, L., Choi, I. H. and Sabata, D. (2006). "Evidence-based interventions in fall prevention." *Home Health Care Services Quarterly* 25(1-2): 55-73.
- Ramsey, C. G., Hoke, J. R., Sleeper, H. R., Bassler, B. L. and American Institute of Architects. (2000). *Architectural graphic standards*. New York ; Chichester, Wiley.
- Rashid, S., Hussain, M. and Yusuff, R. (2008). "Designing homes for the elderly based on the anthropometry of older Malaysians." *Asian Journal of Gerontology Geriatrics* 3: 75-83.
- Riley, P. O., Schenkman, M. L., Mann, R. W. and Hodge, W. A. (1991). "Mechanics of a constrained chair-rise." *Journal of Biomechanics* 24(1): 77-85.
- Rogers, M. E., Rogers, N. L., Takeshima, N. and Islam, M. M. (2004). "Reducing the Risk for Falls in the Homes of Older Adults." *Journal of Housing For the Elderly* 18(2): 29 - 39.
- Saaty, T. L. (2008). "Decision making with the analytic hierarchy process." *International Journal of Services Sciences* 1(1): 83-98.
- Sanford, J. A., Arch, M. and Megrew, M. B. (1995). "An evaluation of grab bars to meet the needs of elderly people." *Assistive Technology* 7(1): 36-47.
- SCC (2008). *Barrier-Free Design Guide, Based on the Alberta Building Code 2006. Design for independence and Dignity for Everyone, Vision, Hearing, Communication, Mobility, Cognition*. Safety Code Council. Edmonton.
- Scott, V., Pearce, M. and Pengelly, C. (2005). *Technical Report: Injury Resulting from Falls Among Canadians Age 65 and over (on the Analysis of Data from the Canadian Community Health Survey, Cycle 2.1, as Presented in: Report on Seniors' Falls in Canada)*. Victoria, BC Public Health Agency of Canada.
- Sinagub, J., Vaughn, S. and Schumm, J. (1996). *Focus group interviews in education and psychology*, Sage Publications, Incorporated Thousand Oaks.

- Skiena, S. S. (2008). *The algorithm design manual*. London, Springer.
- Sonn, U. and Grimby, G. (1994). "Assistive devices in an elderly population studied at 70 and 76 years of age." *Disability and Rehabilitation* 16(2): 85-92.
- Spiegel, M. R. (1992). *Schaum's Outline of Theory and Problems of Probability and Statistics*. New York, McGraw-Hill.
- Stamatis, D. H. (2001). *Six Sigma and Beyond*. Boca Raton, FL, St. Lucie Press.
- Stevens, M., Holman, C. A. J., Bennett, N. and De Klerk, N. (2001). "Preventing falls in older people: outcome evaluation of a randomized controlled trial." *Journal of the American Geriatrics Society* 49(11): 1448-1455.
- Stevens, M., Holman, C. D. A. J. and Bennett, N. (2001). "Preventing Falls in Older People: Impact of an Intervention to Reduce Environmental Hazards in the Home." *Journal of the American Geriatrics Society* 49(11): 1442-1447.
- Stevens, S. (1946). "On the Theory of Scales of Measurement." *Science* 103(2684): 677-680.
- Sveistrup, H., Lockett, D., Edwards, N. and Aminzadeh, F. (2006). "Evaluation of bath grab bar placement for older adults." *Technology and Disability* 18(2): 45-55.
- Taira, E. D. and Carlson, J. L. (1999). *Aging in place : designing, adapting, and enhancing the home environment*. New York ; London, Haworth Press.
- Talbot, L. A., Musiol, R. J., Witham, E. K. and Metter, E. J. (2005). "Falls in young, middle-aged and older community dwelling adults: perceived cause, environmental factors and injury." *BMC Public Health* 5: 86.
- Templer, J. A. (1992). *The Staircase: Studies of Hazards, Falls, and Safer Design*. Cambridge, Mass., MIT Press.
- Tideiksaar, R. (2010). *Falls in older people : prevention & management*. Baltimore, Health Professions Press.
- Tinetti, M. E. (2003). "Preventing Falls in Elderly Persons." *New England Journal of Medicine* 348(1): 42-49.

- Tinetti, M. E., Baker, D. I., McAvay, G., Claus, E. B., Garrett, P., Gottschalk, M., Koch, M. L., Trainor, K. and Horwitz, R. I. (1994). "A multifactorial intervention to reduce the risk of falling among elderly people living in the community." *New England Journal of Medicine* 331(13): 821-827.
- Tinetti, M. E., Doucette, J., Claus, E. and Marottoli, R. (1995). "Risk factors for serious injury during falls by older persons in the community." *Journal of the American Geriatrics Society* 43(11): 1214-1221.
- Tinetti, M. E., Speechley, M. and Ginter, S. F. (1988). "Risk factors for falls among elderly persons living in the community." *New England Journal of Medicine* 319(26): 1701-1707.
- Tinetti, M. E. and Williams, C. S. (1998). "The effect of falls and fall injuries on functioning in community-dwelling older persons." *The Journals of Gerontology Series A: Biological Sciences and Medical Sciences* 53(2): M112-119.
- Tinetti, M. E., Williams, T. F. and Mayewski, R. (1986). "Fall risk index for elderly patients based on number of chronic disabilities." *The American Journal of Medicine* 80(3): 429-434.
- Trickey, F., Maltais, D., Gosselin, C. and Robitaille, Y. (1994). "Adapting Older Persons' Homes to Promote Independence." *Physical & Occupational Therapy in Geriatrics* 12(1): 1-14.
- Turcotte, M. S., Grant. (2007). *A portrait of seniors in Canada, 2006 / by Martin Turcotte and Grant Schellenberg*. Ottawa, Statistics Canada, Social and Aboriginal Statistics Division.
- van Haastregt, J. C., Diederiks, J. P., van Rossum, E., de Witte, L. P. and Crebolder, H. F. (2000). "Effects of preventive home visits to elderly people living in the community: systematic review." *BMJ* 320(7237): 754-758.
- Vellas, B. J., Wayne, S. J., Romero, L. J., Baumgartner, R. N. and Garry, P. J. (1997). "Fear of Falling and Restriction of Mobility in Elderly Fallers." *Age Ageing* 26(3): 189-193.
- Ware, W. B., Ferron, J. M. and Miller, B. M. (2013). *Introductory statistics : a conceptual approach using R*, Routledge Taylor and Francis Group.
- Warren, S., Craft, R. L. and Bosma, J. T. (1999). *Designing Smart Health Care Technology into the Home of the Future*.

West, B. N. and Emmitt, S. (2004). "Functional design? An analysis of new speculative house plans in the UK." *Design Studies* 25(3): 275-299.