

University of Alberta

Indolizidine alkaloids and asymmetric synthesis of carbocycles

by

David Alexander Wingert

A thesis submitted to the Faculty of Graduate Studies and Research
in partial fulfillment of the requirements for the degree of

Doctor of Philosophy

Department of Chemistry

©David Alexander Wingert

Fall 2011

Edmonton, Alberta

Permission is hereby granted to the University of Alberta Libraries to reproduce single copies of this thesis and to lend or sell such copies for private, scholarly or scientific research purposes only. Where the thesis is converted to, or otherwise made available in digital form, the University of Alberta will advise potential users of the thesis of these terms.

The author reserves all other publication and other rights in association with the copyright in the thesis and, except as herein before provided, neither the thesis nor any substantial portion thereof may be printed or otherwise reproduced in any material form whatsoever without the author's prior written permission.

***DEDICATED TO
MY FAMILY***

ABSTRACT

The first chapter of this thesis describes the development of an asymmetric route to the core structure of the indolizidine alkaloids and its application to the total synthesis of (+)-ipalbidine, a member of this compound class. The initial approach was designed to use the intramolecular conjugate displacement (ICD) reaction developed in this group as the method to form the bicyclic core structure of these compounds. Some limitations of this useful method were uncovered under these circumstances, and a different approach was required to carry out the synthesis. The indolizidine structure was formed by use of a conjugate addition and the total synthesis of (+)-ipalbidine was completed.

The second chapter describes the expansion of the all-carbon ICD reaction previously developed by this group for carbocyclic ring formation. The goal was to install a pendant chain in an asymmetric fashion onto the carbocycle precursors and then form the rings using the ICD reaction. The strategically placed pendant chain could then be manipulated and utilized as a handle to elaborate the carbocyclic intermediates into more complex structures. This chapter describes (a) the use of the Myers asymmetric alkylation reaction as an installation method for the pendant chain, (b) the production of the asymmetrically substituted carbocycles via the ICD reaction and (c) our efforts to elaborate these intermediates into more complex compounds.

ACKNOWLEDGEMENTS

I would like to express my sincere gratitude to Dr. D. L. J. Clive for his suggestions, advice, guidance, and constant encouragement during the course of my Ph.D. program, and for his assistance during the preparation of this Thesis.

My thanks go to all members of the Clive group, past and present, for their assistance and useful discussions pertaining to my research and for making the research laboratories an enjoyable workplace. I would also like to extend my thanks to Lihong Wang and Zhenhua Chen for their four years of friendship (including our spirited discussions of chemistry and of life). Finally, I would also like to offer my thanks to Dr. Hayley Wan, for her assistance during the last few months of my time at the University of Alberta.

My thanks are also extended to the support staff (IR, MS, NMR, glass blowing, electronic, machine and chemical shops) for their valuable service and advice which helped me immensely in my research.

Finally, I would like to thank my family members for their constant support and encouragement, especially during the course of my graduate studies and during the preparation of this thesis.

Table of Contents

Chapter 1: Asymmetric route to the core structure of indolizidine alkaloids: total synthesis of (+)-ipalbidine.....	1
1. Introduction.....	2
1.1 General.....	2
1.2 (+)-Ipalbidine.....	4
1.2.1 First total synthesis of (\pm)-ipalbidine by Viswanathan.....	5
1.2.2 Total synthesis of (\pm)-ipalbidine and its resolution by Wick	6
1.2.3 Total synthesis of (\pm)-ipalbidine by Stevens	8
1.2.4 Total synthesis of (\pm)-ipalbidine by Herbert.....	10
1.2.5 Formal synthesis of (\pm)-ipalbidine by Michael.....	11
1.2.6 Formal synthesis of (\pm)-ipalbidine by Kibayashi.....	13
1.2.7 Total synthesis of (\pm)-ipalbidine by Danishefsky.....	15
1.2.8 Total synthesis of (\pm)-ipalbidine by Jefford.....	16
1.2.9 Total synthesis of (\pm)-ipalbidine by Padwa	19
1.2.10 Total synthesis of (\pm)-ipalbidine by Ishibashi.....	21
1.2.11 Conclusions.....	24
1.3 Asymmetric syntheses of (+)-ipalbidine	24
1.3.1 Asymmetric synthesis of (+)-ipalbidine by Liu	24
1.3.2 Asymmetric synthesis of (+)-ipalbidine by Honda	26
1.3.3 Asymmetric synthesis of (+)-ipalbidine by Georg	30
1.4 Conclusions.....	34
2. Results and Discussion.....	35

2.1	The Intramolecular Conjugate Displacement (ICD) Reaction.....	35
2.2	The intramolecular conjugate displacement (ICD) reaction and its use in total synthesis	37
2.3	Research Objectives.....	39
2.4	Attempted total synthesis of (+)-ipalbidine: Use of the ICD reaction on an <i>N</i>-Boc protected substrate	40
2.4.1	<i>ICD based retrosynthesis of (+)-ipalbidine.....</i>	<i>40</i>
2.4.2	<i>Synthesis of the L-proline-derived aldehyde</i>	<i>40</i>
2.4.3	<i>Selenoxides as allylic alcohol synthons</i>	<i>42</i>
2.4.4	<i>Selenoacetals as allylic alcohol synthons.....</i>	<i>45</i>
2.4.5	<i>Use of organometallics to create the allylic alcohol functionality.</i>	<i>46</i>
2.4.6	<i>Allylic alcohol formation utilizing an organolithium reagent</i>	<i>47</i>
2.4.7	<i>Intramolecular conjugate addition with a phenyl group</i>	<i>49</i>
2.4.8	<i>Allylic alcohol formation with Grignard reagents.....</i>	<i>50</i>
2.4.9	<i>Allylic alcohol formation using organozinc reagents.....</i>	<i>51</i>
2.4.10	<i>Allylic alcohol formation from acid chlorides</i>	<i>52</i>
2.4.11	<i>Allylic alcohol formation from Weinreb amides.....</i>	<i>54</i>
2.5	Attempted total synthesis of (+)-ipalbidine: Use of the ICD reaction with an <i>N-p</i>-methoxybenzyl protected substrate	55
2.5.1	<i>Synthesis of a <i>N</i>-PMB protected aldehyde.....</i>	<i>55</i>
2.5.2	<i>Allylic alcohol formation from an organolithium nucleophile</i>	<i>56</i>
2.5.3	<i>Intramolecular conjugate displacement of the <i>N</i>-PMB protected series</i>	<i>59</i>
2.6	Attempted total synthesis of (+)-ipalbidine: intramolecular conjugate displacement via silicon stabilization	60

2.6.1	<i>Generation of allylic alcohols</i>	60
2.6.2	<i>Intramolecular conjugate displacement in the presence of a silicon atom</i>	62
2.7	Attempted total synthesis of (+)-ipalbidine: use of a vinyl sulfone functionality as a handle for reactivity	63
2.7.1	<i>Coupling of a vinyl sulfone with a Grignard reagent</i>	64
2.7.2	<i>Conversion of a vinyl sulfone to a zirconocene</i>	65
2.7.3	<i>Conversion of a vinyl sulfone to an organotin species</i>	66
2.8	Conclusions from the ICD approach	68
2.9	Attempted total synthesis of (+)-ipalbidine: condensation of an organocuprate with an acid chloride	69
2.10	Attempted total synthesis of (+)-ipalbidine: use of metal-mediated coupling	72
2.10.1	<i>Use of a triflate for Suzuki-Miyaura coupling</i>	72
2.10.2	<i>Use of a hydrazone to generate coupling partners for the Suzuki-Miyaura reaction</i>	74
2.10.3	<i>Formation of vinyl halide for Suzuki-Miyaura coupling from a terminal triple bond</i>	75
2.10.4	<i>Hydroboration of an L-proline derivative for Suzuki-Miyaura coupling</i>	78
2.11	Attempted total synthesis of (+)-ipalbidine: use of a masked synthon	80
2.12	Total synthesis of (+)-ipalbidine: use of the Reformatsky reaction and elaboration to the natural product	83
2.12.1	<i>Use of soft nucleophiles in the synthesis of (+)-ipalbidine</i>	83

2.12.2	<i>Exploration of aldol alternatives for the synthesis of (+)-ipalbidine .</i>	86
2.12.3	<i>The Reformatsky reaction and its use in the total synthesis of (+)-ipalbidine</i>	87
2.12.4	<i>Reformatsky reaction of a ketone and conjugate addition to access indolizidine alkaloids</i>	91
2.12.5	<i>Completion of the total synthesis of (+)-ipalbidine</i>	93
2.12.6	<i>Second generation synthesis and improvement in optical purity....</i>	95
2.12.7	<i>Applicability of the conjugate addition for alkaloid synthesis.....</i>	98
2.13	Conclusions	99
3.	Experimental	100
4.	References	136
Chapter 2: Intramolecular conjugate displacement and its use in the asymmetric synthesis of carbocycles		
1.	Introduction	147
1.1	General	147
1.2	Carbocycle ring formation	148
1.2.1	<i>The aldol condensation</i>	148
1.2.2	<i>The Michael reaction</i>	152
1.2.3	<i>The Dieckmann Condensation: a specialized form of the Claisen reaction</i>	154
1.2.4	<i>The Diels-Alder Reaction</i>	156
1.2.5	<i>Organometallic mediated cyclizations</i>	160
1.2.6	<i>Radical cyclizations</i>	165

1.2.7	<i>Displacement reactions</i>	167
1.2.8	<i>Conclusions</i>	169
1.3	The all carbon Intramolecular Conjugate Displacement Reaction (ICD)	170
1.4	Conclusions	176
2.	Results and Discussion	177
2.1	Research Objectives	177
2.2	Preparation of asymmetrically substituted ICD precursors	179
2.2.1	<i>Preparation of the carboxylic acid congeners</i>	182
2.2.2	<i>Choosing a chiral auxiliary: The Evans, Myers, and Enders RAMP/SAMP asymmetric alkylation reactions</i>	187
2.2.3	<i>Conversion of the carboxylic acid precursors to pseudoephedrine amides</i>	192
2.2.4	<i>Selection of the pendant chain and asymmetric alkylation</i>	195
2.2.5	<i>Removal of the chiral auxiliary</i>	199
2.2.6	<i>Oxidation of alcohols and avoidance of epimerization</i>	203
2.2.7	<i>ICD ring closure to form asymmetrically substituted rings</i>	204
2.2.8	<i>The ICD-Diels-Alder pathway</i>	208
2.2.9	<i>Elaboration of asymmetric intermediates</i>	215
2.3	Conclusions	220
3.	Experimental	223
4.	References	280

Table of Schemes

Chapter 1

Scheme 1	<i>(+)-Halichlorine</i>	2
Scheme 2	<i>Quinolizidine and indolizidine alkaloid core structures</i>	3
Scheme 3	<i>Ipalbidine and Ipalbine</i>	4
Scheme 4	<i>Total synthesis of (±)-ipalbidine by Viswanathan</i>	5
Scheme 5	<i>Total synthesis of (±)-ipalbidine by Wick</i>	6
Scheme 6	<i>Resolution of OAc-ipalbidine with (-)-di-O-p-toluoyl tartaric acid</i>	7
Scheme 7	<i>Total synthesis of (±)-ipalbidine by Stevens</i>	9
Scheme 8	<i>Synthesis of (±)-septicine</i>	9
Scheme 9	<i>Total synthesis of (±)-ipalbidine by Herbert</i>	10
Scheme 10	<i>Formal synthesis of (±)-ipalbidine by Michael</i>	12
Scheme 11	<i>Eschenmoser's sulfide contraction</i>	13
Scheme 12	<i>Formal synthesis of (±)-ipalbidine by Kibayashi</i>	14
Scheme 13	<i>Total synthesis of (±)-ipalbidine by Danishefsky</i>	15
Scheme 14	<i>Total synthesis of (±)-ipalbidine by Jefford</i>	16
Scheme 15	<i>Reduction of ipalbidine precursors</i>	17
Scheme 16	<i>Benzene ring interference during carbenoid capture</i>	18
Scheme 17	<i>Completion of (±)-ipalbidine synthesis</i>	19
Scheme 18	<i>Total synthesis of (±)-ipalbidine by Padwa</i>	19
Scheme 19	<i>Pyridone formation via [3 + 2] cycloaddition</i>	20
Scheme 20	<i>Preparation of amino precursor from L-proline</i>	21
Scheme 21	<i>Preparation of radical cyclization precursors and side product formation</i>	22
Scheme 22	<i>Total synthesis of (±)-ipalbidine by Ishibashi</i>	23
Scheme 23	<i>Partial asymmetric synthesis of (+)-ipalbidine by Liu</i>	25
Scheme 24	<i>First generation synthesis of (+)-ipalbidine by Honda</i>	27
Scheme 25	<i>Indolizidine core via McMurry coupling</i>	28

Scheme 26	<i>Completion of the total synthesis of (+)-ipalbidine.....</i>	28
Scheme 27	<i>Modified approach to the (+)-ipalbidine precursor.....</i>	29
Scheme 28	<i>Indolizidine core formation via ynone conjugate addition</i>	30
Scheme 29	<i>Installation of aryl component</i>	32
Scheme 30	<i>Completion of total synthesis</i>	33
Scheme 31	<i>The S_N2' reaction and the intramolecular conjugate displacement (ICD)</i>	36
Scheme 32	<i>The ICD and its use in the total synthesis of (+)-halichlorine.....</i>	37
Scheme 33	<i>Preparation of alkaloid core structures via the ICD reaction</i>	38
Scheme 34	<i>The ICD and its use in the total synthesis of (-)-δ-coniceine</i>	39
Scheme 35	<i>First generation ICD based retrosynthesis of (+)-ipalbidine</i>	40
Scheme 36	<i>Preparation of the L-proline-derived aldehyde.....</i>	41
Scheme 37	<i>Preparation of an optically pure indolizidine compound via ICD</i>	42
Scheme 38	<i>Reich's use of selenoxides as allylic alcohol synthons</i>	42
Scheme 39	<i>Attempted use of Reich's selenoxides for allylic alcohol installation.....</i>	43
Scheme 40	<i>Proposed mechanism of selenium substitution.....</i>	44
Scheme 41	<i>Undesired styrene formation using an electron rich selenoxide</i>	45
Scheme 42	<i>Preparation and use of selenoacetals as allylic alcohol synthons</i>	46
Scheme 43	<i>Use of organometallic styrenes for allylic alcohol formation.....</i>	47
Scheme 44	<i>Organolithium 1,2-addition for allylic alcohol formation</i>	47
Scheme 45	<i>Intramolecular conjugate displacement with a phenyl group.....</i>	49
Scheme 46	<i>Grignard 1,2-addition for allylic alcohol formation.....</i>	50
Scheme 47	<i>Organozinc 1,2-addition for allylic alcohol formation</i>	51
Scheme 48	<i>Preparation and use of an acid chloride with an organolithium reagent.....</i>	53
Scheme 49	<i>Use of an organocuprate with the acid chloride.....</i>	53

Scheme 50	<i>Preparation of a Weinreb amide and its use with an organolithium</i>	54
Scheme 51	<i>Preparation of PMB protected aldehyde from L-proline</i>	56
Scheme 52	<i>Attempted organolithium condensation with the PMB protected aldehyde</i>	57
Scheme 53	<i>Alternative pathway for preparation of O-mesylated material</i>	59
Scheme 54	<i>Intramolecular conjugate displacement with a phenyl group and O-mesylate leaving group</i>	59
Scheme 55	<i>Attempted preparation of silicon substituted allylic alcohol</i>	61
Scheme 56	<i>Preparation of silicon substituted allylic alcohols</i>	62
Scheme 57	<i>Attempted ICD with silicon as the stabilizing group</i>	63
Scheme 58	<i>Preparation of sulfone substituted indolizidine alkaloid via ICD</i>	64
Scheme 59	<i>Coupling of vinyl sulfones with Grignard reagents</i>	65
Scheme 60	<i>Attempted coupling of a sulfone substituted indolizidine alkaloid with a Grignard</i>	65
Scheme 61	<i>Substitution of a vinyl sulfone with zirconium</i>	66
Scheme 62	<i>Substitution of a vinyl sulfone with tin</i>	67
Scheme 63	<i>Second generation retrosynthetic approach</i>	69
Scheme 64	<i>β-elimination of an internal amide during zinc insertion</i>	70
Scheme 65	<i>Preparation of a PMB protected alkyl iodide proline derivative</i>	70
Scheme 66	<i>Preparation of the required acid chloride</i>	71
Scheme 67	<i>Attempted coupling of the organozinc with the acid chloride</i>	72
Scheme 68	<i>Third generation retrosynthetic approach</i>	73
Scheme 69	<i>Preparation of arylboronate</i>	73
Scheme 70	<i>Attempted preparation of vinyl triflate</i>	74
Scheme 71	<i>Attempted conversion of hydrazone to a vinyl bromide</i>	75
Scheme 72	<i>Preparation of proline-derived acetylene</i>	76
Scheme 73	<i>Attempted conversion of acetylene into vinyl coupling partner</i>	77

Scheme 74	<i>Modification of third generation retrosynthetic approach.....</i>	78
Scheme 75	<i>Attempted preparation of vinyl triflate coupling partner.....</i>	79
Scheme 76	<i>Preparation of vinyl bromides.....</i>	79
Scheme 77	<i>Attempted hydroboration of proline-derived olefin.....</i>	80
Scheme 78	<i>Fourth generation retrosynthetic approach.....</i>	81
Scheme 79	<i>Preparation of cyclic sulfamidate.....</i>	81
Scheme 80	<i>Preparation of nitro synthon.....</i>	82
Scheme 81	<i>Attempted condensation of nitro synthon with cyclic sulfamidate.....</i>	82
Scheme 82	<i>Fifth generation retrosynthetic approach.....</i>	83
Scheme 83	<i>Condensation of nitro compound with proline-derived aldehyde.....</i>	84
Scheme 84	<i>Final retrosynthetic approach.....</i>	85
Scheme 85	<i>Condensation of an enolate with the proline-derived aldehyde.....</i>	85
Scheme 86	<i>Attempted Mukaiyama aldol condensation with the proline-derived aldehyde.....</i>	86
Scheme 87	<i>Preparation of Reformatsky precursors.....</i>	87
Scheme 88	<i>Selection of Reformatsky conditions.....</i>	88
Scheme 89	<i>Reformatsky with an electron rich aryl ring.....</i>	89
Scheme 90	<i>Preparation of redesigned Reformatsky precursors.....</i>	90
Scheme 91	<i>Reformatsky condensation of aryl ester with proline-derived aldehyde.....</i>	90
Scheme 92	<i>Preparation of the proline-derived methyl ketone.....</i>	91
Scheme 93	<i>Attempted Reformatsky with the methyl ketone.....</i>	92
Scheme 94	<i>Attempted conjugate addition.....</i>	92
Scheme 95	<i>Synthesis of the (+)-ipalbidine precursor.....</i>	93
Scheme 96	<i>Elaboration of intermediate to (+)-ipalbidine.....</i>	94
Scheme 97	<i>Second generation preparation of the proline-derived aldehyde.....</i>	96
Scheme 98	<i>Possible mechanism of β-epimerization.....</i>	97

Scheme 99	<i>Possible preparation of septicine</i>	98
Scheme 100	<i>Core structure of the stemona alkaloids</i>	99

Chapter 2

Scheme 1	<i>Carbocycles in nature and medicine</i>	147
Scheme 2	<i>Derivatization of the aldol product</i>	148
Scheme 3	<i>The Mukaiyama aldol and Li-enolate formation</i>	149
Scheme 4	<i>The asymmetric Mukaiyama aldol reaction</i>	150
Scheme 5	<i>The Evans asymmetric aldol reaction</i>	151
Scheme 6	<i>Aldol reaction in the total synthesis of dammarenediol II</i>	151
Scheme 7	<i>The Michael reaction</i>	152
Scheme 8	<i>The Robinson annulation</i>	153
Scheme 9	<i>The key Michael reaction in Corey's synthesis of longifolene</i>	154
Scheme 10	<i>Variants of the Claisen condensation</i>	155
Scheme 11	<i>The Dieckmann condensation in the total synthesis of ningalin D</i>	155
Scheme 12	<i>The Diels-Alder cycloaddition</i>	157
Scheme 13	<i>Hetero Diels-Alder cycloaddition</i>	158
Scheme 14	<i>Endo selectivity of the Diels-Alder cycloaddition</i>	158
Scheme 15	<i>Asymmetric catalysts for the Diels-Alder cycloaddition</i>	159
Scheme 16	<i>Use of the Diels-Alder reaction in the total synthesis of the CP molecules</i>	160
Scheme 17	<i>The Stille and Heck reaction in total synthesis</i>	162
Scheme 18	<i>Use of the Suzuki-Miyaura reaction in total synthesis</i>	163
Scheme 19	<i>Outcome of a ring closing metathesis</i>	163
Scheme 20	<i>Catalysts for olefin metathesis</i>	164
Scheme 21	<i>Ring closing metathesis in the synthesis of (+)-nakadomarin A</i>	165
Scheme 22	<i>Radical cyclization</i>	166

Scheme 23	<i>Use of a radical cyclization in the total synthesis of dihydrocodeine</i>	167
Scheme 24	<i>Displacement reactions to form rings</i>	168
Scheme 25	<i>Stork's epoxynitrile ring closing reactions</i>	169
Scheme 26	<i>The S_N2' reaction and its modification</i>	171
Scheme 27	<i>Seebach's modification of the S_N2' reaction</i>	171
Scheme 28	<i>Intramolecular conjugate displacement (ICD) with nitrogen</i>	172
Scheme 29	<i>The ICD and its use in total synthesis</i>	173
Scheme 30	<i>Applicability of the all-carbon ICD in CP molecule synthesis</i>	173
Scheme 31	<i>Carbocycle ring formation via the ICD reaction</i>	175
Scheme 32	<i>Projected ICD formation of asymmetrically substituted carbocycles</i>	177
Scheme 33	<i>Modification of asymmetric intermediates into naturally occurring core structures</i>	178
Scheme 34	<i>Targeted asymmetrically substituted ICD intermediates</i>	180
Scheme 35	<i>Aldehyde precursors prepared in the Clive group</i>	181
Scheme 36	<i>Formation of ICD intermediates</i>	181
Scheme 37	<i>Introduction of pendant chain via asymmetric alkylation</i>	182
Scheme 38	<i>Projected preparation of carboxylic acids</i>	183
Scheme 39	<i>Displacement reaction for ester preparation</i>	183
Scheme 40	<i>Displacement reaction of iodide for ester preparation</i>	184
Scheme 41	<i>First generation carboxylic acid preparation</i>	184
Scheme 42	<i>Use of Grignard reagent to prepare carboxylic acids</i>	185
Scheme 43	<i>Nitrile derivatization for carboxylic acid preparation</i>	185
Scheme 44	<i>Second generation carboxylic acid preparation</i>	186
Scheme 45	<i>Carboxylic acid preparation for seven-membered ring series</i>	187
Scheme 46	<i>Evans chiral auxiliaries</i>	188
Scheme 47	<i>The asymmetric Evans alkylation</i>	188
Scheme 48	<i>Preparation of pseudoephedrine amides</i>	190
Scheme 49	<i>Myers asymmetric alkylation and auxiliary removal</i>	190

Scheme 50	<i>RAMP/SAMP hydrazones</i>	191
Scheme 51	<i>RAMP/SAMP alkylation</i>	192
Scheme 52	<i>Preparation of pseudoephedrine amides from an ester precursor</i>	193
Scheme 53	<i>Preparation of a pseudoephedrine amide from a mixed anhydride</i>	194
Scheme 54	<i>Preparation of pseudoephedrine amides from acid chlorides</i>	194
Scheme 55	<i>Retrosynthesis of a tricyclic system</i>	196
Scheme 56	<i>Model experiment for the Myers asymmetric alkylation</i>	197
Scheme 57	<i>Myers asymmetric alkylation</i>	198
Scheme 58	<i>Attempted hydrolysis of the chiral auxiliary</i>	200
Scheme 59	<i>Reductive removal of the chiral auxiliary using LAB</i>	201
Scheme 60	<i>Mosher ester preparation</i>	202
Scheme 61	<i>Monitoring of optical purity following oxidation</i>	204
Scheme 62	<i>Indirect preparation of allylic alcohols</i>	205
Scheme 63	<i>Formation of the asymmetrically substituted six-membered ring</i>	206
Scheme 64	<i>Formation of the asymmetrically substituted seven-membered ring</i>	207
Scheme 65	<i>Retrosynthesis of a tricyclic compound</i>	208
Scheme 66	<i>Preparation of diene containing alkyl iodide</i>	209
Scheme 67	<i>Alkylation using freshly prepared alkyl iodide</i>	210
Scheme 68	<i>Preparation of Mosher esters</i>	211
Scheme 69	<i>Preparation of allylic alcohol precursor</i>	212
Scheme 70	<i>Attempted preparation of allylic alcohols</i>	213
Scheme 71	<i>Preparation of the allylic alcohol and its subsequent acetylation</i>	213
Scheme 72	<i>Attempted oxidation of sulfur</i>	214
Scheme 73	<i>Preparation of the Diels-Alder precursor</i>	216
Scheme 74	<i>Proposed endo transition state of the desired Diels-Alder cycloaddition</i>	217

Scheme 75	<i>Attempted intermolecular Diels-Alder reactions</i>	218
Scheme 76	<i>Attempted photochemical [2 + 2]</i>	219
Scheme 77	<i>Lewis acid catalyzed "formal" [2 + 2] cyclizations</i>	219
Scheme 78	<i>Attempted Diels-Alder generation of the amphilectane-like diterpenoid core structure</i>	221
Scheme 79	<i>Electron donating group in the Diels-Alder reaction</i>	221
Scheme 80	<i>Conjugate addition in the formation of the benzopyran and decahydroquinoline core structures</i>	222

LIST OF ABBREVIATIONS

Ac	acetyl
acac	acetylacetonate
AcOH	acetic acid
AIBN	2,2'-azobisisobutyronitrile
9-BBN	9-borabicyclo(3.3.1)nonane
BINAP	2,2'-bis(diphenylphosphino)-1,1'-binaphthalene
Bn	benzyl
Boc	<i>tert</i> -butyloxycarbonyl
Bu	butyl
<i>t</i> -Bu	<i>tert</i> -butyl
Bz	benzoyl
Cbz	benzyloxycarbonyl
Cp	cyclopentadienyl ligand
Cy	cyclohexane
DABCO	1,4-diazabicyclo octane
DBU	1,8-diazabicyclo[5.4.0]undec-7-ene
DDQ	2,3-dichloro-5,6-dicyano-1,4-benzoquinone
DIBAL-H	diisobutylaluminum hydride
DMA	<i>N,N</i> -dimethylacetamide
DMAP	4-(dimethylamino)pyridine
DMF	<i>N,N</i> -dimethylformamide

DMP	Dess-Martin Periodinane
DMSO	dimethyl sulfoxide
dppf	1,1'-bis(diphenylphosphino)ferrocene
<i>dr</i>	diastereomeric ratio
<i>ee</i>	enantiomeric excess
Et	ethyl
h	hour
HOMO	highest occupied molecular orbital
HPLC	high performance liquid chromatography
HRMS	high resolution mass spectrometry
IBX	2-iodoxybenzoic acid
ICD	intermolecular conjugate displacement
Im	imidazole
KHMDS	potassium hexamethyldisilazide
LAB	lithium amidotrihydroborate
LHMDS	lithium hexamethyldisilazide
LDA	lithium diisopropylamide
LPT	lithium pyrrolidide-borane
LUMO	lowest unoccupied molecular orbital
<i>m</i> -CPBA	<i>meta</i> -chloroperbenzoic acid
Me	methyl
Mes	mesityl
min	minute(s)

MOM	(methoxymethoxy)methyl
Ms	methanesulfonyl
MTPACl	α -methoxy- α -trifluoromethylphenylacetyl chloride
NBS	<i>N</i> -bromosuccinimide
NCS	<i>N</i> -chlorosuccinimide
NMO	4-methylmorpholine <i>N</i> -oxide
NMR	nuclear magnetic resonance
PCC	pyridinium chlorochromate
Pg	protecting group
Ph	phenyl
PMB	<i>para</i> -methoxybenzyl
PPTS	pyridinium <i>para</i> -toluenesulfonic acid
<i>i</i> -Pr	isopropyl
Pyr	pyridine
PivCl	pivaloyl chloride
rt	room temperature
TBDMS	<i>tert</i> -butyldimethylsilyl
TBS	<i>tert</i> -butyldimethylsilyl
TLC	thin layer chromatography
Tf	trifluoromethanesulfonyl
Tf ₂ O	triflic anhydride
TFA	trifluoroacetic acid
THF	tetrahydrofuran

TIPS	tri- <i>iso</i> -propylsilyl
TMEDA	tetramethylethylenediamine
TMS	trimethylsilyl
TMSI	trimethylsilyl iodide
Tol	<i>para</i> -toluene-
TPAP	tetrapropylammonium perruthenate
Ts	<i>para</i> -toluenesulfonyl
TsOH	<i>para</i> -toluenesulfonic acid

Chapter 1

Asymmetric route to the core structure of indolizidine alkaloids:

total synthesis of (+)-ipalbidine

1. Introduction

1.1 General

Marine alkaloids are very diverse in both structure and medicinal properties and therefore have become attractive targets for synthetic chemists in academic and pharmaceutical laboratories. Recently, the total synthesis of the marine alkaloid halichlorine (**1.1**), isolated by Uemura from the Japanese sponge *Halichondria okadai* Kodota,¹ was completed by this group in both racemic and optically pure forms.²

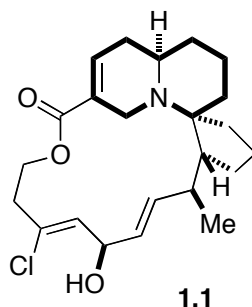

Scheme 1. (+)-Halichlorine

In terms of its medicinal properties, halichlorine has been shown to inhibit the induction of vascular cell adhesion molecule-1 (VCAM-1)³ with an IC_{50} of 7 $\mu\text{g/mL}$. VCAM-1 is an endothelium cell surface protein that promotes leukocyte binding, and is therefore important in inflammatory processes. Its suppression could be useful for treating autoimmune diseases such as arteriosclerosis, asthma and allergic responses.⁴

Focusing on its structural properties, there is of course the macrolactone, but halichlorine has an interesting azabicyclo [4.4.0] decane core structure (highlighted in **1.1**) with a nitrogen at the bridgehead position, the common motif of the smaller subclass of alkaloids known as the quinolizidine alkaloids. During the synthesis of halichlorine, this group utilized an aza-intramolecular conjugate displacement (aza-ICD) reaction to form the bridged ring structure, which spawned our interest in targeting the core structures of both the quinolizidine (**2.1**) and indolizidine alkaloids (**2.2**).⁵

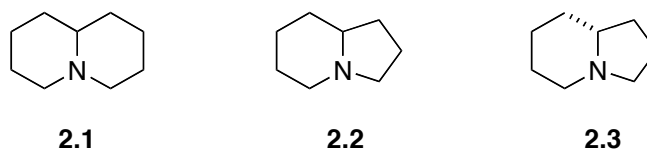

Scheme 2 *Quinolizidine and indolizidine alkaloid core structures*

Utilizing the aza-ICD process, our group was able to generate the core structures of these alkaloids, as well as other size combinations. In several instances, asymmetric syntheses were carried out using starting materials from the chiral pool. Also included in that work was the synthesis of the simple indolizidine alkaloid, (-)-δ-coniceine (**2.3**),⁶ derived from an aza-ICD intermediate and reflecting the usefulness of this methodology for synthesis.

At this point, we became focused on generating more complex optically pure examples of indolizidine alkaloids, in order to explore the applicability and versatility of the aza-ICD process for this class of compound. The hope was to be

able to devise a low-cost, flexible approach from L-proline that could be utilized for many indolizidine alkaloids, and perhaps other compounds with an [X.3.0] core. We chose to target the indolizidine alkaloid (+)-ipalbidine in order to fulfill these goals.

1.2 (+)-Ipalbidine

(+)-Ipalbidine (**3.1**) is the aglycone of (+)-ipalbine (**3.2**), and was chosen for the purposes laid out previously, and also for its interesting medicinal properties. It was isolated from the crushed seeds of *Ipomoea alba* L. (Moonflowers),⁷ and it is a non-addictive analgesic in mice which is not antagonized by naloxone (an opiate drug).⁸ It also shows inhibitory effects on respiratory bursts of leukocytes and scavenges oxygen-free radicals.⁹

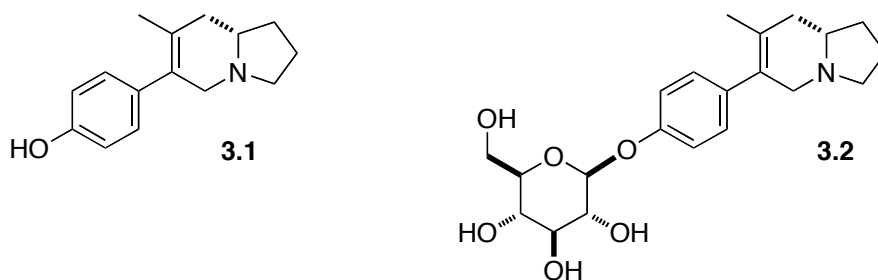

Scheme 3 *Ipalbidine and Ipalbine*

The compound is a known proving ground for synthetic methodology, and therefore seemed like the ideal target for developing our own methods aimed at its synthesis and indolizidine alkaloids in general. The medicinal properties, as well as the retrosynthetic possibilities inherent in the core structure, have led to several

syntheses of this compound, and these syntheses will be summarized in the following sections, separated into categories of racemic and asymmetric syntheses, with each section ordered chronologically.

1.2.1 First total synthesis of (\pm)-ipalbidine by Viswanathan

In 1970, Viswanathan was the first to generate (\pm)-ipalbidine in racemic form.¹⁰ His approach involved treating 4-methoxyphenyl acetate¹¹ with sodium

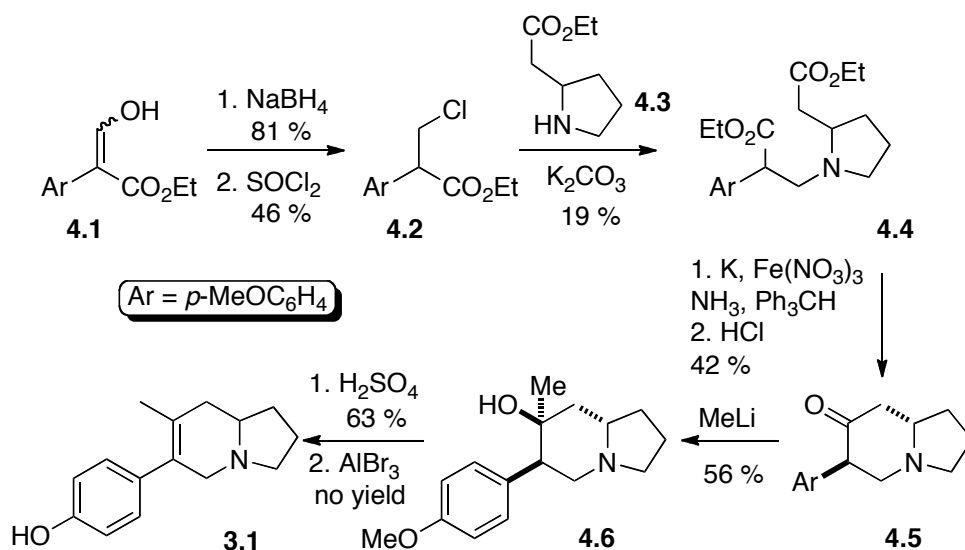

Scheme 4 Total synthesis of (\pm)-ipalbidine by Viswanathan

and ethyl formate to generate enol **4.1**. This compound was subsequently reduced and treated with thionyl chloride to generate compound **4.2**. S_N2 displacement of the chlorine with pyrrolidine derivative **4.3** gave the Dieckmann precursor **4.4**, which was cyclized under basic conditions and decarboxylated. The methyl group was then introduced utilizing freshly prepared MeLi, and dehydration was

then carried out with sulfuric acid. (\pm)-Ipalbidine (**3.1**) was then generated by methyl deprotection of the phenol under Lewis acid conditions (AlBr_3).

1.2.2 Total synthesis of (\pm)-ipalbidine and its resolution by Wick

The total synthesis of racemic ipalbidine was carried out by Wick in 1971,¹² followed by resolution and characterization of the optically pure enantiomers. The starting material for this synthesis was 2-methoxy-1-pyrroline

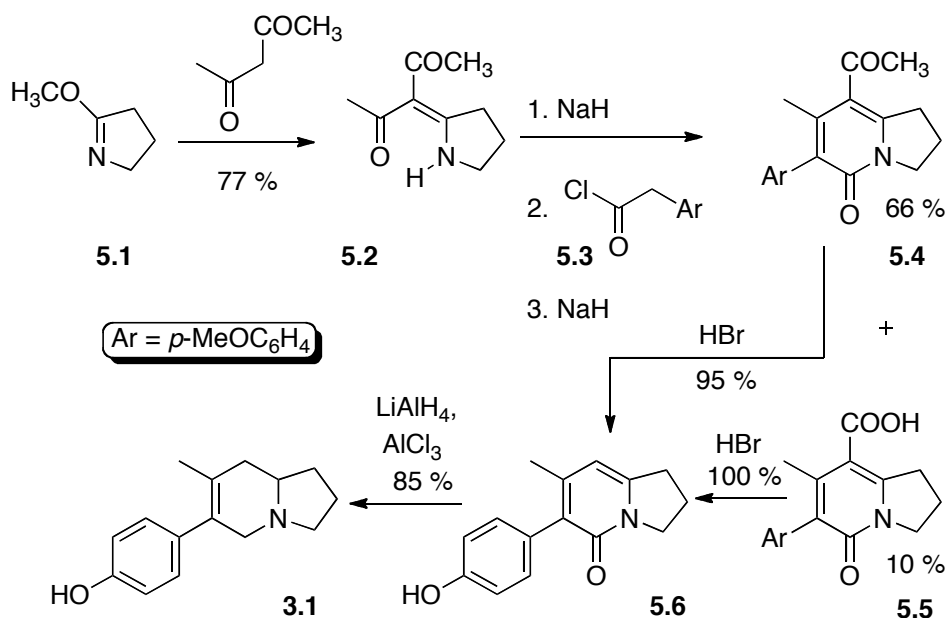

Scheme 5 Total synthesis of (\pm)-ipalbidine by Wick

(**5.1**); this compound is prepared by the alkylation 2-pyrrolidone with dimethyl sulfate.¹³ Condensation of **5.1** with methyl acetoacetate introduces the first few carbons of the six-membered ring. Condensation of the sodium salt of **5.2** (which has much improved reactivity over the protonated form) with acid chloride **5.3**

gave the cyclization precursor, which was closed by an aldol condensation to form ester **5.4** and free acid **5.5**. These compounds were then converted in almost quantitative yield to the demethylated and decarboxylated amide **5.6**. Reduction of **5.6** using AlCl_3 and LiAlH_4 generated racemic ipalbidine.

The resolution of (\pm)-ipalbidine (**3.1**) was carried out by conversion to its phenolic *O*-acetyl derivative, which then crystallized as one diastereoisomeric salt upon treatment with (-)-*di-O-p*-toluoyl tartaric acid, leaving the other diastereoisomeric salt behind in solution.

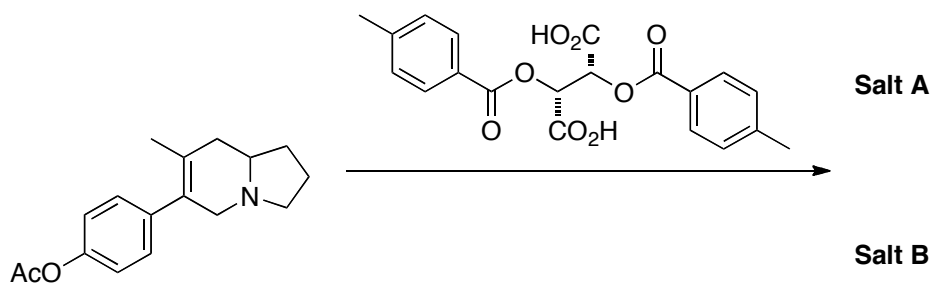

Scheme 6 Resolution of *OAc*-ipalbidine with (-)-*di-O-p*-toluoyl tartaric acid

Each diastereoisomeric salt was then isolated, the acid component liberated, and each enantiomer of the alkaloid deacetylated upon treatment with dilute sodium hydroxide to give optically pure (+)- and (-)-ipalbidine. The authors reported an $[\alpha]_D^{25}$ value of +233.5 ($c = 1.00$, CHCl_3) for (+)-ipalbidine and an $[\alpha]_D^{25}$ value of -237 ($c = 1.00$, CHCl_3) for its enantiomer. The $[\alpha]_D^{25}$ values reported by Wick remained the standard by which asymmetric syntheses were judged until the publication of Georg's synthesis (described later) in which

she analyzed her compounds by chiral HPLC and established that her product, which had an $[\alpha]_D$ value of +202 ($c = 1.00$, CHCl_3), was a 98:2 mixture of enantiomers.

1.2.3 Total synthesis of (\pm)-ipalbidine by Stevens

After completing the total synthesis of (\pm)-isoretronecanol and (\pm)-coniceine (**2.3**),¹⁴ Stevens utilized the same cyclopropylimine rearrangement of those two syntheses in order to generate the more complicated (\pm)-ipalbidine and the related compound (\pm)-septicine (**8.1**).¹⁵

Acylation of *p*-methoxybenzyl cyanide (**7.1**) with LDA and ethyl acetate provided condensation product **7.2**, which was then ketalized and reduced to amine **7.4**. This amine was then condensed with the cyclopropyl aldehyde **7.5** and subsequently treated with mild acid to induce cyclopropylimine rearrangement to generate the 2-pyrroline intermediate **7.7**, which closed under acidic conditions to give bicyclic precursor **7.8**. The sulfur was removed by Raney-nickel hydrogenation, and the ketone released to form the intermediate **4.5**. Treatment with MeLi, dehydration with sulfuric acid, and *O*-demethylation generated (\pm)-ipalbidine (**3.1**). The yields of these final three steps were not reported.

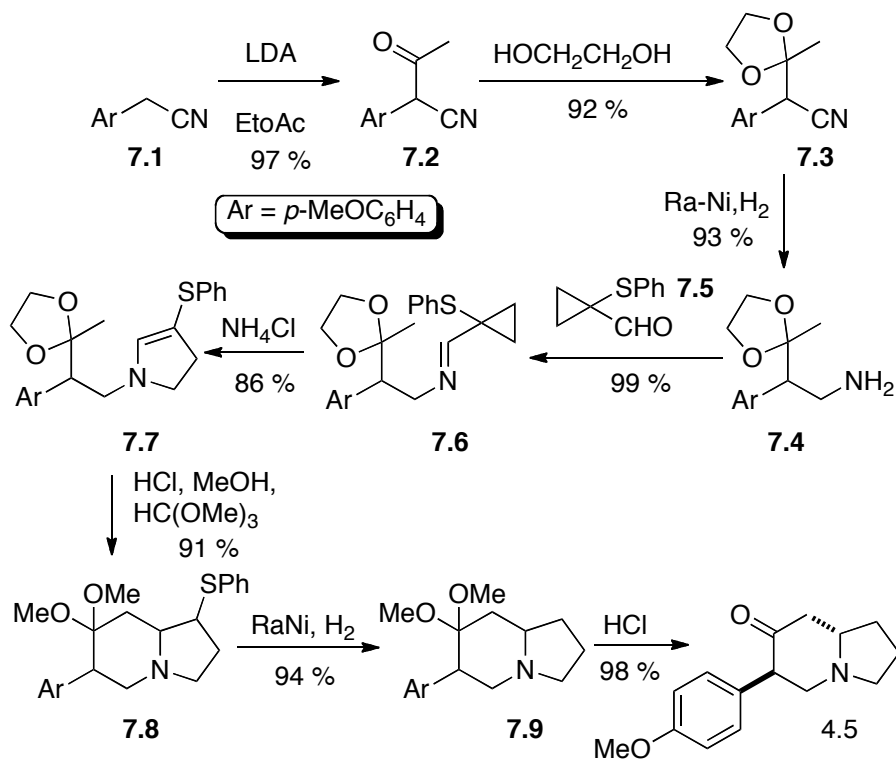

Scheme 7 *Total synthesis of (±)-ipalbidine by Stevens*

Septicine (**8.1**) was generated by Stevens in an analogous fashion, but with the use of 1,2-dimethoxybenzyl cyanide (**8.2**) at the beginning of the synthesis, and organolithium **8.3** in place of MeLi. The subsequent dehydration was carried out as before.

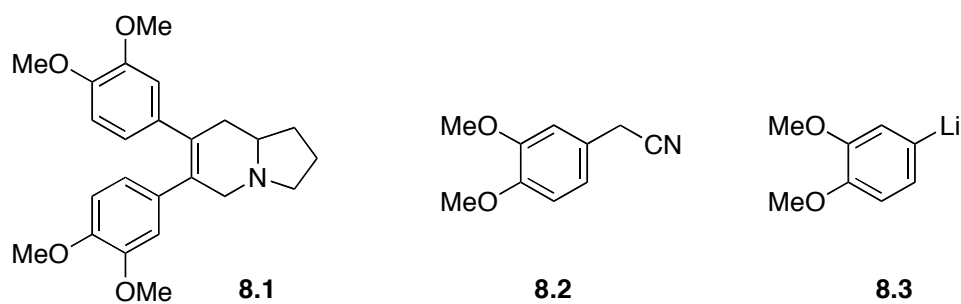

Scheme 8 *Synthesis of (±)-septicine*

The Stevens approach was the first to include a flexibility that would allow for access to several indolizidine alkaloids with only slight variation of the starting materials. This flexibility would begin to be a hallmark of these alkaloid syntheses.

1.2.4 Total synthesis of (\pm)-ipalbidine by Herbert

In 1979, Herbert reported a short and concise synthesis of (\pm)-ipalbidine.¹⁶

Pyrrolidine derivative **9.2** was available by enzymatic oxidation of

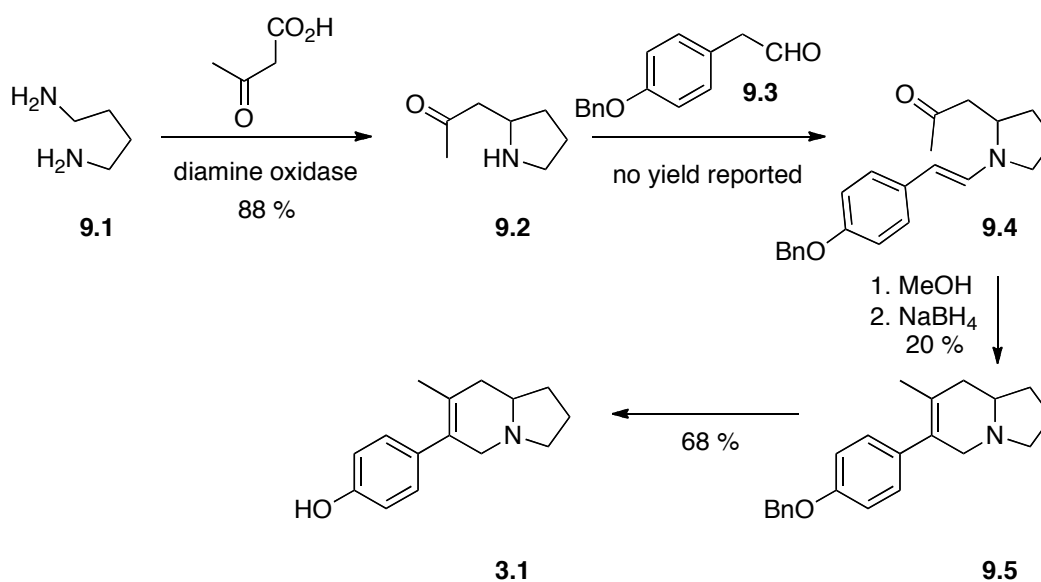

Scheme 9 Total synthesis of (\pm)-ipalbidine by Herbert

9.1 in the presence of acetoacetic acid. Condensation of **9.2** with aldehyde **9.3** gave an enamine intermediate which, in MeOH, cyclized and underwent dehydration to give the natural product precursor **9.5**, following iminium reduction. Debenzylation (no conditions given) gave (\pm)-ipalbidine (**3.1**).

The same authors also carried out a formal synthesis of *O*-methyl ipalbidine,^{16b} using intermediate **9.2** and a *p*-methoxy variant of aldehyde **9.3**. All reaction conditions were the same as before, but the *O*-methyl ipalbidine was not carried forward to the natural product.

1.2.5 Formal synthesis of (\pm)-ipalbidine by Michael

In 1980, Michael reported a formal synthesis¹⁷ of (\pm)-ipalbidine using exocyclic vinylogous urethanes, which were prepared by the “sulfide contraction” procedure developed by Eschenmoser.¹⁸

Thiolactam **10.1** was *N*-alkylated using the Michael acceptor **10.2** under basic conditions. The sulfide contraction was then carried out by first alkylating the sulfur, followed by contraction to generate urethane **10.4**. The non-vinylogous ester was hydrolyzed to its sodium salt and converted to a mixed anhydride, which was then attacked by the electron rich α -carbon of the vinylogous ester to close the ring system and generate the core structure (**10.5** \rightarrow **10.6**). Hydrolysis of ester **10.6** was then carried out, followed by decarboxylation under acidic conditions. Reduction then generated the intermediate **4.5**.

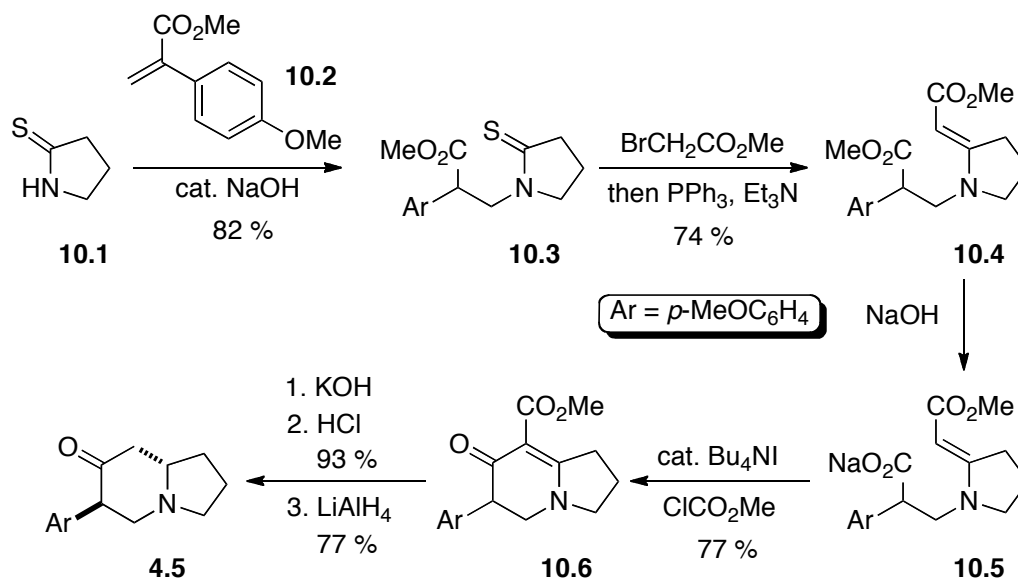

Scheme 10 Formal synthesis of (\pm)-ipalbidine by Michael

Some highlights of the synthesis include generating the alkylated compound **10.3** before carrying out the sulfide contraction. The authors noted that milder conditions and better yields were seen in the sulfur contraction when the nitrogen was tertiary, in comparison to the conditions and yields of Eschenmoser. Acylative ring closure would not occur spontaneously in compound **10.4** and therefore formation of the mixed anhydride was needed to create an electrophilic center reactive enough to be captured intramolecularly by the enamine (**10.4** \rightarrow **10.6**). The final reduction was also of interest, since reduction of the double bond of enaminones is difficult to accomplish¹⁹ using metal catalysts and hydrogen. A mixture of decomposition products, or over-reduction to the alcohol is sometimes seen. However, the authors were able to overcome this by using a metal hydride reagent (LiAlH₄).

The interesting sulfide contraction developed by Eschenmoser involves alkylation on the sulfur, followed by rearrangement and cheletropic extrusion of sulfur to form the double bond, as shown in Scheme 11.

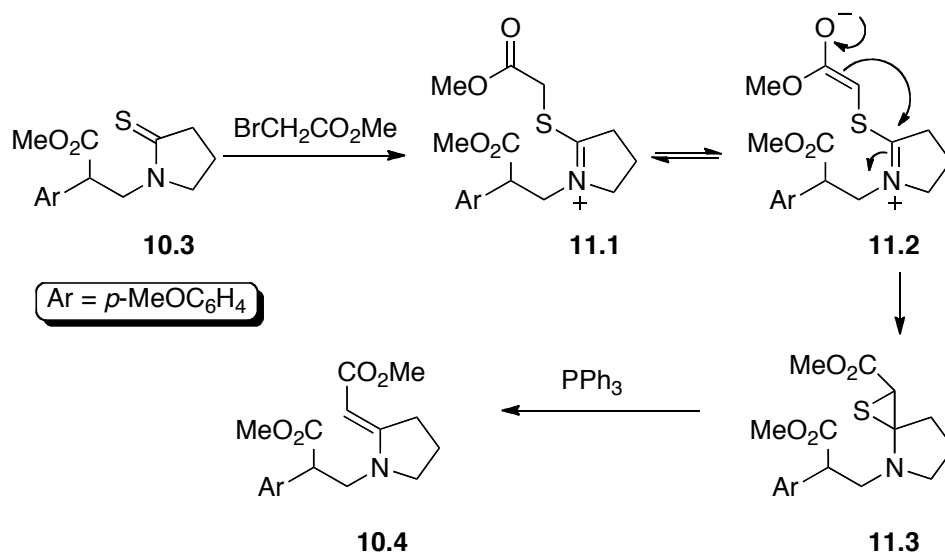

Scheme 11 *Eschenmoser's sulfide contraction*

1.2.6 Formal synthesis of (\pm)-ipalbidine by Kibayashi

In 1983, Kibayashi utilized a 1,3-dipolar cyclization in order to insert the carbons that would generate the nucleus of the indolizidine alkaloid.²⁰ The N-O bond of intermediate **12.4** was cleaved using hydrogenation, and the nitrogen was formylated in the presence of formic acid. The crude mixture was then exposed to NH₃ in MeOH, in order to selectively deformylate any oxygen protected side product. Collins oxidation gave cyclization precursor **12.6**, which, under basic conditions, closed in low yield (36%) to the aldol product **12.7**. Reduction using sodium in liquid ammonia gave the intermediate **4.5**.

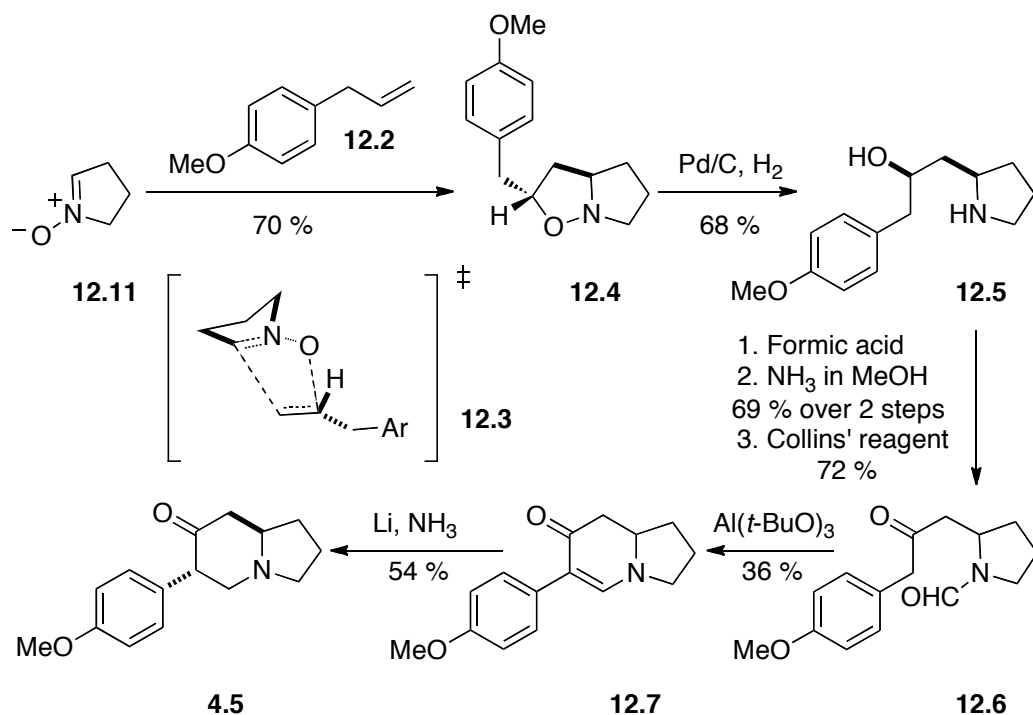

Scheme 12 Formal synthesis of (\pm)-ipalbidine by Kibayashi

This synthesis contains some interesting chemistry, the first example of which is the 1,3-dipolar cycloaddition. The regioselectivity seen was due to LUMO control,²¹ since the 1,3-dipole is a substituted nitronium in which case the largest coefficient is on the carbon atom due to its partial positive character. The dipolarophile is a nonconjugated, electron rich double bond, and therefore the HOMO is polarized to the non-substituted carbon. Matching the largest coefficients gives the heterocycle with the observed regiochemistry. As seen in **12.3**, the stereochemistry is attributed to an *exo*-oriented transition state,²² which alleviates any steric interactions with ring hydrogens by the aryl group if it were to approach from under the heterocyclic ring.

Also of note is the *cis* relationship between the aryl group and the indolizidine bridgehead hydrogen in compound **4.5**. This observed stereochemistry can be attributed to the use of solvated electrons as the reductant for compound **12.7**. Following addition of electrons, protonation of the resultant enolate must be from the top face, as this is the less hindered side.

1.2.7 Total synthesis of (\pm)-ipalbidine by Danishefsky

In 1986, Danishefsky's group completed a total synthesis of (\pm)-ipalbidine²³ utilizing a Lewis-acid activated Diels-Alder cycloaddition reaction. The Diels-Alder adduct **13.4** was then reduced and deprotected to give (\pm)-ipalbidine. Although the shortcoming of this synthesis is the low yield of the Diels-Alder cycloaddition, this drawback is overcome by the small number of steps required.

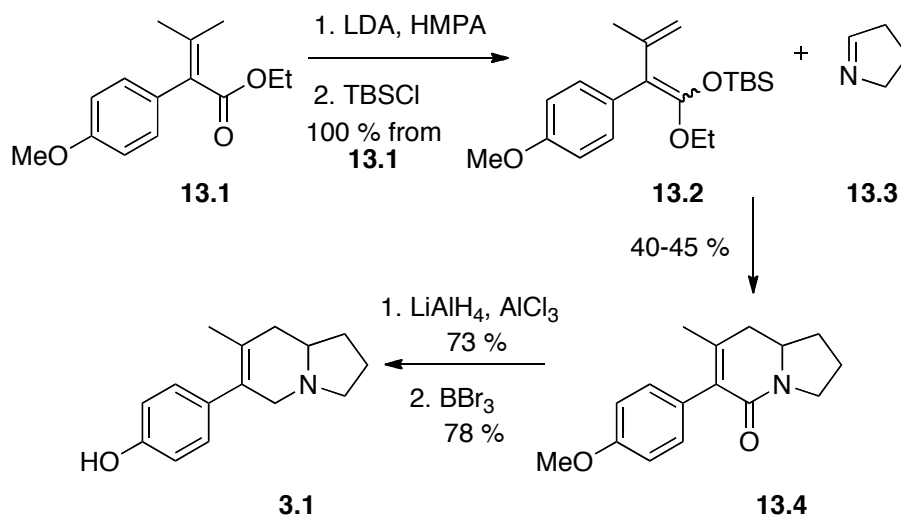

Scheme 13 Total synthesis of (\pm)-ipalbidine by Danishefsky

Danishefsky had provided the quickest route to the core structure of indolizidine alkaloids up to that point, albeit in racemic fashion.

1.2.8 Total synthesis of (\pm)-ipalbidine by Jefford

In 1986, Jefford utilized diazoketones in order to capture a pendant pyrrole ring and generate the core structure of indolizidine alkaloids.²⁴ He made both *O*-methyl ipalbidine and (\pm)-ipalbidine (**3.1**) itself.

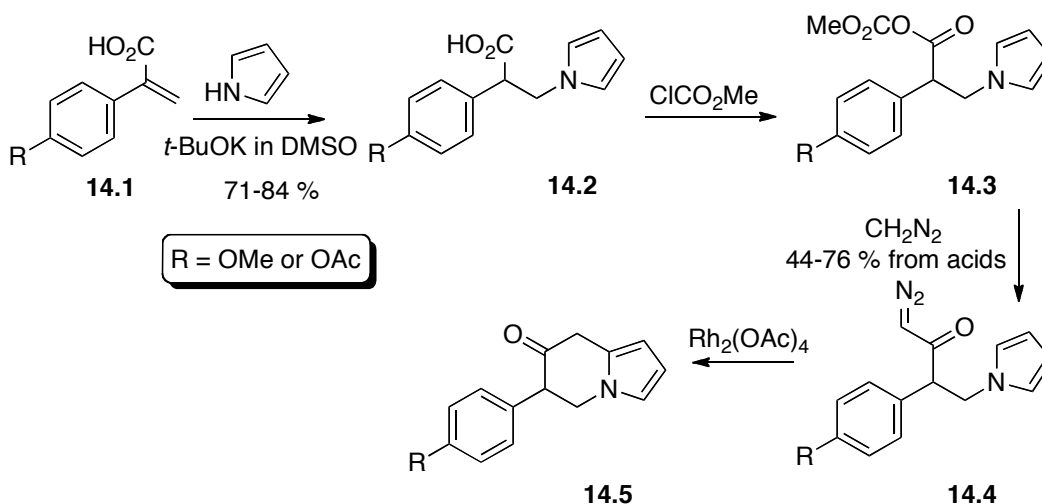

Scheme 14 Total synthesis of (\pm)-ipalbidine by Jefford

Conjugate addition of the anion of pyrrole to **14.1** gave acid **14.2**. Conversion to a mixed anhydride, followed by substitution with diazomethane gave diazoketone **14.4**, which, upon treatment with $\text{Rh}_2(\text{OAc})_4$, gave a carbenoid which was captured by the electrophilic pyrrole ring to generate intermediate **14.5**.

This compound could be converted to intermediate **15.3** (see below) in two different ways. The first involved conversion of the pyrrole to enaminone **15.1**, followed by LiAlH_4 reduction. The second involved global reduction to the alcohol **15.2**, followed by oxidation to generate **15.3**. In the enaminone pathway, the stereochemistry of **15.3** arose from the LiAlH_4 reduction, which leaves the bridgehead hydrogen trans to the aryl group, as we have seen before. In the case of the alcohol **15.2**, the reduction generated as the major isomer the one that has the aryl and alcohol syn.

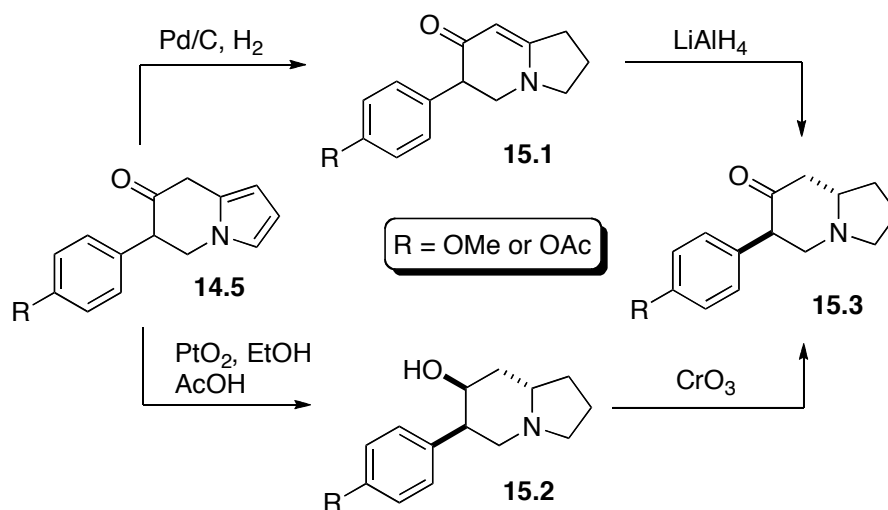

Scheme 15 Reduction of ipalbidine precursors

One interesting aspect of the synthesis involves the possibility of the benzene ring also reacting with the carbenoid, and indeed this side product is observed (Scheme 16). To counteract this side reaction, the authors used a series of different groups at the *para* position, cognizant that a more electron

withdrawing group would suppress the ability of the benzene ring to react with the carbenoid as the ring would be much more electron deficient.

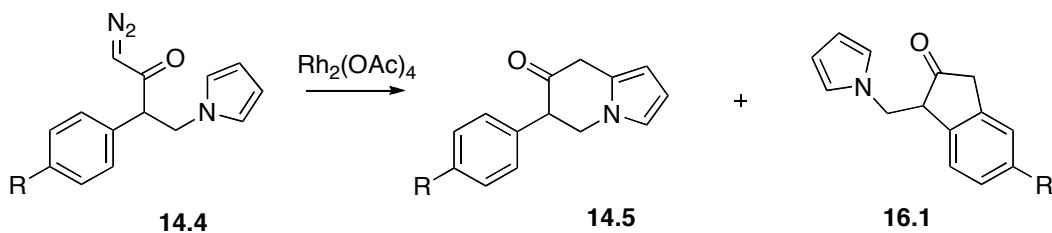

R Group	Ratio (14.5:16.1)	Overall Yield (%)
H	6:1	75
OMe	7:2	89
NO ₂	>100:1	76
OAc	36:1	89
OBz	4:1	85

Scheme 16 Benzene ring interference during carbenoid capture

The *para*-nitro group gives essentially no side product. As seen in Scheme 15, the authors took the *para*-methoxy series all the way to intermediate **15.3** (equivalent to *O*-methyl ipalbidine **4.5**), accomplishing a formal synthesis of (±)-ipalbidine in this fashion. They chose to take the *para* *O*-acetyl substituted pathway all the way to (±)-ipalbidine as the *para* *O*-acetyl derivative provided the best of both worlds; it gave a very good yield of the desired product, and it provided an easily manipulated functionality to release the phenolic hydroxyl

group of the natural product. The final steps from the *O*-acetyl pathway are shown in Scheme 17. They include the methyl installation and deacetylation in one reaction with MeLi, followed by acetylation of the resultant hydroxyls. Under acidic conditions, the tertiary acetate is eliminated, and the phenolic hydroxyl is deprotected to give (\pm)-ipalbidine.

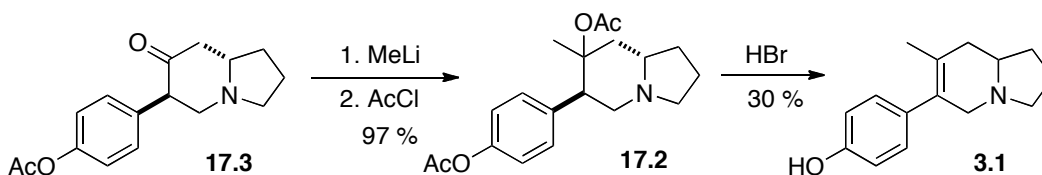

Scheme 17 Completion of (\pm)-ipalbidine synthesis

1.2.9 Total synthesis of (\pm)-ipalbidine by Padwa

Padwa has generated a route to 2-pyridones utilizing a [3 + 2] cycloaddition, and he utilized this methodology to generate racemic ipalbidine in

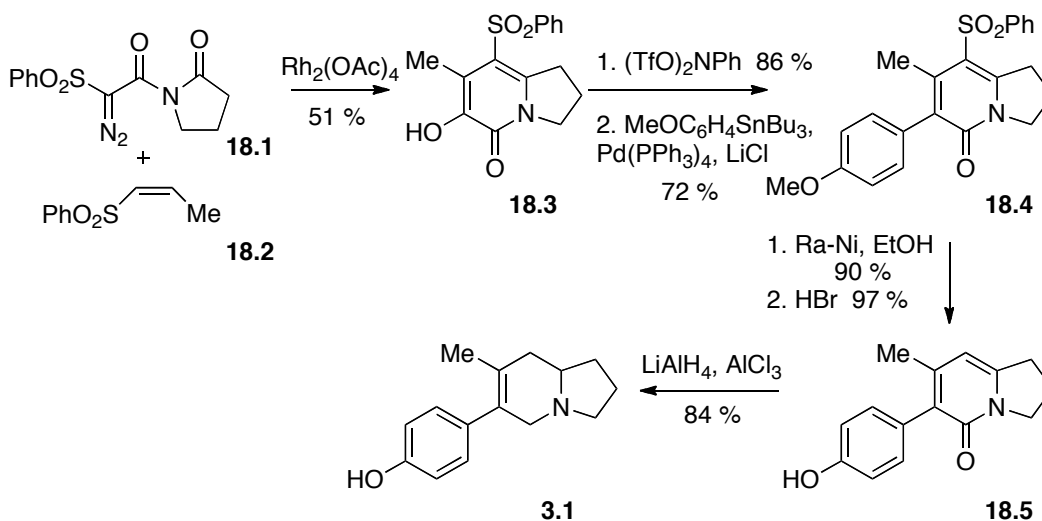

Scheme 18 Total synthesis of (\pm)-ipalbidine by Padwa

ipalbidine in 1997.²⁵

Starting material **18.1** was generated using the Regitz diazo transfer reaction.²⁶ Upon treatment with $\text{Rh}_2(\text{OAc})_4$, a carbenoid was generated that rearranged to the carbonyl ylide **19.1** (see below), which in the presence of olefin **18.2**, undergoes a [3 + 2] cycloaddition. The cycloadduct **19.2** was not isolable, as it rapidly undergoes ring opening to generate compound **18.3**.

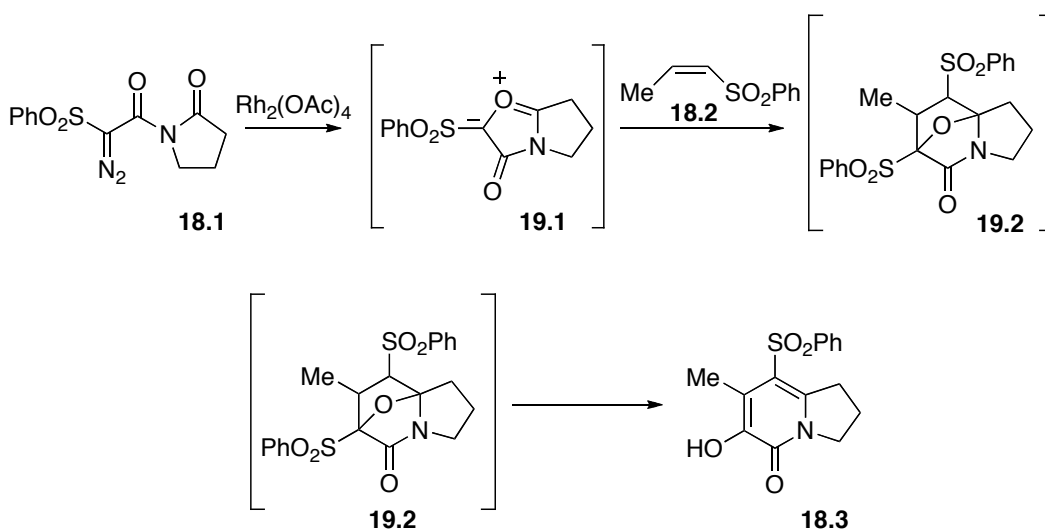

Scheme 19 *Pyridone formation via [3 + 2] cycloaddition*

Conversion of the hydroxyl group into a triflate followed by Stille coupling generated intermediate **18.4** (Scheme 18). The sulfur functionality was removed by Raney-nickel reduction, and the aryl methoxy group was deprotected with HBr; a final reduction with AlH_3 gave (\pm)-ipalbidine. Thus, from the pyridone building block, Padwa developed a pathway towards indolizidine

alkaloids that, with different Stille coupling partners, could potentially lead to several different analogs.

1.2.10 Total synthesis of (\pm)-ipalbidine by Ishibashi

In 1999, Ishibashi attempted to generate a route to optically pure indolizidine alkaloids and to (+)-ipalbidine that would include a radical cyclization.²⁷ His efforts began with an intermediate he generated from L-proline, as can be seen in Scheme 20.

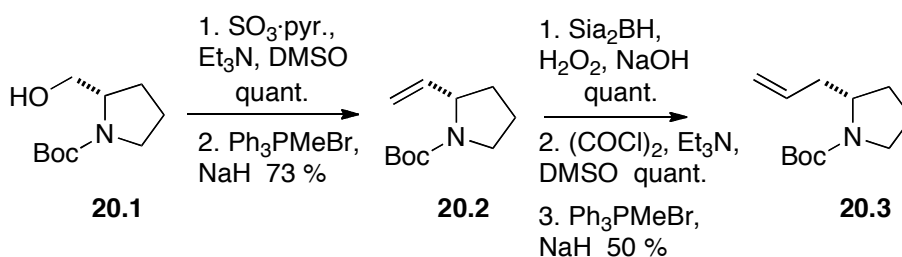

Scheme 20 Preparation of amino precursor from L-proline

N-Boc-(*S*)-prolinol (**20.1**) was derived from L-proline by *N*-protection, followed by BH₃·SMe₂ reduction. The alkyl chain was extended by oxidation and Wittig olefination to the alkene **20.2**. Hydroboration and basic peroxide workup then gave the extended alcohol, which was again extended as before, only this time Swern oxidation was used. Wittig olefination then installed the double bond that would become the site of radical attack (**20.2** → **20.3**).

The first generation synthesis involved creating the radical from a sulfur-carbon bond. After generating compound **21.4** from the acid chloride following $\text{CF}_3\text{CO}_2\text{H}$ -mediated *N*-deprotection, treatment with Bu_3SnH gave no ring closure and left only starting material.

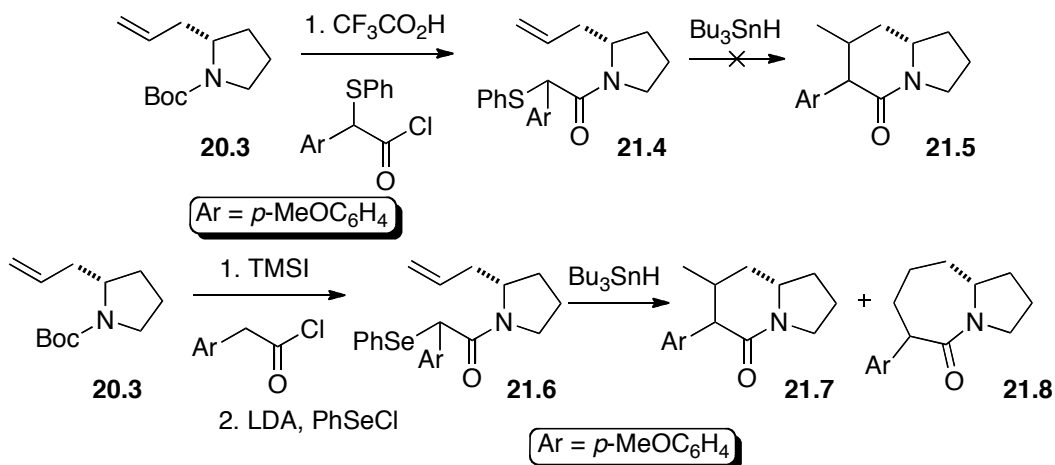

Scheme 21 Preparation of radical cyclization precursors and side product formation

The second attempt used the selenium congener (**21.6**); however, this provided the desired 6-*exo-trig* product (**21.7**) in only 21% yield, as well as generating the undesired 7-*endo-trig* side product (**21.8**) in 16% yield. In previous work, the authors had shown that by adding sulfur to the terminus of the radical accepting olefin, the desired 6-*exo-trig* cyclization²⁸ was promoted. This is most likely due to the stabilization of the radical by the adjacent sulfur, and a final route was developed taking this into account.

Aldehyde **22.1** was extended using the Wittig reaction. The radical donor portion of the molecule was then attached to the deprotected nitrogen as before, via an acid chloride, and the phenylthio group was installed thereafter to give precursor **22.2**. Radical cyclization then generated the desired 6-*exo-trig* product **22.3** in 65% yield. Oxidation of the sulfur and cis-elimination generated the *exo* double bond, which rearranged to the desired product (**22.3** → **22.4**). Amide reduction (with AlH_3) and Lewis acid deprotection then gave (\pm)-ipalbidine.

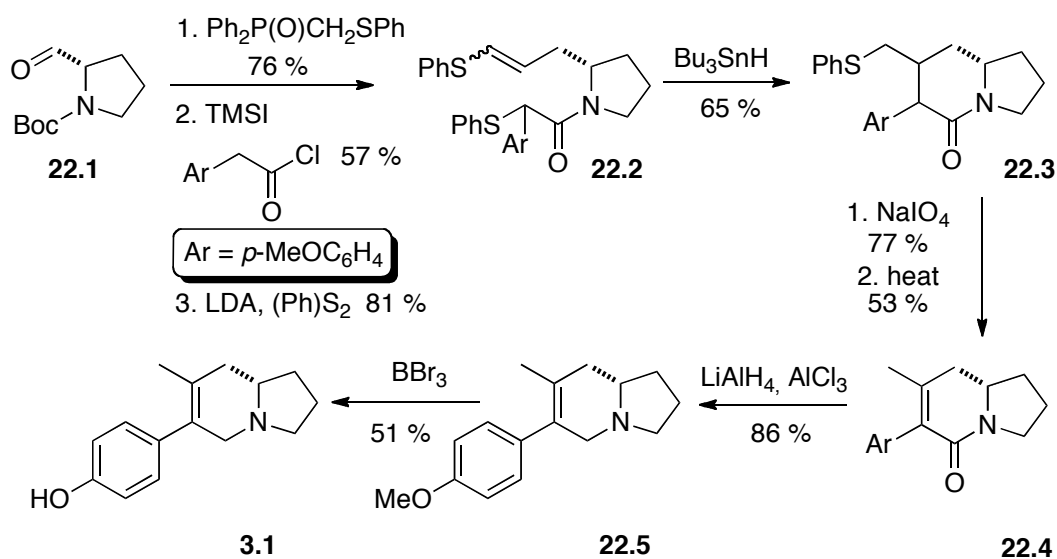

Scheme 22 Total synthesis of (\pm)-ipalbidine by Ishibashi

The authors had initially hoped that this route would provide an asymmetric approach to the core of indolizidine alkaloids and to ipalbidine itself; however, they noted that the specific rotation was nearly zero and the melting point of the picrate derivative matched the previously reported melting point of the racemic picrate.¹² The authors believe that it was during the Wittig olefination

that epimerization may have occurred. Although the synthesis had been intended to generate ipalbidine in optically pure form, racemization took place and therefore Ishibashi's work has been categorized as such and dealt with in this section.

1.2.11 Conclusions

From an overview of the series of racemic syntheses, it is apparent that a wide range of methods can be used to create the core of these indolizidine alkaloids. From simple aldol and Claisen condensations, to Diels-Alder reactions and [3 + 2] cycloadditions, the methodology displayed has been diverse. However, in order to generate compounds such as ipalbidine and other alkaloids of this kind in an asymmetric fashion, it is obvious that other considerations are required. Ishihara's synthesis exemplified the inherent difficulty in preserving the integrity of the stereocenter in ipalbidine precursors and, if starting from the amino acid chiral pool (L-proline), appropriate precautions must be taken.

1.3 Asymmetric syntheses of (+)-ipalbidine

At this point, the three published asymmetric routes to (+)-ipalbidine will be examined, along with strategies for solving the epimerization problems described above.

1.3.1 Asymmetric synthesis of (+)-ipalbidine by Liu

In 1985, Liu was the first to attempt the total synthesis of ipalbidine in an asymmetric fashion.²⁹ Starting from L-proline, it was hoped that the existing stereocenter could be preserved throughout the synthesis. This was done by first protecting L-proline with a benzyloxycarbonyl (Cbz) group and then treating a

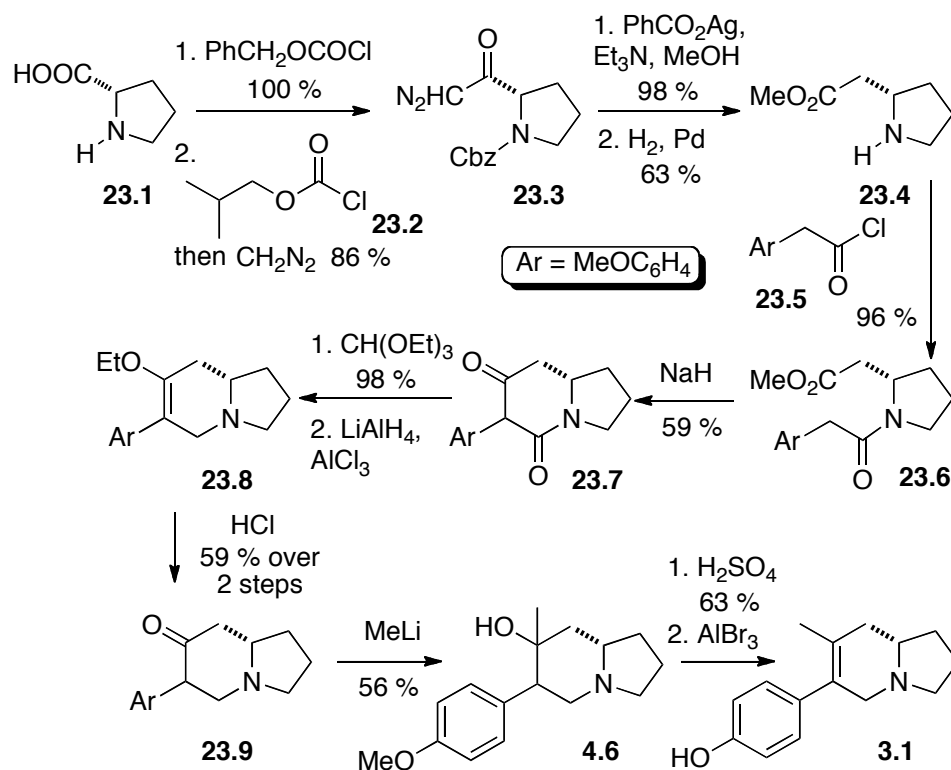

Scheme 23 Partial asymmetric synthesis of (+)-ipalbidine by Liu

mixed anhydride, formed by reaction of the free acid with acid chloride **23.2**, with diazomethane (**23.1** \rightarrow **23.3**). Wolff rearrangement of the acyl species, followed by nitrogen deprotection, gave amine **23.4**. Acylation of the nitrogen with acid chloride **23.5** gave the cyclization precursor **23.6**, which, upon treatment with

NaH, closed in 59% yield to the indolizidine compound **23.7**. Protection of the ketone carbonyl as an enol ether was followed by reduction of the amide (**23.7** → **23.8**) with AlH_3 . Release of the enol ether, followed by treatment with MeLi and sulfuric acid, gave a precursor (**4.6**) which was carried forward to the natural product following Lewis acid mediated deprotection (**23.9** → **3.1**).

The authors reported an $[\alpha]_D^{25}$ value of +54.1 ($c = 1.00$, EtOH). This value is very different from that reported by Wick after his resolution of racemic ipalbidine, in which (+)-ipalbidine was reported to have an $[\alpha]_D^{25}$ value of +233 ($c = 1.00$, CHCl_3).¹² Therefore, there was extensive epimerization at some point during this synthesis, possibly during the initial manipulation of L-proline (formation of **23.3**) or its subsequent derivatives (**23.4-23.8**) under basic or acidic conditions, much like Ishihara observed during his synthesis. Being the first asymmetric synthesis, this attempt shows that beginning from L-proline would prove to be a difficult challenge.

1.3.2 Asymmetric synthesis of (+)-ipalbidine by Honda

In 2003, Honda published an asymmetric route to (+)-ipalbidine by making use of the double bond disconnection in the six membered ring of the indolizidine structure.³⁰ Rather than utilizing L-proline, Honda began his synthesis with L-pyroglutamic acid (**24.1**) and envisioned a ring closing metathesis as his key step.

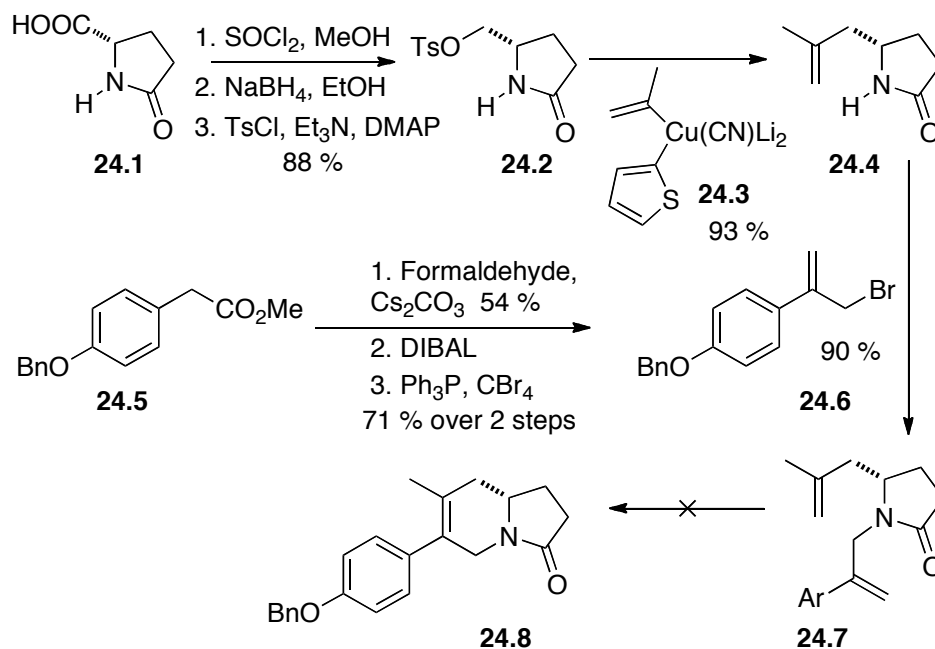

Scheme 24 First generation synthesis of (+)-ipalbidine by Honda

The first generation synthesis involved derivatization of L-pyrroglutamic acid by first converting the acid functionality to an ester,³¹ followed by its reduction and transformation of the resulting alcohol to a tosylate³¹ (**24.1** \rightarrow **24.2**). Coupling of the tosylate with the freshly prepared cuprate **24.3** installed the first double bond for the ring closing metathesis. The second synthesis was carried out by alkylation of the nitrogen using bromide **24.6**, which was prepared from the benzylic ester **24.5**. Unfortunately, the ring closing metathesis did not work with Grubbs' catalyst,³² the Hoveyda catalyst,³³ or Schrock's catalyst,³⁴ as none of the desired product could be isolated. The authors therefore revised their approach and switched their attention to a McMurry coupling.³⁵

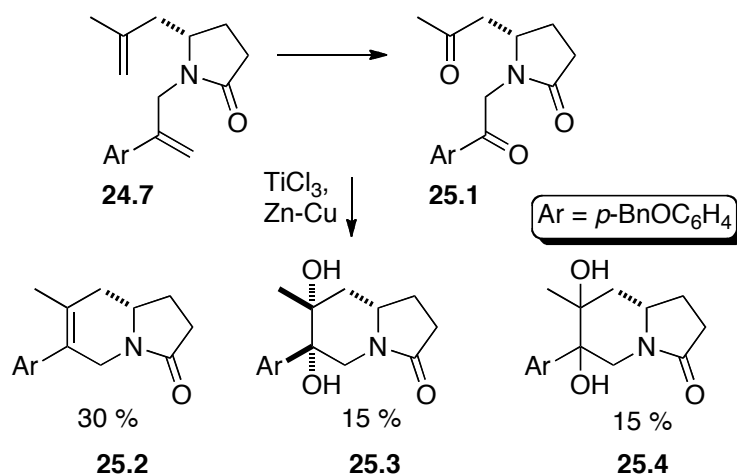

Scheme 25 Indolizidine core via McMurry coupling

Conversion of the previously generated diene to diketone **25.1** provided the McMurry precursor which, upon treatment with TiCl₃ and Zn-Cu couple, gave a mixture of products (Scheme 25). The first set of conditions produced the desired olefinic compound **25.2** in only 30% yield, together with the recovery of diol **25.3** (15%), whose stereochemistry was determined by X-ray analysis, and diol **25.4** (15%), whose stereochemistry could not be determined. The authors then carried **25.2** to (+)-ipalbidine by first reducing the amide functionality with LiAlH₄, followed by deprotection by hydrogenolysis (Scheme 26).

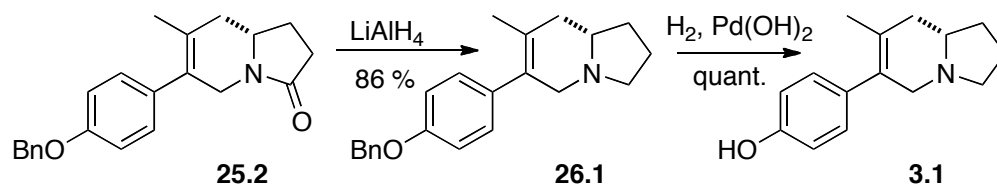

Scheme 26 Completion of the total synthesis of (+)-ipalbidine

The authors deemed the yield of the previous McMurry coupling to be unsatisfactory, and therefore they used a modified procedure whereby generation of the diols was encouraged. When the reaction was run for just 6 h, the main product was diol **25.3** in 66% yield, and the diol **25.4** was recovered in only 6% yield.

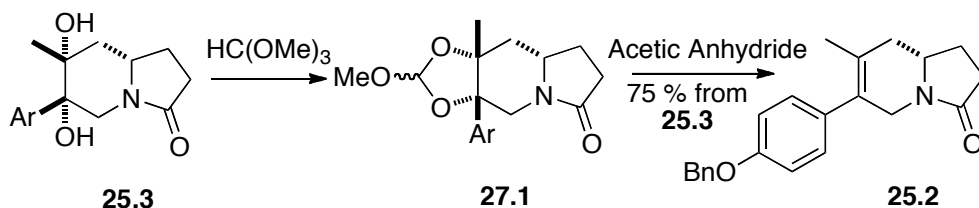

Scheme 27 *Modified approach to the (+)-ipalbidine precursor*

Diol **25.3** was then converted into acetals **27.1** and treated with acetic anhydride; intermediate **25.2** was then carried forward to (+)-ipalbidine as in Scheme 26.

Honda reported an $[\alpha]_D^{25}$ value of +158.6 ($c = 0.8$, MeOH) and of +189.4 ($c = 1.00$, CHCl_3). The value in chloroform is not close to Wick's¹² $[\alpha]_D^{25}$ value of +233 ($c = 1.00$, CHCl_3), and therefore this asymmetric synthesis by Honda appears to have incurred epimerization problems that plagued both Ishihara and Liu. However, the authors expressed the view that their strategy ensured that their product was optically pure! Possibly, epimerization occurred at the stage of **25.1** or **24.7**.

1.3.3 Asymmetric synthesis of (+)-ipalbidine by Georg

In 2010, Georg published a total synthesis of (+)-ipalbidine³⁶ that incorporated her methodology of generating asymmetric enaminones³⁷ and for coupling aryl³⁸ groups to the α carbon of the enaminone functionality. The enaminone methodology included the conjugate addition of ynones derived from L-proline to form the indolizidine core structure, and the key to this procedure is the complete avoidance of β -epimerization during the cyclization (**28.3** \rightarrow **28.5**), which could occur through a retro-Michael/Michael process of the protected amide nitrogen in the proline-derived five membered ring.

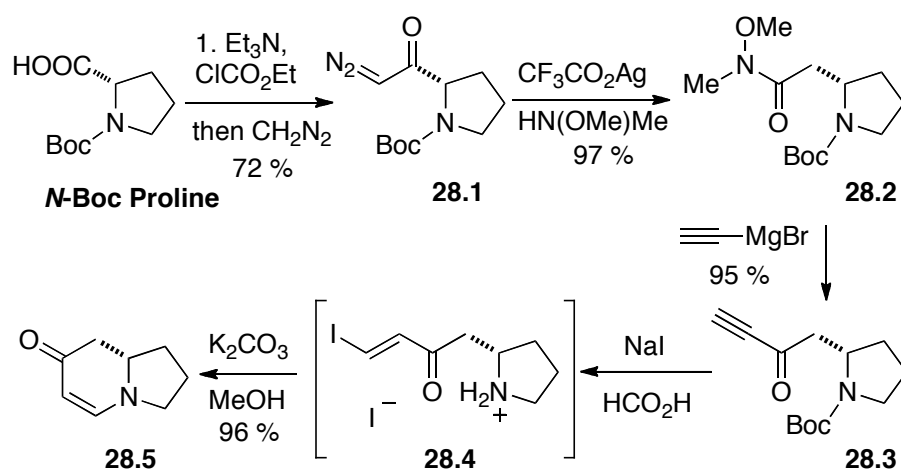

Scheme 28 Indolizidine core formation via ynone conjugate addition

As can be seen in Scheme 28, L-proline can be converted to the desired ynone by creating a mixed anhydride, followed by treatment with diazomethane (**23.1** \rightarrow **28.1**). Wolff rearrangement to the ketene, followed by capture with the appropriate amine, gave Weinreb amide **28.2** and treatment with ethynylmagnesium bromide gave the cyclization precursor.

The yield and reaction time of the cyclization depends on the method of Boc deprotection. In their previous work,³⁷ the authors found that HCl or TMSI not only removes the Boc group, but that the counteranions from these reagents also carry out conjugate addition to the ynone. This addition primes the compound for a 6-*endo-trig* cyclization when the environment becomes basic, as can be seen in intermediate **28.4** (which crystallized out of solution and was characterized via X-ray analysis). The conjugate base of CF₃CO₂H does not carry out conjugate addition to the triple bond, thus leaving the ring closure as a 6-*endo-dig* closure under basic conditions, which apparently does not occur in as high a yield as those examples deprotected with HCl or TMSI for which the closure is an *endo-trig* closure.

Unfortunately, when using either HCl or TMSI, the authors noted that the possibility of β -epimerization is high, and therefore a different set of deprotection conditions was required that would provide all of the qualities discussed previously, without the β -epimerization. As it turned out, formic acid, in the presence of NaI, gently deprotected the Boc group and the iodine activated the ynone so that, upon basification, the reaction proceeded in high yield with no epimerization. MeOH appeared to be the best solvent for this deprotection, and therefore basification via the simple addition of K₂CO₃, following deprotection, allowed for a one pot method of forming the products. It was this set of optimized conditions that was utilized during the synthesis of the (+)-ipalbidine precursor **28.5** (Scheme 28).

The next challenge of the synthesis was the introduction of the aryl group onto the cyclized intermediate **28.5**. One such method involved the installation of iodine at the enaminone α carbon, followed by a Suzuki-Miyaura coupling reaction.³⁹ However, the authors envisioned a more direct approach involving C-H insertion, and had developed this methodology in previous work.³⁸ The conditions discovered by the authors included the use of catalytic Pd(OAc)₂ in the presence of Cu(OAc)₂ as the stoichiometric oxidant, and involved trifluoroborates as the coupling partner. The authors applied both methods to the synthesis of (+)-ipalbidine.

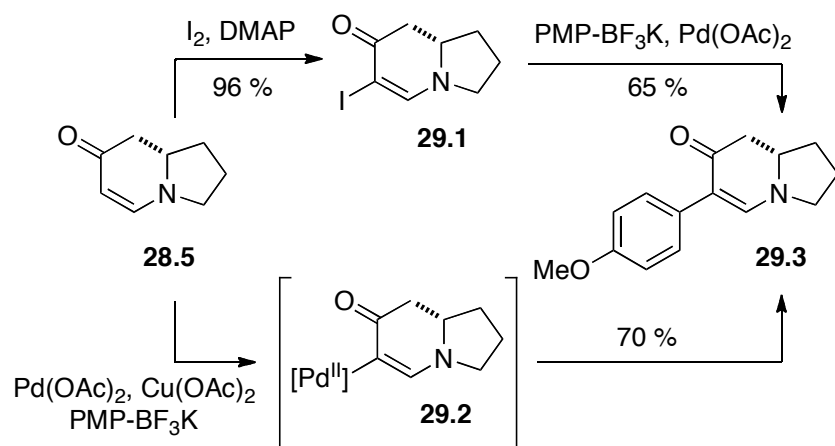

Scheme 29 Installation of aryl component

The first method introduced the iodine in 96% yield in the alpha position by using I₂. This step was followed by coupling with the trifluoroboronate to generate intermediate **29.3** in 65% yield. Utilizing their method of C-H insertion, the authors were able to generate the same compound in 70% yield over one step

via **29.2**. With the aryl group installed, a variation of Liu's²⁹ endgame was followed to reach the natural product.

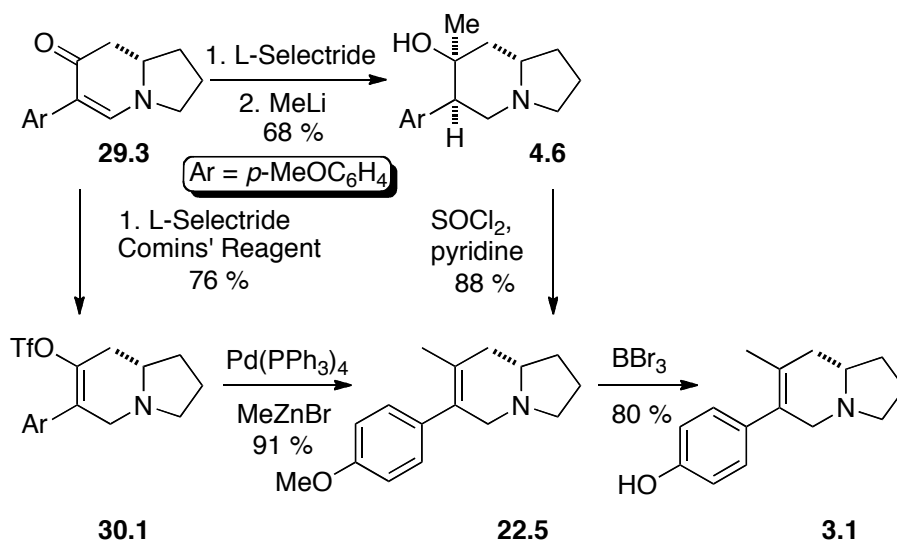

The first approach involved reduction of the enaminone double bond with L-Selectride followed by installation of the methyl group with MeLi (**29.3** → **4.6**). The dehydration step proved to be more difficult than expected, but use of SOCl₂ and pyridine ultimately gave the highest yield to generate (+)-ipalbidine precursor **22.5**. This precursor could also be made in a different fashion, by trapping the enolate from the L-Selectride reduction as a triflate. Coupling with MeZnBr then gave **22.5**. Removal of the *O*-methyl group under Lewis acidic conditions provided (+)-ipalbidine.

The authors reported an $[\alpha]_D$ value of +202 ($c = 1.00$, CHCl₃), which is reasonably close to the $[\alpha]_D^{25}$ value of +233 ($c = 1.00$, CHCl₃) reported by

Wick.¹² The authors also used chiral HPLC to confirm the optical purity of their sample. Using a Chiralcel OJ column, they found the enantiomeric ratio to be 98:2, confirming the success of this synthesis in preserving the stereochemistry. This value suggests that the *ee* of the compound made by Honda $[[\alpha]_D^{25}$ value of +189.4 ($c = 1.00$, CHCl_3), was 90%.

1.4 Conclusions

From these asymmetric syntheses of (+)-ipalbidine, it is apparent that to create this compound and other indolizidine alkaloids from the amino acid chiral pool, one must avoid β -elimination of any susceptible precursors during the synthesis. With this in mind, I set out to complete the total synthesis of (+)-ipalbidine in an effort to expand the scope of the ICD methodology.

2. Results and Discussion

2.1 The Intramolecular Conjugate Displacement (ICD) reaction

During an S_N2' reaction, there is a nucleophilic attack on the double bond of an allyl system, causing a shift of the double bond and displacement of a leaving group (**31.1** \rightarrow **31.3**), as the reaction proceeds in what is believed to be a concerted manner (though this is surprisingly contentious in certain allylic systems).⁴⁰ To clarify the previous statement, in certain cases, an S_N2' may really be an allylic rearrangement followed by a substitution, or rearrangement of an S_N2 product. One must be careful to eliminate the latter possibilities before labeling any reaction as a true S_N2' .

If one were to place a Michael acceptor (an electron withdrawing group) on the central carbon of an allylic system bearing a leaving group, the reactivity of what appears to be a S_N2' could be greater than in its absence. The resultant reaction might be a hybrid of the classical Michael reaction and $E1_{CB}$ elimination, mimicking the outcome of an S_N2' reaction (the true mechanism of this "hybrid" process will be revisited later). Such a process would be useful in organic synthesis (shown in general from **31.4** \rightarrow **31.5**), because S_N2' prime reactions do not always work and this modification would be an excellent way of solving this reactivity issue.

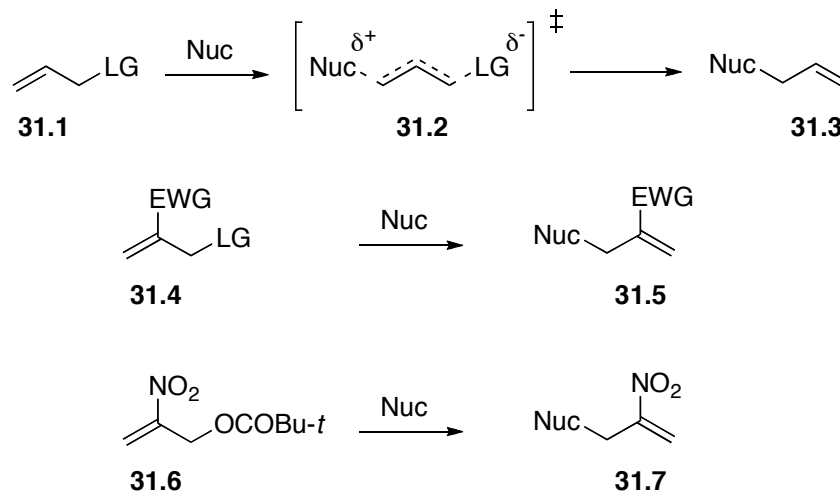

Scheme 31 *The S_N2' reaction and the intramolecular conjugate displacement (ICD)*

An early example of this reactivity was examined by Seebach,⁴¹ in an intermolecular case, via the displacement of an acid leaving group in the presence of organolithium and Grignard nucleophiles with a nitro group functionality on the central carbon (**31.6** \rightarrow **31.7**).

This reactivity was applied in an intramolecular sense only occasionally, such as in the generation of azamacrocycles⁴² (nitrogen as the nucleophile) or for cross-linking proteins.⁴³ Previous goals of this group were to expand the scope of this methodology in an intramolecular sense; this would highlight its usefulness in the field of synthetic organic chemistry. Following this work, the reaction was dubbed the "intramolecular conjugate displacement" (ICD) reaction.

The mechanism of this reaction⁴⁴ was also explored for all-carbon examples, in an effort to deduce whether or not it is a concerted S_N2' process, or a Michael addition followed by an E1_{CB} elimination. It appears that the nature of the leaving group dictates whether or not the reaction is stepwise or concerted, as the anionic Michael adduct could be isolated, but only in situations where the leaving group was poor (-OSiEt₃). The only conclusions are that in cases with better leaving groups (-OCOCH₃), the reaction is either concerted or the intermediate too short-lived to isolate or capture.

2.2 The intramolecular conjugate displacement (ICD) reaction and its use in total synthesis

As mentioned in the introduction (see Section 1), the aza-ICD reaction proved to be an extremely useful reaction when applied to the total synthesis of

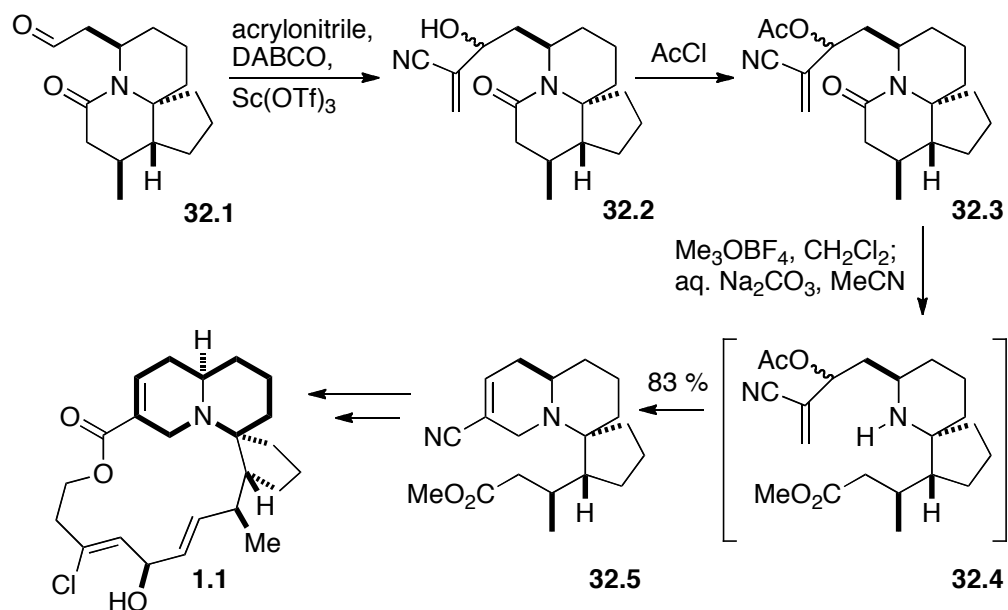

Scheme 32 The ICD and its use in the total synthesis of (+)-halichlorine

(+)-halichlorine (**1**), published previously by this group.² For this natural product, it was the quinolizidine core (highlighted in **1** and formed in **32.5**) that was generated via this process (Scheme 32).

In the halichlorine example, it was a nitrile that was used as the electron withdrawing group, allowing the cyclization to take place in 83% yield. Following the publication of this natural product, our group decided to explore the scope of the aza-ICD and its ability to access other alkaloid core structures (Scheme 33)⁶ in an asymmetric sense, shown in general form for the indolizidine alkaloids in Scheme 33.

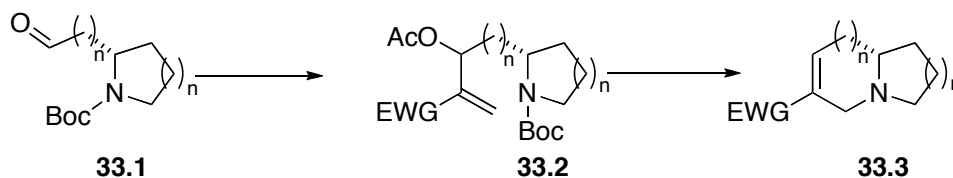

Scheme 33 Preparation of alkaloid core structures via the ICD reaction

The preparation of the small indolizidine alkaloid (-)- δ -coniceine (**3.3**) was also included in this research (Scheme 34). The successful synthesis of **3.3** would show the usefulness of the aza-ICD approach for accessing the core structures of these alkaloids from the chiral pool, and would prove a launching point for the retrosynthesis of the more complex (+)-ipalbidine.

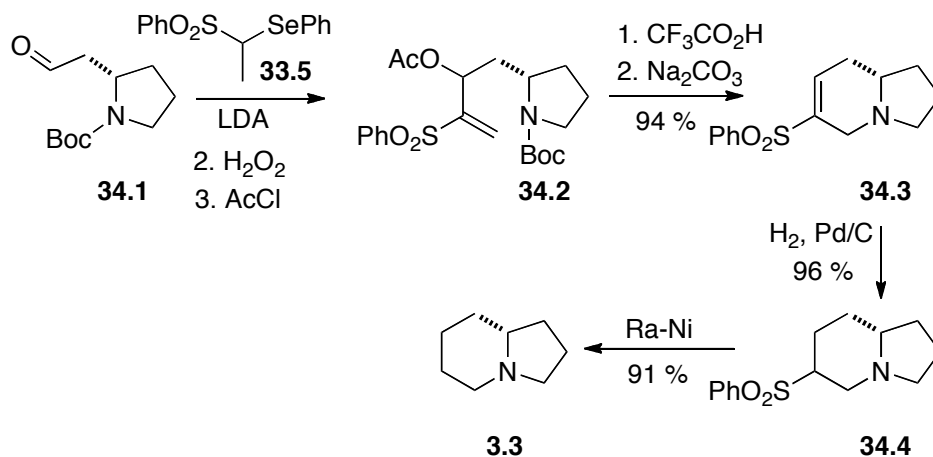

Scheme 34 *The ICD and its use in the total synthesis of (-)- δ -coniceine*

2.3 Research Objectives

The objectives of this research were twofold. The first was to develop an asymmetric and flexible route to the core structure of the indolizidine alkaloids, highlighted by the total synthesis of (+)-ipalbidine from L-proline. Initial efforts would focus on utilizing the ICD reaction to access the indolizidine core. It would be during this synthesis that different substituents on the central carbon of the allyl system of an ICD precursor would be used in an effort to glean further mechanistic insight into this reaction, constituting the second purpose of the work.

2.4 Attempted total synthesis of (+)-ipalbidine: Use of the ICD reaction on an *N*-Boc protected substrate

2.4.1 ICD based retrosynthesis of (+)-ipalbidine

The initial retrosynthesis of (+)-ipalbidine included the use of the ICD reaction to form the indolizidine core structure. For this compound, a phenyl group rather than a Michael acceptor would be placed on the central carbon of the allyl system, and we wished to see whether the ICD reaction would proceed.

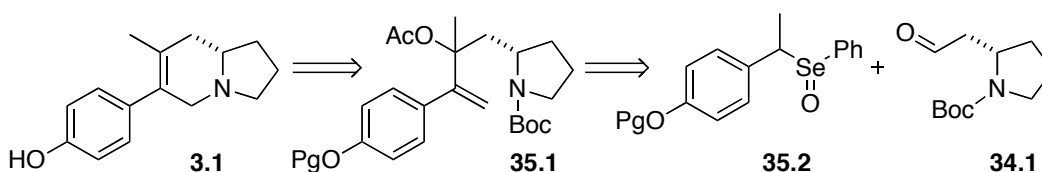

Scheme 35 First generation ICD based retrosynthesis of (+)-ipalbidine

The introduction of the phenyl group was envisioned to occur via anionic condensation of selenoxide **35.2** with the L-proline-derived **34.1**, which had been previously made in our group (Scheme 36).

2.4.2 Synthesis of the L-proline-derived aldehyde

The L-proline-derived aldehyde **34.1** was generated by carrying out *N*-Boc protection of the proline nitrogen,⁴⁵ followed by borane reduction to the alcohol (**36.1** → **36.2** → **36.3**).⁴⁵ Swern oxidation and Wittig olefination⁴⁶ generated precursor **36.5**, and this enol ether could be hydrolyzed to aldehyde **34.1** via use of Hg(OAc)₂.⁴⁷ Mercuric acetate was necessary, because hydrolysis under acidic

conditions may cause β -epimerization, lowering the optical purity at the beginning. The $\text{Hg}(\text{OAc})_2$ also produces a red salt in the reaction mixture, which is very difficult to remove, even after SiO_2 chromatography. However, after several purification steps, the compound can be isolated in pure form.

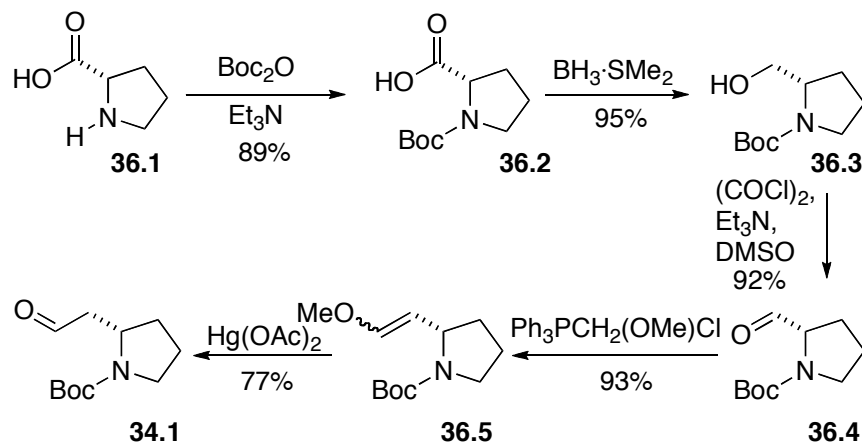

Scheme 36 Preparation of the *L*-proline-derived aldehyde

Although the optical rotation of our **34.1** $[[\alpha]_D^{25} +36.0$ ($c = 1.5$, MeOH)] did not match that of another group $[[\alpha]_D^{25}$ value of $+46.5$ ($c = 1.5$, MeOH)],⁴⁸ we continued, based on the knowledge that this method had been used in the synthesis of (-)- δ -coniceine, whose $[\alpha]_D^{25}$ value of -18.27 ($c = 0.15$, EtOH) fell into the range of reported values.⁴⁹ We were also confident of this compound's optical purity because an *ee* value of 99.8% was determined by HPLC for ICD product **37.2**, a compound derived from aldehyde **34.1**.^{2a}

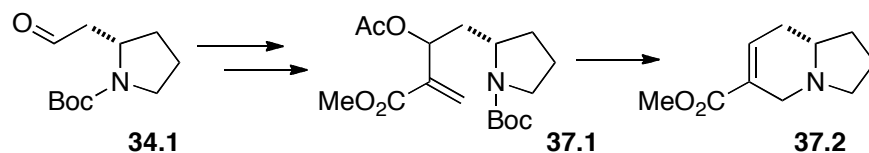

Scheme 37 Preparation of an optically pure indolizidine compound via ICD

2.4.3 Selenoxides as allylic alcohol synthons

The selenoxide anions that we wished to use during our synthesis had been previously shown by Reich⁵⁰ to be stable at low temperature (-78 °C) and also resistant to selenoxide elimination. Upon α -deprotonation, they add to both aldehydes and ketones, and after warming to room temperature, they then undergo elimination to form allylic alcohols (Scheme 38).

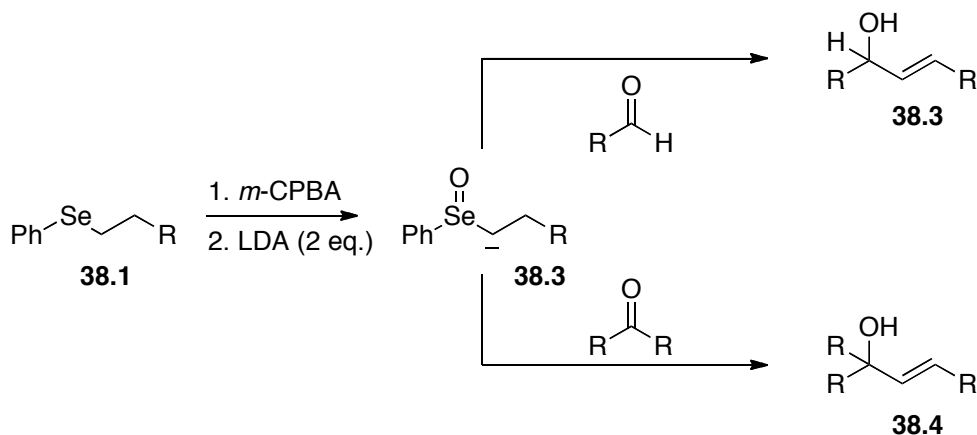

Scheme 38 Reich's use of selenoxides as allylic alcohol synthons

There were two selenides that we wished to use. The first was synthesized from α -methyl benzyl alcohol, benzeneselenocyanate and tributylphosphine, and condensed with aldehyde **34.1**, as shown in Scheme 39.

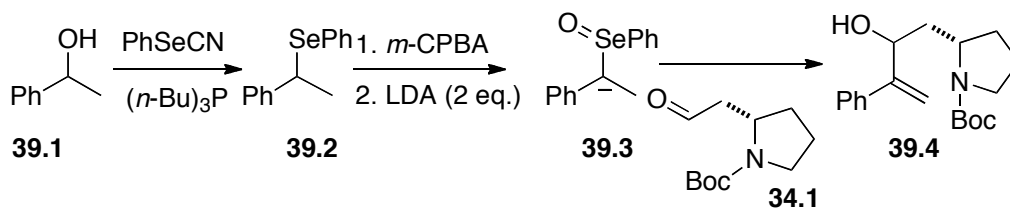

Scheme 39 Attempted use of Reich's selenoxides for allylic alcohol installation

Unfortunately, Reich's conditions proved ineffective in generating the desired allylic alcohol **39.4**. Initially, only a mixture of the two starting materials was observed when using standard *m*-CPBA (bought from Aldrich) and therefore a switch to ozone as the oxidant was investigated. However, only a complex mixture was isolated when the crude product of this reaction was analyzed by ^1H NMR. *m*-CPBA was therefore recrystallized before use to remove benzoic acid and water contaminants, in an effort to improve the oxidation and overall yield. In this last attempt, the desired product **39.4** was generated, but only in 23% overall yield, along with recovery of aldehyde **34.1**. It appeared as though the nucleophile generated from **39.2** did not react well with our aldehyde.

The second selenide we used was similar to the first, with the exception of having a *p*-methoxy group. This selenide was generated in a different manner, as the initial conditions (use of PhSeCN) did not work. It was made via a radical mechanism in the presence of PhSeSePh, and included the use of La metal.⁵¹ In the mechanism proposed for this transformation, the alcohol was converted into an alkyl iodide, which was subsequently oxidized by the copper to a radical. This

radical reacts with diphenyl diselenide in solution to generate the selenide (Scheme 40).

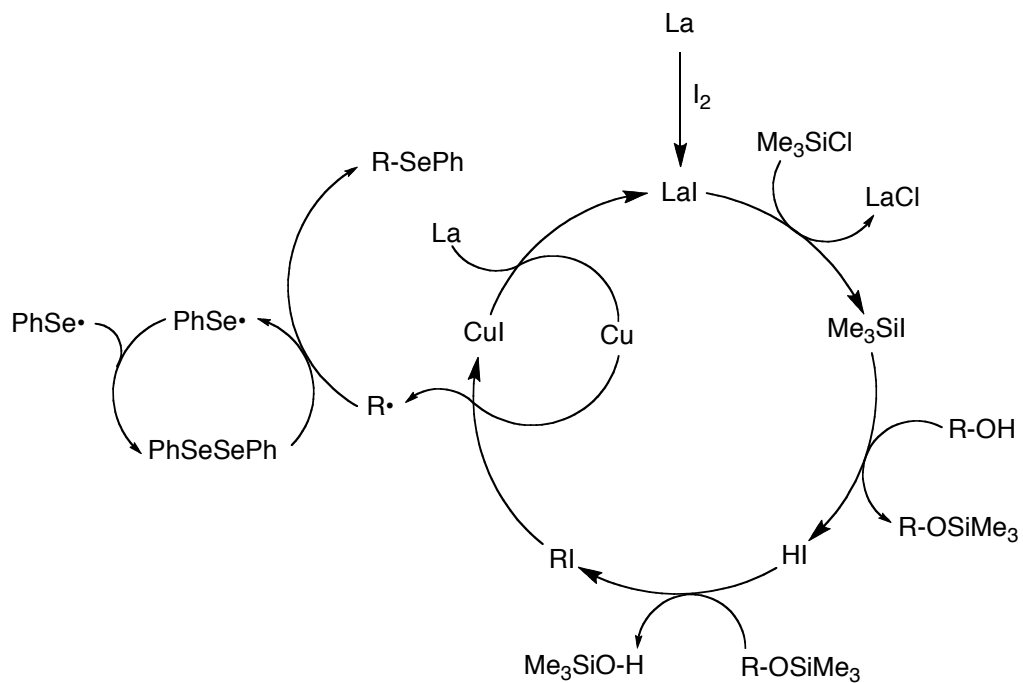

Scheme 40 *Proposed mechanism of selenium substitution*

When using Reich's deprotonation method on the selenoxide derived from this selenide, we found that the starting aldehyde was recovered, and the corresponding styrene **41.7** was detected.

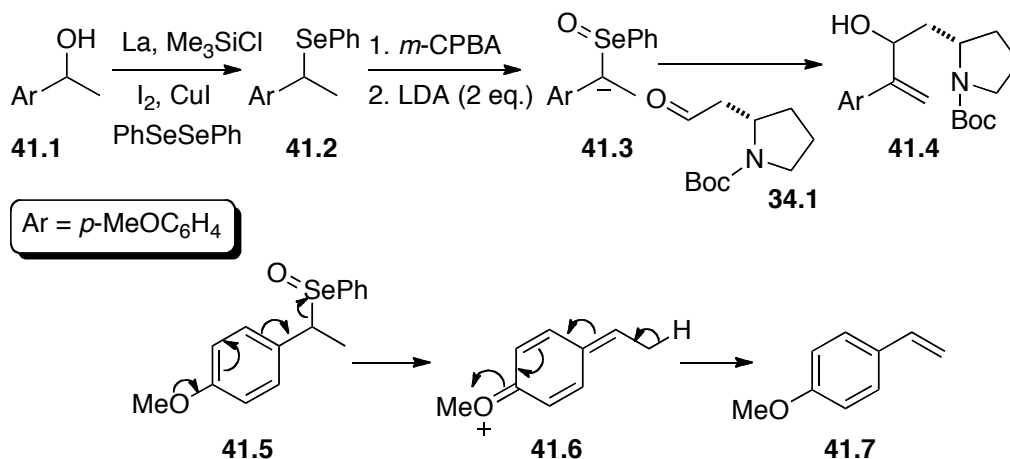

Scheme 41 *Undesired styrene formation using an electron rich selenoxide*

It is possible that following oxidation, the selenoxide is eliminated from the compound by the electron rich aryl ring, and the injected base simply serves to deprotonate the compound to the styrene. In any case, Reich's method of adding deprotonated selenoxides to aldehydes did not work on our substrate, and a different synthon was sought for formation of the desired allylic alcohol.

2.4.4 Selenoacetals as allylic alcohol synthons

Since we were having trouble adding selenoxides to our proline-derived aldehyde (**39.4**), we turned our attention to utilizing selenoacetals as an alternative.

Acetals of type **42.3** have been made previously by this group,⁵² and proved to be excellent synthons for allylic alcohols. They are prepared by combining a ketone (in our case, acetophenone) with tris(phenylseleno)borane **42.2**,⁵³ and, when treated with *n*-BuLi, they serve as selenium-stabilized

nucleophiles that can add to aldehydes. Upon oxidation, the selenoxide eliminates to provide the double bond. However, when applied to our substrate, the nucleophile failed to add to aldehyde **34.1**, and no desired product was detected.

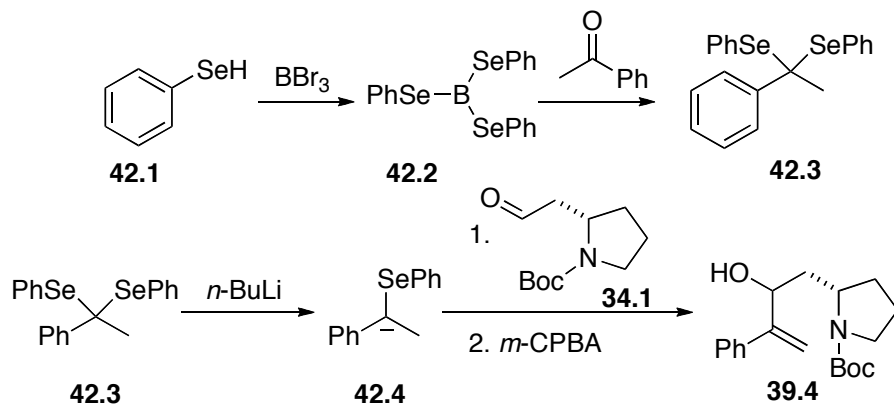

Scheme 42 Preparation and use of selenoacetals as allylic alcohol synthons

Because these selenium based nucleophiles were not adding effectively, we decided to use a more direct approach for generating the desired allylic alcohols.

2.4.5 Use of organometallics to create the allylic alcohol functionality

Because we could not generate the allylic alcohol functionality using selenium based synthons, we decided to generate the allylic alcohol directly from aldehyde **34.1** and an organometallic species (Scheme 43), generated from α -bromostyrene (**43.1**).

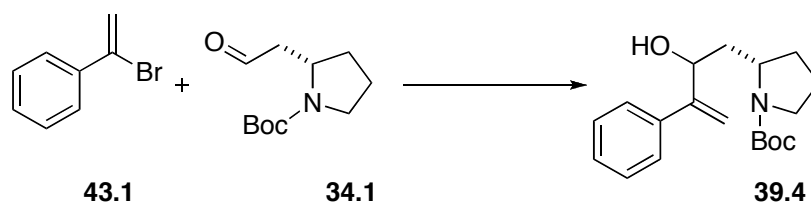

Scheme 43 Use of organometallic styrenes for allylic alcohol formation

2.4.6 Allylic alcohol formation utilizing an organolithium reagent

Our initial approach was to use lithium-halogen exchange by treating α -bromostyrene **43.1** with *t*-BuLi, followed by addition of aldehyde **34.1**. This nucleophile has been generated previously and reported in the literature, albeit by using *n*-BuLi, and the authors had found its stability sufficient to generate yields over 50% when condensing it with aldehydes⁵¹ or with CO₂.⁵⁴ It therefore seemed reasonable that these organolithium compounds were of sufficient stability for our use. For the sake of thoroughness, we would generate the organolithium **44.1** from experiments with *t*-BuLi and with *n*-BuLi.

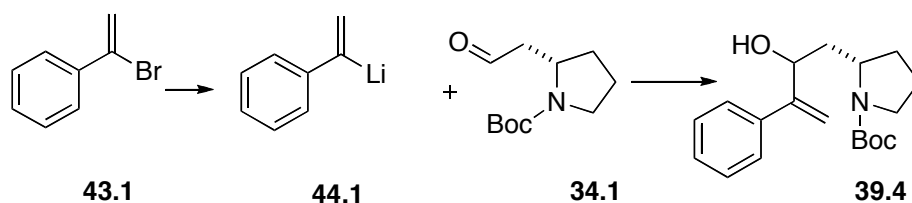

Scheme 44 Organolithium 1,2-addition for allylic alcohol formation

The initial attempts were based on lithium-halogen exchange with *t*-BuLi, but when **44.1** was added to aldehyde **34.1**, a complex mixture was obtained. The outcome was similar when the solvent was changed from ether to THF in an effort

to improve solubility. It was surmised that the anion might be too harsh for the electrophile, and therefore, conversion to the more nucleophilic and less basic organocerate was attempted, by carrying out another metal exchange with dry CeCl_3 . Unfortunately, this appeared to have no impact, as only the aldehyde was detected in the ^1H NMR spectrum of the crude reaction mixture.

The α -bromostyrene that was used in these reactions was made from styrene and bromine, followed by treatment of the isolable intermediate with NaOH .⁵⁵ α -Bromostyrene made in this way is not stable for long periods of time, and an attempt was made to make the α -bromostyrene fresh the same day it was to be used to convert it to the organolithium, and then to treat it with aldehyde **34.1**. This reaction was quenched with D_2O to see if the anion had formed (through the presence of deuterated styrene), but other than noting the presence of aldehyde **34.1**, the ^1H NMR spectrum of the crude reaction mixture was inconclusive. One final attempt using technical grade α -bromostyrene (stable for extended periods of time) purchased from Aldrich was carried out, but no difference in outcome was noted. The possibility arose that this organolithium was too hard to react efficiently with our aldehyde, leading to issues of enolization of the aldehyde or epimerization. Either way, it seemed that the organolithium was unable to condense with our aldehyde.

2.4.7 Intramolecular conjugate addition with a phenyl group

As noted earlier in section 2.4.3, allylic alcohol **39.4** had been generated by the method of selenoxide anion attack. Although it was generated in just 23% yield, we had enough in hand to convert to the corresponding acetate, followed by an attempted ICD reaction (Scheme 45). The acetate was generated in 86% yield, but when the ICD was tried, recovery of only the deprotected amine was detected and therefore, in the presence of the phenyl group, no ICD reaction occurs.

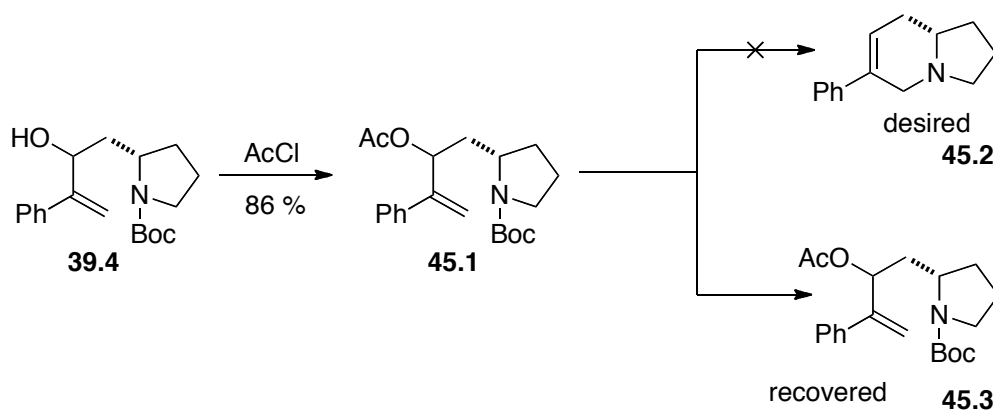

Scheme 45 *Intramolecular conjugate displacement with a phenyl group*

It appears that the phenyl group cannot sufficiently promote the formation of **45.2** with an acetate as the leaving group in an ICD reaction. We felt that a change from an acetate to a mesylate might help to drive the reaction forward. However, we still needed to find a way of generating the allylic alcohol precursor in sufficient yields to test this possibility, and the following sections describe our attempts to do so.

2.4.8 Allylic alcohol formation with Grignard reagents

Because the organolithium did not appear compatible with our aldehyde, conversion of α -bromostyrene to other organometallic reagents seemed logical. The first organometallic tried was conversion of α -bromostyrene **43.1** to the corresponding Grignard reagent **46.1**, its preparation being reported in several previous publications.⁵⁶

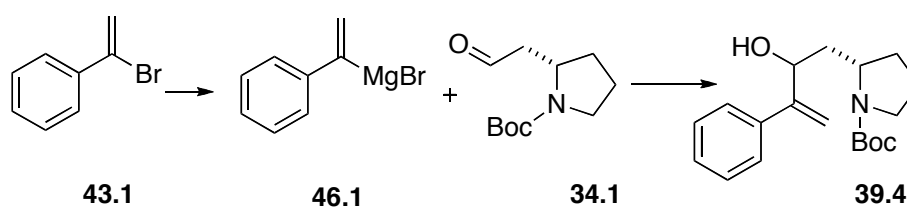

Scheme 46 Grignard 1,2-addition for allylic alcohol formation

The first attempt when using the Grignard reagent gave only the aldehyde starting material. This outcome was due to the difficulties inherent in small scale Grignard preparation. The reaction was therefore carried out again, but this time using a stock solution of the Grignard reagent prepared beforehand. This seemed to give a trace of allylic alcohol **39.4** as judged by the ^1H NMR spectrum of the crude reaction mixture; however, two further attempts could not reproduce this result, let alone provide a higher yield. Although the presence of **39.4** was detected, we surmised that the N -Boc protecting group may be interfering with the Grignard reagent or the nucleophile was again too hard. Therefore, one last attempt using a softer organozinc was carried out.

2.4.9 Allylic alcohol formation using organozinc reagents

The initial attempt to form the organozinc was based on a previous procedure published from this group,⁵⁷ and involved the use of activated zinc dust, while a second was based on metal exchange (Scheme 47).⁵⁸

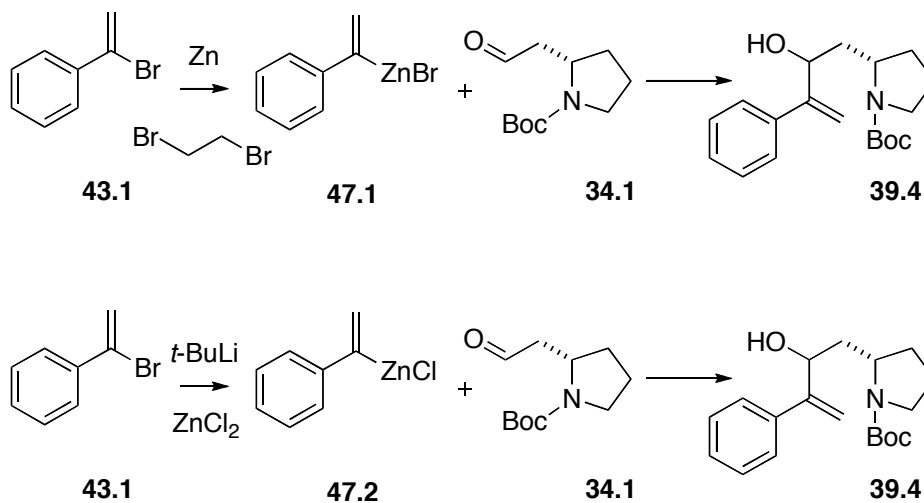

Scheme 47 Organozinc 1,2-addition for allylic alcohol formation

In using the first method of organozinc preparation, allylic alcohol **39.4** was not detected, but α -bromostyrene was still evident in the ¹H NMR spectrum of the crude reaction mixture. It was apparent that the organozinc did not form. In the literature procedure, the zinc insertion took place into an sp³ carbon-iodine bond, whereas in this case, the insertion would be into an sp² carbon-bromine bond. It is possible that this difference stopped the formation of the organozinc, but the possibility remains that the zinc dust was never activated properly in the first place.

The second procedure for organozinc formation included metal exchange between the organolithium formed from α -bromostyrene and a solution of ZnCl_2 .⁵⁸ Following this approach, the starting aldehyde **34.1** was seen in the ^1H NMR of the crude reaction mixture, along with the signals for styrene. No signals for α -bromostyrene were detected, and therefore the organolithium (and hopefully the subsequent organozinc) reagent did form, but not the desired allylic alcohol. It would appear that either the organolithium/organozinc reagent decomposed partially, or as before did not react smoothly with this aldehyde.

2.4.10 Allylic alcohol formation from acid chlorides

At this point it was felt that a modification of the electrophile was in order so as to improve its reactivity. Aldehyde **34.1** seemed to be unreactive towards many of our nucleophiles, and so we had to change the nucleophile or electrophile, or both. The first modification was the conversion of the aldehyde to an acid chloride, in the hope that this would react more readily.

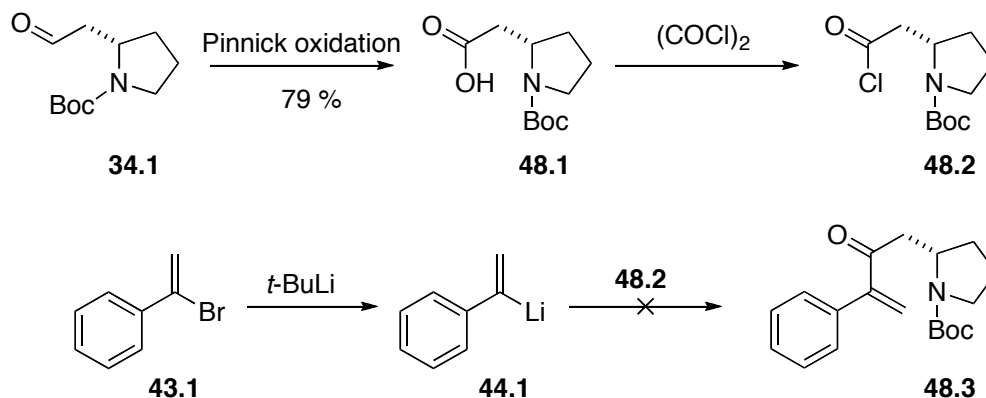

Scheme 48 *Preparation and use of an acid chloride with an organolithium reagent*

Using this acid chloride (whose preparation is shown in Scheme 48) with the organolithium generated from α -bromostyrene (**43.1** \rightarrow **44.1**), we found that the desired ketone **48.3** was not detected. The characteristic signal of the *N*-Boc protecting group was also missing in the ^1H NMR spectrum, suggesting deprotection or decomposition. The acid chloride seemed to be too sensitive to the organolithium nucleophile, and so it was appropriate to use an organocuprate instead (Scheme 49).

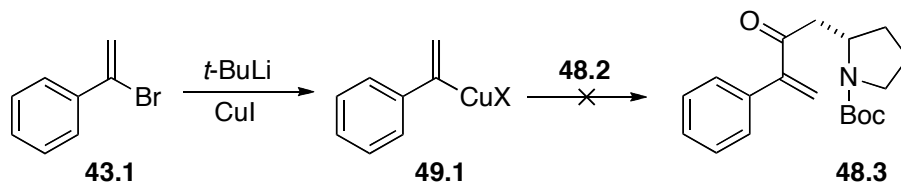

Scheme 49 *Use of an organocuprate with the acid chloride*

In this case, the ^1H NMR spectrum of the crude reaction product showed alkenyl peaks that did not belong to either styrene or α -bromostyrene (**43.1**), but this result could not be repeated on a larger scale and none of the desired product (**48.3**) was isolated.

Because no success was met with the acid chloride, a Weinreb amide was chosen as the next electrophile due to its robust nature and better compatibility with reactive nucleophiles.

2.4.11 Allylic alcohol formation from Weinreb amides

The Weinreb amide was prepared by converting acid **48.1** into a mixed anhydride and subsequently treating it with *N*-methoxy-*N*-methylamine hydrochloride.⁵⁹ With the amide now in hand, it was then treated with the organolithium formed from α -bromostyrene (Scheme 50).

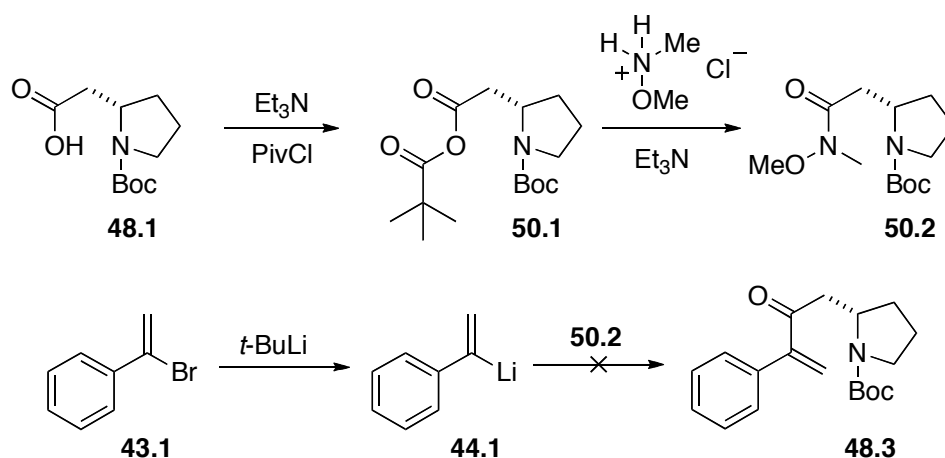

Scheme 50 Preparation of a Weinreb amide and its use with an organolithium

The first attempt was carried out using *n*-BuLi to form the organolithium from α -bromostyrene, but the result of this reaction was recovery of the amide and the detection of trace amounts of styrene. In the second attempt, *t*-BuLi was used for lithium-halogen exchange, but again the outcome was the same.

We felt that as these nucleophiles generated from α -bromostyrene had been used successfully in previous publications, the problem was with the reactivity of the aldehyde. An effort was therefore made to modify its reactivity by converting the aldehyde to other functionalities, but this was to no avail. We therefore surmised that the *N*-Boc protecting group may be incompatible with the strong nucleophiles used in these reactions, and so we set out to use a different protecting group that lacked a carbonyl so that we could use an excess of nucleophile in the hope of improving yields.

2.5 Attempted total synthesis of (+)-ipalbidine: Use of the ICD reaction with an *N*-*p*-methoxybenzyl protected substrate

*2.5.1 Synthesis of a *N*-PMB protected aldehyde*

In an effort to bypass problems that may be due to the *N*-Boc protected compounds, a *p*-methoxybenzyl series was to be used instead. The synthesis of these compounds was very similar to the *N*-Boc series, and began with the double protection of L-proline⁶⁰ using PMBCl, followed by DIBAL reduction to the *N*-PMB protected alcohol **51.2**. This alcohol was carried forward to the extended

aldehyde by first oxidizing it under Swern conditions, followed by Wittig homologation and treatment with aqueous acid (HCl). Due to the extreme polarity of these amines, acid extraction was carried out in order to purify them to avoid column chromatography, as these compounds do not elute readily from silica gel.

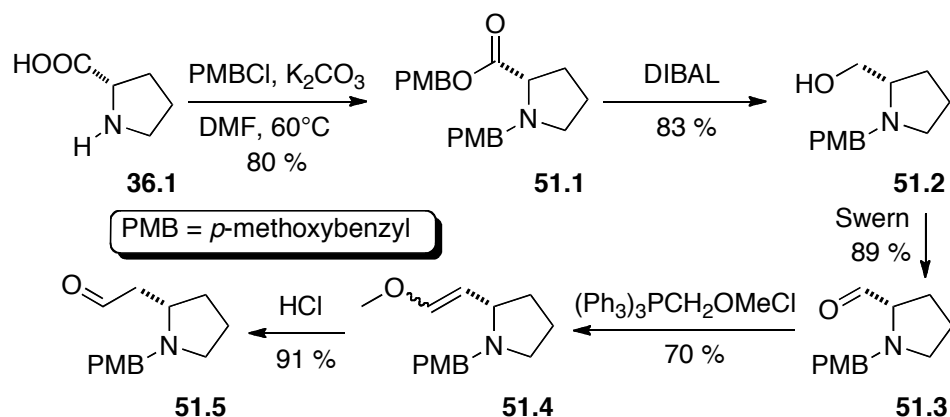

Scheme 51 Preparation of PMB protected aldehyde from L-proline

With **51.5** in hand, many of the same nucleophiles were used as in the *N*-Boc series.

2.5.2 Allylic alcohol formation from an organolithium nucleophile

The first set of experiments with the *N*-PMB protected aldehyde **51.5** involved the use of the organolithium formed from α -bromostyrene (**43.1**), as in the *N*-Boc protected series.

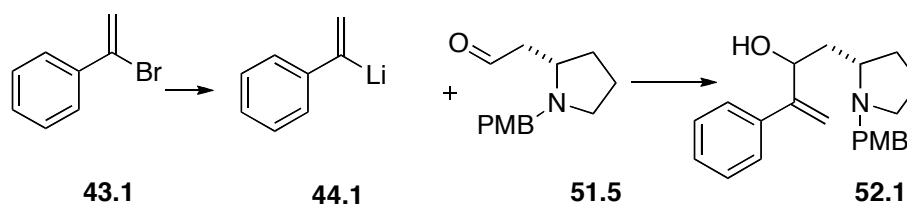

Scheme 52 *Attempted organolithium condensation with the PMB protected aldehyde*

The initial attempt of this reaction utilized *t*-BuLi for the lithium-halogen exchange, and produced in small quantities what appeared to be the desired allylic alcohol **52.1** as judged by ^1H NMR spectroscopy, even though the predominant signals in the spectrum were those of the starting aldehyde. Therefore, the amount of α -bromostyrene (and hence the organolithium) was increased to 3 equivalents, in order to promote total consumption of the aldehyde. The time allotted for the lithium-halogen exchange itself was also shortened, in an effort to prevent decomposition of the organolithium compound. Under these new conditions, the prevalent signals were that of the desired allylic alcohol, with only minute amounts of the aldehyde remaining. These conditions were carried out a second time to check for consistency, which had previously been an issue in the *N*-Boc series, and this time the result was the same. One reaction with *n*-BuLi was carried out, as this was typically the base of choice in the literature for the preparation of organolithium compound **44.1**.⁵⁴ This procedure also generated the allylic alcohol (^1H NMR), and the product was isolated in 41% yield as a mixture of two diastereoisomers. Although the yield was low, it appeared that the *N*-PMB

series was more suited to react with these nucleophiles than the *N*-Boc series, but there were still some problems that needed attention.

The PMB substrate pathway had two major disadvantages: the first being that these crude mixtures could not be chromatographed due to the extreme polar nature of the tertiary amine, and the second being that the aldehyde was not totally consumed. To overcome these problems, an acid extraction procedure was used in an attempt to isolate the desired allylic alcohol, but unfortunately the aldehyde was extracted as well. However, this extraction did serve to purify the mixture substantially. In a final attempt to remove the aldehyde, a wash with saturated sodium bisulfite (NaSO₃) was carried out. This would convert the aldehyde into a water soluble salt, leaving behind the desired organic compounds. Although these methods were effective in the purification of the allylic alcohol, the isolated yields remained below 50%. However, the allylic alcohols that were isolated could be carried forward.

A second route to these *N*-PMB protected allylic alcohols was also examined (Scheme 53) using a dithiane nucleophile. The addition of the dithiane was problematic and the process was not always reproducible, but **53.2** was isolated in 40% yield. Unfortunately, the carbonyl protected as a dithiane could not be regenerated from compound **53.3**, although several different methods were used, including mercuric chloride (HgCl₂), (CF₃CO₂)₂PhI,⁶¹ and NCS,⁶² and so this approach was abandoned.

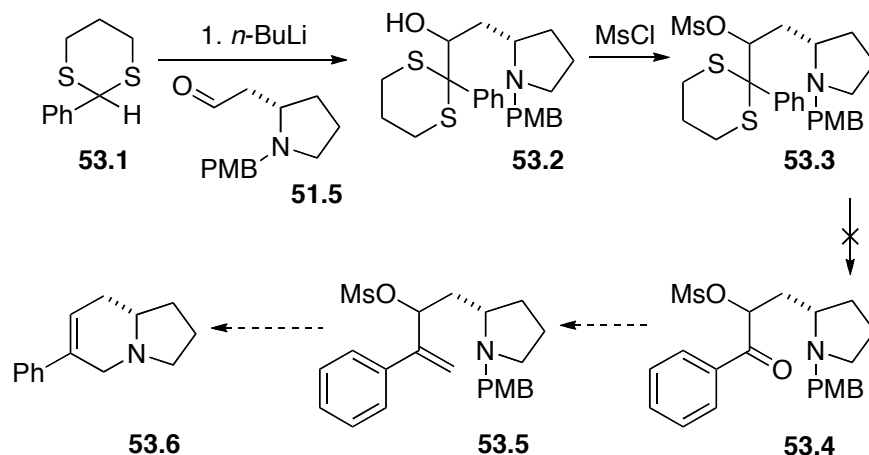

Scheme 53 *Alternative pathway for preparation of O-mesylated material*

2.5.3 Intramolecular conjugate displacement of the N-PMB protected series

The diastereoisomeric mixture of alcohols described in the previous section were to be mesylated and deprotected to see if cyclization was possible with the mesylate species.

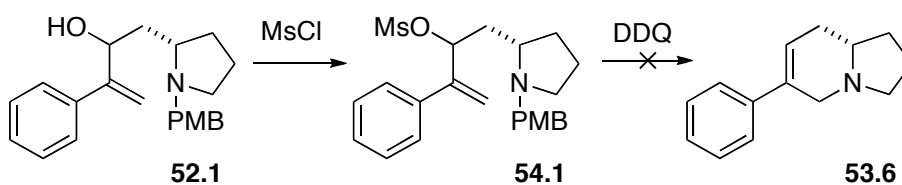

Scheme 54 *Intramolecular conjugate displacement with a phenyl group and O-mesylate leaving group*

Following mesylation and DDQ deprotection, only a complex mixture was observed, and it appeared that the ICD reaction in this situation did not produce the desired product, not to mention the difficulty in bringing up the precursor in significant quantities. There was sufficient evidence at this point to conclude that

the ICD reaction would not work with a phenyl group on the central carbon of the allylic system.

We now wished to explore whether a silicon atom would enhance reactivity during the course of the ICD reaction, mimicking the stability seen in α -silyl substituted Michael acceptors (ketones), introduced by Stork in an effort to avoid the polymerization of methyl vinyl ketone during the course of Robinson annulations.⁶³ The mode of anion stabilization in this case is not from orbital overlap of the anionic carbon 2p orbital to empty Si 3d orbitals,⁶⁴ but rather an overlap of the carbon 2p orbital with the Si-CH₃ σ^* orbital (of a TMS substituent);⁶⁵ this is similar to the mode of stabilization for sulfur and phosphorus α -carbanions.

2.6 Attempted total synthesis of (+)-ipalbidine: intramolecular conjugate displacement via silicon stabilization

2.6.1 Generation of allylic alcohols

Two separate approaches were implemented to generate the allylic alcohols necessary to test the effect of a silicon atom on the ICD reaction. The first involved the use of a selenium synthon that formally provides the allylic alcohols of a Morita-Baylis-Hillman reaction, and the second was the nucleophilic addition of α -(trimethylsilyl)vinyl bromide.

First, the known selenoacetal **55.1** undergoes lithium-selenium exchange, followed by quenching of the nucleophile with trimethylsilylchloride.⁶⁶ This compound (**55.2**) can then be deprotonated and treated with aldehyde **34.1**.⁶⁷ Unfortunately, the nucleophile did not add to the aldehyde.

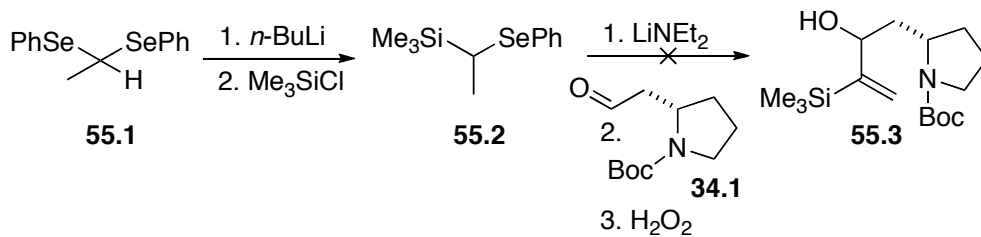

Scheme 55 *Attempted preparation of silicon substituted allylic alcohol*

In the literature, anions derived from **55.2** were reported to be used on alkyl bromides. When applied to our aldehyde, it seemed that there was no condensation as no desired material was detected.

In a more direct approach, a nucleophile derived from lithium-halogen exchange of commercial α -(trimethylsilyl)vinyl bromide (**56.1**) was treated with several of the electrophiles that we had generated previously.

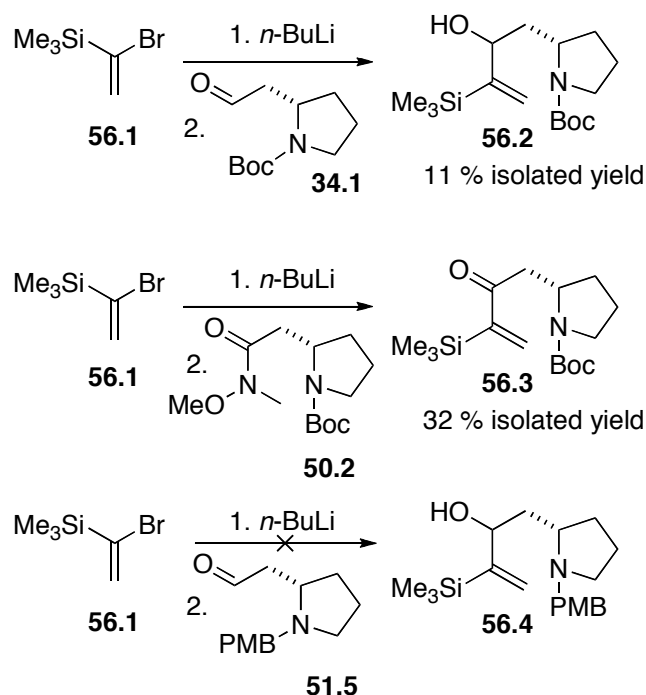

Scheme 56 Preparation of silicon substituted allylic alcohols

Each reaction was carried out several times, and the optimum yield is reported in Scheme 56. The yields were quite low, and it is possible that again enolization/ β -epimerization may be a side reaction. Nevertheless, enough material was available to investigate the effects of the silicon atom on the ICD reaction.

2.6.2 Intramolecular conjugate displacement in the presence of a silicon atom

With the *N*-Boc protected material in hand, we acetylated and deprotected the compound using our standard conditions. To our disappointment, the ICD reaction of **56.2** was not successful, and $2p \rightarrow \sigma^*$ stabilization does not appear to appreciably affect the outcome of the reaction. It is not being suggested that the α

carbanion is an intermediate in the reaction pathway, just that the Si atom can act as a stabilizing influence while the negative charge is built up on the central carbon atom of the allylic system during the ICD reaction. Nevertheless, it appears that in order for the ICD to work, the presence of a resonance stabilizing electron-withdrawing group on the central atom of the allyl system is necessary.

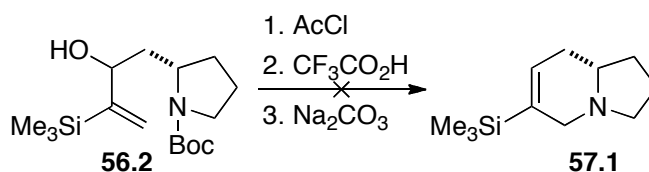

Scheme 57 *Attempted ICD with silicon as the stabilizing group*

2.7 Attempted total synthesis of (+)-ipalbidine: use of a vinyl sulfone functionality as a handle for reactivity

Because it had become apparent that the ICD reaction functions only in the presence of a Michael acceptor, our method of generating (+)-ipalbidine using the ICD would now involve one of the intermediates of the (-)- δ -coniceine synthesis,² wherein a phenyl sulfone is the Michael acceptor. The material was brought up via condensation of selenide **33.5** with aldehyde **34.1**. This reaction generated two diastereoisomers in 77% overall yield. Selenium oxidation and elimination, followed by alcohol acetylation (**58.2** \rightarrow **58.4**), gave the ICD precursor **58.4**. Using our standard ICD conditions, the compound cyclized nicely to give vinyl sulfone **34.4**. We wished to use this intermediate for coupling with

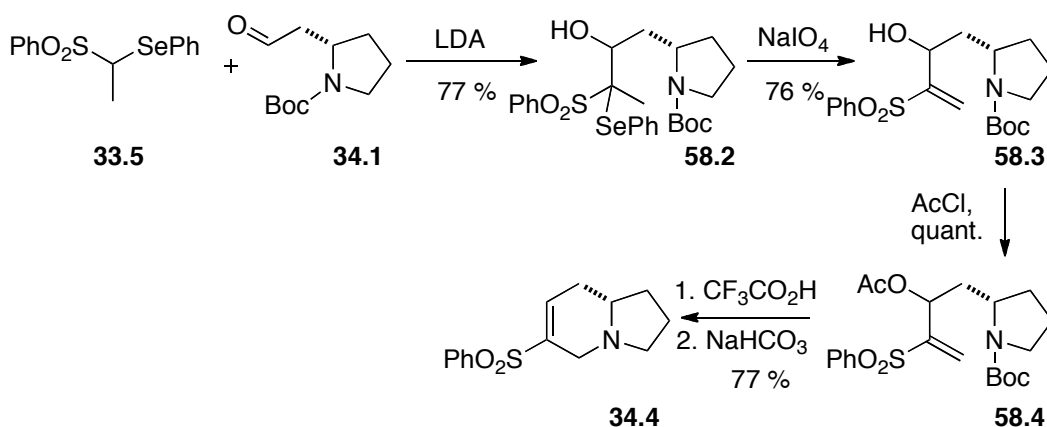

Scheme 58 Preparation of sulfone substituted indolizidine alkaloid via ICD

an aryl group, and investigate if a phenyl ring could be installed in place of the phenylsulfonyl group.

2.7.1 Coupling of a vinyl sulfone with a Grignard reagent

The first coupling attempt used a Grignard reagent in the presence of $\text{Ni}(\text{acac})_2$ or $\text{Fe}(\text{acac})_3$. This method (see **59.1** \rightarrow **59.2**) was developed by Julia,⁶⁸ and had been used in his total synthesis of the yellow scale insect pheromone (3*S*,5*E*)-(-)-3,9-dimethyl-6-isopropyl-5,8-decadien-1-yl acetate, whose *O*-TBS precursor (**59.3**) (the natural product being identical to **59.4** but with an *O*-acetate) was generated using the coupling methodology, albeit in low yield.

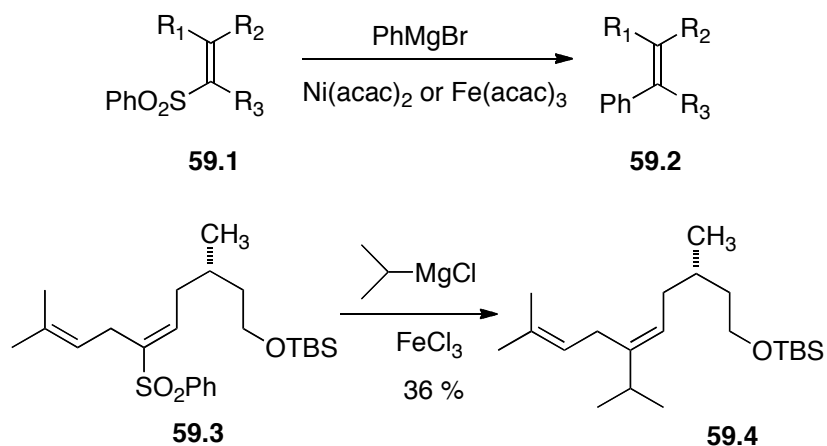

Scheme 59 *Coupling of vinyl sulfones with Grignard reagents*

When applied to our ICD vinyl sulfone intermediate, only the starting material was recovered (**58.5**). It is unknown whether the presence of the amine interferes with the operation of the metal in this reaction.

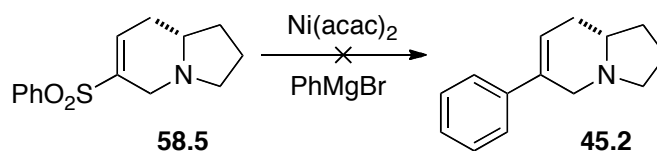

Scheme 60 *Attempted coupling of a sulfone substituted indolizidine alkaloid with a Grignard*

2.7.2 Conversion of a vinyl sulfone to a zirconocene

The second approach involved the use of a dieny zirconocene complex, and its ability to formally substitute the sulfone of a vinyl sulfone system⁶⁹ via double bond coordination, followed by carbometallative ring expansion into the zirconacyclopentane (**61.2**). Collapse of this system then leaves the zirconium in

place of the previous sulfone. The zirconium species can be converted to a vinyl iodide (**61.4**) or copper derivative (**61.5**), with each derivative being an effective coupling partner (Scheme 61).

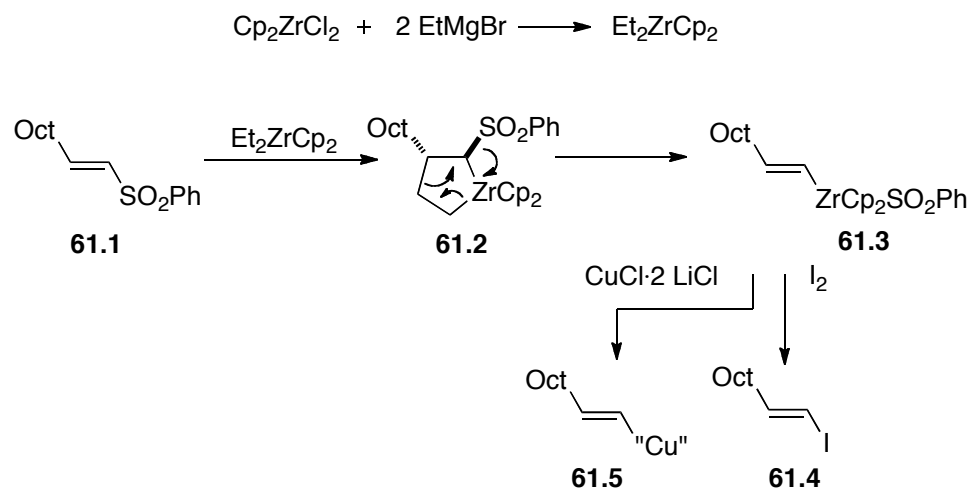

Scheme 61 *Substitution of a vinyl sulfone with zirconium*

When applied to our system however, no insertion took place and again only the starting sulfone was recovered.

2.7.3 Conversion of a vinyl sulfone to an organotin species

Our final attempt to utilize the vinyl sulfone was based on the exchange of the sulfone group for a tributyltin unit, which would provide Stille coupling intermediates that could be elaborated to (+)-ipalbidine. The initial literature precedent showed that in the presence of two equivalents of tributyltin hydride, the sulfone functionality could be exchanged in simple systems for the tin (the Ueno reaction) (**62.1** \rightarrow **62.2**). This reaction has been useful in many situations.

For example, it was found that a sulfone on a butadiene sulfone derivative (**62.5**) could be exchanged for tributyltin (Scheme 62).^{70a} This same exchange was also shown to take place in systems bearing a vinyl sulfone with a geminal fluorine atom (**62.8** → **62.9**). When applied to our alkaloid system, however, the result was the same as the other two attempts, and only starting material could be recovered.

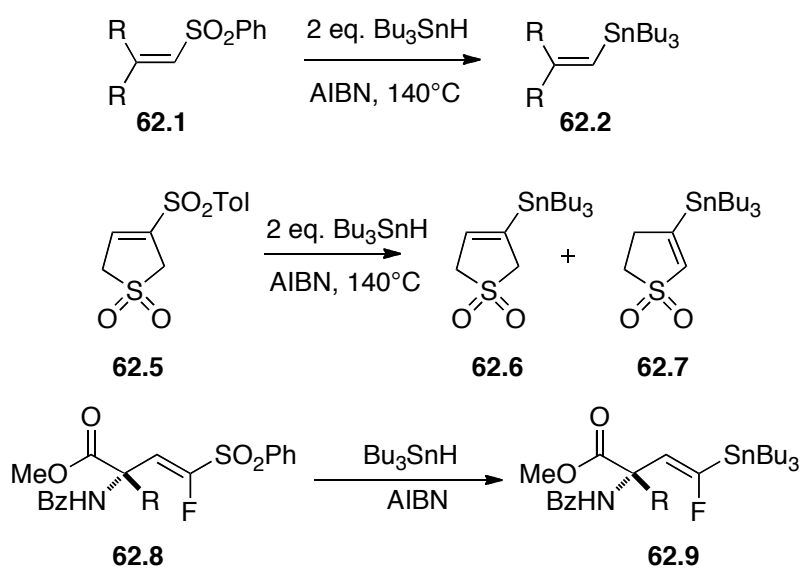

Scheme 62 *Substitution of a vinyl sulfone with tin*

Following these discouraging results, the time had come to reevaluate the practicality of the ICD approach for the generation of (+)-ipalbidine.

2.8 Conclusions from the ICD approach

The initial approach for generating the indolizidine alkaloid (+)-ipalbidine had included the use of an intramolecular conjugate displacement. Unfortunately, several problems became apparent with this route.

The first problem was the reactivity of the L-proline-derived aldehydes in both the *N*-Boc and *N*-PMB series. These aldehydes react quite readily with soft nucleophiles, as previous work has shown that they form Morita-Baylis-Hillman allylic alcohols with ease.² However, when trying to introduce harder nucleophiles to these aldehydes, it appears that there is a compatibility issue. The hard nature of many of these nucleophiles seems to keep yields quite low, and so it is difficult to bring up sufficient material. Whether the problem is enolization, β -epimerization or the stability of the organometallic species, the fact remains that these reactions do not generate the desired material in a sufficient quantity.

The second, and perhaps more important difficulty, was with the ICD reaction itself. As we found in several situations, these reactions do not work unless a resonance stabilizing electron-withdrawing group is attached to the central carbon of the allylic system. The presence of a weakly delocalizing phenyl group, or a silicon atom ($2p \rightarrow \sigma^*$ stabilization), are not enough to allow these reactions to proceed. Taking this information into account, we then attempted to use one of our known ICD intermediates, a vinyl sulfone, in an attempt to derivatize it and generate (+)-ipalbidine. Unfortunately, the vinyl

sulfone could not be manipulated, and these attempts were therefore abandoned; we therefore set out to generate a different asymmetric route to the indolizidine alkaloids and to (+)-ipalbidine itself.

2.9 Attempted total synthesis of (+)-ipalbidine: condensation of an organocuprate with an acid chloride

Our first attempt at accessing the core of the indolizidine alkaloids without the use of an ICD included the condensation of an L-proline-derived organocuprate reagent with an acid chloride (Scheme 63). This would prime the molecule for a conjugate addition following nitrogen deprotection.

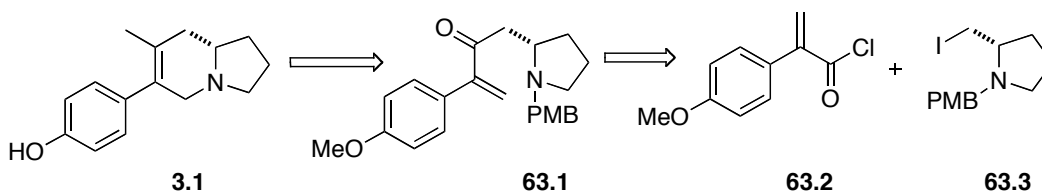

Scheme 63 *Second generation retrosynthetic approach*

The key to this approach was the generation of an organocuprate from compound **63.3**, which could be achieved via treatment with CuCN following organozinc formation. These β -amido organocuprates have previously been shown to condense in moderate yield with various electrophiles,⁷¹ with a major issue being the β -elimination of the nitrogen to form olefin products (Scheme 64). Side product formation can be suppressed with the use of dipolar aprotic solvents at 0 °C, such as DMF, DMA, and DMSO, instead of THF at room temperature.⁷²

Because DMF can react with acid chlorides under these conditions, DMA was chosen as the best solvent for this reaction.⁷³

Although β -elimination is a problem during the formation of β -amido organozinc compounds (as mentioned previously, see Scheme 64), we felt that the use of a PMB protecting group would suppress the leaving group ability of the nitrogen atom, as pK_a values suggest that an amine would not be expelled as easily as an amide.

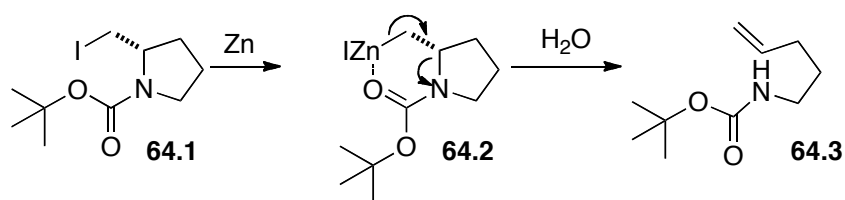

Scheme 64 β -elimination of an internal amide during zinc insertion

Preparation of the *N*-PMB protected iodo compound was carried out by treating *L*-proline with *p*-methoxybenzyl chloride, followed by reduction of the PMB ester using DIBAL, as seen earlier (**36.1** \rightarrow **49.1**). This alcohol could then be converted to the iodide under standard conditions.

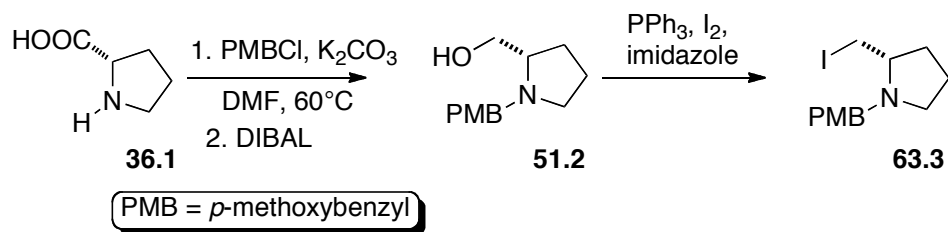

Scheme 65 Preparation of a PMB protected alkyl iodide proline derivative

The acid chloride **63.2** could be prepared by first converting *p*-methoxyacetophenone into ethyl *p*-methoxyphenyl acetate, via a Lewis acid induced rearrangement.⁷⁴ Viswanathan's¹⁰ method for generating alcohol **66.3** was then used, which included aldol condensation of the ester with ethyl formate, followed by reduction of the double bond.

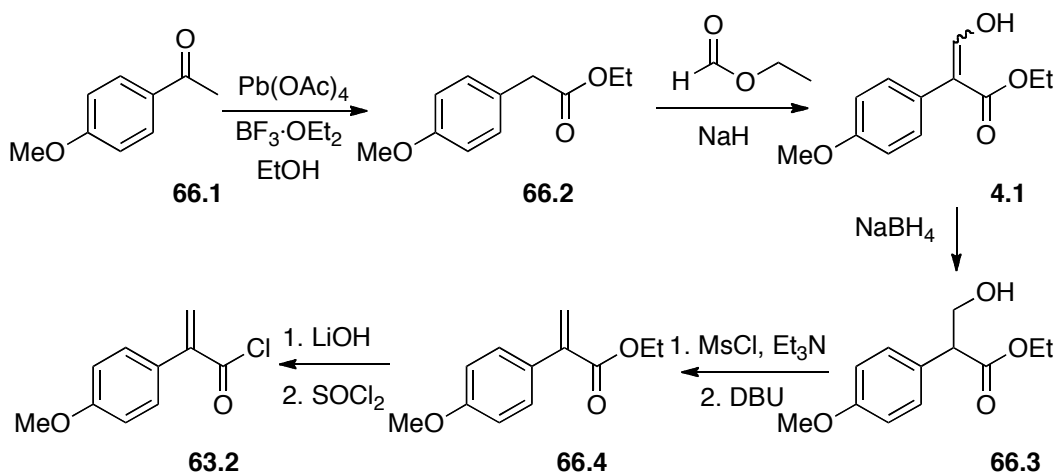

Scheme 66 Preparation of the required acid chloride

The α,β -unsaturated ester was formed by converting the alcohol into a mesylate leaving group, followed by elimination in the presence of DBU. Finally, ester hydrolysis and treatment of the resulting acid with SOCl_2 then gave acid chloride **63.2**.

To our disappointment, several attempts at condensing the organocuprate derived from **63.3** proved futile, and the desired condensation reaction never occurred. Rather than conjugate addition precursor **63.1**, a protonated product from intermediate **67.1** was recovered from the reaction mixture.

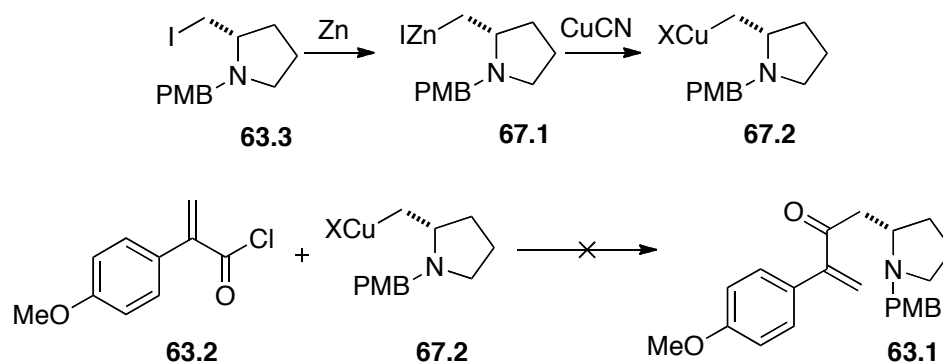

Scheme 67 *Attempted coupling of the organozinc with the acid chloride*

We felt that this approach had too many difficulties with the organocuprate formation, and it was abandoned for a different route.

2.10 Attempted total synthesis of (+)-ipalbidine: use of metal-mediated coupling

2.10.1 Use of a triflate for Suzuki-Miyaura coupling

Our next approach to (+)-ipalbidine involved the Suzuki-Miyaura coupling of triflate **68.4** with arylboronate **68.3** (Scheme 68). Following the coupling, an allylic oxidation would be used to install a ketone carbonyl, priming compound **68.1** for a conjugate addition following nitrogen deprotection.

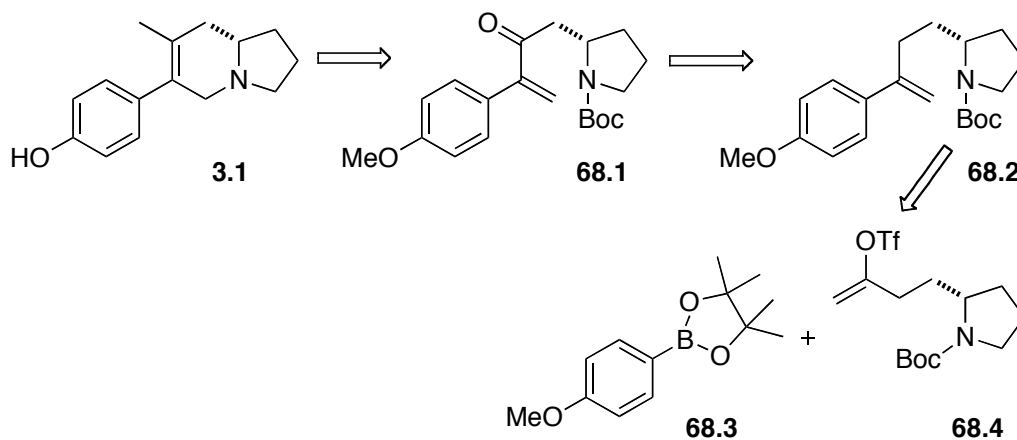

Scheme 68 *Third generation retrosynthetic approach*

The arylboronate **68.3** can be generated in one step from *p*-iodoanisole and pinacolborane (Scheme 69), as described by Ma.⁷⁵ This compound (**68.3**) would be a fine component for a Suzuki-Miyaura coupling.

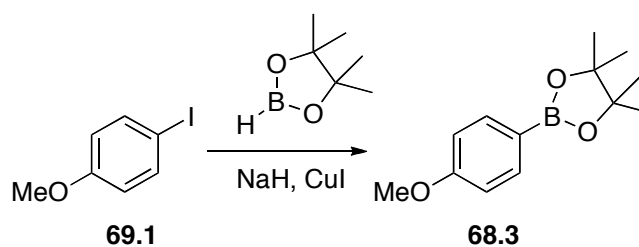

Scheme 69 *Preparation of arylboronate*

The triflate **68.4** would be made by extending the known L-proline-derived precursor **36.4** with freshly prepared Wittig reagent **70.1**,⁷⁶ followed by the reduction of the double bond under standard conditions (Scheme 70).

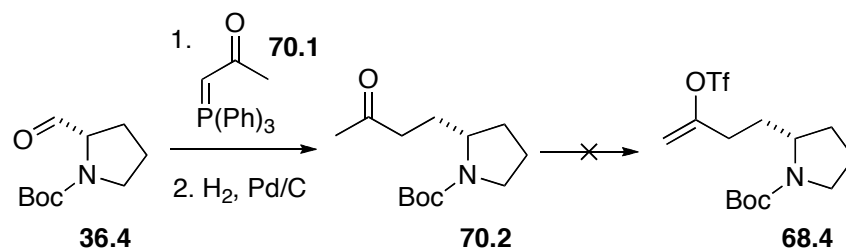

Scheme 70 *Attempted preparation of vinyl triflate*

Although generating ketone **70.2** was achieved without incident, its conversion to the corresponding triflate proved surprisingly difficult. A screening process was carried out where different bases (LDA and KHMDS) were used in combination with different triflating agents [PyrN(OTf)_2 , Tf_2O], but no combination would allow for isolation of the triflate. It appeared that the triflate was unstable during aqueous workup or purification, and only the starting ketone could be recovered. A control reaction was carried out whereby the same conditions were used on cyclohexanone, and this did produce the desired compound; the only conclusion was that the triflate wasn't stable during an aqueous workup or chromatography.

2.10.2 Use of a hydrazone to generate coupling partners for the Suzuki-Miyaura reaction

In order to overcome this problem, we set out to make a vinyl halogen from ketone **70.2**; this would be done by first converting the ketone to a hydrazone. The hydrazone could then be transformed into the corresponding vinyl carbanion by the Shapiro reaction (treatment with *t*-BuLi), followed by

electrophilic quenching with NBS. Unfortunately, these efforts gave only trace amounts of the desired material.

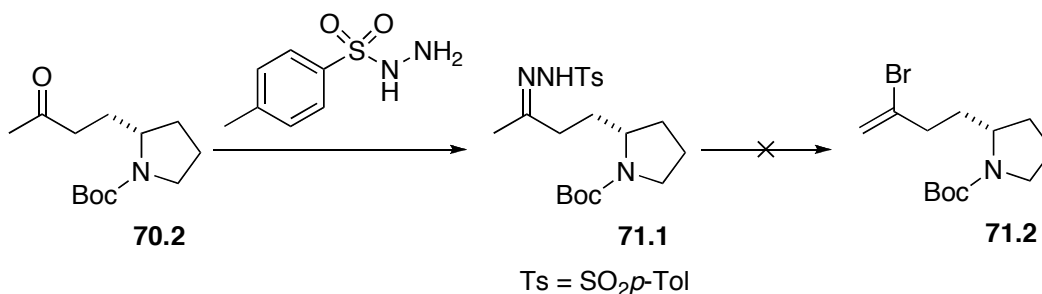

Scheme 71 *Attempted conversion of hydrazone to a vinyl bromide*

The use of *N*-tosylhydrazones as direct coupling partners has been reported in the literature,⁷⁷ in a one pot procedure where the desired terminal double bond of **71.2** could form in situ, followed by its coupling to an appropriate aryl halide. One drawback with our substrate **71.1**, however, was that double bond regioisomers would probably be formed. Rather than deal with this complication, we set out to generate our vinyl halide from a terminal triple bond instead.

2.10.3 Formation of vinyl halide for Suzuki-Miyaura coupling from a terminal triple bond

To generate the triple bond starting material, the extension of known L-proline derivative **36.4** was carried out using a different Wittig reagent from before. The reagent was prepared from methyltriphenylphosphonium bromide and ethyl formate, as described by Trippett and Walker.⁷⁸ Condensation of this

Wittig reagent with aldehyde **36.4**, followed by hydrogenation, provided α,β -unsaturated aldehyde **72.2** (see below).

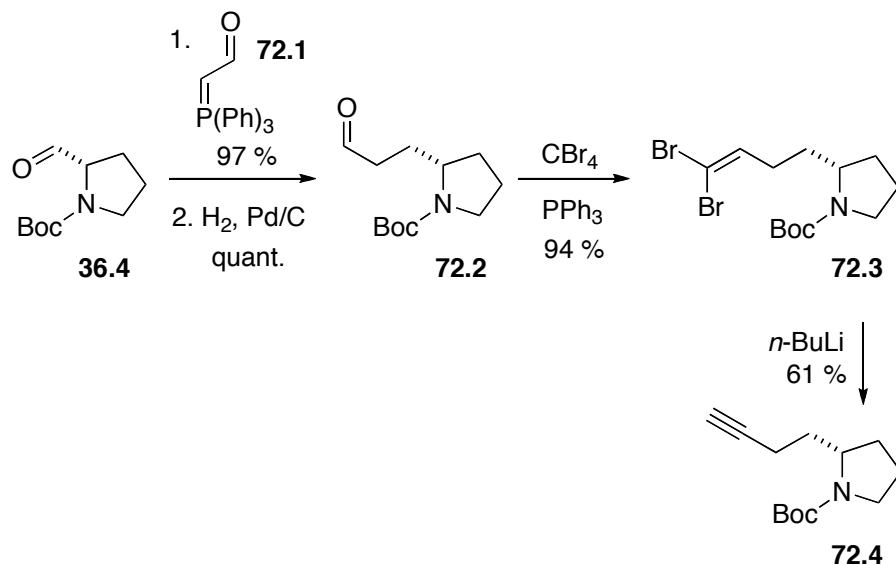

Scheme 72 Preparation of proline-derived acetylene

This aldehyde was then converted to a terminal triple bond, following the standard Corey-Fuchs procedure, whereby **72.2** is first treated with tetrabromomethane and triphenylphosphine. The isolable intermediate was then transformed into the triple bond via organolithium exchange and rearrangement.

With the acetylene **72.4** in hand, we set out to convert it to either a vinyl halide or a vinyl metal species (Scheme 73). The first attempt targeted the formation of a vinyl iodide,⁷⁹ but the starting material was too sensitive for the Lewis acidic conditions. The second attempt was based on the in situ formation of the organometallic species $\text{Bu}_3\text{SnAlEt}_2$, which can undergo a

stannylaluminumation across the triple bond, with the regioselective placement of the tin typically on the internal carbon of the terminal triple bond.⁸⁰ In our case, the starting material was recovered, perhaps due to the quality of the Et_2AlCl or the Bu_3SnH , and no **73.2** was detected. Our third effort involved the generation of a vinyl bromide, and called for the use of *B*-bromocatecholborane to add across the triple bond, followed by protonolysis,⁸¹ but as before, this effort met with no success.

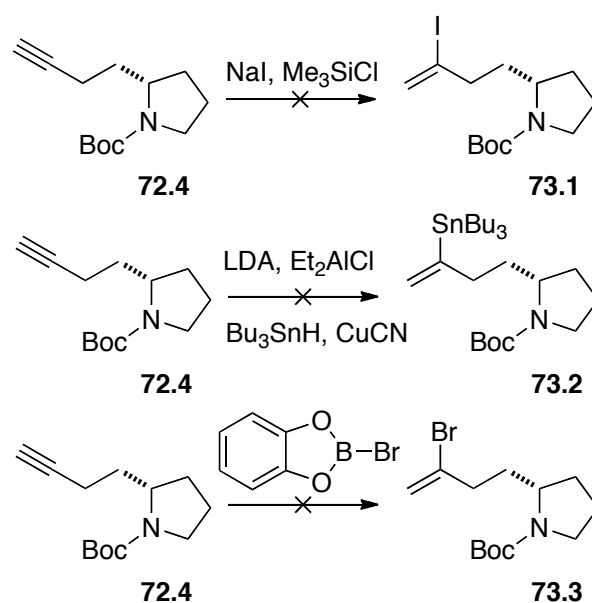

Scheme 73 *Attempted conversion of acetylene into vinyl coupling partner*

Disappointed with these outcomes, we decided to change the disconnections to the Suzuki-Miyaura coupling.

2.10.4 Hydroboration of an L-proline derivative for Suzuki-Miyaura coupling

Because we could not successfully generate the desired vinyl triflate or halide, we decided to move the boron from the aryl part of the molecule to the amino unit. Following coupling, the common intermediate **68.2** would then be generated (Scheme 74).

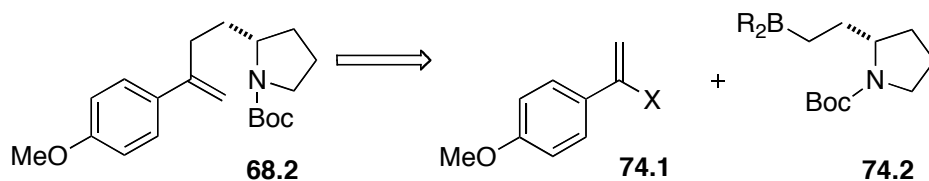

Scheme 74 *Modification of third generation retrosynthetic approach*

The general intermediate **74.1** could be made from acetophenone (**66.1**) and LDA,⁸² followed by exposure to a triflating source. Unfortunately, the acetylene **75.2** is produced due to the electron rich nature of the aryl ring, which expels the triflate, followed by elimination of one of the olefinic hydrogens to produce the triple bond. Placing a tosyl group on the aryl ring oxygen instead of a methyl group helps to stabilize the corresponding vinyl triflate (**75.5**), but it too breaks down over several hours (Scheme 75).

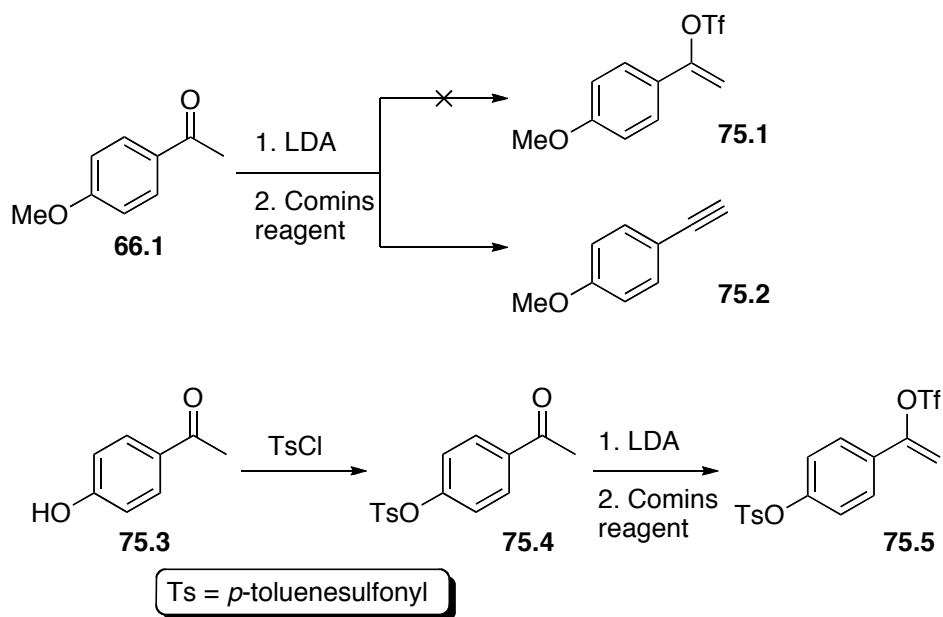

Scheme 75 Attempted preparation of vinyl triflate coupling partner

However, the vinyl bromide **76.1** can be generated from *p*-methoxyacetophenone,⁸³ and this compound is stable for several days. A second vinyl bromide (**76.3**) can also be prepared from the substituted styrene **76.2**, following a simple bromination-elimination sequence that has been used previously in this work to generate α -bromostyrene (Scheme 76).⁵⁵

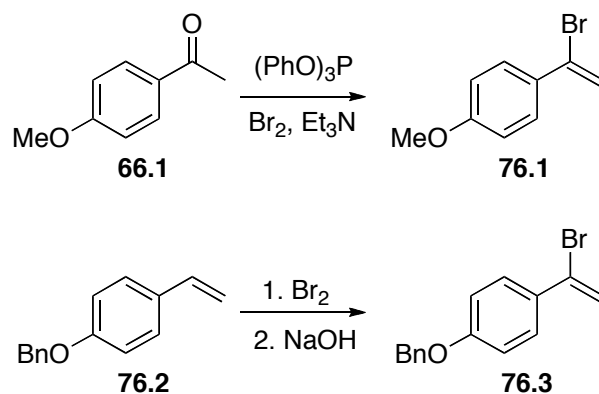

Scheme 76 Preparation of vinyl bromides

With these coupling partners in hand, we set out to generate the trialkylborane compound **74.2** via hydroboration of olefin **77.1**. This compound has been generated previously⁸⁴ using 9-BBN, but it had been immediately converted to the corresponding alcohol. We tried to isolate the boron intermediate, but our efforts were unsuccessful, as the boron species decomposed during these attempts. We tried other hydroborating agents such as pinacolborane and catecholborane, but again the desired borane could not be isolated due to its instability (Scheme 77).

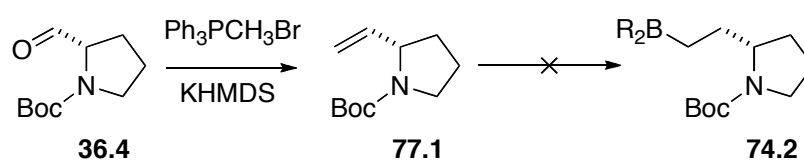

Scheme 77 *Attempted hydroboration of proline-derived olefin*

Because we could not generate the proper trialkylborane, this approach, based on the Suzuki-Miyaura method, was abandoned.

2.11 Attempted total synthesis of (+)-ipalbidine: use of a masked synthon

In our next route, the retrosynthetic approach involved the use of a masked synthon that would be used to open an L-proline derivative in a manner that would preserve the optical purity and introduce the aryl part of (+)-ipalbidine in one reaction.

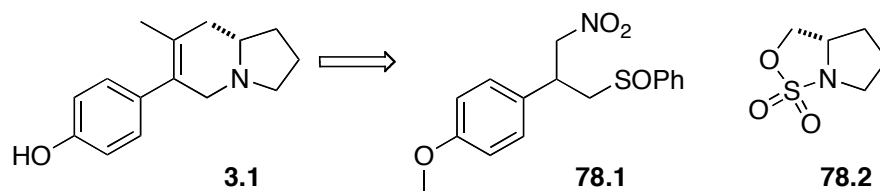

Scheme 78 *Fourth generation retrosynthetic approach*

By deprotonating α to the nitro group of **78.1**, a nucleophilic displacement on the $\text{CH}_2\text{-O}$ bond of **78.2** would install the phenyl moiety. Generation of compound **78.2** was relatively straightforward and was carried out via LiAlH_4 reduction of L-proline, followed by cyclization of the resulting amino alcohol to the sulfamidate⁸⁵ using sulfuryl chloride at -78°C .

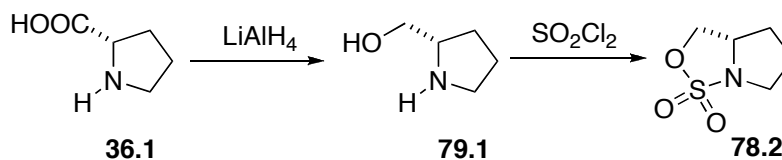

Scheme 79 *Preparation of cyclic sulfamidate*

Although these cyclic sulfamidates are known to react with hard nucleophiles (e.g. amines, MeOH),⁸⁵ we had hoped that they would open in the presence of nitro compound **78.1**, whose synthesis is presented in Scheme 80. This expectation was based on work published by Baldwin⁸⁶ in which a serine-derived sulfamidate was opened using diethyl malonate, a soft nucleophile.

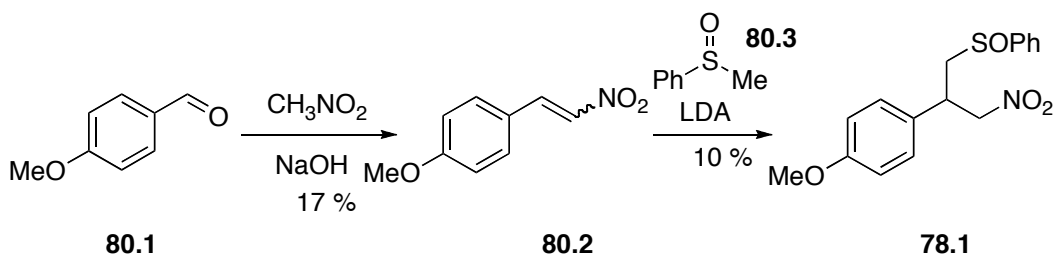

Scheme 80 *Preparation of nitro synthon*

By carrying out a Henry reaction on *p*-anisaldehyde with nitromethane, Michael acceptor **80.2** was generated, albeit in low yield. Michael addition of deprotonated sulfoxide **80.3** then led to our desired synthon. We had hoped that after condensation with **78.2** (see below), the sulfoxide would undergo a *cis*-elimination reaction, and the nitro functionality would be converted to a ketone with TiCl_3 .⁸⁷

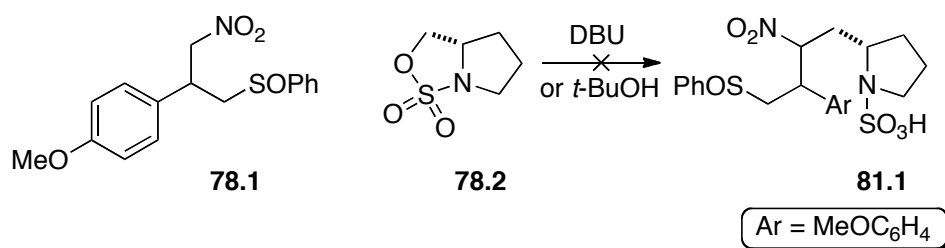

Scheme 81 *Attempted condensation of nitro synthon with cyclic sulfamidate*

Unfortunately, our efforts to open the cyclic sulfamidate were completely unsuccessful, and only recovery of the starting materials was noted. At this point a new approach was required.

2.12 Total synthesis of (+)-ipalbidine: use of the Reformatsky reaction and elaboration to the natural product

2.12.1 Use of soft nucleophiles in the synthesis of (+)-ipalbidine

Because previous nucleophiles we had tried to add to aldehyde **34.1** appeared to be too hard (resulting in poor yields), we suspected that reaction would occur with softer nucleophiles, based on our previous work wherein Morita-Baylis-Hillman alcohols were derived from this aldehyde. Therefore, two routes were developed simultaneously to explore this possibility.

The first route was based on elaborating the Henry condensation intermediate **82.2** by protecting the newly formed alcohol, and converting the nitro group to a ketone functionality. The ketone could then be transformed into an olefin using standard Wittig conditions, followed by deprotection and oxidation of the alcohol; in this way, a conjugate addition precursor would be generated (Scheme 82).

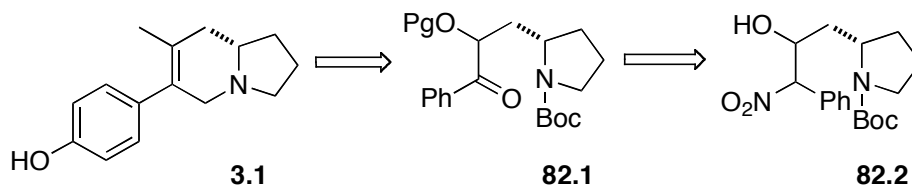

Scheme 82 *Fifth generation retrosynthetic approach*

As discussed previously, one of the primary issues plaguing most of our synthetic attempts has been the inability to condense nucleophiles with the L-proline-derived aldehyde **34.1**. However, by using the soft nitro compound **83.2**, we were able to successfully condense it and produce the resultant alcohols in acceptable yield. This marked the first time that aldehyde **34.1** had reacted in a successful manner during the course of this work. It is apparent that the nucleophiles must be resonance stabilized to react. This route was left at this stage as I felt that a simpler route could be developed, based on the knowledge that only soft nucleophiles react.

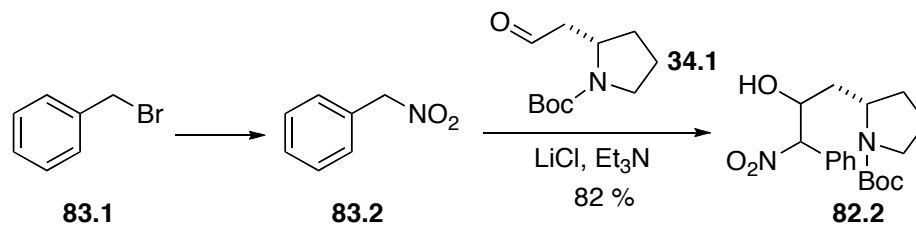

Scheme 83 *Combination of nitro compound with proline-derived aldehyde*

The second (and simpler) route capitalizing on this finding called for the addition of an enolate derived from **84.3** with aldehyde **34.1**.

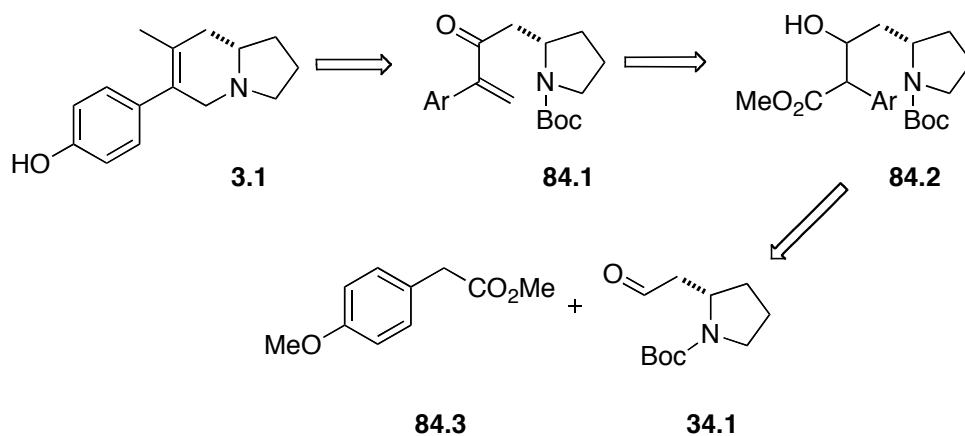

Scheme 84 *Final retrosynthetic approach*

In this case, the ester would function as a masked double bond, and the alcohol of **84.2** could be oxidized at a later stage to provide another conjugate addition precursor. Unfortunately, the initial attempt to condense **84.3** and **34.1** via a simple aldol reaction did not produce a good yield of product, and starting aldehyde **34.1** was still present (Scheme 85). We knew that the deprotonation step was successful, because deprotonation followed by a deuterated water quench did reduce the normalized integration of the α -carbon signal from two to one.

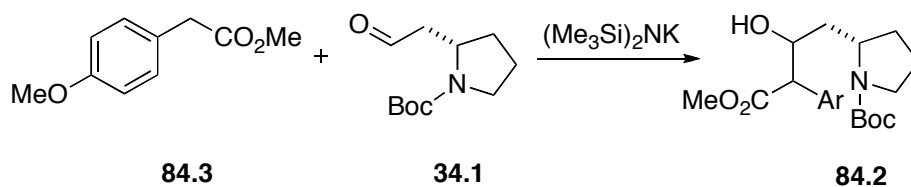

Scheme 85 *Condensation of an enolate with the proline-derived aldehyde*

The poor yield of the addition reaction was disappointing, as this route had seemed like the more practical of the two. Because the simple aldol reaction did not work well, we felt that the enolate was still too hard, and in an effort to avoid this issue, we attempted to explore some milder enolate-type reactions.

2.12.2 Exploration of aldol alternatives for the synthesis of (+)-ipalbidine

The first reaction that was used in an effort to increase the yield over that obtained with our enolate was the Mukaiyama aldol reaction. The aryl ester was converted into its corresponding silyl enol ether (**86.1**)⁸⁸ and, using BiCl_3 ⁸⁹ as the Lewis acid, the reaction was carried out. Unfortunately, no addition was observed and these conditions were not pursued further, as a better alternative was found.

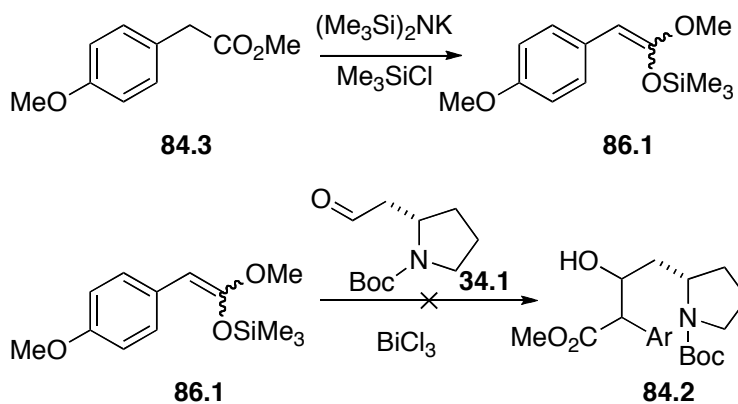

Scheme 86 *Attempted Mukaiyama aldol condensation with the proline-derived aldehyde*

2.12.3 The Reformatsky reaction and its use in the total synthesis of (+)-*ipalbidine*

The reaction that seemed best suited to our needs was the Reformatsky reaction. The reaction is carried out with α -halo esters, and is known to work with enolizable aldehydes and ketones, a requirement for our purposes.

We prepared the α -bromo compounds **87.3** and **87.4** by standard Fisher esterification and benzylic bromination⁹⁰ (Scheme 87).

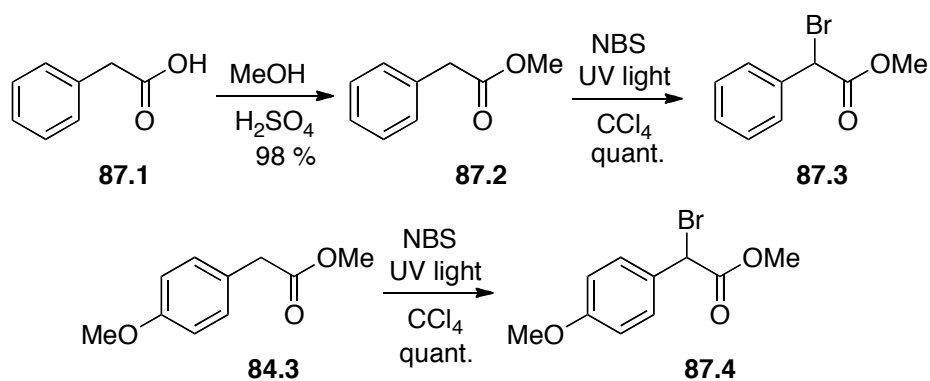

Scheme 87 *Preparation of Reformatsky precursors*

These compounds were then screened against several sets of literature conditions to find those that gave the best results for carrying out Reformatsky reactions. Both the tin⁹¹ and samarium metal⁹² mediated Reformatsky procedures did not provide the desired material. However, in returning to the roots of the reaction, it was found that Zn metal gave the desired alcohol **88.2** in 95% yield as two diastereoisomers.⁹³

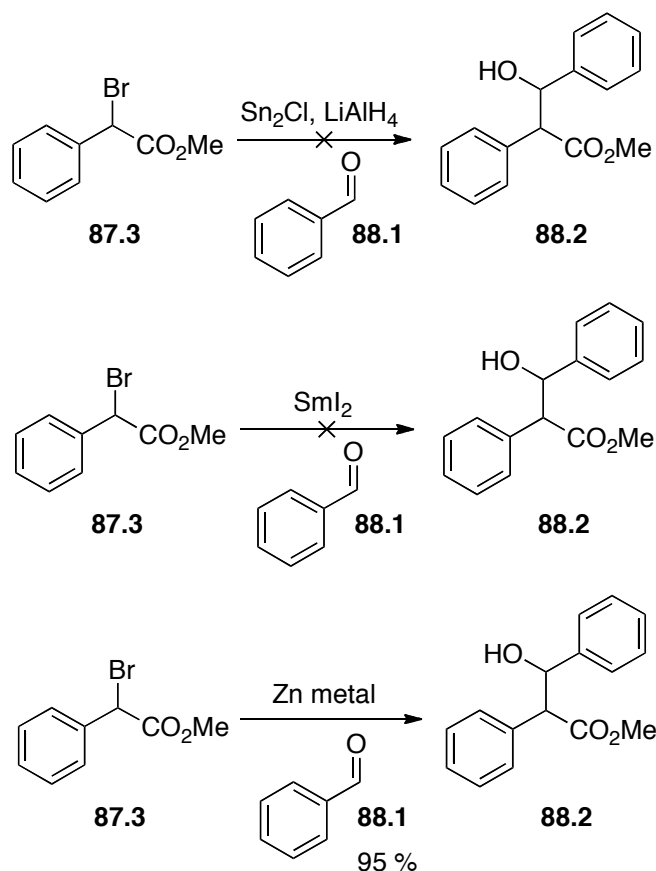

Scheme 88 Selection of Reformatsky conditions

Having now found the conditions for a successful reaction, the next step was to test the corresponding *p*-methoxy bromo ester with benzaldehyde to see if this substrate could undergo the Reformatsky with an electron rich aryl ring (Scheme 89). After carrying out the reaction, only a complex mixture was isolated. Evidently, in order for this reaction to be successful, an electron withdrawing protecting group would have to be placed on the phenolic oxygen, and therefore our route would not go through *O*-methyl ipalbidine.

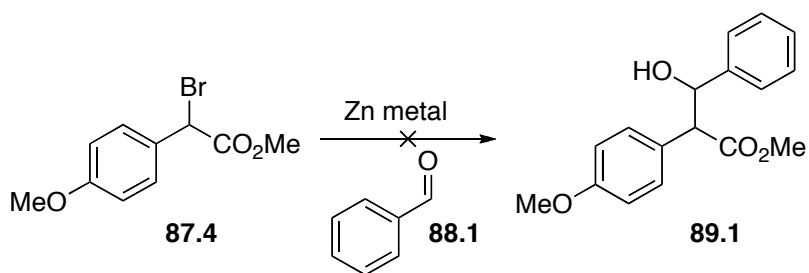

Scheme 89 *Reformatsky with an electron rich aryl ring*

The protecting group of choice was a benzenesulfonate as the more common *p*-toluenesulfonate could not be used because there would be interference during the benzylic bromination. The preparation was quite straightforward, with a Fisher esterification of the corresponding *p*-hydroxyphenyl acetic acid, followed by protection using benzenesulfonyl chloride.⁹⁴ Benzylic bromination then proceeded in quantitative yield to provide **90.3** as a white solid. The bromination procedure gave a much higher yield when using freshly recrystallized *N*-bromosuccinimide rather than the standard yellow reagent.

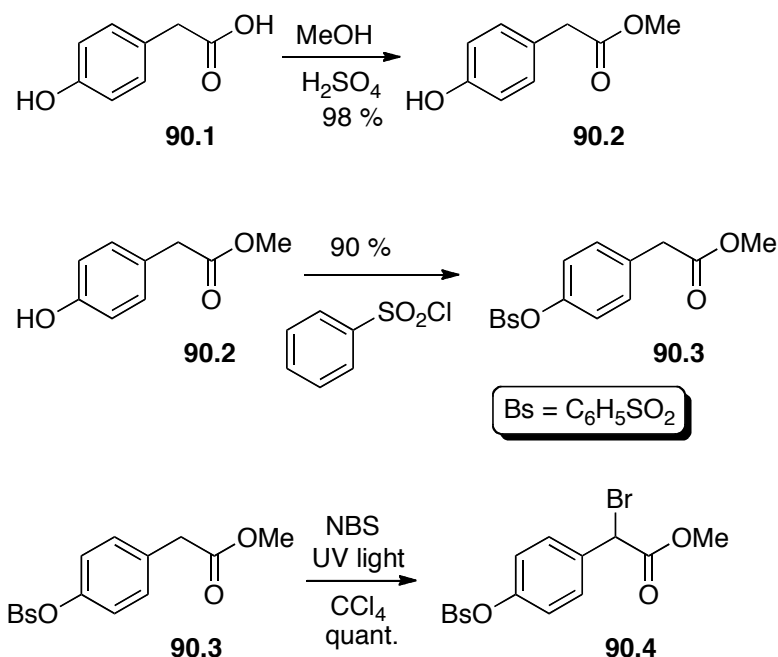

Scheme 90 Preparation of redesigned Reformatsky precursors

With the Reformatsky precursor **90.4** in hand, it was time to condense it with our previously generated aldehyde **34.1**. To our pleasure, the reaction proceeded in 98% overall yield, and the crude ¹H NMR spectrum showed complete consumption of the aldehyde.

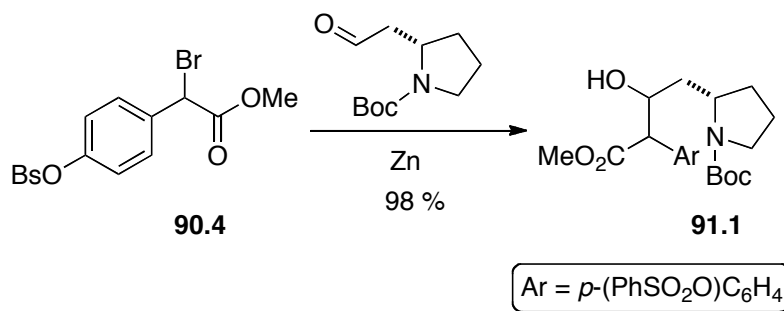

Scheme 91 Reformatsky condensation of aryl ester with proline-derived aldehyde

We now had for the first time, an efficient and asymmetric method of generating an advanced intermediate for our synthesis. Before elaborating the compound to the natural product several small modifications were attempted in order to investigate the ability to generate (+)-ipalbidine by a shorter route.

2.12.4 Reformatsky reaction of a ketone and conjugate addition to access indolizidine alkaloids

The first modification of the Reformatsky reaction that is presented in Scheme 92 was to attempt the corresponding reaction on ketone **92.2**. This would install the methyl group of (+)-ipalbidine at an earlier stage; in the event, installing the methyl group at a late stage proved difficult. The ketone in question was elaborated from aldehyde **34.1** by condensing it with methyl magnesium bromide, followed by oxidation of the product to give ketone **92.2**.

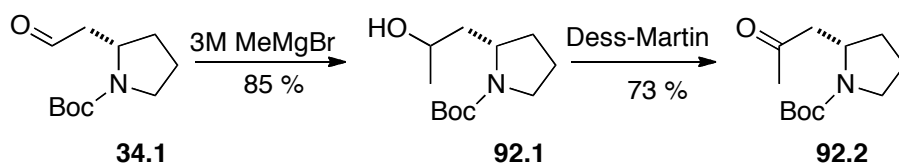

Scheme 92 Preparation of the proline-derived methyl ketone

The Reformatsky reaction was carried out initially at room temperature (following the procedure described previously), but the mixture was then heated to 80 °C. Unfortunately, no reaction seemed to occur, as only the starting material was recovered.

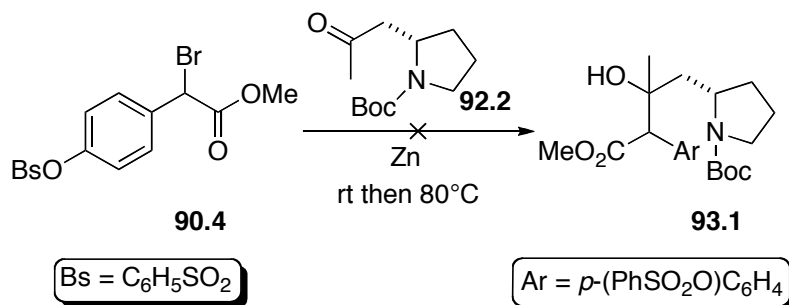

Scheme 93 *Attempted Reformatsky with the methyl ketone*

We also wished to know if a conjugate addition would be able to occur onto a doubly activated double bond (see **94.2**), generated from the Morita-Baylis-Hillman reaction of methyl acrylate with aldehyde **34.1**, followed by oxidation.

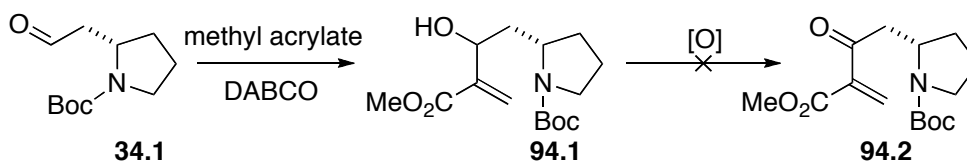

Scheme 94 *Attempted conjugate addition*

Many different methods were used to oxidize compound **94.1**, including Dess-Martin reagent, Swern oxidation, and MnO_2 , but **94.1** was too unstable to isolate, and could not be carried forward to other compounds.

After these efforts, we returned to the previously generated Reformatsky intermediate and carried it forward to the natural product.

2.12.5 Completion of the total synthesis of (+)-ipalbidine

In order to generate (+)-ipalbidine, the secondary hydroxyl of **91.1** must be protected in order to convert the ester to a double bond. Initial conditions utilizing *t*-butyldimethylsilyl chloride were unsuccessful, but the use of TBSOTf gave the product in 65% yield. DIBAL reduction of the ester then gave the primary alcohol, which could be converted to a double bond following the Grieco protocol.⁹⁵

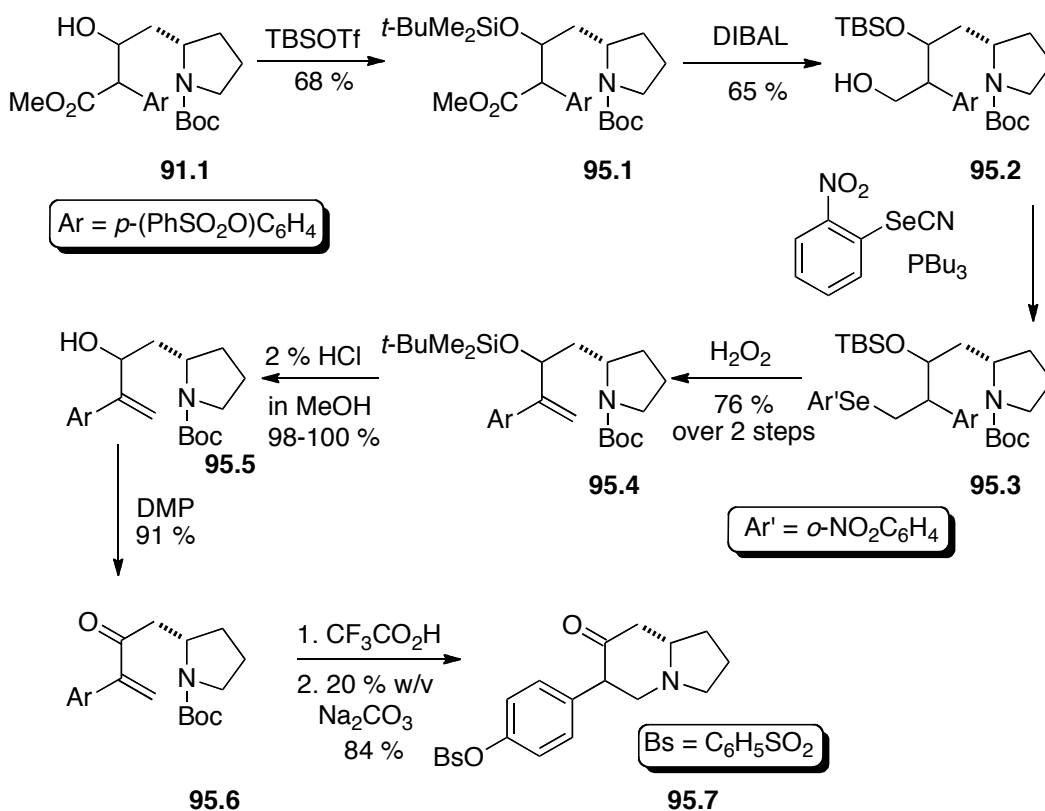

Scheme 95 Synthesis of the (+)-ipalbidine precursor

Initially, several other procedures had been attempted in order to generate the double bond from the primary hydroxyl, including mesylation and

elimination, but Grieco's method ultimately provided the desired double bond in the highest yield.

Subsequent removal of the silyl protecting group proceeded smoothly, as did the oxidation of the secondary alcohol to the ketone (**95.4** → **95.6**). The conjugate addition was carried out under the same conditions as the aza-ICD reaction, with $\text{CF}_3\text{CO}_2\text{H}$ mediated deprotection, followed by buffering of the salt in MeCN with an aqueous solution of 20% w/v Na_2CO_3 . The cyclized indolizidine intermediate **95.7** was thus obtained in acceptable yield.

The methyl group was installed by condensation of MeLi with the ketone **95.7**, as previously described by Liu,²⁹ and this compound was dehydrated using TsOH in benzene. The hydroxide mediated deprotection of **96.2** then provided (+)-ipalbidine in 67% yield.

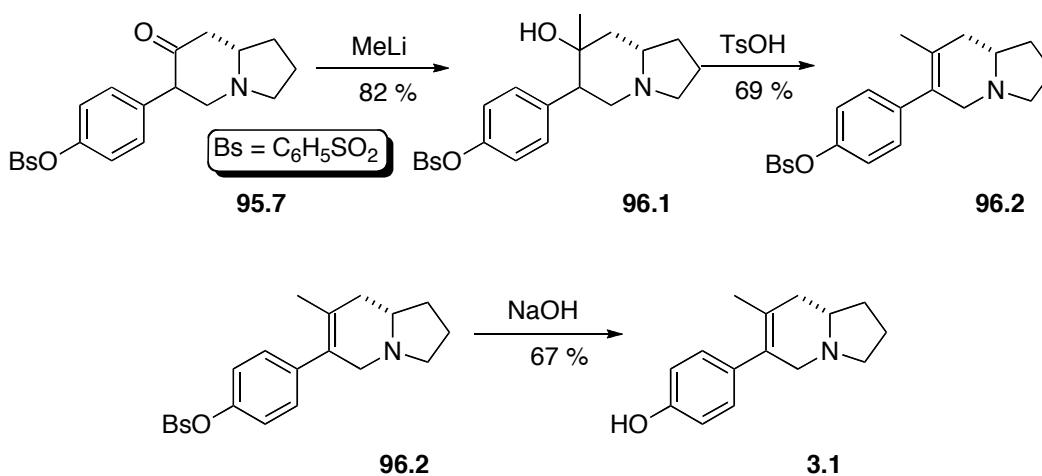

Scheme 96 Elaboration of intermediate to (+)-ipalbidine

The total synthesis of (+)-ipalbidine had been completed, with all spectra of the final compound matching those reported. The $[\alpha]_D^{25}$ value of this isolated compound was found to be +120 ($c = 1.5$, CHCl_3). By comparison with the value reported by Georg (+202, $c = 1.00$, CHCl_3),³⁶ it was clear that there had been some epimerization, though this conclusion is tentatively based on optical rotation data, and not on the more definitive method of chiral HPLC.

2.12.6 Second generation synthesis and improvement in optical purity

This epimerization had possibly occurred during the preparation of the L-proline-derived aldehyde **34.1** described in section 2.4.2. As mentioned before, our $[\alpha]_D^{25}$ value had never matched that reported for this compound,⁴⁸ but we decided to continue as our method for making the aldehyde had provided optically pure compounds when it was used in other projects by our group. It seemed plausible that during this project, slight differences in experimental procedure may have caused epimerization, and a second generation synthesis of (+)-ipalbidine based on our route was carried out using aldehyde **34.1** prepared as reported in the literature,⁴⁸ with several experimental modifications.

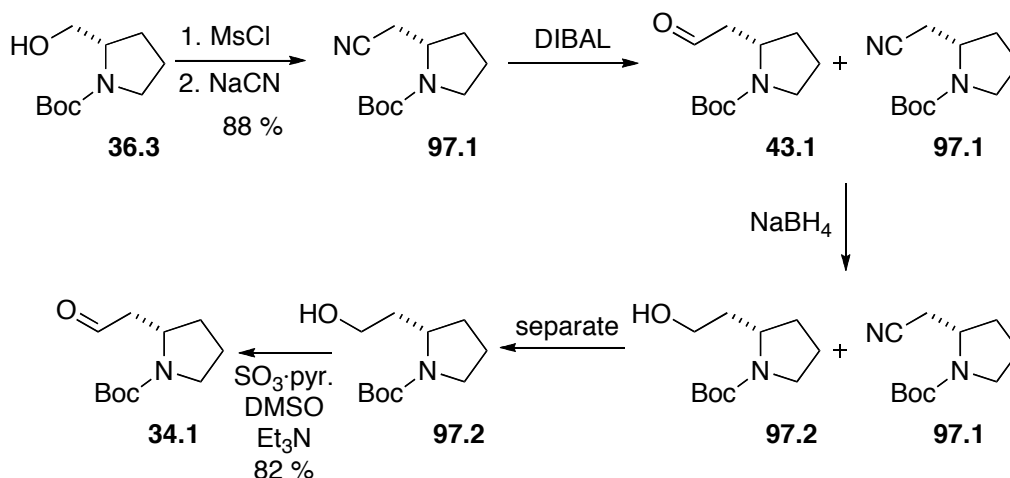

Scheme 97 *Second generation preparation of the proline-derived aldehyde*

N-Boc prolinol (**36.3**) was made as described in section 2.4.2, and the alcohol was mesylated and treated with cyanide to generate the nitrile **97.1**. This compound was then reduced with DIBAL, but unfortunately the aldehyde and nitrile have the same R_f value. However, the aldehyde in this mixture of compounds could be reduced using NaBH_4 , and the two compounds could now be separated. Although a possible risk, a Parikh-Doering⁹⁶ oxidation was carried out to oxidize the compound to aldehyde **34.1**. This method generated the aldehyde with an $[\alpha]_D^{25}$ value of +44 ($c = 1.5$, MeOH), which compared well with that of the literature⁴⁸ $[[\alpha]_D^{25}$ of +46.5 ($c = 1.5$, MeOH)]. Because the authors⁴⁸ had also established the *ee* value of their compound **34.1** to be >99% by NMR, following derivatization with a chiral amine, we concluded that the aldehyde was now of high optical purity ($\geq 94\%$).

With this aldehyde, the second generation synthesis was carried out, and the $[\alpha]_D^{25}$ of (+)-ipalbidine from this synthesis was +148.55 ($c = 1.1$, CHCl_3). This represents a big improvement over the initial synthesis, but the value was still below that of the optically pure material reported by Georg $[[\alpha]_D^{25} +202, c = 1.00, \text{CHCl}_3, er = 98:2]$,³⁶ and Wick $[[\alpha]_D^{25} +233, c = 1.00, \text{CHCl}_3]$ and suggested an *ee* of 73%. We appreciate that there is a possibility for epimerization to occur during *N*-Boc deprotection, as outlined in Scheme 98.

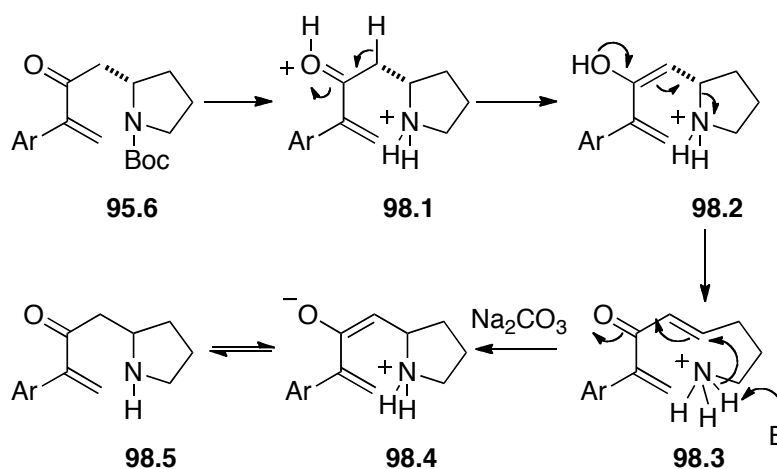

Scheme 98 Possible mechanism of β -epimerization

In this case, $\text{CF}_3\text{CO}_2\text{H}$ may be too strong an acid, and the carbonyl α proton may be lost, causing elimination (E1_{CB}) of the internal amine (**98.1** \rightarrow **98.2** \rightarrow **98.3**). Upon ring closure, the *ee* would be eroded. Georg had noted problems with *N*-Boc deprotection during her ynone conjugate additions,³⁷ and had settled on the use of formic acid for her synthesis of (+)-ipalbidine³⁶ as a way to avoid epimerization.

A third generation approach, using milder *N*-Boc deprotection methods, may improve the optical purity, but at this point work on the total synthesis of (+)-ipalbidine was stopped as the goal of generating a route to the indolizidine alkaloids had been achieved, by the use of a conjugate addition to access the core structure.

2.12.7 Applicability of the conjugate addition for alkaloid synthesis

This route met several of the demands stated at the beginning of this work, which were to create a flexible and asymmetric approach to the indolizidine class of alkaloids. In principle, this approach could be used to access other indolizidine compounds, such as septicine (**99.1**) in much the same manner, if different Reformatsky conditions can be found for electron rich aryl rings α to the ester.

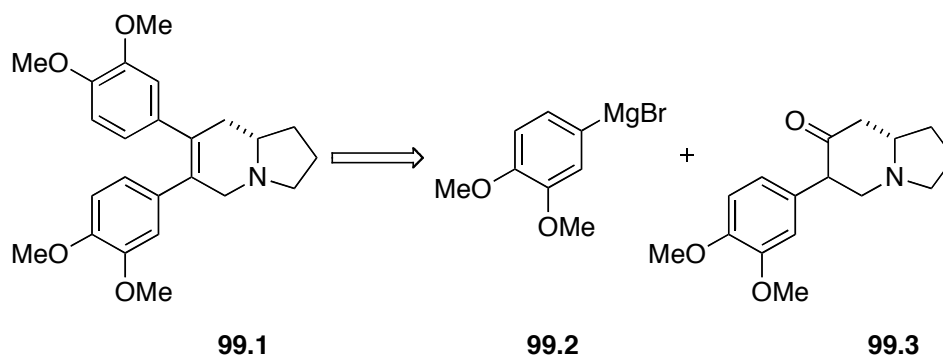

Scheme 99 Possible preparation of septicine

Along with other indolizidine alkaloids, more ring sizes may also be accessed with this method beginning from L-proline, such as the stemona alkaloids, whose core structure is shown (Scheme 100).

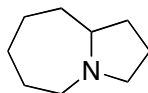
**100.1****Scheme 100** *Core structure of the stemona alkaloids***2.13 Conclusions**

The initial objectives of this research were to develop a route toward the indolizidine alkaloid (+)-ipalbidine that would be flexible and asymmetric, and to attempt to gather further insights into the aza-ICD reaction. These objectives have been largely met, although the *ee* of our synthetic ipalbidine is only 73%.

In attempting to utilize certain groups for the ICD reaction, we have learned that only Michael acceptors are able to promote the ICD reaction, and that all-carbon delocalizing systems (i.e. benzene) and silicon (via $2p \rightarrow \sigma^*$ donation), do not.

We have also developed an asymmetric route to (+)-ipalbidine, and in particular to the core of indolizidine alkaloids. By starting from the chiral pool (L-proline) and other simple starting materials, the cost of these methods has been kept to a minimum and might be suitable for larger compounds containing these moieties; some future work will be required in order to eliminate remaining issues with epimerization.

3. EXPERIMENTAL

Unless stated to the contrary, the following conditions apply: Reactions were carried out under a slight static pressure of Ar or N₂ that had been purified by passage through a column (3.5 x 42 cm) of R-311 catalyst and then through a similar column of Drierite. All solvents for reactions were dried, as described below. Glassware was dried in an oven (140 °C) for at least 3 h before use and either cooled in a desiccator over Drierite, or assembled quickly, sealed with rubber septa, and allowed to cool under a slight static pressure of Ar or N₂. Reaction mixtures were stirred by Teflon-coated magnetic stirring bars.

Hexane and ethyl acetate used for chromatography were distilled before use.

Products were isolated from solution by evaporation under water aspirator vacuum at, or below, room temperature, using a rotary evaporator.

Microliter syringes were washed with water and acetone, using a suction device to draw the solvents through. Air was then drawn through for 1 min and the syringe was stored under vacuum. The solution to be dispensed was drawn up and expelled, and this operation was repeated several times before drawing up the sample to be used. Cannula transfers were always done under slight pressure (Ar or N₂), not by suction.

Commercial thin layer chromatography (TLC) plates (silica gel, Merck 60F-254) were used. Spots were detected by examination under UV light or by spraying the plate with a solution of phosphomolybdic acid or potassium

permanganate,⁹⁷ followed by charring with a heat gun. Silica gel for flash chromatography was Merck type 60 (230-400 mesh).

Dry solvents were prepared under an inert atmosphere and transferred by syringe or cannula. Dry THF, Et₂O, PhH, and PhMe were distilled from Na and benzophenone ketyl. Dry CH₂Cl₂, Et₃N, *i*-Pr₂NEt and pyridine were distilled from CaH₂. Dry MeOH was distilled from Mg(OMe)₂. FT-IR measurements were made from the specified solvent using KBr plates.

The NMR data of all *N*-Boc protected compounds was collected at high temperatures in order to clarify their outcome. The symbols s, d, t, and q used for ¹³C NMR signals indicate 0, 1, 2, or 3 attached hydrogens, respectively, as based on the APT experiment.

Mass spectra were recorded with Agilent Technologies 6220 Accurate-Mass TOF LC/MS, Perseptive Biosystems Mariner Biospectrometry Workstation, Kratos MS50 or Micromass ZabSpec Hybrid Sector-TOF mass spectrometers. Compounds isolated by flash chromatography were pure by TLC and, unless otherwise stated, also as judged by high field ¹H and ¹³C NMR spectra.

Optical rotation measurements were taken on a Perkin Elmer 241 Polarimeter (units for specific rotation [α_D] are deg dm⁻¹ cm³ g⁻¹ but the literature uses just degrees). The sodium D-line (589 nm) was the wavelength of choice.

(2*S*)-2-(Hydroxymethyl)-1-pyrrolidinecarboxylic acid 1,1-dimethylethyl ester (**36.3**).⁴⁵

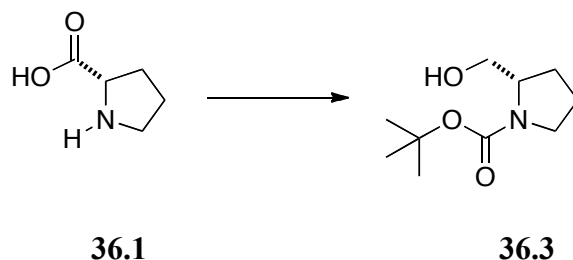

Et₃N (2.54 mL, 18.2 mmol), followed by Boc₂O (6.70 g, 16.9 mmol) in CH₂Cl₂ (3 mL), was added to a stirred and cooled (0 °C) solution of L-proline (1.50 g, 13.0 mmol) in dry CH₂Cl₂ (24 mL). Stirring at 0 °C was continued for 2 h, the cooling bath removed and stirring was continued for another 2 h. The reaction was quenched with saturated aqueous citric acid and the mixture was partitioned between CHCl₃ and water. The combined organic extracts were washed with brine, dried (MgSO₄), and evaporated. BH₃·SMe₂ (10.2 M in dimethyl sulfide, 3.24 mL, 32.4 mmol) was added to a stirred and cooled (0 °C) solution of the residue in dry THF (24 mL) and stirring was continued overnight. The mixture was cooled to 0 °C, quenched with water, and partitioned between EtOAc and water. The aqueous phase was extracted with EtOAc, and the combined organic extracts were washed with brine, dried (MgSO₄), and evaporated. Flash chromatography of the residue over silica gel (4 x 15 cm), using 40% EtOAc-hexanes, gave **36.3** (2.49 g, 95%) as a white solid: mp = 60-65 °C; [α]_D²⁵ -47.05 (*c* = 0.96, MeOH); FTIR (MeOH cast) 3420, 2975, 1694, 1672

cm⁻¹; ¹H NMR (CDCl₃, 300 MHz) δ 1.49 (s, 9 H), 1.60 (dddd, *J* = 10.6, 10.6, 4.2, 4.2 Hz, 1 H), 1.70-1.90 (m, 2 H), 2.0 (dddd, *J* = 12.4, 7.4, 7.4, 7.4 Hz, 1 H), 3.37 (app. dt, *J* = 33.0, 6.7 Hz, 1 H), 3.38 (app. dt, *J* = 55.0 Hz, 7.1 Hz, 1H), 3.55-3.67 (m, 2 H), 3.80-4.00 (m, 2 H); ¹³C NMR (CDCl₃, 125 MHz) δ 23.9 (t), 28.4 (q), 28.6 (t), 47.4 (t), 60.0 (d), 67.2 (t), 80.1 (s), 156.0 (s); exact mass (electrospray) *m/z* calcd for C₁₀H₁₉NNaO₃ 224.1257, found 224.1257.

(2*S*)-2-Formyl)-1-pyrrolidinecarboxylic acid 1,1-dimethylethyl ester

(36.4).⁴⁵

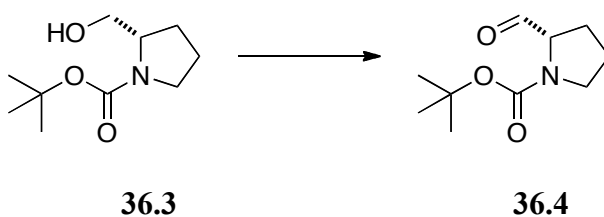

Dry CH₂Cl₂ (12 mL) was added to (COCl)₂ (0.59 mL, 6.80 mmol) in a dry, N₂-filled flask. The solution was cooled to -78 °C and DMSO (0.97 mL, 0.014 mol) in CH₂Cl₂ (5 mL) was added dropwise, and stirring was continued for 10 min. A solution of **36.3** (1.37 g, 6.80 mmol) in CH₂Cl₂ (8 mL) was then added dropwise, and stirring was continued for 20 min. Et₃N (3.79 mL, 0.027 mol) was then added, the cooling bath was removed and stirring was continued for 5 h. The mixture was quenched with water and partitioned between CHCl₃ and water. The aqueous phase was extracted with CHCl₃, and the combined organic extracts were washed with brine, dried (MgSO₄), and evaporated. Flash chromatography of the

residue over silica gel (3.2 x 15 cm), using 25% EtOAc-hexanes, gave **36.4** (1.16 g, 86%) as an oil: $[\alpha]_D^{25} -92.53$ ($c = 0.99$, CHCl_3); FTIR (MeOH cast) 2978, 2934, 2882, 1737, 1698 cm^{-1} ; ^1H NMR (CDCl_3 , 500 MHz, 60 °C) δ 1.40 (s, 9 H), 1.78-1.88 (m, 2 H), 1.89-1.96 (m, 1 H), 1.99-2.09 (m, 2 H), 3.40-3.50 (m, 2 H), 4.00-4.20 (m, 1 H), 9.41-9.50 (m, 1 H); ^{13}C NMR (CDCl_3 , 125 MHz) δ 23.9 (t), 27.9 (t), 28.3 (q), 46.8 (t), 65.0 (d), (t), 80.4 (s), 153.9 (s), 200.0 (s); exact mass (electrospray) m/z calcd for $\text{C}_{10}\text{H}_{17}\text{NNaO}_3$ 222.1101, found 222.1099.

(2S)-2-(2-Methoxyethenyl)-1-pyrrolidinecarboxylic acid 1,1-dimethylethyl ester (36.5).⁴⁶

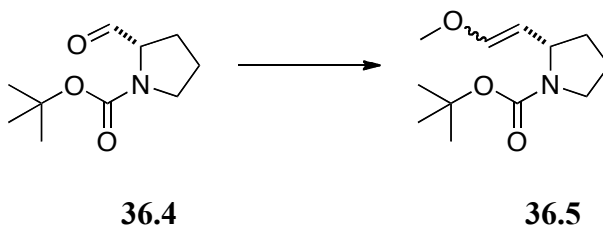

$(\text{Me}_3\text{Si})_2\text{NK}$ (0.5 M solution in PhMe, 60 mL, 0.031 mol) was added dropwise to a stirred and cooled (0 °C) solution of $\text{Ph}_3\text{PCH}_2(\text{OMe})\text{Cl}$ (11.12 g, 0.032 mol) in dry THF (80 mL). Stirring was continued for 1 h and a solution of **36.4** (3.23 g, 0.016 mol) in THF (10 mL) was then added dropwise and stirring was continued for 2 h. The cooling bath was removed and stirring was continued for a further 3 h. The mixture was quenched with water and partitioned between EtOAc and water. The aqueous phase was extracted with EtOAc, and the combined organic extracts were washed with brine, dried (MgSO_4), and

evaporated. Flash chromatography of the residue over silica gel (3.8 x 15 cm), using 15% EtOAc-hexanes, gave **36.5** (3.42 g, 93%) as an oil which was an inseparable mixture of *Z* and *E* diastereoisomers. The material was used for the next reaction.

(2*S*)-2-(2-Oxoethyl)-1-pyrrolidinecarboxylic acid 1,1-dimethylethyl ester (34.1).⁴⁷

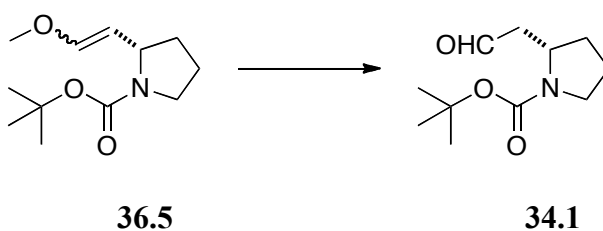

Hg(OAc)₂ (6.34 g, 0.019 mol) was added to a stirred and cooled (0 °C) solution of **36.5** (1.51 g, 6.63 mmol) in a 9:1 mixture of THF and water (60 mL). The cooling bath was removed and stirring was continued for 3 h. The reaction was quenched with saturated aqueous KI and the mixture was partitioned between EtOAc and water. The aqueous phase was extracted with EtOAc, and the combined organic extracts were washed with saturated KI and brine, dried (MgSO₄), and evaporated. Flash chromatography of the residue over silica gel (1.7 x 15 cm), using 15% EtOAc-hexanes, gave **34.1** (0.79 g, 56%) as an oil: $[\alpha]_D^{25} -32.7$ (*c* = 1.50, CHCl₃); FTIR (CHCl₃ cast) 2975, 2933, 2882, 2731, 1723, 1692 cm⁻¹; ¹H NMR (CDCl₃, 400 MHz, 60 °C) δ 1.44 (s, 9 H), 1.59-1.68 (m, 1 H), 1.79-1.88 (m, 2 H), 2.01-2.13 (m, 1 H), 2.45 (ddd, 1 H), 2.80 (d, 1 H), 3.29-

3.41 (m, 2 H), 4.18-4.23 (m, 1 H), 9.78-9.80 (m, 1 H); ^{13}C NMR (CDCl_3 , 125 MHz, 60 °C) δ 23.4 (t), 28.5 (q), 31.6 (t), 46.5 (t), 49.3 (t), 52.5 (d), 79.7 (s), 154.4 (s), 200.4 (s); exact mass (electrospray) m/z calcd for $\text{C}_{11}\text{H}_{19}\text{NNaO}_3$ 236.1257, found 236.1255.

In a subsequent experiment, the product obtained by evaporation of the eluant from the flash chromatography was diluted with CHCl_3 and the supernatant solution was transferred to another flask (leaving behind a red material) and evaporated. The residue was resubjected to the same process (trituration with chloroform) several times until almost all of the red impurity had been removed. The overall yield was 98%.

(2*S*)-2-(2-Cyanomethyl)-1-pyrrolidinecarboxylic acid 1,1-dimethylethyl ester (97.1).⁴⁸

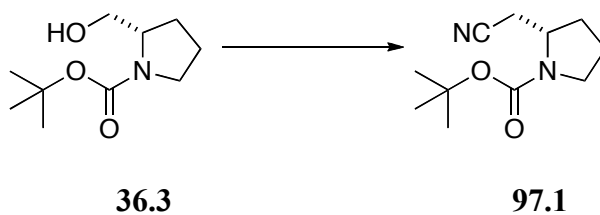

Et_3N (3.17 mL, 0.023 mol), followed by MeSO_2Cl (1.50 mL, 0.019 mol), were added to a stirred and cooled (0 °C) solution of **36.3** (3.27 g, 0.016 mol) in CH_2Cl_2 (35 mL). Stirring was continued for 2 h and the reaction was quenched with water and with hydrochloric acid (0.5 M). The reaction mixture was extracted twice with CHCl_3 , and the combined organic extracts were dried

(MgSO₄) and evaporated to give the crude mesylate. Bu₄Ni (0.60 g, 1.62 mmol), followed by NaCN (3.18 g, 0.065 mol), was added to a solution of the mesylate in DMSO (50 mL) and the mixture was heated overnight at 50 °C, cooled to room temperature and diluted with water (100 mL). This mixture was extracted three times with EtOAc and the combined organic extracts were dried (MgSO₄) and evaporated. Flash chromatography of the residue over silica gel (4 x 10 cm), using 30% EtOAc-hexanes, gave **97.1** (3.05 g, 89% over 2 steps) as a clear oil: $[\alpha]_D^{25}$ -95.98 (*c* = 0.62, CHCl₃); FTIR (CHCl₃ cast) 2249, 1693 cm⁻¹; ¹H NMR (CDCl₃, 500 MHz, 60 °C) δ 1.50 (s, 9 H), 1.83-1.96 (m, 2 H), 1.97-2.06 (m, 1 H), 2.19 (app. dq, *J* = 12.6, 7.6 Hz, 1 H), 2.50-2.90 (m, 2 H), 3.40-3.50 (m, 2 H), 4.00-4.05 (m, 1 H); ¹³C NMR (CDCl₃, 125 MHz, 60 °C) δ 22.6 (t), 23.5 (t), 28.5 (t), 30.8 (q), 47.0 (t), 53.9 (d), 80.2 (s), 117.7 (s), 154.4 (s); exact mass (electrospray) *m/z* calcd for C₁₁H₁₈N₂NaO₂ 233.1260, found 233.1261.

4-[(Phenylsulfonyl)oxy]benzeneacetic acid methyl ester (90.3).

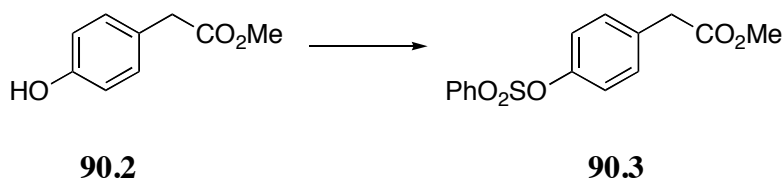

Et₃N (1.76 mL, 12.6 mmol) and PhSO₂Cl (1.62 mL, 12.6 mmol) were added to a stirred and cooled (0 °C) solution of **90.2** (2.00 g, 12.1 mmol) in dry CH₂Cl₂ (60 mL). The cold bath was left in place but not recharged and stirring

was continued overnight. The mixture was partitioned between CHCl_3 and water and the combined organic extracts were washed with brine, dried (MgSO_4), and evaporated. Flash chromatography of the residue over silica gel (3 x 15 cm), using first hexanes, and then 25% EtOAc-hexanes, gave **90.3** (2.59 g, 70%) as an oil: FTIR (neat film) 1738 cm^{-1} ; $^1\text{H NMR}$ (CDCl_3 , 500 MHz) δ 3.58 (s, 2 H), 3.68 (s, 3 H), 6.92-6.94 (m, 2 H), 7.19-7.21 (m, 2 H), 7.51-7.54 (m, 2 H), 7.65-7.68 (m, 1 H), 7.82-7.84 (m, 2 H); $^{13}\text{C NMR}$ (CDCl_3 , 125 MHz) δ 40.4 (t), 52.1 (q), 122.4 (d), 128.5 (d), 129.2 (d), 130.5 (d), 133.1 (s), 134.2 (d), 135.4 (s), 148.6 (s), 171.4 (s); exact mass (electrospray) m/z calcd for $\text{C}_{15}\text{H}_{14}\text{NaO}_5\text{S}$ 329.0454, found 329.0453.

α -Bromo-4-[(phenylsulfonyl)oxy]benzeneacetic acid methyl ester (90.4).

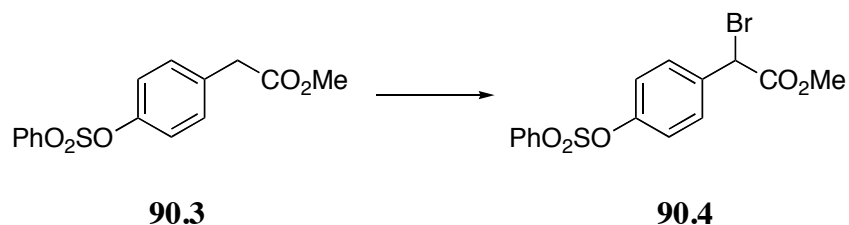

Benzoyl peroxide (44.3 mg, 0.18 mmol) and NBS (recrystallized from water, 1.74 g, 9.78 mmol) were tipped into a solution of **90.3** (2.80 g, 9.78 mmol) in dry CCl_4 (40 mL). The mixture was then heated at $90\text{ }^\circ\text{C}$ with illumination by uv light (Hanovia, 140 Watt, type 30620) for 4 h. The mixture was cooled and partitioned between CHCl_3 and water and the combined organic extracts were washed with water and brine, dried (MgSO_4), and evaporated. Flash

chromatography of the residue over silica gel (3.6 x 15 cm), using first hexanes, and then 20% EtOAc-hexanes, gave **90.4** containing a trace amount (^1H NMR) of **90.3**. Recrystallization from EtOAc-hexanes (the material was dissolved in EtOAc and then hexane was added to just avoid slight turbidity) gave **90.4** as a white solid (3.09 g, 88%): mp 86-87 °C; FTIR (CHCl_3 cast) 1748 cm^{-1} ; ^1H NMR (CDCl_3 , 500 MHz) δ 3.78 (s, 3 H), 5.30 (s, 1 H), 6.98-6.70 (m, 2 H), 7.48-7.50 (m, 2 H), 7.53-7.56 (m, 2 H), 7.67-7.70 (m, 1 H), 7.84-7.86 (m, 2 H); ^{13}C NMR (CDCl_3 , 125 MHz) δ 45.0 (d), 55.5 (q), 122.7 (d), 128.4 (d), 129.3 (d), 130.2 (d), 134.4 (d), 134.7 (s), 135.3 (s), 149.9 (s), 168.4 (s); exact mass (electrospray) m/z calcd for $\text{C}_{15}\text{H}_{13}^{79}\text{BrNaO}_5\text{S}$ 406.9559, found 406.9564.

(2S)-1-[(1,1-Dimethylethoxy)carbonyl]- β -hydroxy- α -[[4-phenylsulfonyl]oxy]phenyl]-2-pyrrolidinebutanoic acid methyl ester (91.1**).**

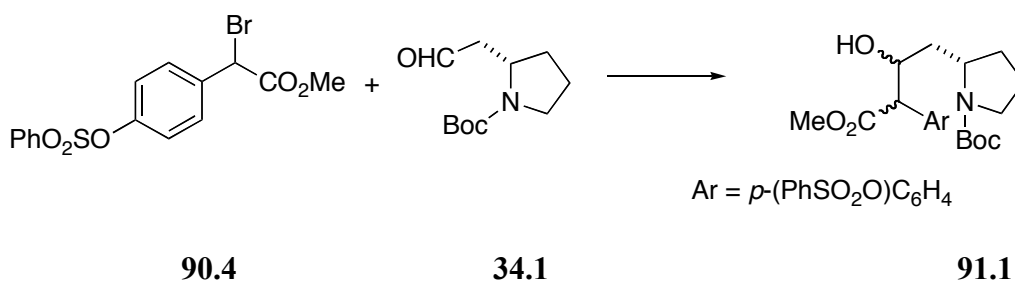

Zn dust (0.518 mg, 7.92 mmol) was tipped into a stirred solution of **34.1** (0.704 g, 3.30 mmol) in THF (20 mL) and the mixture was cooled to -40 °C. A solution of **90.4** (2.54 g, 6.61 mmol) in THF (10 mL plus 8 mL as a rinse) was added by syringe. The cold bath was left in place but not recharged and stirring

was continued overnight. The mixture was quenched with saturated aqueous NH_4Cl , followed by hydrochloric acid (0.5 M) and stirring was continued for 30 min. The mixture was partitioned between EtOAc and water and the combined organic extracts were washed with brine, dried (MgSO_4), and evaporated. Flash chromatography of the residue over silica gel (3.2 x 15 cm), using first hexanes, and then 100 mL portions of 20%, 22%, 24%...42% EtOAc-hexanes, gave **91.1** (1.68 g, 98%) as a golden oil consisting of four diastereoisomers. The least and most polar diastereoisomers were isolated for spectroscopic characterization.

Least polar diastereoisomer: $[\alpha]_D^{25} -6.05$ ($c = 0.36$, CHCl_3); FTIR (CHCl_3 cast) 3374, 2975, 1736, 1666 cm^{-1} ; ^1H NMR (CDCl_3 , 400 MHz, 60 °C) δ 1.30-1.43 (m, 2 H), 1.46 (s, 9 H), 1.49-1.62 (m, 2 H), 1.80-1.87 (m, 2 H), 1.91-1.99 (m, 1 H), 3.27-3.39 (m, 2 H), 3.59 (d, $J = 7.5$ Hz, 1 H), 3.65 (s, 3 H), 4.09-4.18 (m, 2 H), 6.94-6.96 (m, 2 H), 7.29-7.31 (m, 2 H), 7.48-7.52 (m, 2 H), 7.61-7.65 (m, 1 H), 7.83-7.86 (m, 2 H); ^{13}C NMR (CDCl_3 , 100 MHz, 60 °C) δ 23.5 (t), 28.5 (q), 31.5 (t), 41.3 (t), 46.4 (t), 51.9 (q), 54.2 (d), 57.1 (d), 69.4 (d), 80.1 (s), 121.9 (d), 128.4 (d), 129.1 (d), 130.5 (d), 134.0 (d), 135.7 (s), 136.1 (s), 149.0 (s), 155.3 (s), 172.7 (s); exact mass (electrospray) m/z calcd for $\text{C}_{26}\text{H}_{33}\text{NNaO}_8\text{S}$ 542.1819, found 542.1819. This sample contained slight impurities (^1H NMR), but the product from the next step was obtained pure.

Most polar diastereoisomer: $[\alpha]_D^{25} -50.1$ ($c = 0.46$, MeOH); FTIR (CHCl_3 cast) 3420, 2973, 1737, 1687 cm^{-1} ; ^1H NMR (CDCl_3 , 400 MHz, 60 °C) δ 1.21-1.27 (m, 1 H), 1.42-1.48 (m, 11 H), 1.61-1.67 (m, 2 H), 1.70-1.78 (m, 1 H), 1.87-1.95 (dddd, $J = 14.8, 9.9, 7.5, 7.5$ Hz, 1 H), 3.22 (ddd, $J = 11.9, 7.8, 4.1$ Hz, 1 H),

3.30-3.36 (m, 1 H), 3.59 (d, $J = 8.6$ Hz, 1 H), 3.68 (s, 3 H), 3.97 (dddd, $J = 7.6$, 7.6, 7.6, 2.9 Hz, 1 H), 4.10-4.15 (m, 1 H), 6.96-6.99 (m, 2 H), 7.25-7.27 (m, 2 H), 7.49-7.53 (m, 2 H), 7.63-7.68 (m, 1 H), 7.84-7.86 (m, 2 H); ^{13}C NMR (CDCl_3 , 100 MHz, 60 °C) δ 23.5 (t), 28.6 (q), 31.7 (t), 40.2 (t), 46.5 (t), 52.0 (q), 54.9 (d), 58.1 (d), 72.3 (d), 79.8 (s), 122.5 (d), 128.5 (d), 129.2 (d), 129.9 (d), 134.3 (d), 135.5 (s), 136.1 (s), 149.2 (s), 155.3 (s), 173.1 (s); exact mass (electrospray) m/z calcd for $\text{C}_{26}\text{H}_{33}\text{NNaO}_8\text{S}$ 542.1819, found 542.1819.

(2*S*)- β -[[[(1,1-Dimethylethyl)dimethylsilyl]oxy]-1-[(1,1-dimethylethoxy)carbonyl]- α -[[[4-phenylsulfonyl]oxy]phenyl]-2-pyrrolidinebutanoic acid methyl ester (95.1).

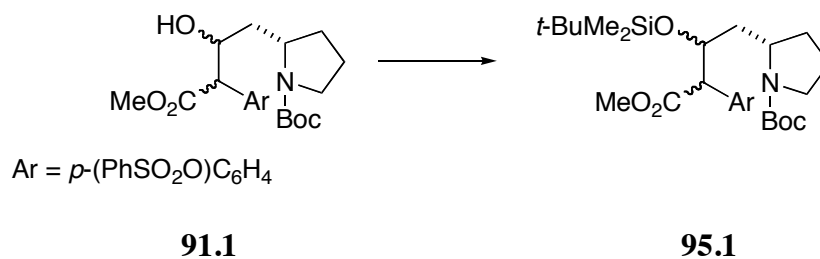

The following procedure for the least polar diastereoisomer of **91.1** was repeated on the most polar and also on a mixture of the four isomers.

2,6-Lutidine (0.19 mL, 1.64 mmol) and then TBSOTf (0.25 mL, 1.10 mmol) were added by syringe to a stirred and cooled (-78 °C) solution of **91.1** (least polar isomer, 0.282 g, 0.55 mmol) in dry CH_2Cl_2 (6 mL). Stirring at -78 °C was continued for 3 h and the mixture was quenched with saturated aqueous

NaHCO₃ and water. The mixture was partitioned between CHCl₃ and water and the combined organic extracts were washed with brine, dried (MgSO₄), and evaporated. Flash chromatography of the residue over silica gel (2 x 15 cm), using first hexanes, and then 100 mL portions, of 14%, 16%...20% EtOAc-hexanes, gave a **95.1** (0.265 g, 77%) as a clear oil: $[\alpha]_D^{25}$ -17.76 ($c = 0.68$, CHCl₃); FTIR (CHCl₃ cast) 2956, 1736, 1691 cm⁻¹; ¹H NMR (CDCl₃, 400 MHz, 60 °C) δ -0.12 (s, 3 H), -0.05 (s, 3 H), 0.82 (s, 9 H), 1.42 (s, 9 H), 1.47-1.51 (m, 1 H), 1.70-1.86 (m, 4 H), 1.89-1.95 (m, 1 H), 3.22-3.33 (m, 2 H), 3.66 (s, 3 H), 3.78 (br s, 2 H), 4.35-4.40 (m, 1 H), 6.93-6.95 (m, 2 H), 7.34-7.36 (m, 2 H), 7.48-7.52 (m, 2 H), 7.61-7.65 (m, 1 H), 7.85-7.87 (m, 2 H); ¹³C NMR (CDCl₃, 100 MHz, 60 °C) δ -4.8 (q), -4.2 (q), 18.0 (t), 23.4 (s), 25.9 (q), 28.6 (q), 31.7 (t), 40.9 (t), 46.0 (t), 51.8 (q), 55.1 (d), 72.7 (d), 79.2 (s), 120.2 (d), 121.6 (d), 128.5 (d), 129.1 (d), 131.6 (d), 134.0 (d), 134.8 (s), 136.6 (s), 149.1 (s), 154.5 (s), 172.3 (s); exact mass (electrospray) m/z calcd for C₃₂H₄₇NNaO₈SSi 656.2684, found 656.2685.

Use of most polar isomer of **91.1**:

2,6-Lutidine (0.16 mL, 1.51 mmol) and then TBSOTf (0.23 mL, 1.01 mmol) were added by syringe to a stirred and cooled (-78 °C) solution of **91.1** (most polar isomer, 0.262 g, 0.51 mmol) in dry CH₂Cl₂ (6 mL). Stirring at -78 °C was continued for 3 h and the mixture was quenched with saturated aqueous NaHCO₃ and water. The mixture was partitioned between CHCl₃ and water and the combined organic extracts were washed with brine, dried (MgSO₄), and evaporated. Flash chromatography of the residue over silica gel (2 x 15 cm),

using first hexanes, and then 100 mL portions of 14%, 16%...20% EtOAc-hexanes, gave a **95.1** (0.282 g, 88%) as a clear oil: $[\alpha]_D^{25} -19.53$ ($c = 0.60$, CHCl_3); FTIR (CHCl_3 cast) 2955, 1739, 1690 cm^{-1} ; ^1H NMR (CDCl_3 , 400 MHz, 60 °C) δ 0.03 (s, 3 H), 0.08 (s, 3 H), 0.88 (s, 9 H), 1.16-1.26 (m, 1 H), 1.39 (s, 9 H), 1.59-1.61 (m, 2 H), 1.68-1.86 (m, 3 H), 3.12-3.17 (m, 1 H), 3.30-3.33 (m, 1 H), 3.65 (s, 3 H), 3.80-3.84 (m, 1 H), 3.88-3.94 (m, 1 H), 4.27 (dd, $J = 7.5, 3.8$ Hz, 1 H), 6.90-6.92 (m, 2 H), 7.28-7.32 (m, 2 H), 7.48-7.52 (m, 2 H), 7.61-7.66 (m, 1 H), 7.83-7.85 (m, 2 H); ^{13}C NMR (CDCl_3 , 100 MHz, 60 °C) δ -4.6 (q), -4.1 (q), 18.1 (t), 23.0 (s), 26.0 (q), 28.6 (q), 30.5 (t), missing signal (t), 46.0 (t), 51.7 (q), 54.0 (d), 72.4 (d), 79.1 (s), 120.1 (d), 122.1 (d), 128.5 (d), 129.1 (d), 130.5 (d), 134.1 (d), 136.5 (s), 149.1 (s), 154.5 (s), 157.7 (s), 172.6 (s); exact mass (electrospray) m/z calcd for $\text{C}_{32}\text{H}_{47}\text{NNaO}_8\text{SSi}$ 656.2684, found 656.2694.

Use of an unequal mixture of all four isomers of **91.1**:

2,6-Lutidine (0.76 mL, 6.52 mmol) and then TBSOTf (1.00 mL, 4.34 mmol) were added by syringe to a stirred and cooled (-78 °C) solution of **91.1** (unequal mixture of all four diastereoisomers, 1.13 g, 2.17 mmol) in dry CH_2Cl_2 (30 mL). Stirring at -78 °C was continued for 3 h and the mixture was quenched with saturated aqueous NaHCO_3 and water. The mixture was partitioned between CHCl_3 and water and the combined organic extracts were washed with brine, dried (MgSO_4), and evaporated. Flash chromatography of the residue over silica gel (3.7 x 15 cm), using first hexanes, and then 100 mL portions of 14%, 16%...20% EtOAc-hexanes, gave **95.1** (0.941 g, 68%) as a clear oil.

(2*S*)-2-[2-[[[(1,1-Dimethylethyl)dimethylsilyl]oxy]-4-hydroxy-3-[[4-phenylsulfonyl]oxy]phenyl]butyl]-1-pyrrolidinecarboxylic acid 1,1-dimethylethyl ester (95.2).

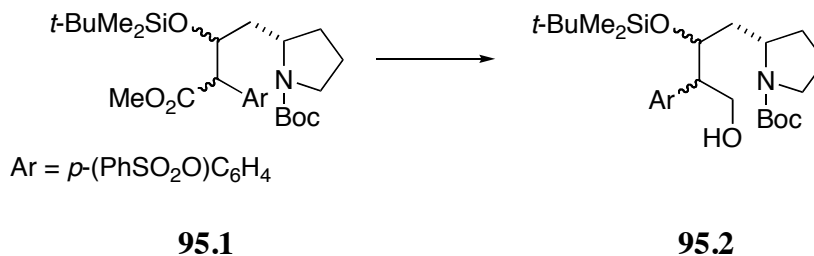

The following procedure for the material derived from the least polar diastereoisomer of alcohol **91.1** was repeated on material derived from the most polar isomer of **91.1** and also on material derived from a mixture of the four isomers of **91.1**.

DIBAL-H (1.0 M in PhMe, 1.70 mL, 1.67 mmol) was added by syringe to a stirred and cooled (-78 °C) solution of **95.1** (from least polar parent alcohol, 0.265 g, 0.42 mmol) in dry THF (8 mL). Stirring was continued for 20 min, the cooling bath was removed and stirring was continued for 50 min. The mixture was quenched with MeOH and saturated aqueous sodium potassium tartrate and vigorous stirring was continued for 1.5 h. The mixture was partitioned between EtOAc and water and the combined organic extracts were washed with brine, dried (MgSO₄), and evaporated. Flash chromatography of the residue over silica gel (1.7 x 11 cm), using first hexanes, and then 40% EtOAc-hexanes, gave **95.2**

(0.154 g, 61%) as a clear oil: $[\alpha]_D^{25}$ -11.61 ($c = 0.87$, CHCl_3); FTIR (CHCl_3 cast) 3430, 2956, 1690 cm^{-1} ; ^1H NMR (CDCl_3 , 400 MHz, 60 °C) δ 0.10 (s, 3 H), 0.12 (s, 3 H), 0.90 (s, 9 H), 1.36 (s, 9 H), 1.67-1.71 (m, 1 H), 1.77-1.92 (m, 5 H), 2.97 (ddd, $J = 7.2, 7.2, 3.1$ Hz, 1 H), 3.25 (ddd, $J = 11.1, 6.0, 6.0$ Hz, 1 H), 3.34 (ddd, $J = 10.9, 7.6, 7.6$ Hz, 1 H), 3.78 (br s, 1 H), 3.83 (dd, $J = 10.6, 6.6$ Hz, 1 H), 3.99 (dd, $J = 10.4, 10.4$ Hz, 1 H), 4.18-4.22 (m, 1 H), 6.93-6.95 (m, 2 H), 7.26-7.29 (m, 2 H), 7.49-7.53 (m, 2 H), 7.62-7.66 (m, 1 H), 7.85-7.87 (m, 2 H); ^{13}C NMR (CDCl_3 , 100 MHz, 60 °C) δ -4.5 (q), -4.1 (q), 18.1 (t), 23.4 (s), 26.0 (q), 28.6 (q), 31.7 (t), 39.9 (t), 46.1 (t), 52.3 (d), 55.4 (d), 63.9 (t), 72.4 (d), 79.3 (s), 121.9 (d), 128.5 (d), 129.1 (d), 131.0 (d), 134.0 (d), 136.2 (s), 138.3 (s), 148.7 (s), 154.6 (s); exact mass (electrospray) m/z calcd for $\text{C}_{31}\text{H}_{47}\text{NNaO}_7\text{SSi}$ 628.2735, found 628.2741.

Use of material derived from the most polar isomer of **91.1**:

DIBAL-H (1.0 M in PhMe, 1.80 mL, 1.78 mmol) was added by syringe to a stirred and cooled (-78 °C) solution of **95.1** (from most polar parent alcohol, 0.282 g, 0.45 mmol) in dry THF (8 mL). Stirring was continued for 20 min, the cooling bath was removed and stirring was continued for 50 min. The mixture was quenched with MeOH and saturated aqueous sodium potassium tartrate and vigorous stirring was continued for 1.5 h. The mixture was partitioned between EtOAc and water and the combined organic extracts were washed with brine, dried (MgSO_4), and evaporated. Flash chromatography of the residue over silica gel (1.7 x 11 cm), using first hexanes, and then 40% EtOAc-hexanes, gave **95.2**

(0.177 g, 66%) as a clear oil: $[\alpha]_D^{25}$ -8.48 ($c = 0.46$, CHCl_3); FTIR (CHCl_3 cast) 3423, 2957, 1688 cm^{-1} ; ^1H NMR (CDCl_3 , 400 MHz, 60 °C) δ -0.29 (br s, 3 H), -0.05 (s, 3 H), 0.84 (s, 9 H), 1.42 (s, 9 H), 1.62-1.66 (m, 2 H), 1.76-1.95 (m, 4 H), 3.19 (br s, 1 H), 3.26 (ddd, $J = 11.3, 6.0, 6.0$ Hz, 1 H), 3.39 (ddd, $J = 11.0, 8.1, 8.1$ Hz, 1 H), 3.96-4.13 (m, 4 H), 6.91-6.93 (m, 2 H), 7.38-7.43 (br s, 2 H), 7.48-7.52 (m, 2 H), 7.62-7.66 (m, 1 H), 7.84-7.6 (m, 2 H); ^{13}C NMR (CDCl_3 , 100 MHz, 60 °C) δ -5.0 (q), -4.6 (q), 18.0 (t), 23.5 (s), 25.9 (q), 28.6 (q), 31.4 (t), 41.6 (t), 46.1 (t), 54.0 (d), 54.1 (d), 63.0 (t), 74.3 (d), 79.3 (s), 121.1 (d), 128.4 (d), 129.1 (d), 130.4 (d), 134.0 (d), 136.2 (s), 141.3 (s), 148.5 (s), 155.0 (s); exact mass (electrospray) m/z calcd for $\text{C}_{31}\text{H}_{47}\text{NNaO}_7\text{SSi}$ 628.2735, found 628.2746.

Use of material derived from an unequal mixture of all four isomers of **91.1**:

DIBAL-H (1.0 M in PhMe, 5.90 mL, 5.94 mmol) was added by syringe to a stirred and cooled (-78 °C) solution of **95.1** (unequal mixture of four alcohol diastereoisomers, 0.941 g, 1.48 mmol) in dry THF (30 mL). Stirring was continued for 20 min, the cooling bath was removed and stirring was continued for 50 min. The mixture was quenched with MeOH and saturated aqueous sodium potassium tartrate and vigorous stirring was continued for 1.5 h. The mixture was partitioned between EtOAc and water and the combined organic extracts were washed with brine, dried (MgSO_4), and evaporated. Flash chromatography of the residue over silica gel (2.1 x 13 cm), using first hexanes, and then 40% EtOAc-hexanes, gave **95.2** (0.586 g, 65%) as a clear oil.

(2*S*)-2-[2-[[1,1-Dimethylethyl)dimethylsilyl]oxy]-3-[[4-phenylsulfonyl)oxy]phenyl]-3-buten-1-yl]-1-pyrrolidinecarboxylic acid 1,1-dimethylethyl ester (**95.4**).

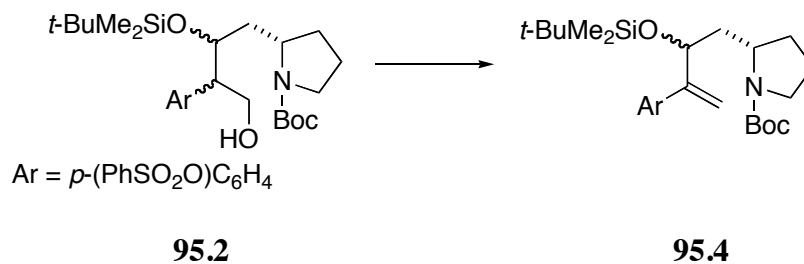

The following procedure for the material derived from the least polar diastereoisomer of alcohol **91.1** was repeated on material derived from the most polar isomer of **91.1** and also on material derived from the unequal mixture of the four isomers of **91.1**.

o-O₂NC₆H₄SeCN (0.151 g, 0.67 mmol) was tipped into a stirred solution of **95.2** (0.161 g, 0.27 mmol) in dry THF (3 mL). Bu₃P (0.1 mL, 0.67 mmol) was injected and stirring was continued for 4 h. Evaporation of the solvent and flash chromatography of the residue over silica gel (1.7 x 15 cm), using first hexanes, and then 50-mL portions of 10%, 12%...20% EtOAc-hexanes, gave the intermediate selenide (0.180 g, 86%) as a yellow oil (containing slight selenium contaminants). H₂O₂ (30%, 2.5 mL) was added to a stirred solution of the intermediate selenide (all the material) in THF (11 mL) and stirring was continued overnight. The mixture was quenched with aqueous NaOH (10%) and partitioned between EtOAc and water. The combined organic extracts were washed with

aqueous NaOH (10%) and brine, dried (MgSO₄) and evaporated. Flash chromatography of the residue over silica gel (1.7 x 10 cm), using first 10% EtOAc-hexanes, and then 50 mL portions of 12%, 14%...20% EtOAc-hexanes, gave **95.4** (0.096g, 62% over 2 steps) as a yellow oil, evidently containing a colored impurity, which was not observable in the ¹H and ¹³C NMR spectra. The impurity is removed in the next step: $[\alpha]_D^{25}$ -8.09 (*c* = 0.43, CHCl₃); FTIR (CHCl₃ cast) 2956, 1691 cm⁻¹; ¹H NMR (CDCl₃, 500 MHz, 60 °C) δ 0.01 (s, 3 H), 0.11 (s, 3 H), 0.91 (s, 9 H), 1.36 (s, 9 H), 1.51 (ddd, *J* = 13.8, 9.4, 8.3 Hz, 1 H), 1.74-1.78 (m, 2 H), 1.83-1.89 (m, 4 H), 1.85 (ddd, *J* = 13.7, 4.9, 2.7 Hz, 1 H), 3.70-3.76 (m, 1 H), 4.64 (br s, 1 H), 5.26 (d, 1.4 Hz, 1 H), 5.34 (s, 1 H), 6.93-6.96 (m, 2 H), 7.39-7.42 (m, 2 H), 7.49-7.54 (m, 2 H), 7.62-7.67 (m, 1 H), 7.85-7.87 (m, 2 H); ¹³C NMR (CDCl₃, 100 MHz, 60 °C) δ -4.7 (q), -4.4 (q), 18.2 (t), 23.3 (s), 26.0 (q), 28.6 (q), 32.0 (t), 43.5 (t), 46.0 (t), 56.2 (d), 75.0 (d), 78.9 (s), 114.2 (t), 122.0 (d), 128.5 (d), 128.5 (d), 129.1 (d), 134.1 (d), 136.1 (s), 138.8 (s), 149.2 (s), 150.8 (s), 154.3 (s); exact mass (electrospray) *m/z* calcd for C₃₁H₄₅NNaO₆SSi 610.2629, found 610.2631. This spectrum showed the presence of some contaminants, but all contaminants were removed in the next step.

Use of material derived from the most polar isomer of **91.1**:

o-O₂NC₆H₄SeCN (0.078 g, 0.34 mmol) was tipped into a stirred solution of **95.2** (0.173 g, 0.29 mmol) in dry THF (5 mL). Bu₃P (0.05 mL, 0.34 mmol) was injected and stirring was continued for 4 h. Evaporation of the solvent and flash chromatography of the residue over silica gel (1.7 x 15 cm), using first

hexanes, and then 50-mL portions of 10%, 12%...20% EtOAc-hexanes, gave the intermediate selenide (0.176 g, 78%) as a yellow oil. H₂O₂ (30%, 0.8 mL) was added to a stirred solution of the intermediate selenide (all the material) in THF (5 mL) and stirring was continued overnight. The mixture was quenched with aqueous NaOH (10%) and partitioned between EtOAc and water. The combined organic extracts were washed with aqueous NaOH (10%) and brine, dried (MgSO₄), and evaporated. Flash chromatography of the residue over silica gel (1.7 x 10 cm), using first 10% EtOAc-hexanes, and then 50 mL portions of 12%, 14%...20% EtOAc-hexanes, gave **95.4** (0.111 g, 66% over two steps) as a yellow oil, evidently containing a colored impurity, which was not observable in the ¹H and ¹³C NMR spectra. The impurity is removed in the next step: $[\alpha]_D^{25} -25.09$ ($c = 0.42$, CHCl₃); FTIR (CHCl₃ cast) 2958, 1691 cm⁻¹; ¹H NMR (CDCl₃, 500 MHz) δ 0.01 (s, 3 H), 0.10 (s, 3 H), 0.92 (s, 9 H), 1.30-1.35 (m, 1 H), 1.42 (s, 9 H), 1.68-1.77 (m, 3 H), 1.84-1.92 (m, 1 H), 2.10 (ddd, $J = 13.0, 9.0, 3.4$ Hz, 1 H), 3.22-3.26 (m, 1 H), 3.32-3.96 (m, 1 H), 3.93-3.96 (m, 1 H), 4.57 (d, $J = 7.7$ Hz, 1 H), 5.27 (s, 1 H), 5.34 (s, 1 H), 6.95-6.97 (m, 2 H), 7.38-7.40 (m, 2 H), 7.51-7.54 (m, 2 H), 7.64-7.67 (m, 1 H), 7.86-7.88 (m, 2 H); ¹³C NMR (CDCl₃, 125 MHz) δ -4.9 (q), -4.4 (q), 18.3 (t), 23.2 (s), 25.9 (q), 28.7 (q), 30.2 (t), 41.8 (t), 46.1 (t), 54.4 (d), 73.8 (d), 79.0 (s), 114.5 (t), 122.1 (d), 128.5 (d), 128.6 (d), 129.2 (d), 134.1 (d), 136.2 (s), 138.8 (s), 149.2 (s), 150.6 (s), 154.4 (s); exact mass (electrospray) m/z calcd for C₃₁H₄₅NNaO₆SSi 610.2629, found 610.2619.

Use of material derived from the unequal mixture of four isomers of **91.1**:

o-O₂NC₆H₄SeCN (0.264 g, 1.16 mmol) was tipped into a stirred solution of **95.2** (unequal mixture of four diastereoisomers, 0.586 g, 0.97 mmol) in dry THF (20 mL). Bu₃P (0.16 mL, 1.16 mmol) was injected and stirring was continued for 4 h. Evaporation of the solvent and flash chromatography of the residue over silica gel (3.0 x 15 cm), using first hexanes, and then 50-mL portions of 10%, 12%...20% EtOAc-hexanes, gave the intermediate selenide (0.7678 g, >100%) as a yellow oil (containing selenium contaminants). H₂O₂ (30%, 3.0 mL) was added to a stirred solution of the intermediate selenide (all the material) in THF (15 mL) and stirring was continued overnight. The mixture was quenched with aqueous NaOH (10%) and partitioned between EtOAc and water. The combined organic extracts were washed with aqueous NaOH (10%) and brine, dried (MgSO₄), and evaporated. Flash chromatography of the residue over silica gel (1.7 x 15 cm), using first 10% EtOAc-hexanes, and then 50 mL portions of 12%, 14%...20% EtOAc-hexanes, gave the less polar diastereoisomer of **95.4** (0.068 g, 12%) and the more polar diastereoisomer of **95.4** (0.364 g, 64%) as yellow oils, evidently containing a colored impurity, which was not observable in the ¹H and ¹³C NMR spectra. The impurity was removed in the next step.

(2*S*)-2-[2-Hydroxy-3-[[4-(phenylsulfonyl)oxy]phenyl]-3-buten-1-yl]-1-pyrrolidinecarboxylic acid 1,1-dimethylethyl ester (**95.5**).

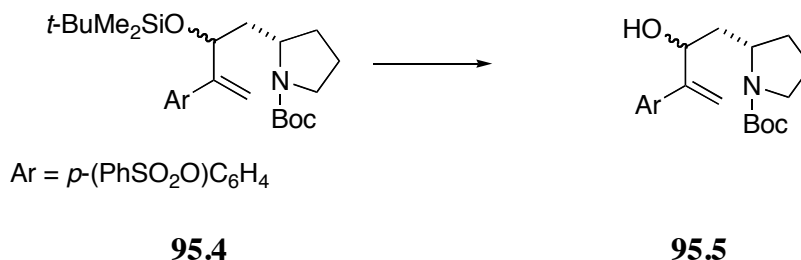

Use of the less polar diastereoisomer of **95.4**:

Concentrated hydrochloric acid (2% v/v in MeOH, 6 mL) was added with swirling to **95.4** (less polar isomer, 0.124 g, 0.21 mmol). The mixture was stirred for 1.5 h, quenched with saturated aqueous NaHCO₃ and partitioned between EtOAc and water. The combined organic extracts were washed with brine, dried (MgSO₄), and evaporated. Flash chromatography of the residue over silica gel (1.7 x 10 cm), using first 20% EtOAc-hexanes and then 30% EtOAc-hexanes, gave **95.5** as a clear oil (0.099 g, 98%): $[\alpha]_D^{25} -39.69$ ($c = 0.40$, CHCl₃); FTIR (CHCl₃ cast) 3387, 2975, 1666 cm⁻¹; ¹H NMR (CDCl₃, 400 MHz, 55 °C) δ 1.47 (s, 12 H), 1.71-1.85 (m, 2 H), 1.89-1.99 (m, 1 H), 3.25 (ddd, $J = 11.3, 8.1, 3.5$ Hz, 1 H), 3.35 (dd, $J = 18.7, 10.3$ Hz, 1 H), 4.17 (br s, 1 H), 4.51 (d, $J = 10.5$ Hz, 1 H), 5.19 (br s, 1 H), 5.26 (s, 1 H), 5.44 (s, 1 H), 6.92-6.96 (m, 2 H), 7.30-7.33 (m, 2 H), 7.48-7.53 (m, 2 H), 7.62-7.66 (m, 1 H), 7.83-7.86 (m, 2 H); ¹³C NMR (CDCl₃, 100 MHz, 55 °C) δ 23.6 (t), 28.5 (q), 31.5 (t), 42.9 (t), 46.5 (t), 54.0 (d), 69.8 (d), 80.1 (s), 113.4 (t), 122.0 (d), 128.1 (d), 128.5 (d), 129.1 (d), 134.1 (d),

136.0 (s), 139.7 (s), 149.0 (s), 149.9 (s) 156.7 (s); exact mass (electrospray) m/z calcd for $C_{25}H_{31}NNaO_6S$ 496.1764, found 496.1766.

Use of the more polar diastereoisomer of **95.4**:

Concentrated hydrochloric acid (2% v/v in MeOH, 6 mL) was added with swirling to **95.4** (more polar isomer, 0.103 g, 0.17 mmol). The mixture was stirred for 3 h, quenched with saturated aqueous $NaHCO_3$ and partitioned between EtOAc and water. The combined organic extracts were washed with brine, dried ($MgSO_4$), and evaporated. Flash chromatography of the residue over silica gel (1.7 x 15 cm), using first 20% EtOAc-hexanes and then 30% EtOAc-hexanes, gave **95.5** as a clear oil (0.088 g, 100%): $[\alpha]_D^{25}$ -17.20 ($c = 0.45$, $CHCl_3$); FTIR ($CHCl_3$ cast) 3400, 2975, 1671 cm^{-1} ; 1H NMR ($CDCl_3$, 400 MHz, 60 °C) δ 1.45 (s, 9 H), 1.53-1.60 (m, 2 H), 1.71-1.85 (m, 3 H), 1.92-1.99 (m, 1 H), 3.24 (ddd, $J = 11.8, 7.6, 4.5$ Hz, 1 H), 3.33 (dd, $J = 18.1, 8.9$ Hz, 1 H), 4.00-4.05 (m, 1 H), 4.60 (d, $J = 9.2$ Hz, 1 H), 5.22 (s, 1 H), 5.41 (s, 1 H), 6.94-6.97 (m, 2 H), 7.28-7.32 (m, 2 H), 7.49-7.54 (m, 2 H), 7.63-7.67 (m, 1 H), 7.84-7.87 (m, 2 H); ^{13}C NMR ($CDCl_3$, 100 MHz, 60 °C) δ 23.6 (t), 28.6 (q), 32.0 (t), 42.7 (t), 46.5 (t), 55.5 (d), 72.1 (d), 79.8 (s), 113.3 (t), 122.1 (d), 128.2 (d), 128.5 (d), 129.1 (d), 134.1 (d), 136.1 (s), 139.5 (s), 149.1 (s), 150.9 (s) 155.4 (s); exact mass (electrospray) m/z calcd for $C_{25}H_{31}NNaO_6S$ 496.1764, found 496.1763.

(2*S*)-2-[2-Oxo-3-[[4-(phenylsulfonyl)oxy]phenyl]-3-buten-1-yl]-1-pyrrolidine-carboxylic acid 1,1-dimethylethyl ester (**95.6**).

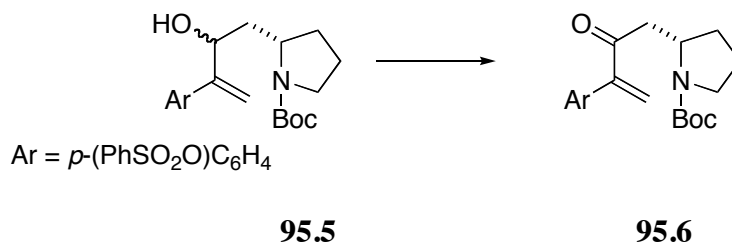

Use of the less polar diastereoisomer of **95.5**:

Dess-Martin periodinane (0.65 g, 0.63 mmol) was added in one portion to a stirred solution of **95.5** (0.099 g, 0.21 mmol) in dry CH₂Cl₂ (2 mL) and stirring was continued for 4 h. The reaction was quenched with saturated aqueous NaHCO₃, and then with saturated aqueous Na₂S₂O₃, and the mixture was stirred until transparent (ca 30 min). The mixture was partitioned between CHCl₃ and water and the combined organic extracts were washed with brine, dried (MgSO₄), and evaporated. Flash chromatography of the residue over silica gel (1.7 x 15 cm), using first 18% EtOAc-hexanes, and then 30 mL portions of 20%, 22%...26% EtOAc-hexanes, gave **95.6** (0.089 g, 91%): [α]²⁵_D -10.54 (*c* = 0.48, CHCl₃); FTIR (CHCl₃ cast) 2975, 1687 cm⁻¹; ¹H NMR (CDCl₃, 400 MHz, 60 °C) δ 1.46 (s, 9 H), 1.67-1.74 (m, 1 H), 1.79-1.87 (m, 2 H), 2.02-2.12 (m, 1 H), 2.66 (dd, *J* = 15.6, 9.4 Hz, 1 H), 3.30-3.41 (m, 3 H), 4.20-4.25 (m, 1 H), 5.97 (s, 1 H), 6.26 (br s, 1 H), 6.98-7.00 (m, 2 H), 7.24-7.27 (m, 2 H), 7.50-7.55 (m, 2 H), 7.63-7.68 (m, 1 H), 7.86-7.89 (m, 2 H); ¹³C NMR (CDCl₃, 100 MHz, 60 °C) δ 23.4 (t), 28.6 (q), 31.1 (t), 44.1 (t), 46.5 (t), 54.5 (d), 79.5 (s), 122.0 (d), 128.5 (d), 129.2

(d), 129.9 (d), 134.2 (d), 136.1 (s), 148.2 (s), 149.6 (s) 154.4 (s), 199.6 (s), one signal missing; exact mass (electrospray) m/z calcd for $C_{25}H_{29}NNaO_6S$ 494.1608, found 494.1599.

Use of the more polar diastereoisomer of **95.5**:

Dess-Martin periodinane (0.214 g, 0.50 mmol) was added in one portion to a stirred solution of **95.5** (more polar diastereoisomer, 0.080 g, 0.17 mmol) in dry CH_2Cl_2 (2 mL) and stirring was continued for 4 h. The reaction was quenched with saturated aqueous $NaHCO_3$, followed by saturated aqueous $Na_2S_2O_3$ and the mixture was stirred until transparent (ca 30 min). The mixture was then partitioned between $CHCl_3$ and water and the combined organic extracts were washed with brine, dried ($MgSO_4$), and evaporated. Flash chromatography of the residue over silica gel (1.7 x 15 cm), using first 18% EtOAc-hexanes, and then 30 mL portions of 20%, 22%, 24%, 26% EtOAc-hexanes, gave **95.6** (0.055 g, 69%).

(8a*S*)-Hexahydro-6-[[4-(phenylsulfonyl)oxy]phenyl]-7(1*H*)-indolizino-
one (95.7).

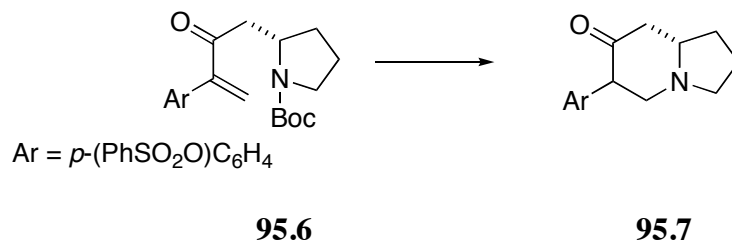

CF₃CO₂H (0.7 mL, 9.00 mmol) was added by syringe to a stirred and cooled (0 °C) solution of **95.6** (0.714 g, 1.52 mmol) in dry CH₂Cl₂ (2 mL). The cooling bath was removed and stirring was continued for 1 h. A further portion of CF₃CO₂H (0.7 mL) was added and stirring was continued for 1 h. The solution was evaporated under reduced pressure, and the residue was suspended in MeCN (12 mL). The mixture was basified (to pH = 14/until universal pH paper goes deep blue) with aqueous Na₂CO₃ (20%, 1 mL), stirred at 50 °C for 3 h and cooled to room temperature. The mixture was partitioned between EtOAc and water and the combined organic extracts were washed with brine, dried (MgSO₄), and evaporated. Flash chromatography of the residue over silica gel (1.7 x 15 cm), using first 40% EtOAc-hexanes, and then 50 mL portions of 86% to 90% EtOAc-hexanes, gave **95.7** as a cream-colored solid (0.475 g, 84%) which was a single diastereoisomer. The compound must be used immediately for the next step: mp 126-130 °C; [α]_D²⁵ -1.78 (*c* = 1.63, CHCl₃); FTIR (CHCl₃ cast) 2962, 1715 cm⁻¹; ¹H NMR (CDCl₃, 500 MHz) δ 1.59-1.62 (m, 1 H), 1.84-1.88 (m, 1 H), 1.98-2.05 (m, 2 H), 2.28 (q, *J* = 9.0 Hz, 1 H), 2.43-2.47 (m, 2 H), 2.52 (t, *J* = 11.5 Hz, 1 H), 2.62-2.66 (m, 1 H), 3.18 (dd, *J* = 8.9, 1.7 Hz, 1 H), 3.44 (dd, *J* = 11.1, 6.2 Hz, 1 H), 3.84 (dd, *J* = 8.8, 6.1 Hz, 1 H), 6.93-6.96 (m, 2 H), 7.04-7.06 (m, 2 H), 7.51-7.54 (m, 2 H), 7.64-7.68 (m, 1 H), 7.84-7.86 (m, 2 H); ¹³C NMR (CDCl₃, 125 MHz) δ 22.5 (t), 31.4 (t), 47.0 (t), 52.8 (t), 55.4 (d), 57.9 (t), 64.9 (d), 122.2 (d), 128.5 (d), 129.1 (d), 129.7 (s), 130.5 (d), 134.2 (d), 135.5 (s), 148.6 (s), 207.0 (s); exact mass (electrospray) *m/z* calcd for C₂₀H₂₁NNaO₄S 394.1084, found 394.1087.

**(8a*S*)-7-Methyloctahydro-6-[[4-phenylsulfonyl]oxy]phenyl]-7-indoliz-
inol (96.1).**

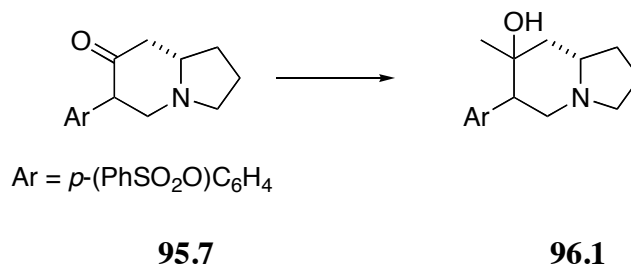

MeLi (0.79 mL, 1.26 mmol) was added by syringe to a stirred and cooled (-78 °C) solution of **95.7** (0.445 g, 1.20 mmol) in dry THF (5 mL). Stirring was continued for 15 min and the mixture was quenched with MeOH, and partitioned between EtOAc and water. The combined organic extracts were washed with brine, dried (MgSO₄), and evaporated. Flash chromatography of the residue over silica gel (1.7 x 15 cm), using first CH₂Cl₂, and then 30 mL portions of 2, 4...10% MeOH-CH₂Cl₂, gave **96.1** as a colorless semisolid (0.257 g, 52%), and recovered **95.7** (0.245 g) which was then recycled [the material was stirred for 3 h in a mixture of MeCN (5 mL) and aqueous Na₂CO₃ (20%, 3 mL), isolated and the recovered material (233 mg) was treated with MeLi, as above to give **96.1** (0.146 g, 60%)], making the overall yield of **96.1** 87% as a mixture of diastereoisomers which was used in the next step.

(8a*S*)-1,2,3,5,8,8a-Hexahydro-7-methyl-6-[[*p*-(4-phenylsulfonyl)oxy]-phenyl]indolizine (96.2).

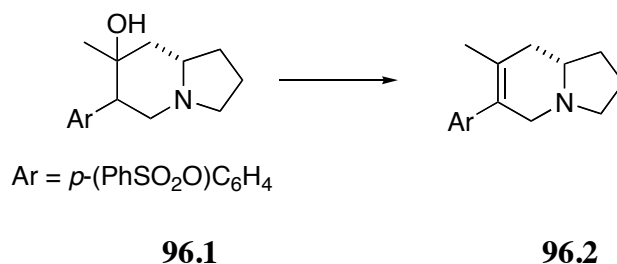

TsOH·H₂O (0.156 g, 0.84 mmol) was tipped into a solution of **96.1** (0.127 g, 0.33 mmol) in dry PhH (10 mL) and the solution refluxed overnight and then cooled to room temperature. The mixture was quenched with saturated aqueous NaHCO₃, and partitioned between EtOAc and water. The combined organic extracts were washed with brine, dried (MgSO₄), and evaporated. Flash chromatography of the residue over silica gel (1.2 x 15 cm), using first CH₂Cl₂, and then 30 mL portions of 2%, 4%...10% MeOH-CH₂Cl₂, gave **96.2**, as a colorless oil (0.072 g, 69%): $[\alpha]_D^{25} +54.44$ ($c = 0.44$, CHCl₃); FTIR (CHCl₃ cast) 2964 cm⁻¹; ¹H NMR (CDCl₃, 500 MHz) δ 1.48 (dddd, $J = 11.7, 11.7, 9.5, 6.5$ Hz, 1 H), 1.53 (s, 3 H), 1.76 (dddd, $J = 18.8, 8.9, 6.5, 2.3$ Hz, 1 H), 1.88 (dddd, $J = 12.7, 8.8, 4.1, 4.1$ Hz, 1 H), 2.02 (dddd, $J = 16.45, 10.3, 6.5, 4.1$ Hz, 1 H), 2.06-2.13 (m, 1 H), 2.18 (ddd, $J = 9.0, 9.0, 9.0$ Hz, 1 H), 2.22-2.28 (m, 2 H), 2.88-2.91 (m, 1 H), 3.20 (ddd, $J = 8.8, 8.8, 2.2$ Hz, 1 H), 3.55 (d, $J = 15.6$ Hz, 1 H), 6.90-6.92 (m, 2 H), 7.05-7.08 (m, 2 H), 7.49-7.53 (m, 2 H), 7.63-7.66 (m, 1 H), 7.81-8.84 (m, 2 H); ¹³C NMR (CDCl₃, 125 MHz) δ 20.0 (s), 21.4 (t), 30.8 (t), 38.4 (t),

54.2 (t), 57.5 (t), 60.2 (d), 122.1 (d), 128.5 (d), 129.2 (d), 129.3 (s), 129.7 (s), 130.1 (d), 134.3 (d), 135.6 (s), 140.5 (s), 148.1 (s); exact mass (electrospray) m/z calcd for $C_{21}H_{24}NO_3S$ 370.1471, found 370.1471.

4-[(8a*S*)-1,2,3,5,8,8a-Hexahydro-7-methyl-6-indolizinyl]phenol [(+)-ipalbidine] (3.1).

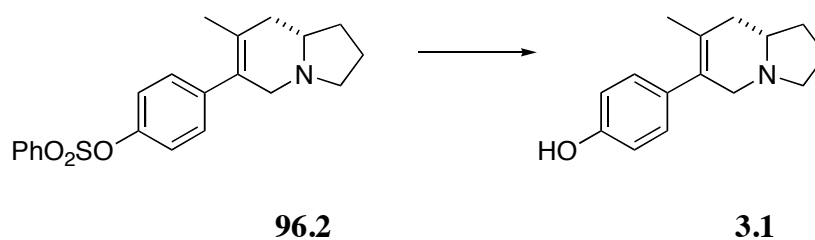

NaOH (10%, 0.93 mL, 2.32 mmol) was added to a solution of **96.2** (0.150 g, 0.058 mmol) in EtOH (2 mL) and the solution was refluxed for 1 h and then cooled to room temperature. The mixture was diluted with water and partitioned between EtOAc and water and the combined organic extracts were washed with brine, dried ($MgSO_4$), and evaporated. Flash chromatography of the residue over silica gel (1.2 x 15 cm), using first 100% EtOAc, and then 30 mL portions of 10%, 20%, 22%,...,30% MeOH-EtOAc, gave **3.1** (0.053 g, 57%) as an oil: $[\alpha]_D^{25} +108.94$ ($c = 0.75$, EtOH); FTIR ($CHCl_3$ cast) 3179, 2967 cm^{-1} ; 1H NMR ($CDCl_3$, 500 MHz) δ 1.50-1.60 (m, 4 H), 1.72-1.82 (m, 1 H), 1.88-1.98 (m, 1 H), 1.98-2.06 (m, 2 H), 2.11-2.27 (m, 3 H), 2.34 (bs, 1 H), 2.95 (d, $J = 12.5$ Hz, 1 H), 3.23 (app. t, $J = 9$ Hz, 1 H), 3.67 (d, $J = 15.8$ Hz, 1 H), 6.72-6.76 (m, 2 H), 6.95-6.96 (m, 2 H); ^{13}C NMR ($CDCl_3$, 125 MHz) δ 20.2 (q), 21.3 (t), 30.4 (t), 37.9 (t), 54.2 (t),

57.9 (t), 60.7 (d), 115.6 (d), 128.4 (s), 129.9 (d), 130.1 (s), 132.5 (s), 155.7 (s);
exact mass m/z calcd for $C_{15}H_{19}NO$ 229.1467, found 229.1463.

(Nitromethyl)benzene (83.2).⁹⁸

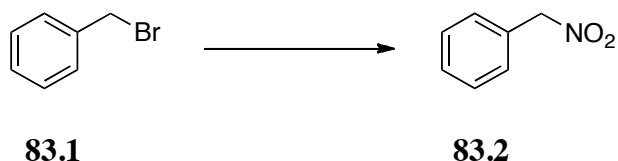

Benzyl bromide (**83.1**) (3.5 mL, 0.029 mol) was added to a stirred and cooled (0 °C) solution of urea (3.89 g, 0.065 mol) and NaNO₂ (3.49 g, 0.05 mol) in DMF (40 mL). Stirring was continued for 5 h, after which the mixture was diluted with water and extracted twice with Et₂O. The combined organic extracts were washed twice with water, once with brine, dried (MgSO₄) and evaporated. Flash chromatography of the residue over silica gel (3.0 x 20 cm) using 5% EtOAc-hexanes, gave **83.2** (0.617 g, 15%) as a yellow oil: FTIR (Neat film) 1554, 1375 cm⁻¹; ¹H NMR (CDCl₃, 400 MHz) δ 5.44 (s, 2 H), 7.40-7.50 (m, 5 H); ¹³C NMR (CDCl₃, 10 MHz) δ 80.0 (t), 129.1 (d), 129.8 (s), 130.0 (d), 130.0 (d).

(2*S*)-2-(2-Hydroxy-3-nitro-3-phenylpropyl)-1-pyrrolidinecarboxylic acid 1,1-dimethylethyl ester (97.1).

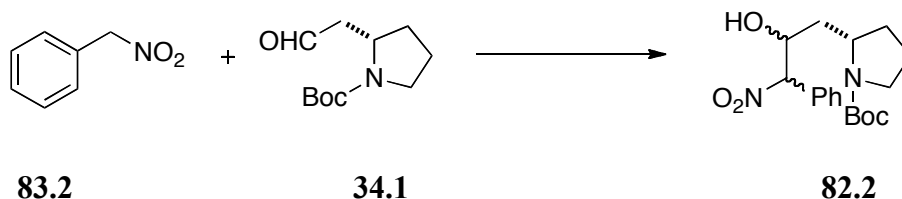

LiBr (0.013 g, 0.15 mmol), followed by Et_3N (0.14 mL, 1.02 mmol), was added to a stirred solution of **83.2** (0.133 g, 0.97 mmol) in THF (2.5 mL). A solution of **34.1** (0.103 g, 0.48 mmol) in THF (1 mL + 0.5 mL rinse) was added by syringe. The solution was stirred overnight at room temperature and quenched with hydrochloric acid (0.5 M). The crude mixture was extracted twice with EtOAc, and the combined organic extracts were washed with brine, dried (MgSO_4), and evaporated. Flash chromatography of the residue over silica gel (1.7 x 10 cm) using a gradient elution of 5%, 10%, 11%, 12%...20% EtOAc-hexanes, gave **82.2** (0.138 g, 82%) as an inseparable mixture of four diastereoisomers.

(2*S*)-1-[(1,1-Dimethylethoxy)carbonyl]- β -hydroxy- α -methylene-2-pyrrolidinebutanoic acid methyl ester (**94.1**).^{2b}

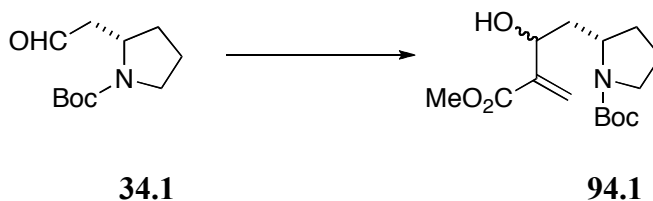

DABCO (0.779 g, 6.95 mmol) was added to a solution of **34.1** (0.494 g, 2.32 mmol) in methyl acrylate (0.85 mL, 9.26 mmol) and the mixture was stirred for 5 days. The remaining solvent was removed by evaporation. Flash chromatography of the residue over silica gel (1.7 x 15 cm), using a gradient elution of 16%, 17%...25% EtOAc-hexanes, gave a least polar diastereoisomer (0.213 g, 31%) and a more polar diastereoisomer (0.288 g, 42%).

Less polar diastereoisomer: $[\alpha]_D^{25} +8.16$ ($c = 0.38$, CHCl_3); FTIR (CHCl_3 cast) 3396, 1720, 1692, 1668 cm^{-1} ; ^1H NMR (CDCl_3 , 400 MHz) δ 1.32-1.42 (m, 10 H), 1.50-1.58 (m, 1 H), 1.60-1.95 (m, 4 H), 3.25-3.35 (m, 2 H), 3.70 (s, 3 H), 4.10-4.20 (bs, 1 H), 4.41-4.43 (m, 1 H), 5.20-5.60 (bs, 1 H), 5.99 (bs, 1 H), 6.21 (s, 1 H); ^{13}C NMR (CDCl_3 , 100 MHz) δ 23.4 (t), 28.4 (q), 31.2 (t), 42.9 (t), 46.3 (t), 51.6 (d), 53.8 (d), 66.4 (q), 80.0 (s), 124.2 (t), 142.7 (s), 156.5 (s), 166.7 (s); exact mass (electrospray) m/z calcd for $\text{C}_{15}\text{H}_{25}\text{NNaO}_5$ 322.1625, found 322.1626.

More polar diastereoisomer: $[\alpha]_D^{25} +42.37$ ($c = 0.21$, CHCl_3); FTIR (CHCl_3 cast) 3419, 1718, 1693, 1670 cm^{-1} ; ^1H NMR (CDCl_3 , 400 MHz) δ 1.46 (s, 9 H), 1.68-1.90 (m, 5 H), 1.94-2.60 (m, 1 H), 3.28-3.58 (m, 2 H), 3.76-3.78 (m, 3

H), 4.00-4.08 (m, 1 H), 4.48-4.54 (m, 1 H), 5.94 (bs, 1 H), 6.22 (s, 1 H); ^{13}C NMR (CDCl_3 , 100 MHz) δ 23.5 (t), 28.4 (q), 31.2 (t), 42.6 (t), 46.2 (t), 51.5 (d), 55.2 (d), 68.6 (q), 79.3 (s), 124.1 (t), 143.1 (s), 154.5 (s), 166.6 (s); exact mass (electrospray) m/z calcd for $\text{C}_{15}\text{H}_{25}\text{NNaO}_5$ 322.1625, found 322.1628.

(2S)-2-(2-Hydroxypropyl)-1-pyrrolidinecarboxylic acid 1,1-dimethylethyl ester (97.1).⁹⁹

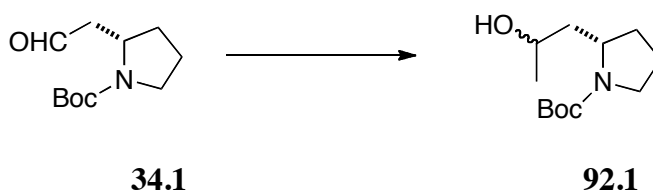

MeMgBr (3 M in Et_2O , 1.60 mL, 4.74 mmol) was added to a stirred and cooled ($0\text{ }^\circ\text{C}$) solution of **34.1** (0.506 g, 2.37 mmol) in Et_2O (20 mL). After 10 min at $0\text{ }^\circ\text{C}$, the cooling bath was removed and stirring was continued for 1 h. The mixture was quenched with MeOH , and water and hydrochloric acid (0.5 M, to dissolve any residues) were added. The mixture was extracted twice with Et_2O and the combined organic extracts were washed with brine, dried (MgSO_4) and evaporated. Flash chromatography of the residue over silica gel (1.7 x 20 cm), using 18%, 20%...30% EtOAc -hexanes, gave a least polar diastereoisomer of **92.1** (0.240 g, 44%), and a more polar diastereoisomer of **92.1** (0.222 g, 41%).

Less polar diastereoisomer: $[\alpha]_D^{25} -8.91$ ($c = 0.35$, CHCl_3); FTIR (CHCl_3 cast) $3439, 1694, 1673 \text{ cm}^{-1}$; $^1\text{H NMR}$ (CDCl_3 , 400 MHz) δ 1.08 (d, $J = 6.2$ Hz, 3 H), 1.20-1.44 (m, 11 H), 1.46-1.58 (m, 1 H), 1.76-1.96 (m, 3 H), 3.17-3.30 (m, 2 H), 3.58-3.68 (m, 1 H), 4.00-4.20 (m, 1 H), 4.50-5.00 (bs, 1 H); $^{13}\text{C NMR}$ (CDCl_3 , 100 MHz) δ 22.5 (q), 23.4 (t), 28.3 (q), 31.0 (t), 45.6 (t), 46.4 (t), 53.7 (d), 63.6 (d), 79.7 (s), 156.5 (s); exact mass (electrospray) m/z calcd for $\text{C}_{12}\text{H}_{23}\text{NNaO}_3$ 252.1570, found 252.1573.

More polar diastereoisomer: $[\alpha]_D^{25} -42.36$ ($c = 0.54$, CHCl_3); FTIR (CHCl_3 cast) $3425, 1694, 1673 \text{ cm}^{-1}$; $^1\text{H NMR}$ (CDCl_3 , 400 MHz) δ 1.14 (d, $J = 6.2$ Hz, 3 H), 1.40 (s, 10 H), 1.56-1.66 (m, 1 H), 1.70-2.10 (m, 4 H), 3.20-3.34 (m, 2 H), 3.35-3.60 (bs, 1 H), 3.75-3.84 (m, 1 H), 3.90-3.96 (m, 1 H); $^{13}\text{C NMR}$ (CDCl_3 , 100 MHz) δ 23.6 (t), 223.9 (q), 28.4 (q), 31.8 (t), 45.1 (t), 46.1 (t), 55.3 (d), 66.1 (d), 79.4 (s), 154.3 (s); exact mass (electrospray) m/z calcd for $\text{C}_{12}\text{H}_{23}\text{NNaO}_3$ 252.1570, found 252.1572.

(2*S*)-2-(2-Oxypropyl)-1-pyrrolidinecarboxylic acid 1,1-dimethylethyl ester (97.1).

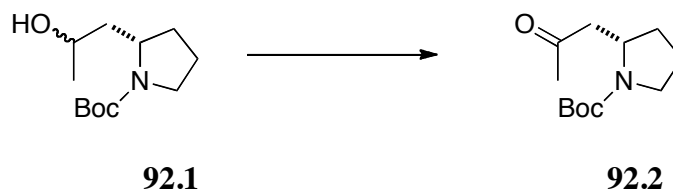

Use of the more polar diastereoisomer:

NaHCO₃ (0.814 g, 9.69 mmol), followed by Dess-Martin periodinane (1.232 g, 2.91 mmol), was added to a stirred solution of **92.1** (0.222 g, 9.69 mmol) in dry CH₂Cl₂ (15 mL) and stirring was continued for 5 h. The mixture was quenched slowly with water, followed by saturated aqueous NaHCO₃ and then with saturated aqueous Na₂S₂O₃. The resulting solution was stirred for 30 min (solution becomes clear) and the mixture was partitioned between CHCl₃ and water. The combined organic extracts were washed with brine, dried (MgSO₄), and evaporated. Flash chromatography of the residue over silica gel (1.7 x 15 cm), using a gradient elution of 16%, 18%...24% EtOAc-hexanes, gave **92.2** (0.162 g, 73%) as a clear oil: $[\alpha]_D^{25}$ -26.92 (*c* = 0.58, CHCl₃); FTIR (CHCl₃ cast) 1692 cm⁻¹; ¹H NMR (CDCl₃, 400 MHz) δ 1.35 (s, 9 H), 1.5-1.58 (m, 1 H), 1.68-1.76 (m, 2 H), 1.96 (dq, *J* = 11.5, 8.2 Hz, 1 H), 2.04 (s, 3 H), 2.30 (dd, *J* = 15.5, 9.6 Hz, 1 H), 2.78-3.04 (m, 1 H), 3.16-3.28 (bs, 1 H), 4.00-4.08 (bs, 1 H); exact mass (electrospray) *m/z* calcd for C₁₂H₂₁NNaO₃ 250.1414, found 250.1414.

Use of the less polar diastereoisomer:

NaHCO₃ (0.879 g, 0.11 mol), followed by Dess-Martin periodinane (1.331 g, 3.14 mmol), was added to a stirred solution of **92.1** (0.240 g, 1.05 mmol) in dry CH₂Cl₂ (12 mL) and stirring was continued for 5 h. The mixture was quenched slowly with water, followed by saturated aqueous NaHCO₃ and then with saturated aqueous Na₂S₂O₃. The resulting solution was stirred for 30 min (solution becomes clear) and the mixture was partitioned between CHCl₃ and water. The combined organic extracts were washed with brine, dried (MgSO₄),

and evaporated. Flash chromatography of the residue over silica gel (1.7 x 15 cm), using a gradient elution with 16%, 18%...24% EtOAc-hexanes, gave **92.2** (0.161 g, 68%) as a clear oil.

4. References

- 1 Kuramoto, M.; Tong, C.; Yamada, K.; Chiba, T.; Hayashi, Y.; Uemura, D. *Tetrahedron Lett.* **1996**, *37*, 3867-3870. (b) Arimoto, H.; Hayakawa, I.; Kuramoto, M.; Uemura, D. *Tetrahedron Lett.* **1998**, *39*, 861-862.
- 2 (a) Clive, D. L. J.; Yu, M.; Li, Z. *Chem. Commun.* **2005**, 906-908. (b) Clive, D. L. J.; Li, Z.; Yu, M. *J. Org. Chem.* **2007**, *72*, 5608-5617. (c) Liu, D.; Acharya, H. P.; Yu, M.; Wang, J.; Yeh, V. S. C.; Kang, S.; Chiruta, C.; Jachak, S. M.; Clive, D. L. J. *J. Org. Chem.* **2009**, *74*, 7417-7428.
- 3 Springer, T. A. *Cell* **1994**, *76*, 301-314. (b) Carlos, T. M.; Harlan, J. M. *Blood* **1994**, *84*, 2068-2101.
- 4 Foster, C. A. *J. Allergy Clin. Immunol.* **1996**, S270-S277.
- 5 Michael, J. P. *Nat. Prod. Rep.* **2007**, *25*, 191-222.
- 6 Clive, D. L. J.; Li, Z.; Yu, M. *J. Org. Chem.* **2007**, *72*, 5608-5617.
- 7 Gourley, J. M.; Heacock, R. A.; McInnes, A. G.; Nikolin, B.; Smith, D. G. *J. Chem. Soc., Chem. Commun.* **1969**, 709-710.
- 8 Zhou, J.; Zhao, G.; Jin, W.; Zheng, W.; Chi, Z. *Chin. Acad. Sci., Shanghai* **1988**, *9*, 107-111.
- 9 Chen, X.; Chu, Y. *Zhongguo Yaolixue Tongbao* **1998**, *14*, 243-244.
- 10 Govindachari, T. R.; Sidhaye, A. R.; Viswanathan, N. *Tetrahedron* **1970**, *26*, 3829-3831.
- 11 Adams, R.; Miyano, S.; Nair, M. D. *J. Am. Chem. Soc.* **1961**, *83*, 3323-3327.

- 12 Wick, A. E.; Bartlett, P. A.; Dolphin, D. *Helv. Chem. Acta.* **1971**, *54*, 513-522.
- 13 Peterson, S.; Tietze, E. *Chem. Ber.* **1957**, *90*, 909-921.
- 14 Stevens, R. V.; Luh, Y.; Sheu, J. T. *Tetrahedron Lett.* **1976**, *17*, 3799-3802.
- 15 Stevens, R. V.; Luh, Y. *Tetrahedron Lett.* **1977**, *18*, 979-982.
- 16 (a) Herbert, R. B.; Hedges, S. U. *J. Chem. Res. (S)* **1979**, 1. (b) Cragg, J. E.; Hedges, S. H.; Herbert, R. B. *Tetrahedron Lett.* **1981**, *22*, 2127-2130.
- 17 Howard, A. S.; Gerrans, G. C.; Michael, J. P. *J. Org. Chem.* **1980**, *45*, 1713-1715.
- 18 Roth, M.; Dubs, P.; Götschi, E.; Eschenmoser, A. *Helv. Chim. Acta* **1971**, *54*, 710-734.
- 19 Greenhill, J. V. *Chem. Soc. Rev.* **1977**, *6*, 277-294.
- 20 (a) Iida, H.; Watanabe, Y.; Kibayashi, C. *Chem. Lett.* **1983**, 1195-1196.
(b) Iida, H.; Watanabe, Y.; Kibayashi, C. *J. Chem. Soc., Perkin Trans. 1* **1985**, 261-266.
- 21 (a) Houk, K. N.; Sims, J.; Duke, Jr., R. E.; Storozier, R. W.; George, J. K. *J. Am. Chem. Soc.* **1973**, *95*, 7287-7301. (b) Houk, K. N.; Sims, J.; Watts, C. R.; Luskus, L. J. *J. Am. Chem. Soc.* **1973**, *95*, 7301-7315.
- 22 (a) Gree, R.; Tonnard, F.; Carrie, R. *Tetrahedron Lett.* **1973**, *14*, 453-456.
(b) Tufariello, J. J.; Ali, S. A. *Tetrahedron Lett.* **1978**, *19*, 4647-4650.
- 23 Danishefsky, S. J.; Vogel, C. *J. Org. Chem.* **1986**, *51*, 3916-3918.

- 24 Jefford, C. W.; Kubota, T.; Zaslona, A. *Helv. Chim. Acta.* **1986**, *69*, 2048-2061.
- 25 (a) Sheehan, S. M.; Padwa, A. *J. Org. Chem.* **1997**, *62*, 438-439. (b) Padwa, A.; Sheehan, S. M.; Straub, C. S. *J. Org. Chem.* **1999**, *64*, 8648-8659.
- 26 Regitz, M.; Maas, G. *Diazo Compounds: Properties and Synthesis*; Academic Press: Orlando, FL, 1986; p 185.
- 27 Ikeda, M.; Shikaura, J.; Mackawa, N.; Daibuzono, K.; Teranishi, H.; Teraoka, Y.; Oda, N.; Ishibashi, H. *Heterocycles* **1999**, *50*, 31-34.
- 28 Ishibashi, H.; Kameoka, C.; Iriyama, H.; Kodoma, K.; Sato, T.; Ikeda, M. *J. Org. Chem.* **1995**, *60*, 1276-1284. (b) Ishibashi, H.; Kawanami, H.; Ikeda, M. *J. Chem. Soc., Perkin Trans 1* **1997**, 817-822.
- 29 Liu, Z.; Lu, R.; Chen, Q.; Hong, H. *Huaxue Xuebao* **1985**, *43*, 992-995.
- 30 (a) Honda, T.; Namiki, H.; Nagase, H.; Mizutani, H. *Arkivoc* **2003**, 188-198. (b) Honda, T.; Namiki, H.; Nagase, H.; Mizutani, H. *Tetrahedron Lett.* **2003**, *44*, 3035-3038.
- 31 Otsuka, M.; Masuda, T.; Haupt, A.; Ohno, M.; Shiraki, T.; Sugiura, T.; Maeda, K. *J. Am. Chem. Soc.* **1990**, *112*, 838-845.
- 32 Schwab, P.; Grubbs, R. H.; Ziller, J. W. *J. Am. Chem. Soc.* **1996**, *118*, 100-110.
- 33 Kingsbury, J. S.; Harrity, J. P. A.; Bonitatebus, Jr., P. J.; Hoveyda, A. H. *J. Am. Chem. Soc.* **1999**, *121*, 791-799.

- 34 Schrock, R. R.; Murdzek, J. S.; Bazan, G. C.; Robbins, J.; DiMare, M.; O'Regan, M. *J. Am. Chem. Soc.* **1990**, *112*, 3875-3886.
- 35 McMurray, J. E. *Chem. Rev.* **1989**, *89*, 1513-1524. (b) Lenoir, D. *Synthesis* **1989**, 883-897.
- 36 Niphakis, M. J.; Georg, G. I. *J. Org. Chem.* **2010**, *75*, 6019-6022.
- 37 Niphakis, M. J.; Turunen, B. J.; Georg, G. I. *J. Org. Chem.* **2010**, *75*, 6793-6805.
- 38 Ge, H.; Niphakis, M. J.; Georg, G. I. *J. Am. Chem. Soc.* **2008**, *130*, 3708-3709.
- 39 (a) Kranke, B.; Kunz, H. *Org. Biomol. Chem.* **2007**, *5*, 349-354. (b) Kranke, B.; Kunz, H. *Can. J. Chem.* **2006**, *84*, 625-641. (c) Comins, D. L.; Joseph, S. P.; Chen, X. *Tetrahedron Lett.* **1995**, *36*, 9141-9144. (d) Wang, X.; Turunen, B. J.; Leighty, M. W.; Georg, G. I. *Tetrahedron Lett.* **2007**, *48*, 8811-8814.
- 40 Bordwell, F. G.; Schexnayder, D. A. *J. Org. Chem.* **1968**, *33*, 3249-3246.
- 41 (a) Knochel, P.; Seebach, D. *Nouv. J. Chim.* **1981**, *5*, 75-77. (b) Knochel, P.; Seebach, D. *Tetrahedron Lett.* **1981**, *22*, 3223-3226. (c) Seebach, D.; Knochel, P. *Helv. Chim. Acta* **1984**, *67*, 261-283. (d) Seebach, D.; Calderari, G.; Knochel, P. *Tetrahedron* **1985**, *41*, 4861-4872.
- 42 (a) Bauchat, P.; Le Bras, N.; Rigal, L.; Foucaud, A. *Tetrahedron* **1994**, *50*, 7815-7826. (b) Bauchat, P.; Foucaud, A. *Tetrahedron Lett.* **1989**, *30*, 6337-6338.
- 43 Mitra, S.; Lawton, R. G. *J. Am. Chem. Soc.* **1979**, *101*, 3097-3110.

- 44 Wang, L.; Prabhudas, B.; Clive, D. L. J. *J. Am. Chem. Soc.* **2009**, *131*, 6003-6012.
- 45 Pettit, G. R.; Singh, S. B.; Herald, D. L.; Lloyd-Williams, P.; Kantoci, D.; Burkett, D. D.; Barkoczy, J.; Hogan, F.; Wardlaw, T. R. *J. Org. Chem.* **1994**, *59*, 6287-6295.
- 46 Ansell, M. F.; Caton, M. P. L.; Stuttle, K. A. J. *J. Chem. Soc., Perkin Trans, 1* **1984**, 1069-1077.
- 47 Crouch, R. D.; Mehlmann, J. F.; Herb, B. R.; Mitten, J. V.; Dai, G. H. *Synthesis* **1999**, 559-561.
- 48 Toujas, J-L.; Jost, E; Vaultier, M. *Bull. Soc. Chim. Fr.* **1997**, *134*, 713-717.
- 49 Reported values: (a) Yoda, H.; Katoh, H.; Ujihara, Y.; Takabe, K. *Tetrahedron Lett.* **2001**, *42*, 2509-2512: $[\alpha]^{23.5}_{\text{D}} -4.02$ (*c* 2.12, EtOH). (b) Costa, A.; Najera, C.; Sansano, J. M. *Tetrahedron: Asymmetry* **2001**, *12*, 2205-2211: $[\alpha]^{25}_{\text{D}} -10.1$ (*c* 1.88, EtOH). (c) Andrés, J. M.; Herráiz-Sierra, I.; Pedrose, R.; Pérez-Encabo, A. *Eur. J. Org. Chem.* **2000**, 1719-1726: $[\alpha]^{23}_{\text{D}} -10.1$ (*c* 1.8, EtOH). (d) Sibi, M. P.; Christensen, J. W. *Tetrahedron Lett.* **1990**, *31*, 5689-5692: $[\alpha]^{27}_{\text{D}} -10.8$ (*c* 1.76, EtOH). (e) Sibi, M. P.; Christensen, J. W. *J. Org. Chem.* **1999**, *64*, 6434-6442: $[\alpha]^{26}_{\text{D}} -10.8$ (*c* 1.76, EtOH). (f) Waldmann, H.; Braun, M. J. *J. Org. Chem.* **1992**, *57*, 4444-4451: $[\alpha]^{23}_{\text{D}} -7.9$ (*c* 0.15, EtOH). (g) Waldmann, H.; Braun, M.; Dräger, M. *Angew. Chem. Int. Ed.* **1990**, *29*, 1468-1471: $[\alpha]^{22}_{\text{D}} -7.9$ (*c* 0.15, EtOH). (h) Ringdahl, B.; Pinder, A. R.; Pareira, W.

- E., Jr.; Oppenheimer, N. J.; Craig, J. C. *J. Chem. Soc., Perkin Trans. I* **1984**, 1-4: $[\alpha]_{\text{D}}^{23} -10.2$ (*c* 1.76, EtOH). (i) Arisawa, M.; Takezawa, E.; Nishida, A.; Mori, M.; Nakagawa, M. *Synlett* **1997**, 1179-1180: $[\alpha]_{\text{D}}^{25} -20.5$ (0.98, EtOH). (j) Arisawa, M.; Takahashi, M.; Takezawa, E.; Nishida, A.; Yamaguchi, T.; Torisawa, Y.; Nishida, A.; Nakagawa, M. *Chem. Pharm. Bull.* **2000**, 48, 1593-1596: $[\alpha]_{\text{D}}^{25} -20.5$ (*c* 0.98, EtOH).
- 50 Reich, H. J.; Shah, S. S.; Chow, F. *J. Am. Chem. Soc.* **1979**, 101, 6648-6656.
- 51 Nishino, T.; Nishiyama, Y.; Sonoda, N. *Chem. Lett.* **2003**, 32, 918-919.
- 52 Clive, D. L. J.; Menchen, S. M. *J. Org. Chem.* **1979**, 44, 4279-4285.
- 53 Schmidt, M.; Block, H. D. *J. Organometal. Chem.* **1970**, 25, 17-21.
- 54 Curtin, D. Y.; Harris, E. E. *J. Am. Chem. Soc.* **1951**, 73, 4519-4521.
- 55 Weiler, M. *Ber. Dtsch. Chem. Ges.* **1900**, 33, 464-471.
- 56 (a) Glaser, C. *Liebigs Ann. Chem.* **1870**, 154, 137-171. (b) Ashworth, F.; Burkhardt, G. N. *J. Chem. Soc.* **1928**, 1791-1802. (c) Lubell, W. D.; Rapoport, H. *J. Am. Chem. Soc.* **1988**, 110, 7447-7455.
- 57 Clive, D. L. J.; Coltart, D. M.; Zhou, Y. *J. Org. Chem.* **1999**, 64, 1447-1454.
- 58 Negishi, E.; King, A. O.; Okukado, N. *J. Org. Chem.* **1977**, 42, 1821-1823.
- 59 Singh, J.; Satyamurthi, N.; Aidhen, I. S. *J. Prakt. Chem.* **2000**, 342, 340-347.

- 60 Zhao, S.; Freeman, J. P.; Bacon, C. L.; Fox, G. B.; O'Driscoll, E.; Foley, A. G.; Kelly, J.; Farrell, U.; Regan, C.; Mizsak, S. A.; Szmuszkovicz, J. *Bioorg. Med. Chem.* **1999**, *7*, 1647-1654.
- 61 Stork, G.; Zhao, K. *Tetrahedron Lett.* **1989**, *30*, 287-290.
- 62 (a) Gröbel, B.-T.; Seebach, D. *Synthesis* **1977**, 357-402. (b) Chen, S.-H.; Horvath, R. F.; Joglar, J.; Fisher, M. J.; Danishefsky, S. J. *J. Org. Chem.* **1991**, *56*, 5834-5845.
- 63 Stork, G.; Ganem, B. *J. Am. Chem. Soc.* **1972**, *95*, 6152-6153.
- 64 Kwart, H.; King, K. G. *d-Orbitals in the Chemistry of Silicon, Phosphorus and Sulfur*, Springer, Berlin, 1977.
- 65 (a) Epiotis, N. D.; Yates, R. L.; Bernardi, F.; Wolfe, S. *J. Am. Chem. Soc.* **1976**, *98*, 5435-5439. (b) Lehn, J.-M.; Wipff, P. *J. Am. Chem. Soc.* **1976**, *98*, 7498-7505.
- 66 Von Dumont, W.; Krief, A. *Angew. Chem.* **1976**, *88*, 184-185.
- 67 Reich, H.J.; Shah, S. K. *J. Org. Chem.* **1977**, *42*, 1773-1776.
- 68 (a) Fabre, J-L.; Julia, M.; Verpeaux, J-N. *Tetrahedron Lett.* **1982**, *23*, 2469-2572. (b) Alvarez, E.; Cuvigny, T.; Hervé du Penhoat, C.; Julia, M. *Tetrahedron* **1988**, *44*, 111-118. (c) Alvarez, E.; Cuvigny, T.; Hervé du Penhoat, C.; Julia, M. *Tetrahedron* **1988**, *44*, 119-126.
- 69 (a) Chinkov, N.; Majumdar, S.; Marek, I. *J. Am. Chem. Soc.* **2003**, *125*, 13258-13264. (b) Farhat, S.; Zouev, I.; Marek, I. *Tetrahedron* **2004**, *64*, 1329-1337.

- 70 (a) Watanabe, Y.; Ueno, Y.; Araki, T.; Endo, T.; Okawara, M. *Tetrahedron Lett.* **1986**, *27*, 215-218. (b) Bew, S. P.; Sweeney, J. B.; *Synthesis* **1994**, 698-698. (c) McCarthy, J. R.; Huber, E. W.; Le, T-B.; Lakovics, M.; Matthews, D. P. *Tetrahedron* **1996**, *52*, 45-48. (d) Berkowitz, D. B.; de la Salud-Bea, R.; Jahng, W-J. *Org. Lett.* **2004**, *6*, 1821-1824.
- 71 (a) Karstens, W. F. J.; Stol, M.; Rutjes, F. P. J. T.; Hiemstra, H. *Synlett* **1998**, 1126-1128. (b) Karstens, W. F. J.; Moolenaar, M. J.; Rutjes, F. P. J. T.; Grabowska, U.; Speckamp, W. N.; Hiemstra, H. *Tetrahedron Lett.* **1999**, *40*, 8629-8632. (c) Karstens, W. F. J.; Stol, M.; Rutjes, F. P. J. T.; Kooijman, H.; Spek, A. L.; Hiemstra, H. *J. Organomet. Chem.* **2001**, *624*, 244-258.
- 72 Dexter, C. S.; Jackson, R. F. W. *J. Chem. Soc., Chem. Commun.* **1998**, 75-76.
- 73 Hjelmgaard, T.; Tanner, D. *Org. Biomol. Chem.* **2006**, *4*, 1796-1805.
- 74 Myrbo, B.; Ila, H.; Junjappa, H. *Synthesis* **1981**, 126-127.
- 75 Zhu, W.; Ma, D. *Org. Lett.* **2006**, *8*, 261-263.
- 76 Schuda, P. F.; Ebner, C. B.; Potlock, S. J. *Synthesis* **1987**, 1055-1057.
- 77 Barluenga, J.; Moriel, P.; Valdés, C.; Aznar, F. *Angew. Chem. Int. Ed.* **2007**, *46*, 5587-5590.
- 78 Trippett, S.; Walker, D. M. *J. Chem. Soc.* **1961**, 1266-1272.
- 79 Kamiya, N.; Chikami, Y.; Ishii, Y. *Synlett* **1990**, 675.
- 80 Sharma, S.; Oehlschlager, C. *J. Org. Chem.* **1989**, *54*, 5064-5073.

- 81 Hara, S.; Dojo, H.; Takinami, S.; Suzuki, A. *Tetrahedron Lett.* **1983**, *24*, 731-734.
- 82 Rosiak, A.; Frey, W.; Christoffers, J. *Eur. J. Org. Chem.* **2006**, 4044-4054.
- 83 Spaggiari, A.; Vacarri, V.; Davoli, P.; Torre, G.; Prati, F. *J. Org. Chem.* **2007**, *72*, 2216-2219.
- 84 Fürstner, A.; Kennedy, J. W. *J. Chem. Eur. J.* **2006**, *12*, 7398-7410.
- 85 Alker, D.; Doyle, K. J.; Harwood, L. M.; McGregor, A.; *Tetrahedron: Asymmetry* **1990**, *1*, 877-880.
- 86 Baldwin, J. E.; Spivey, A. C.; Schofield, C. J. *Tetrahedron: Asymmetry* **1990**, *1*, 881-884.
- 87 McMurry, J. E.; Melton, J. *J. Org. Chem.* **1973**, *38*, 4367-4373.
- 88 Heurtaux, B.; Lion, C.; Gall, T. L.; Mioskowski, C. *J. Org. Chem.* **2005**, *70*, 1474-1477.
- 89 Wada, M.; Takeichi, E.; Matsumoto, T. *Bull. Chem. Soc. Jpn.* **1991**, *64*, 990-994.
- 90 Abbott, B. M.; Ferrari, F. D.; Harnor, S. J.; Barnes, J. C.; Marques, R. *Tetrahedron* **2008**, *64*, 5072-5078.
- 91 Harada, T.; Mukaiyama, T. *Chem. Lett.* **1982**, 161-164.
- 92 Sparling, B. A.; Moslin, R. M.; Jamison, T. F. *Org. Lett.* **2008**, *10*, 1291-1294.
- 93 Shimada, T.; Yoshioka, M.; Konno, T.; Ishihara, T. *Org. Lett.* **2006**, *8*, 1129-1131.

- 94 Munday, R. H.; Matinelli, J. R.; Buchwald, S. L. *J. Am. Chem. Soc.* **2008**, *130*, 2754-2755.
- 95 (a) Grieco, P. A.; Gilman, S.; Nishizawa, M. *J. Org. Chem.* **1976**, *41*, 1485-1486. (b) Sharpless, K. B.; Young, M. Y. *J. Org. Chem.* **1975**, *40*, 947-949.
- 96 Parikh, J. R.; Doering, W. v. E. *J. Am. Chem. Soc.* **1967**, *89*, 5505-5507.
- 97 Preparation of phosphomolybdic acid stain: phosphomolybdic acid (15 g) and $\text{Ce}(\text{SO}_4)_2$ (2.5 g) were added to a mixture of water-sulfuric acid (485 mL-15 mL) and the mixture was stirred for 1 h. Preparation of potassium permanganate stain: KMnO_4 (3 g) and K_2CO_3 (20 g) were added to a solution of water (300 mL) and NaOH (5 %, 5 mL) and the mixture was stirred for 2 h.
- 98 Kornblum, N.; Larson, H. O.; Blackwood, R. K.; Mooberry, D. D.; Oliveto, E. P.; Graham, G. E. *J. Am. Chem. Soc.* **1956**, *78*, 1497-1501.
- 99 Davies, S. G.; Fletcher, A. M.; Roberts, P. M.; Smith, A. D. *Tetrahedron* **2009**, *65*, 10192-10213.

Chapter 2

Intramolecular conjugate displacement and its use in the asymmetric synthesis of carbocycles

1. Introduction

1.1 General

The generation of carbocycles has been an important pursuit in organic synthesis, as such structures appear in innumerable natural products and pharmaceutical compounds. The size and complexity of carbocycles can range from the simplest of structures to the most complex maze of atoms, and they can be found in a wide range of compounds, from perfumes to the drugs used everyday on the front lines of medicine (Scheme 1).

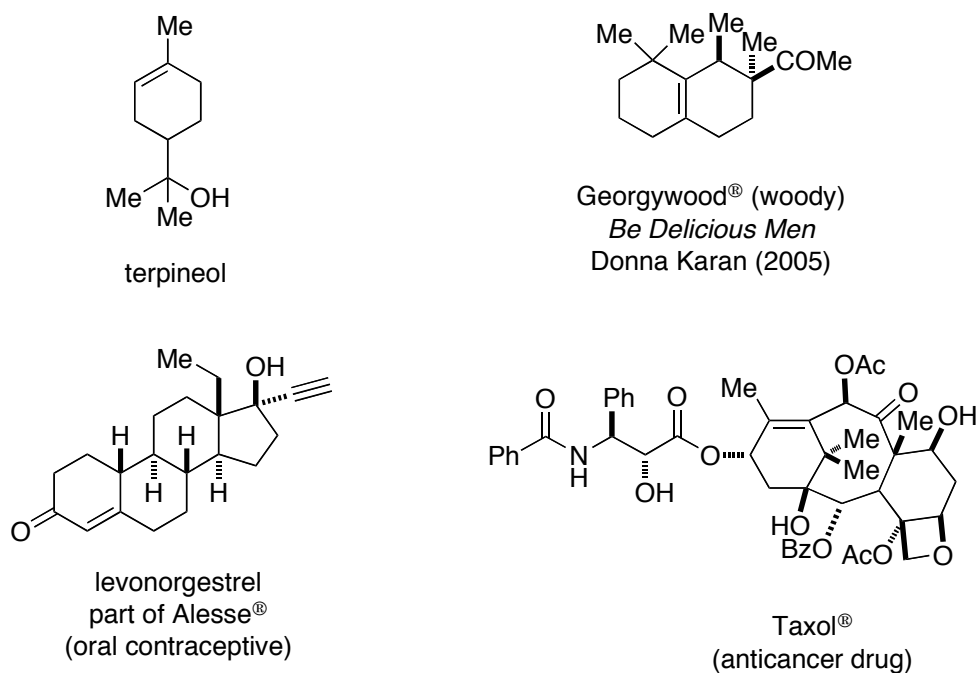

Scheme 1 *Carbocycles in nature and medicine*

The synthesis of compounds such as these has contributed a very large number of important methods for the construction of carbon-carbon bonds as well

as for carbocyclic ring formation, and so has provided modern chemists with the tools to attack new problems at the frontiers of organic chemistry. A brief overview of some of the most important of these methods will be highlighted in the following sections to provide a historical context to this synthetic problem, with the appreciation that a few pages cannot do justice to the subject.

1.2 Carbocycle ring formation

1.2.1 The aldol condensation

The aldol condensation¹ has been used for more than a century to form carbon-carbon bonds from the **enol** or **enolate** of an aldehyde or a ketone to the electrophilic carbonyl of another **aldehyde** or **ketone**. The reaction can be

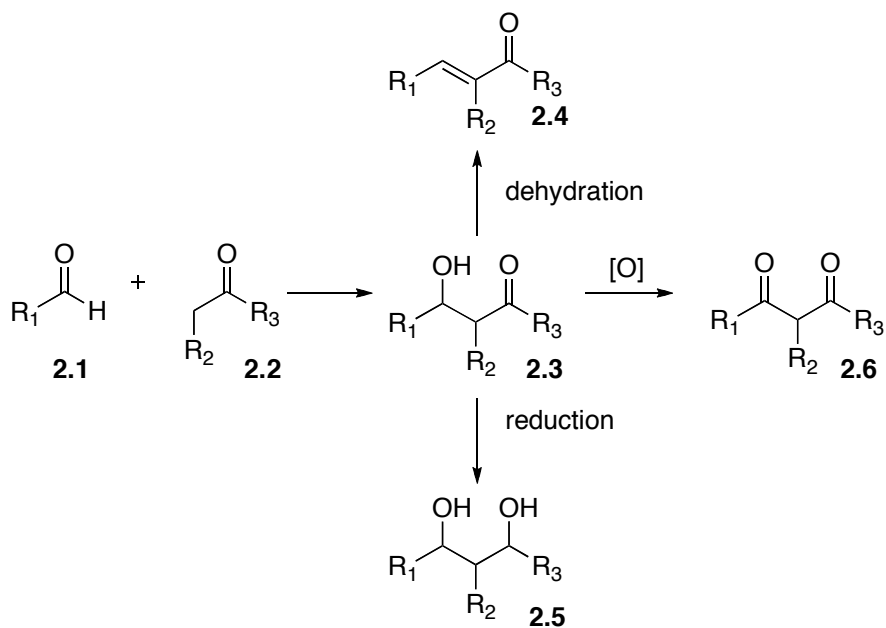

Scheme 2 *Derivatization of the aldol product*

stopped after the formation of an alcohol, or can be allowed to continue to the aldol condensation product (**2.4**), following elimination of the newly formed hydroxyl. The aldol product can also be oxidized or reduced to produce the corresponding dione (**2.6**) or diol (**2.5**), respectively.

Several variants of this reaction have been introduced. Heathcock² made many pioneering discoveries in the field of Li-enolates and their use in the aldol reaction, and Mukaiyama³ developed the use of silyl enol ethers and Lewis acids as alternatives to enolates (Scheme 3). Masamune developed boron enolates, whose introduction ushered in a new approach to stereoselective aldol reactions.⁴

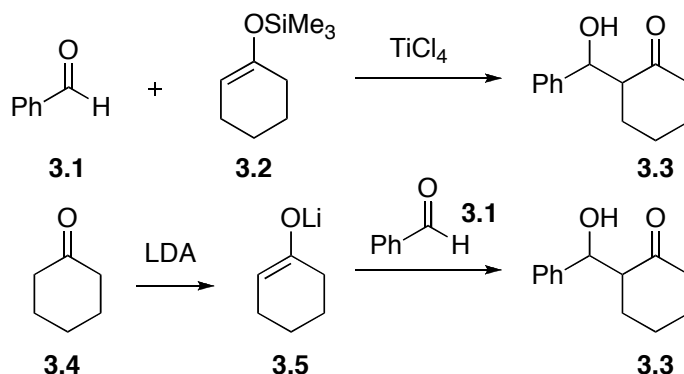

Scheme 3 *The Mukaiyama aldol and Li-enolate formation*

Many asymmetric, catalyst-controlled variants of the aldol reaction have been generated; these deal with the fact that the reaction can form two new stereocenters. One of the variants includes the use of chiral Lewis acids for the Mukaiyama aldol reaction⁵ (Scheme 4), while other asymmetric variants utilize chiral metal complex mediated catalysis, following Li-enolate formation. These

chiral Lewis acids have inspired an entire field of research, allowing synthetic chemists to carry out the aldol reaction in many different ways.

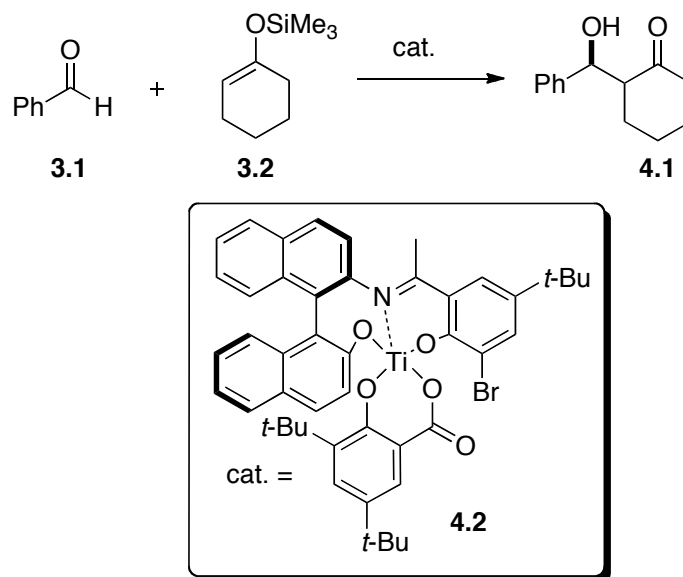

Scheme 4 *The asymmetric Mukaiyama aldol reaction*

Another variant of the aldol reaction includes the use of chiral auxiliaries in cases of reagent control, most famously introduced by Evans.⁶ By converting optically pure oxazolidinones into their boron enolates, facial selectivity can be imparted on the outcome of the reaction (Scheme 5).

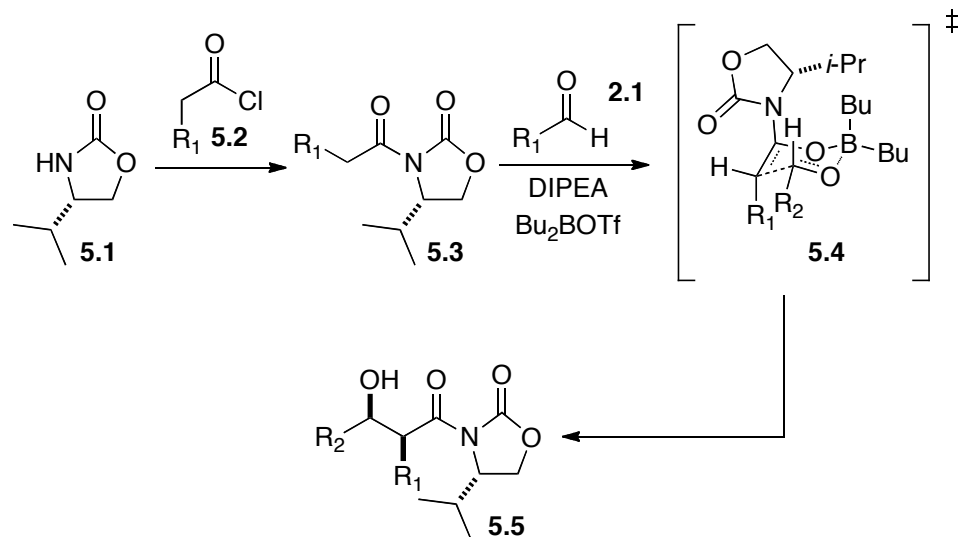

Scheme 5 *The Evans asymmetric aldol reaction*

Finally, within the context of total and carbocycle synthesis, the aldol reaction has been indispensable in its ability to generate complex ring systems. One such example highlighted here is Corey's use of the aldol cyclization during the total synthesis of dammarenediol II,⁷ where he installed the final ring of the compound using an aldol cyclization (Scheme 6).

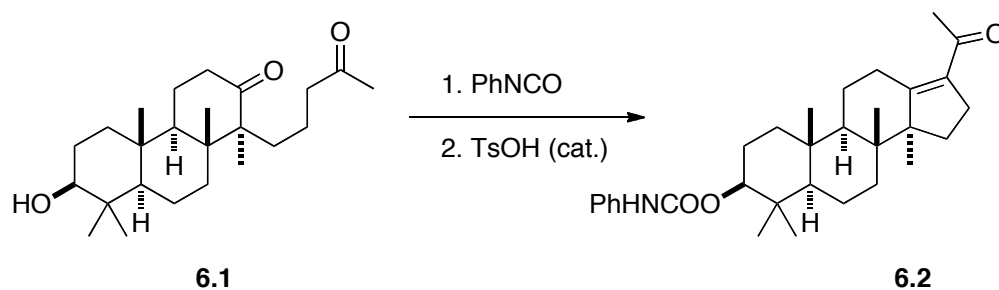

Scheme 6 *Aldol reaction in the total synthesis of dammarenediol II*

1.2.2 The Michael reaction

The Michael reaction was initially discovered as the nucleophilic addition of the anion of diethyl malonate to ethylidene malonate.⁸ It was not until Michael's work, however, that the addition of stabilized anions (his also derived from malonates) to α,β -unsaturated double bonds was more thoroughly investigated.⁹ He would later find that electron deficient triple bonds could also serve as reaction partners for these same nucleophiles.¹⁰ A simple example is shown in Scheme 7 in which diethyl malonate adds to ethyl cinnamate.

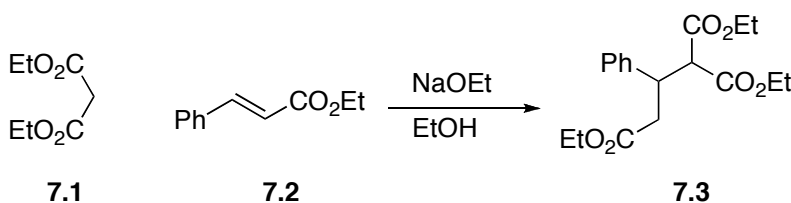

Scheme 7 *The Michael reaction*

Of course, the scope of the reaction would expand over the next hundred years, with the inclusion of heteroatom nucleophiles and modified Michael acceptors, but its most important application came in the field of total synthesis, where its carbon-carbon bond forming ability could be used in intramolecular situations to create complex carbocyclic natural products.

A famous incorporation of the Michael addition in natural product synthesis came from Robert Robinson, whose development of the "Robinson annulation"¹¹ for steroid synthesis revolutionized that field (Scheme 8). This

reaction coupled the carbon-carbon bond forming power of the Michael addition with that of the aldol condensation and, in so doing, generated a powerful method for constructing carbon fused rings. An interrupted, asymmetric version of the Robinson annulation was later developed by Hajos and Parrish,¹² in which the aldol condensation is carried out in the presence of a chiral catalyst, typically proline, in an early example of organocatalysis. A one-pot method was developed at approximately the same time by Weichert and co-workers,¹³ in which they also carried out the reaction with proline; however, they added an acid co-catalyst (such as HClO₄) in what was a one step, asymmetric Robinson annulation.

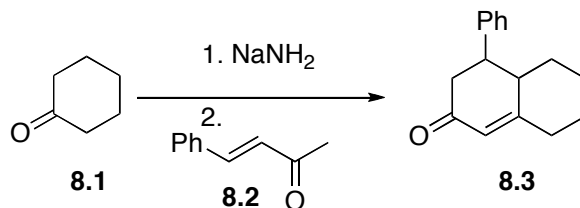

Scheme 8 *The Robinson annulation*

Another classic application of the Michael addition in total synthesis is Corey's use of the reaction to form the bridged ring system of longifolene;¹⁴ the key reaction is shown in Scheme 9.

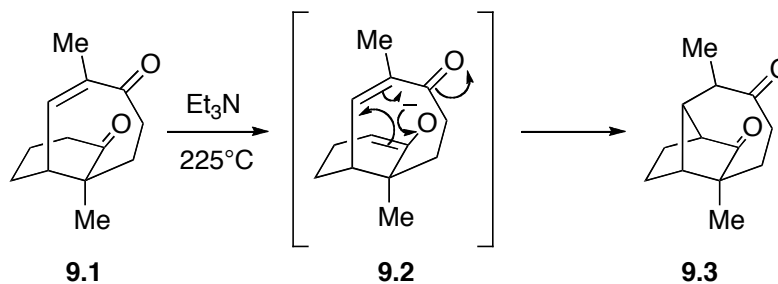

Scheme 9 *The key Michael reaction in Corey's synthesis of longifolene*

As we have seen, the Michael addition is a powerful method of creating carbon-carbon bonds, as well as complicated carbocyclic structures in just a few steps, and the next reaction to be examined utilizes the same principles of enolate condensation as the aldol reaction and Michael addition.

1.2.3 *The Dieckmann Condensation: a specialized form of the Claisen reaction*

The Claisen reaction¹⁵ is a method of preparing β -keto esters, and involves the condensation of an ester enolate with another ester, either identical (*Claisen condensation*), or different (*crossed Claisen condensation*). Taking this ability to form carbon-carbon bonds into consideration, an intramolecular version of the reaction was developed that allowed for the synthesis of many ring systems from acyclic chains (*Dieckmann condensation*),¹⁶ a synthetic method of generating carbon rings that is widely used to this day (Scheme 10).

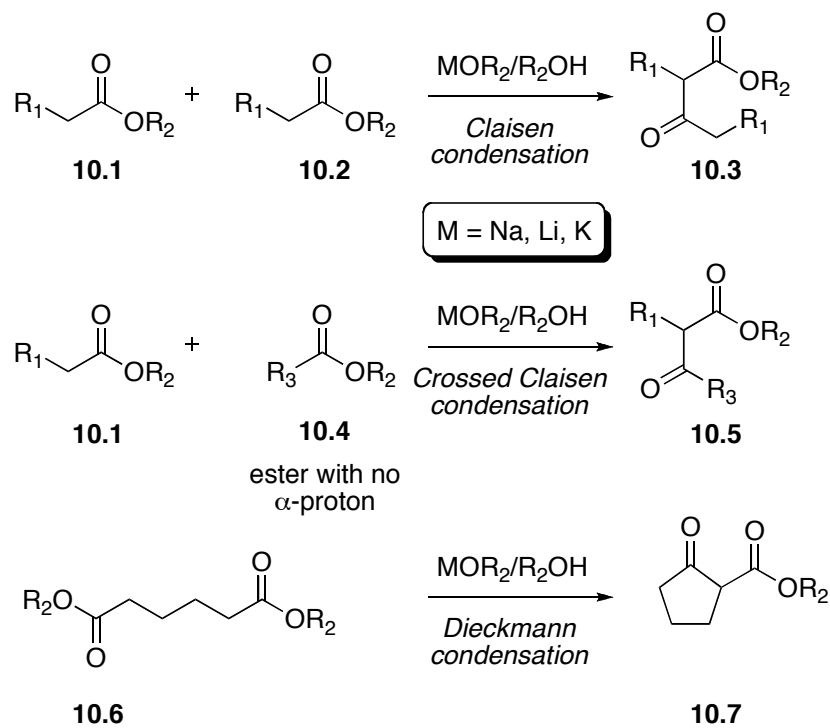

Scheme 10 Variants of the Claisen condensation

An example of the Dieckmann condensation in total synthesis is its application in Boger's route to ningalin D. In this case, Boger used a double

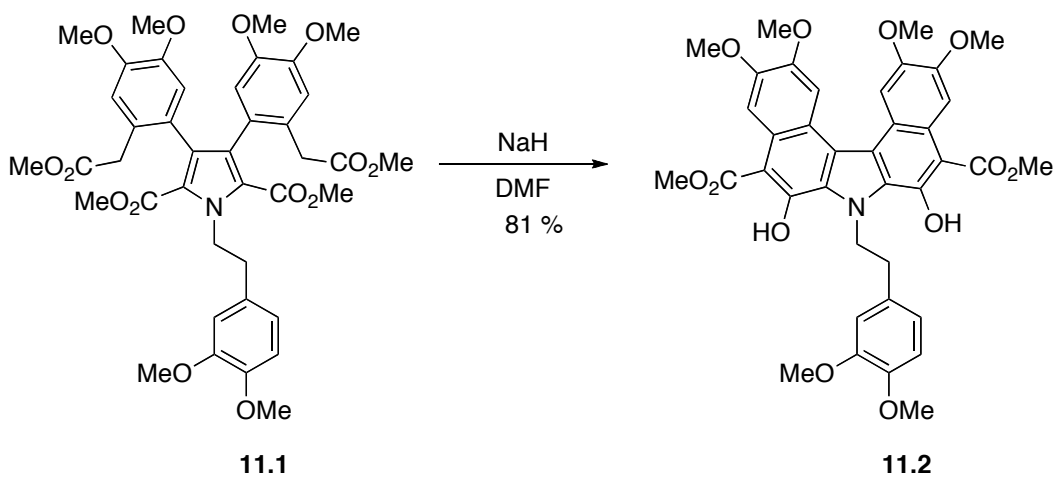

Scheme 11 The Dieckmann condensation in the total synthesis of ningalin D

Dieckmann condensation to generate two aryl rings following tautomerization.¹⁷

To this point, most of the methodology to form carbon-carbon bonds that has been examined is based on enolate/enol chemistry. However, in the 1920's, a new and powerful methodology — the Diels-Alder reaction — would be uncovered which revolutionized the ability to generate molecular complexity in a quick and efficient manner.

1.2.4 *The Diels-Alder Reaction*¹⁸

Although the products of the Diels-Alder reaction had been generated before, their proper structure had not been assigned. However, by elucidating the structure of the adducts to be cyclohexene derivatives, Diels and Alder were able to uncover the true nature of the reaction, and its applicability in total synthesis exploded.¹⁹

The reaction is a thermally allowed, concerted $[4\pi + 2\pi]$ cycloaddition,²⁰ and involves the reaction of a diene with an electron poor alkene or alkyne (the dienophile) in the case of a normal electron demand Diels-Alder reaction. It passes through a transition state that possesses aromatic character, and due to its concerted nature, the Diels-Alder reaction results in the retention of relative stereochemistry. This makes the reaction perfect for organic synthesis, as the outcome is essentially always predictable (Scheme 12).

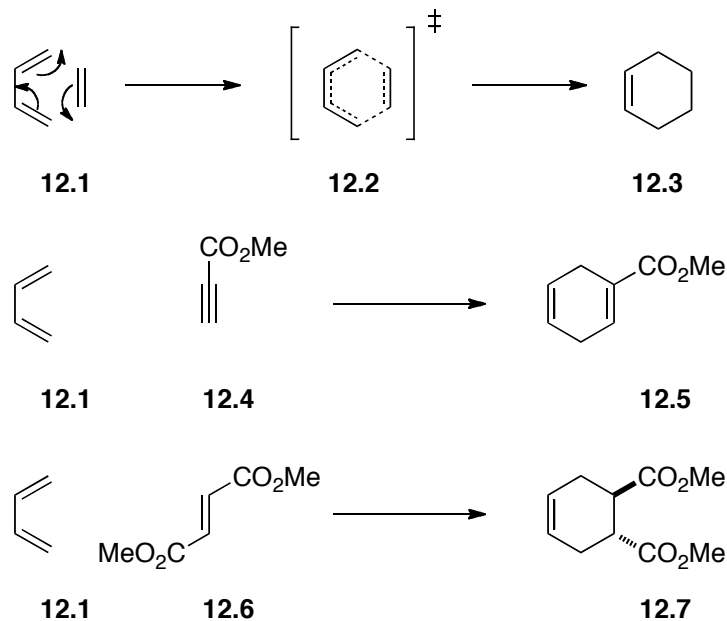

Scheme 12 *The Diels-Alder cycloaddition*

The Diels-Alder reaction can also be used when heteroatoms are present in the components, as long as the electronic nature ($[4\pi + 2\pi]$) is retained. An example is shown from the total synthesis of (-)-lepadin A²¹ (Scheme 13). When the diene does not contain a heteroatom and the dienophile does, then the reaction is a typical electron-demand reaction. However, when the diene does contain heteroatoms and/or electron-withdrawing substituents, an electron rich dienophile is required as this is a reverse electron demand Diels-Alder reaction.

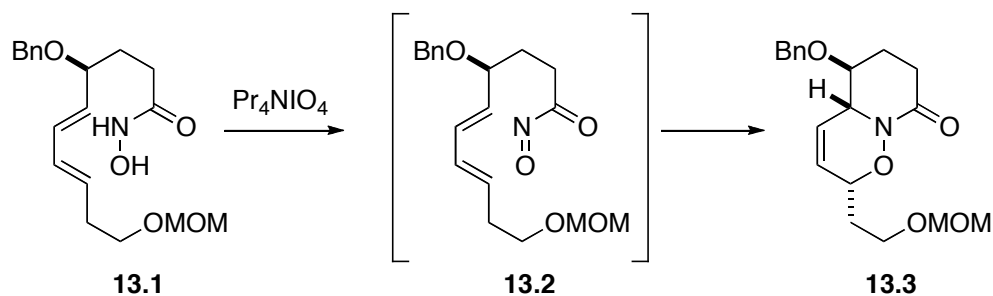

Scheme 13 *Hetero Diels-Alder cycloaddition*

One of the benefits of the reaction is its ability to generate bridged compounds, and in these cases, the stereochemistry of the adduct is typically of an endo nature, due to the approach taken by the dienophile. This approach is attributed to secondary orbital overlap in the transition state between the diene p-orbitals, and p-orbitals of the dienophile (Scheme 14).

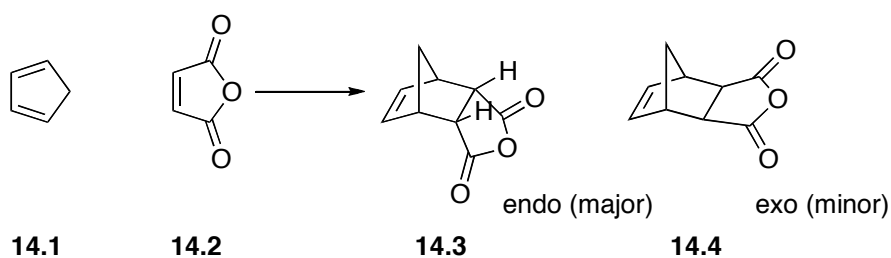

Scheme 14 *Endo selectivity of the Diels-Alder cycloaddition*

In the past decade, a large number of asymmetric catalysts have been designed for use in the Diels-Alder reaction, greatly increasing its usefulness. The most important of these catalysts include Corey's oxazaborolidine catalysts,²² Evans' copper-box system for *N*-acrylyloxazolidinones,²³ and also the organocatalysts of MacMillan.²⁴ These catalysts have allowed for the

introduction of asymmetry at the early stages of syntheses, and have given chemists the ability to utilize the Diels-Alder reaction in modern asymmetric synthesis.

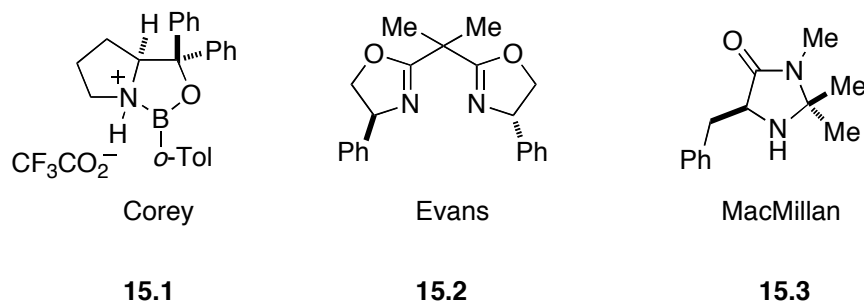

Scheme 15 *Asymmetric catalysts for the Diels-Alder cycloaddition*

An impressive example of the power of the Diels-Alder reaction is in Nicolaou's approach to the core structure of the CP molecules²⁵ (Scheme 16). In this case, an intramolecular Diels-Alder reaction was carried out in the presence of a Lewis acid catalyst via an endo transition state, generating the advanced intermediate **16.3** from acyclic starting material.

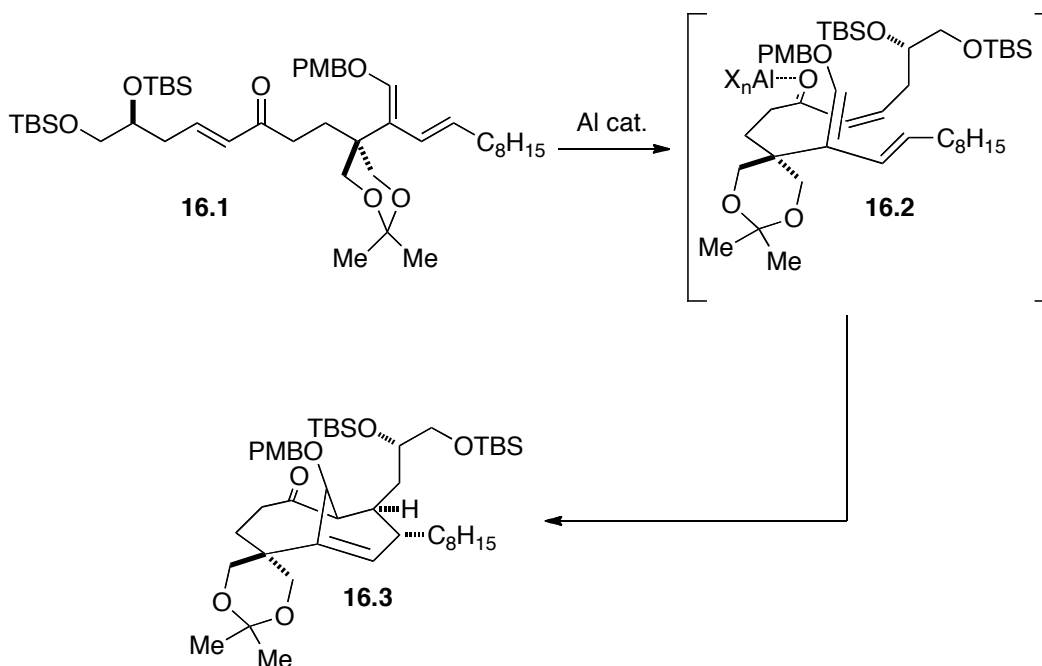

Scheme 16 Use of the Diels-Alder reaction in the total synthesis of the CP molecules

In summary, the Diels-Alder reaction is arguably one of the most powerful methods of creating complex carbocycles from much simpler starting materials.

1.2.5 Organometallic mediated cyclizations

The development of organometallic reagents in the 1970's revolutionized the procedures for making carbon-carbon bonds, and is perhaps as powerful a tool for creating complex structures as the Diels-Alder reaction. Although the field of sp^3 - sp^3 carbon-carbon coupling remains in its infancy, chemists have devised methods for coupling carbon atoms of essentially all other combinations of hybridization, and this substantial work on coupling reactions has been recognized by the Nobel committee in 2010. This work cannot be

comprehensively reviewed in this brief introduction — there are many books on the subject.²⁶ However, an identification of the main metal mediated reactions and their use in total synthesis will be provided in order to show the importance of this area of organic chemistry.

The reactions of Heck,²⁷ Negishi,²⁸ Suzuki,²⁹ Kumada,³⁰ Stille,³¹ and Nozaki,³² are considered to be the pre-eminent coupling reactions useful for bond and carbocycle formation, and they have been crucial in the synthesis of very complex compounds.

Highlighted below is Panek's use of a "double" Stille reaction, carried out during the total synthesis (+)-mycotrienol,³³ and Danishefsky's use of a Heck reaction during his total synthesis of taxol.³⁴ These examples were chosen as they display the applicability of the methodology in a complex total synthesis.

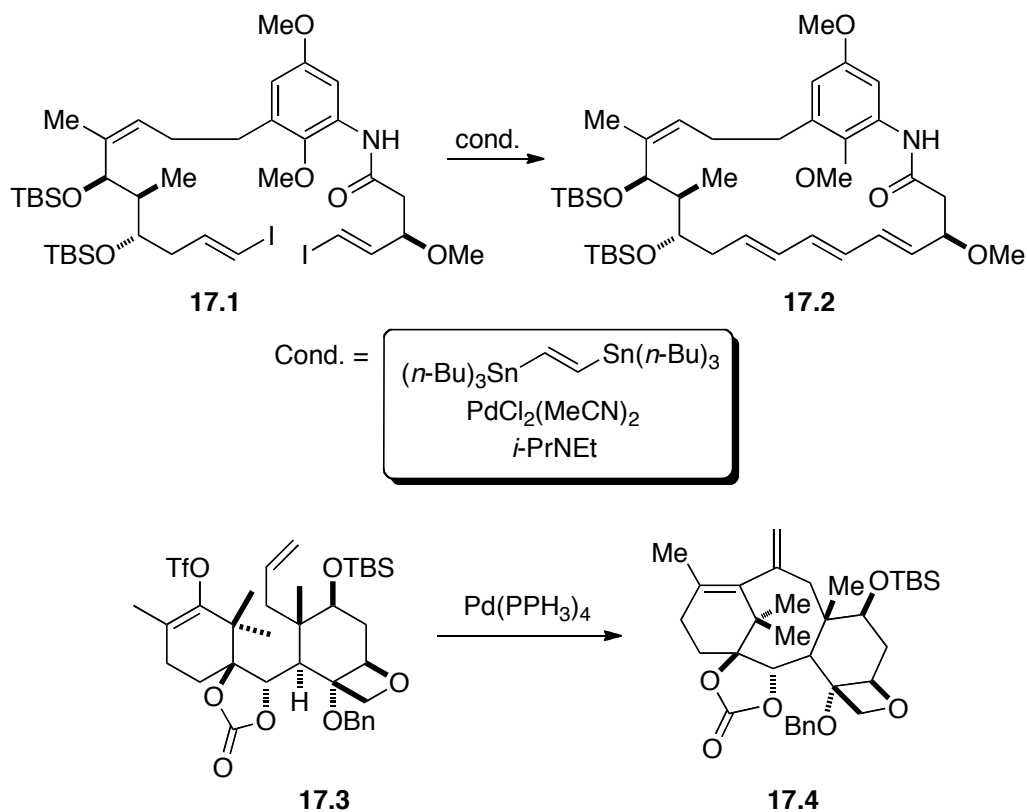

Scheme 17 *The Stille and Heck reaction in total synthesis*

The Suzuki-Miyaura²⁹ reaction has come to be one of the most powerful macrocyclization methods used today; it also has the ability to couple large fragments together during a synthesis. Shown below is the construction of the ring system of phomactin B,³⁵ the key step being the intramolecular coupling to form the large macrocycle.

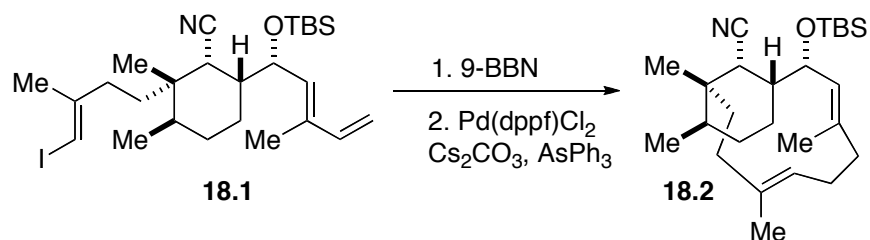

Scheme 18 Use of the Suzuki-Miyaura reaction in total synthesis

Finally, we come to alkene metathesis,³⁶ perhaps the most significant contribution to carbon macrocycle synthesis. The ring closing metathesis emerged as the most commonly used form of the metathesis reaction, as it allows for the "coupling" of two sp^2 hybridized olefinic carbons in the presence of a catalyst along with the concomitant generation of ethylene (Scheme 19).

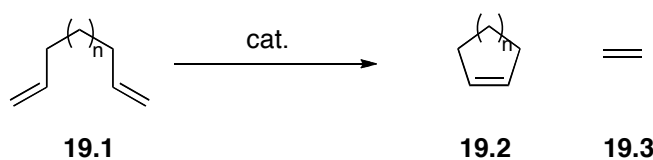

Scheme 19 Outcome of a ring closing metathesis

Although the initial use of the reaction in synthesis could not be exploited due to the low functional group tolerance and efficiency of the catalysts, the development of Grubbs³⁷ and Schrock's³⁸ catalysts (Scheme 20) allowed synthetic chemists to utilize the reaction under almost any circumstance. Some of the drawbacks of the reaction include catalyst sensitivity to Lewis bases in the substrate (amines, nitriles, etc.) and an inability to control double bond geometry

for cross metatheses and large ring closing metatheses (although often the residual double bond is reduced afterwards in the latter situation).

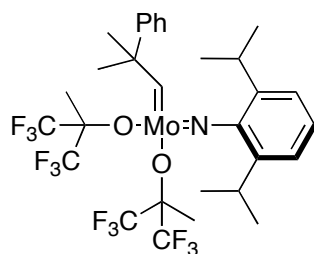

Schrock's cat.

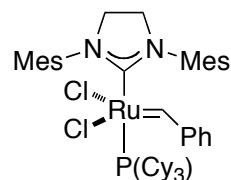
20.1Grubbs' 2nd gen. cat.**20.2**

Scheme 20 *Catalysts for olefin metathesis*

The power of the ring closing metathesis was on full display in the total synthesis of (+)-nakadomarin A,³⁹ when the reaction was used twice in order to install two large carbon macrocycles. Each metathesis utilized a different Grubbs catalyst to optimize yields, and one can see the functional group tolerance. The reliability of the reaction is attested by the fact that a ring closing metathesis is typically utilized near the end of many organic syntheses, and the value of the metathesis process was recognized with a Nobel Prize in 2005.

Although no formal examination of the details of these metal mediated reactions can be given here, the goal was to highlight the importance of these methods in the field of total synthesis and carbocycle formation. From the examples provided, it is clear that this methodology has changed the manner in which chemists approach synthetic problems.

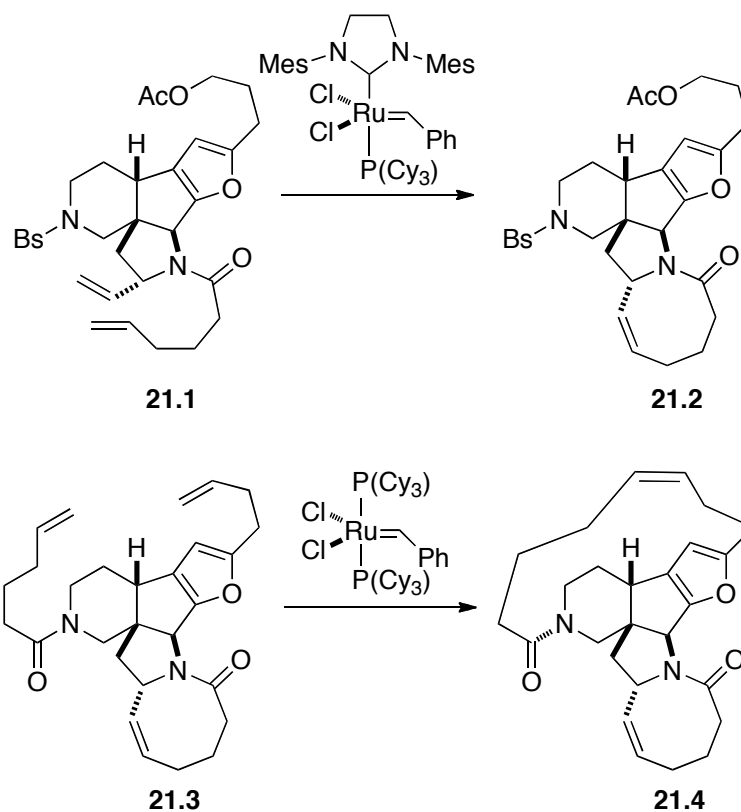

Scheme 21 Ring closing metathesis in the synthesis of (+)-nakadomarin A

1.2.6 Radical Cyclizations⁴⁰

Another powerful method of making carbocycles and one that is again too large to cover completely in this introduction, is radical cyclization. However, a brief overview of the reaction and its applicability in organic synthesis will be included.

During radical cyclization, a radical is generated, which closes onto an acceptor functionality within the acyclic chain, producing a ring. The radicals are typically generated from halogens and phenyl alkyl selenides⁴¹ using a stannane

and a radical initiator (usually AIBN), and they prefer to close in a *5-exo-trigonal* cyclization as opposed to a *6-endo-trigonal* closure (Scheme 22).

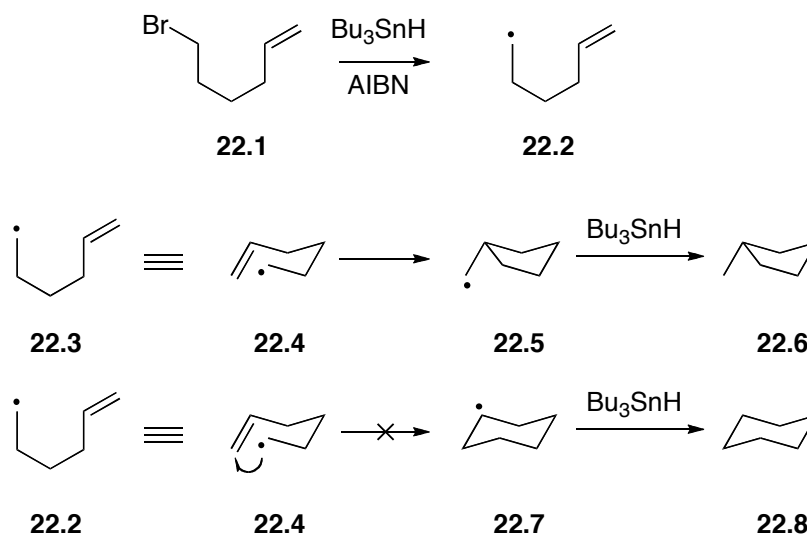

Scheme 22 *Radical cyclization*

The reason for the preferred *5-exo-trigonal* cyclization is due to effective orbital overlap along this trajectory, according to Baldwin's rules.⁴² In the case of the five-membered ring, the radical orbital can overlap with the π^* orbital more effectively along this approach as opposed to the overlap that would form the six-membered ring.

Being free of additives and allowing for conditions that do not require protecting groups on several functionalities (including -OH and -NRH), radical cyclizations have come to be very popular in organic synthesis. For example, in the total synthesis of dihydrocodeine⁴³ [a formal intermediate in the synthesis of (-) morphine], two rings were formed during a cascade radical cyclization

(Scheme 23), without any requirement for hydroxyl protection. This reaction illustrates the ability of radical cyclizations to form complex systems from simple starting materials, and is clearly a powerful synthetic tool.

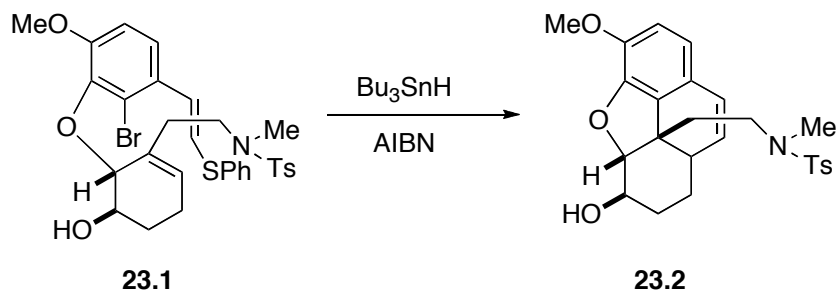

Scheme 23 Use of a radical cyclization in the total synthesis of dihydrocodeine

1.2.7 Displacement reactions

The last method of carbocycle formation to be mentioned here, and one of the oldest, is the simple displacement (e.g. $\text{S}_{\text{N}}2$ type) reaction within acyclic starting materials (Scheme 24). Using this simple approach, many different ring sizes can be generated, although there are some limitations, as defined by Baldwin's rules.

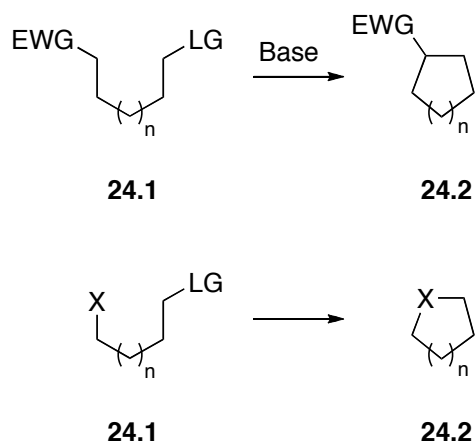

Scheme 24 *Displacement reactions to form rings*

It was through the use of displacement reactions that much of the evidence for preferred intramolecular trajectories of attack, and the subsequent ring sizes that are produced, was elucidated. Stork found during the synthesis of (\pm)-grandisol⁴⁴ that his method of opening epoxynitriles under basic conditions led to the preferential generation of four-membered rings due to the geometric constraint imposed by the epoxide in the acyclic system (Scheme 25).

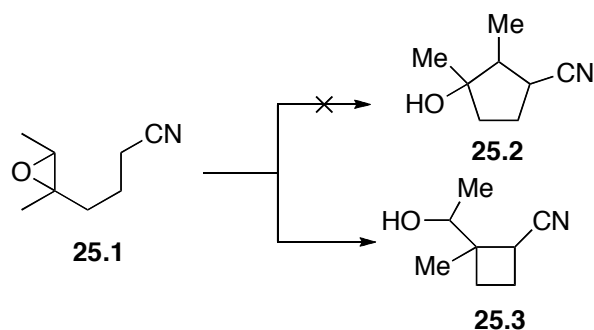

Scheme 25 *Stork's epoxynitrile ring closing reactions*

It must be noted that these rules are more in the nature of guidelines, and that many examples exist in which they do not apply. However, the rules have been applied to many of the cyclization methods seen previously in this introduction, including radical cyclizations, Michael additions and aldol reactions.

1.2.8 Conclusions

Many other methods of cyclization have not been mentioned here, including the McMurry coupling,⁴⁵ the Wittig⁴⁶ and Horner-Emmons-Wadsworth⁴⁷ olefinations, Kagan-Molander⁴⁸ coupling, and many rearrangements that can provide ring structures. However, the goals of this section were to provide the historical and most known methods of carbocycle formation, in order provide the reader with the proper historical background. At this point, I would like to now introduce our group's useful approach of carbocycle formation.

1.3 The all carbon Intramolecular Conjugate Displacement Reaction (ICD)

During an S_N2' reaction, there is a nucleophilic attack on the double bond of an allylic system, causing a shift in the double bond and displacement of a leaving group (**26.1** \rightarrow **26.3**) as the reaction proceeds, in what is believed to be a concerted manner (though this is surprisingly contentious in certain allylic systems).⁴⁹ To clarify the previous statement, in certain cases, an S_N2' displacement may really be an allylic rearrangement followed by a substitution, or rearrangement of an S_N2 product. It is necessary to eliminate the latter possibilities before labeling any reaction as a true S_N2' process.

If there is an electron withdrawing group on the central carbon of an allylic system bearing a leaving group, the reactivity of what appears to be a S_N2' reaction is greater than in the absence of the electron withdrawing group. The resultant reaction might be a hybrid of the classical Michael reaction and an $E1_{CB}$ elimination, mimicking the outcome of an S_N2' reaction. The process would be useful in organic synthesis (shown in general from **26.4** \rightarrow **26.5**) because S_N2' prime reactions do not always work and this modification would be an effective way of overcoming this problem.

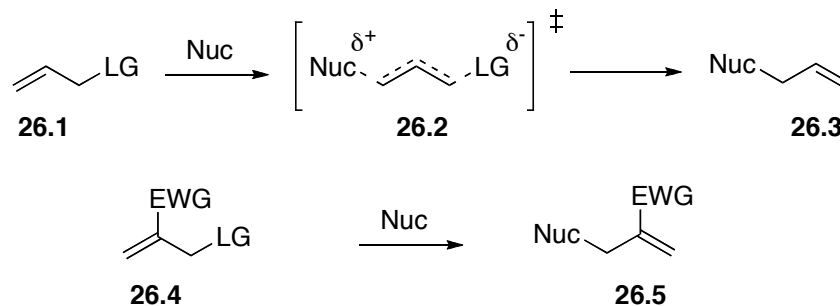

Scheme 26 *The S_N2' reaction and its modification*

An early example of this enhanced reactivity was reported by Seebach⁵⁰ in an intermolecular case, via the displacement of an acid leaving group in the presence of organolithium and Grignard nucleophiles with a nitro group on the central carbon (**27.1** \rightarrow **27.2**).

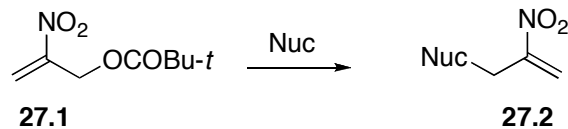

Scheme 27 *Seebach's modification of the S_N2' reaction*

The use of this reactivity in an intramolecular sense has been reported only occasionally, such as in the generation of azamacrocycles⁵¹ (nitrogen as the nucleophile) or for cross-linking proteins.⁵² This laboratory has expanded on the use of this intramolecular reactivity,⁵³ and has been able to construct many different alkaloid core structures of the type [m.n.0] with nitrogen at the bridgehead position using, what we have now dubbed, the intramolecular conjugate displacement (ICD) reaction (Scheme 28).

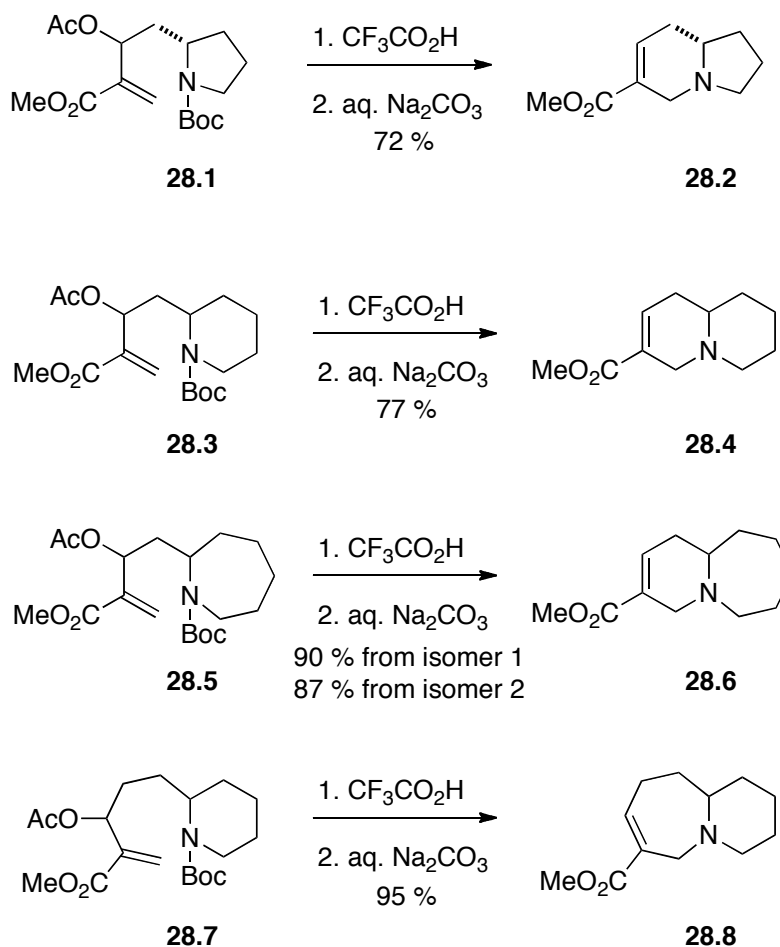

Scheme 28 *Intramolecular conjugate displacement (ICD) with nitrogen*

The nucleophile in these situations was nitrogen, and all ring closures proceeded in excellent yield.

Our group has already applied the method of ring formation to (+)-halichlorine⁵⁴ (via the ICD intermediate **29.2**), as well as the smaller alkaloid (-)- δ -coniceine⁵³ (**29.6**).

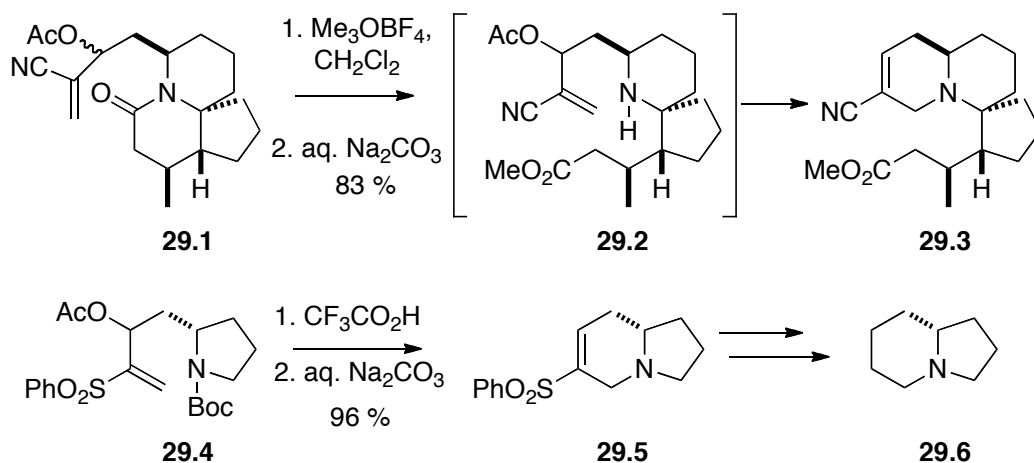

Scheme 29 *The ICD and its use in total synthesis*

Recently, this group has been working on the total synthesis of CP-225,917, and in the process of that research,⁵⁵ modified the intramolecular conjugate displacement to include a carbon nucleophile for the first time, resulting in an all-carbon ICD reaction (Scheme 30).

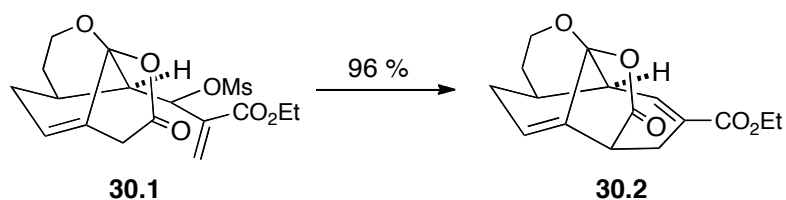

Scheme 30 *Applicability of the all-carbon ICD in CP molecule synthesis*

At this point, we became interested in generalizing the all-carbon ICD as a method of preparing carbocyclic compounds, as the utility of the above conversion made it obvious that an investigation of the scope of the reaction was appropriate.

In past investigations carried out by this group,⁵⁶ the substrate scope, nucleophile, leaving group, and mechanism were all explored in detail. The ring sizes (Scheme 31) that could be accessed via the endocyclic ICD reaction include six- to eight-membered rings, and the best nucleophiles in these cases were malonates, α -benzenesulfonyl esters $(\text{PhSO}_2)\text{CH}(\text{R})\text{CO}_2\text{R}'$, and gem bis-(phenylsulfones) $[(\text{PhSO}_2)_2\text{CHR}]$. The empirical findings suggested that DBU or Cs_2CO_3 in MeCN or THF are the preferred bases for the ICD reaction, and Cs_2CO_3 in THF became the method of choice, as no elimination reaction of the leaving group was observed. Finally, the reaction proceeded well when the usual electron-withdrawing groups of standard Michael acceptors were placed on the central carbon of the allyl system, such as esters, nitriles, and sulfones.

When attempting to make the eight-membered ring, it was found that the six-membered ring forms preferentially in typical $\text{S}_{\text{N}}2$ fashion, and therefore the ICD method seems more general for the formation of six- and seven-membered rings. Five-membered rings can be generated, but only in an exocyclic fashion (**31.7** \rightarrow **31.8**), as *5-endo-trig* reactions are disfavored according to Baldwin's rules.

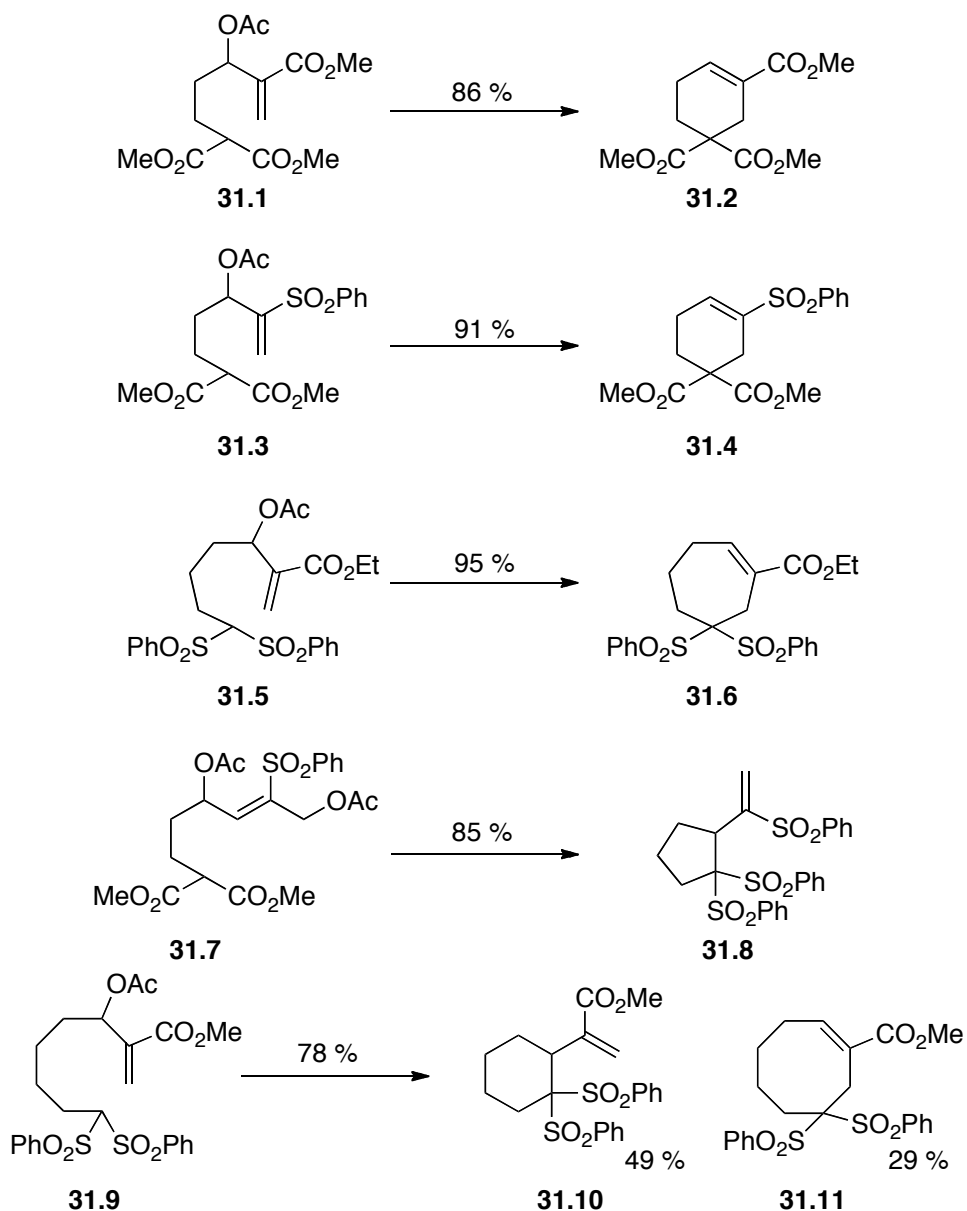

Scheme 31 Carbocycle ring formation via the ICD reaction

The mechanism was also explored for these ICD reactions, in an effort to deduce whether or not it is a concerted reaction (an S_N2' reaction), or a Michael addition followed by an $E1_{CB}$ elimination of the leaving group. It was established that when the leaving group is poor ($-OSiEt_3$), the normal Michael adduct can be isolated. When the ICD is carried out in a protic solvent (MeOH or *t*-BuOH) with

a good leaving group (-OAc), the cyclized product is isolated, and not the protonated Michael intermediate. The only conclusion to be made, based on this evidence, is that either the Michael adduct is too short-lived to be captured (since the E1_{CB} elimination of the leaving group follows quickly thereafter), or a concerted mechanism (the S_N2') may be operating. However, we do know that a Michael acceptor is required on the central allylic carbon, as a phenyl group and Si atom substitution gave no reaction (see Chapter 1 of this thesis), at least in the cases of aza-ICD reactions.

With this general method for generating carbocyclic ring structures fully investigated, it was decided to apply the method to asymmetric intermediates that could be elaborated into more complex structures.

1.4 Conclusions

Some of the historical methods for generating carbocyclic compounds have been described above so as to provide a context for the following work. A synopsis has also been provided describing this group's study of the scope of the intramolecular conjugate displacement (ICD) reaction. At this point, a description of this author's attempts to apply these methods in asymmetric carbocycle synthesis will be described.

2. Results and Discussion

2.1 Research Objectives

We wished to asymmetrically introduce a pendant chain into the starting material for the ICD reaction so that the process shown in Scheme 32 could be carried out.

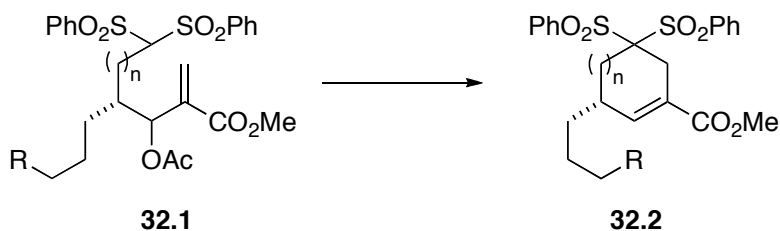

Scheme 32 *Projected ICD formation of asymmetrically substituted carbocycles*

The α,β -unsaturated ester functionality in the produced **32.2** would allow us to create intermediates that could be transformed into many different kinds of compounds, depending on the nature of the chain, and the stereochemistry of the highlighted stereocenters can be controlled (Scheme 33). In some cases, a Michael addition to the α,β -unsaturated ester would allow us to generate several different types of heterocycles including the decahydroquinoline core (**33.2**), belonging to a major class of amphibian alkaloids (e.g. compound **33.6**),⁵⁷ and the benzopyran core (**33.4**), a class of compounds that is used in perfumery (e.g.

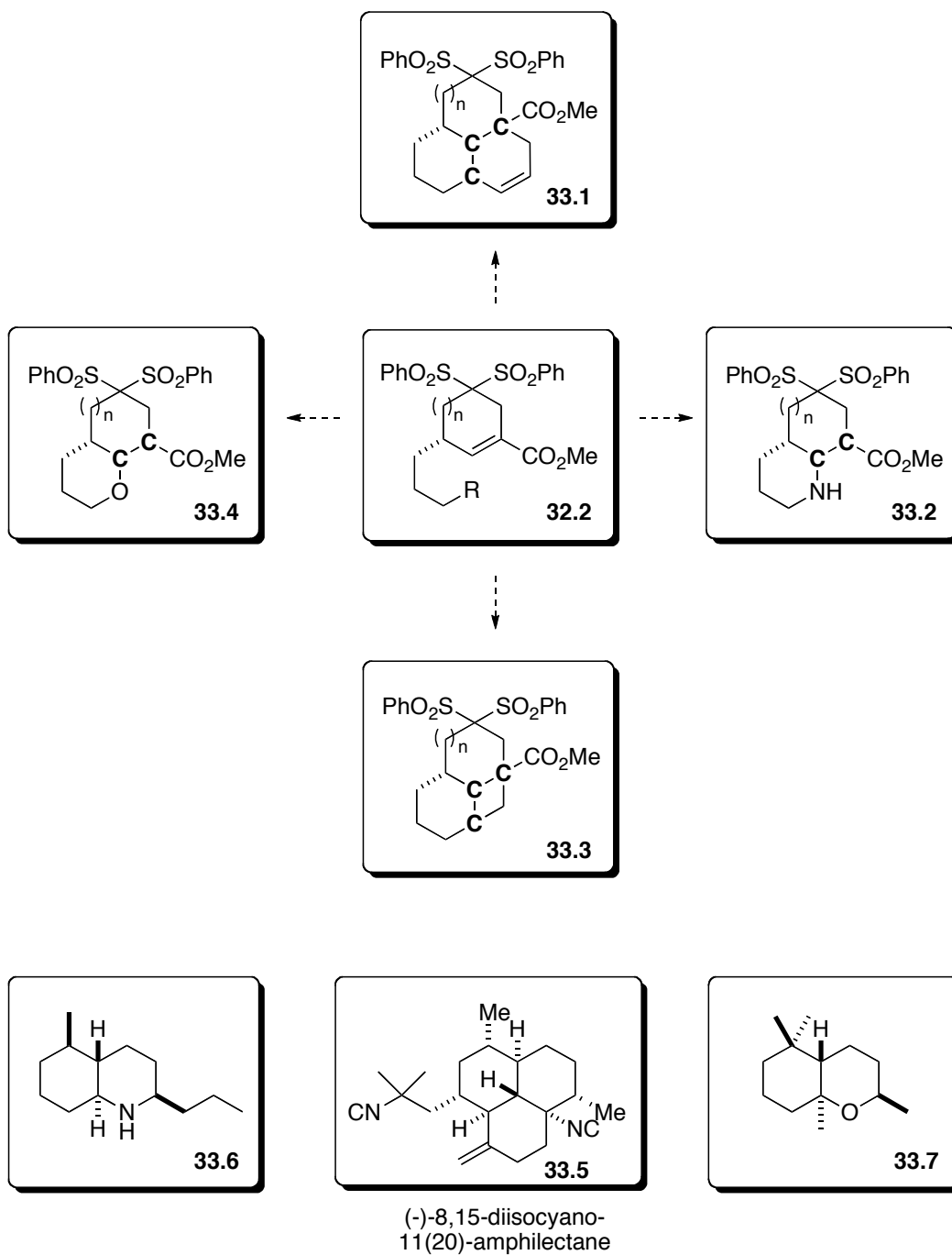

Scheme 33 *Modification of asymmetric intermediates into naturally occurring core structures*

compound **33.7**).⁵⁸ However, the initial aim would be to generate asymmetric carbocyclic ring structures, in a manner that could possibly be later applied to specific targets, such as the amphilectane diterpenoid (-)-8,15-diisocyano-11(20) amphilectane (**33.5**).⁵⁹

The goals of the following work were to find a practical method of installing the pendant chain, followed by ICD formation of the initial ring. The next objective was to then build up these compounds into more advanced intermediates, using the pendant chain as the source of diastereoselectivity for the subsequent ring building reactions.

2.2 Preparation of asymmetrically substituted ICD precursors

Before describing the preparation of the ICD precursors, it must be noted that the chain length of these compounds was chosen in order to generate six- and seven-membered ring products, as they are the sizes most easily produced by the ICD method (Scheme 34). The internal nucleophile would be generated from the $(\text{PhSO}_2)_2\text{CH}$ unit, because this reactive handle should be removable at a later time under reductive conditions. The initial Michael acceptor would be an α,β -unsaturated ester, although in future work the use of an α,β -unsaturated sulfone could be attempted as this too can be removed from the carbocycle framework. The nature of the pendant chain will be covered in future sections, and we envisioned the final precursors to be structures of the type shown below (**34.1**, **34.3**; note that the absolute configuration given in the scheme is arbitrary).

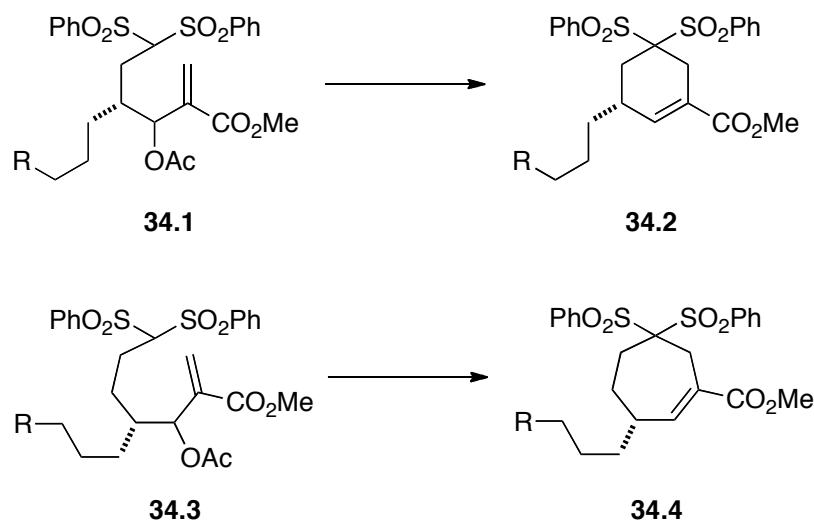

Scheme 34 Targeted asymmetrically substituted ICD intermediates

During the course of past ICD research done in this laboratory,⁵⁶ the method of preparing the ICD precursors for the six- and seven-membered rings was developed in a straightforward fashion (Scheme 35). Aldehyde precursors were prepared that could be converted to Morita-Baylis-Hillman alcohols via a selenium based method⁶⁰ and subsequently acetylated.

This previous research produced the aldehyde of the six-membered ring series by converting acetal **35.1** to the thioacetal under acidic ($\text{CF}_3\text{CO}_2\text{H}$) conditions in the presence of thiophenol (Scheme 35). Displacement of the chloride with sodium cyanide, followed by reduction with DIBAL gave the desired aldehyde (**35.2** \rightarrow **35.4**). The aldehyde for the seven-membered ring series was prepared via a substitution reaction of ethyl 2-bromobutanoate with thioacetal **35.6**, followed by reduction of the ester to an aldehyde (**35.5** \rightarrow **35.8**).

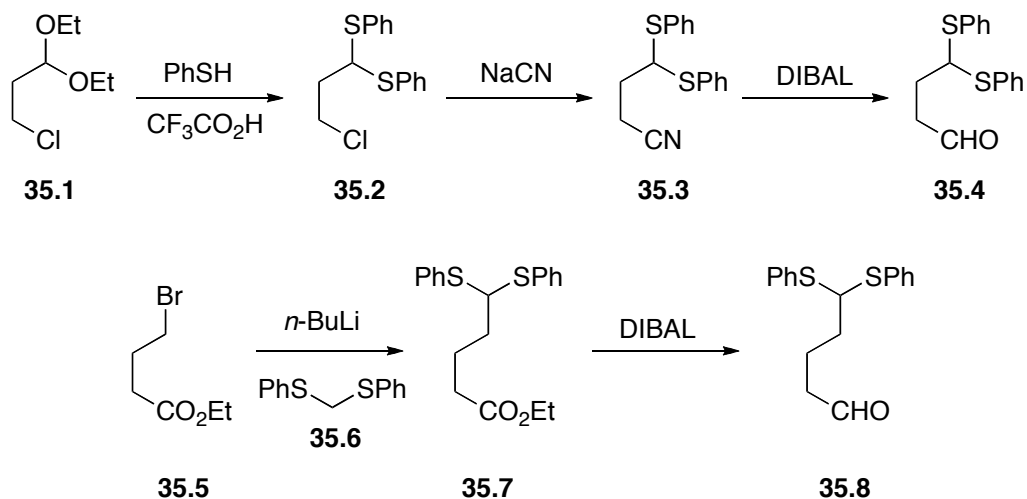

Scheme 35 Aldehyde precursors prepared in the Clive group

Conversion of the aldehydes to the corresponding acetylated Morita-Baylis-Hillman alcohols was then carried out using the selenium-based routes shown below (Scheme 36). The aldehydes of both chain lengths were condensed with selenide **36.1**,⁶¹ oxidized (including the sulfur atoms) with *m*-CPBA, leading

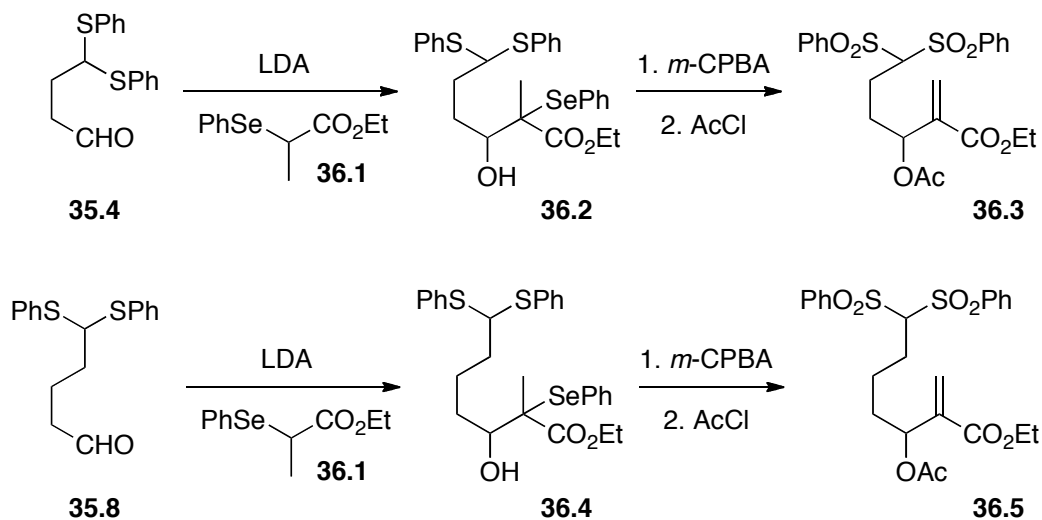

Scheme 36 Formation of ICD intermediates

to selenoxide elimination and double bond formation. The allylic alcohols were then acetylated under standard conditions, using AcCl.

We wished to keep this general approach to the ICD precursors, but at some point we obviously needed to asymmetrically introduce a pendant chain. We felt that the best way to do so was to generate the acid analogs of aldehydes **35.4** (shown below) and **35.8**. We would then introduce a chiral auxiliary and asymmetrically alkylate next to the carbonyl (Scheme 37). The auxiliary would then be removed and the sequence carried forward to the ICD ring formation as in this group's previously developed ICD work.⁵⁶

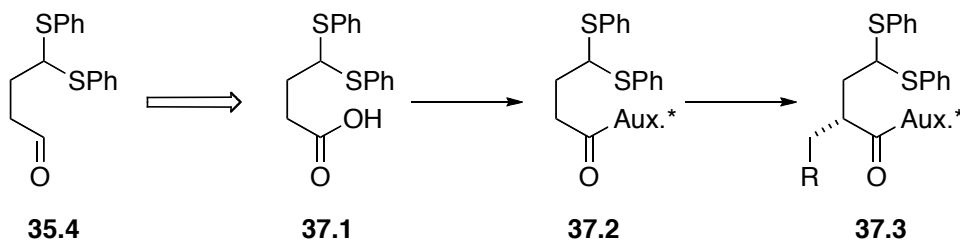

Scheme 37 *Introduction of pendant chain via asymmetric alkylation*

2.2.1 Preparation of the carboxylic acid congeners

The initial attempts of producing the carboxylic acid compounds were based on hydrolyzing an ester precursor (Scheme 38).

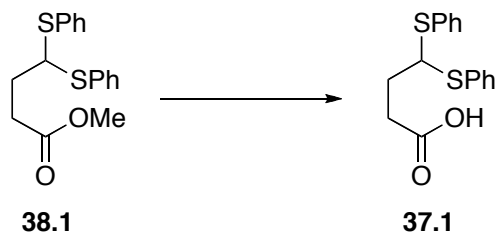

Scheme 38 *Projected preparation of carboxylic acids*

The first attempt to generate the ester **38.1** was to condense 3-chloropropionate with the lithium anion of thioacetal **35.6**, but only a complex mixture was formed (Scheme 39).

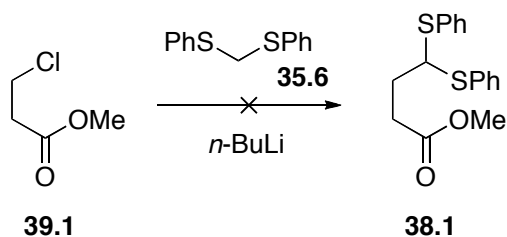

Scheme 39 *Displacement reaction for ester preparation*

We felt that a better leaving group might remedy the situation, and so an iodoester was made via a Finkelstein reaction. Although conversion to the iodoester went smoothly, the lithium anion of thioacetal **35.6** again gave only a complex mixture (Scheme 40).

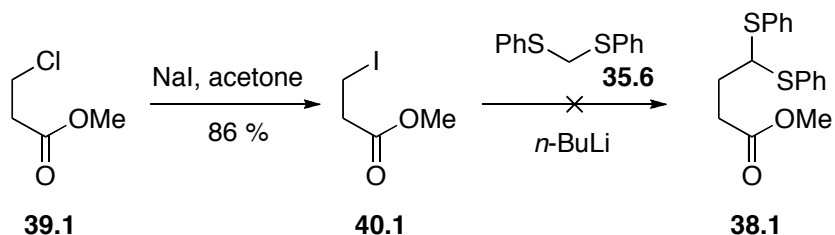

Scheme 40 *Displacement reaction of iodide for ester preparation*

Although this substitution approach worked on chains of greater length in this group's previous work,⁵⁶ it did not work here. We therefore modified the approach to generate the acid by producing a cyanide precursor, which could be hydrolyzed to give the desired compound. Acetal **35.1** could be transformed into thioacetal **35.2** under acidic conditions in excellent yield. Substitution of the chlorine with cyanide and subsequent hydrolysis gave acid **37.1**, but in very low yield (23%). Acidic conditions could not be used due to the presence of the thioacetal, and because the yield was rather low, other routes were explored in an effort to bypass this problem.

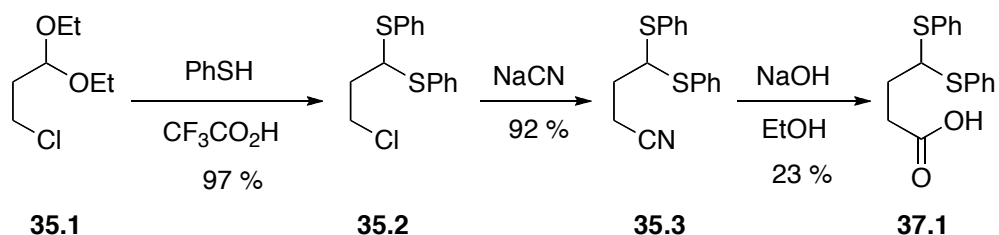

Scheme 41 *First generation carboxylic acid preparation*

The first of these attempts was based on the condensation of a Grignard reagent with carbon dioxide (Scheme 42). The Grignard reagent could be

prepared from the iodoacetal **42.1**, but unfortunately, condensation with CO_2 gave only a complex mixture.

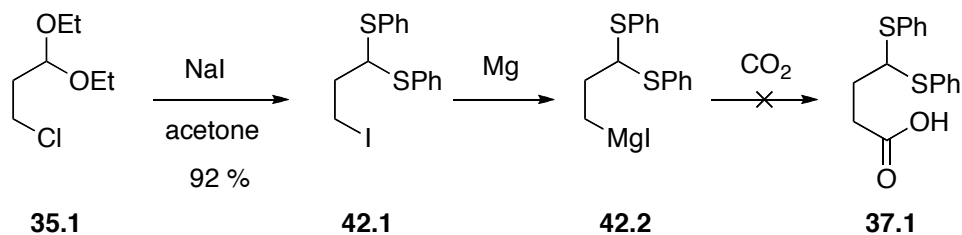

Scheme 42 Use of Grignard reagent to prepare carboxylic acids

An alternative was to take acetal **43.1**, easily prepared from the commercially available chloride **35.1** (Scheme 43), and reduce it with DIBAL to the corresponding aldehyde and carry out a Pinnick oxidation. Although this sequence had previously been carried out to produce the thioacetal analog of **35.4**, that compound was not suitable for Pinnick oxidation due to the danger of sulfur oxidation. Unfortunately, the DIBAL reaction produced an inseparable mixture of several aldehydes, even though a non-aqueous workup with Rochelle's salt (Na^+/K^+ tartrate) was carried out.

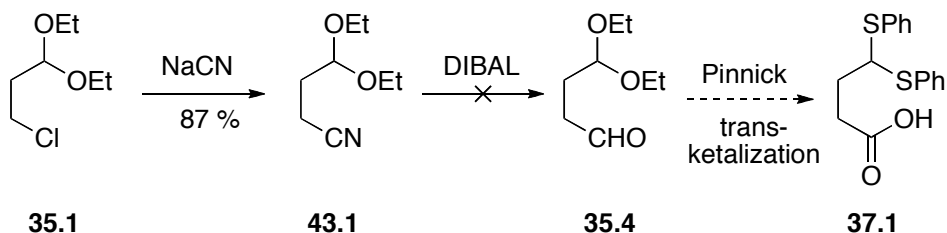

Scheme 43 Nitrile derivatization for carboxylic acid preparation

Finally, a successful route was developed (Scheme 44) whereby γ -butyrolactone was opened under acidic conditions in MeOH to give a mixture of the corresponding acyclic ester and lactone. This mixture was then subjected to Swern oxidation, allowing for the removal of the starting lactone from the newly formed aldehyde. The thioketal was then installed under Lewis acidic conditions, and the ester was hydrolyzed to the desired acid (**38.1** \rightarrow **37.1**).

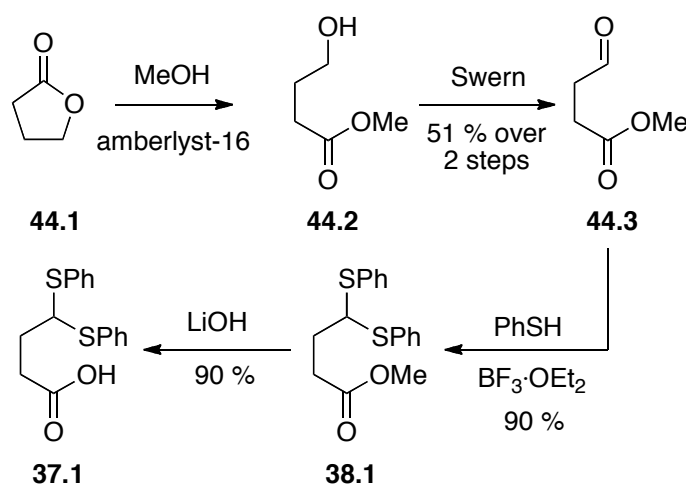

Scheme 44 *Second generation carboxylic acid preparation*

With this method in hand, a corresponding synthesis of the acid required for generation of the seven-membered ring was carried out, the only difference being the use of δ -valerolactone (**45.1**) instead of γ -butyrolactone.

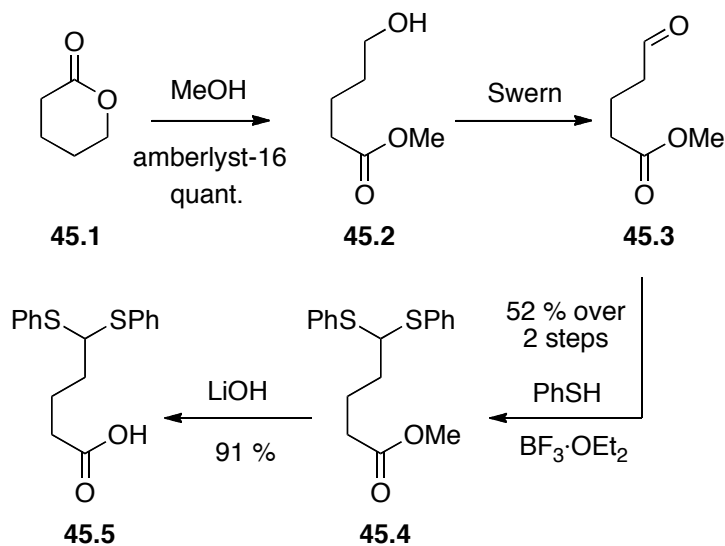

Scheme 45 Carboxylic acid preparation for seven-membered ring series

With these two acids in hand, installation of the chiral auxiliary and alkylation could then be carried out. However, the appropriate chiral auxiliary had to be chosen.

2.2.2 Choosing a chiral auxiliary: The Evans, Myers, and Enders RAMP/SAMP asymmetric alkylation reactions

The Evans aldol research produced several chiral auxiliaries that have also proven to be useful in asymmetric enolate amination,⁶² hydroxylation,⁶³ and, of course, alkylation.⁶⁴ These auxiliaries are substituted oxazolidinones (Scheme 46), and are installed to produce imides whose enolates then react with the appropriately chosen electrophile.

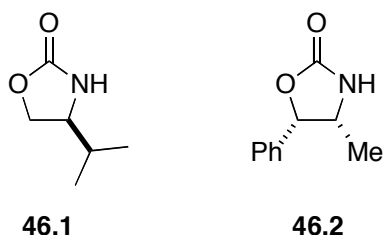

Scheme 46 *Evans chiral auxiliaries*

The chiral oxazolidones are prepared by reaction of phosgene or diethyl carbonate with (*S*)-valinol or (1*S*,2*R*)-norephedrine⁶ to give the auxiliaries pictured above. The imides are then prepared by acylation of the nitrogen using the appropriate acid chloride, and asymmetric alkylation can be carried out using either the lithium- (from LDA) or sodium- (from NaHMDS) (*Z*)-enolate (Scheme 47).

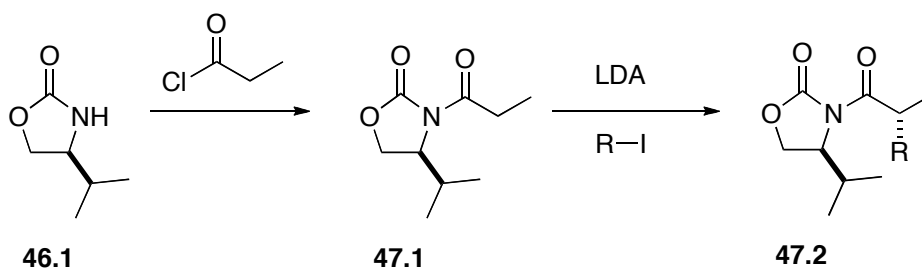

Scheme 47 *The asymmetric Evans alkylation*

The chiral auxiliary can be removed by LiAlH_4 or LiBH_4 reduction or by hydrolysis to the acid, using LiOH ; the alcohol or acid that is released is then carried forward in the synthesis.

Some of the advantages of the Evans asymmetric alkylation include the ease of preparation of the optically pure chiral auxiliaries, the high diastereoisomeric excess typically seen in the reaction, and the ability to remove the auxiliary without epimerization under mild conditions (allowing for the recycling of the auxiliary) due to the reactive nature of the imide functionality.

The Myers asymmetric alkylation⁶⁵ is based on the same principles as the Evans method, but utilizes a chiral amide rather than an imide to impart facial selectivity in the subsequent alkylation reaction. By using pseudoephedrine as the chiral auxiliary, the Myers alkylation allows for the generation of more nucleophilic amide enolates, overcoming a problem encountered with imide enolates.

The amides can be prepared under specific conditions from several different kinds of functionality, including acids, acid chlorides and even esters (Scheme 48), and the subsequently alkylated products are typically crystalline (allowing for recrystallization and optical enrichment). Below is an example of an amide produced from (*S,S*)-(+)-pseudoephedrine.

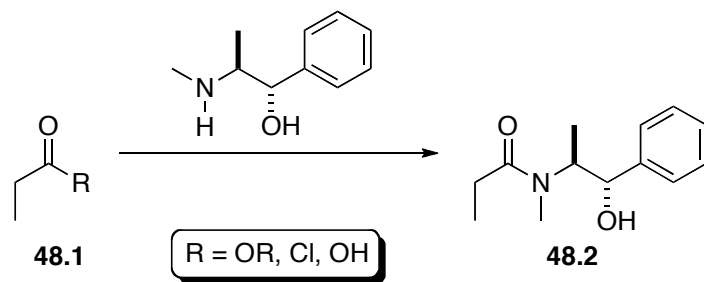

Scheme 48 Preparation of pseudoephedrine amides

Once the amide has been prepared, alkylation can then be carried out by preparing the (*Z*)-enolate with LDA in the presence of LiCl, followed by the addition of the alkylating agent, typically an alkyl iodide (Scheme 49). The presence of LiCl in the reaction mixture accelerates the rate of alkylation, as well as suppressing any *O*-alkylation on the chiral auxiliary. (Note that the stereochemistry in the scheme below is assigned based on Myers observation that attack is from the face opposite to that of the lithiated ephedrine oxygen).

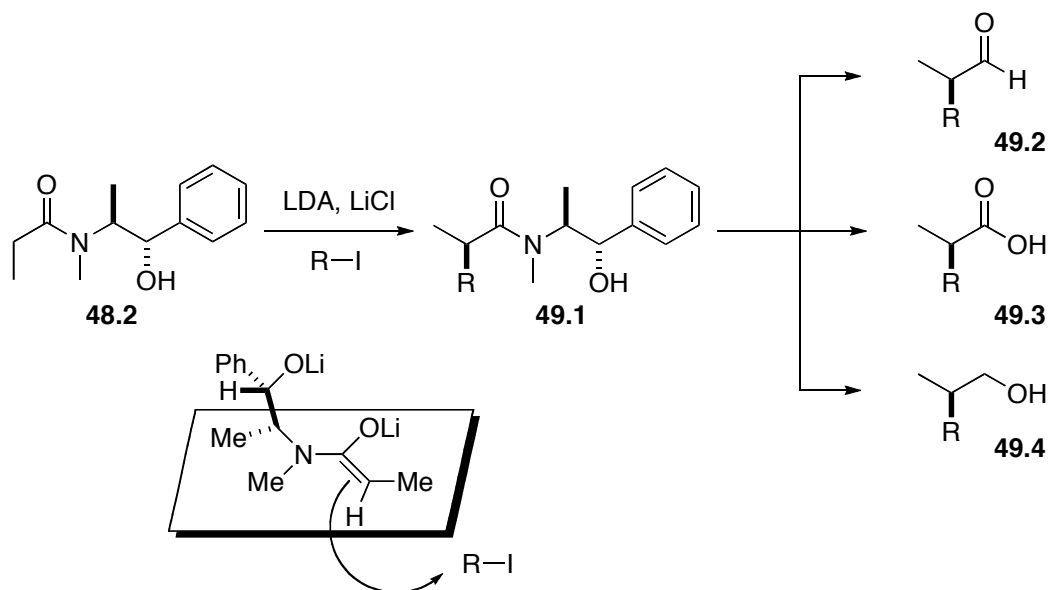

Scheme 49 Myers asymmetric alkylation and auxiliary removal

Some positive aspects of the Myers alkylation include the ability to remove the chiral auxiliary in several different ways, while still maintaining optical purity, including hydrolysis to the corresponding acid, as well as amide reduction to either the aldehyde or alcohol. β -Substituted alkyl chains can also be used as electrophiles for alkylation, and the pseudoephedrine enolates are thermally stable even at 23 °C, which allows for higher temperature exposure to the alkyl halide, which may lead to higher yields.

The Enders RAMP/SAMP⁶⁶ method of asymmetric alkylation is different from both the Evans and Myers methods in that it uses an asymmetric hydrazone auxiliary (RAMP/SAMP) (Scheme 50) as the source of chirality during the alkylation.

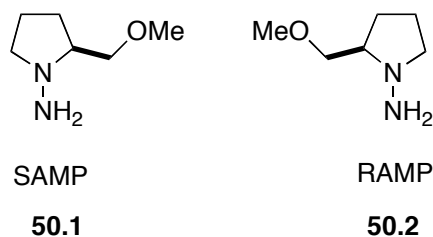

Scheme 50 *RAMP/SAMP hydrazones*

The hydrazone can be made from aldehydes at 0 °C, but for ketones, refluxing in benzene with catalytic acid and a Dean-Stark apparatus is necessary. The enolate can then be formed using LDA, followed by cooling to temperatures around -100 °C and addition of the alkyl halide (Scheme 51).

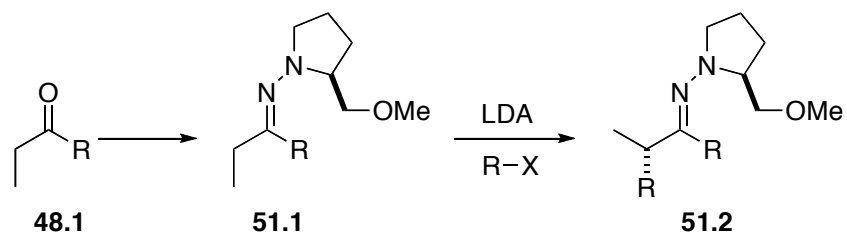

Scheme 51 *RAMP/SAMP alkylation*

The chiral auxiliary can be removed by ozonolysis or hydrolysis following *N*-alkylation with MeI; the hydrazone can also be converted to other functionalities such as nitriles,⁶⁷ dithianes,⁶⁸ or amines.⁶⁹

Due to the low temperatures required, strong alkylating agents such as primary halides (Br or I), allyl halides and benzyl halides are required for the reaction to occur, somewhat limiting the substrate scope of the reaction.

With these three options available, it was felt that the Myers asymmetric alkylation reaction would be the best one for the alkylation required in this work. It was chosen because of the possibility of optical enrichment via recrystallization of the (typically) crystalline products, the availability of the chiral auxiliary (pseudoephedrine), as well as the variability of the alkyl halides that have been used in the literature reports.⁷⁰

2.2.3 Conversion of the carboxylic acid precursors to pseudoephedrine amides

The first order of business was to install the pseudoephedrine auxiliary into our previously prepared carboxylic acids, using (*S,S*)-(+)-pseudoephedrine.

Because Myers had a procedure for the conversion of esters to pseudoephedrine amides (Scheme 52), this method was attempted first, in an effort to avoid converting the ester to the acid.

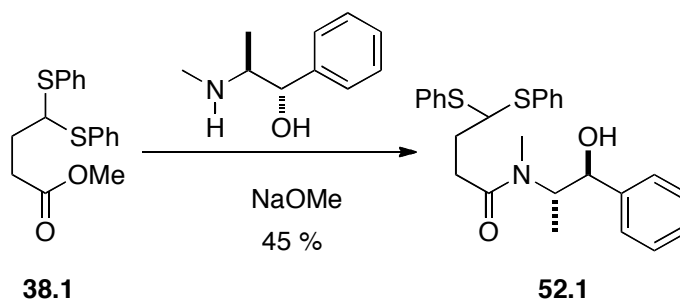

Scheme 52 *Preparation of pseudoephedrine amides from an ester precursor*

Unfortunately, this method gave only low yields and the use of the carboxylic acid proved to be necessary.

Two methods were available for transforming the acid into the amide, the first being the formation of a mixed anhydride and treatment with (+)-pseudoephedrine, and the second being the conversion of the acid to the acid chloride, again followed by treatment with (+)-pseudoephedrine. The first method gave the desired amide in only 53 % yield when applied to **37.1** (see below).

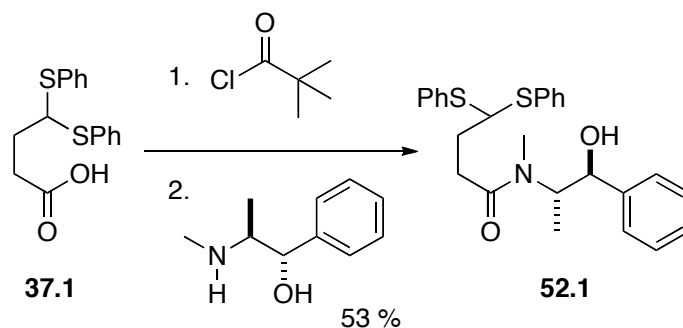

Scheme 53 Preparation of a pseudoephedrine amide from a mixed anhydride

However, transformation to the amide via the acid chloride proved to be very efficient, and this method was applied to the seven-membered ring series acid (**45.5**) as well (Scheme 54). Now, with the pseudoephedrine amides in hand, alkylation could be carried out.

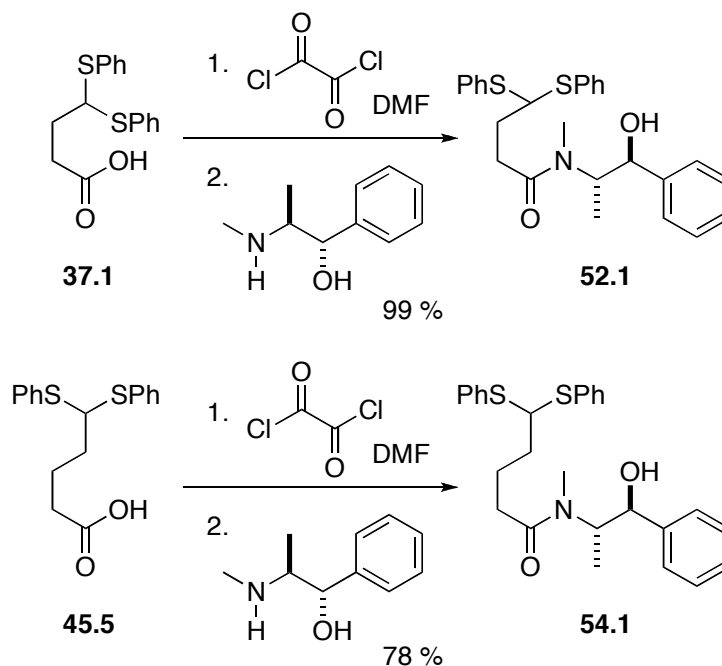

Scheme 54 Preparation of pseudoephedrine amides from acid chlorides

Amides **52.1** and **54.1** are not crystalline, but rather sticky semi-solids. Efforts to obtain a solid by precipitating the compound out of solution were unsuccessful. Because the optical purity of the purchased pseudoephedrine was assumed to be acceptable (the $[\alpha]_D^{25}$ was checked for accuracy*), we felt confident that the optical purity of the amides was high, and a recrystallization at this stage was not required.

2.2.4 Selection of the pendant chain and asymmetric alkylation

Prior to amide alkylation, the nature of the pendant chain needed to be considered because it would ultimately be involved in reactions after the ICD cyclization. Because the initial goal of the project was to produce more complex carbocycles, the Diels-Alder reaction was chosen as the method for elaborating the ICD product, and for this purpose the initial pendant chain would have to be a diene, or be convertible into a diene.

Compounds such as **55.1** (Scheme 55) could be produced from the pendant diene precursor **55.2**. Clearly, the pendant diene could be installed via alkylation using alkyl iodide **55.6**, but it may be better to carry a protected oxygen (of type **55.7**) through the sequence, and then convert the hydroxyl functionality to the diene.

* The $[\alpha]_D^{20}$ of the purchased bottle was listed as $+51 \pm 2$ ($c = 0.6$ in EtOH). In comparison, our recorded $[\alpha]_D^{25}$ value from the same bottle was $+50$ ($c = 0.6$ in EtOH).

The total length of the final diene chain was to be seven carbons, as we felt that the synthesis of the all six-membered ring system **55.1** would be an appropriate first example, as related Diels-Alder reactions are known.⁷¹ We decided to first examine the protected oxygen method; the other possibility, with the diene already present in the alkyl halide, will be discussed in Section 2.2.8.

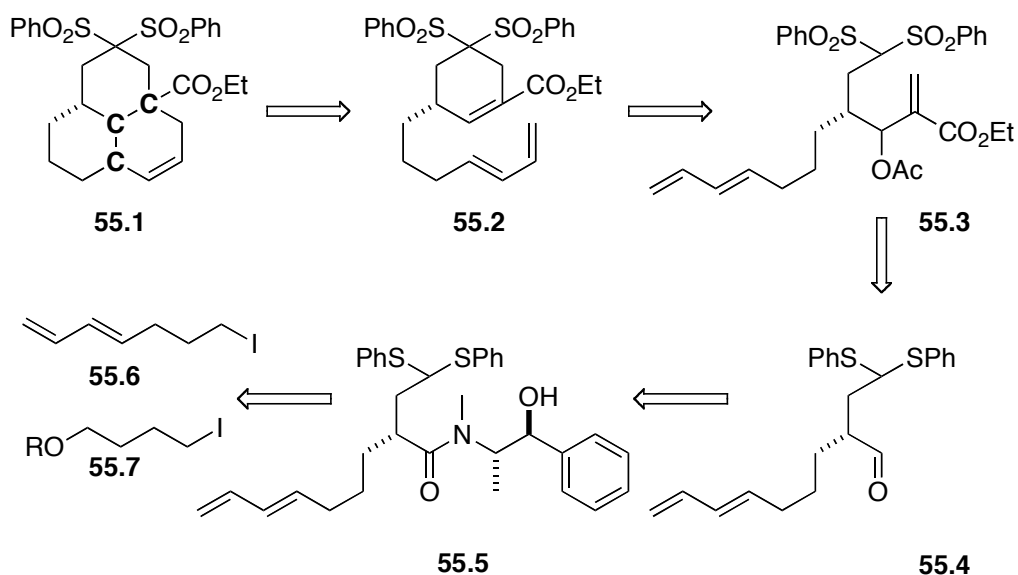

To standardize the alkylation reaction for our own amides, a control experiment was carried out using the alkyl iodide **56.2**,⁷² which Myers had previously used.^{65d}

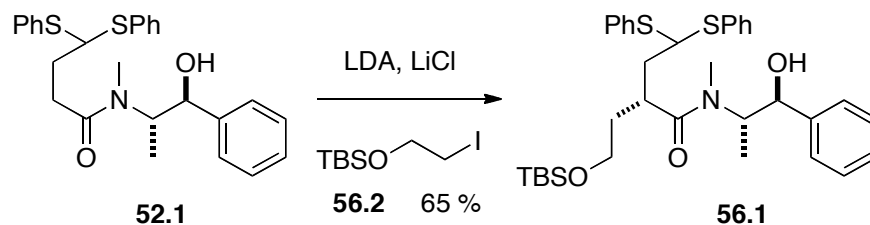

Scheme 56 *Model experiment for the Myers asymmetric alkylation*

Because Myers has described two procedures for alkylation, one where the amide is in excess, and one where the alkyl iodide is in excess, we wished to choose one set of conditions and carry out the reaction with the structure of our amides being the only variable. The preferred conditions were to have excess alkyl iodide, as these compounds could be prepared rather easily and recovered easily by chromatography. After several attempts using an excess of the iodide, the optimized yield for the reaction of Scheme 56 was 65% of a 5.9:1 ratio of rotamers, with a tentatively assigned *dr* of 9:1 as determined by ¹H NMR. Due to the complicated nature of the ¹H NMR spectra, Myers suggests diastereoisomeric ratios are best determined by capillary GC analysis. Direct measurement of the enantiomeric ratio can also be measured by preparation of Mosher esters following auxiliary removal. In any event, the standard conditions had been selected, and our pseudoephedrine amides could now be alkylated with the appropriate alkyl iodide.

The pendant chain we wished to use was similar to the one previously tested, with the exception of being four carbons in length rather than two. The

alkyl iodide **57.3** is easily prepared in one step from THF, NaI, and TBSCl,⁷³ and must be used fresh for the alkylation reaction to ensure high yields.

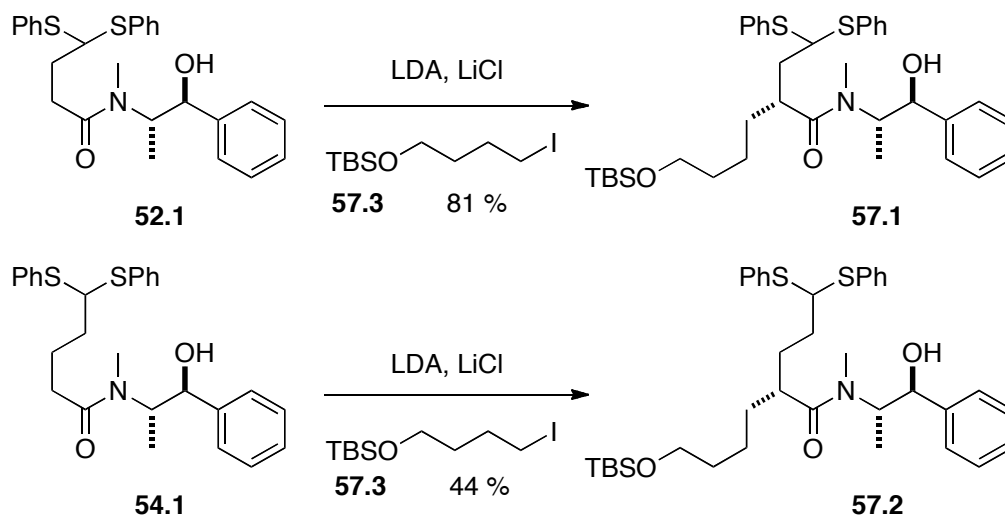

Scheme 57 *Myers asymmetric alkylation*

The alkylation of the six-membered ring series amide went smoothly, generating a 4.5:1 mixture of rotamers of **57.1** in 81% optimized yield. The diastereoisomeric ratio was assigned as being 9:1, but due to the complexity of the ¹H NMR spectrum caused by a mixture of rotamers and diastereoisomers, this value is tentative. The product was semi-solid and formed a white foam when under vacuum. Initial attempts to precipitate the material using toluene (as suggested by Myers) were carried out, but no solid could be isolated; other solvents besides toluene were not examined to precipitate the alkylated compound.

The seven-membered ring series amide was alkylated under the same conditions (compound **57.2**), but the process has not been optimized, and the highest yield to date is only 44 %. This alkylation still stands as the only one without an optimized yield, as another high yielding alkylation is reported in Section 2.2.8.

Compound **57.2** was a 5.5:1 ratio of rotamers and in this case the diastereoisomeric ratio could not be assigned due to the complexity of the spectrum; this material could also not be precipitated and therefore optically enriched.

With the desired alkylated material in hand, we wished to carry the material forward in an effort to generate the asymmetrically substituted six- and seven-membered rings, beginning with the removal of pseudoephedrine from the alkylated compounds.

2.2.5 Removal of the chiral auxiliary

The conditions that were used to remove the pseudoephedrine auxiliary were optimized using compound **56.1** (from Scheme 56) and the alkylated compound **55.5** from section 2.2.8, before being used on the alkylation products containing the TBS protected oxygen (compounds **57.1** and **57.2**).

The initial attempts to remove the auxiliary were based on Myers' conditions of amide hydrolysis to the corresponding acid, and were carried out on the alkylated compound **55.5** from section 2.2.8. Unfortunately, all of the attempted conditions produced only complex mixtures (Scheme 58) and this method was abandoned.

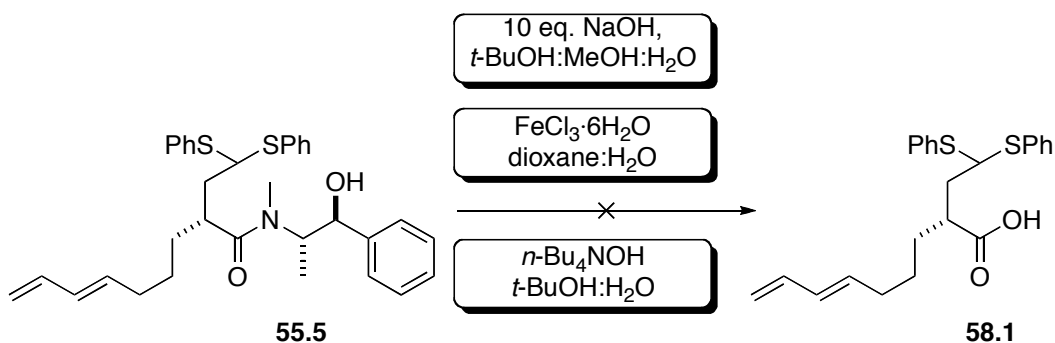

Scheme 58 *Attempted hydrolysis of the chiral auxiliary*

At this point we turned our attention to reductive removal of the auxiliary from the model alkylation compound (**56.1**), using a reagent Myers had developed for the reduction of pseudoephedrine amides to alcohols with minimal generation of the amine (a typical problem when reducing amides). By using borane-ammonia complex and treating it with LDA, lithium amidotrihydroborate (LAB) was generated,⁷⁴ and the pseudoephedrine could be removed effectively. The LAB reducing agent of Myers overcomes certain drawbacks of the lithium pyrrolidide-borane (LPT) reagent of Singaram⁷⁵ when it is used for the reduction of pseudoephedrine amides, such as base induced epimerization and decomposition of the intermediate aldehyde. We were able to successfully use

this reagent on the amide from the model experiment (compound **56.1** but in low yield), as well as in fully optimized form for those compounds alkylated with the TBS protected oxygen (**57.1** and **57.2** below) and on alkylated compound **55.5** of Section 2.2.8 (see Scheme 67).

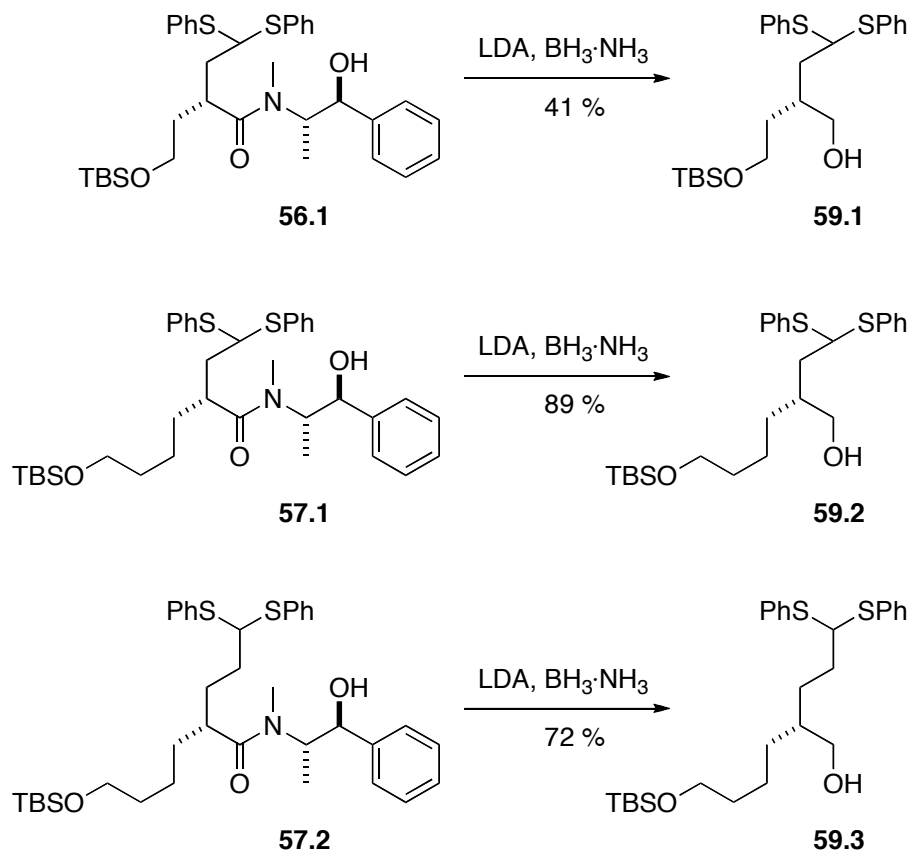

Scheme 59 Reductive removal of the chiral auxiliary using LAB

Both Mosher esters⁷⁶ of alcohol **59.1** were prepared in an effort to elucidate the optical purity of the compound (Scheme 60) by this method, but no obvious shifts were apparent in either the ^1H or the ^{19}F NMR spectra. Because the

Mosher ester method did not work, either here or for compound **55.5**, this method was not tried for alcohols **59.2** and **59.3**.

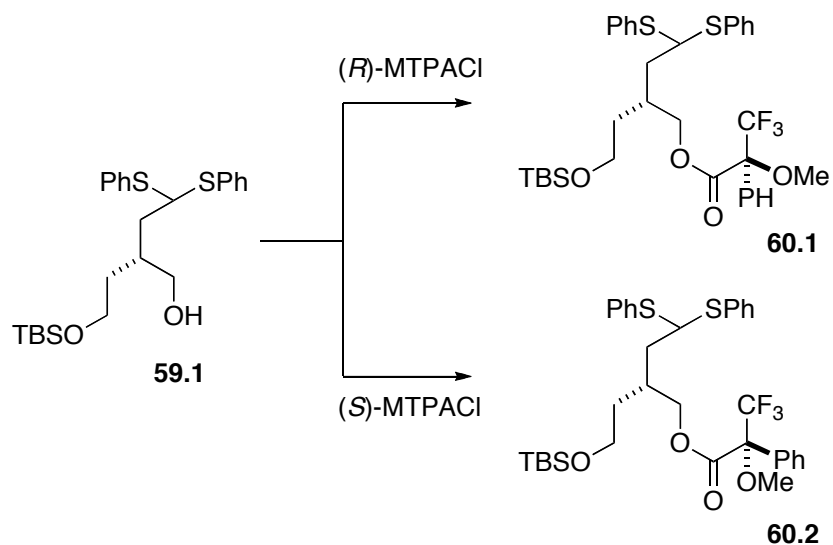

Because we could not recrystallize the alkylation products to obtain diastereoisomerically pure compounds, the products after removal of the auxiliaries cannot be 100% optically pure; however, they are still useful to explore the subsequent reactions, because the conditions collected from these experiments should be applicable to optically pure material in subsequent work.

With this in mind, the next step was to oxidize the alcohols **59.2** and **59.3**; they would be subsequently derivatized and used in ICD reactions by methods described by this group.⁵⁶

2.2.6 *Oxidation of alcohols and avoidance of epimerization*

Because the oxidation of the alcohols would produce aldehydes that could undergo epimerization, it was important to keep track of the optical purity. This was done by oxidizing the alcohol to the aldehyde, followed by its subsequent reduction back to the alcohol and recording of the $[\alpha]_D^{25}$. A comparison of the two specific rotations would provide evidence of epimerization if it occurred. We relied on this method as we do not have access to chiral HPLC.

The reagent used to oxidize the alcohol to the aldehyde was PCC (Scheme 61); it was chosen because of the simple workup procedure. All basic oxidations were ignored, as it is possible that epimerization could occur α to the newly formed carbonyl. Although PCC is not well known for causing α epimerization, we monitored the optical rotation of the compounds involved in the reaction to be thorough.

The oxidation proceeded smoothly, however there was a competitive desilylation reaction and the reaction time needed to be controlled. In the six-membered ring series, there appeared to be no epimerization, and the method was applied to the seven-membered ring series. Because the $[\alpha]_D^{25}$ values do not match in this case, it is possible that some epimerization has occurred, though this is a tentative conclusion, as the method of optical rotation is not exact.

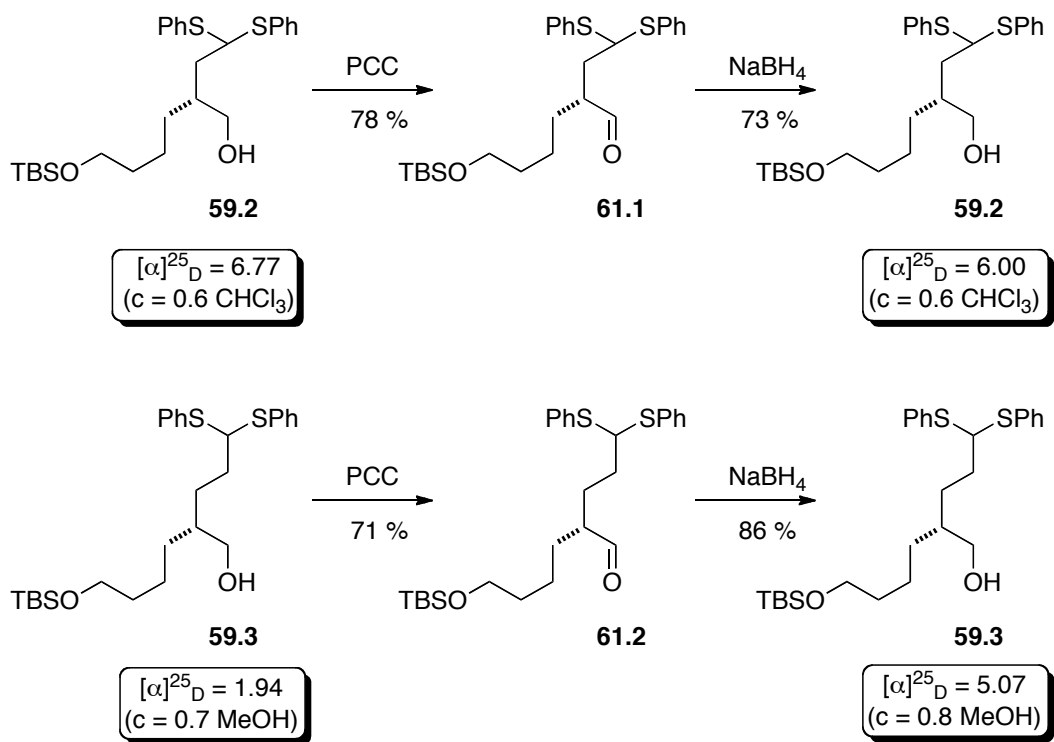

Scheme 61 *Monitoring of optical purity following oxidation*

With the aldehydes in hand, we could now complete the synthesis of the asymmetrically substituted rings.

2.2.7 ICD ring closure to form asymmetrically substituted rings

To prepare the ICD precursor, a Morita-Baylis-Hillman alcohol was generated from selenide **36.1**⁶¹ by the indirect method previously described,⁶⁰ followed by treatment with *m*-CPBA to form the allylic alcohol, as well as simultaneously removing the silyl protecting group (Scheme 62) and oxidizing the sulfur atoms.

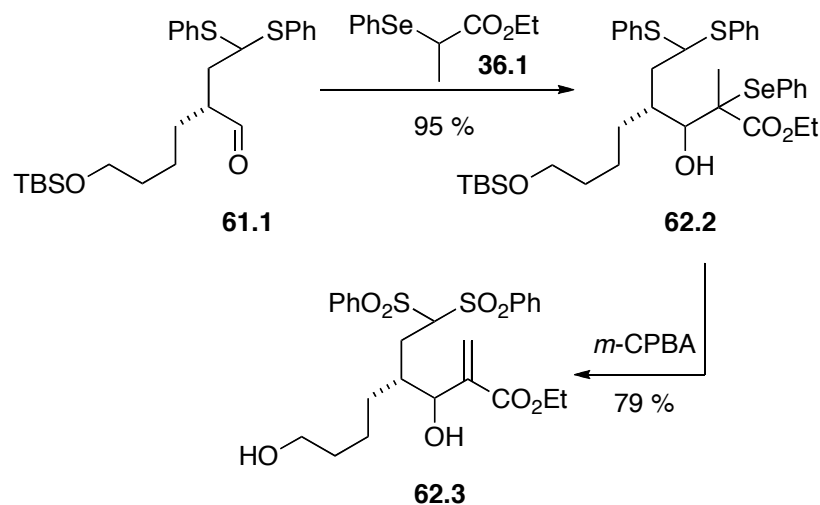

Scheme 62 Indirect preparation of allylic alcohols

Although it is not surprising that the silyl group was removed under the acidic conditions of *m*-CPBA oxidation, the desilylation was not a significant problem. Following double acetylation, no competitive displacement of the primary *O*-acetate was seen when the ICD was carried out using our optimized conditions of Cs_2CO_3 in THF (Scheme 63), and the desired six-membered ring was generated in high yield.

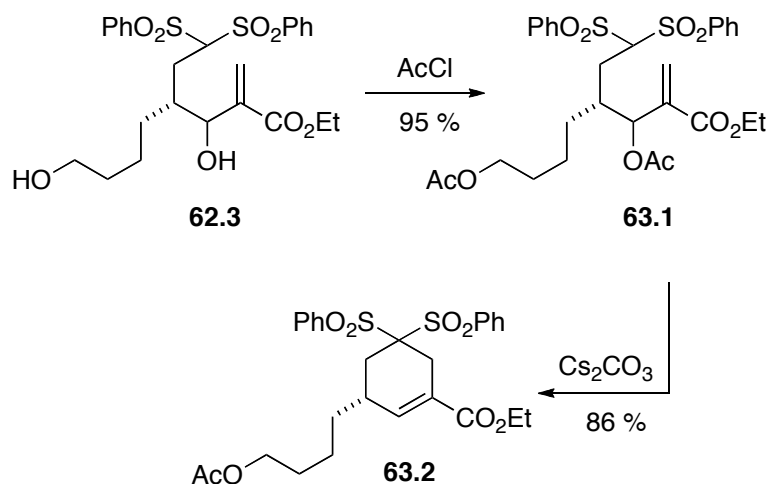

Scheme 63 Formation of the asymmetrically substituted six-membered ring

At this point, with the successful application of the ICD reaction, we now had a pathway to asymmetrically substituted six-membered rings without the use of a Diels-Alder reaction. Under the exact same conditions, the asymmetrically substituted seven-membered ring could also be generated (Scheme 64). The only difference between the two pathways was the use of a methyl ester instead of an ethyl ester in the selenide nucleophile (**64.2**), in order to simplify the ^1H and ^{13}C NMR spectra.

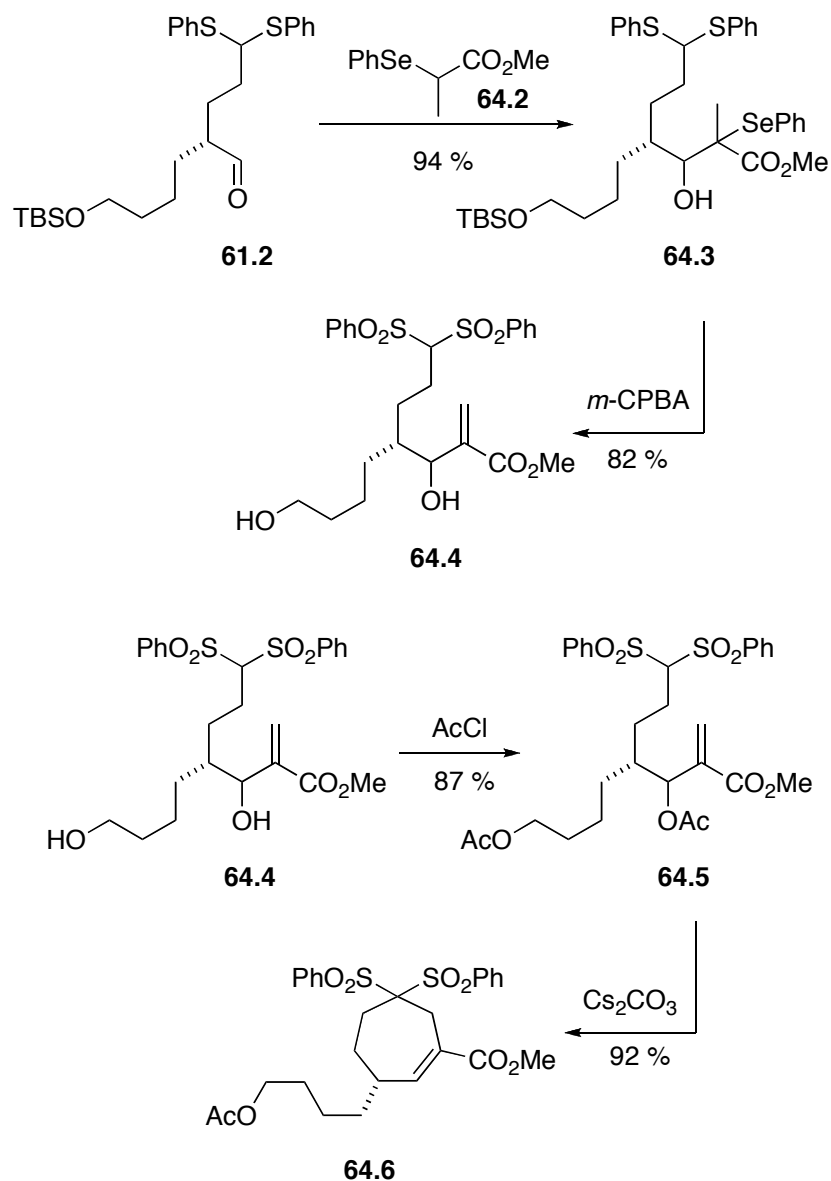

Scheme 64 Formation of the asymmetrically substituted seven-membered ring

At this point, we now had a pathway for generating asymmetrically substituted carbocycles as precursors for organic synthesis, and we now wished to use these compounds for the production of more complex systems, using the stereochemically defined pendant chain. However, before discussing those experiments, we wanted to first deal with efforts to install a diene unit by the

alkylation of a Myers amide, as such dienes would make it possible to investigate a tandem ICD-Diels Alder reaction.

2.2.8 The ICD-Diels-Alder pathway

The initial goal of this pathway was to generate the Diels-Alder precursor **55.2** with the diene already in place before the ICD process, so that following the ICD ring closure, a Diels-Alder cycloaddition could be immediately carried out to generate compound **55.1**. The hope was that the sequence **55.3** → **55.1** could be done without isolation of **55.2**.

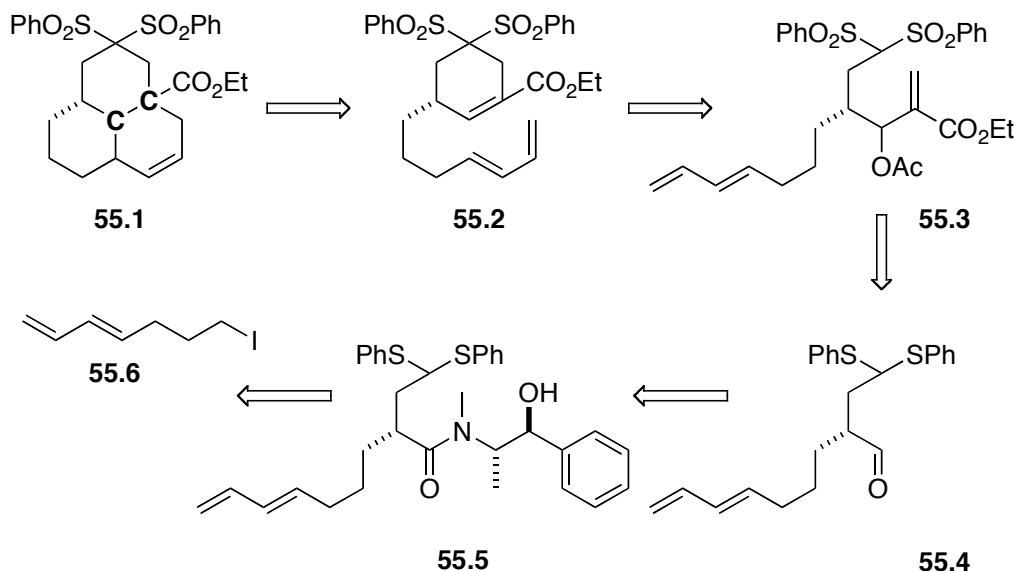

Scheme 65 Retrosynthesis of a tricyclic compound

To investigate this pathway, alkylation using alkyl iodide **55.6** would need to be carried out under the Myers conditions. The first step was therefore to make

the alkyl iodide; this is a known compound, which was prepared by the method summarized in Scheme 66.

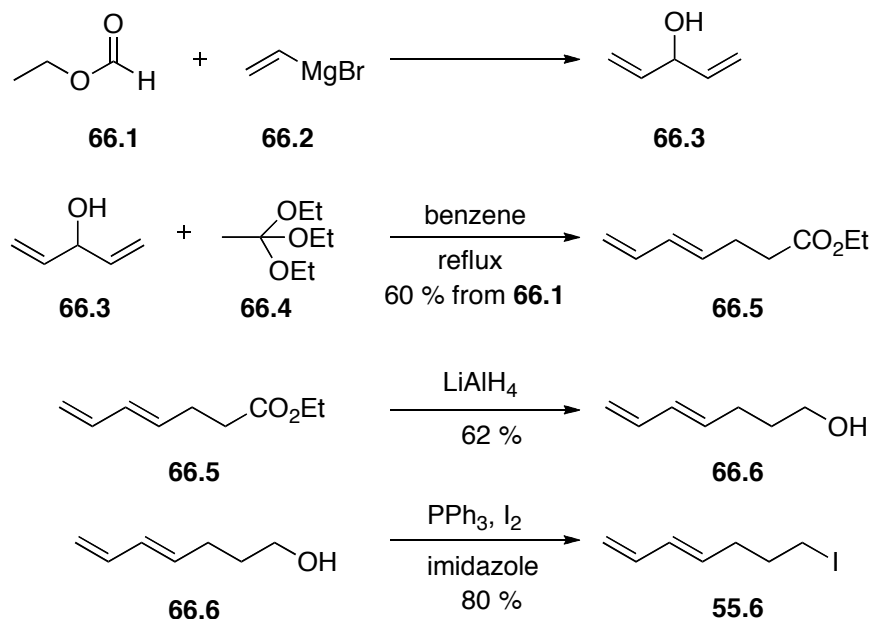

Scheme 66 Preparation of diene containing alkyl iodide

Condensation of ethyl formate with vinyl magnesium bromide generated the divinyl alcohol **66.3**, which was immediately used for a Johnson-Claisen rearrangement in the presence of triethyl orthoacetate to form the ethyl ester **66.5**.⁷⁷ Simple reduction of the ester with LiAlH_4 ,⁷⁸ followed by conversion of the resulting alcohol (**66.6**) to the alkyl iodide **55.6**,⁷⁹ provided the desired compound, which could now be used for the alkylation of our pseudoephedrine amide **52.1**.

The alkylation worked very well, generating the product in 90% optimized yield, as a mixture of rotamers. Unfortunately, the diastereoisomeric ratio could

not be determined by ^1H NMR, as the spectrum was too complicated to interpret due to the presence of rotamers and diastereoisomers.

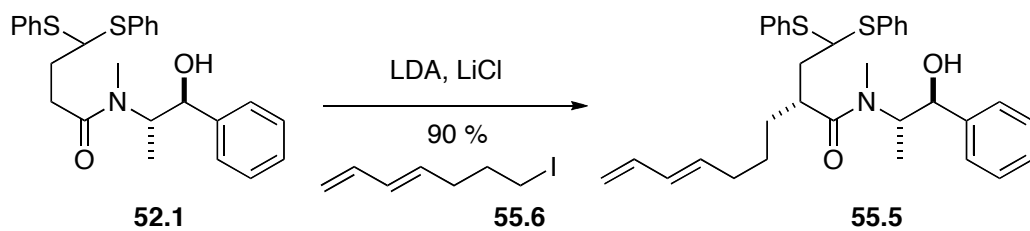

Scheme 67 *Alkylation using freshly prepared alkyl iodide*

Removal of the auxiliary proceeded smoothly, but in this case, a higher temperature (60 °C) was required for Myers' LAB reagent to reduce the amide functionality (Scheme 68). Mosher esters⁷⁶ were then prepared from the alcohol **68.1**, but no obvious shifts were detectable in either the ^1H or ^{19}F NMR spectra of the two esters, and so an assessment of the enantiomeric ratio could not be made.

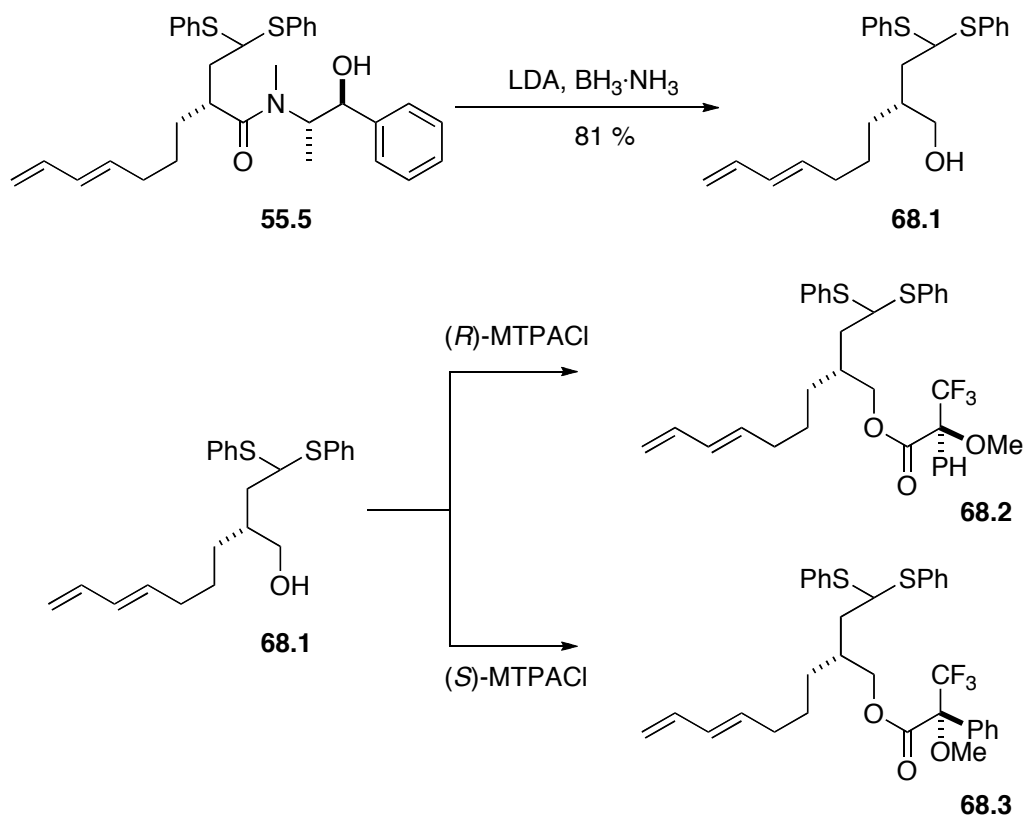

Scheme 68 Preparation of Mosher esters

Despite this, the pathway was carried forward in order to determine the viability of the entire sequence. Therefore, alcohol **68.1** was oxidized to the corresponding aldehyde using PCC. The aldehyde was then condensed with selenide **36.1**, and the hope was that following this reaction, a global oxidation could be carried out without affecting the diene (Scheme 69).

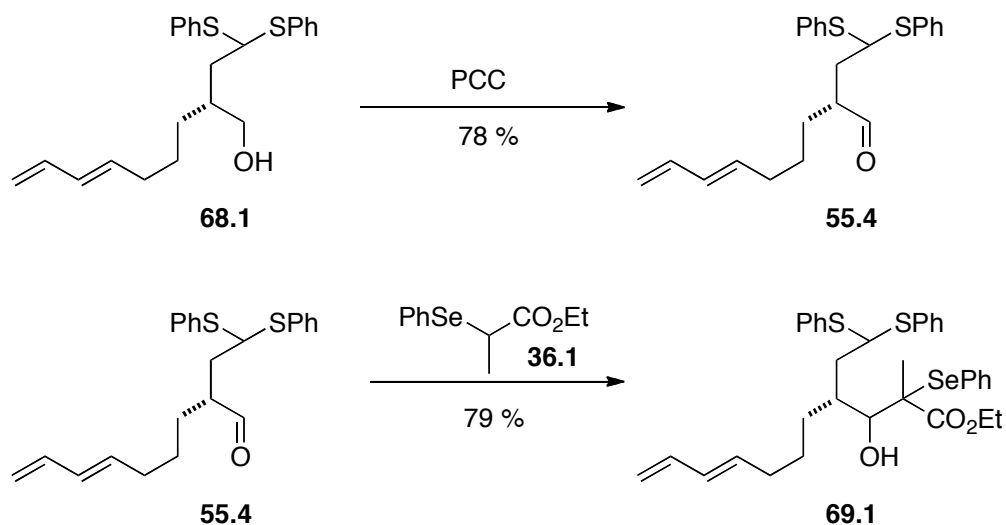

Scheme 69 Preparation of allylic alcohol precursor

m-CPBA was not an appropriate reagent because of the presence of the double bonds, and so we set out to use hydrogen peroxide instead. When the reaction was tried at room temperature, it was obvious that the selenium was being oxidized, but no sulfur oxidation was occurring (as monitored by TLC). When the reaction mixture was heated, only a complex mixture was recovered (Scheme 70). Another attempt using TPAP/NMO was also carried out,⁸⁰ but it appears that only the selenium was oxidized, as by TLC there is no sign of an extremely polar compound, which is expected for the disulfone. We were aware of the possibility that the oxidizing agent could convert the secondary alcohol to a ketone but proceeded anyway.

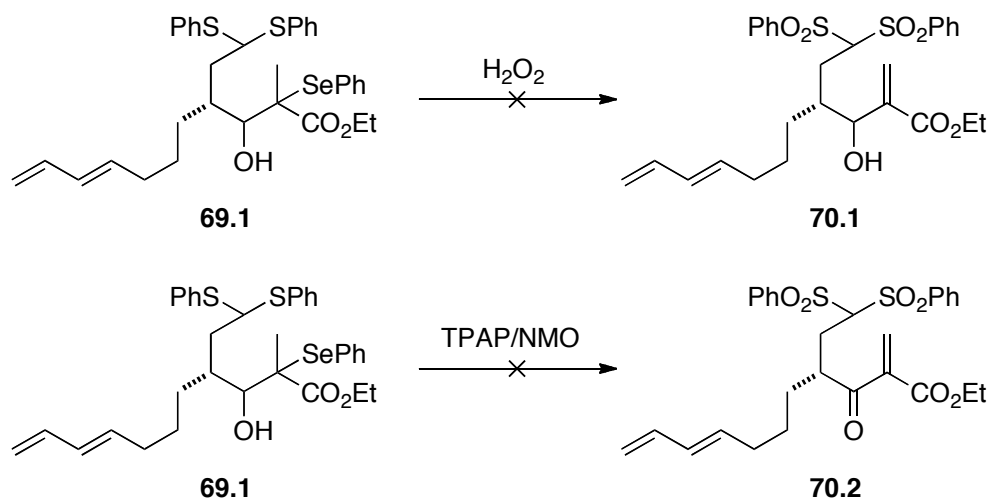

Scheme 70 *Attempted preparation of allylic alcohols*

We also tried to carry out a global oxidation using sodium periodate, although this oxidant typically does not oxidize sulfur all the way to the sulfone level. However, only the allylic alcohol (from selenoxide fragmentation) was recovered in 50% yield (**71.1**), with no sign of the totally oxidized compound (Scheme 71); some of this alcohol (see below) was then converted to acetate **71.2**.

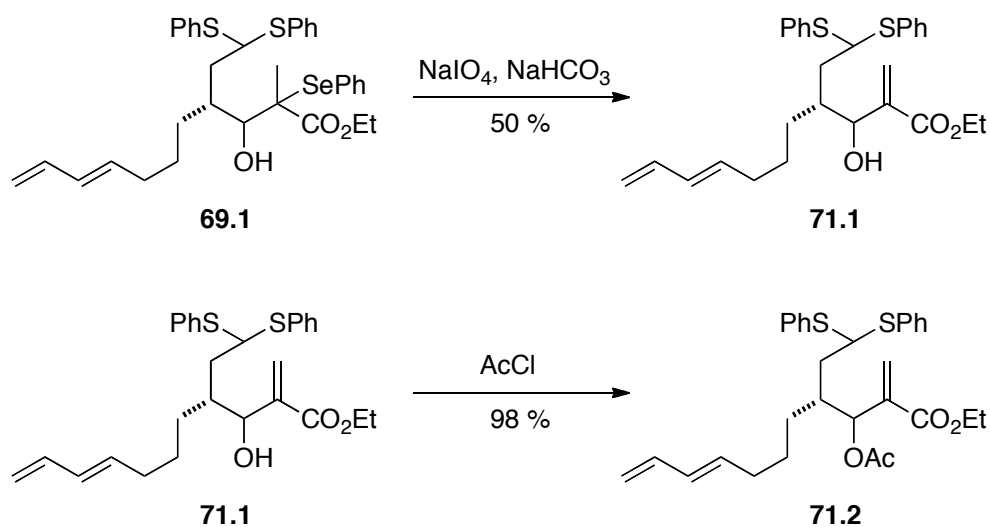

Scheme 71 *Preparation of the allylic alcohol and its subsequent acetylation*

As we could generate the allylic alcohol, we decided to carry out the oxidation in a stepwise manner, oxidizing the selenium first, followed by the sulfur atoms. We attempted several oxidations on these two compounds (**71.1** and **71.2**) in an effort to produce the sulfones without disturbing the diene. Unfortunately, many of the conditions that we tried gave complex mixtures. The main set of conditions we focused on was the use of ammonium heptamolybdate in combination with hydrogen peroxide,⁸¹ which was most promising since it at least did not give complex mixtures as judged by the ¹H NMR spectrum on the crude reaction product.

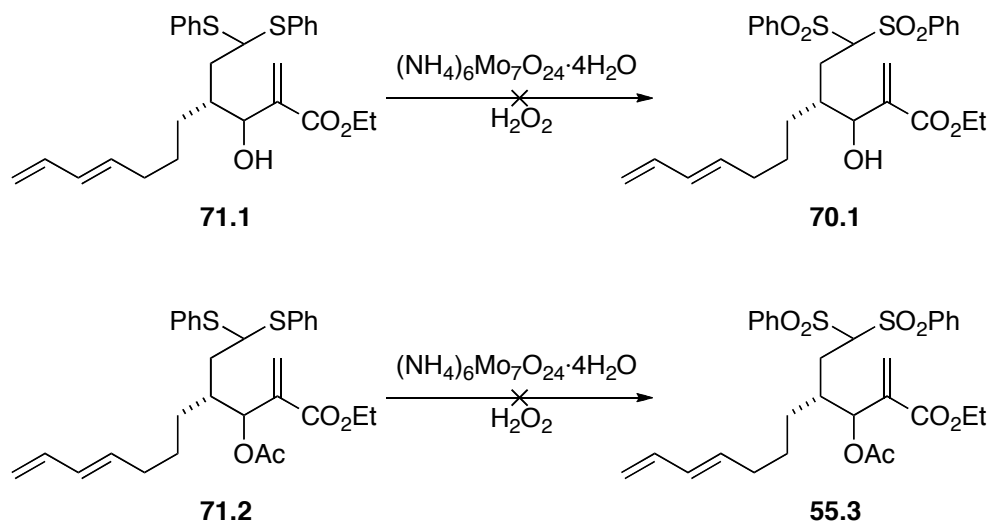

Scheme 72 *Attempted oxidation of sulfur*

Different reaction times, solvents and temperatures were used under these conditions, but the desired molecular ion could not be detected by mass spectrometry, nor did it appear from TLC that a polar compound (as expected for a sulfone) was forming. Attempts were carried out to oxidize the acetate **71.2**

using periodic acid/chromium trioxide,⁸² but only a complex mixture was recovered from this reaction.

Although disappointed that this pathway has not been developed thus far due to the complications with sulfur oxidation, we feel that the matter is worth revisiting since there is literature precedent for use of H₂O₂/catalyst in the presence of isolated double bonds.⁸³ At this point we decided to carry our newly formed, asymmetrically substituted carbocycles forward, and attempt to elaborate them into more complex structures.

2.2.9 *Elaboration of asymmetric intermediates*

We decided to elaborate the six-membered series first for two reasons: The first being that this system could be converted to the core structure of the amphilectane-like diterpenoids (naturally occurring compounds), and the second, the Diels-Alder reaction that would be required to make these compounds has a close analogy in the literature.⁷¹ Any conditions established in this case could then be applied to the seven-membered ICD series, as well as to other systems that have a different pendant chain length.

The initial goal was to establish the conditions needed for a successful Diels-Alder cycloaddition. To this end, the pendant chain would have to be modified to incorporate a diene unit.

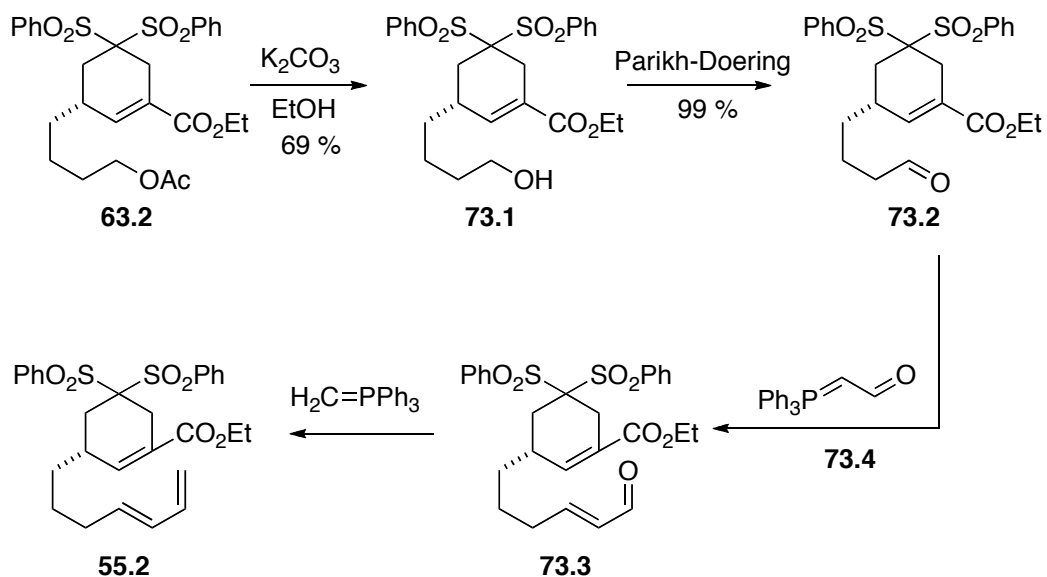

Scheme 73 Preparation of the Diels-Alder precursor

The chain of **63.2** was extended by hydrolyzing the acetate and oxidizing the resulting alcohol under Parikh-Doering conditions (**63.2** \rightarrow **73.2**). Wittig homologation of aldehyde **73.2** using the ylide **73.4**,⁸⁴ gave the α,β -unsaturated aldehyde **73.3**, exclusively as the *E*-isomer. A second Wittig reaction was then carried out to generate the Diels-Alder precursor **55.2**.

Several efforts were made to close the ring system (see Scheme 74), including simple heating (120 °C), as well as heating in the presence of a Lewis acid [$\text{Yb}(\text{OTf})_3$]; at this point, in each experiment no desired product was recovered and no starting material remained. The NMR spectrum of the crude reaction product did show the ring double bond hydrogen, as well as a change in the signals for the initial diene hydrogens had occurred, suggesting that an isomerization had occurred. More material needs to be generated in order to

screen all available conditions, including Lewis acid catalysis in order to lower the temperature of the reaction and avoid any the changes to the diene. When this new material is produced, electron donating groups (-OMe and -CH₃) will be included at the diene terminus in order to promote the reaction (the methyl fortuitously appears in some diterpenoid compounds).^{71b}

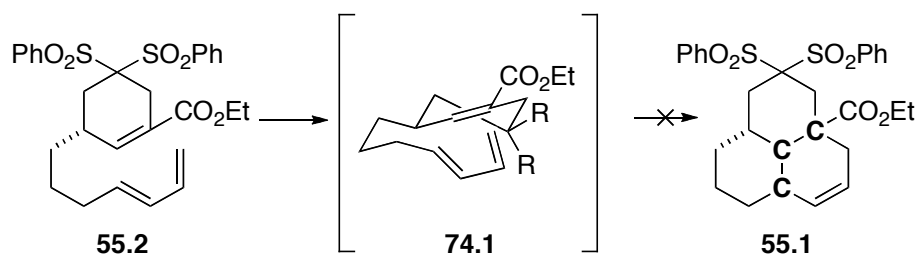

Scheme 74 *Proposed endo transition state of the desired Diels-Alder cycloaddition*

Two intermolecular Diels-Alder reactions (Scheme 75) were also tried to investigate the effect of the pendant chain on directing the stereochemistry, but in these cases only starting material was recovered. In each case, only heating was used, and Lewis acid catalysis will again need to be explored.

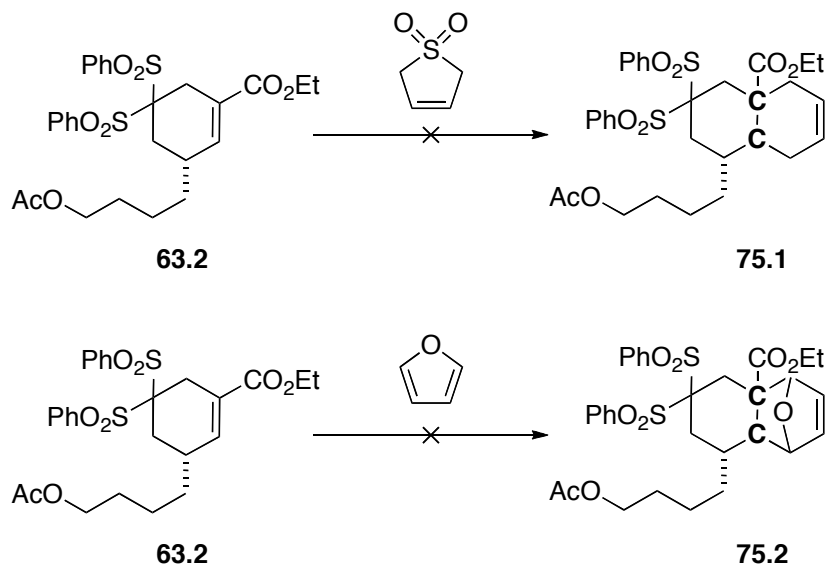

Scheme 75 *Attempted intermolecular Diels-Alder reactions*

At this point, further work is needed in order to identify the conditions for a successful Diels-Alder cyclization, so that ICD products can be elaborated into the desired (more complex) structures.

An effort to carry out a photochemical [2 + 2] cycloaddition was also made, with the material being prepared by taking aldehyde **73.2** and carrying out a Wittig homologation to generate the olefin **76.1**. This compound was then exposed to UV light, but unfortunately the desired product was not isolated, and

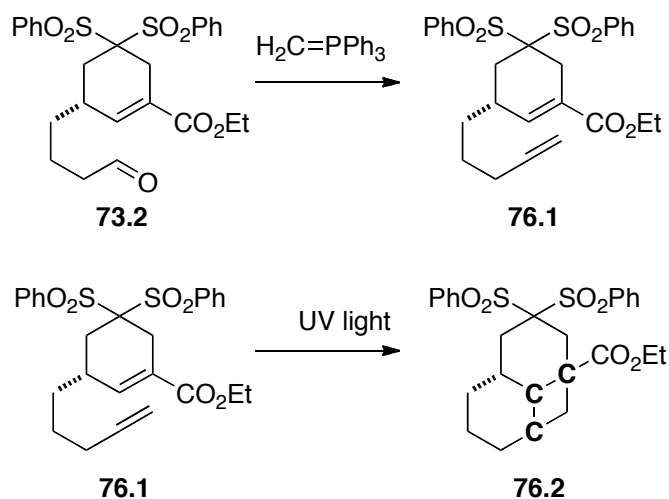

Scheme 76 *Attempted photochemical [2 + 2]*

although the ring double bond signal is still present, the original starting material was not recovered by preparative TLC. It appears that the photochemical reaction does not work, and a formal [2 + 2] cycloaddition via Lewis acid activation of the α,β -unsaturated ester may be required (the planned future application of this methodology is shown in Scheme 77).⁸⁵

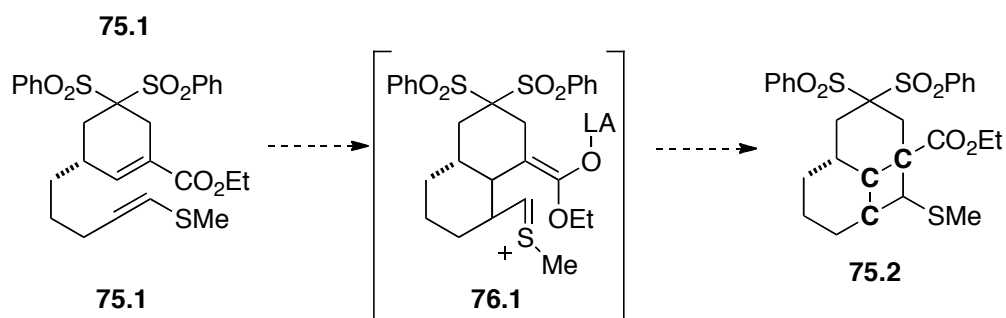

Scheme 77 *Lewis acid catalyzed "formal" [2 + 2] cyclizations*

2.3 Conclusions

One of the main goals of this research was to introduce a pendant chain in an asymmetric fashion that could be used to react with the residual α,β -unsaturated ester generated in our ICD reaction. At present, the chain has been introduced, but the optical purity of the alkylated product is not acceptable.

To improve the optical purity, several choices are at our disposal. The first is to continue to use the Myers asymmetric alkylation, but the semi-solid alkylation products must be crystallized. With these crystals in hand, a recrystallization can be carried out and the optical purity can be increased. We can also change to the Evans chiral auxiliaries introduced in Section 2.2.2. The Evans alkylation typically delivers high *dr* without the requirement of optical enrichment, and this seems to be the best option because there are many examples in the literature that display its utility.⁸⁶

The other goal of this research, following production of asymmetrically substituted ICD rings, was their elaboration to more complex structures. The initial structure we attempted to target was the amphilectane-like diterpenoid core structure **55.1** (Scheme 78) via a Diels-Alder reaction. We have established that generating this compound thermally is not possible. Therefore, new material must be brought up (with a higher optical purity via the methods described previously), and a series of Lewis acid catalysts screened, based on information in the literature for these kinds of cycloadditions.⁷¹

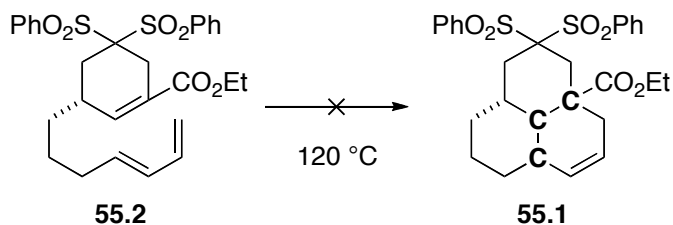

Scheme 78 *Attempted Diels-Alder generation of the amphilectane-like diterpenoid core structure*

As mentioned in Section 2.2.9, the addition of an electron donating group (Scheme 79) (-OMe or CH₃) to the terminus of the diene may improve the chances of a successful reaction (the methyl also happens to be present in several diterpenoid compounds).

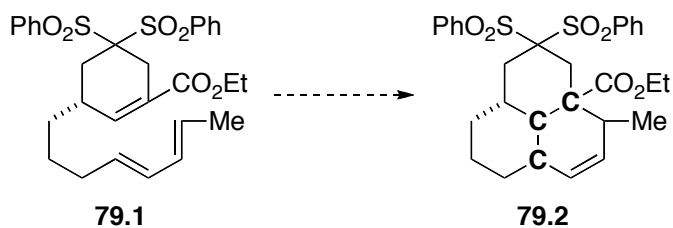

Scheme 79 *Electron donating group in the Diels-Alder reaction*

The photochemical [2 + 2] cycloaddition that was attempted did not provide the desired material. However, as mentioned in Section 2.2.9, a formal, Lewis acid activated cyclization⁸³ may be a viable alternative to generate the desired product (as was shown in Scheme 77).

Although no attempt at heterocycle formation (as in Scheme 33) has been carried out, that too is another area to be explored, as both oxygen (producing the benzopyran core **33.4**) and nitrogen (producing the decahydroquinoline core **33.2**) can carry out Michael additions onto the α,β -unsaturated subunits of the ICD ring systems, as shown in the introduction and reproduced in Scheme 81.

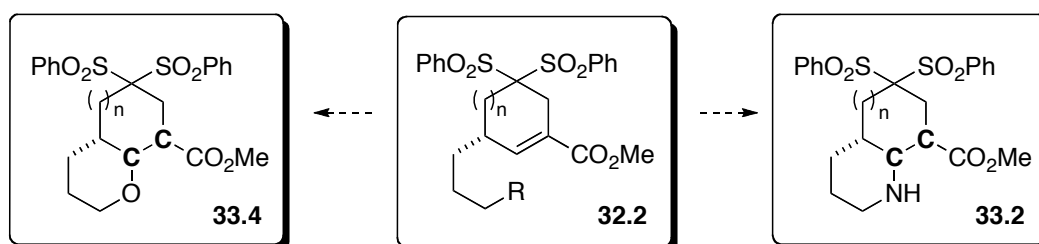

Scheme 80 *Conjugate addition in the formation of the benzopyran and decahydroquinoline core structures*

Much work remains to be done for us to realize our ambition of contributing to the previously described field of carbocycle formation.

3. EXPERIMENTAL

Unless stated to the contrary, the following conditions apply: Reactions were carried out under a slight static pressure of Ar or N₂ that had been purified by passage through a column (3.5 x 42 cm) of R-311 catalyst and then through a similar column of Drierite. All solvents for reactions were dried, as described below. Glassware was dried in an oven (140 °C) for at least 3 h before use and either cooled in a desiccator over Drierite, or assembled quickly, sealed with rubber septa, and allowed to cool under a slight static pressure of Ar or N₂. Reaction mixtures were stirred by Teflon-coated magnetic stirring bars.

Hexane and ethyl acetate used for chromatography were distilled before use.

Products were isolated from solution by evaporation under water aspirator vacuum at, or below, room temperature, using a rotary evaporator.

Microliter syringes were washed with water and acetone, using a suction device to draw the solvents through. Air was then drawn through for 1 min and the syringe was stored under vacuum. The solution to be dispensed was drawn up and expelled, and this operation was repeated several times before drawing up the sample to be used. Cannula transfers were always done under slight pressure (Ar or N₂), not by suction. Dropwise additions were done at such a rate that there was ca. 0.5-1 second between each successive drop.

Commercial thin layer chromatography (TLC) plates (silica gel, Merck 60F-254) were used. Spots were detected by spraying the plate with a solution of phosphomolybdic acid or permanganate stain,⁸⁷ followed by charring with a heat

gun, or by examination under UV light. Silica gel for flash chromatography was Merck type 60 (230-400 mesh).

Dry solvents were prepared under an inert atmosphere and transferred by syringe or cannula. Dry THF, Et₂O, PhH, and PhMe were distilled from sodium and benzophenone ketyl. Dry CH₂Cl₂, Et₃N, *i*-Pr₂NEt and pyridine were distilled from CaH₂. Dry MeOH or EtOH was distilled from Mg(OMe)₂ or Mg(OEt)₂, respectively. FT-IR measurements were made from the specified solvent using KBr plates.

The symbols s, d, t, and q used for ¹³C NMR signals indicate 0, 1, 2, or 3 attached hydrogens, respectively, as based on the APT experiment and are applied when applicable.

The absolute stereochemistry of asymmetric alkylations are based on the stereochemical models proposed by Myers.^{65d}

Mass spectra were recorded with Agilent Technologies 6220 Accurate-Mass TOF LC/MS, Perseptive Biosystems Mariner Biospectrometry Workstation, Kratos MS50 or Micromass ZabSpec Hybrid Sector-TOF mass spectrometers.

Compounds isolated by flash chromatography were pure by TLC and, unless otherwise stated, also as judged by high field ¹H and ¹³C NMR spectra.

Optical rotation measurements were taken on a Perkin Elmer 241 Polarimeter (units for specific rotation [α_D] are deg dm⁻¹ cm³ g⁻¹ but the literature uses just degrees). The sodium D-line (589 nm) was the wavelength of choice.

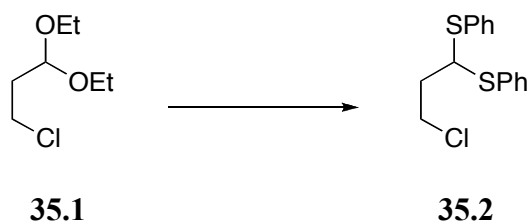
[[3-Chloro-1-(phenylsulfanyl)propyl]sulfanyl]benzene (**35.2**).⁵⁶

PhSH (11.1 mL, 0.11 mol), followed by CF₃CO₂H (6.93 mL, 0.09 mol), was added to a stirred solution of freshly distilled **35.1** (3.00 g, 0.018 mol) in dry CH₂Cl₂ (45 mL), and stirring was continued for 2 days at room temperature. The reaction was quenched by slow addition of 10% aqueous NaOH and the mixture partitioned between CHCl₃ and water. The aqueous layer was extracted with CHCl₃, and the combined organic extracts were washed three times with 10% aqueous NaOH, then brine, dried (MgSO₄), and evaporated. Flash chromatography of the residue over silica gel (4 x 15 cm), using 2% EtOAc-hexanes, gave **35.2** (5.17 g, 97%) as a clear oil: FTIR (neat film) 3073 cm⁻¹; ¹H NMR (CDCl₃, 400 MHz) δ 2.29 (q, *J* = 6.3 Hz, 2 H), 3.81 (t, *J* = 6.3 Hz, 2 H), 4.63 (t, *J* = 7.1 Hz, 1 H), 7.30-7.38 (m, 6 H), 7.50-7.71 (m, 4 H); ¹³C NMR (CDCl₃, 100 MHz) δ 38.3 (t), 42.1 (t), 55.3 (d), 128.1 (d), 129.1 (d), 133.0 (d), 133.4 (s); exact mass (electron impact) *m/z* calcd for C₁₅H₁₅³⁵ClS₂ 294.0304, found 294.0302.

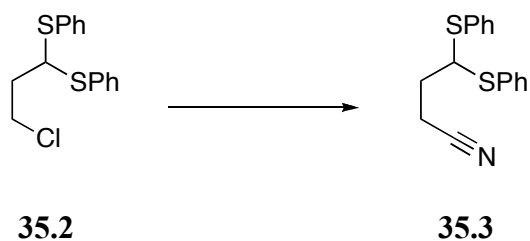
4,4-Bis(phenylsulfanyl)butanenitrile (35.3).⁵⁶

n-Bu₄NI (0.647 g, 1.75 mmol), followed by NaCN (4.29 g, 0.088 mol), was added to a stirred solution of **35.2** (5.165 g, 0.018 mol) in dry DMSO (80 mL). The reaction mixture was stirred overnight at 50 °C, cooled to room temperature, diluted with water (100 mL) and extracted three times with Et₂O. The combined organic extracts were washed with water and brine, dried (MgSO₄), and evaporated. Flash chromatography of the residue over silica gel (4 x 15 cm), using first hexanes, and then a gradient elution of 4%, 6%...10% EtOAc-hexanes, gave **35.3** (4.58 g, 92%) as a clear oil: FTIR (neat film) 3073, 2248 cm⁻¹; ¹H NMR (CDCl₃, 500 MHz) δ 2.15 (app. q, *J* = 7.1 Hz, 2 H), 2.68 (t, *J* = 7.2 Hz, 2 H), 4.46 (t, *J* = 6.9 Hz, 1 H), 7.32-7.38 (m, 6 H), 7.48-7.52 (m, 4 H); ¹³C NMR (CDCl₃, 125 MHz) δ 15.2 (t), 31.2 (t), 56.9 (d), 118.7 (s), 128.5 (d), 129.2 (d), 132.7 (s), 133.3 (s); exact mass (electron impact) *m/z* calcd for C₁₆H₁₅NS₂ 285.0646, found 285.0646.

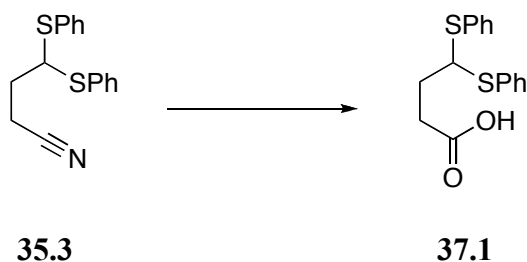
4,4-Bis(phenylsulfanyl)butanoic acid (37.1).

NaOH (50% w/v solution, 0.1 mL, 1.1 mmol) was added to a stirred solution of **35.3** (0.121 g, 4.22 mmol) in EtOH (95%, 1 mL). The mixture was stirred overnight at 60 °C, cooled to room temperature, acidified with concentrated H₂SO₄ and extracted twice with EtOAc. The combined organic extracts were extracted twice with saturated aqueous NaHCO₃. The combined aqueous extracts were acidified with concentrated hydrochloric acid, and extracted twice with EtOAc. The combined organic extracts were washed with brine, dried (MgSO₄), and evaporated to give **37.1** (0.032 g, 23%) as a white solid: mp 73-76 °C; FTIR (film cast) 3400-3000, 1708 cm⁻¹; ¹H NMR (CDCl₃, 300 MHz) δ 2.22 (q, *J* = 7.2 Hz, 2 H), 2.78 (t, *J* = 7.2 Hz, 2 H), 4.54 (t, *J* = 6.8 Hz, 1 H), 7.30-7.40 (m, 6 H), 7.50-7.56 (m, 4 H), OH signal missing; ¹³C NMR (CDCl₃, 100 MHz) δ 30.5 (t), 31.2 (t), 57.3 (d), 128.0 (d), 129.0 (d), 132.9 (d), 133.7 (s), 178.5 (s); exact mass (electron impact) *m/z* calcd for C₁₆H₁₆O₂S₂ 304.0592, found 304.0590.

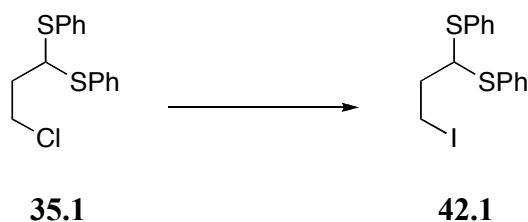
[[3-Iodo-1-(phenylsulfanyl)propyl]sulfanyl]benzene (**42.1**).

NaI (8.77 g, 0.058 mol) was added to a stirred solution of **35.1** (3.45 g, 0.012 mol) in dry acetone (100 mL). The mixture was refluxed overnight, cooled to room temperature and quenched with saturated aqueous $\text{Na}_2\text{S}_2\text{O}_3$. The mixture was extracted twice with EtOAc, and the combined organic extracts were washed with saturated aqueous $\text{Na}_2\text{S}_2\text{O}_3$ and brine, dried (MgSO_4), and evaporated. Flash chromatography of the residue over silica gel (4 x 15 cm), using first hexanes, and then a gradient elution of 0%, 1%, 2%, 3% EtOAc-hexanes, gave **42.1** (4.18 g, 92%) as a clear oil: FTIR (neat film) 3072 cm^{-1} ; $^1\text{H NMR}$ (CDCl_3 , 500 MHz) δ 2.50 (q, $J = 6.9\text{ Hz}$, 2 H), 3.42 (t, $J = 6.9\text{ Hz}$, 2 H), 4.55 (t, $J = 7.1\text{ Hz}$, 1 H), 7.30-7.38 (m, 6 H), 7.50-7.54 (m, 4 H); $^{13}\text{C NMR}$ (CDCl_3 , 125 MHz) δ 3.3 (t), 38.8 (t), 58.9 (d), 128.1 (d), 129.1 (d), 133.2 (d), 133.3 (s); exact mass (electron impact) m/z calcd for $\text{C}_{15}\text{H}_{15}\text{IS}_2$ 385.9660, found 385.9557.

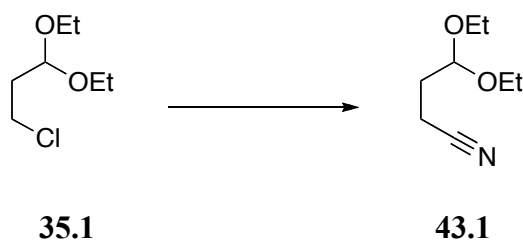
4,4-Diethoxybutanenitrile (43.1).⁵⁶

Bu₄NI (0.776 g, 2.10 mmol), followed by NaCN (5.15 g, 0.11 mol), was added to a stirred solution of **35.1** (3.50 g, 0.021 mol) in dry DMSO (80 mL). The mixture was stirred overnight at 50 °C, cooled to room temperature, diluted with water (100 mL) and extracted twice with Et₂O. The combined organic extracts were washed with water and brine, dried (MgSO₄), and evaporated to give **43.1** (2.75 g, 83%) as a golden oil: FTIR (neat film) 2247 cm⁻¹; ¹H NMR (CDCl₃, 300 MHz) δ 1.20 (t, *J* = 7.0 Hz, 6 H), 1.91 (td, *J* = 7.1, 5.3 Hz, 2 H), 2.41 (t, *J* = 7.5 Hz, 2 H), 3.50 (dq, *J* = 9.4, 7.0 Hz, 2 H), 3.65 (dq, *J* = 9.3, 7.0 Hz, 2 H), 4.58 (t, *J* = 5.3 Hz, 1 H); ¹³C NMR (CDCl₃, 100 MHz) δ 12.5 (t), 15.2 (q), 29.6 (t), 62.3 (t), 100.8 (d), 119.5 (s); exact mass (electrospray) *m/z* calcd for C₈H₁₅NNaO₂ 180.0995, found 180.0993.

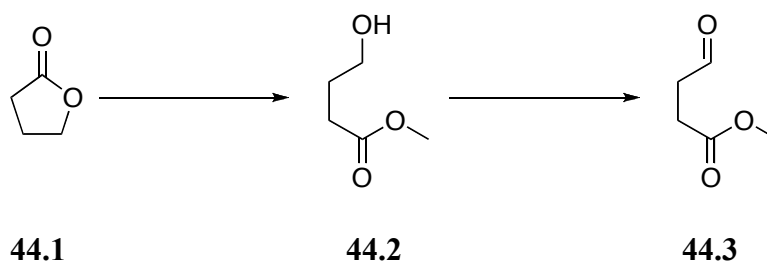
Methyl 4-oxobutanoate (44.3).

Amberlyst-15 resin (0.600 g) was added to a solution of γ -butyrolactone (**44.1**) (4.00 g, 0.046 mol) in dry MeOH (60 mL) and the mixture was stirred for 2 days, filtered through a bed of silica gel (topped with a thin layer of Celite), using MeOH, and evaporated to give a mixture of γ -butyrolactone and **44.2** (5.22 g, 95%) [10% lactone still present by ^1H NMR].

In a separate flask, $(\text{COCl})_2$ (1.85 mL, 0.21 mol) was added to CH_2Cl_2 (24 mL) in a dry, N_2 -filled flask. The solution was cooled to $-78\text{ }^\circ\text{C}$ and DMSO (3.00 mL, 0.042 mol) in CH_2Cl_2 (17 mL) was added dropwise, and stirring was continued for 10 min. A solution of γ -butyrolactone and **44.2** (2.50 g) in CH_2Cl_2 (12 mL) was then added dropwise, and stirring was continued for 20 min. Et_3N (11.8 mL, 0.085 mol) was then added, the cooling bath removed, and stirring was continued for 1 h. The mixture was quenched with water, followed by dilute hydrochloric acid (0.5 M), and the aqueous layer was extracted with CHCl_3 . The combined organic extracts were washed with brine, dried (MgSO_4), and evaporated. Flash chromatography of the residue over silica gel (3.7 x 15 cm), using 20% EtOAc-hexanes, gave **44.3** (1.39 g, 51% overall from γ -butyrolactone)

as a clear oil which was used immediately for the next step: FTIR (neat film) 2848, 2734, 1737 cm^{-1} ; ^1H NMR (CDCl_3 , 500 MHz) δ 2.64 (t, $J = 6.7$ Hz, 2 H), 2.80 (t, $J = 6.8$ Hz, 2 H), 3.70 (s, 3 H), 9.81 (s, 1 H); ^{13}C NMR (CDCl_3 , 125 MHz) δ 26.3 (t), 38.5 (t), 51.8 (q), 172.6 (s), 199.9 (d); exact mass (electron impact) m/z calcd for $\text{C}_5\text{H}_8\text{O}_3$ 117.0552, found 117.0551.

Methyl 4,4-bis(phenylsulfanyl)butanoate (38.1).

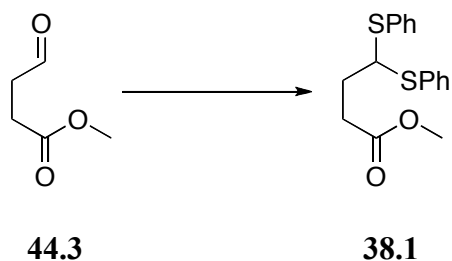

PhSH (6.80 mL, 0.066 mol), followed by $\text{BF}_3 \cdot \text{OEt}_2$ (4.10 mL, 0.033 mol), was added to a stirred and cooled (0°C) solution of **44.3** (3.84 g, 0.033 mol) in dry CH_2Cl_2 (60 mL). The mixture was stirred overnight at room temperature, quenched with aqueous NaOH (10%), diluted with water, and extracted twice with CHCl_3 . The combined organic extracts were washed with aqueous NaOH (10%), water and brine, dried (MgSO_4), and evaporated to give **38.1** (9.51 g, 90%) as a golden oil: FTIR (neat film) 1736 cm^{-1} ; ^1H NMR (CDCl_3 , 400 MHz) δ 1.95 (q, $J = 7.0$ Hz, 2 H), 2.64 (t, $J = 7.3$ Hz, 2 H), 3.66 (s, 3 H), 4.51 (t, $J = 6.9$ Hz, 1 H), 7.29-7.35 (m, 6 H), 7.48-7.50 (m, 4 H); ^{13}C NMR (CDCl_3 , 100 MHz) δ 30.7 (t), 31.3 (t), 51.7 (q), 57.4 (d), 127.9 (d), 129.0 (d), 132.8 (d), 133.8 (s),

(2*R*)-2-[2-[(*tert*-Butyldimethylsilyl)oxy]ethyl]-*N*-[(1*S*,2*S*)-1-hydroxy-1-phenylpropan-2-yl]-*N*-methyl-4,4-bis(phenylsulfanyl)butanamide (**56.1**).

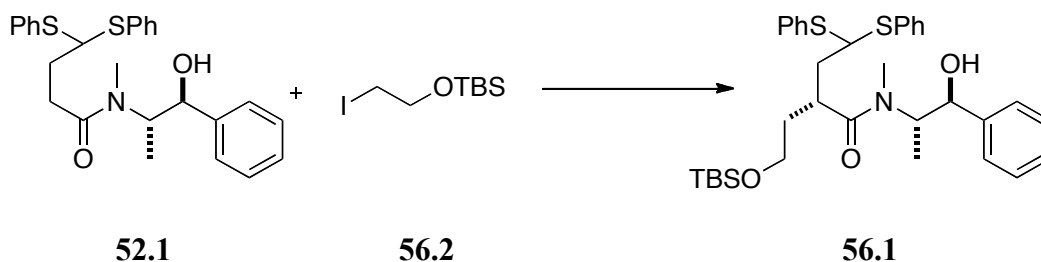

i-Pr₂NEt (0.32 mL, 2.25 mmol) was added to a stirred suspension of LiCl (0.254 g, 6.00 mmol) in THF (1.2 mL) and the mixture was cooled to -78 °C. *n*-BuLi (2.5 M in hexanes, 0.84 mL, 2.10 mmol) was added and the mixture was stirred for 15 min and then at 0 °C for another 15 min. The mixture was cooled to -78 °C and **52.1** (3 mL of a 0.33 M stock THF solution, 1.00 mmol) was added by syringe and the mixture was stirred for 1 h. Stirring was continued for 15 min at 0 °C, and 15 min at room temperature and then the mixture was cooled to 0 °C. A solution of freshly prepared **56.2** (0.541 g, 2.00 mmol) in THF (1 mL + 0.5 mL rinse) was added by syringe and stirring at 0 °C was continued for 18 h. The mixture was quenched with saturated aqueous NH₄Cl and partitioned between EtOAc and water. The aqueous layer was extracted with EtOAc and the combined organic extracts were dried (MgSO₄) and evaporated. Flash chromatography of the residue over silica gel (2.7 x 15 cm), using first 10% EtOAc-hexanes, and then a gradient elution of 22%, 24%...30% EtOAc-hexanes, gave **56.1** (0.396 g, 65%) as a yellow oil consisting of two rotamers: $[\alpha]_D^{25}$

The solution was stirred at 0 °C for 10 min and then $\text{NH}_3 \cdot \text{BH}_3$ (90% technical grade, 0.088 g, 2.59 mmol) was added in one lot, and stirring was continued for 15 min. The cooling bath was removed, stirring was continued for 15 min and the mixture was recooled to 0 °C. A solution of **56.1** (0.396 g, 0.64 mmol) in THF (1.5 mL + 1.5 mL rinse) was added by syringe and stirring was continued for 3 h. The mixture was heated to 50 °C for 2.5 h, cooled to room temperature, quenched with dilute hydrochloric acid (0.5 M) and extracted three times with EtOAc. The combined organic extracts were washed with brine, dried (MgSO_4), and evaporated. Flash chromatography of the residue over silica gel (1.7 x 15 cm), using 8%, 10%, 12%, 14% EtOAc-hexanes, gave **59.1** (0.120 g, 41%) as a clear oil: FTIR (cast film) 3423 cm^{-1} ; ^1H NMR (CDCl_3 , 500 MHz) δ 0.06 (s, 3 H), 0.07 (s, 3 H), 0.09 (s, 9 H), 1.53 (dddd, $J = 15.0, 11.7, 7.4, 4.0 \text{ Hz}$, 1 H), 1.63 (dddd, $J = 14.7, 11.2, 8.5, 6.9, 4.2 \text{ Hz}$, 1 H), 1.63 (ddd, $J = 14.4, 7.6, 6.6 \text{ Hz}$, 1 H), 1.94 (ddd, $J = 14.5, 7.1, 7.1 \text{ Hz}$, 1 H), 2.14-2.22 (m, 1 H), 3.02-3.06 (m, 1 H), 3.46-3.52 (m, 3 H), 4.48 (t, $J = 7.4 \text{ Hz}$, 1 H), 7.26-7.34 (m, 6 H), 7.46-7.50 (m, 4 H), (OH signal missing); ^{13}C NMR (CDCl_3 , 125 MHz) δ -5.5 (q), 18.2 (t), 25.9 (q), 35.0 (t), 37.0 (d), 37.9 (t), 56.4 (d), 61.2 (t), 65.2 (s), 127.7 (d), 127.8 (d), 128.9 (d), 128.9 (d), 132.7 (d), 133.0 (d), 133.9 (s), 134.0 (s); exact mass (electrospray) m/z calcd for $\text{C}_{24}\text{H}_{36}\text{NaO}_2\text{S}_2\text{Si}$ 471.1818, found 471.1818.

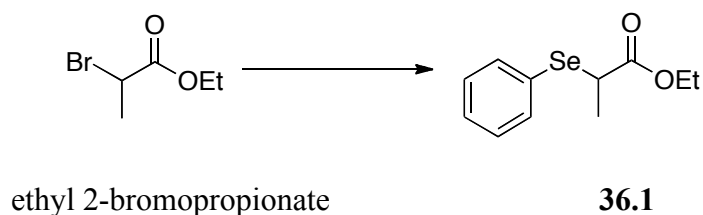
Ethyl 2-(phenylselanyl)propanoate (36.1).

NaBH₄ (0.378 g, 0.010 mol) was added to a stirred and cooled (0 °C) solution of PhSeSePh (0.624 g, 2.00 mmol) in EtOH (8 mL) and stirring was continued for 30 min (solution becomes white). Ethyl 2-bromopropionate (0.49 mL, 3.80 mmol) was added, the cooling bath was removed and stirring was continued for 2 h, after which time the mixture was quenched with water and extracted twice with EtOAc. The combined organic extracts were washed with brine, dried (MgSO₄) and evaporated. Flash chromatography of the residue over silica gel (2.5 x 15 cm), using 100% hexanes to elute selenium contaminants, followed by a gradient elution of 4%, 6%, 8% EtOAc-hexanes, gave **36.1** (0.937 g, 96%) as a pale yellow oil: FTIR (neat film) 1728 cm⁻¹; ¹H NMR (CDCl₃, 400 MHz) δ 1.18 (t, *J* = 7.2 Hz, 3 H), 1.50 (d, *J* = 7.2 Hz, 3 H), 3.78 (q, *J* = 7.2 Hz, 1 H), 4.10 (q, *J* = 7.2 Hz, 2 H), 7.26-7.36 (m, 3 H), 7.59-7.62 (m, 2 H); ¹³C NMR (CDCl₃, 125 MHz) δ 14.0 (q), 17.7 (q), 37.4 (d), 61.0 (t), 127.9 (s), 128.5 (d), 128.9 (d), 135.8 (d), 173.4 (s); exact mass (electron impact) *m/z* calcd for C₁₁H₁₄O₂⁸⁰Se 258.0159, found 258.0160.

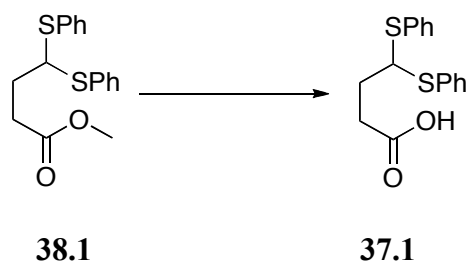
4,4-Bis(phenylsulfanyl)butanoic acid (37.1).

LiOH (0.131 g, 3.12 mmol) was added to a stirred solution of **38.1** (0.497 g, 1.56 mmol) in THF-water (9-1, 10 mL) and stirring was continued overnight. The mixture was then diluted with water and this solution washed twice with EtOAc and the organic extracts were discarded. The aqueous phase was acidified (pH = 1/universal pH paper goes red) with concentrated hydrochloric acid and extracted twice with EtOAc. The combined organic extracts were washed with brine, dried (MgSO₄), and evaporated to give **37.1** (0.428 g, 90%) as a white solid: mp 73-76 °C; FTIR (neat film) 3200-2800, 1708 cm⁻¹; ¹H NMR (CDCl₃, 500 MHz) δ 2.19 (q, *J* = 7.4 Hz, 2 H), 2.54 (t, *J* = 7.3 Hz, 2 H), 4.49 (t, *J* = 6.8 Hz, 1 H), 7.28-7.34 (m, 6 H), 7.47-7.50 (m, 4 H), 10.4-12.0 (br s, 1 H); ¹³C NMR (CDCl₃, 125 MHz) δ 30.5 (t), 31.2 (t), 57.3 (d), 128.0 (d), 129.0 (d), 132.9 (d), 133.6 (s), 178.7 (s); exact mass (electrospray) *m/z* calcd for C₁₆H₁₅O₂S₂ (M-H⁺) 303.0519, found 303.0522.

Methyl 5,5-bis(phenylsulfanyl)pentanoate (45.4).

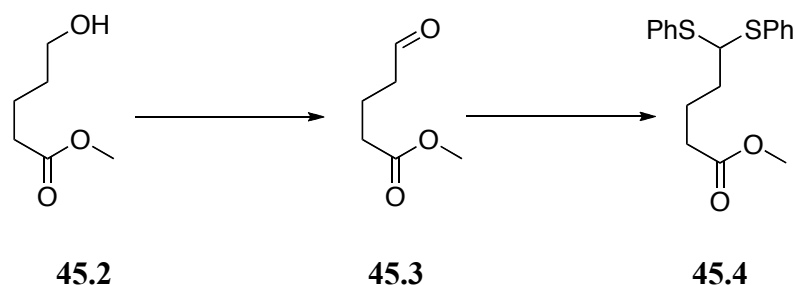

(COCl)₂ (4.30 mL, 0.049 mol) was added to CH₂Cl₂ (80 mL) in a dry, N₂-filled flask. The solution was cooled to -78 °C and DMSO (7.69 mL, 0.098 mol) in CH₂Cl₂ (20 mL) was added dropwise and stirring was continued for 10 min. A solution of **45.2** (6.50 g, 0.049 mol) in CH₂Cl₂ (20 mL) was then added dropwise, and stirring was continued for 20 min. Et₃N (27 mL, 0.19 mol) was then added, the cooling bath was removed, and stirring was continued for 1 h. The mixture was quenched with water and dilute hydrochloric acid (0.5 M) and the aqueous layer was extracted with CHCl₃. The combined organic extracts were washed with brine, dried (MgSO₄) and evaporated. Flash chromatography of the residue over silica gel (4.5 x 15 cm), using a gradient elution of 8%, 18%, 20%, 22%, 24% EtOAc-hexanes, gave **45.3** (5.69 g, 89%) as a clear oil which was used immediately for the next step.

PhSH (10.0 mL, 0.097 mol), followed by BF₃·OEt₂ (6.00 mL, 0.048 mol), was added to a stirred and cooled (0 °C) solution of **45.3** (3.84 g, 0.033 mol) in dry CH₂Cl₂ (80 mL). The mixture was stirred overnight, quenched with aqueous NaOH (10%), diluted with water and extracted twice with CHCl₃. The combined

organic extracts were washed with aqueous NaOH (10%), water and brine, dried (MgSO₄) and evaporated. Flash chromatography of the residue over silica gel (4.5 x 15 cm), using a gradient elution of 2%, 4%...10% EtOAc-hexanes, gave **45.4** (8.48 g, 52% over two steps) as a clear oil: FTIR (neat film) 1737 cm⁻¹; ¹H NMR (CDCl₃, 500 MHz) δ 1.86-1.91 (m, 2 H), 1.92-2.00 (m, 2 H), 2.31 (t, *J* = 7.2 Hz, 2 H), 3.64 (s, 3 H), 4.40 (t, *J* = 6.7 Hz, 1 H), 7.25-7.34 (m, 6 H), 7.45-7.49 (m, 4 H); ¹³C NMR (CDCl₃, 125 MHz) δ 22.6 (t), 33.4 (t), 35.1 (t), 51.6 (q), 58.0 (d), 127.8 (d), 128.9 (d), 132.8 (d), 134.4 (s), 173.4 (s); exact mass (electron impact) *m/z* calcd for C₁₈H₂₀O₂S₂ 332.0905, found 332.0904.

5,5-Bis(phenylsulfanyl)pentanoic acid (45.5).

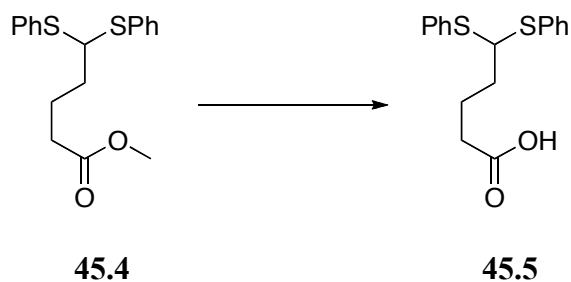

LiOH (1.99 g, 0.047 mol) was added to a stirred solution of **45.4** (7.89 g, 0.023 mol) in THF-water (9-1, 100 mL) and stirring was continued overnight. The mixture was then diluted with water and extracted twice with EtOAc. The combined organic extracts were washed with brine, dried (MgSO₄), and evaporated. Flash chromatography of the residue over silica gel (5.5 x 15 cm), using a gradient elution of 10%, 18%, 20%...24% EtOAc-hexanes, gave **45.5**

(6.84 g, 91%) as a clear oil: FTIR (neat film) 3400-3000, 1707 cm^{-1} ; ^1H NMR (CDCl_3 , 500 MHz) δ 1.89-1.95 (m, 2 H), 1.95-2.10 (m, 2 H), 2.36 (t, $J = 7.0$ Hz, 2 H), 4.41 (t, $J = 6.5$ Hz, 1 H), 7.26-7.34 (m, 6 H), 7.44-7.50 (m, 4 H), 10.0-12.0 (br s, 1 H); ^{13}C NMR (CDCl_3 , 125 MHz) δ 22.2 (t), 33.4 (t), 35.0 (t), 58.1 (d), 127.8 (d), 129.0 (d), 132.9 (d), 134.0 (s), 179.5 (s); exact mass (electrospray) m/z calcd for $\text{C}_{17}\text{H}_{18}\text{NaO}_2\text{S}_2$ 341.0641, found 341.0640.

***N*-[(1*S*,2*S*)-1-Hydroxy-1-phenylpropan-2-yl]-*N*-methyl-4,4-bis(phenylsulfanyl)butanamide (52.1).**

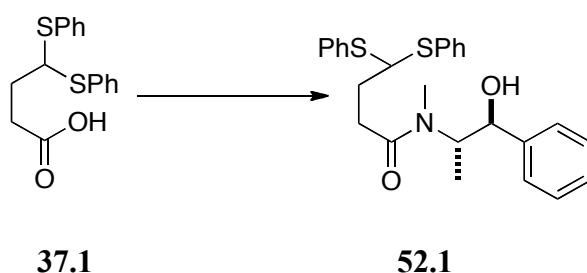

$(\text{COCl})_2$ (0.76 mL, 8.76 mmol) was added to a stirred solution of **37.1** (2.67 g, 8.76 mmol) in CH_2Cl_2 (26 mL). DMF (1 drop) was added, stirring was continued until bubbling ceased (ca. 1 h), and the mixture was cooled to 0 °C. A solution of (+)-pseudoephedrine (1.38 g, 8.32 mmol) and Et_3N (1.46 mL, 0.010 mol) in CH_2Cl_2 (5 mL + 2 mL rinse) was then added. Stirring was continued for 3.5 h and the reaction was quenched with water. The mixture was extracted twice with CHCl_3 , and the combined organic extracts were washed with brine, dried (MgSO_4) and evaporated. Flash chromatography of the residue over silica gel (4

x 15 cm), using a gradient elution of 5%, 10%, 25%, 46%, 48%, 50% EtOAc-hexanes, gave **52.1** (3.93 g, 99%) as a clear semi-solid: $[\alpha]_D^{25} +54.66$ ($c = 0.45$, CHCl_3); FTIR (CHCl_3 cast) 3500-3200, 1623 cm^{-1} ; ^1H NMR (2.2:1 rotamer ratio, asterisk denotes minor peaks, CDCl_3 , 500 MHz) δ *0.96 (d, $J = 6.8$ Hz, 1 H), 1.80 (d, $J = 6.9$ Hz, 2 H), 2.20-2.30 (m, 2 H), 2.56-2.68 (m, 1 H), 2.78-2.82 (m, 3 H), *2.9 (s, 1 H), 4.10-4.20 (br s, 1 H), 4.46-4.59 (m, 2 H), 4.61 (t, $J = 6.8$ Hz, 0.8 H), *4.66 (t, $J = 6.7$ Hz, 0.3 H), 7.26-7.40 (m, 11 H), 7.47-7.55 (m, 4 H); ^{13}C NMR (2.2:1 rotamer ratio, CDCl_3 , 125 MHz) δ 14.5, 15.4, 30.8, 31.2, 31.3, 31.6, 57.4, 57.5, 58.2, 75.5, 76.4, 77.35, 126.46, 126.97, 127.61, 127.65, 127.73, 127.76, 127.77, 128.39, 128.42, 128.7, 128.97, 129.01, 129.02, 132.39, 132.49, 132.53, 132.58, 134.03, 134.07, 134.17, 134.24, 141.4, 142.3, 172.9, 173.0; exact mass (electrospray) m/z calcd for $\text{C}_{26}\text{H}_{29}\text{NNaO}_2\text{S}_2$ 474.1532, found 474.1528.

***N*-[(1*S*,2*S*)-1-Hydroxy-1-phenylpropan-2-yl]-*N*-methyl-5,5-bis(phenylsulfanyl)pentanamide (**54.1**).**

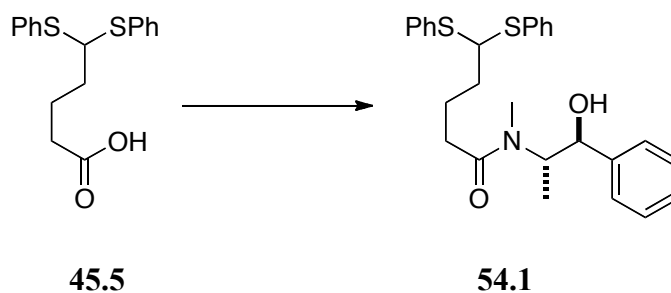

$(\text{COCl})_2$ (0.68 mL, 7.85 mmol) was added to a stirred solution of **45.5** (2.50 g, 7.85 mmol) in CH_2Cl_2 (20 mL). DMF (1 drop) was added, stirring

continued until bubbling ceased (ca. 1 h), and the mixture was cooled to 0 °C. A solution of (+)-pseudoephedrine (1.23 g, 7.46 mmol) and Et₃N (1.30 mL, 9.42 mmol) in CH₂Cl₂ (5 mL + 2 mL rinse) was then added. Stirring was continued for 4 h and the reaction was quenched with water. The mixture was extracted twice with CHCl₃, and the combined organic extracts were washed with brine, dried (MgSO₄) and evaporated. Flash chromatography of the residue over silica gel (5 x 15 cm), using a gradient elution of 5%, 10%, 25%, 40%, 42%...50% EtOAc-hexanes, gave **54.1** (2.71 g, 78%) as a clear semi-solid: $[\alpha]_D^{25} +49.25$ ($c = 1.14$, CHCl₃); FTIR (CHCl₃ cast) 3500-3200, 1622 cm⁻¹; ¹H NMR (2.2:1 rotamer ratio, asterisk denotes minor peaks, CDCl₃, 500 MHz) δ *1.00 (d, $J = 6.8$ Hz, 1 H), 1.10 (d, $J = 7.0$ Hz, 2 H), 1.90-2.20 (m, 4 H), 2.20-2.32 (m, 1 H), 2.34-2.48 (m, 1 H), 2.77 (s, 2 H), *2.92 (s, 1 H), 4.36-4.48 (m, 2 H), 4.54-4.61 (m, 1 H), 7.26-7.38 (m, 11 H), 7.46-7.52 (m, 4 H), (OH missing); ¹³C NMR (2.2:1 rotamer ratio, CDCl₃, 125 MHz) δ 14.5, 15.5, 22.7, 23.1, 27.0, 33.0, 33.7, 35.5, 35.6, 58.2, 58.3, 58.4, 75.5, 76.4, 126.4, 127.0, 127.7, 127.8, 128.3, 128.4, 128.7, 128.9, 132.66, 132.70, 134.2, 134.3, 141.5, 142.5, 173.5, 174.5; exact mass (electrospray) m/z calcd for C₂₇H₃₁NNaO₂S₂ 488.1688, found 488.1685.

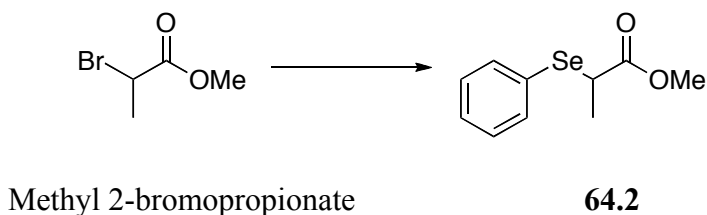
Methyl 2-(phenylselanyl)propanoate (64.2).

NaBH₄ (0.509 g, 0.013 mol) was added to a stirred and cooled (0 °C) solution of PhSeSePh (0.840 g, 2.69 mmol) in MeOH (8 mL) and stirring was continued for 30 min (solution becomes white). Methyl 2-bromopropionate (0.60 mL, 5.38 mmol) was added, the cooling bath was removed and stirring was continued for 3 h, after which time the reaction was quenched with water. The mixture was extracted twice with EtOAc, and the combined organic extracts were washed with brine, dried (MgSO₄), and evaporated. Flash chromatography of the residue over silica gel (2.7 x 15 cm), using 100% hexanes to elute Se contaminants, followed by a gradient elution of 2%, 4%, 6% EtOAc-hexanes, gave **64.2** (0.846 g, 65%) as a pale yellow oil: FTIR (neat film) 1732 cm⁻¹; ¹H NMR (CDCl₃, 500 MHz) δ 1.57 (d, *J* = 7.2 Hz, 3 H), 3.66 (s, 3 H), 3.81 (q, *J* = 7.2 Hz, 1 H), 7.30-7.39 (m, 3 H), 7.60-7.63 (m, 2 H); ¹³C NMR (CDCl₃, 125 MHz) δ 17.8 (q), 37.2 (d), 52.1 (q), (t), 127.7 (s), 128.6 (d), 129.0 (d), 135.8 (d), 173.9 (s); exact mass (electron impact) *m/z* calcd for C₁₀H₁₂O₂⁸⁰Se 244.0002, found 244.0001.

(2*R*)-2-[2,2-Bis(phenylsulfanyl)ethyl]-6-[(*tert*-butyldimethylsilyl)oxy]-*N*-[(1*S*,2*S*)-1-hydroxy-1-phenylpropan-2-yl]-*N*-methylhexanamide (**57.1**).

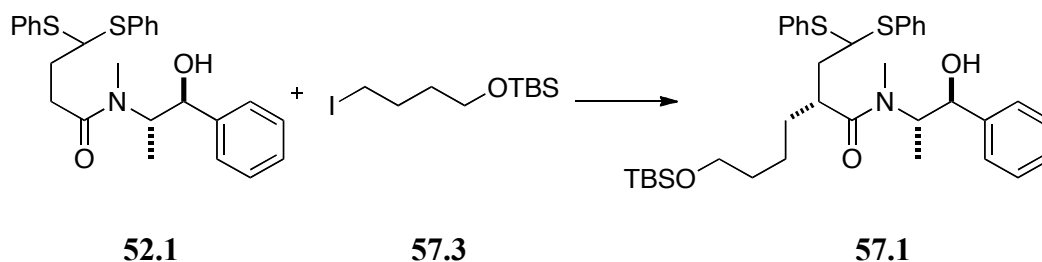

i-Pr₂NEt (0.32 mL, 2.25 mmol) was added to a stirred suspension of LiCl (0.262 g, 6.00 mmol) in THF (1.2 mL) and the mixture was cooled to -78 °C. *n*-BuLi (2.5 M in hexanes, 0.86 mL, 2.10 mmol) was added and the mixture was stirred for 15 min, after which time it was stirred at 0 °C for another 15 min. The mixture was cooled to -78 °C, **52.1** (3.0 mL of a 0.33 M stock solution in THF, 1.00 mmol) was added by syringe and the mixture was stirred for 1 h. Stirring was then continued for 15 min at 0 °C, for 15 min at room temperature (removed ice bath) and then for 10 min at 0 °C. A solution of freshly prepared **57.3** (0.629 g, 2.00 mmol) in THF (1 mL + 0.5 mL rinse) was added by syringe and the mixture was stirred at 0 °C for 5 h. The mixture was quenched with saturated aqueous NH₄Cl, and partitioned between EtOAc and water. The aqueous layer was extracted twice with EtOAc, and the combined organic extracts were dried (MgSO₄), and evaporated. Flash chromatography of the residue over silica gel (2.5 x 15 cm), using a gradient elution of 10%, 20%, 22%...28% EtOAc-hexanes, gave **57.1** (0.519 g, 81%) as a yellow oil consisting of two rotamers: $[\alpha]_D^{25}$ -

117.98 ($c = 0.67$, CHCl_3); FTIR (CHCl_3 cast) 3383, 1619 cm^{-1} ; ^1H NMR (4.5:1 rotamer ratio, CDCl_3 , 500 MHz) δ 0.02-0.04 (m, 6 H), 0.89 (s, 9 H), 1.06 (d, $J = 7.0$ Hz, 3 H), 1.10-1.17 (m, 1 H), 1.17-1.37 (m, 2 H), 1.38-1.53 (m, 3 H), 1.83 (ddd, $J = 14.4, 10.3, 4.2$ Hz, 1 H), 2.44 (ddd, $J = 14.3, 9.8, 4.5$ Hz, 1 H), 2.90-2.96 (m, 3 H), 3.09-3.15 (m, 1 H), 3.49-3.58 (m, 2 H), 4.20-4.40 (br s, 1 H), 4.41-4.50 (m, 2 H), 4.52-4.60 (m, 1 H), 7.22-7.39 (m, 11 H), 7.40-7.46 (m, 2 H), 7.46-7.50 (m, 2 H); ^{13}C NMR (CDCl_3 , 125 MHz) δ -5.2, 14.6, 15.6, 18.4, 23.4, 23.5, 26.0, 26.0, 32.8, 33.1, 38.9, 40.1, 55.0, 55.7, 62.8, 63.1, 75.4, 76.2, 26.3, 127.0, 127.3, 127.4, 127.6, 127.6, 127.7, 128.3, 128.4, 128.7, 128.9, 128.9, 128.9, 129.0, 131.6, 131.8, 132.0, 132.4, 133.5, 134.4, 134.5, 141.4, 142.4, 175.7, 177.1; exact mass (electrospray) m/z calcd for $\text{C}_{36}\text{H}_{51}\text{NNaO}_3\text{S}_2\text{Si}$ 660.2972, found 660.2966.

(2*R*)-2-[2,2-Bis(phenylsulfanyl)ethyl]-6-[(*tert*-butyldimethylsilyl)oxy]-hexan-1-ol (59.2).

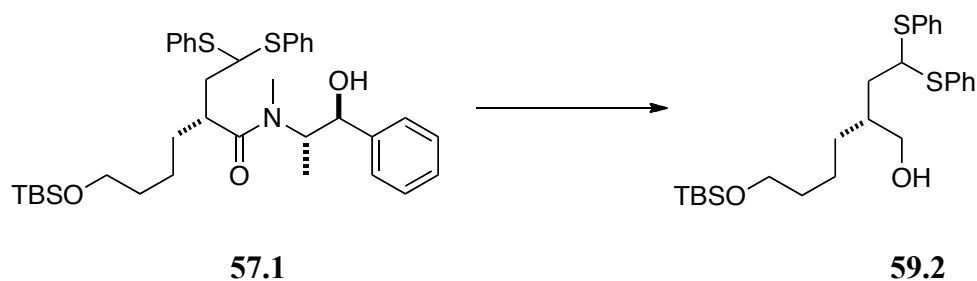

n-BuLi (2.5 M in hexanes, 0.67 mL, 1.66 mmol) was added to a stirred and cooled (-78 °C) solution of *i*-Pr₂NEt (0.24 mL, 1.71 mmol) in THF (2.5 mL). The solution was stirred at 0 °C for 10 min, after which time $\text{NH}_3 \cdot \text{BH}_3$ (90%

technical grade, 0.053 g, 1.71 mmol) was added in one lot, and stirring was continued for 15 min. The cooling bath was removed and stirring was continued for 20 min, after which time the mixture was returned to 0 °C. A solution of **57.1** (0.272 g, 0.43 mmol) in THF (2 mL + 2 mL rinse) was added by syringe, the cooling bath was removed, and stirring was continued for 3 h. The mixture was quenched with water and extracted three times with EtOAc. The combined organic extracts were washed with brine, dried (MgSO₄), and evaporated. Flash chromatography of the residue over silica gel (1.7 x 15 cm) using 8%, 10%, 12%, 14% EtOAc-hexanes gave **59.2** (0.180 g, 89%) as a clear oil: $[\alpha]_D^{25} +4.68$ ($c = 0.44$, CHCl₃); FTIR (CHCl₃ cast) 3398 cm⁻¹; ¹H NMR (CDCl₃, 500 MHz) δ 0.04 (s, 6 H), 0.90 (s, 9 H), 1.20-1.40 (m, 5 H), 1.42-1.50 (m, 2 H), 1.78-1.86 (m, 1 H), 1.90-2.00 (m, 2 H), 3.52 (dd, $J = 10.9, 5.1$ Hz, 1 H), 3.55-3.62 (m, 3 H), 4.55 (dd, $J = 8.0, 6.5$ Hz, 1 H), 7.25-7.34 (m, 6 H), 7.45-7.62 (m, 4 H); ¹³C NMR (CDCl₃, 100 MHz) δ -5.5 (q), 18.5 (t), 22.9 (t), 26.1 (q), 30.8 (t), 33.0 (t), 38.3 (t), 38.4 (d), 56.5 (d), 63.0 (s), 65.1 (t), 127.7 (d), 127.7 (d), 128.9 (d), 132.6 (d), 132.7 (d), 134.0 (s), 134.2 (s); exact mass (electrospray) m/z calcd for C₂₆H₄₀NaO₂S₂Si 499.2131, found 499.2126.

(2*R*)-2-[2,2-Bis(phenylsulfanyl)ethyl]-6-[(*tert*-butyldimethylsilyl)oxy]-hexanal (61.1).

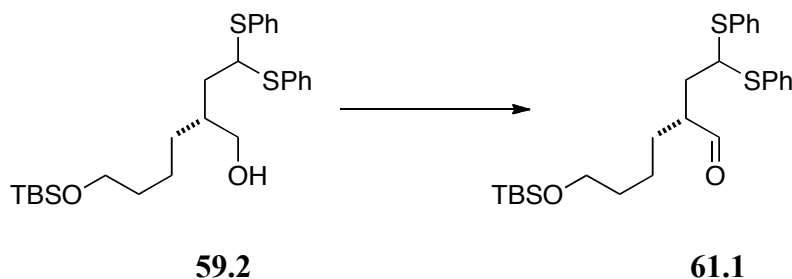

PCC (0.163 g, 0.75 mmol) was added to a stirred solution of **59.2** (0.180 g, 0.38 mmol) in CH₂Cl₂ (3 mL) and stirring was continued for 2.5 h. Celite was added and the solution was stirred vigorously. The resulting slurry was then filtered through a Celite pad. Evaporation of the filtrate and flash chromatography of the residue over silica gel (1.7 x 15 cm), using a gradient elution of 2%, 4%, 6% EtOAc-hexanes, gave **61.1** (0.120 g, 67%) as a clear oil: $[\alpha]_D^{25}$ -25.58 ($c = 0.68$, CHCl₃); FTIR (CHCl₃ cast) 2929, 2857, 1725 cm⁻¹; ¹H NMR (CDCl₃, 400 MHz) δ 0.04 (s, 6 H), 0.88 (s, 9 H), 1.24-1.34 (m, 2 H), 1.38-1.52 (m, 3 H), 1.58-1.69 (m, 1 H), 1.84 (dddd, $J = 14.7, 13.3, 8.5, 4.7$ Hz, 1 H), 2.28 (ddd, $J = 18.6, 14.6, 6.0$ Hz, 1 H), 2.85 (m, 1 H), 3.56 (t, $J = 6.4$ Hz, 2 H), 4.44 (dd, $J = 8.5, 6.0$ Hz, 1 H), 7.25-7.35 (m, 6 H), 7.44-7.48 (m, 4 H), 9.60 (d, $J = 2.0$ Hz, 1 H); ¹³C NMR (CDCl₃, 125 MHz) δ -5.2 (q), 18.3 (t), 23.1 (t), 26.0 (q), 28.9 (t), 32.7 (t), 35.0 (t), 49.5 (d), 56.3 (d), 62.7 (s), 127.9 (d), 128.0 (d), 129.0 (d), 132.7 (d), 132.9 (d), 133.5 (s), 133.8 (s), 203.7 (d); exact mass (electrospray) m/z calcd for C₂₆H₃₈NaO₂S₂Si 497.1975, found 497.1968.

Ethyl (4*R*)-4-[2,2-bis(phenylsulfanyl)ethyl]-8-[(*tert*-butyldimethylsilyl)oxy]-3-hydroxy-2-methyl-2-(phenylselanyl)octanoate (**62.2**).

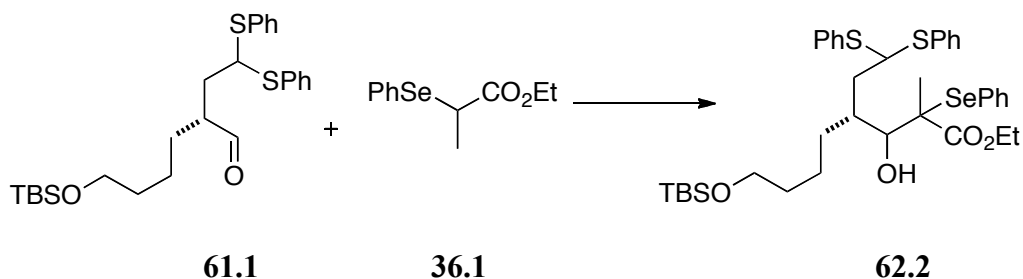

n-BuLi (2.36 M in hexanes, 0.63 mL, 1.49 mmol) was added to a stirred and cooled (-78 °C) solution of *i*-Pr₂NH (0.21 mL, 1.49 mmol) in THF (6 mL) and stirring was continued for 5 min. The solution was then stirred at 0 °C for 20 min and recooled to -78 °C. A solution of **62.1** (0.385 g, 1.49 mmol) in THF (3 mL + 1 mL rinse) was added and stirring was continued for 50 min. A solution of **61.1** (0.508 g, 1.07 mmol) in THF (3 mL + 3 mL rinse) was added and the solution was stirred for 1.5 h. The reaction was quenched with saturated aqueous NH₄Cl, followed by water, and the mixture was allowed to warm to room temperature, following removal of the cooling bath. The crude mixture was extracted twice with EtOAc and the combined organic extracts were washed with brine, dried (MgSO₄), and evaporated. Flash chromatography of the residue over silica gel (2.7 x 15 cm), using a gradient elution of 2%, 4%...10% EtOAc-hexanes, gave **62.2** (0.746 g, 95%) as a clear semi-solid. This material was a partially separable mixture of less and more polar components, each composed of two diastereoisomers; the two components were characterized by spectroscopic

analysis. Following this analysis, the two components were then combined and carried forward in the next step.

Less polar mixture of diastereoisomers: FTIR (CHCl₃ cast) 3445, 1688 cm⁻¹; ¹H NMR (1.6:1 mixture of diastereoisomers, minor diastereoisomer denoted by an asterisk, CDCl₃, 500 MHz) δ 0.01 (s, 3 H), 0.02 (s, 3 H), 0.88-0.90 (m, 9 H), 1.04-1.20 (m, 5 H), 1.20-1.52 (m, 7 H), 1.56-1.64 (m, 1 H), 1.80-1.98 (m, 2 H), 2.82-3.00 (m, 1 H), 3.48 (t, *J* = 6.7 Hz, 1 H), 3.52 (t, *J* = 6.7 Hz, 1 H), 3.88-4.00 (m, 3 H), 4.41 (dd, *J* = 6.1 Hz, 0.53 H), *4.60 (dd, *J* = 8.5, 6.2 Hz, 0.33 H), 7.22-7.32 (m, 8 H), 7.38-7.49 (m, 5 H), 7.50-7.60 (m, 2 H); ¹³C NMR (CDCl₃, 125 MHz) δ -5.23, -5.21, 13.8, 17.4, 17.6, 18.4, 22.6, 22.8, 26.0, 28.0, 28.5, 32.3, 33.1, 33.3, 36.9, 37.4, 38.3, 38.5, 38.7, 55.7, 57.8, 58.4, 58.7, 61.1, 61.2, 63.0, 63.1, 73.4, 74.3, 126.8, 126.9, 127.4, 127.9, 127.65, 127.66, 128.0, 128.78, 128.83, 128.86, 128.89, 129.4, 129.5, 132.2, 132.5, 132.8, 132.9, 133.3, 133.9, 134.35, 134.37, 134.8, 137.98, 138.01, 172.8, 172.9; exact mass (electrospray) *m/z* calcd for C₃₇H₅₂NaO₄S₂⁷⁹SeSi 755.2136, found 755.2122.

More polar mixture of diastereoisomers: FTIR (CHCl₃ cast) 3441, 1672 cm⁻¹; ¹H NMR (3.6:1 ratio of diastereoisomers, minor diastereoisomer denoted by an asterisk, CDCl₃, 500 MHz) δ 0.01-0.04 (m, 6 H), 0.88-0.90 (m, 9 H), 1.14-1.20 (m, 4 H), 1.20-1.34 (m, 2 H), 1.34-1.40 (m, 4 H), 1.41-1.51 (m, 2 H), 1.80 (ddd, *J* = 13.9, 10.6, 2.8 Hz, 1 H), 1.86-1.93 (m, 1 H), 2.12-2.23 (m, 1 H), *3.49 (t, *J* = 6.5 Hz, 0.4 H), 3.54 (ddd, *J* = 6.7, 6.7, 1.6, 1.6 Hz, 1 H), 3.64 (d, *J* = 8.2 Hz, 0.7 H),

*3.87 (d, $J = 8.7$ Hz, 0.2 H), 3.94-4.10 (m, 3 H), 4.38 (dd, $J = 10.6, 4.0$ Hz, 0.76 H), 4.53 (dd, $J = 10.1, 4.4$ Hz, 0.21 H), 7.22-7.32 (m, 8 H), 7.37-7.50 (m, 5 H), 7.54-7.59 (m, 2 H); ^{13}C NMR (CDCl_3 , 125 MHz) δ -5.22, -5.18, 13.85, 13.89, 18.37, 18.40, 20.2, 20.7, 22.9, 23.3, 26.00, 26.04, 27.8, 32.0, 33.10, 33.15, 36.0, 37.5, 37.8, 38.1, 53.9, 54.5, 55.9, 57.7, 61.45, 61.53, 62.9, 63.1, 77.6, 77.7, 126.7, 126.8, 127.5, 127.6, 127.7, 127.9, 128.76, 128.8, 128.88, 128.94, 129.45, 129.53, 132.17, 132.20, 132.3, 132.7, 133.3, 133.7, 134.0, 134.5, 134.6, 138.3, 138.4, 174.8; exact mass (electrospray) m/z calcd for $\text{C}_{37}\text{H}_{52}\text{NaO}_4\text{S}_2^{79}\text{SeSi}$ 755.2136, found 753.2123.

Ethyl (4*R*)-4-[2,2-bis(benzenesulfonyl)ethyl]-3,8-dihydroxy-2-methylenedeneoctanoate (62.3).

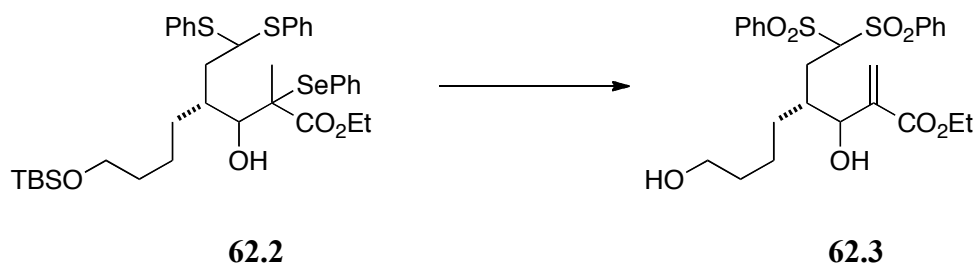

m-CPBA (75% w/w, 1.758 g, 8.15 mmol) was added slowly to a stirred solution of **62.2** (0.746 g, 1.02 mmol) in CH_2Cl_2 (12 mL) and the solution was refluxed overnight (orange-red color after 12 h). The solution was then cooled to room temperature and quenched with saturated aqueous NaHCO_3 and water. The crude mixture was extracted twice with CHCl_3 , and the combined organic extracts

were washed with brine, dried (MgSO₄), and evaporated. Flash chromatography of the residue over silica gel (2.2 x 15 cm), using a gradient elution of 20%, 40%, 80%, 82%...86% EtOAc-hexanes, gave **62.3** (0.426 g, 79%) as a white foam composed of two diastereoisomers: FTIR (CHCl₃ cast) 3532, 3404, 1708 cm⁻¹; ¹H NMR (2.2:1 ratio of diastereoisomers, minor diastereoisomer denoted by an asterisk, CDCl₃, 500 MHz) δ 1.10-1.20 (m, 1 H), 1.25-1.60 (m, 9 H), 1.60-1.82 (m, 1 H), 2.10-2.19 (m, 1 H), 2.22-2.38 (m, 2 H), 3.60-3.62 (m, 1 H), 3.64-3.66 (m, 1 H), 4.24-4.30 (m, 2 H), 4.43 (d, *J* = 5.1 Hz, 0.70 H), *4.60 (s, 0.30 H), *4.91 (dd, *J* = 6.3, 3.2 Hz, 0.29 H), 5.01 (dd, *J* = 5.7, 5.7 Hz, 0.71 H), 5.80 (dd, *J* = 1.2, 1.2 Hz, 0.67 H), *5.95 (dd, *J* = 1.5, 1.5 Hz, 0.29 H), 6.32-6.34 (m, 0.67 H), *6.36 (dd, *J* = 1.2, 1.2 Hz, 0.30 H), 7.54-7.62 (m, 4 H), 7.68-7.74 (m, 2 H), 7.92-7.99 (m, 3 H), 8.00-8.03 (m, 1 H); ¹³C NMR (CDCl₃, 125 MHz) δ 14.16, 14.20, 22.4, 23.1, 26.0, 26.3, 26.5, 30.3, 32.4, 32.7, 39.5, 41.1, 60.9, 61.1, 62.3, 62.5, 69.6, 72.6, 81.2, 81.8, 125.5, 126.0, 129.0, 129.11, 129.13, 129.4, 129.5, 129.8, 130.0, 134.4, 134.5, 134.7, 137.2, 137.7, 138.0, 138.2, 141.1, 141.8, 166.2, 166.3; exact mass (electrospray) *m/z* calcd for C₂₅H₃₂NaO₈S₂ 547.1431, found 547.1425.

Ethyl (4*R*)-3,8-bis(acetyloxy)-4-[2,2-bis(benzenesulfonyl)ethyl]-2-methylideneoctanoate (63.1).

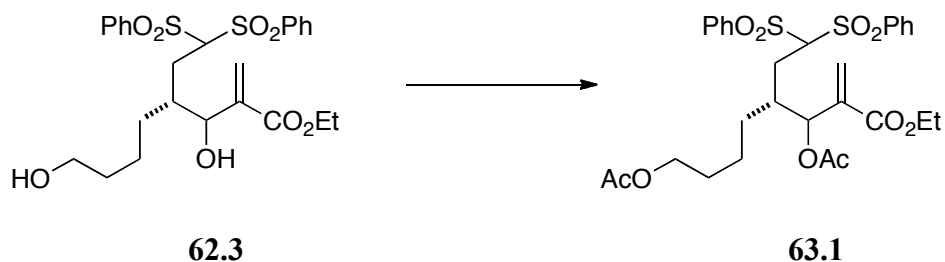

DMAP (0.010 g, 0.08 mmol) was added to a stirred and cooled (0 °C) solution of **62.3** (0.420 g, 0.80 mmol) in CH₂Cl₂ (6 mL). Pyridine (0.39 mL, 4.80 mmol), followed by AcCl (0.46 mL, 6.40 mmol), was added and stirring was continued overnight. The reaction was quenched with water, and the mixture was extracted twice with CHCl₃. The combined organic extracts were washed with brine, dried (MgSO₄), and evaporated. Flash chromatography of the residue over silica gel (2.2 x 15 cm), using a gradient elution of 20%, 38%, 40%...44% EtOAc-hexanes, gave **63.1** (0.462 g, 95%) as a white foam composed of two diastereoisomers: FTIR (CHCl₃ cast) 1738 cm⁻¹; ¹H NMR (2.2:1 ratio of diastereoisomers, minor diastereoisomer denoted by an asterisk, CDCl₃, 500 MHz) δ 1.16-1.26 (m, 2 H), 1.26-1.49 (m, 4 H), 1.49-1.68 (m, 3 H), 2.04-2.10 (m, 4 H), 2.10-2.13 (m, 3 H), 2.20-2.43 (m, 2 H), 4.00-4.10 (m, 2 H), 4.24-4.34 (m, 2 H), 4.54 (dd, *J* = 7.8, 4.0 Hz, 0.6 H), *4.86 (dd, *J* = 7.8, 3.0 Hz, 0.26 H), 5.62-5.66 (m, 1 H), 5.81-5.83 (m, 1 H), *6.37 (s, 0.25 H), 6.39 (dd, *J* = 1.0, 1.0 Hz, 0.56 H), 7.52-7.62 (m, 4 H), 7.66-7.75 (m, 2 H), 7.90-7.98 (m, 4 H); ¹³C NMR

(CDCl₃, 125 MHz) δ 14.1, 20.86, 20.88, 21.01, 21.03, 22.7, 23.5, 25.0, 25.6, 27.6, 28.5, 28.7, 29.6, 38.2, 38.7, 61.2, 61.3, 63.8, 64.1, 71.1, 71.6, 80.5, 81.6, 125.2, 125.7, 128.97, 129.01, 129.09, 129.16, 129.4, 129.57, 129.64, 130.0, 134.4, 134.5, 134.59, 134.61, 137.2, 137.8, 137.88, 137.94, 138.1, 138.5, 164.8, 165.0, 169.5, 169.8, 171.17, 171.19; exact mass (electrospray) m/z calcd for C₂₉H₃₆NaO₁₀S₂ 631.1642, found 631.1640.

Ethyl (3*R*)-3-[4-(acetyloxy)butyl]-5,5-bis(benzenesulfonyl)cyclohex-1-ene-1-carboxylate (63.2).

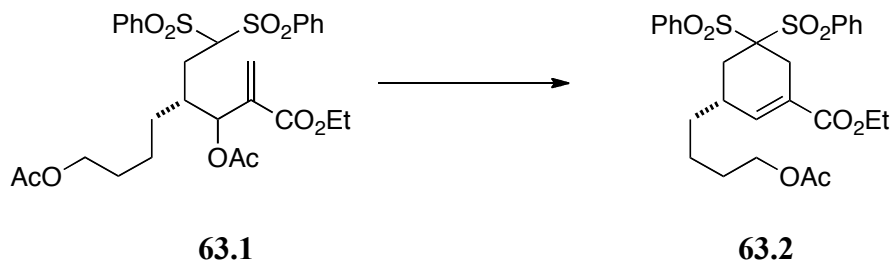

Cs₂CO₃ (0.494 g, 1.52 mmol) was added to a stirred solution of **63.1** (0.462 g, 0.76 mmol) in dry THF (7 mL). Stirring was continued for 5 h and the mixture was quenched with water and extracted twice with EtOAc. The combined organic extracts were washed with brine, dried (MgSO₄), and evaporated. Flash chromatography of the residue over silica gel (1.7 x 15 cm), using a gradient elution of 20%, 40%, 42% EtOAc-hexanes, gave **63.2** (0.357 g, 86%) as a white foam: $[\alpha]_D^{25}$ -23.68 ($c = 0.32$, CHCl₃); FTIR (CHCl₃ cast) 1735, 1711 cm⁻¹; ¹H NMR (CDCl₃, 500 MHz) δ 1.30 (t, $J = 7.2$ Hz, 3 H), 1.40-1.58 (m,

4 H), 1.65 (app. quintet, $J = 7.2$ Hz, 2 H), 1.93 (dd, $J = 14.3, 10.9$ Hz, 1 H), 2.09 (s, 3 H), 2.62 (dd, $J = 14.3, 5.8$ Hz, 1 H), 2.76-2.83 (m, 1 H), 3.07-3.19 (m, 2 H), 4.07 (t, $J = 6.6$ Hz, 2 H), 4.15-4.25 (m, 2 H), 6.87 (s, 1 H), 7.58-7.64 (m, 4 H), 7.70-7.76 (m, 2 H), 8.00-8.06 (m, 4 H); ^{13}C NMR (CDCl_3 , 125 MHz) δ 14.3 (q), 21.0 (q), 23.0 (t), 25.8 (t), 28.5 (t), 29.6 (t), 33.6 (d), 34.7 (t), 60.9 (t), 64.0 (t), 87.6 (s), 125.5 (s), 128.8 (d), 128.8 (d), 130.1 (d), 131.5 (d), 134.7 (d), 134.8 (d), 135.9 (s), 136.7 (s), 142.0 (d), 165.5 (s), 171.1 (s); exact mass (electrospray) m/z calcd for $\text{C}_{27}\text{H}_{32}\text{NaO}_8\text{S}_2$ 571.1431, found 571.1420.

Ethyl (3*R*)-5,5-bis(benzenesulfonyl)-3-(4-hydroxybutyl)cyclohex-1-ene-1-carboxylate (72.1).

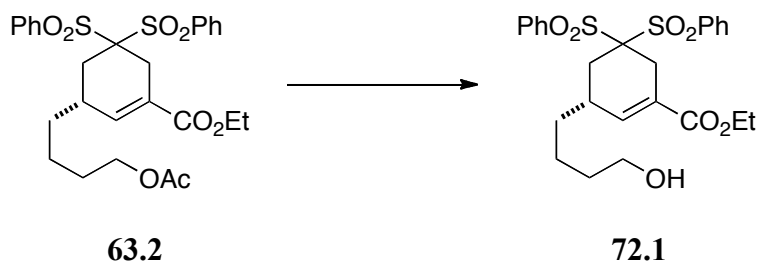

K_2CO_3 (0.091 g, 0.66 mmol) was added to a stirred solution of **63.2** (0.241 g, 0.44 mmol) in anhydrous EtOH (5 mL) and stirring was continued for 1.5 h. The mixture was diluted with water and extracted twice with EtOAc. The combined organic extracts were washed with brine, dried (MgSO_4), and evaporated. Flash chromatography of the residue over silica gel (1.7 x 15 cm), using a gradient elution of 40%, 48%, 50%...56% EtOAc-hexanes, gave **72.1**

(0.151 g, 68%) as a clear oil: $[\alpha]_D^{25} -25.46$ ($c = 0.30$, CHCl_3); FTIR (CHCl_3 cast) 3550, 1708 cm^{-1} ; ^1H NMR (CDCl_3 , 400 MHz) δ 1.28 (t, $J = 7.1$ Hz, 3 H), 1.40-1.62 (m, 7 H), 1.93 (dd, $J = 14.4, 11.0$ Hz, 1 H), 2.61 (dd, $J = 14.4, 5.6$ Hz, 1 H), 2.74-2.83 (m, 1 H), 3.06-3.28 (m, 2 H), 3.65 (t, $J = 6.3$ Hz, 2 H), 4.12-4.22 (m, 2 H), 6.87 (s, 1 H), 7.56-7.63 (m, 4 H), 7.69-7.76 (m, 2 H), 8.00-8.08 (m, 4 H); ^{13}C NMR (CDCl_3 , 125 MHz) δ 14.3 (q), 22.8 (t), 25.8 (t), 29.6 (t), 32.6 (t), 33.7 (d), 34.9 (t), 60.9 (t), 62.6 (t), 87.7 (s), 125.4 (s), 128.7 (d), 128.8 (d), 131.0 (d), 131.5 (d), 134.7 (d), 134.8 (d), 135.9 (s), 136.7 (s), 142.2 (d), 165.6 (s); exact mass (electrospray) m/z calcd for $\text{C}_{25}\text{H}_{30}\text{NaO}_7\text{S}_2$ 529.1325, found 529.1318.

Ethyl (3*R*)-5,5-bis(benzenesulfonyl)-3-(4-oxobutyl)cyclohex-1-ene-1-carboxylate (72.2).

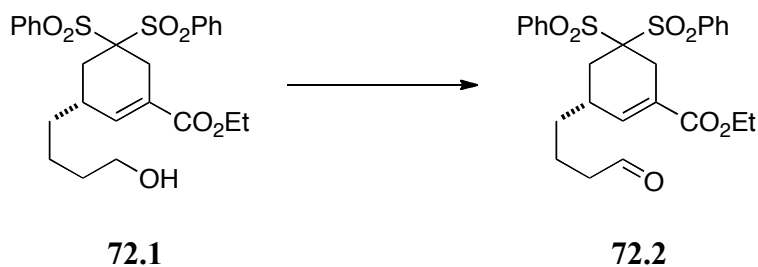

DMSO (0.21 mL, 2.97 mmol), followed by Et_3N (0.37 mL, 2.68 mmol), was added to a stirred solution of **72.1** (0.151 g, 0.30 mmol) in CH_2Cl_2 (5 mL) and the mixture was cooled to 0 °C. $\text{Pyr}\cdot\text{SO}_3$ (0.142 g, 0.89 mmol) was added and stirring was continued for 1 h. The cooling bath was removed and the mixture was quenched with water after 4 h and extracted twice with CHCl_3 . The

combined organic extracts were washed with brine, dried (MgSO_4), and evaporated. Flash chromatography of the residue over silica gel (1.7 x 15 cm), using a gradient elution of 42%, 44%, 46%, 48% EtOAc-hexanes, gave **72.2** (0.149 g, 99%) as a clear oil: $[\alpha]_D^{25} -18.16$ ($c = 0.48$, CHCl_3); FTIR (CHCl_3 cast) 2868, 2727, 1713 cm^{-1} ; ^1H NMR (CDCl_3 , 500 MHz) δ 1.30 (t, $J = 7.2$ Hz, 3 H), 1.40-1.49 (m, 1 H), 1.49-1.58 (m, 1 H), 1.60-1.80 (m, 2 H), 1.93 (dd, $J = 14.3$, 5.8 Hz, 1 H), 2.50 (t, $J = 7.1$ Hz, 2 H), 2.65 (dd, $J = 14.3$, 5.8 Hz, 1 H), 2.78-2.86 (m, 1 H), 3.06-3.19 (m, 2 H), 4.18-4.26 (m, 2 H), 6.87 (s, 1 H), 7.58-7.65 (m, 4 H), 7.72-7.76 (m, 2 H), 8.00-8.08 (m, 4 H), 9.79-9.81 (m, 1 H); ^{13}C NMR (CDCl_3 , 125 MHz) δ 14.3 (q), 19.0 (t), 25.8 (t), 29.6 (t), 33.6 (d), 34.4 (t), 43.5 (t), 61.0 (t), 87.5 (s), 125.8 (s), 128.8 (d), 128.9 (d), 131.0 (d), 131.5 (d), 134.8 (d), 134.8 (d), 135.8 (s), 136.7 (s), 141.6 (d), 165.5 (s), 201.5 (s); exact mass (electrospray) m/z calcd for $\text{C}_{25}\text{H}_{28}\text{NaO}_7\text{S}_2$ 527.1169, found 527.1165.

Ethyl (3*R*)-5,5-bis(benzenesulfonyl)-3-[(4*E*)-6-oxohex-4-en-1-yl]cyclohex-1-ene-1-carboxylate (72.3).

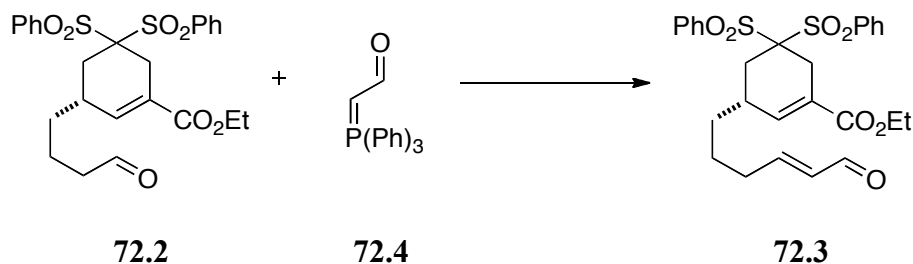

Formylmethyltriphenylphosphorane: *n*-BuLi (2.5 M in hexanes, 1.50 mL, 3.53 mmol) was added to a stirred and cooled (0 °C) suspension of methyltriphenylphosphonium bromide (1.20 g, 3.36 mmol) in Et₂O (6 mL) and stirring was continued for 1 h. A solution of ethyl formate (2.00 mL, 0.025 mol) in Et₂O (1 mL + 1 mL rinse) was added by syringe and the solution was swirled by hand for 5 min (the mixture was quite thick). The cooling bath was removed, and the mixture was stirred vigorously for 2 h before being quenched with dilute hydrochloric acid (0.5 M). The organic phase was extracted with dilute hydrochloric acid (0.5 M), and the combined aqueous phases were basified (universal pH paper turns blue) with aqueous NaOH (30% w/v solution). The basic aqueous solution was extracted twice with Et₂O, and the combined organic extracts were washed with brine, dried (MgSO₄), and evaporated to afford the Wittig reagent **72.4**.

The crude Wittig reagent was then dissolved in dry THF (5 mL), and a solution of **72.2** (0.139 g, 0.27 mmol) in THF (1 mL + 1 mL rinse) was added by syringe. The mixture was refluxed overnight, allowed to cool to room temperature, quenched with dilute hydrochloric acid (0.5 M) and extracted twice with EtOAc. The combined organic extracts were washed with brine, dried (MgSO₄), and evaporated. Flash chromatography of the residue over silica gel (1.3 x 15 cm), using a gradient elution of 40%, 42%...50% EtOAc-hexanes, gave **72.3** (0.056 g, 54%) as a yellow oil: $[\alpha]_D^{25} -13.8$ ($c = 0.30$, CHCl₃); FTIR (CHCl₃ cast) 2851, 2740, 1708, 1689 cm⁻¹; ¹H NMR (CDCl₃, 500 MHz) δ 1.30 (t, $J = 7.2$ Hz, 3 H), 1.42-1.50 (m, 1 H), 1.50-1.67 (m, 3 H), 1.93 (dd, $J = 14.2, 11.0$ Hz, 1

H), 2.36-2.41 (m, 2 H), 2.64 (dd, $J = 14.3, 5.7$ Hz, 1 H), 2.80-2.87 (m, 1 H), 3.08-3.20 (m, 2 H), 4.19-4.25 (m, 2 H), 6.15 (dd, $J = 15.7, 7.9$ Hz, 1 H), 6.84 (dt, $J = 15.6, 6.8$ Hz, 1 H), 6.86 (s, 1 H), 7.58-7.65 (m, 4 H), 7.72-7.78 (m, 2 H), 8.00-8.08 (m, 4 H), 9.55 (d, $J = 7.8$ Hz, 1 H); ^{13}C NMR (CDCl_3 , 125 MHz) δ 14.3 (q), 24.8 (t), 25.9 (t), 29.6 (t), 32.5 (t), 33.5 (d), 34.5 (t), 61.0 (t), 87.5 (s), 125.8 (s), 128.8 (d), 128.9 (d), 131.0 (d), 131.5 (d), 133.5 (d), 134.8 (d), 134.8 (d), 135.8 (s), 136.6 (s), 141.5 (d), 157.2 (d), 165.5 (s), 193.8 (d); exact mass (electrospray) m/z calcd for $\text{C}_{27}\text{H}_{30}\text{NaO}_7\text{S}_2$ 553.1325, found 553.1319.

(2*R*)-2-[3,3-Bis(phenylsulfanyl)propyl]-6-[(*tert*-butyldimethylsilyl)-oxy]-*N*-[(1*S*,2*S*)-1-hydroxy-1-phenylpropan-2-yl]-*N*-methylhexanamide (57.2).

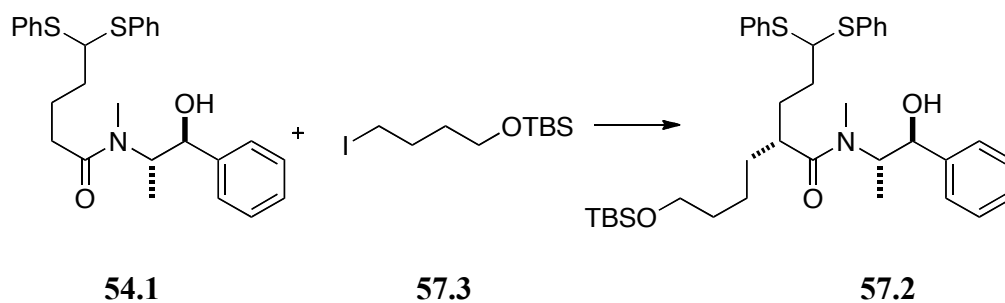

i-Pr₂NEt (0.32 mL, 2.25 mmol) was added to a stirred suspension of LiCl (0.262 g, 6.00 mmol) in THF (1.2 mL) and the mixture was cooled to -78 °C. *n*-BuLi (2.36 M in hexanes, 0.89 mL, 2.10 mmol) was added and the mixture was stirred for 15 min, after which time it was stirred at 0 °C for 15 min. The mixture was recooled to -78 °C, **54.1** (3 mL of a 0.33 M stock solution in THF, 1.00

mmol) was added by syringe and the mixture was stirred for 1 h. Stirring was continued for 15 min at 0 °C, 15 min at room temperature and another 10 min at 0 °C. A solution of freshly prepared **57.3** (0.629 g, 2.00 mmol) in THF (1 mL + 0.5 mL rinse) was added by syringe and stirring at 0 °C was continued for 5 h. The mixture was quenched with saturated aqueous NH₄Cl and extracted with EtOAc. The combined organic extracts were dried (MgSO₄), and evaporated. Flash chromatography of the residue over silica gel (2.2 x 15 cm), using a gradient elution of 5%, 15%, 24%, 26%...28% EtOAc-hexanes, gave **57.2** (0.284 g, 44%) as a clear semi-solid consisting of two rotamers: $[\alpha]_D^{25} +40.55$ ($c = 0.68$, CHCl₃); FTIR (CHCl₃ cast) 3384, 1618 cm⁻¹; ¹H NMR (5.5:1 rotamer ratio, asterisk denotes minor rotamer, CDCl₃, 500 MHz) δ 0.04-0.08 (m, 6 H), 0.90 (s, 9 H), 1.10 (d, $J = 7.0$ Hz, 2 H), 1.16-1.28 (m, 2 H), 1.30-1.40 (m, 1 H), 1.42-1.50 (m, 2 H), 1.50-1.60 (m, 1 H), 1.72-1.84 (m, 3 H), 1.86-2.00 (m, 2 H), 2.50-2.58 (m, 1 H), 2.79 (s, 2.5 H), *2.89 (s, 0.5 H), 3.52-3.64 (m, 2 H), 4.32-4.40 (m, 2 H), 4.60 (t, $J = 7.2$ Hz, 1 H), 7.25-7.36 (m, 11 H), 7.40-7.50 (m, 4 H), (OH signal missing); ¹³C NMR (CDCl₃, 125 MHz) δ -5.21, -5.20, 14.5, 15.6, 18.4, 23.6, 23.9, 26.0, 27.0, 30.0, 30.1, 32.0, 32.7, 33.0, 33.1, 33.2, 33.5, 40.9, 40.9, 58.1, 58.3, 58.4, 63.0, 63.2, 75.4, 76.2, 126.2, 126.9, 127.5, 127.7, 127.8, 128.3, 128.4, 128.8, 128.9, 132.7, 132.8, 134.0, 134.1, 141.2, 176.4, 177.6; exact mass (electrospray) m/z calcd for C₃₇H₅₃NNaO₃S₂Si 674.3128, found 674.3120.

(2*R*)-2-[3,3-Bis(phenylsulfanyl)propyl]-6-[(*tert*-butyldimethylsilyl)-oxy]hexan-1-ol (**59.3**).

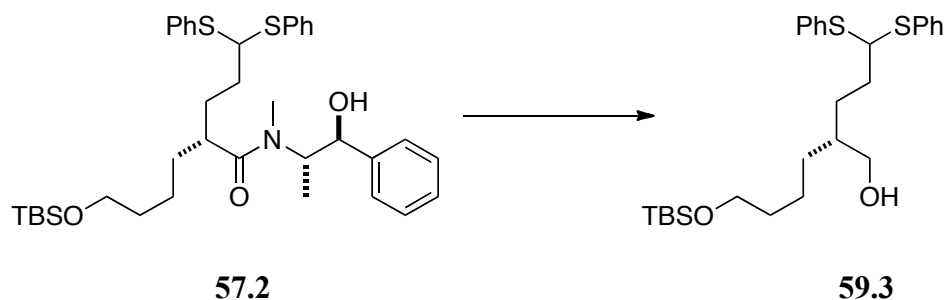

n-BuLi (2.36 M in hexanes, 0.72 mL, 1.66 mmol) was added to a stirred and cooled (-78 °C) solution of *i*-Pr₂NH (0.24 mL, 1.74 mmol) in THF (2.5 mL). The solution was stirred at 0 °C for 10 min, after which time NH₃·BH₃ (90% technical grade, 0.054 g, 1.74 mmol) was added in one lot, and stirring was continued for 15 min. The cooling bath was removed and stirring was continued for 20 min, after which time the solution was returned to 0 °C. A solution of **57.2** (0.284 g, 0.44 mmol) in THF (2 mL + 2 mL rinse) was added by syringe, the cooling bath was removed, and stirring was continued for 2 h. The mixture was quenched with water and extracted three times with EtOAc. The combined organic extracts were washed with brine, dried (MgSO₄), and evaporated. Flash chromatography of the residue over silica gel (1.7 x 15 cm), using 8%, 10%, 12%, 14% EtOAc-hexanes, gave **59.3** (0.154 g, 72%) as a clear oil: $[\alpha]_D^{25} +0.75$ ($c = 0.48$, CHCl₃); FTIR (CHCl₃ cast) 3381 cm⁻¹; ¹H NMR (CDCl₃, 500 MHz) δ 0.09 (s, 6 H), 0.92 (s, 9 H), 1.22-1.38 (m, 5 H), 1.44-1.53 (m, 3 H), 1.60-1.72 (m, 2 H), 1.86-1.93 (m, 2 H), 3.46-3.54 (m, 2 H), 3.62 (t, $J = 6.5$ Hz, 2 H), 4.42 (t, $J = 6.4$

Hz, 1 H), 7.28-7.35 (m, 6 H), 7.48-7.51 (m, 4 H); ^{13}C NMR (CDCl_3 , 125 MHz) δ -5.2 (q), 18.4 (t), 23.0 (t), 26.0 (q), 28.2 (t), 30.6 (t), 33.1 (t), 40.2 (d), 58.8 (d), 63.1 (s), 65.3 (t), 127.7 (d), 128.9 (d), 132.7 (d), 134.3 (s), 134.3 (s); exact mass (electrospray) m/z calcd for $\text{C}_{27}\text{H}_{42}\text{NaO}_2\text{S}_2\text{Si}$ 513.2288, found 513.2289.

(2*R*)-2-[3,3-Bis(phenylsulfanyl)propyl]-6-[(*tert*-butyldimethylsilyl)-oxy]hexanal (61.2).

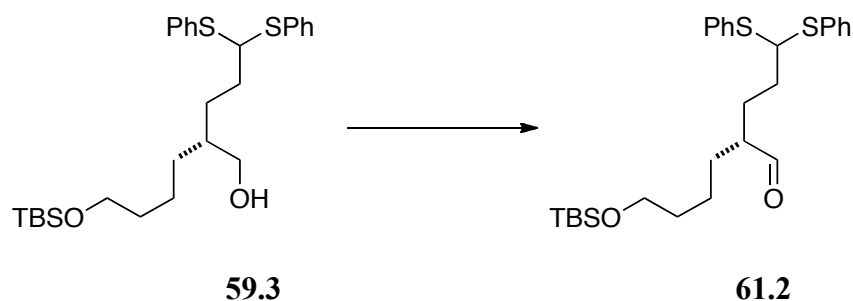

NaOAc (0.690 g, 8.40 mmol), 4 Å molecular sieves (0.5 g), and PCC (0.725 g, 3.36 mmol) were added to a stirred solution of **59.3** (0.825 g, 1.68 mmol) in CH_2Cl_2 (15 mL). Stirring was continued for 30 min and then Celite was added. The resulting slurry was filtered through a pad of Celite (rinsed with CH_2Cl_2) and the filtrate was evaporated. Flash chromatography of the residue over silica gel (2.7 x 15 cm), using a gradient elution of 4%, 6%, 8% EtOAc-hexanes, gave **61.2** (0.584 g, 71%) as a clear oil: $[\alpha]_D^{25}$ -4.06 ($c = 0.34$, CHCl_3); FTIR (CHCl_3 cast) 2856, 2708, 1725 cm^{-1} ; ^1H NMR (CDCl_3 , 500 MHz) δ 0.08 (s, 6 H), 0.92 (s, 9 H), 1.28-1.56 (m, 5 H), 1.58-1.70 (m, 1 H), 1.78-2.02 (m, 4 H), 2.20-2.26 (m, 1 H), 3.61 (t, $J = 6.4$ Hz, 2 H), 4.40 (t, $J = 6.2$ Hz, 1 H), 7.28-7.36

(m, 6 H), 7.46-7.50 (m, 4 H), 9.55 (d, $J = 6.2$ Hz, 1 H); ^{13}C NMR (CDCl_3 , 125 MHz) δ -5.2 (q), 18.4 (t), 23.3 (t), 25.9 (t), 26.0 (q), 28.6 (t), 32.8 (t), 33.1 (t), 51.4 (d), 58.4 (d), 62.8 (s), 127.9 (d), 129.0 (d), 132.8 (d), 132.8 (d), 143.0 (s), 204.5 (d); exact mass (electrospray) m/z calcd for $\text{C}_{27}\text{H}_{40}\text{NaO}_2\text{S}_2\text{Si}$ 511.2131, found 511.2132.

Methyl (4*R*)-4-[3,3-bis(phenylsulfanyl)propyl]-8-[(*tert*-butyldimethylsilyl)oxy]-3-hydroxy-2-methyl-2-(phenylselanyl)octanoate (64.3).

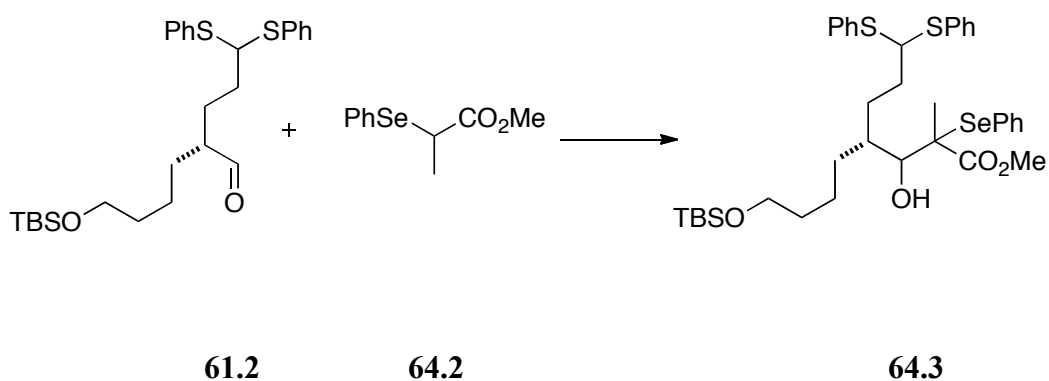

n-BuLi (2.36 M in hexanes, 0.62 mL, 1.47 mmol) was added to a stirred and cooled (-78 °C) solution of *i*-Pr₂NH (0.21 mL, 1.47 mmol) in THF (6 mL) and stirring was continued for 5 min. The solution was then stirred at 0 °C for 20 min and recooled to -78 °C. A solution of **64.2** (0.358 g, 1.47 mmol) in THF (3 mL + 1 mL rinse) was added and stirring was continued for 50 min. A solution of **61.2** (0.514 g, 1.05 mmol) in THF (3 mL + 3 mL rinse) was added and the mixture was stirred for 2.5 h. The reaction was quenched with saturated aqueous NH_4Cl , followed by water. The mixture was allowed to warm to room

temperature and was extracted twice with EtOAc. The combined organic extracts were washed with brine, dried (MgSO_4), and evaporated. Flash chromatography of the residue over silica gel (2.7 x 15 cm), using a gradient elution of 2%, 4%...10% EtOAc-hexanes, gave **64.3** (0.726 g, 94%) as a clear semi-solid. This material was a partially separable mixture of less and more polar components, each composed of two diastereoisomers; the two components were characterized by spectroscopic analysis. Following this analysis, the components were then combined and carried forward to the next step.

Less polar mixture of diastereoisomers: FTIR (CHCl_3 cast) 3478, 1728, 1705 cm^{-1} ; ^1H NMR (1.2:1 mixture of diastereoisomers, minor diastereoisomer denoted by an asterisk, CDCl_3 , 500 MHz) δ 0.06 (s, 3 H), 0.07 (s, 3 H), 0.90-0.92 (m, 9 H), 1.06-1.26 (m, 3 H), 1.30-1.62 (m, 8 H), 1.68-1.86 (m, 2 H), 1.92-2.02 (m, 1 H), *2.78 (d, $J = 3.3$ Hz, 0.44 H), 2.84 (d, $J = 3.1$ Hz, 0.53 H), 3.52-3.55 (m, 4 H), 3.60 (t, $J = 6.6$ Hz, 1 H), 3.92-3.96 (m, 1 H), *4.35 (t, $J = 6.4$ Hz, 0.46 H), 4.41 (t, $J = 6.1$ Hz, 0.54 H), 7.26-7.35 (m, 8 H), 7.40-7.49 (m, 5 H), 7.56-7.60 (m, 2 H); ^{13}C NMR (CDCl_3 , 125 MHz) δ -5.20, -5.17, 17.3, 17.4, 18.4, 22.76, 22.83, 26.0, 26.6, 28.5, 28.8, 31.4, 32.8, 33.0, 33.1, 33.3, 36.9, 40.1, 40.3, 51.77, 51.84, 58.7, 58.9, 59.0, 63.0, 63.1, 73.7, 73.8, 126.8, 127.5, 127.67, 127.69, 128.86, 128.87, 129.57, 129.59, 132.44, 132.46, 132.70, 132.74, 134.2, 134.3, 134.5, 134.6, 137.99, 138.02, 173.0, 173.1; exact mass (electrospray) m/z calcd for $\text{C}_{37}\text{H}_{52}\text{NaO}_4\text{S}_2^{77}\text{SeSi}$ 753.2150, found 753.2133.

More polar mixture of diastereoisomers: FTIR (CHCl₃ cast) 3505, 1724 cm⁻¹; ¹H NMR (1.9:1 ratio of diastereoisomers, minor diastereoisomer denoted by an asterisk, CDCl₃, 500 MHz) δ 0.02-0.06 (m, 6 H), 0.89-0.91 (m, 9 H), 1.16-1.28 (m, 3 H), 1.32-1.49 (m, 7 H), 1.60-1.90 (m, 3 H), 1.90-2.00 (m, 1 H), *3.36 (d, $J = 8.0$ Hz, 0.35 H), 3.53-3.60 (m, 3 H), 3.61 (s, 1 H), 3.62 (s, 2 H), *3.86 (dd, $J = 7.9, 1.9$ Hz, 0.35 H), 3.96 (dd, $J = 8.3, 1.9$ Hz, 0.64 H), 4.33 (t, $J = 6.2$ Hz, 0.66 H), *4.39 (t, $J = 6.4$ Hz, 0.35 H), 7.24-7.33 (m, 8 H), 7.37-7.48 (m, 5 H), 7.53-7.57 (m, 2 H); ¹³C NMR (CDCl₃, 125 MHz) δ -5.18, -5.15, 18.38, 18.41, 20.1, 20.5, 23.3, 23.8, 25.6, 26.0, 26.1, 27.8, 29.8, 32.0, 33.09, 33.14, 33.3, 33.6, 39.28, 39.33, 52.2, 52.3, 54.9, 55.1, 58.7, 58.9, 63.0, 63.1, 77.7, 77.8, 126.7, 126.8, 127.65, 127.69, 127.71, 128.82, 128.86, 128.91, 129.5, 132.5, 132.6, 132.8, 134.28, 134.3, 134.3, 138.2, 138.3, 174.8, 175.1; exact mass (electrospray) m/z calcd for C₃₇H₅₂NaO₄S₂⁷⁷SeSi 753.2150, found 753.2132.

Methyl (4R)-4-[3,3-bis(benzenesulfonyl)propyl]-3,8-dihydroxy-2-methylideneoctanoate (64.4).

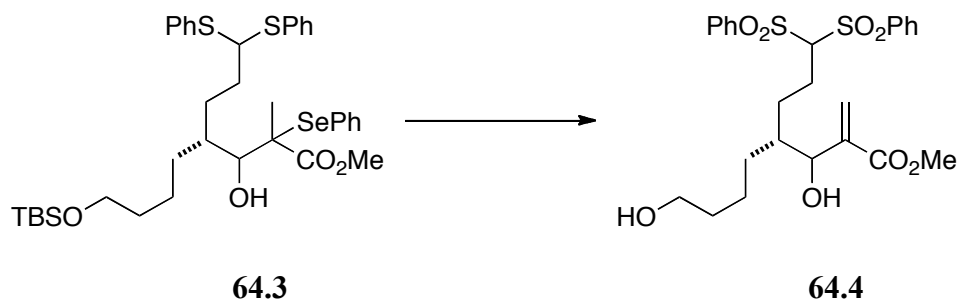

m-CPBA (75% w/w, 1.37 g, 7.93 mmol) was added slowly to a stirred solution of **64.3** (0.726 g, 1.00 mmol) in CH₂Cl₂ (12 mL). The solution was refluxed overnight (orange-red color), cooled to room temperature and quenched with saturated aqueous NaHCO₃ and water. The mixture was extracted twice with CHCl₃, and the combined organic extracts were washed with brine, dried (MgSO₄), and evaporated. Flash chromatography of the residue over silica gel (2.2 x 15 cm), using a gradient elution of 20%, 40%, 80%, 82%, 84%, 86% EtOAc-hexanes, gave **64.4** (0.427 g, 82%) as a white foam composed of two diastereoisomers: FTIR (CHCl₃ cast) 3533, 3398, 1712 cm⁻¹; ¹H NMR (1.2:1 ratio of diastereoisomers, minor diastereoisomer denoted by an asterisk, CDCl₃, 500 MHz) δ 1.16-1.30 (m, 1 H), 1.30-1.44 (m, 3 H), 1.43-1.78 (m, 6 H), 2.10-2.60 (m, 3 H), 3.60-3.66 (m, 2 H), 3.80 (s, 3 H), 4.37 (d, *J* = 5.3 Hz, 0.5 H), 4.41 (t, *J* = 5.5 Hz, 0.55 H), 4.45 (d, *J* = 4.0 Hz, 0.5 H), *4.61 (dd, *J* = 6.4, 5.1 Hz, 0.45 H), 5.81-5.82 (m, 0.55 H), *5.85-5.86 (m, 0.46 H), 6.30 (s, 0.56 H), *6.33 (s, 0.45 H), 7.56-7.61 (m, 4 H), 7.69-7.73 (m, 2 H), 7.94-8.00 (m, 4 H); ¹³C NMR (CDCl₃, 125 MHz) δ 22.7, 22.9, 23.0, 23.3, 27.2, 27.4, 28.6, 30.0, 32.7, 32.8, 40.7, 41.4, 51.97, 52.00, 62.55, 62.59, 72.2, 73.2, 83.2, 84.0, 126.2, 126.4, 129.06, 129.10, 129.61, 129.64, 134.5, 134.6, 137.8, 137.9, 138.00, 138.03, 141.2, 141.3, 166.81, 166.84; exact mass (electrospray) *m/z* calcd for C₂₅H₃₂NaO₈S₂ 547.1431, found 547.1427.

Methyl (4*R*)-3,8-bis(acetyloxy)-4-[3,3-bis(benzenesulfonyl)propyl]-2-methylideneoctanoate (64.5).

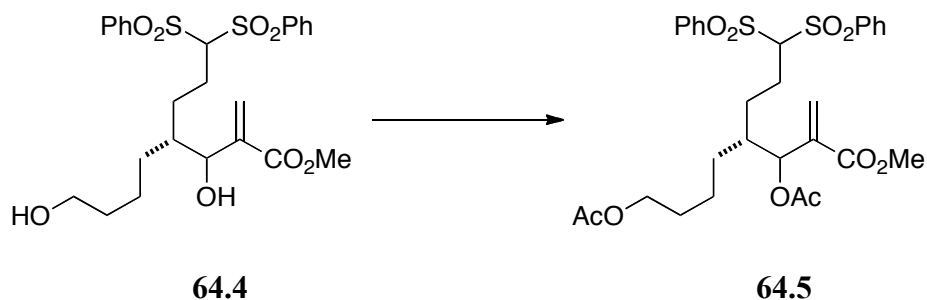

DMAP (0.001 g, 0.08 mmol) was added to a stirred and cooled (0 °C) solution of **64.4** (0.427 g, 0.81 mmol) in CH₂Cl₂ (6 mL). Pyridine (0.40 mL, 4.88 mmol), followed by AcCl (0.46 mL, 6.51 mmol), was added and the solution was stirred overnight. The reaction was quenched with water and the mixture was extracted twice with CHCl₃. The combined organic extracts were washed with brine, dried (MgSO₄), and evaporated. Flash chromatography of the residue over silica gel (2.2 x 15 cm), using a gradient elution of 20%, 40%, 42%, 44%, 46% EtOAc-hexanes, gave **64.5** (0.430 g, 87%) as a white foam composed of two diastereoisomers: FTIR (CHCl₃ cast) 1737 cm⁻¹; ¹H NMR (1.2:1 ratio of diastereoisomers, minor diastereoisomer denoted by an asterisk, CDCl₃, 500 MHz) δ 1.10-1.30 (m, 2 H), 1.32-1.49 (m, 2 H), 1.50-1.70 (m, 3 H), 1.70-1.82 (m, 2 H), *2.06 (s, 1.3 H), 2.07 (s, 1.8 H), *2.10 (s, 1.3 H), 2.11 (s, 1.6 H), 2.20-2.31 (m, 2 H), *3.80 (s, 1.2 H), 3.80 (s, 1.4 H), 4.00-4.08 (m, 2 H), 4.31 (t, *J* = 5.3 Hz, 0.5 H), 4.56 (t, *J* = 5.9 Hz, 0.4 H), 5.61 (d, *J* = 3.0 Hz, 0.4 H), 5.68 (d, *J* = 3.5 Hz, 0.5 H), 5.70-5.71 (m, 1 H), 6.35-6.37 (m, 1 H), 7.58-7.62 (m, 4 H), 7.69-7.74 (m,

2 H), 7.92-8.00 (m, 4 H); ^{13}C NMR (CDCl_3 , 125 MHz) δ 20.93, 20.96, 21.02, 23.1, 23.3, 23.5, 27.7, 28.57, 28.62, 28.8, 29.8, 39.9, 40.0, 52.1, 64.1, 64.2, 72.3, 72.6, 83.2, 83.8, 126.2, 126.3, 129.09, 129.13, 129.54, 129.56, 129.58, 129.7, 134.5, 134.55, 134.59, 134.61, 137.75, 137.83, 138.98, 138.09, 138.2, 138.4, 165.5, 165.6, 169.7, 171.19, 171.20; exact mass (electrospray) m/z calcd for $\text{C}_{29}\text{H}_{36}\text{NaO}_{10}\text{S}_2$ 631.1642, found 631.1635.

Methyl (3*R*)-3-[4-(acetyloxy)butyl]-6,6-bis(benzenesulfonyl)cyclohept-1-ene-1-carboxylate (64.6).

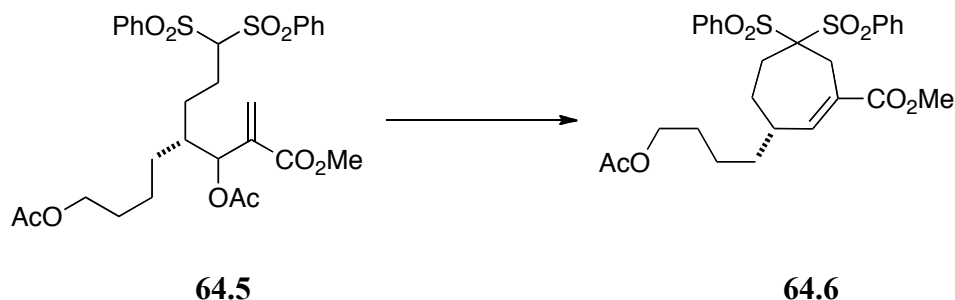

Cs_2CO_3 (0.460 g, 1.41 mmol) was added to a stirred solution of **64.5** (0.430 g, 0.71 mmol) in dry THF (7 mL) and stirring was continued for 2.5 h. The mixture was quenched with water and extracted twice with EtOAc. The combined organic extracts were washed with brine, dried (MgSO_4), and evaporated. Flash chromatography of the residue over silica gel (1.7 x 15 cm), using a gradient elution of 20%, 42%, 44% EtOAc-hexanes, gave **64.6** (0.355 g, 92%) as a white foam: $[\alpha]_D^{25}$ -15.16 ($c = 0.69$, CHCl_3); FTIR (CHCl_3 cast) 1731 cm^{-1} ; ^1H NMR (CDCl_3 , 500 MHz) δ 1.30-1.56 (m, 5 H), 1.62 (app. quintet, $J =$

6.8 Hz, 2 H), 1.84-1.92 (m, 1 H), 2.3 (s, 3 H), 2.36 (ddd, $J = 15.9, 8.4, 2.1$ Hz, 1 H), 2.48-2.59 (m, 2 H), 3.56 (AB q, $J_{AB} = 16.0$ Hz, $\Delta\nu_{AB} = 69.8$ Hz, 2 H), 3.78 (s, 3 H), 4.3 (t, $J = 6.6$ Hz, 2 H), 6.85 (d, $J = 5.1$ Hz, 1 H), 7.58-7.63 (m, 4 H), 7.70-7.75 (m, 2 H), 8.03-8.05 (m, 2 H), 8.09-8.12 (m, 2 H); ^{13}C NMR (CDCl_3 , 125 MHz) δ 21.0 (q), 23.3 (t), 25.1(t), 25.8 (t), 27.0 (t), 28.6 (t), 35.0 (t), 40.3 (d), 52.4 (q), 64.2 (t), 89.8 (s), 126.2 (s), 128.7 (d), 128.8 (d), 131.4 (d), 131.5 (d), 134.6 (d), 134.6 (d), 136.3 (s), 136.8 (s), 144.8 (d), 167.3 (s), 171.1 (s); exact mass (electrospray) m/z calcd for $\text{C}_{27}\text{H}_{32}\text{NaO}_8\text{S}_2$ 571.1431, found 571.1428.

Penta-1,4-dien-3-ol (66.3).⁷⁷

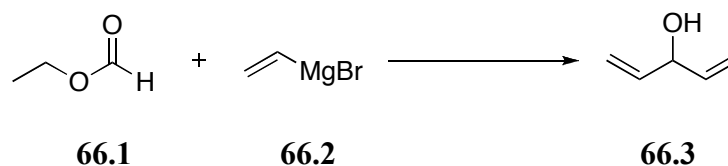

Mg metal shavings (13.0 g, 0.53 mol) were added to THF (300 mL) in a dry, 3-necked 1 L flask fitted with a condenser and a 250 mL addition funnel containing a solution of vinyl bromide (56.0 g, 0.46 mol) in THF (56 mL). Approximately 15 mL of the vinyl bromide solution was added to the turnings and the reaction was initiated with gentle heating from a heat gun. Following initiation (solution boiling gently), the remaining solution of vinyl bromide was added dropwise **carefully** so as to maintain a gentle reflux and the addition funnel was rinsed with THF (5 mL). Following the addition, the mixture was refluxed (oil bath) for 1.5 h and then cooled to 0 °C. A solution of ethyl formate (66.1)

(10 mL, 0.124 mol) in THF (40 mL) was added dropwise from the addition funnel to the stirred solution. The cooling bath was left in place but not recharged and stirring was continued overnight. The reaction was quenched with dilute hydrochloric acid (300 mL, 3 N), and the mixture was extracted three times with Et₂O. The combined organic extracts were washed with brine, dried (MgSO₄), and distilled at atmospheric pressure, using a conventional distillation apparatus to remove Et₂O. The resulting concentrated solution of **66.3** in THF (approx. 50 mL) was then used directly in the next step.

Ethyl (4E)-hepta-4,6-dienoate (66.5).⁷⁷

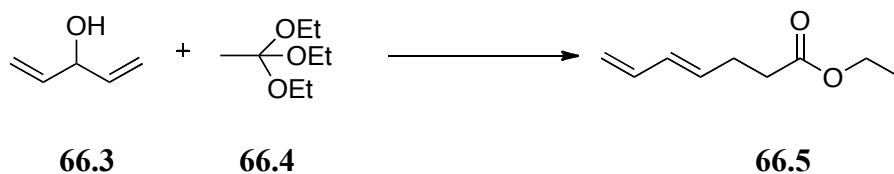

Benzene (200 mL), ethyl orthoacetate (**66.4**) (80 mL, 0.44 mol) and propionic acid (0.5 mL, 6.70 mmol), were added to the solution of **66.3** in THF and the mixture was refluxed overnight. The solvents were removed at atmospheric pressure using a standard distillation apparatus. Side products and other contaminants were removed by vacuum distillation (20 mm Hg, oil bath at 90 °C) until no more drops came over. The final purification was by high vacuum distillation (0.5 mm Hg, oil bath at 60 °C) to give **66.5** (11.4 g, 60% over 2 steps): bp 45 °C; FTIR (neat film) 1738 cm⁻¹; ¹H NMR (CDCl₃, 500 MHz) δ 1.35 (t, *J* = 7.1 Hz, 3 H), 2.39-2.42 (m, 4 H), 4.20 (q, *J* = 7.2 Hz, 2 H), 4.98-5.00

(m, 1 H), 5.09-5.14 (m, 1 H), 5.53-5.60 (m, 1 H), 6.06-6.11 (m, 1 H), 6.29 (dt, $J = 16.9, 10.4$ Hz, 1 H); ^{13}C NMR (CDCl_3 , 125 MHz) δ 14.2 (q), 27.8 (t), 33.9 (t), 60.3 (t), 115.7 (t), 131.9 (d), 132.6 (d), 136.9 (d), 172.9 (s); exact mass (electron impact) m/z calcd for $\text{C}_9\text{H}_{14}\text{O}_2$ 154.0994, found 154.0993.

(4E)-Hepta-4,6-dien-1-ol (66.6).⁷⁸

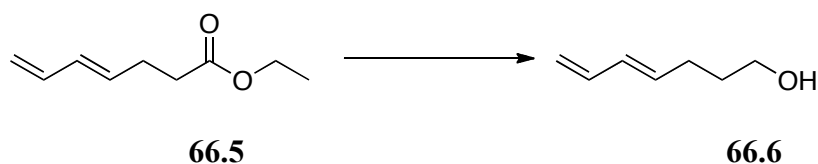

A solution of **66.5** (11.4 g, 0.074 mol), in Et_2O (20 mL) was added dropwise to a stirred and cooled ($0\text{ }^\circ\text{C}$) suspension of LiAlH_4 (95%, 6.44 g, 0.17 mol) in Et_2O (100 mL). The cooling bath was removed and the suspension was allowed to warm to room temperature and the mixture was then refluxed for 6 h. The mixture was cooled to $0\text{ }^\circ\text{C}$ and quenched by slow addition of water (6 mL), aqueous NaOH (15% w/v, 6 mL), and water (18 mL). MgSO_4 was added to the mixture to create a slurry which was filtered through a pad of Celite. Evaporation of the filtrate and flash chromatography of the residue over silica gel (4.5 x 10 cm), using a gradient elution of 10%, 30%, 35% EtOAc -hexanes, gave **66.6** (5.13 g, 62%) as an oil. This was further purified by vacuum distillation (20 mm Hg): bp $84\text{ }^\circ\text{C}$; FTIR (neat film) 3333 cm^{-1} ; ^1H NMR (CDCl_3 , 300 MHz) δ 1.57 (s, 1 H), 1.69 (pentet, $J = 6.8$ Hz, 2 H), 2.20 (q, $J = 7.2$ Hz, 2 H), 3.66 (t, $J = 6.5$ Hz, 2 H), 4.95-5.01 (m, 1 H), 5.06-5.14 (m, 1 H), 5.71 (dt, $J = 15.2, 6.9$ Hz, 1

H), 6.03-6.14 (m, 1 H), 6.31 (dt, $J = 17.0, 10.3$, 1 H); ^{13}C NMR (CDCl_3 , 125 MHz) δ 28.8 (t), 32.1 (t), 62.4 (t), 115.1 (t), 131.5 (d), 134.3 (d), 137.1 (d).

(3E)-7-Iodohepta-1,3-diene (55.6).⁷⁹



Triphenylphosphine (1.93 g, 7.35 mmol), followed by imidazole (1.00 g, 0.015 mol), was added to a solution of **66.6** (0.550 g, 4.90 mmol) in CH_2Cl_2 (20 mL) and the solution was cooled to 0 °C. Iodine (1.62 g, 6.37 mmol) was added and the reaction mixture was stirred for 10 min at 0 °C before the cooling bath was removed. Stirring was continued for 1 h and Et_2O (10 mL) was added to the mixture which was then poured onto saturated aqueous NaHCO_3 (15 mL) with swirling. The aqueous phase was extracted twice with CH_2Cl_2 and the combined organic extracts were washed with brine, dried and evaporated at room temperature with SiO_2 (5 g). The resulting solid was poured onto a bed (3.5 x 8 cm) of silica gel made up with pentane, and flash chromatography, using 100% pentane, gave **55.6** (1.00 g, 90%): FTIR (neat film) 1652 cm^{-1} ; ^1H NMR (CDCl_3 , 500 MHz) δ 1.92 (pentet, $J = 7.11$ Hz, 2 H), 2.20 (q, $J = 7.8$ Hz, 2 H), 3.19 (t, $J = 6.9$ Hz, 2 H), 4.99-5.01 (m, 1 H), 5.09-5.14 (m, 1 H), 5.64 (dt, $J = 15.5, 6.7$ Hz, 1 H), 6.08-6.14 (m, 1 H), 6.10 (dt, $J = 17.0, 11.2$ Hz, 1 H); ^{13}C NMR (CDCl_3 , 125

MHz) δ 6.3 (t), 32.7 (t), 33.1 (t), 115.6 (t), 132.3 (d), 132.5 (d), 136.9 (d); exact mass (electron impact) m/z calcd for $C_7H_{11}I$ 221.9906, found 221.9907.

(2*R*,6*E*)-2-[2,2-Bis(phenylsulfanyl)ethyl]-*N*-[(1*S*,2*S*)-1-hydroxy-1-phenylpropan-2-yl]-*N*-methylnona-6,8-dienamide (55.5).

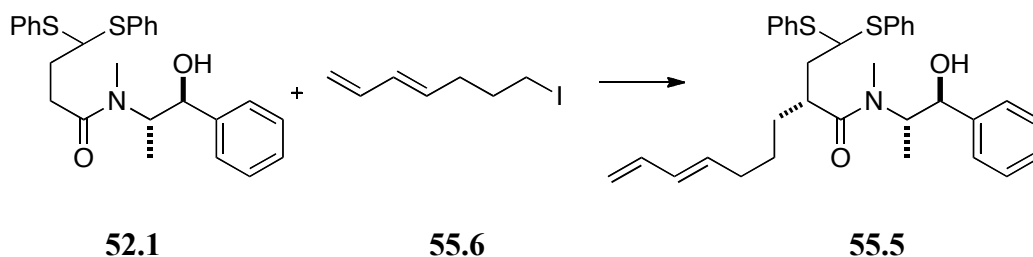

i-Pr₂NH (0.32 mL, 2.25 mmol) was added to a stirred suspension of LiCl (0.262 g, 6.00 mmol) in THF (1.2 mL) and the mixture was cooled to -78 °C. *n*-BuLi (2.5 M in hexanes, 0.86 mL, 2.10 mmol) was added and the mixture was stirred for 15 min, after which time it was stirred at 0 °C for 15 min. The mixture was recooled to -78 °C, and **52.1** (3.0 mL of a 0.33 M stock solution in THF, 1.00 mmol) was added by syringe. Stirring at -78 °C was continued for 1 h, then for 15 min at 0 °C, 15 min at room temperature and, finally, 10 min at 0 °C. A solution of freshly prepared **55.6** (0.444 g, 2.00 mmol) in THF (1 mL + 1.0 mL rinse) was added by syringe and the mixture was stirred for 10 h at 0 °C. The mixture was quenched with saturated aqueous NH₄Cl and partitioned between EtOAc and water. The aqueous layer was extracted twice with EtOAc and the combined organic extracts were dried (MgSO₄) and evaporated. Flash chromatography of the residue over silica gel (2.5 x 15 cm), using a gradient elution of 5%, 15%,

26%, 28%, 30% EtOAc-hexanes, gave **55.5** (0.492 g, 90%) as a yellow oil consisting of two rotamers: $[\alpha]_D^{25} +35.24$ ($c = 0.93$, CHCl_3); FTIR (CHCl_3 cast) 3385, 1684, 1616 cm^{-1} ; ^1H NMR (6.1:1 rotamer ratio, asterisk denotes minor rotamer, CDCl_3 , 500 MHz) δ *0.91 (d, $J = 6.7$ Hz, 0.60 H), 1.09 (d, $J = 6.9$ Hz, 2.40 H), 1.12-1.52 (m, 4 H), 1.66-1.71 (m, 1 H), 1.84 (ddd, $J = 14.2, 10.1, 4.3$ Hz, 1 H), 1.92-2.14 (m, 2 H), 2.44 (ddd, $J = 14.4, 9.7, 4.8$ Hz, 1 H), 2.88-2.94 (m, 3 H), 3.06-3.19 (m, 1 H), 4.38-4.48 (m, 2 H), 4.54-4.62 (m, 1 H), 4.92-5.02 (m, 1 H), 5.04-5.14 (m, 1 H), 5.59 (dt, $J = 15.1, 7.0$ Hz, 1 H), 5.95-6.08 (m, 1 H), 6.29 (dt, $J = 16.9, 10.3$ Hz, 1 H), 7.20-7.38 (m, 12 H), 7.40-7.51 (m, 3 H); ^{13}C NMR (CDCl_3 , 125 MHz) δ 14.5, 15.2, 26.5, 26.8, 27.1, 31.6, 32.4, 32.6, 33.7, 38.6, 38.8, 39.3, 39.9, 55.0, 55.7, 58.0, 59.6, 75.5, 76.2, 114.8, 115.1, 126.3, 127.0, 127.0, 127.4, 127.6, 127.7, 127.8, 128.4, 128.5, 128.8, 128.9, 129.0, 131.2, 131.4, 131.6, 131.8, 132.0, 132.5, 133.4, 133.5, 134.3, 134.4, 134.5, 134.9, 137.1, 137.3, 142.4, 175.6, 177.0; exact mass (electrospray) m/z calcd for $\text{C}_{33}\text{H}_{39}\text{NNaO}_2\text{S}_2$ 568.2314, found 568.2306.

(2*R*,6*E*)-2-[2,2-Bis(phenylsulfanyl)ethyl]nona-6,8-dien-1-ol (68.1).

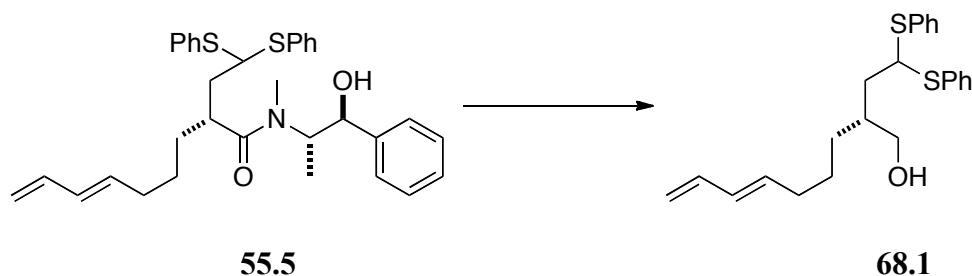

n-BuLi (2.5 M in hexanes, 0.79 mL, 1.97 mmol) was added to a stirred and cooled (-78 °C) solution of *i*-Pr₂NH (0.28 mL, 2.02 mmol) in THF (5 mL). The solution was stirred at 0 °C for 10 min, after which time NH₃·BH₃ (90% technical grade, 0.069 g, 2.02 mmol) was added in one lot, and stirring was continued for 15 min. The cooling bath was removed and stirring was continued for 20 min, after which time the solution was returned to 0 °C. A solution of **55.5** (0.276 g, 0.51 mmol) in THF (2 mL + 2 mL rinse) was added by syringe, the cooling bath was removed, and stirring was continued at 60 °C for 2 h. The mixture was cooled to room temperature, quenched with dilute hydrochloric acid (0.5 M) and extracted three times with EtOAc. The combined organic extracts were washed with brine, dried (MgSO₄), and evaporated. Flash chromatography of the residue over silica gel (1.7 x 15 cm), using 10%, 12%...18% EtOAc-hexanes, gave **68.1** (0.158 g, 81%) as a clear oil: $[\alpha]_D^{25} +10.19$ ($c = 0.73$, CHCl₃); FTIR (CHCl₃ cast) 3392 cm⁻¹; ¹H NMR (CDCl₃, 400 MHz) δ 1.20-1.38 (m, 5 H), 1.78-1.86 (m, 1 H), 1.90-2.08 (m, 4 H), 3.48-3.55 (m, 1 H), 3.56-3.63 (m, 1 H), 4.54 (dd, $J = 7.9, 6.7$ Hz, 1 H), 4.97 (d, $J = 10.2$ Hz, 1 H), 5.09 (d, $J = 17.0$ Hz, 1 H), 5.64 (dt, $J = 15.2, 7.0$, 1 H), 5.99-6.05 (m, 1 H), 6.29 (dt, $J = 16.9, 10.3$ Hz, 1 H), 7.20-7.40 (m, 6 H), 7.40-7.46 (m, 4 H); ¹³C NMR (CDCl₃, 125 MHz) δ 26.2 (t), 30.6 (t), 32.6 (t), 38.2 (t), 38.3 (d), 56.6 (d), 65.3 (t), 114.8 (t), 127.7 (d), 127.8 (d), 131.3 (d), 132.7 (d), 132.8 (d), 134.1 (s), 134.3 (s), 134.7 (d), 137.2 (d); exact mass (electrospray) m/z calcd for C₂₃H₂₈NaOS₂ 407.1474, found 407.1469.

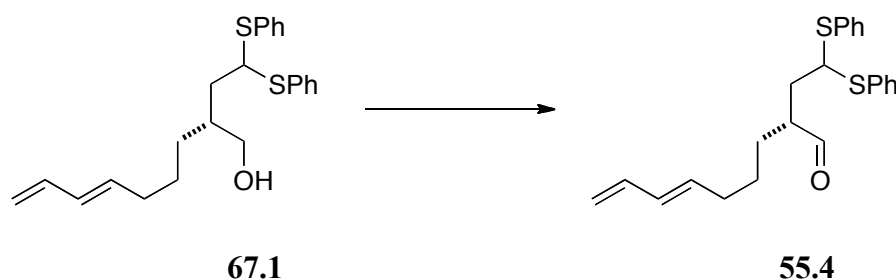
(2*R*,6*E*)-2-[2,2-Bis(phenylsulfanyl)ethyl]nona-6,8-dienal (55.4).

PCC (0.056 g, 0.26 mmol) was added to a stirred solution of **67.1** (0.050 g, 0.13 mmol) in CH₂Cl₂ (3 mL) and stirring was continued for 3 h. Celite was added and the slurry was filtered through a pad of Celite. Evaporation of the filtrate and flash chromatography of the residue over silica gel (1.7 x 15 cm), using a gradient elution of 2%, 4%, 6% EtOAc-hexanes, gave **55.4** (0.039 g, 78%) as a yellow oil: $[\alpha]_D^{25}$ -23.84 ($c = 0.64$, CHCl₃); FTIR (CHCl₃ cast) 2856, 2715, 1724 cm⁻¹; ¹H NMR (CDCl₃, 300 MHz) δ 1.28-1.49 (m, 3 H), 1.58-1.70 (m, 1 H), 1.85 (dddd, $J = 14.6, 13.2, 8.4, 4.8$ Hz, 1 H), 2.06 (AB q, $\Delta\nu_{AB} = 12.2$ Hz, $J_{AB} = 7.5$ Hz, 2 H), 2.28 (ddd, $J = 14.7, 8.4, 6.2$ Hz, 1 H), 2.78-2.89 (m, 1 H), 4.44 (dd, $J = 8.4, 6.2$ Hz, 1 H), 4.96-5.01 (m, 1 H), 5.07-5.15 (m, 1 H), 5.62 (dt, $J = 15.1, 7.3$ Hz, 1 H), 5.90-6.09 (m, 1 H), 6.30 (dt, $J = 16.7, 10.3$ Hz, 1 H), 7.28-7.36 (m, 6 H), 7.42-7.50 (m, 4 H), 9.60 (d, $J = 1.9$ Hz, 1 H); ¹³C NMR (CDCl₃, 100 MHz) δ 26.1 (t), 28.3 (t), 32.3 (t), 34.9 (t), 49.4 (d), 56.3 (d), 115.3 (t), 127.9 (d), 128.1 (d), 129.0 (d), 131.7 (d), 132.6 (d), 133.0 (d), 133.4 (s), 134.0 (s), 137.0 (d), 203.5 (d); exact mass (electrospray) m/z calcd for C₂₃H₂₆NaOS₂ 405.1317, found 405.1317.

Ethyl (4*R*,8*E*)-4-[2,2-bis(phenylsulfanyl)ethyl]-3-hydroxy-2-methyl-2-(phenylselanyl)undeca-8,10-dienoate (69.1).

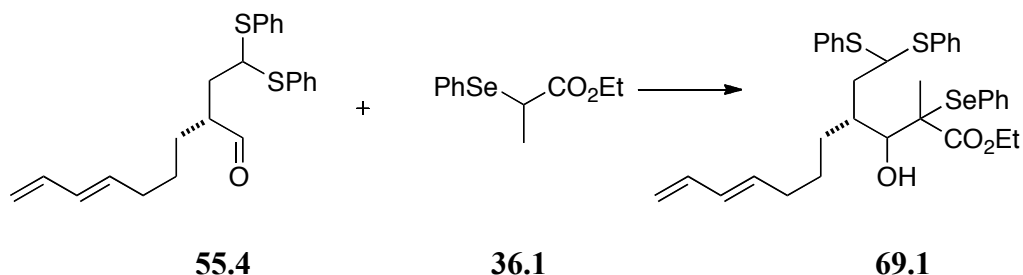

n-BuLi (2.5 M in hexanes, 0.30 mL, 0.74 mmol) was added to a stirred and cooled (-78 °C) solution of *i*-Pr₂NH (0.10 mL, 0.74 mmol) in THF (3 mL) and stirring was continued for 5 min. The solution was then stirred at 0 °C for 20 min and cooled to -78 °C. A solution of **36.1** (0.190 g, 0.74 mmol) in THF (1.5 mL + 1 mL rinse) was added and stirring was continued for 50 min. A solution of **55.4** (0.202 g, 0.53 mmol) in THF (2 mL + 1 mL rinse) was added and the solution was stirred for 2 h at -78 °C. The solution was quenched with saturated aqueous NH₄Cl, followed by water, and allowed to warm to room temperature. The mixture was extracted twice with EtOAc and the combined organic extracts were washed with brine, dried (MgSO₄), and evaporated. Flash chromatography of the residue over silica gel (1.7 x 15 cm), using a gradient elution of 2%, 4%, 6%, 8% EtOAc-hexanes, gave **69.1** (0.265 g, 79%) as a clear semi-solid. This material was a partially separable mixture of less and more polar components, each composed of two diastereoisomers; the two components were characterized

by spectroscopic analysis. Following this analysis, the components were then combined and carried forward to the next step.

Less polar mixture of diastereoisomers: FTIR (CHCl₃ cast) 3500, 1718 cm⁻¹; ¹H NMR (2.3:1 mixture of diastereoisomers, minor diastereoisomer denoted by an asterisk, CDCl₃, 400 MHz) δ 1.06-1.14 (m, 3 H), 1.15-1.40 (m, 3 H), 1.40-1.48 (m, 3 H), 1.58-1.66 (m, 1 H), 1.80-2.04 (m, 4 H), 2.20-2.30 (m, 1 H), *2.88 (d, *J* = 3.1 Hz, 0.27 H), 2.97 (d, *J* = 2.9 Hz, 0.65 H), 3.90-4.02 (m, 3 H), *4.41 (dd, *J* = 7.0, 7.0 Hz, 0.26 H), 4.57-4.62 (m, 0.64 H), 4.94-5.00 (m, 1 H), 5.05-5.13 (m, 1 H), 5.50-5.65 (m, 1 H), 5.91-6.05 (m, 1 H), 6.20-6.35 (m, 1 H), 7.24-7.35 (m, 8 H), 7.39-7.50 (m, 5 H), 7.55-7.60 (m, 2 H); ¹³C NMR (CDCl₃, 100 MHz) δ 13.79, 13.82, 17.3, 17.5, 25.7, 26.1, 28.2, 31.8, 32.5, 32.7, 37.4, 38.1, 38.3, 38.6, 55.8, 57.77, 57.84, 58.8, 58.8, 61.1, 61.2, 73.4, 74.2, 114.8, 126.78, 126.84, 127.4, 127.6, 127.7, 128.9, 128.9, 129.5, 131.3, 132.1, 132.4, 132.9, 133.0, 133.8, 134.3, 134.7, 134.8, 134.9, 137.2, 137.2, 137.9, 138.0, 172.8; exact mass (electrospray) *m/z* calcd for C₃₄H₄₀NaO₃S₂⁷⁷Se 661.1492, found 661.1500.

More polar mixture of diastereoisomers: FTIR (CHCl₃ cast) 3471, 1723, 1693 cm⁻¹; ¹H NMR (3.3:1 ratio of diastereoisomers, minor diastereoisomer denoted by an asterisk, CDCl₃, 500 MHz) δ 1.14-1.20 (m, 3 H), 1.24-1.35 (m, 2 H), 1.36-1.54 (m, 5 H), 1.84 (ddd, *J* = 14.1, 10.8, 3.1 Hz, 1 H), 1.94 (ddd, *J* = 15.1, 10.2, 4.0 Hz, 1 H), 1.98-2.04 (m, 2 H), 2.14-2.28 (m, 1 H), *3.67 (d, *J* = 8.1 Hz, 0.78 H), 3.91 (d, *J* = 8.6 Hz, 0.24 H), 3.96-4.16 (m, 3 H), 4.40 (dd, *J* = 10.8, 4.0 Hz, 0.81 H), *4.55 (dd, *J* = 9.8, 4.7 Hz, 0.25 H), 4.95-5.01 (m, 1 H), 5.06-5.13

(m, 1 H), 5.54- 5.67 (m, 1 H), 5.94-6.04 (m, 1 H), 6.24-6.34 (m, 1 H), 7.24-7.35 (m, 8 H), 7.39-7.53 (m, 5 H), 7.58-7.61 (m, 2 H); ^{13}C NMR (CDCl_3 , 125 MHz) δ 13.88, 13.92, 14.2, 20.2, 20.8, 26.0, 26.5, 27.4, 31.7, 32.58, 32.61, 35.9, 37.4, 37.7, 38.0, 53.9, 54.5, 56.0, 57.7, 61.5, 61.6, 77.6, 77.8, 114.9, 126.7, 126.8, 127.5, 127.6, 127.8, 128.0, 128.79, 128.82, 128.9, 128.93, 129.0, 129.5, 129.6, 131.3, 132.1, 132.2, 132.9, 133.4, 133.5, 134.0, 134.6, 134.8, 134.8, 137.1, 137.2, 138.3, 138.4, 174.8; exact mass (electrospray) m/z calcd for $\text{C}_{34}\text{H}_{40}\text{NaO}_3\text{S}_2^{77}\text{Se}$ 661.1492, found 661.1488.

Ethyl (4*R*,8*E*)-4-[2,2-bis(phenylsulfanyl)ethyl]-3-hydroxy-2-methylideneundeca-8,10-dienoate (71.1).

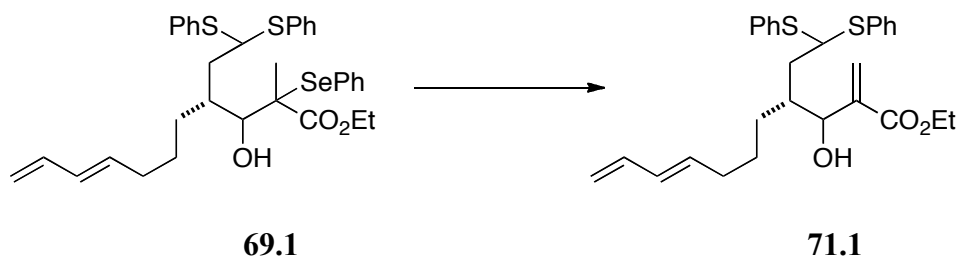

NaHCO_3 (0.031 g, 0.37 mmol), followed by NaIO_4 (0.11 g, 0.52 mmol), was added to a stirred solution of **69.1** (0.195 g, 0.30 mmol), in 5:1 MeOH-water (10 mL). Stirring was continued for 8 h and the mixture was diluted with water and extracted twice with EtOAc. The combined organic extracts were washed with brine, dried (MgSO_4), and evaporated. Flash chromatography of the residue over silica gel (1.7 x 15 cm), using a gradient elution of 4%, 6%...14% EtOAc-hexanes, gave **71.1** (0.072 g, 50%) as a yellow oil: FTIR (CHCl_3 cast) 3496,

1710, 1651 cm^{-1} ; ^1H NMR (CDCl_3 , 500 MHz) δ 1.19-1.43 (m, 7 H), 1.73 (ddd, J = 14.7, 13.7, 6.6 Hz, 1 H), 1.80-1.94 (m, 1 H), 1.96-2.08 (m, 2 H), 2.09-2.22 (m, 2 H), 4.16-4.24 (m, 2 H), 4.40-4.70 (m, 2 H), 4.94-5.00 (m, 1 H), 5.06-5.11 (m, 1 H), 5.57-5.66 (m, 1 H), 5.68-5.71 (m, 1 H), 5.96-6.02 (m, 1 H), 6.20 (s, 1 H), 6.24-6.33 (m, 1 H), 7.25-7.34 (m, 6 H), 7.44-7.53 (m, 4 H); ^{13}C NMR (CDCl_3 , 125 MHz) δ 14.2, 25.9, 26.0, 26.4, 27.6, 27.8, 30.9, 31.0, 31.0, 32.5, 32.6, 35.8, 37.5, 39.3, 39.4, 39.6, 47.8, 56.9, 57.6, 60.6, 60.9, 73.2, 73.3, 114.4, 114.5, 114.8, 114.9, 116.9, 117.0, 125.7, 126.0, 127.6, 127.7, 127.8, 128.8, 128.8, 128.9, 128.9, 129.4, 129.5, 131.2, 131.3, 132.3, 132.3, 132.7, 132.7, 132.8, 132.9, 132.9, 132.9, 133.0, 134.1, 134.2, 134.2, 134.3, 134.4, 134.8, 134.9, 137.2, 137.3, 140.9, 141.0, 141.3, 141.6, 141.6, 141.6, 166.2, 166.4; exact mass (electrospray) m/z calcd for $\text{C}_{28}\text{H}_{34}\text{NaO}_3\text{S}_2$ 505.1842, found 505.1838.

Ethyl (4*R*,8*E*)-3-(acetyloxy)-4-[2,2-bis(phenylsulfanyl)ethyl]-2-methylideneundeca-8,10-dienoate (71.2).

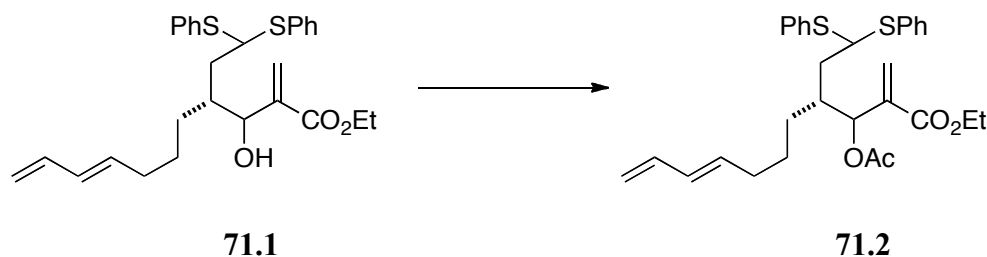

From the more polar mixture of diastereoisomers: DMAP (0.001 g, 0.08 mmol) was added to a stirred solution of **71.1** (0.068 g, 0.14 mmol) in CH_2Cl_2 (3

mL) and the mixture was cooled to 0 °C. Pyridine (0.06 mL, 0.70 mmol), followed by AcCl (0.03 mL, 0.42 mmol), was added, the cooling bath was removed and the solution was stirred for 5 h. The reaction was quenched with water and the mixture was extracted twice with CHCl₃. The combined organic extracts were washed with brine, dried (MgSO₄), and evaporated. Flash chromatography of the residue over silica gel (1.2 x 15 cm), using a gradient elution of 6%, 8%, 10% EtOAc-hexanes, gave **71.2** (0.072 g, 98%) as a clear oil composed of two diastereoisomers: FTIR (CHCl₃ cast) 1746, 1714 cm⁻¹; ¹H NMR (CDCl₃, 500 MHz) δ 1.20-1.52 (m, 7 H), 1.70 (ddd, *J* = 14.0, 8.0, 5.9, 1 H), 1.82 (dd, *J* = 7.0, 7.0 Hz, 1 H), 1.95 (ddd, *J* = 14.7, 9.2, 3.9 Hz, 1 H), 2.00-2.20 (m, 4 H), 2.26-2.32 (m, 1 H), 4.36-4.26 (m, 2 H), 4.32 (dd, *J* = 9.2, 5.8 Hz, 1 H), 4.94-5.00 (m, 1 H), 5.04-5.11 (m, 1 H), 5.50-5.52 (m, 1 H), 5.57-5.66 (m, 1 H), 5.70-5.74 (m, 1 H), 5.95-6.03 (m, 1 H), 6.20 (s, 1 H), 6.25-6.33 (m, 1 H), 7.24-7.34 (m, 6 H), 7.38-7.45 (m, 4 H); ¹³C NMR (CDCl₃, 125 MHz) δ 14.2, 20.8, 20.9, 25.9, 26.3, 27.5, 30.6, 332.4, 32.4, 35.5, 36.7, 37.7, 37.9, 50.1, 57.6, 61.0, 61.1, 72.3, 72.6, 114.9, 117.0, 125.3, 125.6, 127.7, 127.8, 127.8, 127.9, 128.8, 128.9, 128.9, 129.0, 129.6, 131.3, 131.4, 132.7, 133.0, 133.1, 133.2, 133.7, 133.7, 134.1, 134.2, 134.7, 134.7, 137.2, 138.6, 138.7, 164.9, 165.0, 169.6, 169.7; exact mass (electrospray) *m/z* calcd for C₃₀H₃₆NaO₄S₂ 547.1947, found 547.1943.

4. References

- 1 (a) Kane, R. *J. Prakt. Chem.* **1838**, *15*, 129-155. (b) Kane, R. *Ann. Phys.* **1838**, *120 (7)*, 473-494.
- 2 (a) Heathcock, C. H. In *Asymmetric Syntheses Volume 3*; Morrison, J. D. Ed.; Academic Press: New York, **1984**; 111-213. (b) Heathcock, C. H. In *Studies in Organic Chemistry (Amsterdam)*; Buncl, E. Ed.; Elsevier: New York, **1986**; *5B*, 77-237.
- 3 Mukaiyama, T. *Org. React.* **1982**, *28*, 203-331.
- 4 Moon Kim, B.; Williams, S.F.; Masamune, S. In *Comprehensive Organic Synthesis*; Trost, B. M.; Fleming, I. Eds.; Pergamon Press: Oxford, **1991**; 239-275.
- 5 Carreira, E. M. In *Comprehensive Asymmetric Catalysis I-III*; Jacobsen, E. N.; Pfaltz, A.; Yamamoto, H. Eds.; Springer Verlag: Heidelberg, **1999**; *3*, 997-1065.
- 6 Evans, D. A.; Bartroli, J.; Shih, T. L. *J. Am. Chem. Soc.* **1981**, *103*, 2127-2129.
- 7 Corey, E. J.; Lin, S. *J. Am. Chem. Soc.* **1996**, *118*, 8765-8766.
- 8 Komnenos, T. *Liebigs Ann. Chem.* **1883**, *218*, 145-169.
- 9 Michael, A. *J. Prakt. Chem.* **1887**, *35*, 349-356.
- 10 Michael, A. *J. Prakt. Chem.* **1894**, *49*, 20-25.
- 11 Rapson, W. S.; Robinson, R. *J. Chem. Soc.* **1935**, 1285-1288.
- 12 Hajos, Z. G.; Parish, D. R. Application: DE 71-21026623 **1971**.

- 13 Eder, U.; Sauer, G.; Wiechert, R. *Angew. Chem. Int. Ed. Engl.* **1971**, *10*, 496-497.
- 14 Corey, E. J.; Ohno, M.; Mitra, R. B.; Vatakencherry, P. A. *J. Am. Chem. Soc.* **1964**, *86*, 478-485.
- 15 Claisen, L.; Lowman, O. *Ber.* **1887**, *20*, 651-654.
- 16 Dieckmann, W. *Ber.* **1894**, *27*, 102-103.
- 17 Hamasaki, A.; Zimpleman, J. M.; Hwang, I.; Boger, D. L. *J. Am. Chem. Soc.* **2005**, *127*, 10767-10770.
- 18 Nicolaou, K. C.; Snyder, S. A.; Montagnon, T.; Vassilikogiannakis, G. *Angew. Chem. Int. Ed.* **2002**, *41*, 1668-1698.
- 19 (a) Diels, O.; Alder, K. *Ann.* **1926**, *450*, 237-254. (b) Diels, O.; Alder, K. *Ann.* **1928**, *460*, 98-122. (c) Diels, O.; Alder, K. *Ber.* **1929**, *62B*, 2081-2087. (d) Diels, O.; Alder, K. *Ber.* **1929**, *62B*, 2087-2090.
- 20 Woodward, R. B.; Hoffmann, R. *Angew. Chem. Int. Ed. Engl.* **1969**, *8*, 781-853.
- 21 Ozawa, T.; Aoyagi, S.; Kibayashi, C. *J. Org. Chem.* **2001**, *66*, 3338-3347.
- 22 (a) Hayashi, Y.; Rohde, J. J.; Corey, E. J. *J. Am. Chem. Soc.* **1996**, *118*, 5502-5503. (b) Corey, E. J.; Shibata, T.; Lee, T. W. *J. Am. Chem. Soc.* **2002**, *124*, 3808-3809. (c) Ryu, D. H.; Lee, T. W.; Corey, E. J. *J. Am. Chem. Soc.* **2002**, *124*, 9992-9993. (d) Corey, E. J. *Angew. Chem. Int. Ed. Engl.* **2002**, *41*, 16650-16667. (e) Ryu, D. H.; Corey, E. J. *J. Am. Chem. Soc.* **2003**, *125*, 6388-6390.

- 23 Evans, D. A.; Barnes, D. M.; Johnson, J. J.; Lectka, T.; von Matt, P.; Miller, S. J.; Murry, J. A.; Norcross, R. D.; Shaughnessy, E. A.; Campos, K. R. *J. Am. Chem. Soc.* **1999**, *121*, 7582-7594.
- 24 (a) Ahrendt, K. A.; Borths, C. J.; MacMillan, D. W. C. *J. Am. Chem. Soc.* **2000**, *122*, 4243-4244. (b) Northrup, A. B.; MacMillan, D. W. C. *J. Am. Chem. Soc.* **2002**, *124*, 2458-2460.
- 25 Nicolaou, K. C.; Baran, P. S. *Angew. Chem. Int. Ed.* **2002**, *41*, 2678-2720.
- 26 Hartwig, J. *Organotransition metal chemistry: From bonding to catalysis*; University Science Books: Sausalito, Cal., 2010.
- 27 (a) Heck, R. F. *J. Am. Chem. Soc.* **1968**, *90*, 5518-5526. (b) Heck, R. F.; Nolley, J. P. *J. Org. Chem.* **1972**, *37*, 2320-2322. (c) Heck, R. F.; Dieck, H. A. *J. Am. Chem. Soc.* **1974**, *96*, 1133-1136. (d) Heck, R. F. *Org. React.* **1982**, *27*, 345-390. (e) Heck, R. F. *Comprehensive Organic Synthesis*; Trost, B. M., Fleming, I., Eds.; Pergamon Press: Oxford, **1991**, *4*, 833-865.
- 28 (a) Baba, S.; Negishi, E. A. *J. Am. Chem. Soc.* **1976**, *98*, 6729-6731. (b) Negishi, E. A.; Baba, S. *J. Chem. Soc., Chem. Commun.* **1976**, 596-597. (c) King, A. O.; Okukado, N.; Negishi, E. A. *J. Chem. Soc., Chem. Commun.* **1977**, 683-684. (d) Negishi, E. A.; King, A.O., Okukado, N. *J. Org. Chem.* **1977**, *42*, 1821-1823. (e) Negishi, E. A.; Van Horn, D. E. *J. Am. Chem. Soc.* **1977**, *99*, 3168-3170. (f) King, A. O.; Negishi, E., Villani, F. J., Jr.; Silveira, A., Jr. *J. Org. Chem.* **1978**, *43*, 358-360.

- 29 (a) Miyaura, N.; Suzuki, A. *J. Chem. Soc., Chem. Commun.* **1979**, 866-867. (b) Miyaura, N.; Yamada, K.; Suzuki, A. *Tetrahedron Lett.* **1979**, 3437-3440. (c) Miyaura, N.; Yanagi, T.; Suzuki, A. *Synth. Commun.* **1981**, *11*, 513-519. (d) Suzuki, A. *Pure Appl. Chem.* **1985**, *57*, 1749-1758. (e) Suzuki, A. *Pure Appl. Chem.* **1991**, *63*, 419-422.
- 30 (a) Corriu, R. J. P.; Masse, J. P. *J. Chem. Soc., Chem. Commun.* **1972**, 144-144. (b) Tamao, K.; Kiso, Y.; Sumitani, K.; Kumada, M. *J. Am. Chem. Soc.* **1972**, *94*, 9268-9269. (c) Tamao, K.; Sumitani, K.; Kumada, M. *J. Am. Chem. Soc.* **1972**, *94*, 4374-4376. (d) Tamao, K.; Sumitani, K.; Kiso, Y.; Zembayashi, M.; Fukioka, A.; Kodama, S.; Nakajima, I.; Minato, A.; Kumada, M. *Bull. Chem. Soc. Jpn.* **1976**, *49*, 1958-1969.
- 31 (a) Azarian, D.; Dua, S. S.; Eaborn, C.; Walton, D. R. M. *J. Organomet. Chem.* **1976**, *117*, C55-C57. (b) Kosugi, M.; Sasazawa, K.; Shimuzu, Y.; Migata, T. *Chem. Lett.* **1977**, 301-302. (c) Kosugi, M.; Shimuzu, Y.; Migata, T. *Chem. Lett.* **1977**, 1423-1424. (d) Kosugi, M.; Shimuzu, Y.; Migata, T. *J. Organomet. Chem.* **1977**, *129*, C36-C38. (e) Milstein, D.; Stille, J. K. *J. Am. Chem. Soc.* **1978**, *100*, 3636-3638. (f) Milstein, D.; Stille, J. K. *J. Am. Chem. Soc.* **1979**, *101*, 4981-4991. (g) Milstein, D.; Stille, J. K. *J. Am. Chem. Soc.* **1979**, *101*, 4992-4998. (h) Milstein, D.; Stille, J. K. *J. Org. Chem.* **1979**, *44*, 1613-1618. (i) Stille, J. K. *Angew. Chem.* **1986**, *98*, 504-519.
- 32 (a) Okude, Y.; Hirano, S.; Hiyama, T.; Nozaki, H. *J. Am. Chem. Soc.* **1977**, *99*, 3179-3181. (b) Okude, Y.; Hiyama, T.; Nozaki, H. *Tetrahedron*

- Lett.* **1977**, 3829-3830. (c) Hiyama, S.; Okude, Y.; Kimura, K.; Nozaki, H. *Bull. Chem. Soc. Jpn.* **1982**, *55*, 561-568. (d) Nozaki, H.; Hiyama, T.; Oshima, K.; Takai, K. *ACS Symp. Ser.* **1982**, *185*, 99-108. (e) Takai, K.; Kimura, K.; Kuroda, T.; Hiyama, T.; Nozaki, H. *Tetrahedron Lett.* **1983**, *24*, 5281-5284.
- 33 Masse, C. E.; Yang, M.; Solomon, J.; Panek, J. S. *J. Am. Chem. Soc.* **1998**, *120*, 4123-4134.
- 34 Danishefsky, S. J.; Masters, J. J.; Young, W. B.; Link, J. T.; Snyder, L. B.; Magee, T. V.; Jung, D. K.; Isaacs, R. C. A.; Bornmann, W. G.; Alaimo, C. A.; Coburn, C. A.; Di Grandi, M. J. *J. Am. Chem. Soc.* **1996**, *118*, 2843-2859.
- 35 Kallan, N. C.; Halcomb, R. L. *Org. Lett.* **2000**, *2*, 2687-2690.
- 36 (a) Anderson, A. W.; Merckling, N. G. US 2721189, **1955**. (b) Calderon, N. Chen, H. Y.; Scott, K. W. *Tetrahedron Lett.* **1967**, 3327-3329.
- 37 (a) Schwab, P.; Grubbs, R. H.; Ziller, J. W. *J. Am. Chem. Soc.* **1996**, *118*, 100-110.
- 38 Schrock, R. R.; Murdzek, J. S.; Bazan, G. C.; Robbins, J.; DiMare, M.; O'Regan, M. *J. Am. Chem. Soc.* **1990**, *112*, 3875-3886.
- 39 Nagata, T.; Nakagawa, M.; Nishida, A. *J. Am. Chem. Soc.* **2003**, *125*, 7484-7485.
- 40 Zard, S. Z. *Radical Cyclizations in Organic Synthesis*; Oxford University, Oxford, **2003**.

- 41 Clive, D. L. J.; Chittattu, G. J.; Farina, V.; Kiel, W. A.; Menchen, S. M.; Russell, C. G.; Singh, A.; Wong, C. K.; Curtis, N. J. *J. Am. Chem. Soc.* **1980**, *102*, 4438-4447.
- 42 Baldwin, J. E. *J. Chem. Soc., Chem. Commun.* **1976**, 734-736.
- 43 Parker, K. A.; Fokas, D. *J. Org. Chem.* **2006**, *71*, 449-455.
- 44 (a) Stork, G.; Cama, L. D.; Coulson, D. R. *J. Am. Chem. Soc.* **1974**, *96*, 5268-5270. (b) Stork, G.; Cohen, J. F. *J. Am. Chem. Soc.* **1974**, *96*, 5270-5273.
- 45 (a) Sharpless, K. B.; Flood, T. C. *J. Chem. Soc., Chem. Commun.* **1972**, 370-371. (b) Sharpless, K. B.; Umbreit, M. A.; Nieh, M. T.; Flood, T. C. *J. Am. Chem. Soc.* **1972**, *94*, 6538-6540. (c) Mukaiyama, T.; Sata, T.; Hanna, J. *Chem. Lett.* **1973**, 1041-1044. (d) Tyrlik, S.; Wolochowicz, I. *Bull. Soc. Chim. Fr.* **1973**, 2147-2148. (e) McMurry, J. E.; Fleming, M. P. *J. Am. Chem. Soc.* **1974**, *96*, 4708-4709. (f) McMurry, J. E.; *Acc. Chem. Res.* **1974**, *7*, 281-286. (g) McMurry, J. E.; Fleming, M. P.; Kees, K. L.; Krepski, L. R. *J. Org. Chem.* **1978**, *43*, 3255-3266. (h) McMurry, J. E. *Acc. Chem. Res.* **1983**, *16*, 405-411.
- 46 (a) Staudinger, H.; Meyer, J. *Helv. Chim. Acta* **1919**, *2*, 635-646. (b) Coffman, D. D.; Marvel, C. S. *J. Am. Chem. Soc.* **1929**, *51*, 3496-3501. (c) Wittig, G.; Geissler, G. *Ann.* **1953**, *580*, 44-57. (d) Wittig, G.; Schollkopf, U. *Chem. Ber.* **1954**, *97*, 1318-1330. (e) Wittig, G.; Haag, W. *Chem. Ber.* **1955**, *88*, 1654-1666.

- 47 (a) Horner, L.; Hoffmann, H.; Wippel, H. G. *Chem. Ber.* **1958**, *91*, 61-63.
(b) Horner, L.; Hoffmann, H.; Wippel, H. G. *Chem. Ber.* **1959**, *92*, 2499-2505. (c) Wadsworth, W. S., Jr.; Emmons, W. D. *J. Am. Chem. Soc.* **1961**, *83*, 1733-1738. (d) Wadsworth, D. H.; Schupp, I. O. E.; Sous, E. J.; Ford, J. J. A. *J. Org. Chem.* **1965**, *30*, 680-685.
- 48 (a) Namy, J. L.; Girard, P.; Kagan, H. B. *Nouv. J. Chim.* **1977**, *1*, 5-7. (b) Girard, P.; Namy, J. L.; Kagan, H. B. *J. Am. Chem. Soc.* **1980**, *102*, 2693-2698. (c) Molander, G. A.; Etter, J. B. *Tetrahedron Lett.* **1984**, *25*, 3281-3284.
- 49 Bordwell, F. G.; Schexnayder, D. A. *J. Org. Chem.* **1968**, *33*, 3249-3246.
- 50 (a) Knochel, P.; Seebach, D. *Nouv. J. Chim.* **1981**, *5*, 75-77. (b) Knochel, P.; Seebach, D. *Tetrahedron Lett.* **1981**, *22*, 3223-3226. (c) Seebach, D.; Knochel, P. *Helv. Chim. Acta* **1984**, *67*, 261-283. (d) Seebach, D.; Calderari, G.; Knochel, P. *Tetrahedron* **1985**, *41*, 4861-4872.
- 51 (a) Bauchat, P.; Le Bras, N., Rigal, L.; Foucaud, A. *Tetrahedron* **1994**, *50*, 7815-7826. (b) Bauchat, P.; Foucaud, A. *Tetrahedron Lett.* **1989**, *30*, 6337-6338.
- 52 Mitra, S.; Lawton, R. G. *J. Am. Chem. Soc.* **1979**, *101*, 3097-3110.
- 53 (a) Clive, D. L. J.; Yu, M.; Li, Z. *J. Chem. Soc., Chem. Commun.* **2005**, 906-908. (b) Clive, D. L. J.; Li, Z.; Yu, M. *J. Org. Chem.* **2007**, *72*, 5608-5617.

- 54 Liu, D.; Acharya, H. P.; Yu, M.; Wang, J.; Yeh, V. S. C.; Kang, S.; Chiruta, C.; Jachak, S. M.; Clive, D. L. J. *J. Org. Chem.* **2009**, *74*, 7417-7428.
- 55 Prabhudas, B.; Clive, D. L. J. *Angew. Chem. Int. Ed.* **2007**, *46*, 9295-9297.
- 56 Wang, L.; Prabhudas, B.; Clive, D. L. J. *J. Am. Chem. Soc.* **2009**, *131*, 6003-6012.
- 57 Spande, T. F.; Jain, P.; Garraffo, M.; Pannell, L. K.; Yeh, H. J. C.; Daly, J. *W. J. Nat. Prod.* **1999**, *62*, 5-21.
- 58 Linares-Palomino, P. J.; Salido, S.; Altarejos, J.; Nogueras, M.; Sánchez, A. *Flavour Fragr. J.* **2006**, *21*, 659-666.
- 59 Piers, E.; Romero, M. A. *Tetrahedron* **1993**, *49*, 5791-5800.
- 60 (a) Clive, D. L. J.; Li, Z.; Yu, M. *J. Org. Chem.* **2007**, *72*, 5608-5617. (b) Sheng, S.-R.; Wang, Q.; Wang, Q.-Y.; Guo, L.; Liu, X.-L.; Huang, X. *Synlett* **2006**, 1887-1890. (c) Shiina, I.; Yamai, Y.-s.; Shimazaki, T. *J. Org. Chem.* **2005**, *70*, 8103-8106. (d) Cases, M.; de Turiso, F. G.-L.; Hadjisoteriou, M. S.; Pattenden, G. *Org. Biomol. Chem.* **2005**, *3*, 2786-2804. (e) Cases, M.; de Turiso, F. G.-L.; Pattenden, G. *Synlett* **2001**, 1869-1872. (f) Sakakibara, T.; Ikuta, S.; Sudoh, R. *Synthesis* **1982**, 261-263.
- 61 (a) Rama Rao, A. V.; Yadav, J. S.; Srinivasa Rao, C. *Tetrahedron Lett.* **1986**, *27*, 3297-3298. (b) Lebarillier, L.; Outurquin, F.; Paulmier, C. *Tetrahedron* **2000**, *56*, 7483-7493.

- 62 (a) Evans, D. A.; Britton, T. C.; Dorow, R. L.; Dellaria, J. F. *J. Am. Chem. Soc.* **1986**, *108*, 6395-6397. (b) Evans, D. A.; Britton, T. C. *J. Am. Chem. Soc.* **1987**, *109*, 6881-6883. (c) Evans, D. A.; Britton, T. C.; Dellaria, J. F., Jr. *Tetrahedron* **1988**, *44*, 5525-5540. (d) Evans, D. A.; Britton, T. C.; Ellman, J. A.; Dorow, R. L. *J. Am. Chem. Soc.* **1990**, *112*, 4011-4030.
- 63 Evans, D. A.; Morrissey, M. M.; Dorow, R. L. *J. Am. Chem. Soc.* **1985**, *107*, 4346-4348.
- 64 Evans, D. A.; Ennis, M. D.; Mathre, D. J. *J. Am. Chem. Soc.* **1982**, *104*, 1737-1739.
- 65 (a) Larchevêque, M.; Ignatova, E.; Cuvigny, T. *Tetrahedron Lett.* **1978**, *19*, 3961-3964. (b) Larchevêque, M.; Ignatova, E.; Cuvigny, T. *J. Organomet. Chem.* **1979**, *177*, 5-15. (c) Myers, A. G.; Yang, B. H.; Chen, H.; Gleason, J. L. *J. Am. Chem. Soc.* **1994**, *116*, 9361-9362. (d) Myers, A. G.; Yang, B. H.; Chen, H.; McKinstry, L.; Kopecky, D. J.; Gleason, J. L. *J. Am. Chem. Soc.* **1997**, *119*, 6496-6511.
- 66 (a) Enders, D.; Eichenauer, H. *Angew. Chem. Int. Ed. Engl.* **1976**, *15*, 549-550. (b) Enders, Eichenauer, H. *Tetrahedron Lett.* **1977**, *18*, 191-194. (c) Davenport, K. G.; Eichenauer, H.; Enders, D.; Newcomb, M.; Bergbreiter, D. E. *J. Am. Chem. Soc.* **1979**, *101*, 5654-5659. (d) Enders, D.; Eichenauer, H. *Angew. Chem. Int. Ed. Engl.* **1979**, *18*, 397. (e) Enders, D.; Eichenauer, H.; Baus, U.; Schubert, H.; Kremer, K. A. M. *Tetrahedron* **1984**, *40*, 1345-1359.

- 67 (a) Enders, D.; Schubert, H. *Angew. Chem. Int. Ed. Engl.* **1984**, *23*, 365-366. (b) Enders, D.; Plant, A. *Synlett* **1994**, 1045-1056.
- 68 Diez, E.; Lopez, A. M.; Pareja, C.; Martin, E.; Fernandez, R.; Lassaletta, J. M. *Tetrahedron Lett.* **1998**, *39*, 7955-7958.
- 69 (a) Enders, D.; Wortmann, L.; Peters, R. *Acc. Chem. Res.* **2000**, *33*, 157-169. (b) Enders, D.; Schubert, H. *Angew. Chem. Int. Ed. Engl.* **1984**, *23*, 365-366.
- 70 (a) Duffey, M. O.; LeTiran, A.; Morken, J. P. *J. Am. Chem. Soc.* **2003**, *125*, 1458-1459. (b) Colby, E. A.; O'Brien, K. C.; Jamison, T. F. *J. Am. Chem. Soc.* **2004**, *126*, 998-999. (c) Paterson, I.; Britton, R.; Delgado, O.; Meyer, A.; Poullennec, K. G. *Angew. Chem. Int. Ed. Engl.* **2004**, *43*, 4629-4633.
- 71 (a) Corey, E. J.; Magriotis, P. A. *J. Am. Chem. Soc.* **1987**, *109*, 287-289. (b) Enders, D.; Hüttl, M. R. M.; Runsink, J.; Raabe, G.; Wendt, B. *Angew. Chem. Int. Ed.* **2007**, *46*, 467-469. (c) Enders, D.; Hüttl, M. R. M.; Raabe, G.; Bats, J. W. *Angew. Chem. Int. Ed.* **2008**, *350*, 260-279.
- 72 Qin, Y.; Bakker, E. *Anal. Chem.* **2003**, *75*, 6002-6010.
- 73 Nyström, J-E.; Mccanna, T. D.; Helquist, P.; Amouroux, R. *Synthesis* **1988**, 56-58.
- 74 Myers, A. G.; Yang, B. H.; Kopecky, D. J. *Tetrahedron Lett.* **1996**, *37*, 3623-3626.
- 75 (a) Fisher, G. B.; Harrison, J.; Fuller, J. C.; Goralski, C. T.; Singaram, B. *Tetrahedron Lett.* **1992**, *33*, 4533-4536. (b) Fisher, G. B.; Fuller, J. C.;

- Harrison, J.; Goralski, C. T.; Singaram, B. *Tetrahedron Lett.* **1993**, *34*, 1091-1094. (c) Fisher, G. B.; Fuller, J. C.; Harrison, J.; Alvarez, S. G.; Burkhardt, E. R.; Goralski, C. T.; Singaram, B. *J. Org. Chem.* **1994**, *59*, 6378-6385.
- 76 Dale, J. A.; Mosher, H. A. *J. Am. Chem. Soc.* **1973**, *95*, 512-519.
- 77 Hudlicky, T.; Koszyk, F. F.; Kutchan, T. M.; Sheth, J. P. *J. Org. Chem.* **1980**, *45*, 5020-5027.
- 78 Vedejs, E.; Eberlein, T. H.; Wilde, R. G. *J. Org. Chem.* **1988**, *53*, 2220-2226.
- 79 Grieco, P. A.; Kaufman, M. D. *J. Org. Chem.* **1999**, *64*, 6041-6048.
- 80 Guertin, K. R.; Kende, A. S. *Tetrahedron* **1993**, *34*, 5369-5372.
- 81 Jeyakumar, K.; Chakravarthy, R. D.; Chand, D. K. *Catalysis Commun.* **2009**, *10*, 1948-1951.
- 82 Xu, L.; Cheng, J.; Trudell, M. L. *J. Org. Chem.* **2003**, *68*, 5388-5391.
- 83 (a) Gao, X.; Hall, D. G. *J. Am. Chem. Soc.* **2005**, *127*, 1628-1629. (b) Liu, P.; Jacobsen, E. N. *J. Am. Chem. Soc.* **2001**, *123*, 10772-10773.
- 84 Trippett, S.; Walker, D. M. *J. Chem. Soc.* **1961**, 1266-1272.
- 85 (a) Takeda, T.; Fujii, T.; Morita, K.; Fujiwara, T. *Chem. Lett.* **1986**, 1311-1314. (b) Yamazaki, S.; Fujitsuka, H.; Yamabe, S.; Tamura, H. *J. Org. Chem.* **1992**, *57*, 5610-5619.
- 86 (a) Hansen, D. B.; Starr, M.-L.; Tolstoy, N.; Joullié, M. M. *Tetrahedron: Asymmetry* **2005**, *16*, 3623-3627. (b) Pitts, M. R.; Mulzer, J. *Tetrahedron*

Lett. **2002**, *43*, 8471-8473. (c) Kurashina, Y.; Miura, A.; Enomoto, M.; Kuwahara, S. *Tetrahedron* **2011**, *67*, 1649-1653.

- 87 Preparation of phosphomolybdic acid stain: phosphomolybdic acid (15 g) and $\text{Ce}(\text{SO}_4)_2$ (2.5 g) were added to a mixture of water-sulfuric acid (485 mL-15 mL) and the mixture was stirred for 1 h. Preparation of potassium permanganate stain: KMnO_4 (3 g) and K_2CO_3 (20 g) were added to a solution of water (300 mL) and NaOH (5 %, 5 mL) and the mixture was stirred for 2 h.