

40383



National Library of Canada

Bibliothèque nationale du Canada

CANADIAN THESES ON MICROFICHE

THÈSES CANADIENNES SUR MICROFICHE

NAME OF AUTHOR/NOM DE L'AUTEUR LEONARD SHIK WO CHENG

TITLE OF THESIS/TITRE DE LA THÈSE PASSIVE BUS DETECTOR AN APPLICATION OF MICROCOMPUTOR TECHNOLOGY AND PATTERN RECOGNITION

UNIVERSITY/UNIVERSITÉ UNIVERSITY OF ALBERTA

DEGREE FOR WHICH THESIS WAS PRESENTED/ GRADE POUR LEQUEL CETTE THÈSE FUT PRÉSENTÉE M.Sc.

YEAR THIS DEGREE CONFERRED/ANNÉE D'OBTENTION DE CE GRADE 1979

NAME OF SUPERVISOR/NOM DU DIRECTEUR DE THÈSE DR. D.H. KELLY & PROF. S. TOPY

Permission is hereby granted to the NATIONAL LIBRARY OF CANADA to microfilm this thesis and to lend or sell copies of the film.

The author reserves other publication rights, and neither the thesis nor extensive extracts from it may be printed or otherwise reproduced without the author's written permission.

L'autorisation est, par la présente, accordée à la BIBLIOTHÈQUE NATIONALE DU CANADA de microfilmer cette thèse et de prêter ou de vendre des exemplaires du film.

L'auteur se réserve les autres droits de publication; ni la thèse ni de longs extraits de celle-ci ne doivent être imprimés ou autrement reproduits sans l'autorisation écrite de l'auteur.

DATED/DATE April 25, 79 SIGNED/SIGNÉ 

PERMANENT ADDRESS/RÉSIDENCE FIXE 67 HENRY AVE
EDMONTON, ALTA
T5A 2X6



National Library of Canada

Cataloguing Branch
Canadian Theses Division

Ottawa, Canada
K1A 0N4

Bibliothèque nationale du Canada

Direction du catalogage
Division des thèses canadiennes

NOTICE

AVIS

The quality of this microfiche is heavily dependent upon the quality of the original thesis submitted for microfilming. Every effort has been made to ensure the highest quality of reproduction possible.

If pages are missing, contact the university which granted the degree.

Some pages may have indistinct print especially if the original pages were typed with a poor typewriter ribbon or if the university sent us a poor photocopy.

Previously copyrighted materials (journal articles, published tests, etc.) are not filmed.

Reproduction in full or in part of this film is governed by the Canadian Copyright Act, R.S.C. 1970, c. C-30. Please read the authorization forms which accompany this thesis.

**THIS DISSERTATION
HAS BEEN MICROFILMED
EXACTLY AS RECEIVED**

La qualité de cette microfiche dépend grandement de la qualité de la thèse soumise au microfilmage. Nous avons tout fait pour assurer une qualité supérieure de reproduction.

S'il manque des pages, veuillez communiquer avec l'université qui a conféré le grade.

La qualité d'impression de certaines pages peut laisser à désirer, surtout si les pages originales ont été dactylographiées à l'aide d'un ruban usé ou si l'université nous a fait parvenir une photocopie de mauvaise qualité.

Les documents qui font déjà l'objet d'un droit d'auteur (articles de revue, examens publiés, etc.) ne sont pas microfilmés.

La reproduction, même partielle, de ce microfilm est soumise à la Loi canadienne sur le droit d'auteur, SRC 1970, c. C-30. Veuillez prendre connaissance des formules d'autorisation qui accompagnent cette thèse.

**LA THÈSE A ÉTÉ
MICROFILMÉE TELLE QUE
NOUS L'AVONS REÇUE**

THE UNIVERSITY OF ALBERTA

PASSIVE BUS DETECTOR
AN APPLICATION OF
MICROCOMPUTER TECHNOLOGY
AND
PATTERN RECOGNITION

by

(C)

Leonard Shik Wo Cheng

A THESIS

SUBMITTED TO THE FACULTY OF GRADUATE STUDIES AND RESEARCH
IN PARTIAL FULFILMENT OF THE REQUIREMENTS FOR THE DEGREE
OF MASTER OF SCIENCE

DEPARTMENT OF ELECTRICAL ENGINEERING

EDMONTON, ALBERTA

SPRING, 1979

THE UNIVERSITY OF ALBERTA
FACULTY OF GRADUATE STUDIES AND RESEARCH

The undersigned certify that they have read, and recommend to the Faculty of Graduate Studies and Research, for acceptance, a thesis entitled Passive Bus Detector an Application of Microcomputer Technology and Pattern Recognition submitted by Leonard Shik Wo Cheng in partial fulfilment of the requirements for the degree of Master of Science in Electrical Engineering.

.....
Supervisor

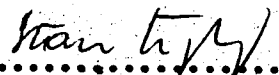
.....
Supervisor

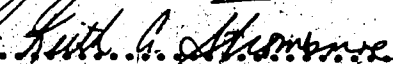
.....

.....

Date April 24/79
.....

ABSTRACT

With the advent of developments in microcomputer technology it is cost-effective to perform a wide variety of practical applications of the theories of Pattern Recognition. This project is one such application in which a low-cost Passive Bus Detection system is developed.

Vehicle signatures sensed by an Electromagnetic Loop Detector are fed into a microcomputer system. Using the Pattern Recognition technique, the system extracts characteristic features from these signatures and defines Discriminant Functions to differentiate transit busses from other vehicles.

The system has been field-tested achieving better than 99% accuracy and is now in operation as part of a busway control device in the City of Edmonton. Most of the equipment used in the system is off-the-shelf to ensure the availability of the final product. However, some necessary modifications and additional circuits were implemented.

ACKNOWLEDGEMENTS

The author would like to express his appreciation to Dr. D.H. Kelly for his guidance and comments and to Professor S. Teply who initiated this work. I also want to thank my colleagues Mr. B. Kasper and Mr. R. W. Lewis for their ideas and discussions on the topics in this thesis.

Thanks are also due to Mr. J. Schnablegger and Mr. O. Korbitt of the Traffic Operations Branch of the City of Edmonton without whom this project will not be possible; and to the technicians in the Traffic Shop for their cooperation during the development of this project.

The work was carried out at the Department of Electrical Engineering at the University of Alberta and the Engineering Department of the City of Edmonton. The financial assistance from these Departments and the National Research Council is also gratefully acknowledged.

TABLE OF CONTENTS

	Page
LIST OF FIGURES AND TABLES	viii
NOMENCLATURE	x
<u>CHAPTER 1</u> INTRODUCTION	
1.1 Background	1
1.2 The System	2
1.3 Project Objective	2
1.4 Scope of the Thesis	4
<u>CHAPTER 2</u> THEORY	
2.1 Introduction	6
2.2 Typical ETS Bus Signature	6
2.3 Data Analysis	9
2.3.1 Hierarchical Decision Tree	10
2.3.2 Signatures with 2 Local Maxima	18
2.3.3 Signatures with 3 or 4 Local Maxima	22
2.4 Summary and Conclusion	24
2.4.1 Summary	24
2.4.2 Conclusion	25
<u>CHAPTER 3</u> HARDWARE DEVELOPMENT	
3.1 Introduction	26
3.2 The Sensing Unit	26
3.2.1 Basic Principle of Operation of a Phase-shift Vehicle Detector	26
3.2.2 Amplifier and Filter	29
3.3 The Peripheral Unit	31
3.3.1 Descriptions	31

3.3.2	Operations	32
3.3.3	Base Address	32
3.4	The Processing Unit	32
3.4.1	Descriptions	32
3.4.2	Memory Organization	35
3.4.3	Operations	37
3.4.4	Modifications	37
<u>CHAPTER 4 . SOFTWARE DEVELOPMENT</u>		
4.1	Introduction	39
4.2	DATAcq	39
4.3	DAC	41
4.4	FETD	41
4.5	FEATURE	42
4.6	CLASSIF	46
<u>CHAPTER 5 CONCLUSION</u>		
5.1	Field Testing Results	53
5.2	Cost Analysis on Existing Systems	58
5.3	Conclusion and Future Developments	57
<u>BIBLIOGRAPHY</u>		
<u>APPENDIX 1</u>	Maximum Likelihood Estimation	61
<u>APPENDIX 2</u>	Stored Vehicle Signatures	65
<u>APPENDIX 3</u>	Data Acquired via FEATURE	114
<u>APPENDIX 4</u>	Program Listings	119

LIST OF FIGURES AND TABLES

<u>FIGURES</u>	Page
1.1 Passive Bus Detection Functional Block Diagram	3
2.1 ETS Bus Undercarriage Diagram	7
2.2 Comparison between the Undercarriage of an ETS Bus and the Average of 3-max Normalized Bus Signatures	8
2.3 Data Distribution and Decision Boundaries	11
2.4 Distributions of Stored Data	12
2.5 Typical Vehicle Signatures	13
2.6 Typical Vehicle Signatures (Cont'd)	14
2.7 Typical Vehicle Signatures (Cont'd)	15
2.8 Heirarchical Decision Tree	17
2.9 Averages of Normalized Signatures - $N = 2, \eta \geq 1$	19
2.10 Averages of Normalized Signatures - $N = 2, \eta < 1$	21
2.11 Averages of Normalized Signatures - $N \in (3,4), \eta \geq 1$	23
2.12 Average of Normalized Signatures - $N \in (3,4), \eta < 1$	25
3.1 A RIC Resonant Citcuit	26
3.2 Change of Frequency by a Metallic Object	27
3.3 A Phase-shift Loop Vehicle Detector (Block Diagram)	28
3.4 Difference Amplifier	29
3.5 VCVS Butterworth LPF	30
3.6 Overall Interface Circuit	31
3.7 System Block Diagram	33
3.8 Timing Diagram for A/D Conversion	34
3.9 Memory Organization	36
3.10 Power Failure Automatic Reset Circuit	38
3.11 Timing Diagram for Power Start-up	38

4.1	Flow Chart DATACQ	40
4.2	Input and Output Threshold Values	41
4.3	Tolerance Value for Extrimum Detection	42
4.4	Artificial Test Data	43
4.5	Flow Chart FETD	44
4.6	Flow Chart FETD (Cont'd)	45
4.7	Flow Chart CLASSIF	47
4.8	Flow Chart CLASSIF (Cont'd)	48
4.9	Flow Chart CLASSIF (Cont'd)	49
4.10	Flow Chart CLASSIF (Cont'd)	50
4.11	Flow Chart CLASSIF (Cont'd)	51
4.12	Flow Chart CLASSIF (Cont'd)	52
5.1	Busway Control Gates in N.E. Edmonton	55

TABLES

2.1	Number of Maxima vs Vehicle Type	15
5.1	Field Test Results (Before Implementation of LPF)	53
5.2	Field Test Results (After Implementation of LPF)	54
5.3	Field Test Results (Final Algorithm Installed)	54
5.4	Cost Estimations for 15 Intersections	57

NOMENCLATURE

<u>Symbol</u>	<u>Meaning</u>
N	Number of Maxima within a vehicle signature
M_{xi}	Magnitude of the i th maximum
M_{ni}	Magnitude of the i th minimum
T_{xi}	Time the i th maximum detected
T_{ni}	Time the i th minimum detected
T	Duration of a vehicle signature
ξ	Normalized time with respect to T
η	Normalized magnitude with respect to M_{x2}
μ	Mean value
σ	Standard deviation
n	Number of data points
ϵ	Tolerance value
θ_{in}	Input Threshold value
θ_{out}	Output Threshold value
\underline{r}	Pattern vector
p	Probability density function
$p(x/y)$	Conditional probability of x given y
\hat{x}	Estimated value of x
$\bigcup_{i=1}^n$	A union of n elements
\in	An element of a set
∇_{θ}	The gradient operator

1.1 Background

Increasing bus ridership as means to reduce congestion and fuel consumption has been receiving a lot of attention in recent years. Reliability and efficiency are among the techniques used to attract transit patronage. In order to provide reliability and efficiency in Transit Operations, priority concessions are given to transit vehicles. These concessions include exclusive bus lanes and priority traffic signalizations. Bus lanes, both with-flow and contra-flow, are the most common ways of giving busses priority over other traffic. However, while busses almost always gain from such treatment, other traffic can suffer substantially in certain circumstances²⁵; and inadequate street facilities, which are common in older neighborhoods of an urban area, will also limit or even prohibit such practice. The second concession requires the invocation of various controls that all depend on the identification of transit vehicles in the overall traffic streams. In 1967 the Federal Highway Administration (FHWA) of the United States initiated a research project called Urban Traffic Control System/Bus Priority System (UTCS/BPS) which substantiated the feasibility of preferential signalizations to reduce delays of transit vehicles at intersections¹⁵ although the requirement for on-board hardware and a special detector hindered the attractiveness of the concept.

Presently two systems are used in the City of Edmonton; both using direct radio transmission to a control device. One system uses a garage door opener to transmit to the control mechanism, the other transmits a signal from a vehicle-mounted transponder to an inductive loop which

indicates the presence of a bus to the local control mechanism. Both systems require all vehicles that use the route to be equipped, and this in itself creates flexibility problems for the transit operator. The other major problem is the failure rate of the various transmission devices. The use of a passive detection system will solve or minimize the above problems.

In 1976, Honeywell Inc., under a contract with the FHWA, developed an engineering model of a Passive Bus Detector¹³. However, the mathematical approach taken in the development resulted in a high-cost and large size system which impaired its practicality. It was therefore our intention to pursue the development of a low-cost and compact passive loop-based transit detection system.

1.2 The System

Previous research and recent advances in microcomputer technology indicated that a classification system based on the pattern recognition technique was within the state of the art. Conceptually the system was identified as having three major functional blocks as illustrated in Fig. 1.1. The blocks have the following functional attributes:

1. The Sensing Block provides the basic signal that the processing logic uses in the recognition algorithm.
2. The Classifier Block performs the comparative logic which determines the vehicle type.
3. The Peripheral Interface Block converts the basic signal to the digital format and provides the input/output control hardware interface such that a desired action takes place as a result of a specific

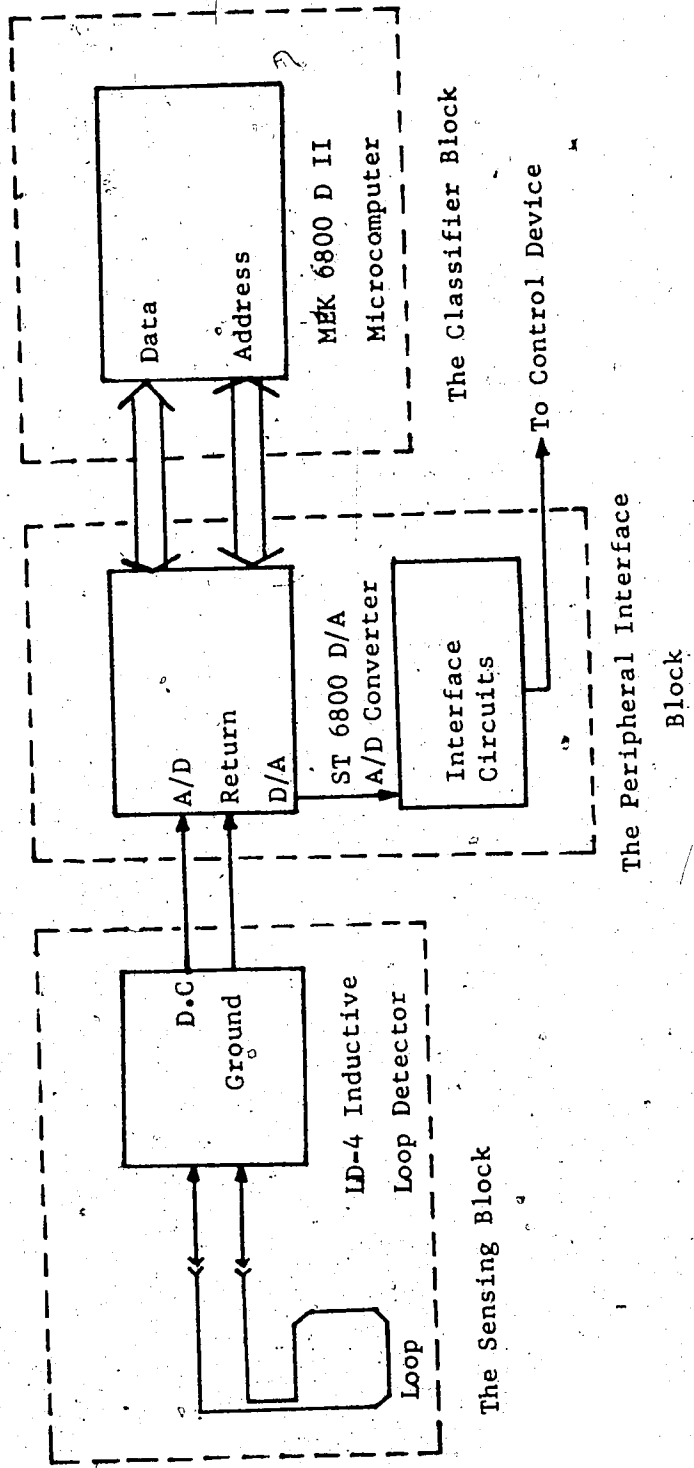

Fig. 1.1 Passive Bus Detection Functional Block Diagram

4

recognition.

The development of the system fell into three phases:

1. Sensing (Data Acquisition)
2. Feature Extraction (Data Analysis)
3. Development of Decision Algorithms (Software Installation)

During the course of designing the system, emphasis was placed on off-the-shelf equipment for the implementation of the final product. This will ensure availability and ease in future maintenance.

1.3 Project Objective

The objective of this project was to develop a low-cost and compact practical system which was capable of differentiating Edmonton Transit System (ETS) busses from other vehicles via a passive mode of detection scheme (i.e. neither the bus driver action nor the on-board equipment is needed) with an accuracy of 95% or better. This objective was successfully attained during the course of this project.

1.4 Scope of the Thesis

This is an interdisciplinary project involving both the Traffic Engineering and the Electrical Engineering where an operational system has been developed.

Chapter one is a description of the background and the need indicated by the City of Edmonton for the development. It also very briefly describes the system and its development.

Chapter two is the theoretical analysis based on the collected data and the derivation of discriminant functions that are used in the final cla-

ssification algorithm.

Chapter three describes the hardware development and necessary modifications to the off-the-shelf equipment to make this a fully automatic operational system.

Chapter four describes the software development in this project. A software filtering technique is discussed. Flow charts for the developed programs are also included.

Chapter five concludes this project by showing the performance of the system. It also points out the arbitrariness or uncertainties which may need adjustments in order to yield optimal system operations.

2.1 Introduction

Due to the variations of the data set (e.g. positions and magnitudes of local maxima and minima in the signatures) the pattern recognition technique seems to be suitable for solving the problem of differentiating ETS busses from other vehicles. This is one technique that can handle a large number of data and their variable nature and define a solution which is, on the average, in close agreement with the actual outcome. Therefore, it is the technique chosen in this project.

2.2 Typical ETS Bus Signature

Before going into the analysis of the data set, it is helpful to establish the correlation between the ETS bus and its signature. Since the distortions of an electromagnetic field are caused by the size of a metallic object and its position in the field, the signature sensed by the loop electronics should correspond to the metallic structure of the vehicle's undercarriage. Measurements of the metallic lumps on the undercarriage of an ETS bus show that the heater box and gas tank are situated between 17 and 27 feet from the front bumper of a 40-foot bus (Fig. 2.1). When we normalize the mid-point of the heater box/gas tank with respect to the total length of the bus, we have

$$\frac{(17 + 27)/2}{40} = 0.55$$

which is in very close agreement with the second local maximum of the average of a 3-max. normalized ETS bus signatures (Fig. 2.2). The other two local maxima are likely produced by the front-wheel axle and the

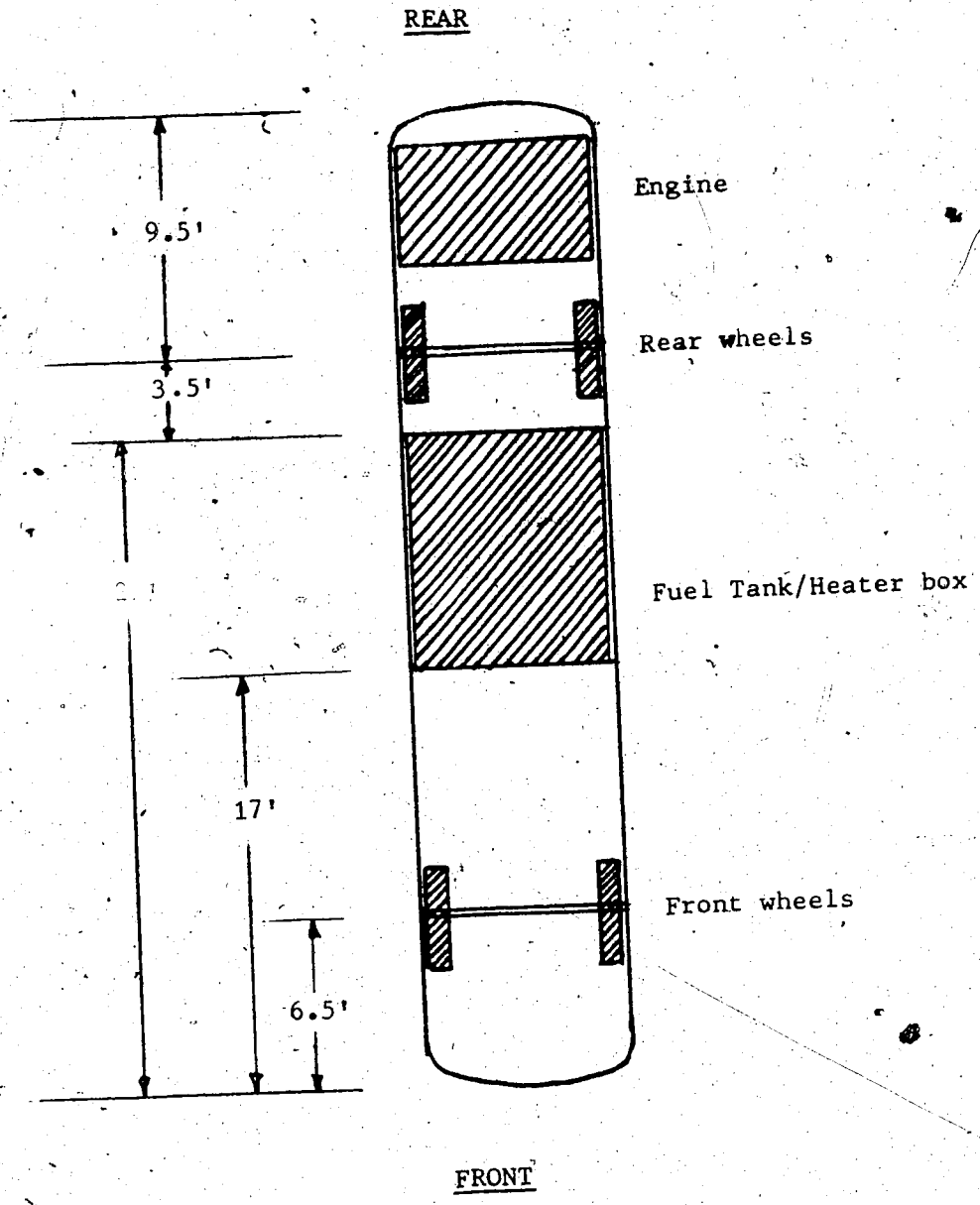

Fig. 2.1 ETS bus undercarriage diagram

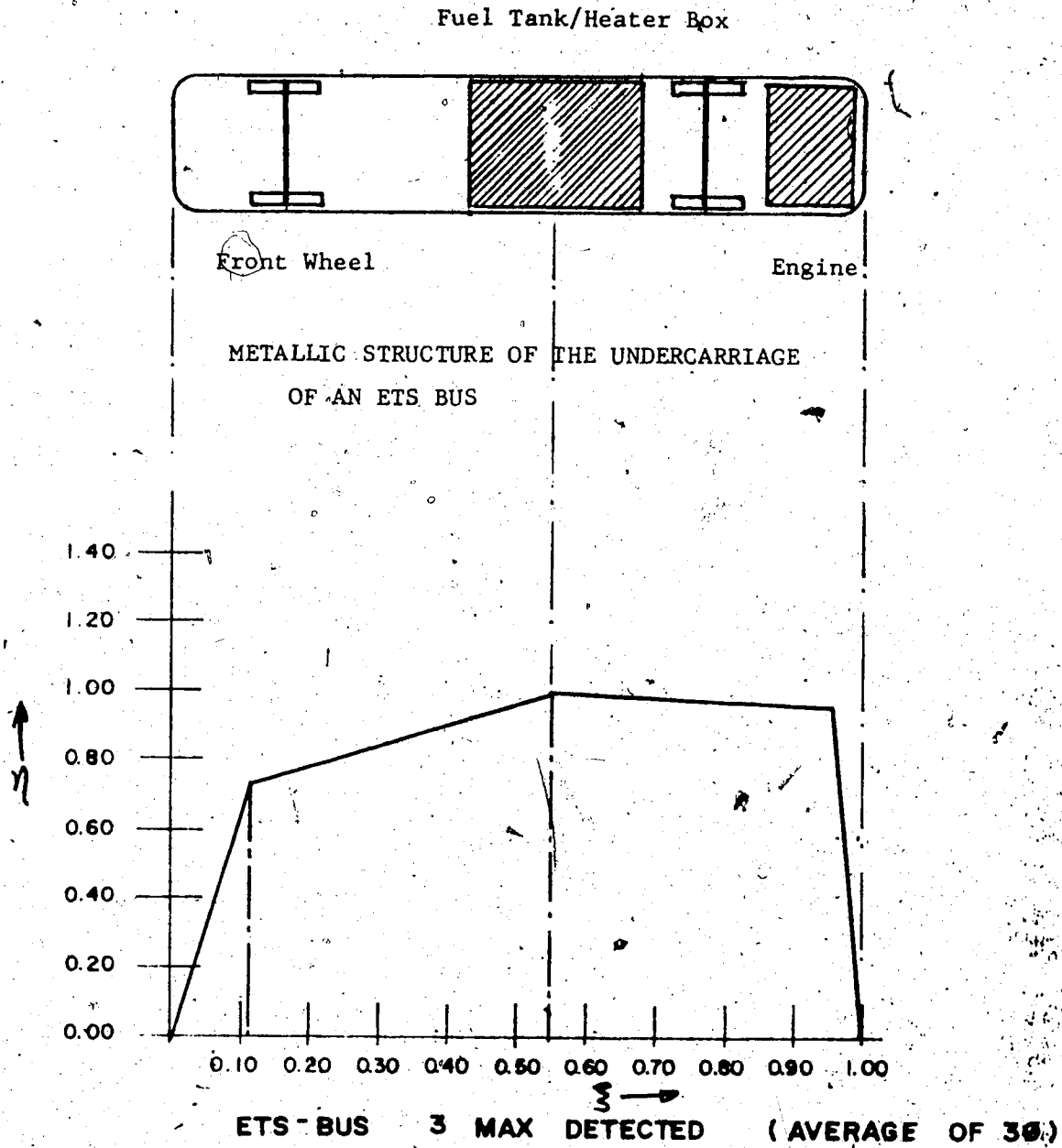

Fig. 2.2 Comparison between the Undercarriage of an ETS Bus and the Average of a 3-Max. Normalized Bus Signature

engine at the rear part of a bus. Therefore, such signature is regarded as the typical signature of an ETS bus and will be referred to as such throughout this chapter.

A typical ETS bus signature thus consists of the following characteristics:

- 1. Three local maxima,
- 2. The second maximum has the highest value, and
- 3. Relative positions of these maxima, normalized with respect to the duration of the signature, are:

1st maximum, $T_{x1} = 0.10$ to 0.20

2nd maximum, $T_{x2} = 0.425$ to 0.675

3rd maximum, $T_{x3} = 0.90$ to 1.00 .

2.3 Data Analysis

Initial analysis on the data set (Appendices 2 & 3) indicates that the feature space can be described by two dimensional pattern vectors. The components of each pattern vector (\underline{r}) are defined by the following two variables ξ and η , where

ξ = Normalized time position with respect to the total duration of the signature,

and

η = Normalized magnitude with respect to the detected second maximum.

The pattern vector is therefore denoted by:

$\underline{r} = (\xi, \eta)$.

Distributions of data from the two classes (i.e., ETS busses and other vehicles) show three nearly disjoint clusters (Fig 2.3), thus indicating that decision lines of high accuracy may be defined. Also, the formation of these clusters suggests the possibility of using only one-dimensional decision algorithms if the data are partitioned by means of some value of the η component. Based on the analysis in the preceding section, the value of $\eta = 1.0$ is chosen.

Now, if we consider only the ξ component the data distribution of ETS busses closely resembles the Normal type (Fig. 2.4). On the other hand data distribution of other vehicles does not quite behave in the Normal manner. This is expected since the class of other vehicles consists of a variety of vehicles and thus it may be considered as the sum of a number of Normal distributions. However, when estimating mean values, μ , and standard deviations, σ , of ξ for these two classes using the Maximum Likelihood Method (Appendix 1), the distributions of data of both classes are treated as the Normal type and adjustments are made when decision lines are defined.

2.3.1 Hierarchical Decision Tree

From the collected data, it is obvious that the number of maxima and their positions and magnitudes in a signature characterize the vehicle it belongs to (Fig. 2.5; 2.6, 2.7). However it was later noted that, after the feature extraction procedure, the number of maxima in a signature of a particular vehicle type is not as unique as we like it to be. For example, signatures of ETS busses are found to have two, three or even four local maxima as depicted by table 2.1. One possible explanation for this would be the measurement error due to noise and/or

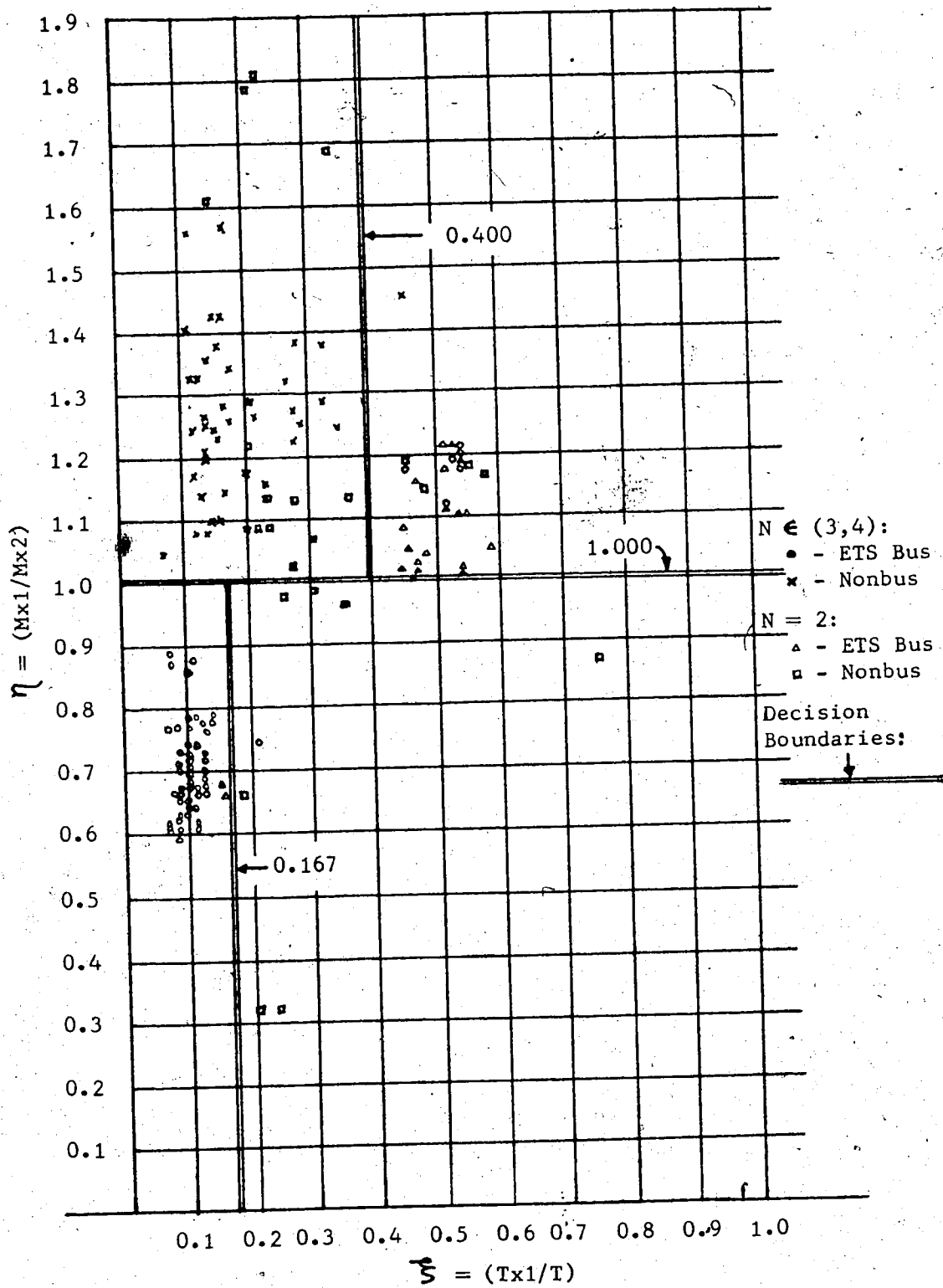

Total Number of Signatures = 156
 Misclassified vehicles: ETS Bus - None
 Other Vehicles - 8
 Overall Accuracy = 94.87%

Fig. 2.3 Data Distribution and Decision Boundaries

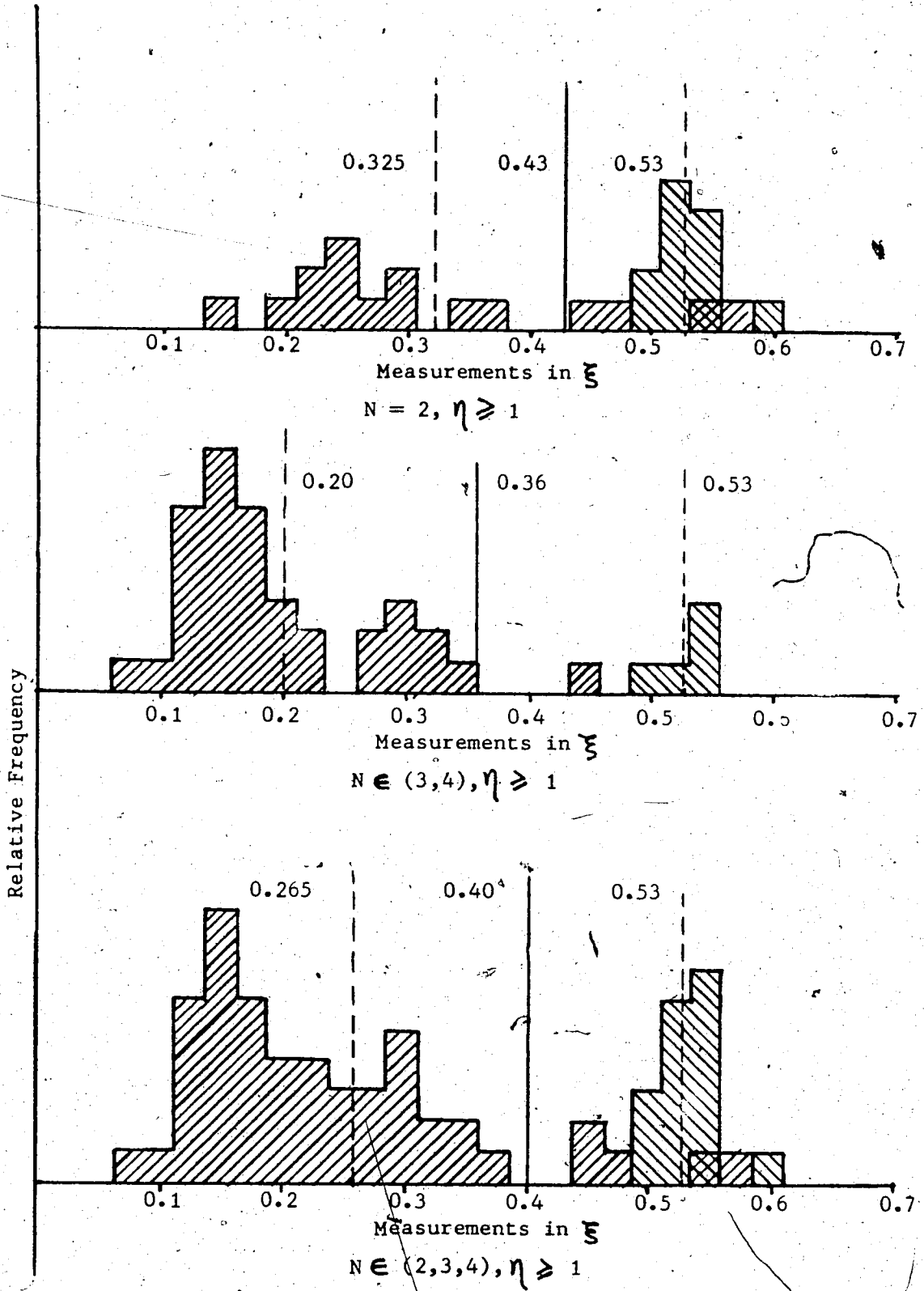

Fig. 2.4 Distributions of Stored Data

- Decision Boundary
- - - Mean Value
- ▨ Other Vehicles
- ▩ ETS Busses

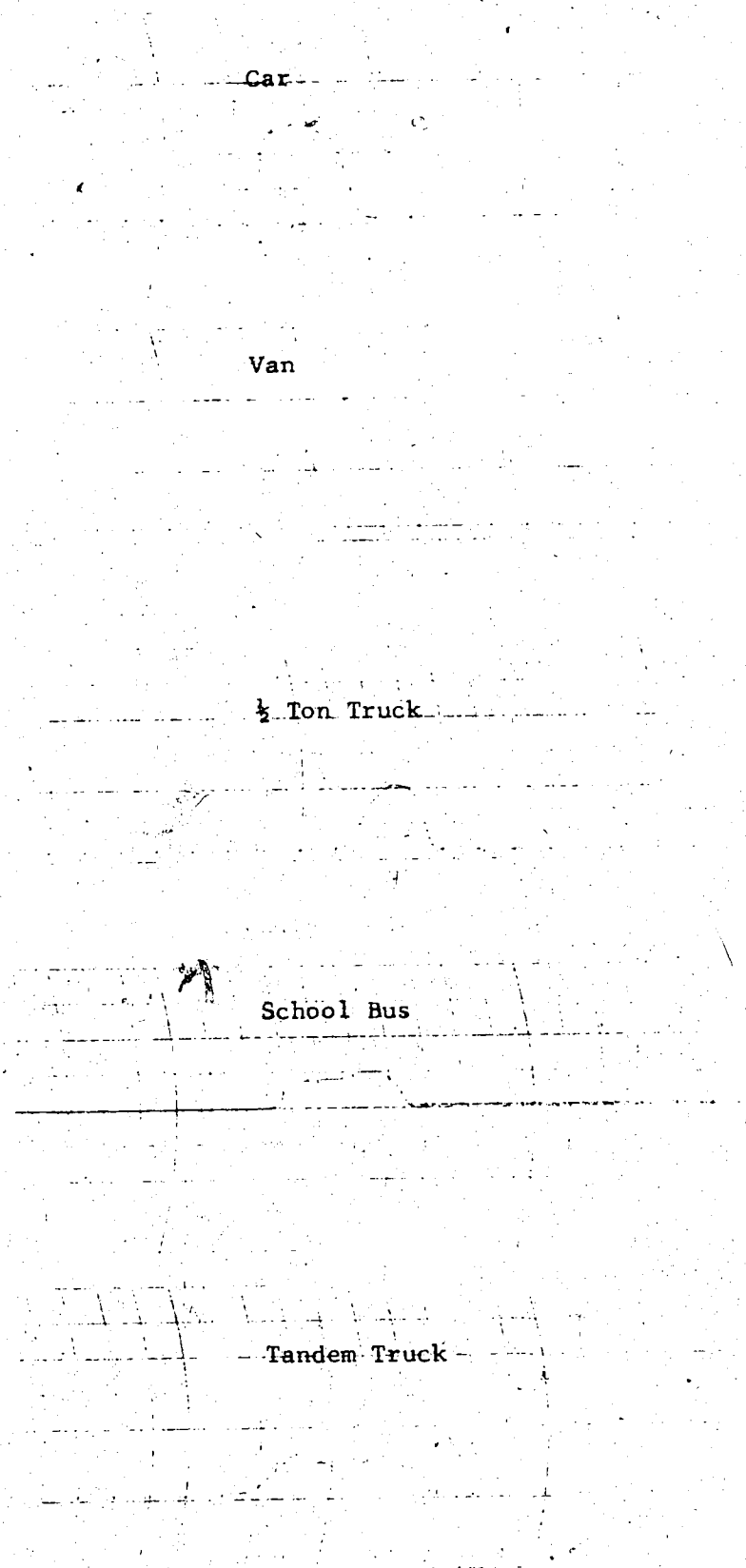
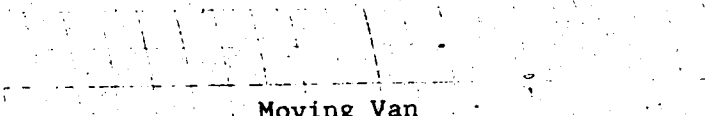



Fig. 2.5 Typical Vehicle Signatures



Moving Van



Greyhound Bus



ETS Trolley Bus



ETS Diesel Bus



Semi-trailer

Fig. 2.6 Typical Vehicle Signatures (Cont'd)

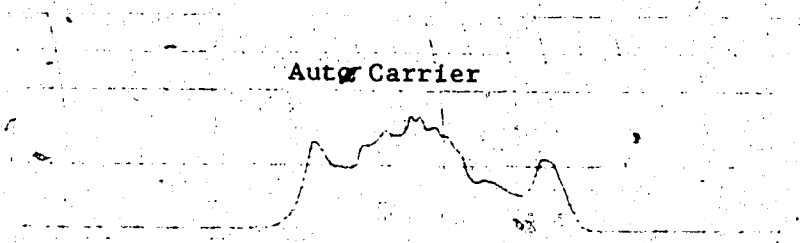

Fig. 2.7 Typical vehicle Signatures (Cont'd)

Auto Carrier			X	X	X	X	X	
Semi-trailer			X	X				
ETS Diesel Bus		X	X	X				
ETS Trolley BUS		X	X	X				
Greyhound Bus	X	X						
Moving Van		X	X					
Tandem Truck		X						
School Bus	X	X						
½ Ton Truck	X	X						
Van	X	X						
Car	X	X						
	1	2	3	4	5	6	7	8

Number of Maxima

Table 2.1 Number of Maxima vs Vehicle Types

the lateral displacement of the vehicle relative to the detection zone of the inductive loop. A more careful analysis indicates that, in the case of ETS busses, when only two maxima are detected, either the first or the third maximum is missing and the second maximum, which is the global maximum in the signature, is always present. In other words, when only two maxima are detected the first detected maximum is actually either the "real" first or the "real" second maximum in a typical ETS bus signature. It is, however, possible to determine whether or not it is the "real" first maximum by comparing the relative time position this maximum is detected with the duration of the whole signature. Based on the charted signatures, the typical signatures of ETS busses exhibit three distinct local maxima (Figure 2.6), thus only the first three local maxima will be considered in the software logic. For a signature which consists of more than four local maxima, the signature will be considered as that of an auto-carrier rather than an ETS bus.

A Hierarchical Decision Tree is thus formulated (Fig. 2.8). Given a vehicle signature, the system first makes a decision as to whether or not the vehicle is a prospective candidate to be classified as an ETS bus by counting the number of detected local maxima; for $2 \leq N \leq 4$ (N = number of local maxima detected), data will be further processed to yield a classification decision. In the case where $N < 2$ and $N > 4$, the system will reject the signature and consider it to be that of a non-(ETS)-bus. A detailed analysis for the cases where $2 \leq N \leq 4$ is given in the following sections; and the prospective signatures are divided into the following four cases as shown in the heirarchical decision tree:

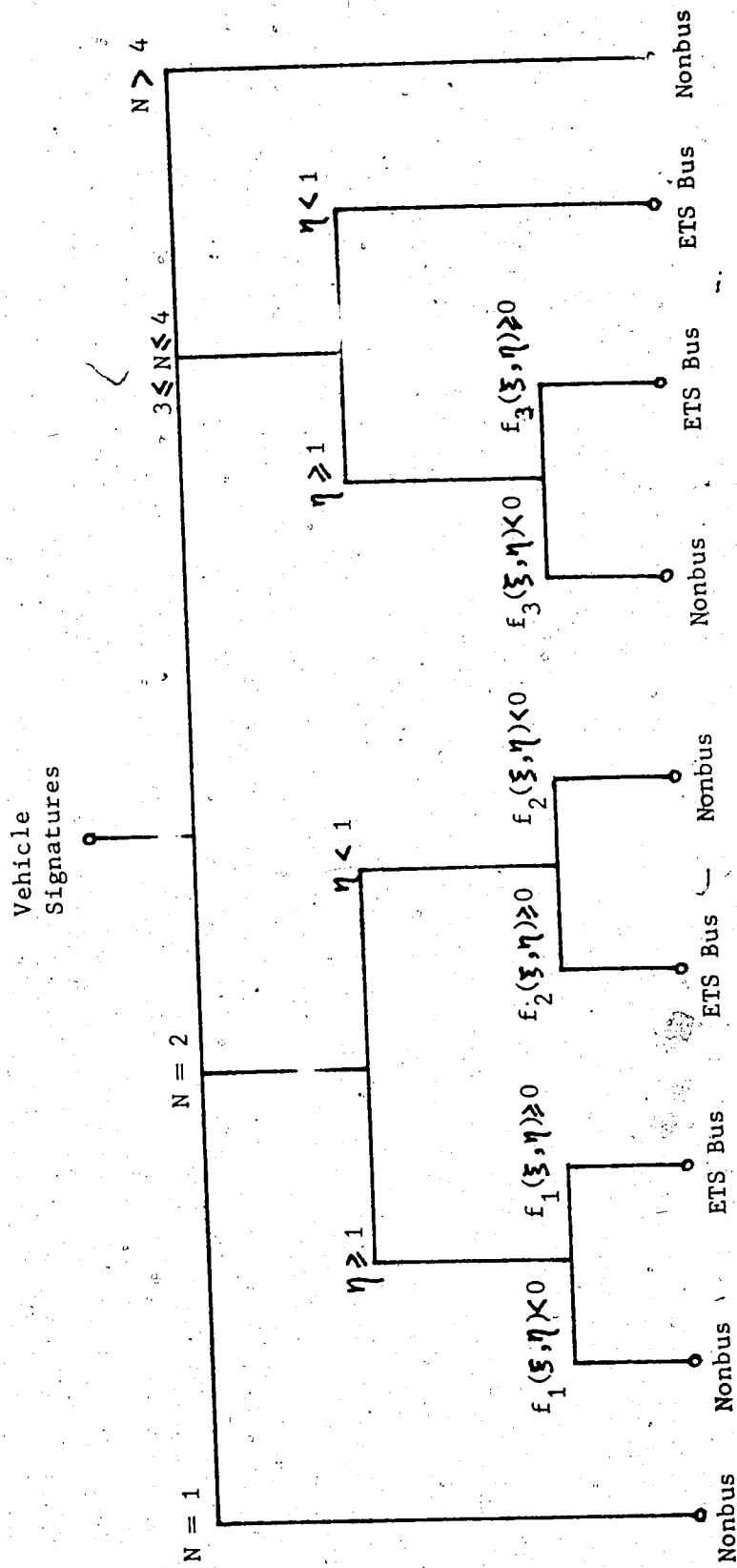

Fig. 2.8 Hierarchical Decision Tree

N = Number of Maxima
 ξ = $(Tx1/T)$, Normalized Time Position of 1st detected maximum
 η = $(Mx1/Mx2)$, Ratio of 1st detected max. to 2nd detected maximum

1. $N = 2, \eta \geq 1$
2. $N = 2, \eta < 1$
3. $N \in (3,4), \eta \geq 1$
4. $N \in (3,4), \eta < 1$

2.3.2 Signatures with 2 local Maxima

The majority of vehicle classes have this characteristic, namely, cars, vans, half ton trucks, school busses, moving vans, greyhound busses and ETS busses (Table 2.1). To distinguish the ETS busses from the rest of the list above, we first investigate the magnitude ratio of the maxima in the signature. As mentioned before, when only two maxima are detected, either the first or the third maximum in the typical signature is undetected. Therefore, if $\eta \geq 1$ the first detected maximum is actually the "real" second maximum in the signature; and if $\eta < 1$ the "real" first maximum is detected. These two cases will be considered separately.

2.3.2.1 In the case $N = 2, \eta \geq 1$ (Fig. 2.9)

In this case, mean values (μ) and standard deviations (σ) of ξ are estimated from the collected data to be:

$$\text{For ETS busses, } \mu_b = 0.532$$

$$\sigma_b = 0.023$$

$$\text{For other vehicles, } \mu_o = 0.33$$

$$\sigma_o = 0.124$$

where subscripts b and o denote ETS busses and other vehicles respectively.

The centroid (mean value) of ETS busses clearly indicates that when $N =$

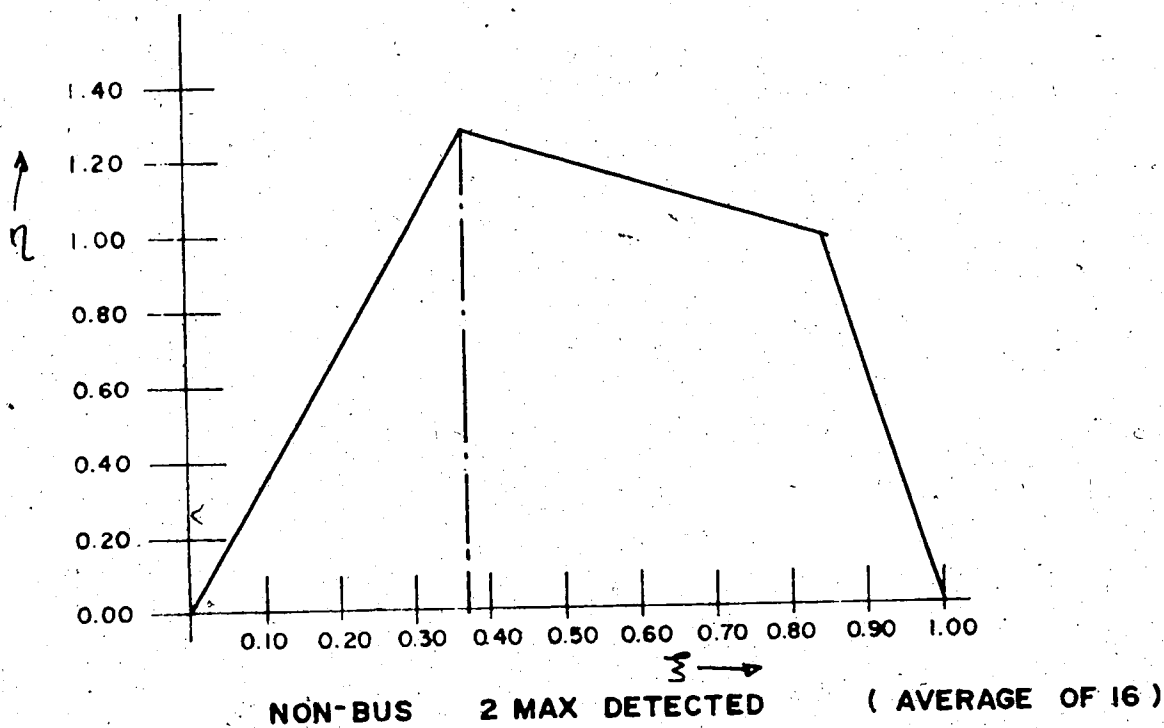
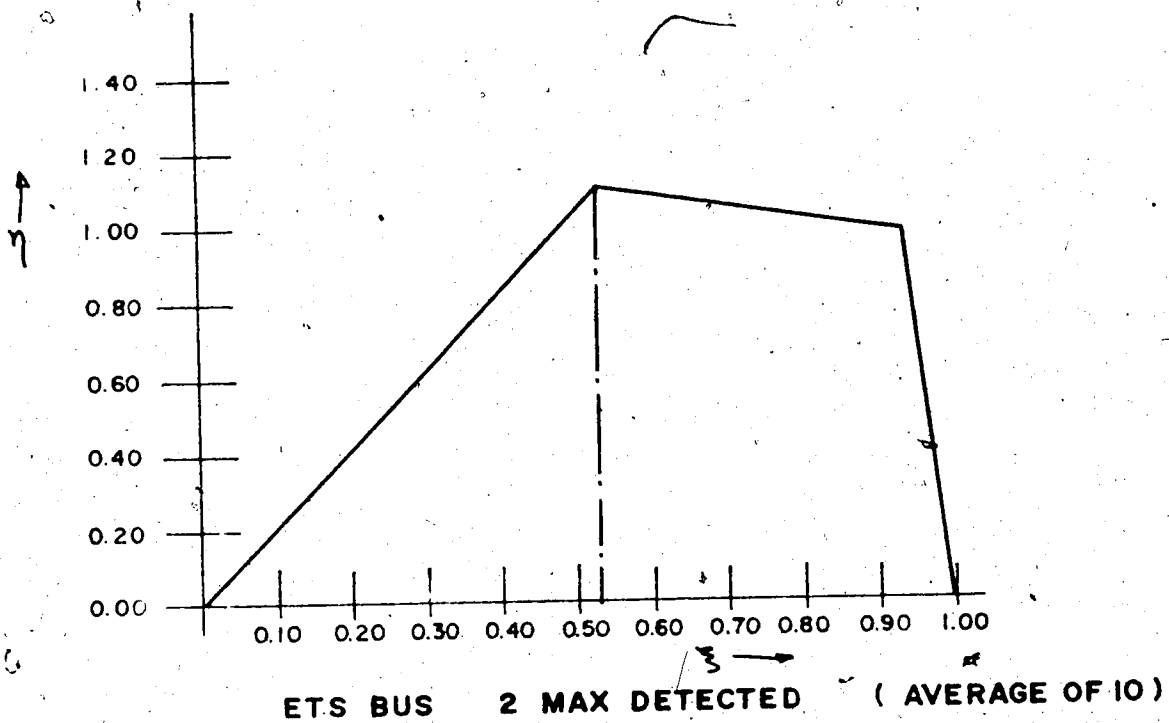

Fig. 2.9 Averages of Normalized Signatures

$N = 2, \eta \geq 1$

2 and $\eta \geq 1$ the detected first maximum is actually the "real" second maximum in a typical ETS bus signature since it is situated very close to the mid-point of the signature ($\xi = 0.532$) just like the second maximum in a typical ETS bus signature. A linear discriminant function, $f_1(\xi, \eta) = f_1(\xi)$, is then defined as,

$$f_1(\xi, \eta) = f_1(\xi) = \xi - \frac{0.532 + 0.33}{2}$$

i.e.,

$$f_1(\xi) = \xi - 0.431$$

and

$$f_1(\xi) \geq 0 \text{ implies ETS busses, and}$$

$$f_1(\xi) < 0 \text{ implies other vehicles.}$$

During the process of defining the decision boundary, the mid-point is used instead of a point proportional to their respective standard deviations because it was decided that a much heavier penalty would be imposed on the misclassification of ETS busses than that of other vehicles.

2.3.2.2 In the case $N = 2$ and $\eta < 1$ (Fig. 2.10)

Only a few data points were gathered in this category (a total of 7, 2 ETS busses and 5 other vehicles). The centroids of these two classes were estimated to be:

$$\text{For ETS busses, } \mu_b = 0.155$$

$$\text{For other vehicles, } \mu_o = 0.26$$

It is obvious that, since $\eta < 1$ and the second maximum is the global maximum in a typical ETS bus signature, the detected first maximum is in fact the "real" first maximum and the "real" third maximum is missing. From the size of the data set, it appears to be a rare case although these

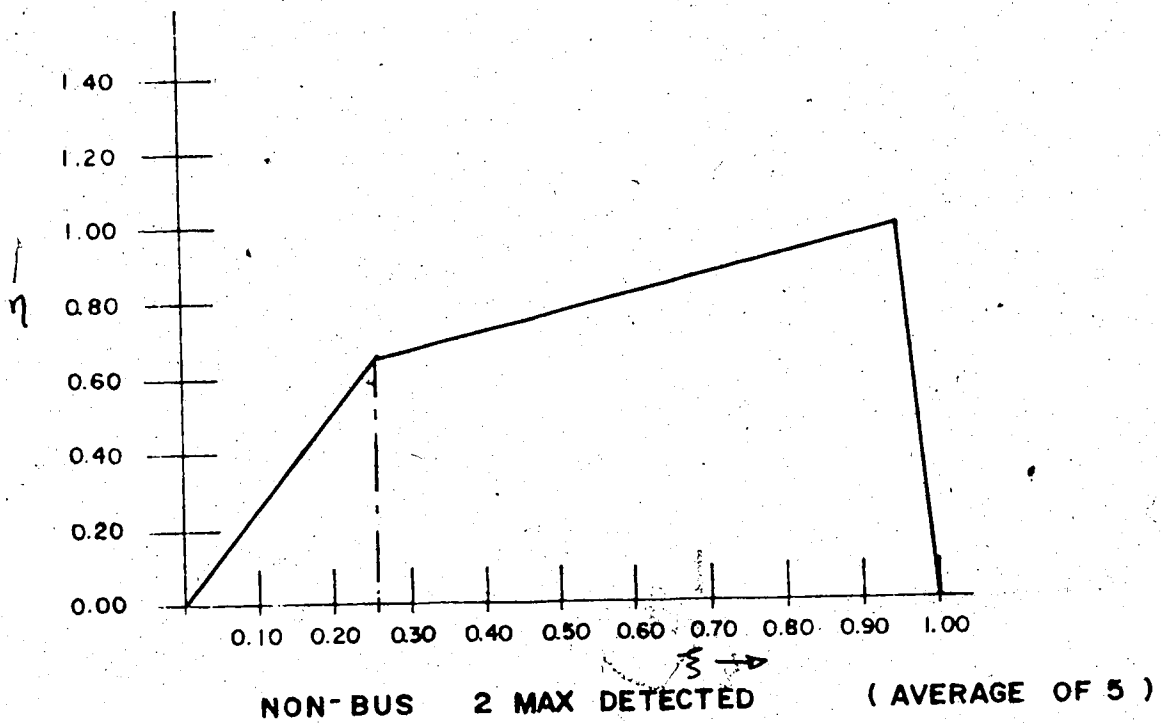
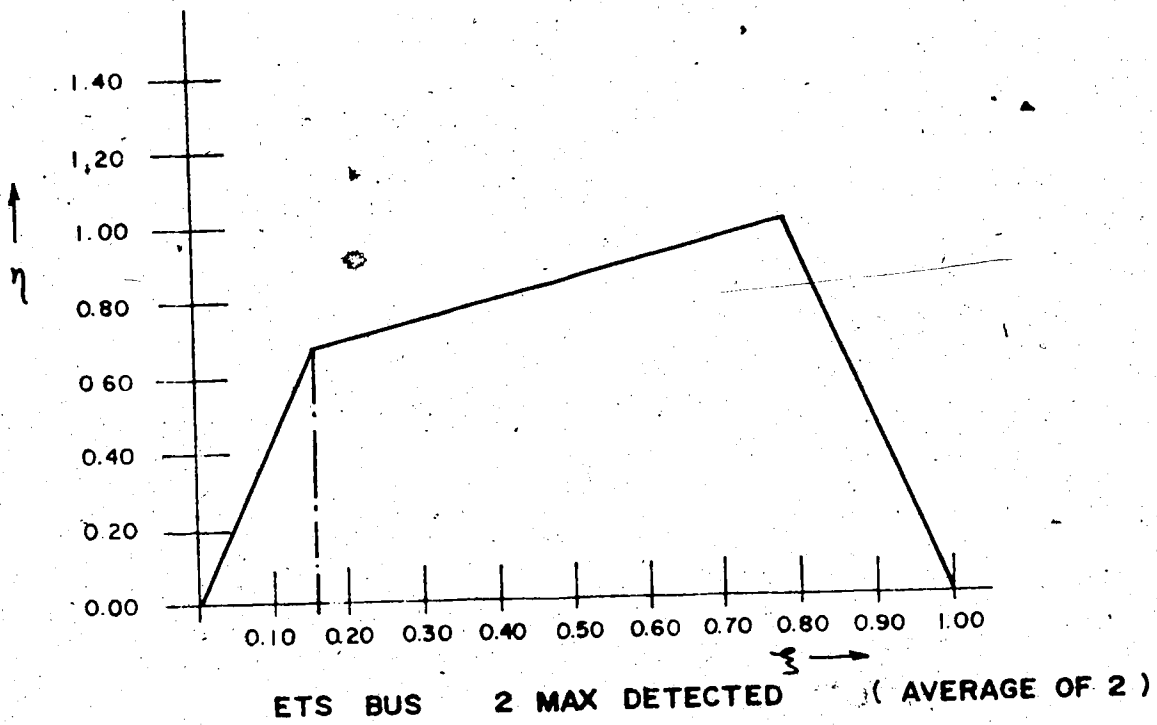

Fig. 2.10 Averages of Normalized Signatures

$$N = 2, \eta < 1$$

signatures do exist. Using the same argument as in section 2.3.2.1, we arrive with a discriminant function as follows:

$$f_2(\xi, \eta) = f_2(\xi) = \frac{0.155 + 0.26}{2} - \xi$$

i.e.,

$$f_2(\xi) = 0.208 - \xi$$

and

$$f_2(\xi) \geq 0 \text{ implies ETS busses, and}$$

$$f_2(\xi) < 0 \text{ implies other vehicles.}$$

2.3.3 Signatures with 3 or 4 Local Maxima

Referring to table 2.1, the vehicle classes that exhibit this characteristic are moving vans, ETS busses (trolley and diesel), semi-trailers and auto-carriers. Following the same argument as in section 2.3.2, we first proceed with the case where $\eta \geq 1$ and then $\eta < 1$.

2.3.3.1 In the case $N \in (3,4)$ and $\eta \geq 1$ (Fig. 2.11).

Mean values of the ETS busses and the other vehicles were estimated as follows:

$$\text{For ETS busses, } \mu_b = 0.532$$

$$\text{For other vehicles, } \mu_o = 0.20$$

Again, in this case, the detected first maximum is actually the "real" second maximum in a typical ETS bus signature and the discriminant function, $f_3(\xi, \eta)$, is defined as:

$$f_3(\xi, \eta) = f_3(\xi) = \xi - \frac{0.532 + 0.20}{2}$$

i.e.,

$$f_3(\xi) = \xi - 0.366$$

and

$$f_3(\xi) \geq 0 \text{ implies ETS busses, and}$$

$$f_3(\xi) < 0 \text{ implies other vehicles.}$$

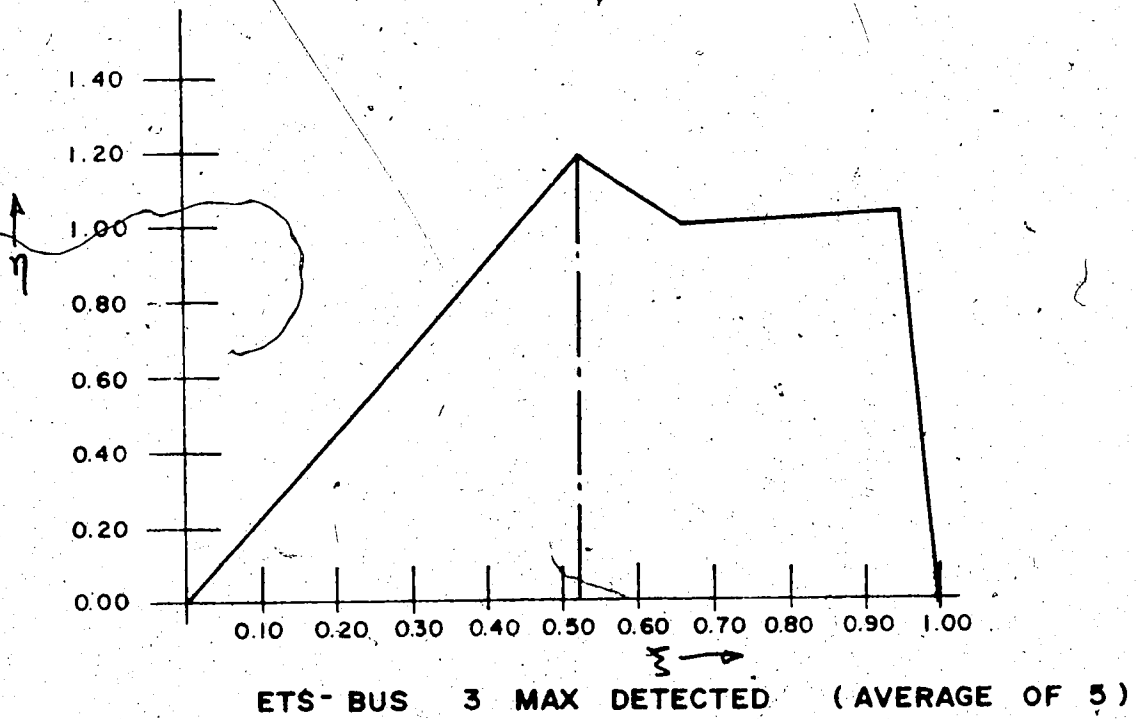
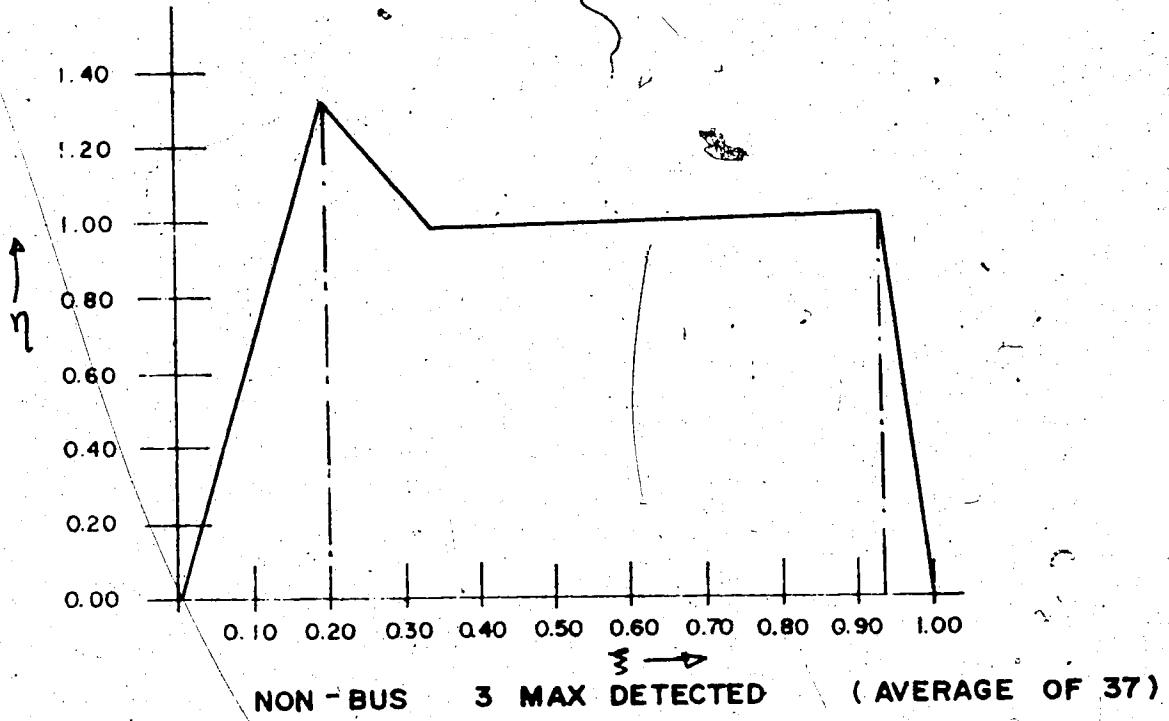

Fig. 2.11 Averages of Normalized Signatures

$N \in (3,4), \eta \geq 1$

2.3.3.2 In the case $N \in (3,4)$ and $\eta < 1$ (Fig. 2.12)

This is the case where the majority of the ETS busses falls into. It includes basically all the characteristics of a typical ETS bus signature. Since no other vehicle signatures exhibit these characteristics from the collected data set, any signature which possesses such characteristics will be considered as that of an ETS bus.

2.4 Summary and Conclusion

2.4.1 Summary - Final Decision Algorithms

For ease in software implementation, the final discriminant functions are modified and summarized as follows:

1. For $N = 2$, $\eta \geq 1$

$$f_1(\xi) = \xi - 0.4$$

$f_1(\xi) \geq 0$ implies ETS busses, and

$f_1(\xi) < 0$ implies other vehicles.

2. For $N = 2$, $\eta < 1$

$$f_2(\xi) = 0.167 - \xi$$

$f_2(\xi) \geq 0$ implies ETS busses, and

$f_2(\xi) < 0$ implies other vehicles.

3. For $N \in (3,4)$, $\eta \geq 1$

$$f_3(\xi) = \xi - 0.4 \quad (\text{same as case 1})$$

$f_3(\xi) \geq 0$ implies ETS busses, and

$f_3(\xi) < 0$ implies other vehicles.

4. For $N \in (3,4)$, $\eta < 1$

The vehicle is classified as an ETS bus.

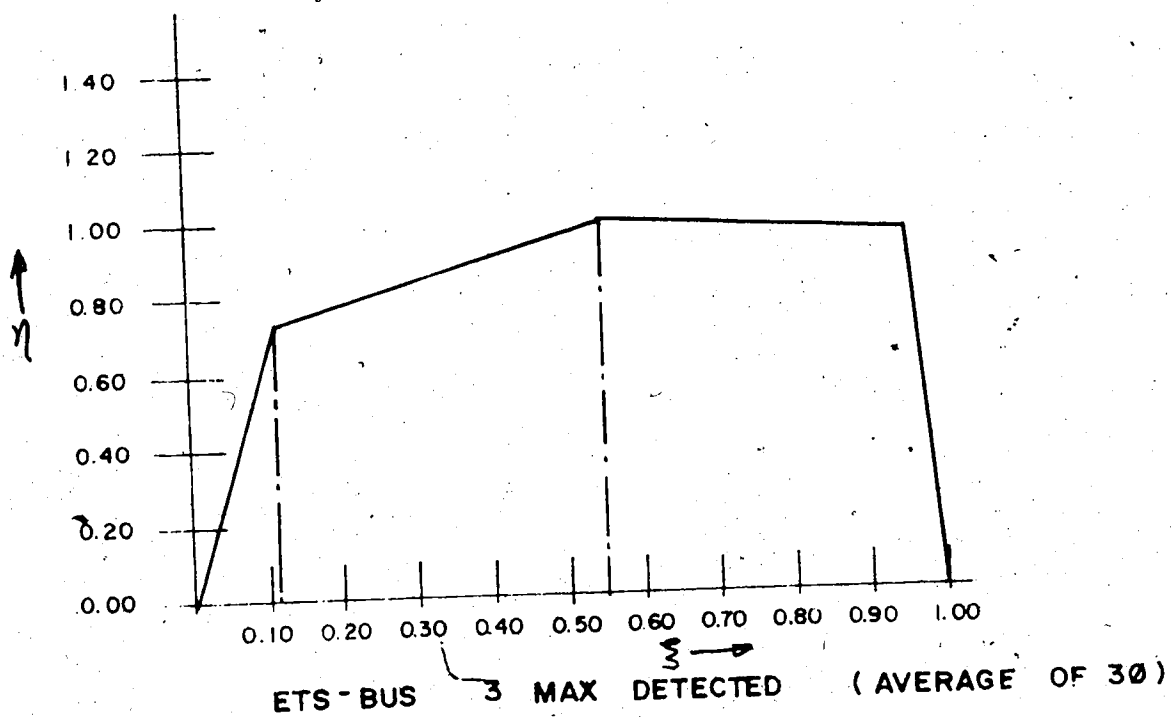

Fig. 2.12 Average of Normalized Signatures

$$N \in (3,4), \eta < 1$$

2.4.2 Conclusion

After the final decision algorithms were implemented in the software in the microcomputer memory, the system was field tested to have an accuracy very closed to 100%.

3.1 Introduction

The hardware implementation of the system consists essentially of three major units. They are:

1. The sensing unit,
2. The peripheral unit, and
3. The processing unit.

The following sections will describe these units and their operations.

3.2 The Sensing Unit

Out of the list of presently used equipment by Edmonton Power, the LD-4 loop vehicle detector of the LFE Corporation was chosen after some extensive testing to be the suitable candidate for the sensing unit. It is a solid-state self-tuning phase-shift vehicle detector. The basic principle of operation of this unit is described in the following section.

3.2.1 Basic Principle of Operation of a Phase-shift Vehicle Detector

The sensing electronics of a phase-shift vehicle detector is essentially a RLC resonant circuit depicted in fig. 3.1.

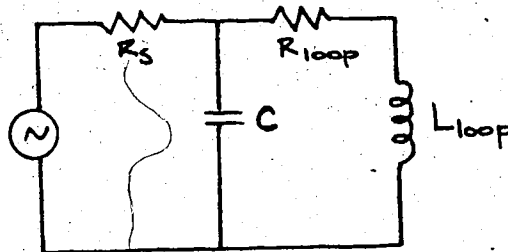

Fig. 3.1 A RLC Resonant Circuit

When the loop is excited with a high-frequency (about 100KHz) AC current, the presence of a vehicle (or a metallic object) in the electromagnetic field of the loop will cause a net decrease in its self-inductance due to the metallic frame of the vehicle. As a result, since the resonant frequency is defined by

$$f_r = \frac{1}{2\pi\sqrt{LC}}$$

it will shift to a higher frequency inversely proportional to the square root of the self-inductance. (Fig. 3.2)

$$\frac{f_{r1}}{f_{r2}} = \sqrt{\frac{L_2}{L_1}}$$

where f_{r1} = resonant frequency of the tank circuit in the absence of metallic object,

f_{r2} = resonant frequency of the tank circuit when a metallic object is in the electromagnetic field of the loop,

L_1 = self-inductance of the loop in the absence of a metallic object, and

L_2 = self-inductance of the loop when a metallic object is in its electromagnetic field.

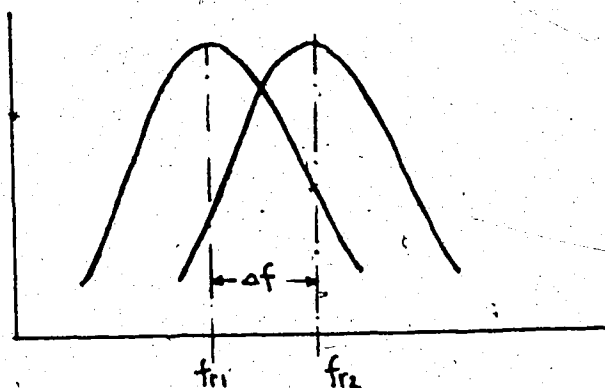

Fig. 3.2 Change of frequency by a metallic object

where Δf = the shift in resonant frequency

This change in frequency is then detected in the form of a phase-shift by a phase-shift detector within the detector electronics as shown in fig

3.3.

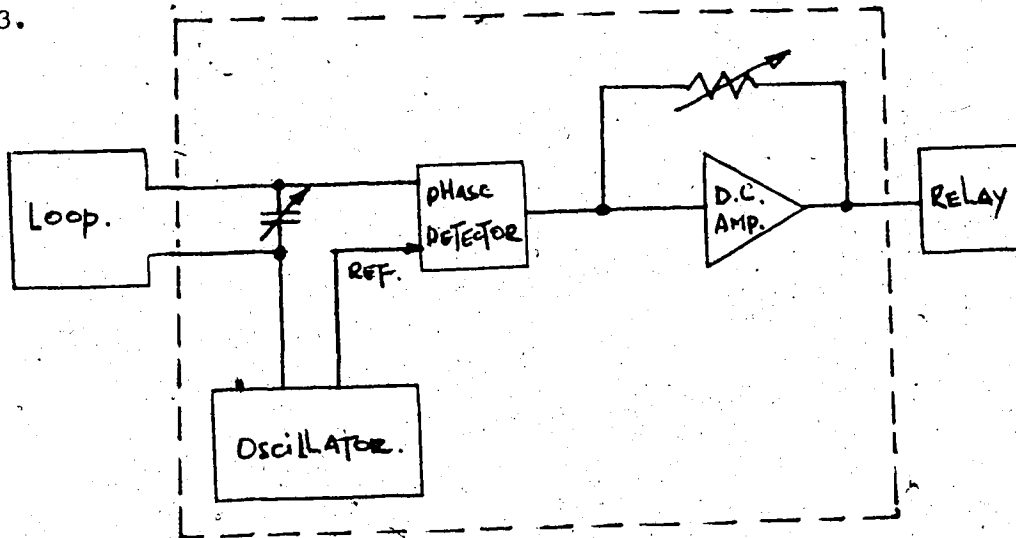

Fig. 3.3 A phase-shift loop vehicle detector (Block diagram)

The output from the phase detector, in the form of a DC voltage, is then amplified to trigger the relay to close or open thus rendering a detection. In this project, however, a more sophisticated approach is taken at the signal output from the DC amplifier. Since the change (decrease) in self-inductance of the loop, hence the resonant frequency of the tank circuit, is dependent on the structure of the undercarriage of the vehicle and on the distance between the loop and these metallic lumps, the output of the DC amplifier thus takes the form of a continuous signal somewhat proportional to the metallic structure of the undercarriage of the vehicle. This continuous signal is defined as the signature of the

vehicle type. (The signature is the essence of the whole project as it is rather unique for each type of vehicles and carries all characteristics needed for the vehicle classification.) The analog signal is then amplified and filtered before it goes to the peripheral unit.

3.2.2 Amplifier and Filter

The signal amplification was designed by using an integrated circuit (IC) difference amplifier (fig. 3.4). The signal from the LD-4 detector was fed to the positive input of the μ A741 while a reference signal was fed to the negative input. The voltage gain is controlled by four resistors as shown:

$$V_{out} = \left(\frac{R_1 + R_2}{R_3 + R_4} \right) \left(\frac{R_4}{R_1} \right) V_2 - \left(\frac{R_2}{R_1} \right) V_1$$

Choosing $R_1 = R_3$ and $R_2 = R_4$ to minimize the offset error due to biased current, we have

$$V_{out} = \left(\frac{R_2}{R_1} \right) (V_2 - V_1)$$

and the gain is therefore,

$$\frac{V_{out}}{(V_2 - V_1)} = \frac{R_2}{R_1} = \frac{R_3}{R_4}$$

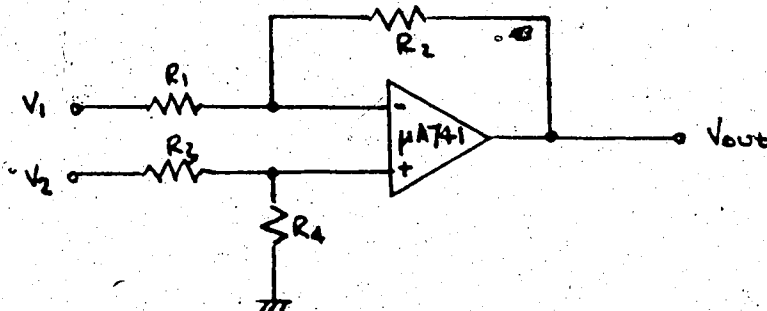

Fig. 3.4 Difference Amplifier

The output, V_{out} , is then fed to the input of a unity gain Voltage-Control-Voltage-Source (VCVS) Butterworth Low Pass Filter (LPF) to enhance the signal to noise ratio (S/N) of the signature. The LPF is designed to cut off noise frequencies higher than the signal itself and a cut-off frequency of approximately 10 Hz was chosen.

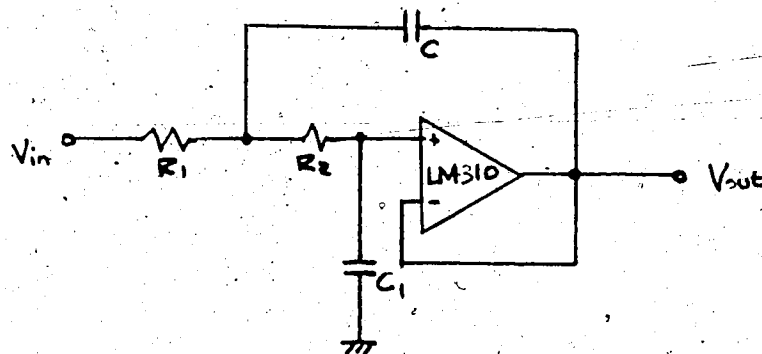

Fig. 3.5 VCVS Butterworth LPF

Values of the components in the above circuit were derived using the following formula:

$$C = \left(\frac{100}{K f_c} \right) \mu\text{F}$$

where the parameter K is chosen to be 1, and f_c is the cut off frequency which is equal to 10 Hz. Hence,

$$C = \frac{100}{10} = 10 \mu\text{F}$$

and the values of the other components are, from a design table,

$$R_1 = 1.65 \text{ K}$$

$$R_2 = 5.1 \text{ K}$$

$$C_1 = 3.3 \mu\text{F}$$

The overall interface circuit is depicted by fig. 3.6

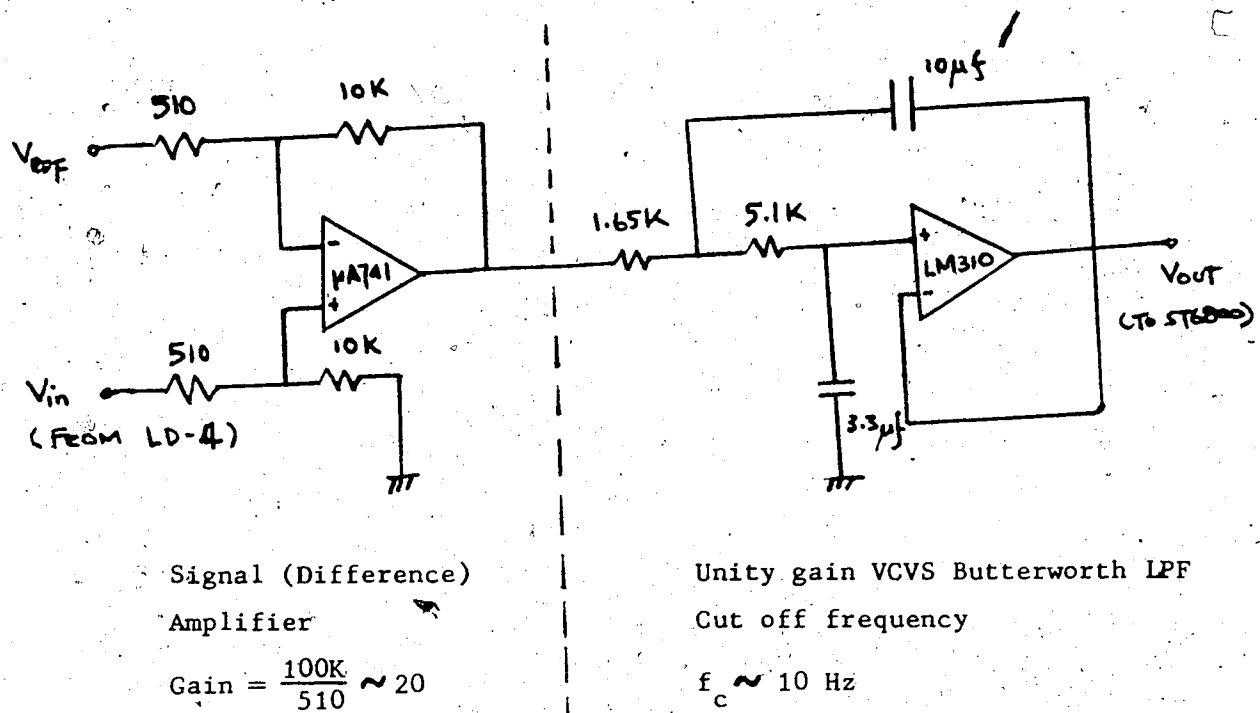

Fig.-3.6 Overall interface circuit

3.3 The Peripheral Unit

3.3.1 Description

The ST-6800B1A is an analog peripheral unit manufactured by the DATEL Systems, Inc. It is compatible to Motorola's M6800 microcomputer systems. This is a real time programmable unit and is capable of interfacing both the analog input and output signals to this microcomputer system.

This A/D-D/A peripheral device accepts 16 analog input channels and outputs 2 analog channels. Under program control from the microcomputer, particular input channels are selected and digitized. The digitized data is then stored in user-selected memory locations so that it may be further processed.

The ST6800B1A A/D-D/A system provides a 12-bit binary resolution and is

organized as a memory-mapped input/output (I/O) device. It appears to the M6800 microcomputer unit (MPU) as a block of 512 consecutive memory locations. Analog input channels may be either randomly or sequentially converted and stored in memory at rates of up to 28,000 samples per second.

3.3.2 Operation

As shown in figure 3.7, addresses A1 through A7 from the M6800 MPU address bus are loaded into the A/D address latch by a STROBE command while the MPU is in a HALT state. The output from this latch then selects and enables one of the 16 input channels.

The trailing edge of the STROBE command then triggers the Sample and Hold One-Shot (S/H OS.) which in turn triggers a CONVERT command. The leading edge of this CONVERT pulse places the S/H amplifier in the HOLD state and the trailing edge initiates the A/D conversion. After the conversion is completed the A/D converter will issue an output to reset the GO/HALT Flip Flop (FF) so that the MPU can resume its operation. (see figure 3.8)

3.3.3 Base Address

The 512 consecutive memory locations required by the ST6800B1A board are allocated at \$4000 through \$41FF in the M6800 memory system by jumper connections. (\$ sign represented hexadecimal number)

3.4 The Processing Unit

3.4.1 Descriptions

The MEK6800DII is a completely self-contained microcomputer module. It includes the following devices:

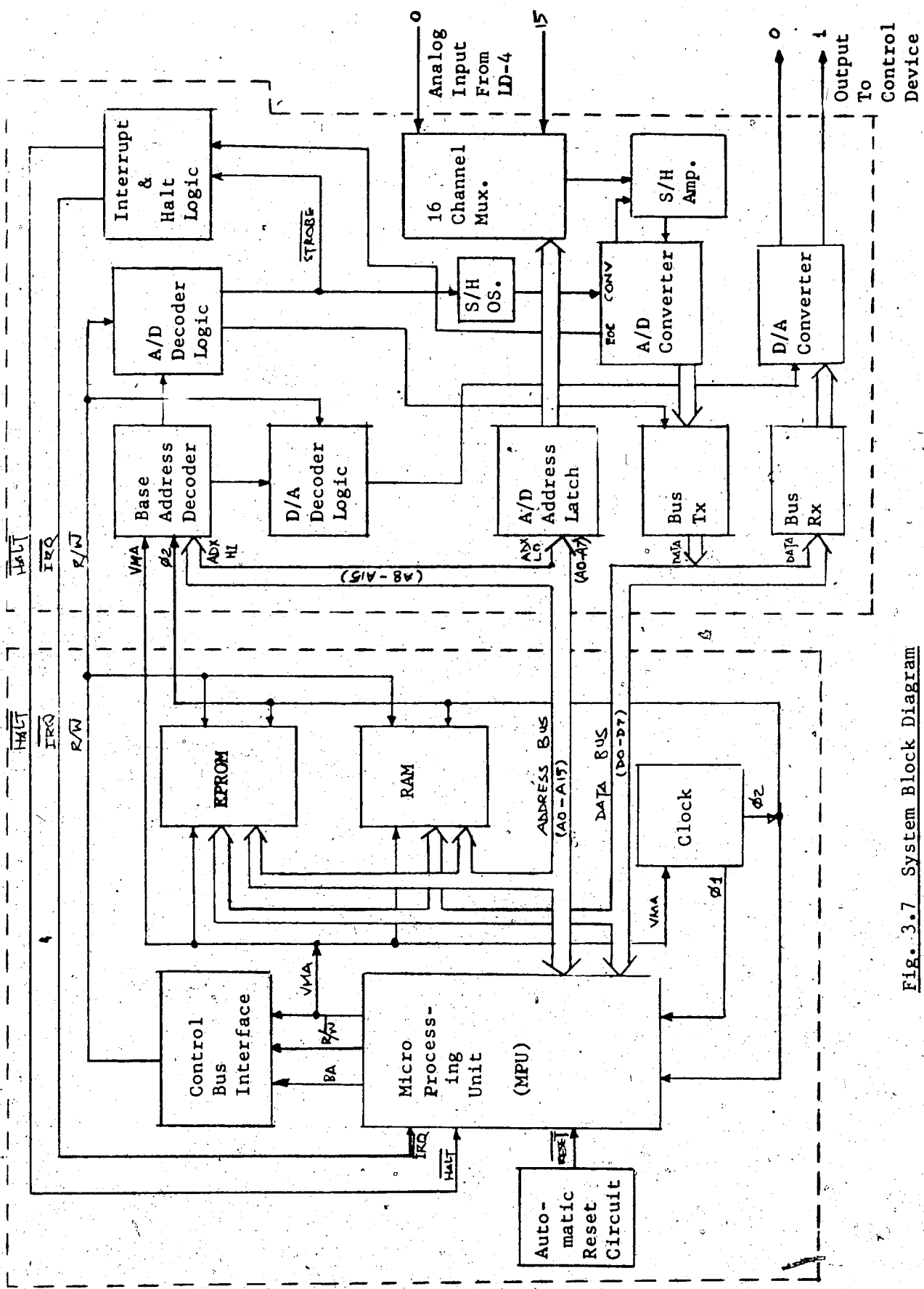

Fig. 3.7 System Block Diagram

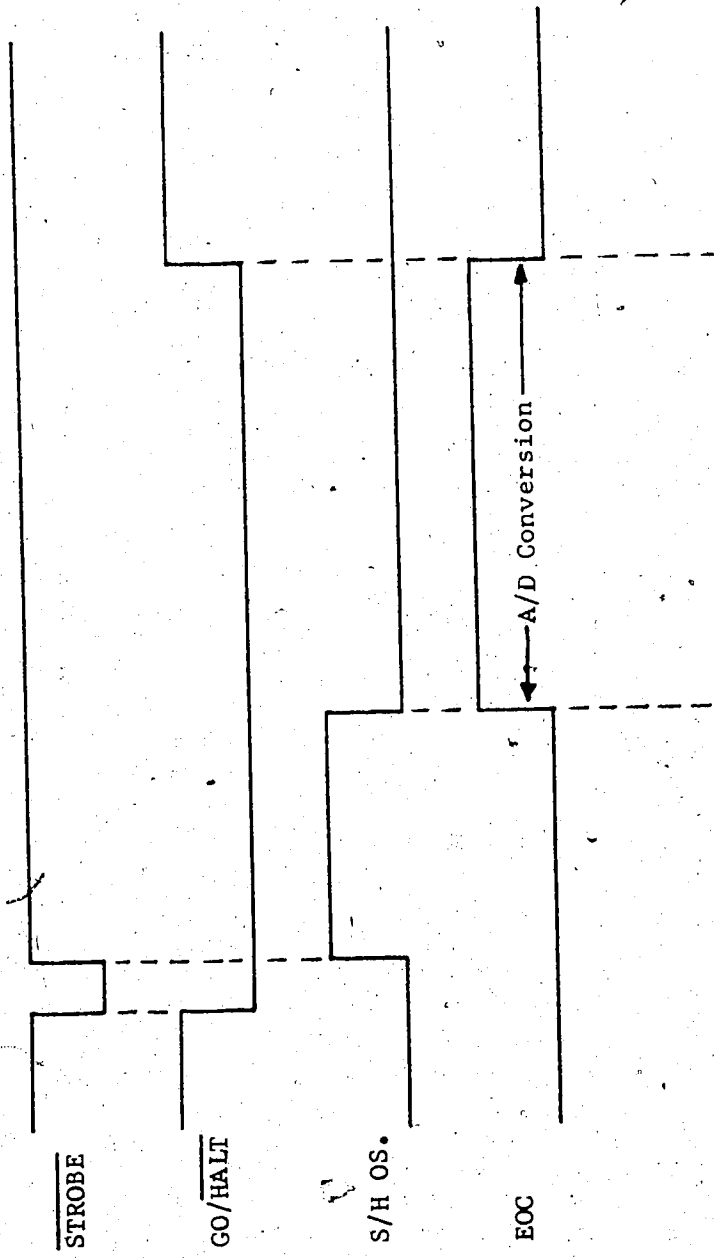

Fig. 3.8 Timing Diagram for A/D Conversion



<u>Qty</u>	<u>Devices</u>
1	MC6800 MPU
1	MCM6830 Read Only Memory (ROM) with JBUG Monitor
3	MCM6810 Random Access Memory (RAM) 128 X 8 bits each
2	MC6820 Peripheral Interface Adapter (PIA)
1	MC6850 Asynchronous Communication Interface Adapter (ACIA)
1	MC6871B Clock Generator

Where the JBUG Monitor is the firmware supplied by the Motorola Inc. which provides the control and diagnostic capability of the system. All these devices are necessary during the development stage although they are not all needed for the final product.

3.4.2 Memory Organization

The addresses of this microcomputer module are not fully decoded and the highest address in the memory field is at \$E3FF. Therefore the JBUG monitor program, which is preprogrammed into a Read Only Memory (ROM), resides at the addresses from \$E000 to \$E3FF in which the reset vector is located at addresses \$E3FE and \$E3FF. However, in order to achieve a power failure automatic reset sequence, an Electrically Programmable Read Only Memory (EPROM) which contains the classification program will have to co-reside at the same addresses (i.e., from \$E000 to \$E3FF). The rest of the memory locations are the same as the standard MEK6800DII module except, as mentioned in section 3.3.3, that memory locations \$4000 through \$4103 are occupied by the ST6800B1A A/D-D/A peripheral system. Figure 3.9 depicts the memory organization of this microcomputer system.

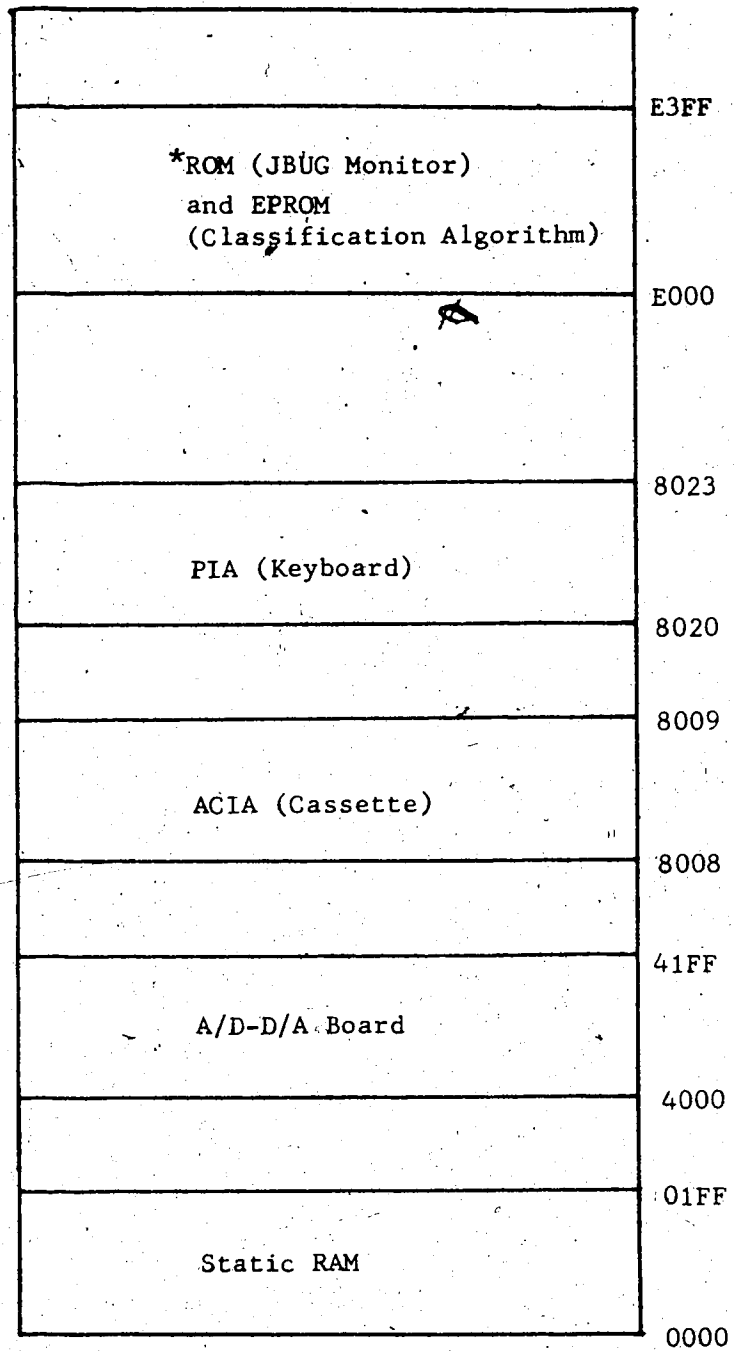

Fig. 3.9 Memory Organization

* One of the two is selected via a toggle switch

3.4.3 Operations

The decision algorithm developed in Chapter 2 is preprogrammed into the EPROM of 1K byte memory. When digitized signals are coming in from the peripheral unit, this program will first extract the features in the same order described by the hierarchical decision tree. It then evaluates the discriminant functions derived from the preceding chapter. If the vehicle is recognized as an ETS bus, the microcomputer module will issue a +10Vdc output via one of the D/A channels from the peripheral unit. This output can then be used to trigger a relay to actual a control device such as a control gate or a bus preemption traffic signal.

3.4.4 Modifications

In order to operate the system in a fully automatic manner, it is necessary to design a power-failure automatic reset circuit (the module has a manual reset circuit only) such that when the power source is up from a failure, the system will be in operation after a prestored reset sequence.

To accomplish such an operation, two start-up criteria must be satisfied.

1. It must ensure that the power supply to the MPU has reached the minimum required operating voltage of 4.75 Vdc.
2. The RESET line must then be held low for a minimum of 8 complete clock periods.

The circuit in figure 3.10 provides a delay of 300 msec to cover the 8 clock cycles (1 clock cycle is equal to 1.6 msec in this system) with R_2C_2 time constant after the R_1C_1 time constant input has triggered the

MPU insuring the V_{CC} ($5 \text{ Vdc} \pm 5\%$) has reached the minimum required level (Fig. 3.11).

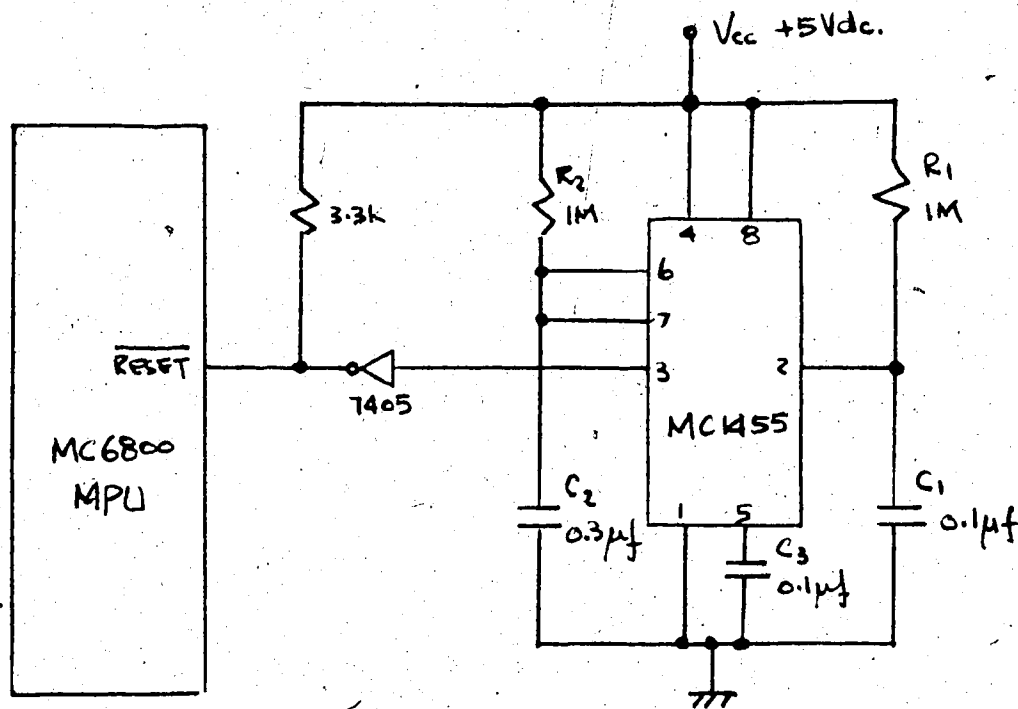

Fig. 3.10 Power Failure Automatic Reset Circuit

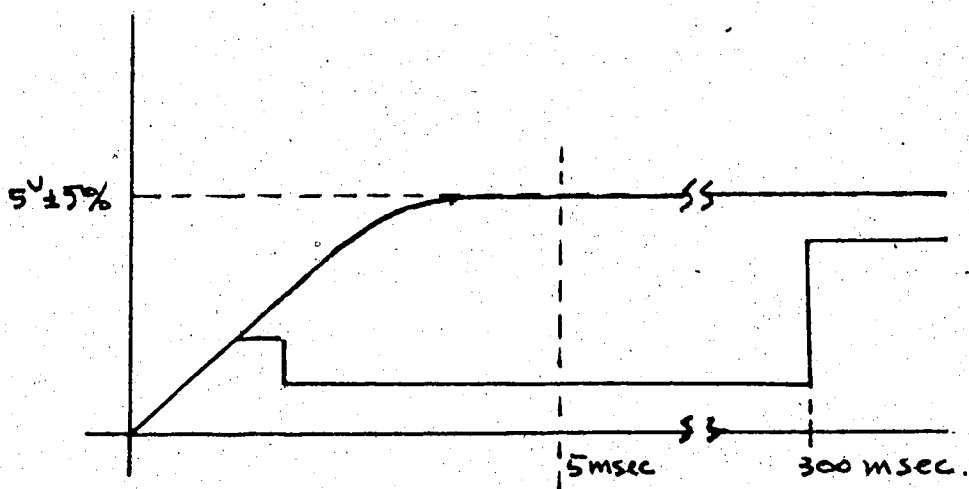

Fig. 3.11 Timing Diagram for Power Start-up

4.1 Introduction

Software development very closely follows the development of the classification algorithm. Different routines were designed and implemented for data analysis and parameter designations. Programs were developed in assembler language and were assembled and debugged on the AMDAHL computer via a M6800ASM cross-assembler program. They were then stored, in the form of machine codes, in an audio cassette tape and were loaded into the microcomputer memory for field testing purposes. After the necessary testings, the final program was then "burnt" into an EAROM for actual operation.

These routines and programs were developed in the following order :

1. DATAcq
2. DAC
3. FETD
4. FEATURE
5. CLASSIF

The following sections will describe the logic of each of the above programs.

4.2 DATAcq

This program is developed to store digitized data from the peripheral unit into designated memory locations in the microcomputer module and then transfer them onto the audio cassette tapes via the JBUG monitor residence program. The flow chart in figure 4.1 depicts the logic flow in this program.

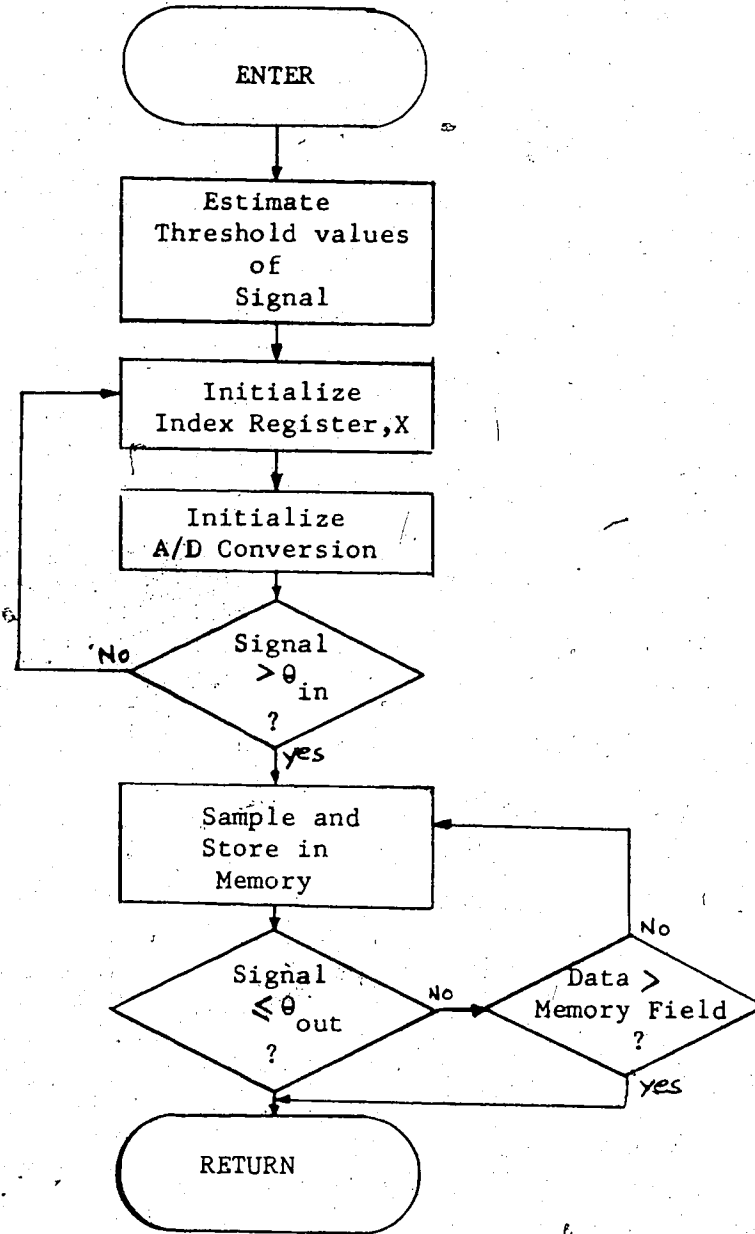

Fig. 4.1 Flow Chart DATACO

Two parameters were defined to initialize and the operation of the program. They are defined as the input threshold value, θ_{in} , and the output threshold value, θ_{out} . When the digitized signal level is higher than θ_{in} the program will start storing sampled values of the signal until it is lower than θ_{out} or when the designated memory field is full. The sampling rate is controlled by a timing loop subroutine.

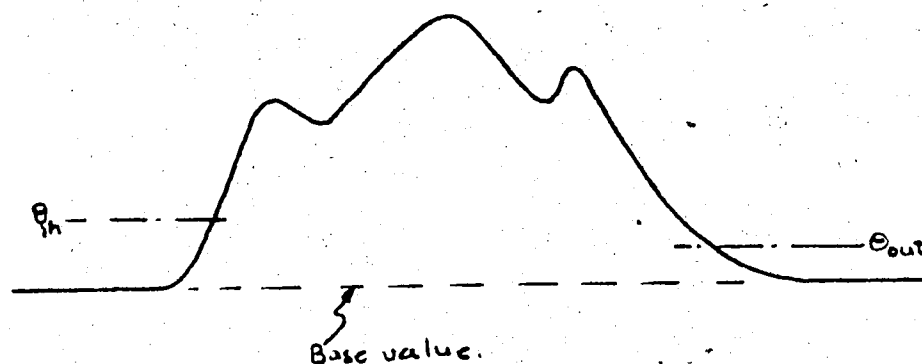

Fig. 4.2 input and output threshold values

The parameters θ_{in} and θ_{out} were rather arbitrarily chosen according to the base value of the signal, that is, signal level when there is no vehicle in the detection zone.

4.3 DAC

This program converts the sampled data stored in the microcomputer memory back into analog signals such that we can plot the signature on a strip chart or observe the signature on an oscilloscope.

4.4 FETD

This is a feature extraction program which extracts the local maxima and the local minima from the stored signature and stores them into

designated memory locations.

However, due to the noise that exists in the signal some form of digital filtering is required. After examining the stored data, a set of artificial data was created (fig. 4.4 & Program listing) and a tolerance, ϵ , was defined. As shown in figure 5.3 below, only a signal variation of more than ϵ will indicate the existence of a local extremum. Otherwise for any signal variation less than ϵ , it will be treated as noise and be rejected.

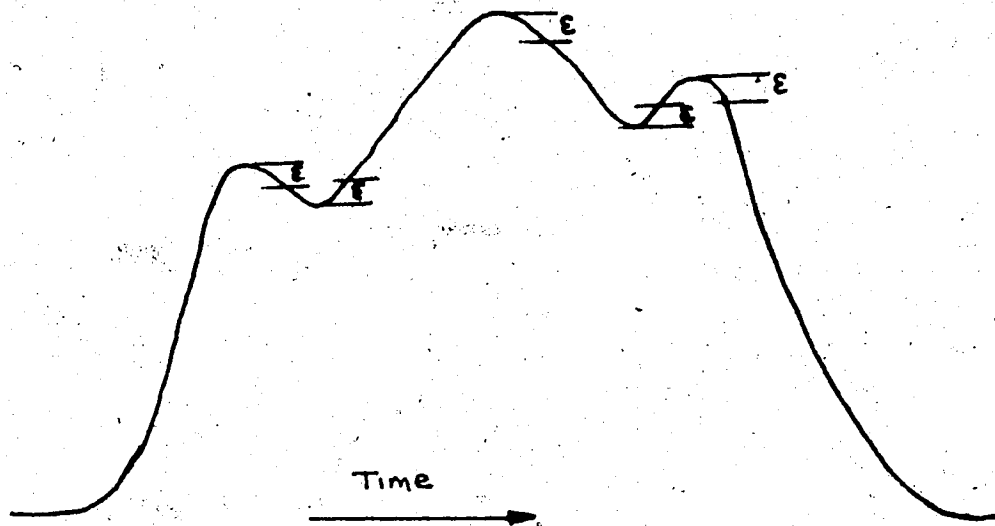

Fig. 4.3 Tolerance value for extremum detection

The following flow charts (Fig. 4.5,4.6) depict the logic flow in this program.

4.5 FEATURE

This program performs the same function as the FETD program (i.e., feature extraction). It basically combines DATAQ and FETD to form a real time program. It extracts and stores only the values of the local extrema

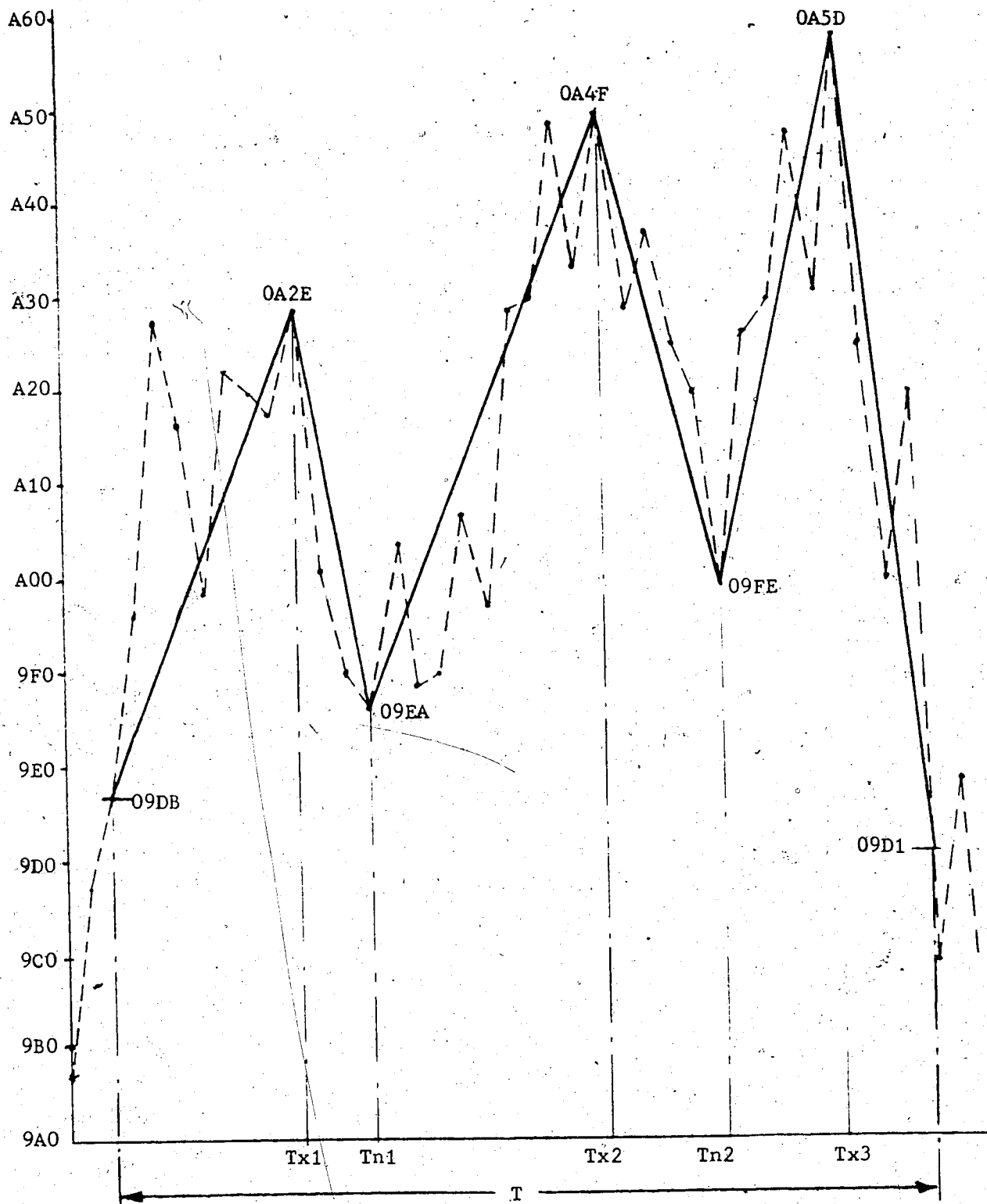

Fig. 4.4 Artificial Test Data

——— After Filtering
 - - - - - Digitized Data (Noisy)
 $\theta_{in} = 09DB, \theta_{out} = 09D1; \epsilon = 30$

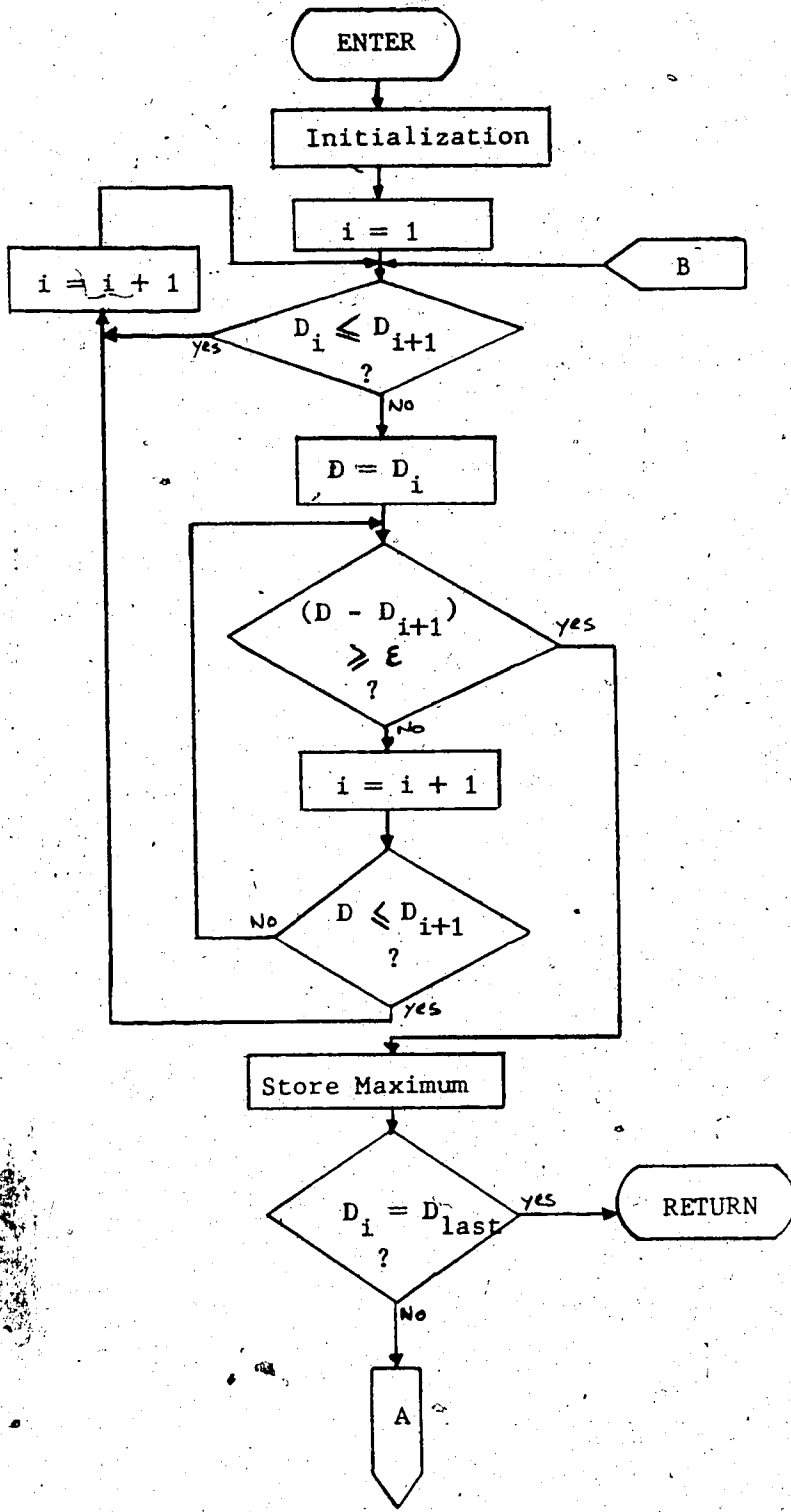

Fig. 5 Flow Chart. FEED

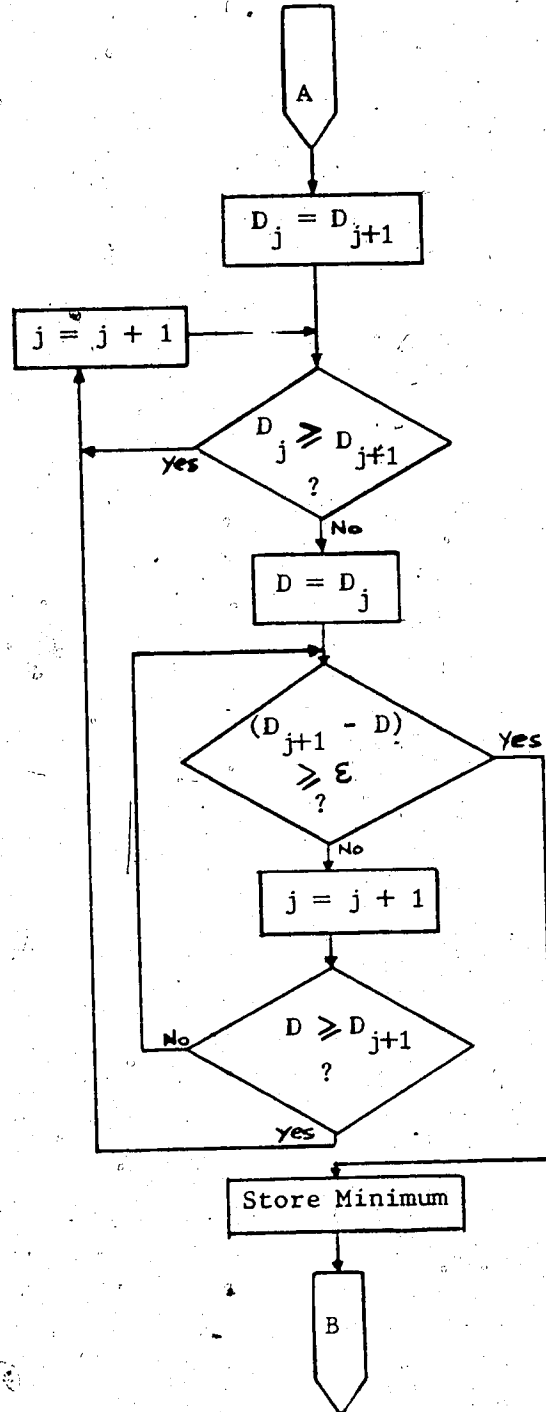

Fig. 4.6 Flow Chart ID (Cont'd)

of the signature in the designated memory locations without having to store the whole signature data. Thus it saves considerable memory space. Unlike FETD it only halts when the signal level is lower than the output threshold value, θ_{out} .

4.6 CLASSIF

In addition to FEATURE, this program consists of all discriminant functions defined in Chapter 2 plus a few more subroutines. This program is responsible for recognizing the ETS busses and outputting a +10Vdc signal to actuate a control device. The other features included in this program are listed as follows:

1. It updates the threshold values in predetermined intervals such that a stalled vehicle in the detection zone will not impair the performance of the system.
2. It resets itself after a vehicle has left the detection zone. (i.e. a new set of threshold values for each vehicle being detected) This subroutine thus compensates the change of base voltage due to the aging of the electronics of the detector; and it also enables the system to operate with different detector units without readjusting the threshold values in the software.
3. A subroutine to detect stalled vehicles in the detection zone is also included such that the system will not be tied up by such vehicles and will automatically go to other channels (other detection zones).
4. It also generates a 1 minute delay after system starts up to allow for the time needed by the LD-4 detector to tune itself.

The following flow charts (Fig. 4.7 through 4.12) show the logic flows in this program.

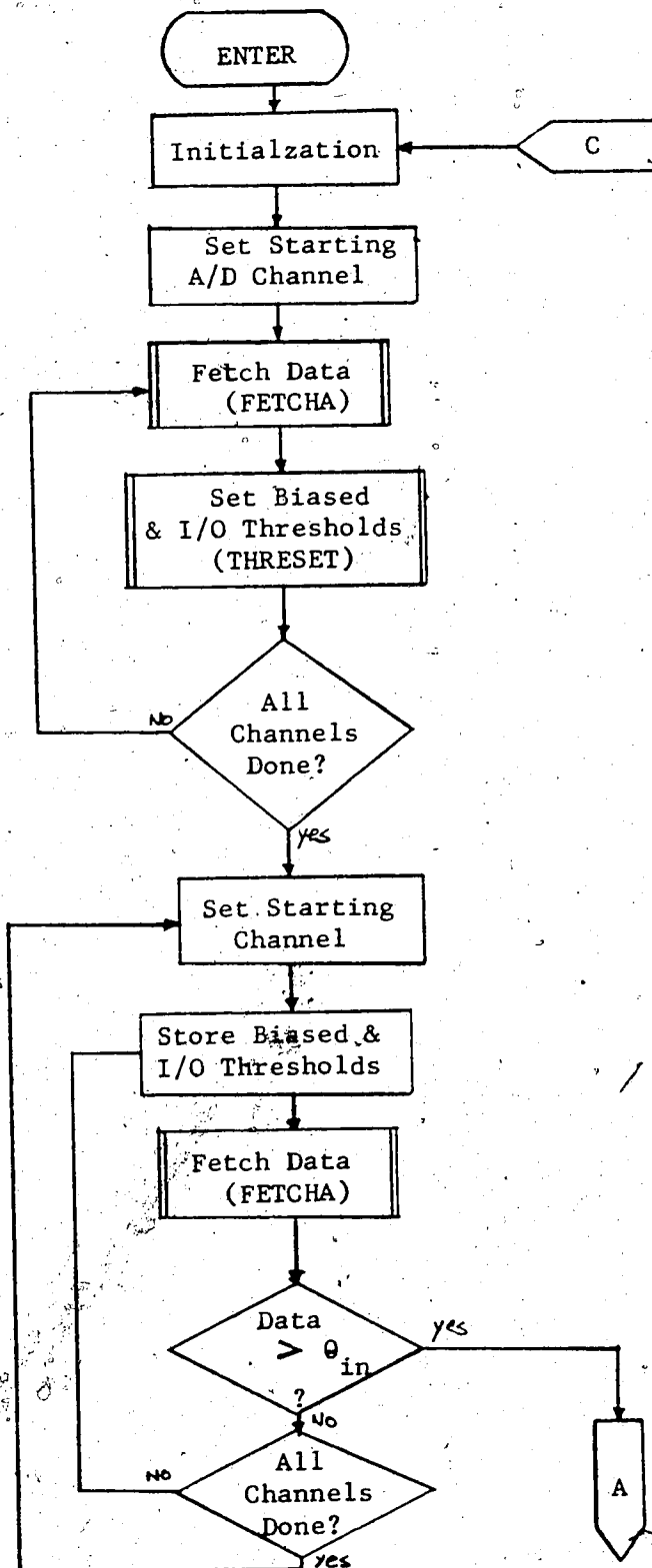

Fig. 4.7 Flow Chart CLASSIF

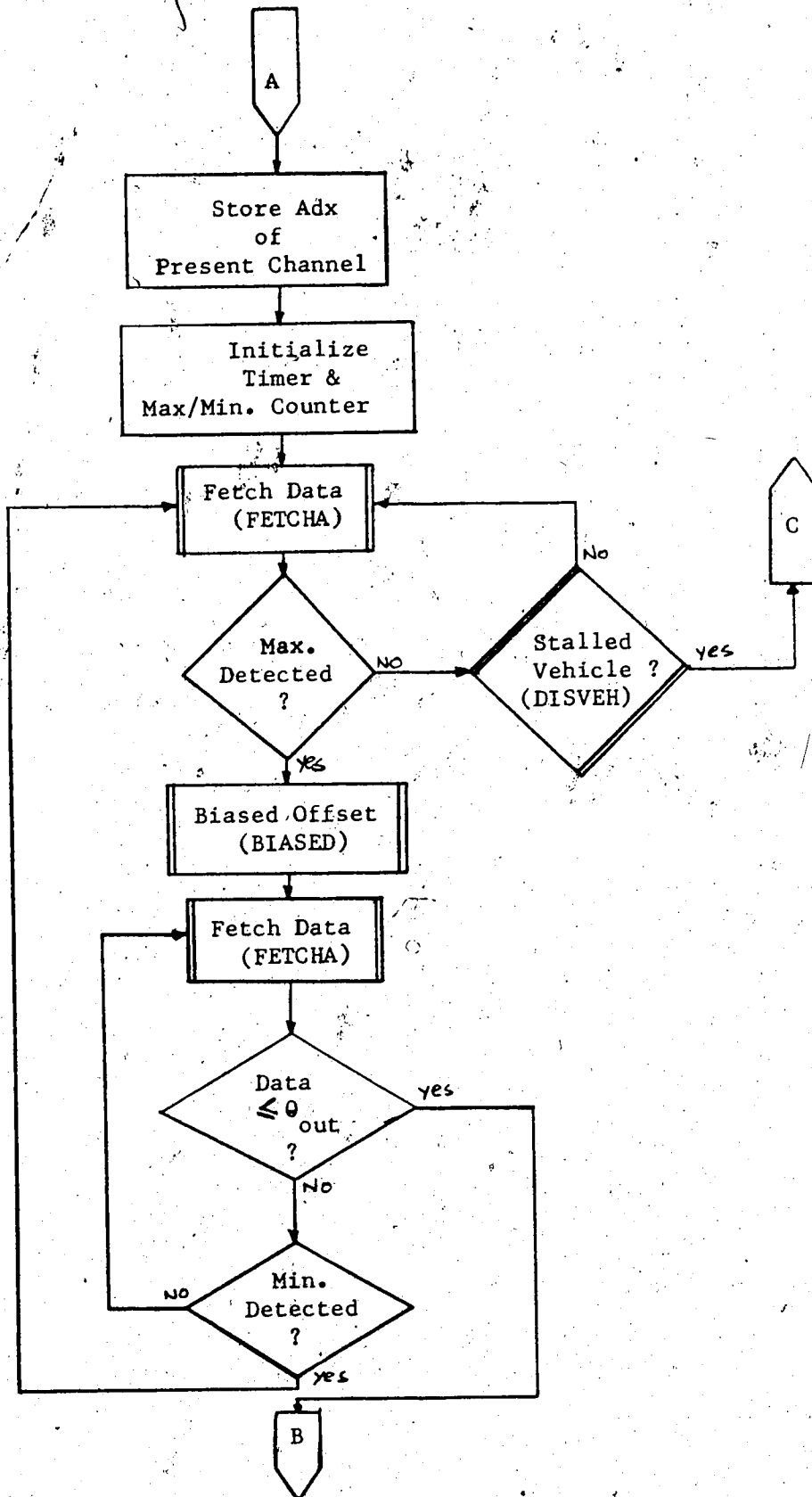

Fig. 4.8 Flow Chart CLASSIF (Cont'd)

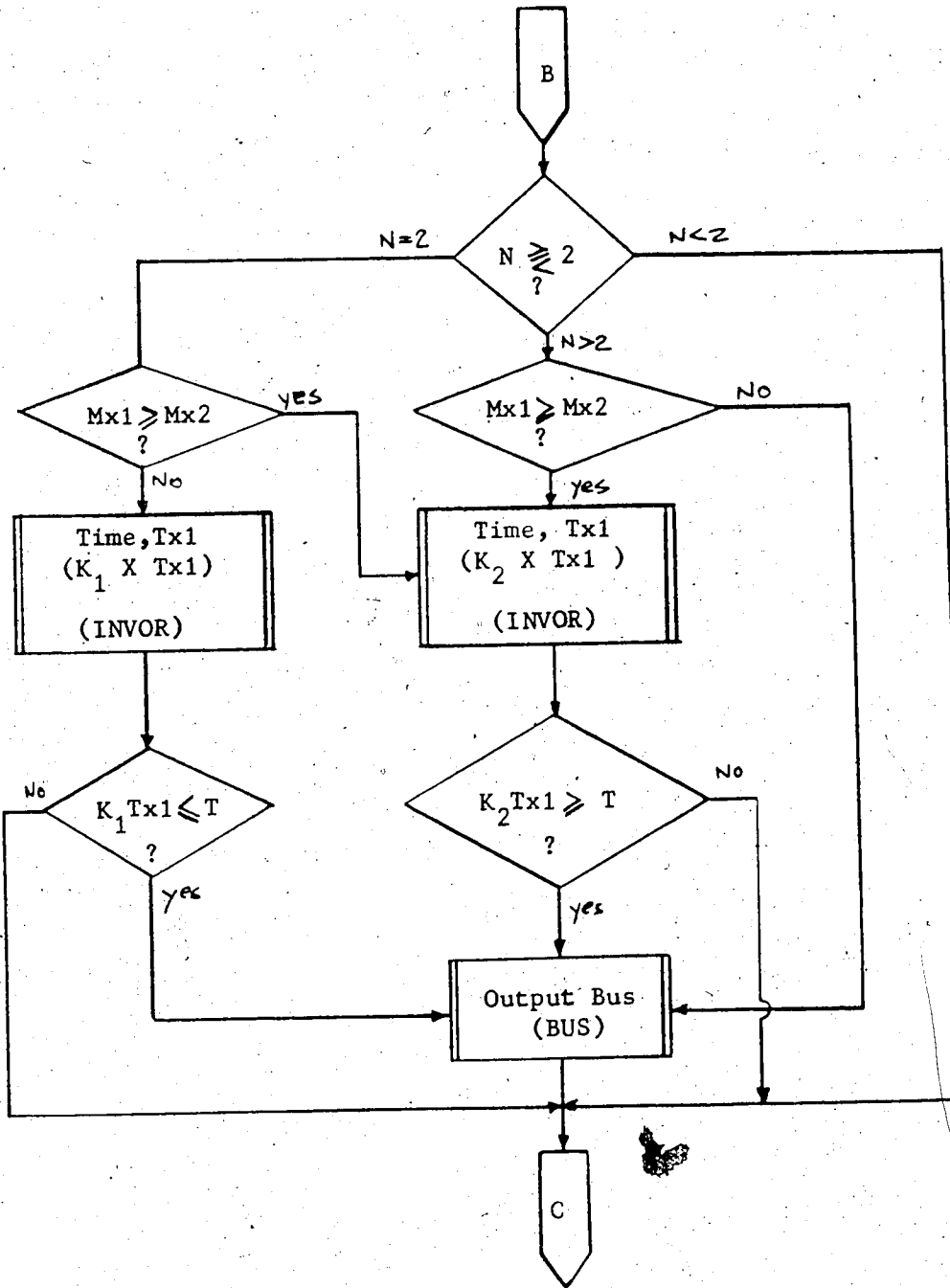

Fig. 4.9 Flow Chart CLASSIF (Cont'd)

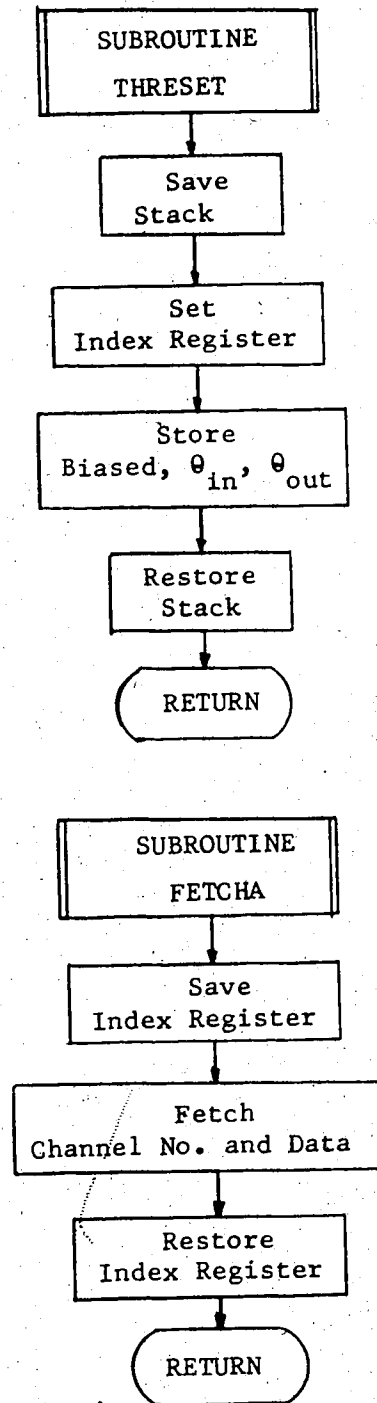

Fig. 4.10 Flow Chart CLASSIF (Cont'd)

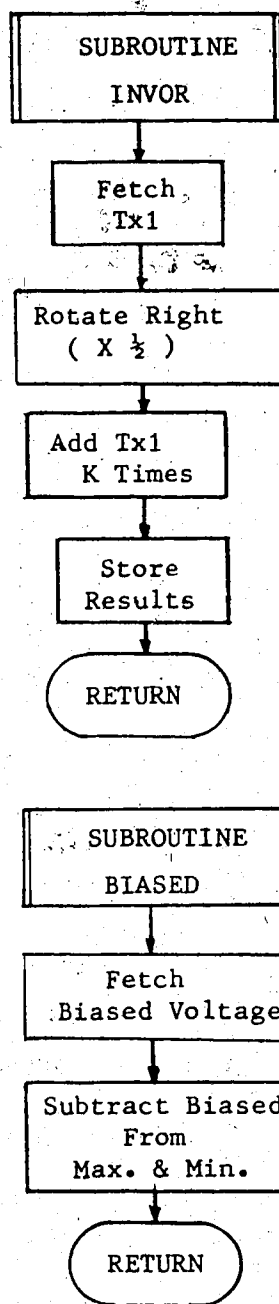

Fig. 4.11 Flow Chart CLASSIF (Cont'd)

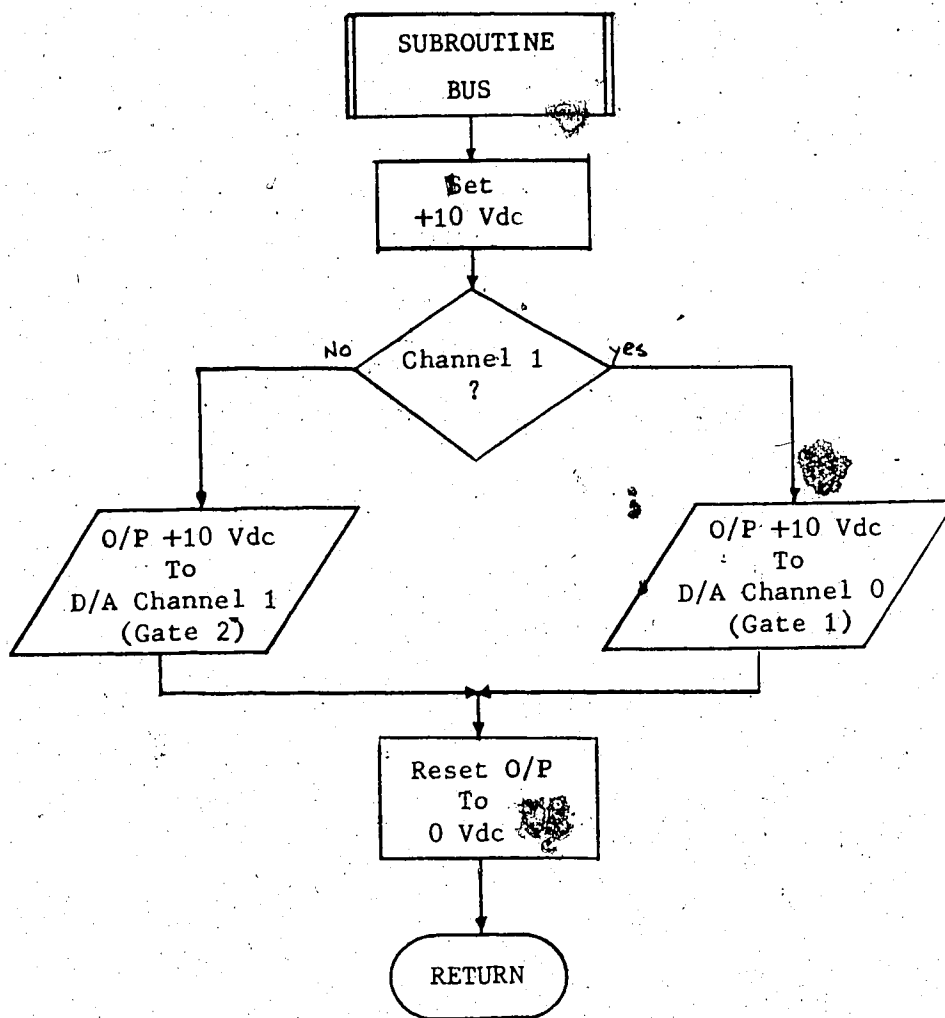

Fig. 4.12 Flow Chart CLASSIF (Cont'd)

This chapter includes the field test results, a cost analysis on the systems being used in the City of Edmonton and the areas for possible future developments.

5.1 Field Testing Results

The system was field tested in order to ensure that a high reliability rate could be achieved in an operating environment. Initially the system was capable of classifying ETS busses to a very high degree of accuracy. After the implementation of a LPF, only two (2) passenger cars and four (4) auto-carriers were identified as ETS busses. Adjustments were then made to the algorithm until this problem was eliminated. The testing period monitored a total of 3950 vehicles which included:

2892 cars and vans;

737 trucks, tandems and moving vans;

110 semi-trailers and auto-carriers; and

191 ETS busses.

The results of these field tests are shown in Tables 5.1, 5.2 and 5.3.

<u>Vehicle Types</u>	<u>No. Detected</u>	<u>Misclassification</u>	<u>accuracy</u>
Cars, vans	868	18	97.9%
Tr., Tandems, M.V.	348	8	97.7%
Semis. Auto-C.	45	5	88.9%
ETS Busses: Trol.	22	1	95.5%
Dies.	43	1	97.7%
TOTAL	1350	33	97.6%

Table 5.1 Field Test results (Before implementation of LPF)

<u>Vehicle Types</u>	<u>No. Detected</u>	<u>Misclassification</u>	<u>Accuracy</u>
Cars, vans	1653	2	99.9%
Tr., Tandems, M.V.	387	---	100.0%
Semis., Auto-C.	120	4*	96.7%
ETS Busses: Trol.	39	---	100.0%
Dies.	70	---	100.0%
TOTAL	2224	6	99.7%

Table 5.2 Field Test Results (After implementation of LPF)

* All four are auto-carriers

<u>Vehicle Types</u>	<u>No. Detected</u>	<u>Misclassification</u>	<u>Accuracy</u>
Cars, vans	271	---	100.0%
Tr., Tandems, M.V.	78	---	100.0%
Semis., Auto-C.	8	---	100.0%
ETS Busses: Trol.	6	---	100.0%
Dies.	13	---	100.0%
TOTAL	376	---	100.0%

Table 5.3 Field Test Results (Final Algorithm Installed)

At this point it was felt that the system could be placed into an operating environment for further evaluation particularly during winter conditions. The system has been installed to control gates on a bus only road in Edmonton. The bus only road in question has a high private vehicle volume despite signage forbidding these manoeuvres. A gate was therefore placed at each access of this bus only road. Call on detectors were located such that activation is possible from both directions. The gate closure operated on a timed delay basis. (Fig. 5.1)

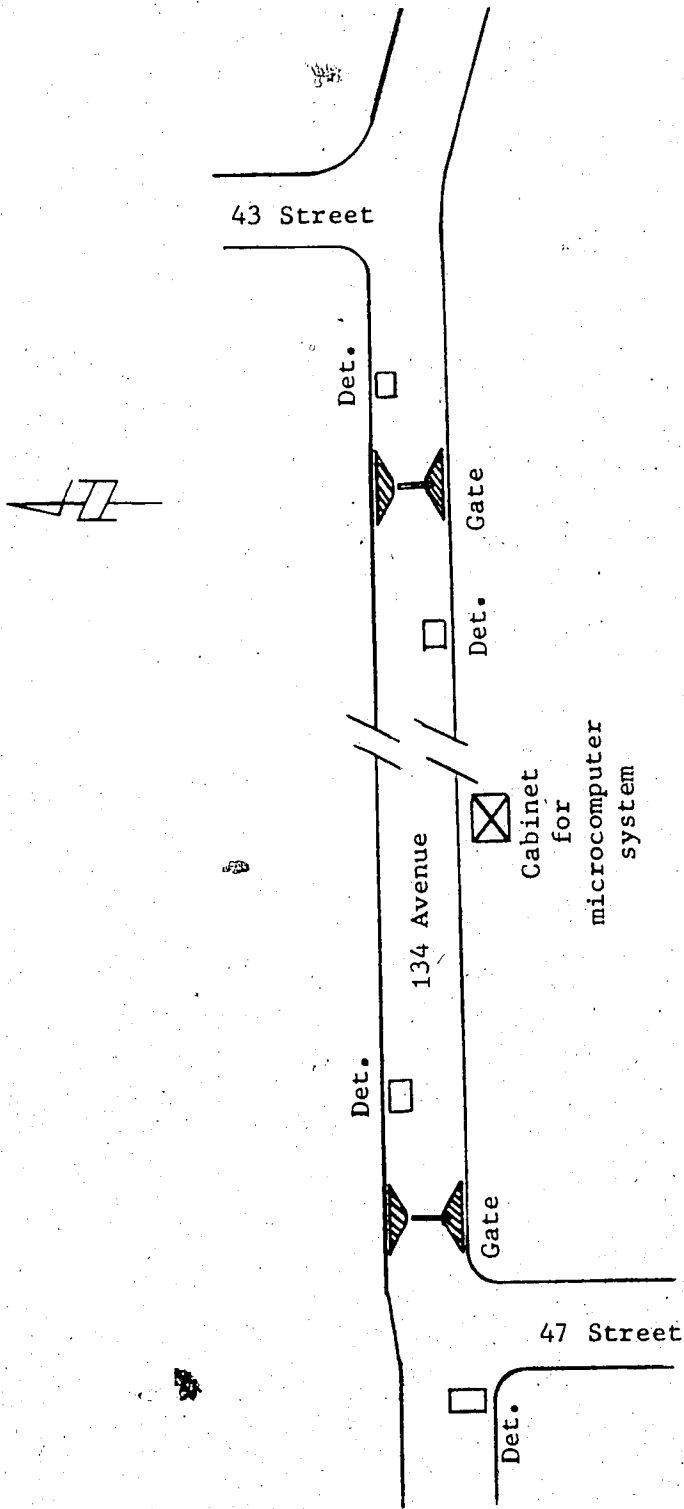

Fig. 5.1 Busway Control Gates in N.E. Edmonton

5.2 Cost Analysis on Existing Systems

As mentioned in Chapter 1 of this thesis, there are presently two other transit actuated systems used in the City of Edmonton, namely the garage door opener type and the vehicle-mounted type. Since it is the policy of the Edmonton Transit System (ETS) that ETS busses rotate their services to every route through the City, all busses will have to be equipped with either of the above devices in addition to the receiving mechanism to be installed on the specific routes that require such detection. Instead, if a passive bus detection system is used, it will be the only device required to be installed on such specific routes. The system developed in this thesis, a passive bus detection system, offers the following advantages over its counterparts.

1. Lower Operational Costs

(a) Installation and Equipment Costs:

The installation and equipment cost for each garage door opener is \$50.00 and for the vehicle-mounted transmitter is \$120.00. There are a total of 650 busses approximately. Therefore, a cost of \$32,500.00 will be incurred to equip all busses using the garage door opener type and \$78,000.00 using the vehicle-mounted type of transmitters. In addition, costs for the receiving mechanism are \$700.00 per intersection. The costs for the passive bus detector developed in this project are approximately \$2,500.00 per intersection. The City of Edmonton indicates that 15 intersections will require such kind of detection in the next two years. Table 5.4 shows a comparison in the costs incurred for the three systems.

<u>System</u>	<u>Tx. Devices</u>	<u>Rx. Devices</u>	<u>Total Cost</u>
Garage Door Opener	\$32,500.00	\$10,500.00	\$43,000.00
Vehicle-mounted Tx.	\$78,000.00	\$10,500.00	\$88,500.00
Passive Bus Det.	-----	\$37,500.00	\$37,500.00

Table 5.4 Cost Estimations for 15 Intersections

(b) Maintenance Costs:

There are only 15 devices to be maintained vs 650 + 15 devices which means that a substantial amount of man-hours will be saved in maintenance if the passive bus detectors are used.

2. Better Reliability

The garage door opener type and the vehicle-mounted transmitters are more vulnerable to damage than the passive bus detector since the latter is housed in a steel cabinet.

3. Easier to Manage

Transit operators do not have to remember to carry the garage door openers when they are on duty or to return them when they are off.

5.3 Conclusion and Future Developments

After the field testing and the early stage of operation, the system appears to be highly reliable (no system failure since the installation of the system on February 8, 1979). However, some arbitrariness still exist in the designation of the parameters such as the input threshold, θ_{in} , the output threshold, θ_{out} , and the tolerance value ϵ . Until a much larger data set is obtained, it is very difficult, if possible at all, to adjust these parameters to render an optimal operation.

BIBLIOGRAPHY

1. A.G. Arkadev and E.M. Braverman - "Computers and Pattern Recognition", Thompson Book Company, Inc., 1967.
2. H.C. Andrews - "Introduction to Mathematical Techniques in Pattern Recognition", Wiley-Interscience, 1972.
3. B.C. Batchelor - "Practical Approach to Pattern Classification", Plenum Press, 1974.
4. B.G. Batchelor - "Design for a High-Speed Euclidean Distance Calculator & its use in Pattern Recognition", 1974 Conference on Computer Systems & Technology, IEEE, Oct., 1974.
5. W.G. Chaplin and V.S. Levadi - "A Generalization of Linear Threshold Decision Algorithm to Multiple Classes", Computer & Information Sciences - II Proceedings of the second Symposium on Computer and Information Sciences, Academic Press, 1966.
6. C.H. Chen - "Statistical Pattern Recognition", Spartan Books, 1973.
7. R.O. Duda and P.E. Hart - "Pattern Classification and Scene Analysis", John Wiley & Sons, 1973
8. B. Everitt - "Cluster Analysis", Heinemann Educational Books, 1974.
9. R.M. Glorioso - "Engineering Cybernetics", Prentice-Hall Inc., 1975.
10. J.G. Graeme - "Applications of Operational Amplifiers - Third Generation Techniques", McGraw-Hill Book Company, 1973.
11. A Grasselli, et al - "Automatic Interpretation and Classification of Images", Academic Press, 1969.

12. J.L. Hilburn and D.E. Johnson - "Manual of Active Filter Design", McGraw-Hill Book Company, 1973.
13. Honeywell Inc. - "Vehicle Detection - Phase III Passive Bus Detector/Intersection Priority System Development", Vol. I, II & III, FHWA-RD-76-66 to 69 inclusively, Federal Highway Administration, December, 1975.
14. D.E. Johnson and J.L. Hilburn - "Rapid Practical Designs of Active Filters", John Wiley & Sons, 1975.
15. C.J. MacGowan - "Bus Priority and Bus Preemption in the Urban Traffic Control System", Compendium of Technical Papers, ITE 45th Annual Meeting, Aug. 1975.
16. W.S. Meisel - "Computer-Oriented Approaches to Pattern Recognition", Academic Press, 1972.
17. W. Mendenhall and R.L. Scheaffer - "Mathematical Statistics with Applications", Duxbury Press, 1973.
18. Motorola Semiconductor Products Inc. - "M6800 Microprocessor Application Manual", Motorola Inc., 1975.
19. N.J. Nilsson - "Learning Machine", McGraw-Hill Book Company, 1975.
20. T. Pavlidis - "Structural Pattern Recognition", Springer Series in Electrophysics, Vol. I, Springer-Verlag, 1977.
21. G.B. Rutkowski - "Handbook of Integrated-Circuit Operational Amplifiers", Prentice Hall Inc., 1975.
22. G. S. Sebestyen - "Decision-Making Processes in Pattern Recognition", MacMillan, 1962.
23. J. T. Tou and R.C. Gonzalez - "Pattern Recognition Principles", Addison-Wesley Publishing Company, 1974.

24. J.T. Tou and R.P. Heydorn - "Some Approaches to Optimum Feature Extraction", Computer & Information Sciences - II, Proceedings of the Second Symposium on Computer & Information Sciences, Academic Press, 1966.
25. Transport and Research Laboratory - "Transport and Road Research 1976", Department of Environment/Department of Transport, England, 1976.
26. P.H. Winston - "Artificial Intelligence", Addison-Wesley Publishing Company, 1977.

APPENDIX 1 MAXIMUM LIKELIHOOD ESTIMATION

Consider a Normal distribution probability density function described by,

$$p(\underline{Y}; \mu, \sigma) = f(\underline{Y}) = \frac{e^{-\frac{(\underline{Y} - \mu)^2}{2\sigma^2}}}{\sigma \sqrt{2\pi}},$$

where μ is the mean value and σ is the standard deviation of the data set.

Let $\theta_1 = \mu$ and $\theta_2 = \sigma^2$ be the components of a parameter vector, $\underline{\theta}$, and \underline{Y} be the union of all data points, i.e.,

$$\underline{Y} = \bigcup_{i=1}^n y_i, \text{ where } n \text{ is the number of components.}$$

Then

$$p(y_i/\underline{\theta}) = \frac{\exp(-(y_i - \theta_1)^2/2\theta_2)}{\sqrt{2\pi\theta_2}} \dots \dots \dots (1)$$

The likelihood of $\underline{\theta}$ is defined as

$$p(\underline{Y}/\underline{\theta}) = \prod_{i=1}^n p(y_i/\underline{\theta})$$

Therefore, for maximum likelihood

$$\nabla_{\underline{\theta}} \left[\prod_{i=1}^n p(y_i/\hat{\underline{\theta}}) \right] = \underline{0}$$

where $\hat{\underline{\theta}}$ is the maximum likelihood estimate of $\underline{\theta}$.

Now, since $\ln p$ is a monotonic function of p , the vector that maximizes $\ln p$ should also maximize p .

Hence, let

$$\nabla_{\underline{\theta}} \left[\ln \left(\prod_{i=1}^n p(y_i/\hat{\underline{\theta}}) \right) \right] = \underline{0}$$

i.e.,

$$\nabla_{\underline{\theta}} \left[\sum_{i=1}^n \ln p(y_i / \hat{\underline{\theta}}) \right] = \underline{0}$$

or

$$\sum_{i=1}^n \left[\nabla_{\underline{\theta}} \ln p(y_i / \hat{\underline{\theta}}) \right] = \underline{0} \dots\dots\dots(2)$$

From (1), we have

$$\ln p(y_i / \underline{\theta}) = -\frac{1}{2} \ln(2\theta_2) - \frac{1}{2\theta_2} (y_i - \theta_1)^2$$

Thus (2) becomes

$$\sum_{i=1}^n \left[\nabla_{\underline{\theta}} \ln p(y_i / \hat{\underline{\theta}}) \right] = \sum_{i=1}^n \left[\begin{array}{c} \frac{1}{\hat{\theta}_2} (y_i - \hat{\theta}_1) \\ -\frac{1}{2\hat{\theta}_2} + \frac{(y_i - \hat{\theta}_1)^2}{2\hat{\theta}_2^2} \end{array} \right] = \underline{0}$$

i.e.,

$$\sum_{i=1}^n \frac{1}{\hat{\theta}_2} (y_i - \hat{\theta}_1) = 0 \dots\dots\dots(3)$$

and

$$\sum_{i=1}^n \left[-\frac{1}{2\hat{\theta}_2} + \frac{(y_i - \hat{\theta}_1)^2}{2\hat{\theta}_2^2} \right] = 0 \dots\dots\dots(4)$$

where $\hat{\theta}_1$ and $\hat{\theta}_2$ are the maximum likelihood estimates for θ_1 and θ_2 respectively.

From (3), we have

$$n \hat{\theta}_1 = \sum_{i=1}^n y_i$$

i.e.,

$$\hat{\theta}_1 = \frac{1}{n} \sum_{i=1}^n y_i \dots\dots\dots(5)$$

and from (4)

$$n \hat{\theta}_2 = \sum_{i=1}^n (y_i - \hat{\theta}_1)^2$$

i.e.,

$$\hat{\theta}_2 = \frac{1}{n} \sum_{i=1}^n (y_i - \hat{\theta}_1)^2 \dots\dots\dots(6)$$

Substituting $\hat{\mu}$ and $\hat{\sigma}^2$ into $\hat{\theta}_1$ and $\hat{\theta}_2$ respectively, (5) and (6) become,

$$\hat{\mu} = \frac{1}{n} \sum_{i=1}^n y_i$$

and

$$\hat{\sigma}^2 = \frac{1}{n} \sum_{i=1}^n (y_i - \hat{\mu})^2.$$

Expand these results into the multivariate case, we have

$$\hat{\underline{\mu}} = \frac{1}{n} \sum_{i=1}^n \underline{y}_i$$

and

$$\hat{\underline{\Sigma}} = \frac{1}{n} \sum_{i=1}^n (\underline{y}_i - \hat{\underline{\mu}})(\underline{y}_i - \hat{\underline{\mu}})^T$$

where $\hat{\underline{\Sigma}}$ is the estimated covariant matrix and superscript T indicates

matrix transpose.

This appendix includes all stored vehicle signatures and their corresponding features extracted by the program FETD described in Chapter 4.

Note that values of data and parameters shown are in hexadecimal numbers, and that the values chosen for the parameters are as follows:

Input threshold	$\theta_{in} = 09DB$
Output threshold	$\theta_{out} = 09C7$
Sample timing	$T_s = 70$
Tolerance	$\epsilon = 28$

unless otherwise stated.

[N.B.] Time scale is reversed (i.e., from right to left) on all charted signatures

T5S1	#Mx	#Mn	Mx1	Tx1	Mn1	Tn1	Mx2	Tx2	Mn2	Mx3	Tx3	T	
1	3	2	0A1C	1444	09F0	15A6	0A4F	1746	0A0B	1978	CA42	1A4A	1D62
2	3	2	0A50	03E0	0927	0486	0A3B	0498	0A0A	0556	0A42	0600	06DC
3	-	-	----	----	----	----	----	----	----	----	----	----	----
4	4	3	0A2F	0174	0907	0242	0AD4	040A	0A16	059A	0A53	0642	073A
5	3	2	0A7F	01A8	0957	0246	0AC2	048A	0A66	062A	0AB1	06D0	07DE
6	4	3	0A0E	0166	09E3	02A8	0A2F	0402	0904	06EA	0A17	06EC	0784
7	3	2	0A4B	018A	0923	0210	0A8C	040A	0A34	05AA	0A76	063E	072A
8	3	2	0A1B	018E	09EE	02CE	0A4D	045C	0A03	067E	0A38	0722	0836

T5S2

1	2	1	0AEA	0290	09B8	0332	0AC7	0334	----	----	----	----	0432
2	4	3	0A13	01EA	09DB	0368	0A17	0444	09E1	08EE	0A1D	09E0	0B62
3	4	3	0A32	0252	0909	02F2	0A1C	02F8	09E1	065E	0A0A	06D2	0764
4	3	2	0A27	01D6	09FD	0328	0A63	053C	0A12	07D2	0A4F	08A2	0A22
5	1	0	0B0E	0270	----	----	----	----	----	----	----	----	0412
6	-	-	----	----	----	----	----	----	----	----	----	----	----
7	-	-	----	----	----	----	----	----	----	----	----	----	----
8	2	1	0A38	0218	090F	0322	0A26	032E	----	----	----	----	041E
9	3	2	0A46	01B0	091E	022A	0A90	0450	0A3B	062C	0A88	06E2	07F0
10	1	0	0A01	046A	----	----	----	----	----	----	----	----	089C
11	3	2	0A35	023C	090B	0278	0A1C	027A	09DA	0436	0A17	0684	072A
12	3	2	0A27	0204	09D6	03DE	0AFF	04E4	09EC	04EC	0A2C	0580	06A6
13	3	2	0A52	0196	0928	021E	0AA1	0400	0A47	0592	0A94	062E	0724

Parameters:

 $\theta_{in} = 09DB$ (input threshold)

 $\theta_{out} = 09C7$ (output threshold)

 $T_s = 70$ (sample timing)

 $\epsilon = 28$ (tolerance)

[N.B.] Data and parameter values are in hexadecimal

T5S1-1 (ETS Bus)

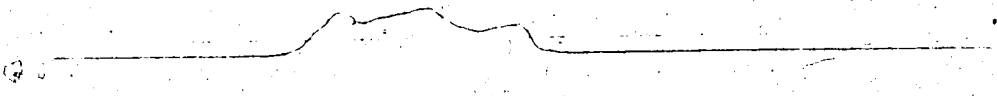

T5S1-2 (ETS Bus)

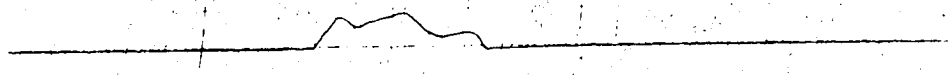

T5S1-4 (ETS Bus)

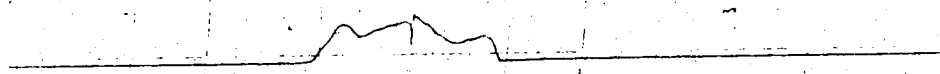

T5S1-5 (ETS Bus)

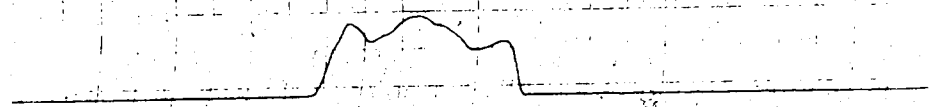

T5S1-6 (ETS Bus)

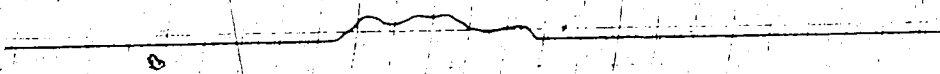

T5S1-7 (ETS Bus)

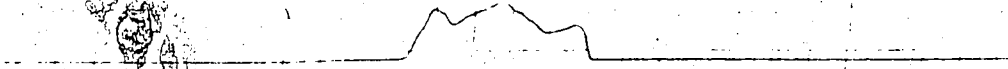

T5S1-8 (ETS Bus)



T5S2-1 (Car)

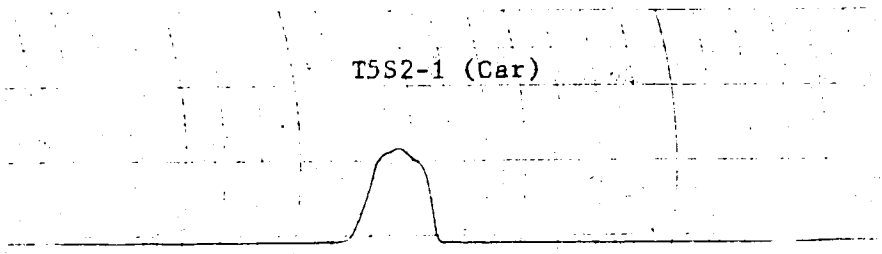

T5S2-2 (Semi-trailer)

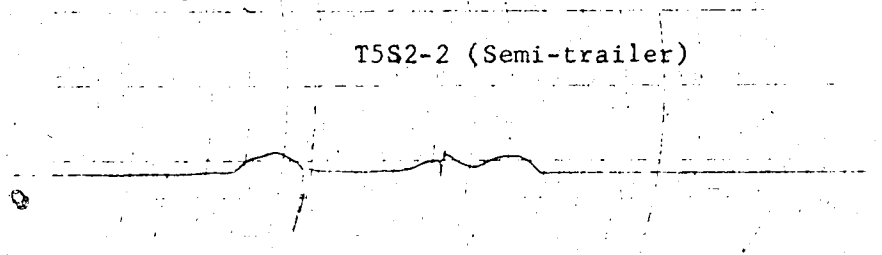

T5S2-3 (Semi-trailer)

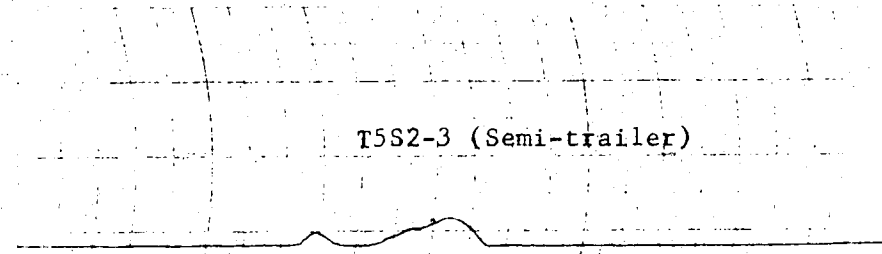

T5S2-4 (ETS Bus)

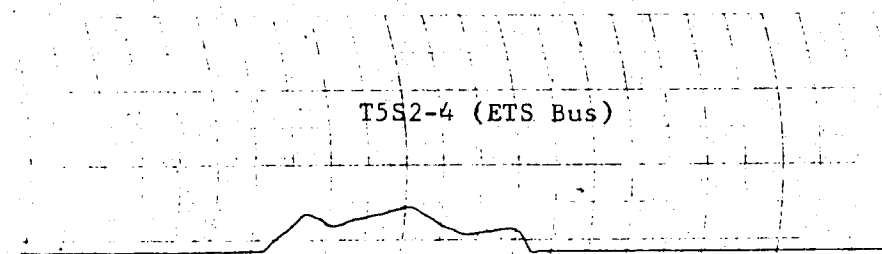

T5S2-5 (Taxi)

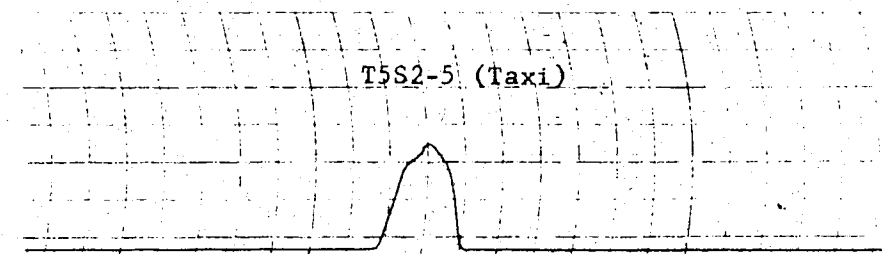

T5S2-6 (Semi-trailer)

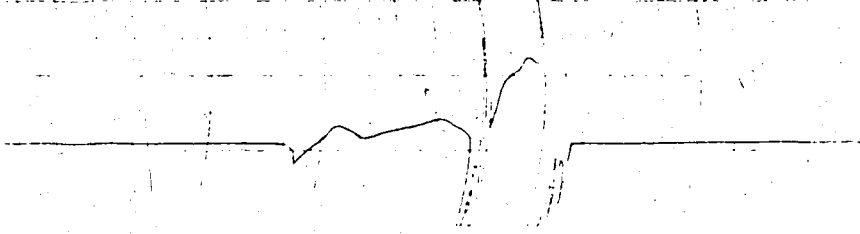

T5S2-7 (Semi-trailer)

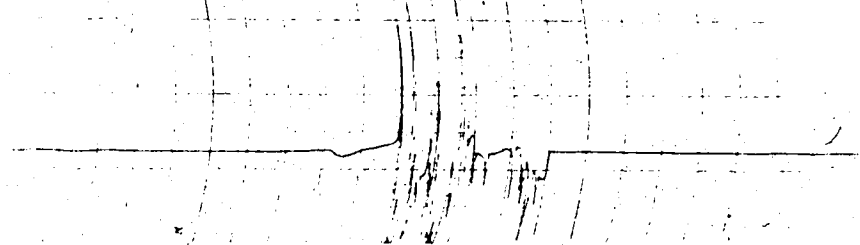

T5S2-8 (1/2 Ton Truck)

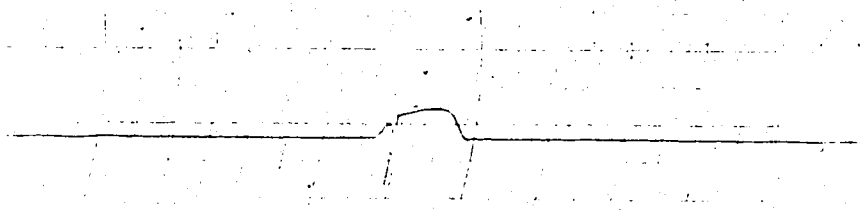

T5S2-9 (ETS Bus)

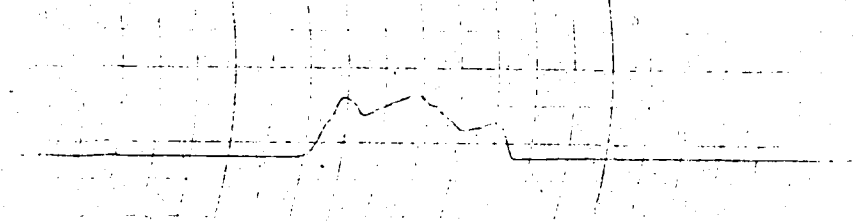

T5S2-10 (ETS Bus)

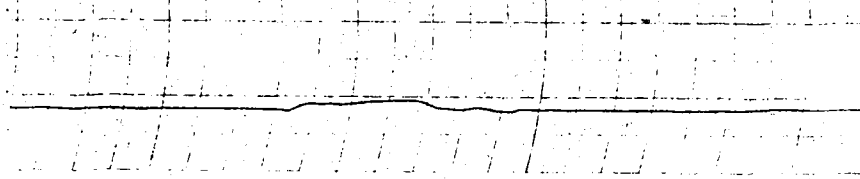

T5S2-11 (Gas Tanker in Tandem)

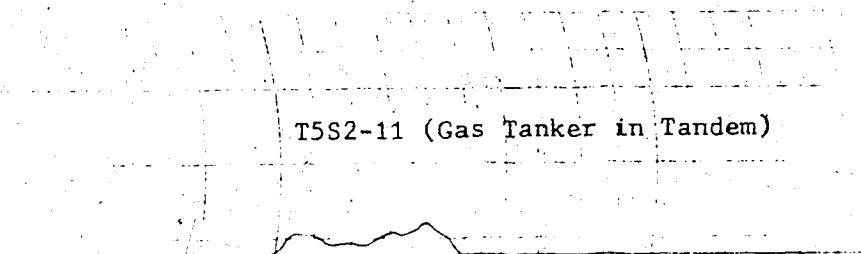

T5S2-12 (Semi-trailer)

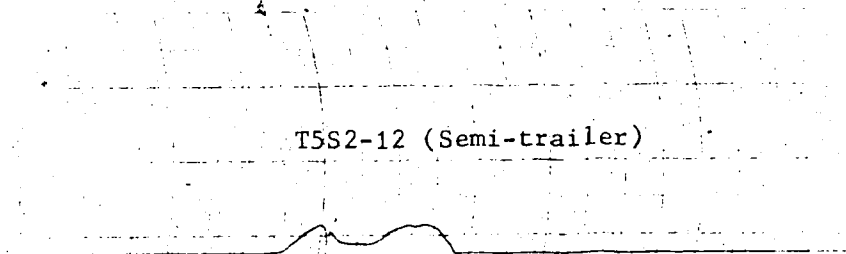

T5S2-13 (ETS Bus)

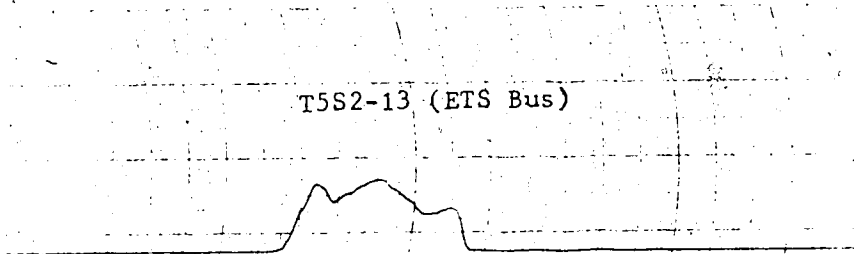

T6S1-1 (ETS Bus)

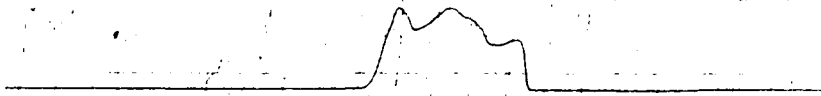

T6S1-2 (Dump Truck)

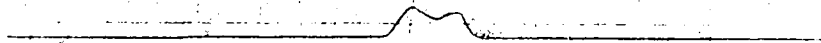

T6S1-3 (Semi-trailer)



T6S1-4 (Semi-trailer)

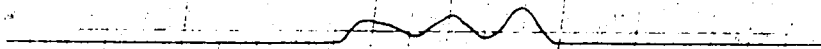

T6S1-5 (Semi-trailer)



T6S1-6 (Semi-trailer)

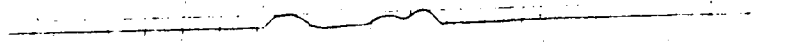

T6S1-7 (ETS Bus)



T6S1-8 (Car)

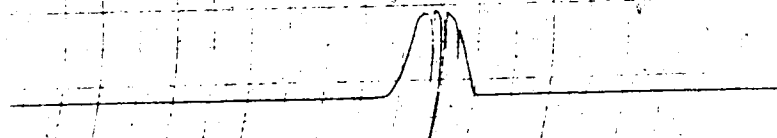

T6S1-9 (ETS Bus)

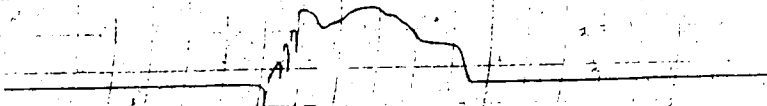

T6S1-10 (ETS Bus)

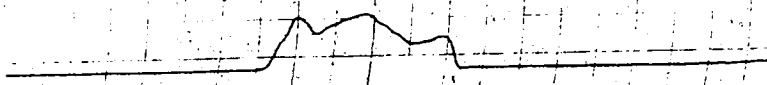

T6S1-11 (ETS Bus)

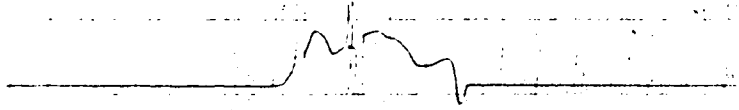

T6S1-12 (ETS Bus)

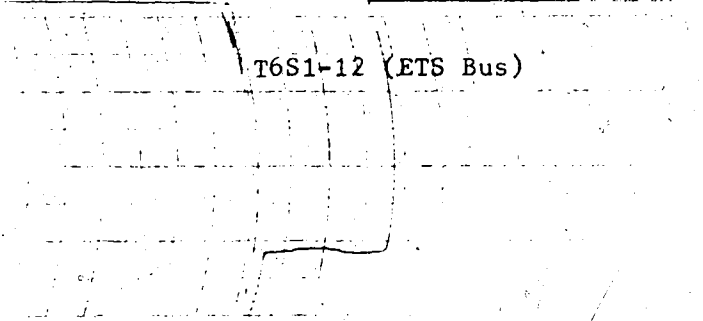

T6S1-13 (ETS Bus)

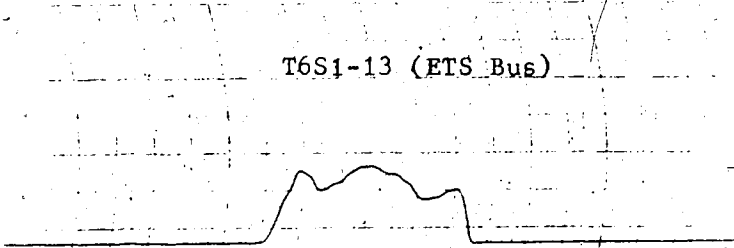

T6S1-14 (Semi-trailer)

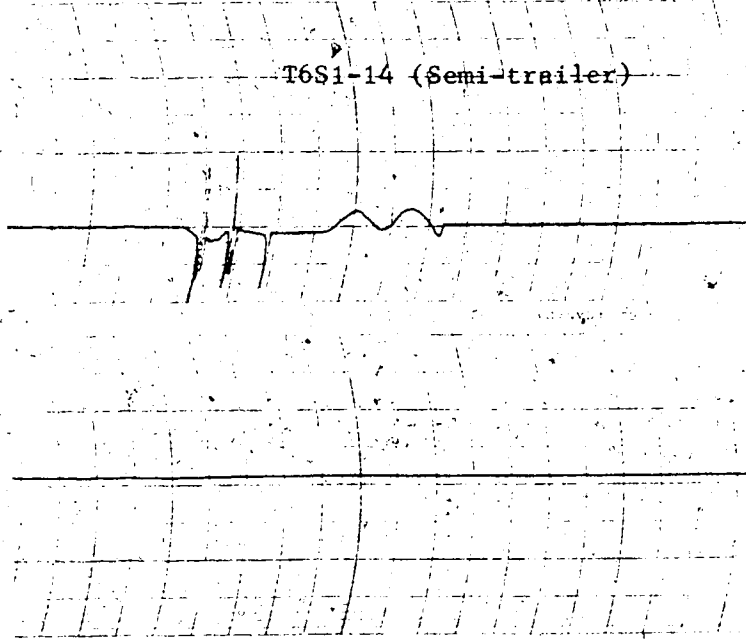

T6S2-1 (ETS Bus)

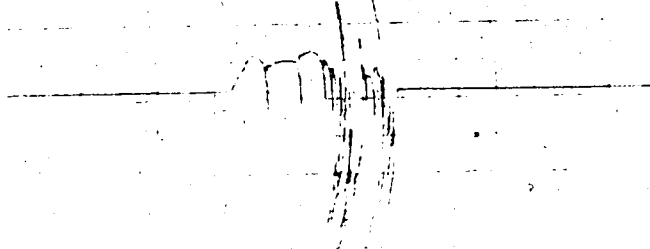

T6S2-2 (Fire Truck)

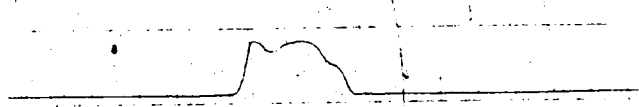

T6S2-3 (Moving Van)

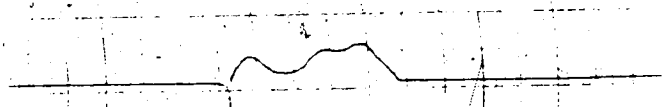

T6S2-4 (ETS Bus)

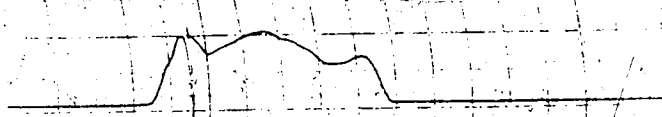

T6S2-5 (Semi-trailer)

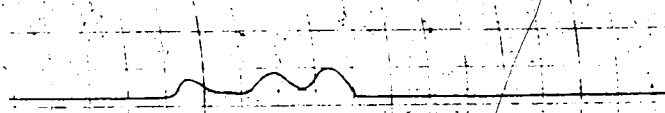

T6S2-6 (Semi-trailer)

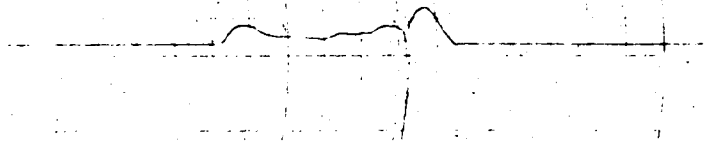

T6S2-7 (ETS Bus)

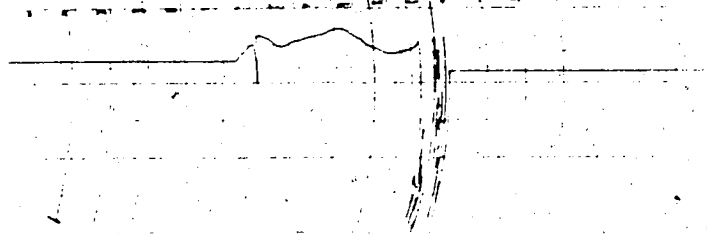

T6S2-8 (Semi-trailer)

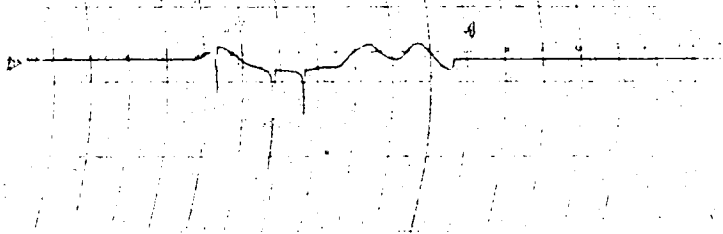

T6S2-9 (ETS Bus)

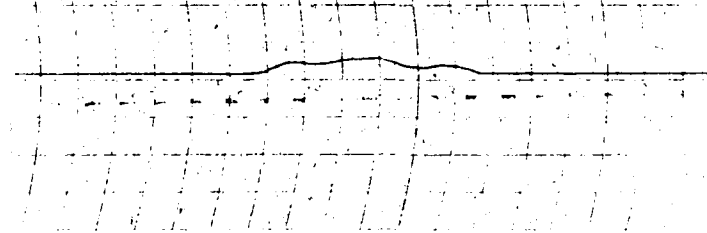

T6S2-10 (Cement Truck)

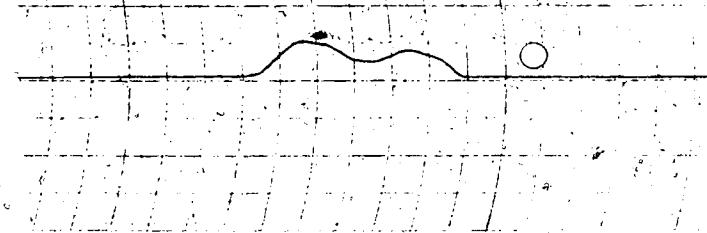

T6S2-11 (ETS Bus)

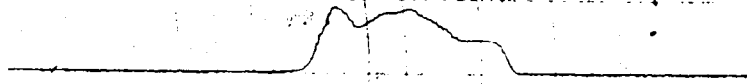

T6S2-12 (Semi-trailer)



T6S2-13 (1/2 Ton Truck w/ Trailer)



T6S2-14 (Car)

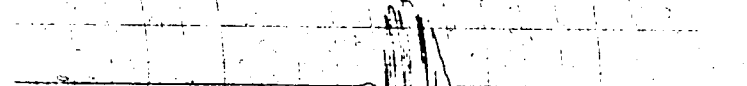

T7S1	#Mx	#Mn	Mx1	Tx1	Mn1	Tn1	Mx2	Tx2	Mn2	Tn2	Mx3	Tx3	T
1	3	2	0A38	023C	0910	02D6	0A29	03D2	09DA	060C	0A1C	0768	082E
2	1	0	0939	0C6A	----	----	----	----	----	----	----	----	0FA8
3	4	3	0A43	020C	0919	02E2	0A37	0358	0913	080E	0A26	0810	08B6
4	3	2	0A4E	010A	0A26	01CA	0A9D	03CE	0A3D	05DE	0A81	06B2	07FA
5	3	2	0A2C	0338	0902	038C	0A16	0392	09D1	04EE	0AFA	057A	0676
6	4	3	0A77	01BC	094F	0226	0A9C	03D0	0A5B	0644	0AAA	0710	083E
7	3	2	0A59	0430	0930	04C0	0A44	04CC	0A0F	05EA	0A51	06AF	07B4
8	2	1	0A50	0230	0928	0334	0A3B	034E	----	----	----	----	05D4
9	1	0	0A07	0418	----	----	----	----	----	----	----	----	07C0
10	4	3	0A2A	01A2	0902	0270	0A5F	044C	0A0E	0612	0A4A	06D0	07E2
11	1	0	0A18	049A	----	----	----	----	----	----	----	----	086C
12	4	3	0A29	01FC	0901	0336	0A15	0338	0901	063C	0A17	0644	0720

T7S2

1	4	3	0A4A	02FC	0920	03A8	0B02	061A	0A24	09CE	0A51	0B8C	0C48
2	3	2	0A79	01B2	0950	020E	0AB6	0434	0A5F	05C4	0AAC	066E	0770
3	3	2	0A89	042E	095F	051E	0A6F	052C	0A3B	05D8	0A92	0674	0790
4	1	0	0A27	03E8	----	----	----	----	----	----	----	----	0742
5	3	2	0A7B	01A0	0953	01FC	0ABE	0436	0A61	057E	0AAF	0624	0722
6	3	2	0A47	01AC	091E	0234	0A8D	047C	0A31	0650	0A7D	0720	082E
7	3	2	0A77	01B8	094F	01F4	0AB1	0464	0A5C	0602	0AB0	06AA	07B6
8	3	2	0A9B	03EB	0970	049C	0A7C	049E	0A4E	052E	0AA9	05CA	06D0
9	1	0	0A04	03EC	----	----	----	----	----	----	----	----	0758
10	5	4	0A5D	01FE	0931	0232	0A3F	0234	09EE	07C8	0A2C	0870	091E
11	3	2	0A5D	01FE	0931	0232	0A3F	0234	09DC	02EA	0A18	0384	06A0
12	5	4	0A37	0418	090F	04B0	0A21	04B2	0904	0B10	0A18	0B12	0C3A
13	4	3	0A8F	019C	0967	01DC	0A71	01E0	0A4E	04FE	0AB8	064A	0728

T7S1-1 (Semi-trailer)

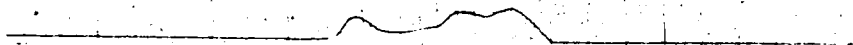

T7S1-2 (ETS Bus)

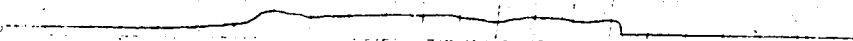

T7S1-3 (Semi-trailer)



T7S1-4 (ETS Bus)

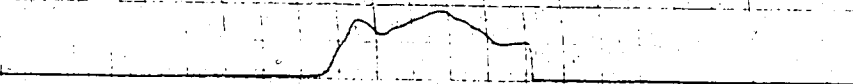

T7S1-5 (Semi-trailer)

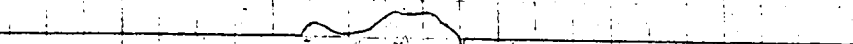

T7S1-6 (ETS Bus)

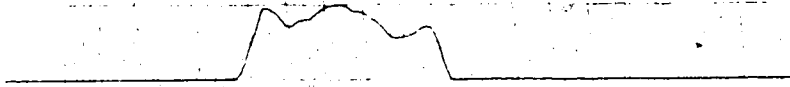

T7S1-7 (ETS Bus)



T7S1-8 (School Bus)



T7S1-9 (ETS Bus)

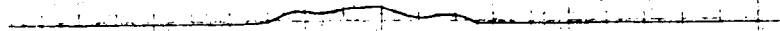

T7S1-10 (ETS Bus)

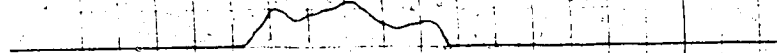

T7S1-11 (ETS Bus)



T7S1-12 (Semi-trailer)

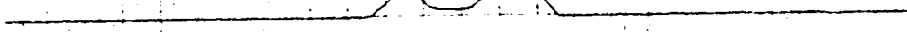

T7S2-1 (Auto Carrier)

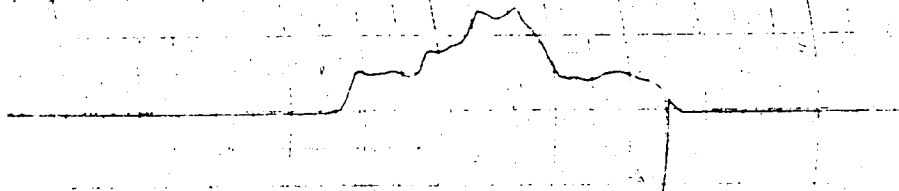

T7S2-2 (ETS Bus)

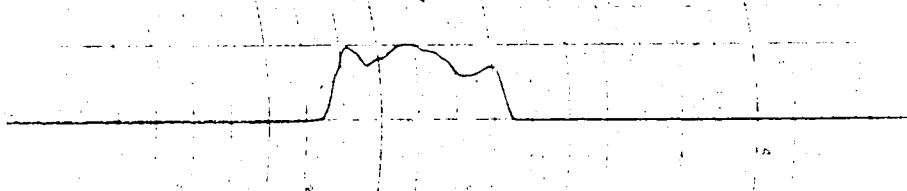

T7S2-3 (ETS Bus)

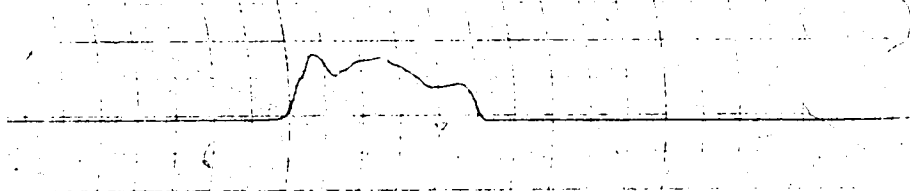

T7S2-4 (ETS Bus)

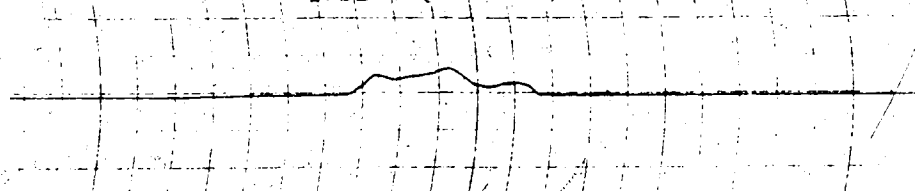

T7S2-5 (ETS Bus)

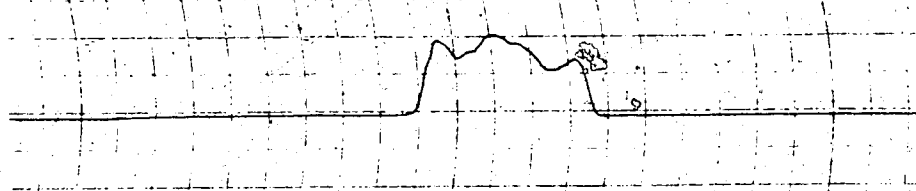

T7S2-6 (ETS Bus)

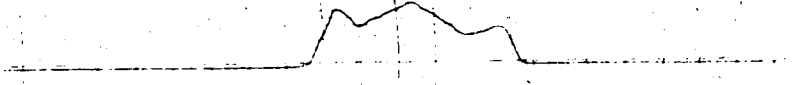

T7S2-7 (ETS Bus)

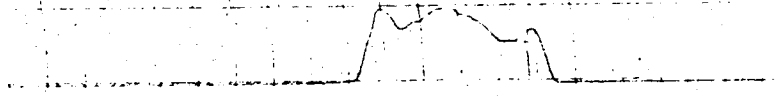

T7S2-8 (ETS Bus)

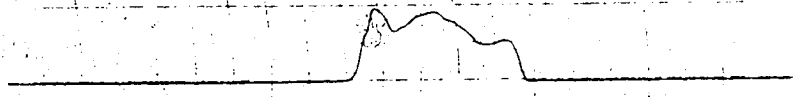

T7S2-9 (ETS Bus)

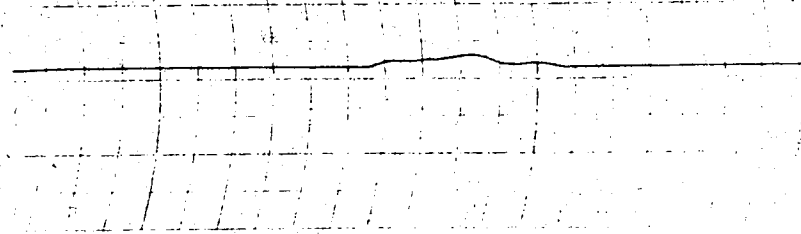

T7S2-10 (Semi-trailer)

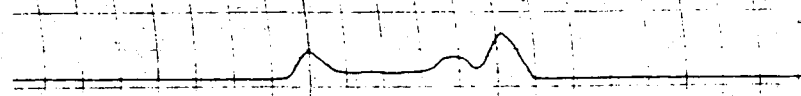

T7S2-11 (Semi-trailer)

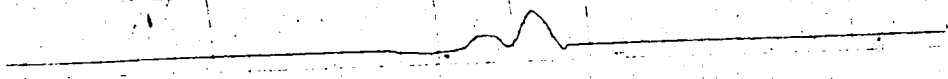

T7S2-12 (Semi-trailer)



T7S2-13 (ETS Bus)

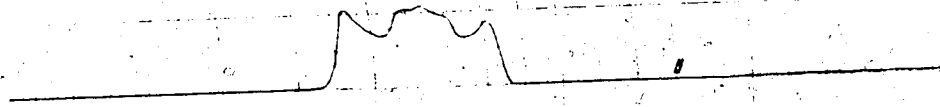

T8S1	#Mx	#Mn	Mx1	Tx1	Mn1	Tn1	Mx2	Tx2	Mn2	Tn2	Mx3	Tx3	T
1	5	4	0A4D	0238	0923	026E	0A32	0272	09D7	0642	0A27	077C	088A
2	3	2	0A23	01FE	09F7	033A	0A5A	0532	0A0F	07B6	0A4D	08C6	0A5A
3	4	3	0A3B	0258	0912	02BE	0A28	02C2	0906	081A	0A18	081C	08B0
4	5	4	0A4B	01E2	0922	022E	0A3A	0232	09E7	076E	0A27	081E	0944
5	3	2	0A26	01E2	09D3	06B6	0AFD	06C8	09ED	06CE	0A1C	0766	0866
6	-	-	----	----	----	----	----	----	----	----	----	----	----
7	3	2	0A28	01DC	09FF	0330	0A67	055A	0A1B	07E0	0A5D	08C8	0A34
8	-	-	----	----	----	----	----	----	----	----	----	----	----
9	1	0	0A17	03D4	----	----	----	----	----	----	----	----	070A
10	4	3	0A38	0216	090F	02AE	0A37	038E	09EA	07CE	0A1D	0886	0974
11	3	2	0A6C	01B2	0944	0200	0AA6	0430	0A4E	05D4	0AA1	067C	078C
12	1	0	0A18	03C8	----	----	----	----	----	----	----	----	06FE

*T8S2

1	2	1	0ABC	0454	0A6D	0630	0AB8	06A0	----	----	----	----	07F4
2	-	-	----	----	----	----	----	----	----	----	----	----	----
3	-	-	----	----	----	----	----	----	----	----	----	----	----
4	3	2	0A34	0186	0A16	0260	0A7A	03B6	0A33	0542	0A71	05D0	06D6
5	3	2	0A27	0186	0A0C	0276	0A6A	03E4	0A29	0570	0A61	0600	0720
6	1	0	0A10	046E	----	----	----	----	----	----	----	----	0888
7	3	2	0A77	01A2	0A51	0262	0AB7	03F0	0A63	0560	0AA9	05EE	0726
8	1	0	0A11	03CE	----	----	----	----	----	----	----	----	076C
9	3	2	0A3A	019A	091F	0210	0A73	047E	0A2E	053C	0A79	0698	079A
10	-	-	----	----	----	----	----	----	----	----	----	----	----
11	-	-	----	----	----	----	----	----	----	----	----	----	----
12	-	-	----	----	----	----	----	----	----	----	----	----	----
13	4	3	0A4F	01A4	0A31	0278	0A93	0406	0A46	05C4	0A8F	0684	07BE

* Tolerance value is changed to $\epsilon = 1B$

T8S1-1 (Semi-trailer)

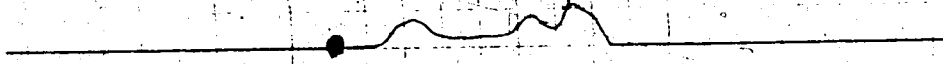

T8S1-2 (ETS Bus)

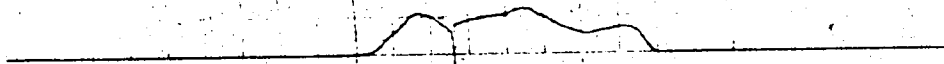

T8S1-3 (Semi-trailer)

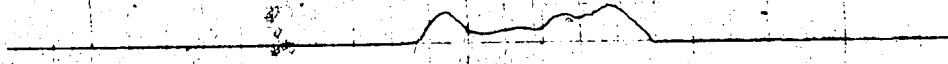

T8S1-4 (Semi-trailer)

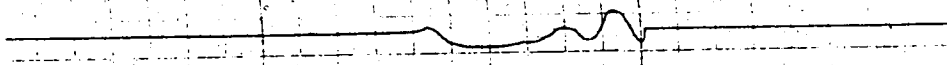

T8S1-5 (Semi-trailer)

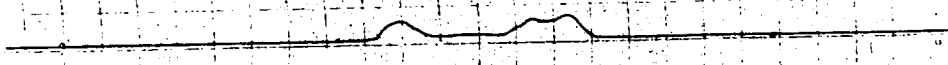

T8S1-6 (ETS Bus)

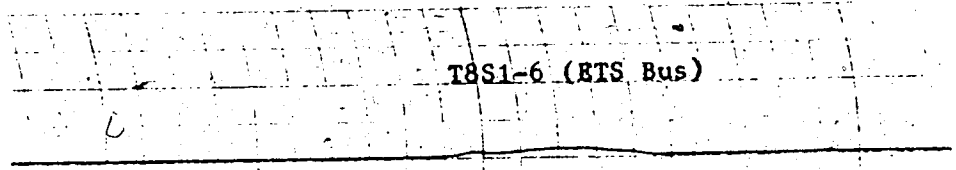

T8S1-7 (ETS Bus)

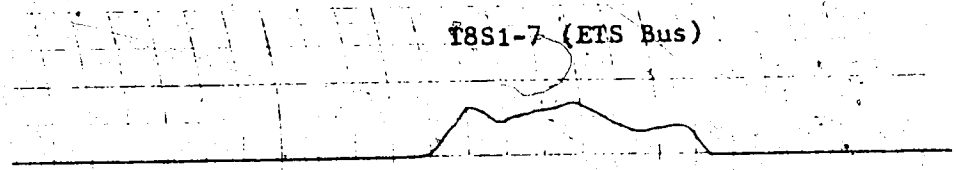

T8S1-8 (Garbage Truck)

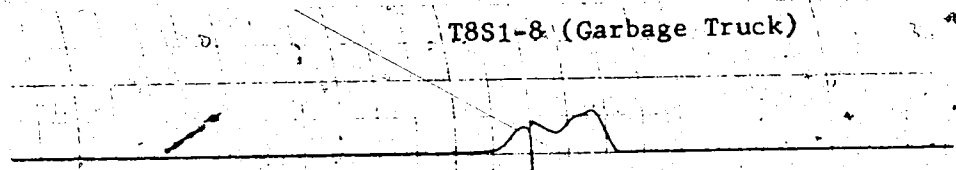

T8S1-9 (ETS Bus)

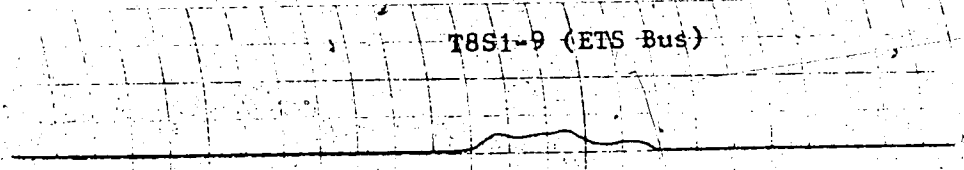

T8S1-10 (Semi-trailer)

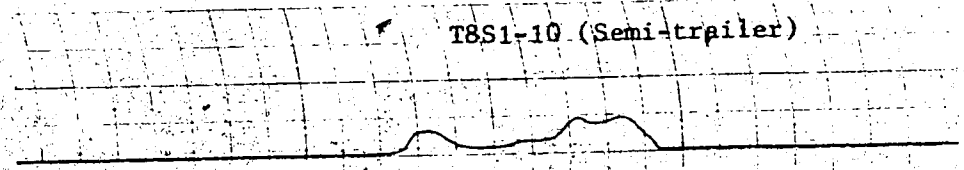

T8S1-11 (ETS Bus)

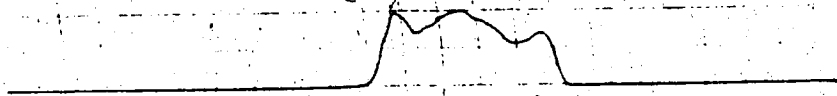

T8S1-12 (ETS Bus)

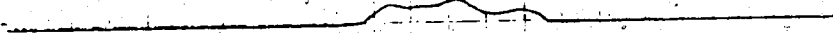

T8S2-1 (ETS Bus)

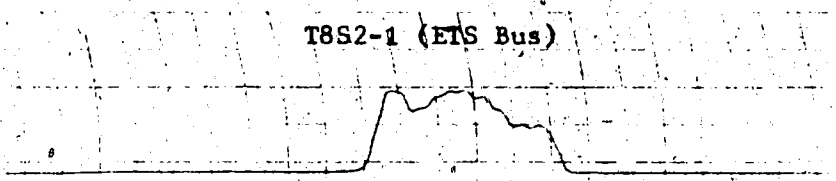

T8S2-2 (Semi-trailer)

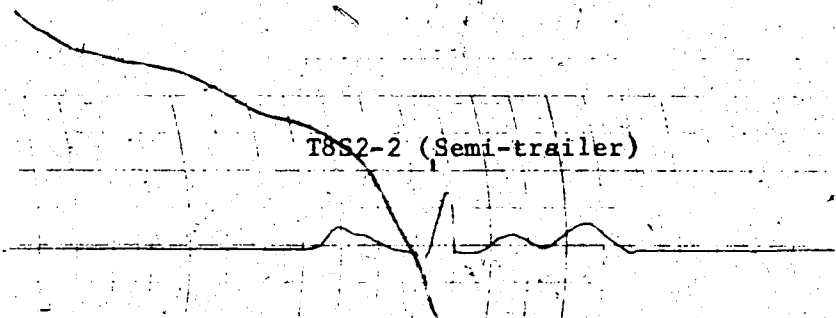

T8S2-3 (ETS Bus)

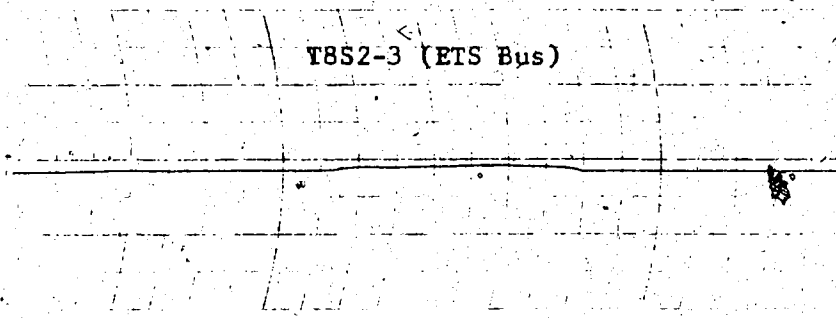

T8S2-4 (ETS Bus)

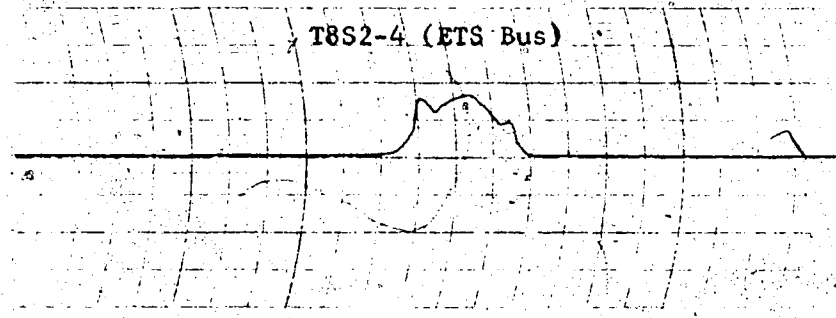

T8S2-5 (ETS Bus)

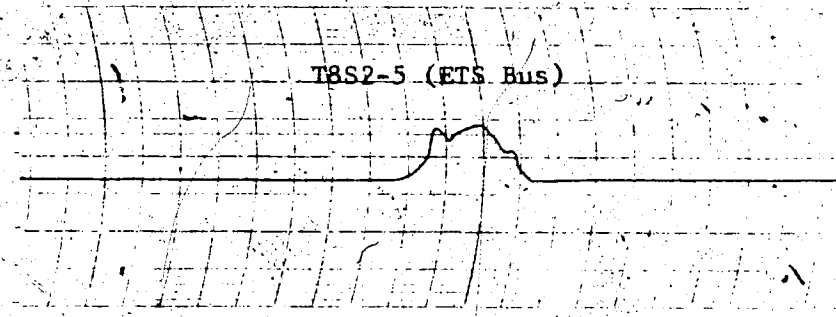

T8S2-6 (ETS Bus)

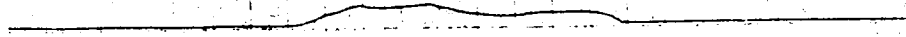

T8S2-7 (ETS Bus)

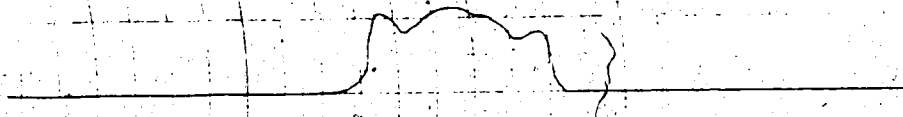

T8S2-8 (ETS Bus)



T8S2-9 (ETS Bus)



T8S2-10 (ETS Bus)



T8S2-11 (ETS Bus)

T8S2-12 (ETS Bus)

T8S2-13 (ETS Bus)

*T9S1	#Mx	#Mn	Mx1	Tx1	Mn1	Tn1	Mx2	Tx2	Mn2	Tn2	Mx3	Tx3	T
1	2	1	0A8B	07DE	0970	0832	0A ₁₀	0834	----	----	----	----	0A10
2	3	2	0A3E	0208	0922	0242	0A _{1F}	0244	09E6	065C	0A18	07CE	08A6
3	3	2	0A70	019E	0A4C	0276	0A _{B5}	0402	0A69	0574	0AAD	0618	0722
4	5	4	0A47	0234	092C	0288	0A _{2B}	028A	0A12	0820	0A3D	08AC	0950
5	3	2	0A7E	019E	0A4C	0276	0A _{B5}	0432	0A67	0576	0A9F	0618	0734
6	3	2	0A23	01BC	09D9	05DE	0A _{F5}	0586	09F2	0694	0A17	0738	07F2
7	3	2	0A40	018C	0925	0210	0A _{B9}	040A	0A3E	05AE	0A81	0607	076E
8	3	2	0A83	01A8	0A50	029A	0A _{B9}	0406	0A65	0594	0AC3	06D4	0810
9	3	2	0A68	018A	0A46	0266	0A _{AC}	03EA	0A5B	0546	0A9D	05D4	06F2
10	3	2	0A6C	01D0	0A49	02EE	0A _{B7}	0384	0A6B	07A2	0AB3	0894	0A68
11	3	2	0A78	01B6	0A4F	028C	0A _{B5}	047E	0A6E	060C	0AAC	06AC	07F0
12	1	0	0A07	0404	----	----	----	----	----	----	----	----	07D4

*T9S2

1	3	2	0A73	0186	0958	01C6	0A _{D1}	0394	0A67	0514	0AAB	059E	06AC
2	1	0	0B00	0430	----	----	----	----	----	----	----	----	0702
3	1	0	0A26	0416	----	----	----	----	----	----	----	----	07D6
4	3	2	0A26	0182	0A0A	0298	0A ₆₅	0404	0A24	05BE	0A51	066A	0788
5	2	1	0A1E	039E	0903	0472	0A ₁₁	0386	----	----	----	----	068C
6	1	0	09E8	03B4	----	----	----	----	----	----	----	----	081E
7	3	2	0A51	0412	0936	04C0	0A _{3B}	04F2	0A15	05D6	0A3D	067A	07A0
8	3	2	0A73	0190	0A4A	024E	0A _{B1}	03F2	0A63	0568	0A9C	05F8	06F8
9	3	2	0A6B	01A4	0A45	0278	0A _{AD}	0420	0A62	05C0	0AAB	066A	0788
10	1	0	0A0A	03EC	----	----	----	----	----	----	----	----	0774
11	3	2	0A69	01C8	0A3E	02D6	0A _{A7}	04DE	0A5B	06F0	0A98	07C6	0932
12	3	2	0A67	018C	0A45	024A	0A _{B4}	0406	0A67	055C	0AB0	0604	070C

* Tolerance value $\epsilon = 1B$

T9S1-1 (Semi-trailer)

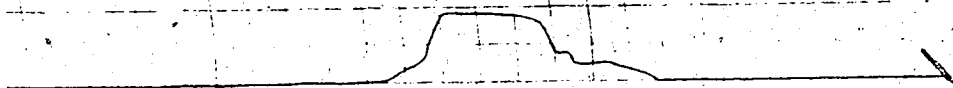

T9S1-2 (Semi-trailer)

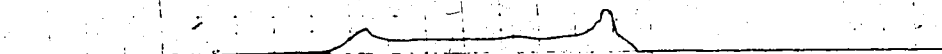

T9S1-3 (ETS Bus)

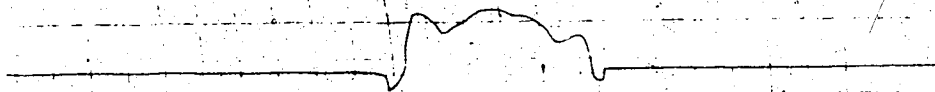

T9S1-4 (Semi. w/ Tractor)

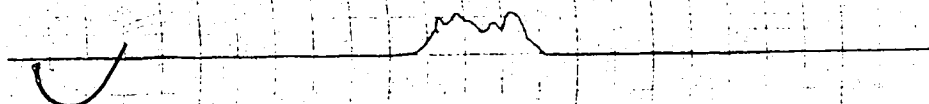

T9S1-5 (ETS Bus)

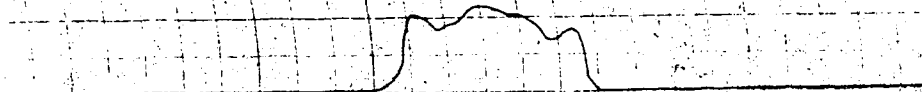

T9S1-6 (Semi-trailer)

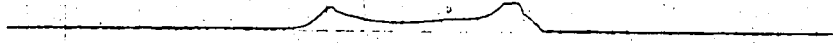

T9S1-7 (ETS Bus)

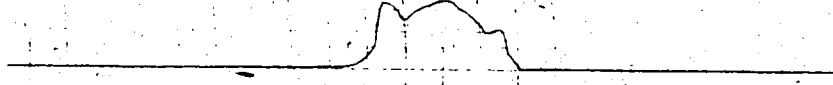

T9S1-8 (ETS Bus)

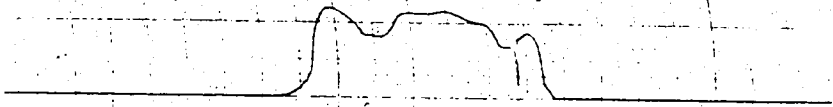

T9S1-9 (ETS Bus)

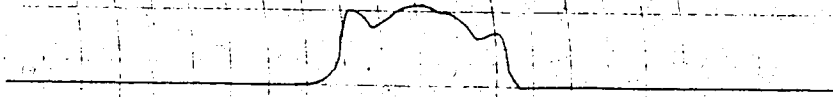

T9S1-10 (ETS Bus)

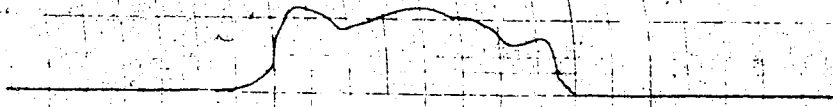

T9S1-11 (ETS Bus)



T9S1-12 (ETS Bus)

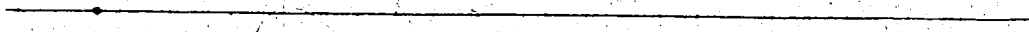

Handwritten scribbles or markings at the bottom of the page.

T9S2-1 (ETS Bus)

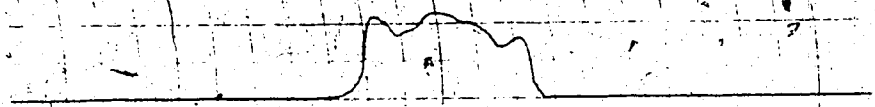

T9S2-2 (Greyhound Bus)

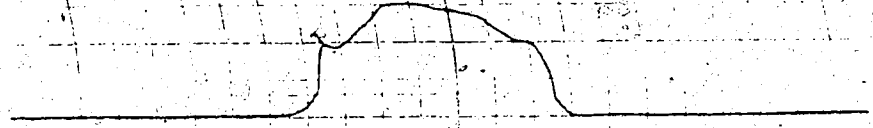

T9S2-3 (Semi-trailer)

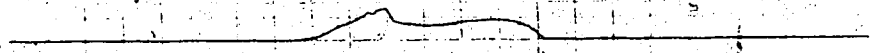

T9S2-4 (ETS Bus)

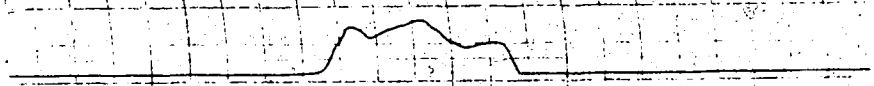

T9S2-5 (ETS Bus)

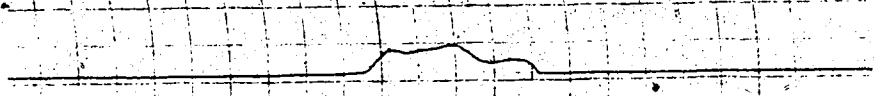

T9S2-11 (ETS Bus)

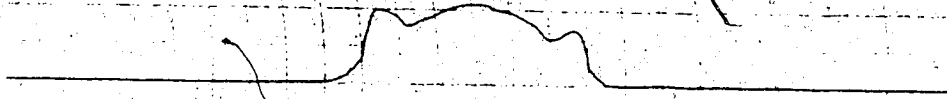

T9S2-12 (ETS Bus)

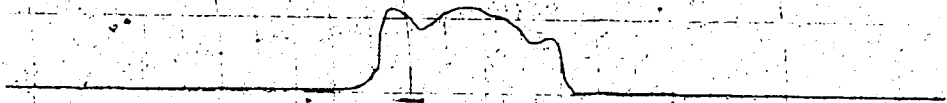

*T10S1	#Mx	#Mn	Mx1	Tx1	Mn1	Tn1	Mx2	Tx2	Mn2	Tn2	Mx3	Tx3	T
1	1	0	09FD	0398	----	----	----	----	----	----	----	----	0722
2	3	2	0A06	019E	09EA	02AA	0A0F	03EC	09F0	05A8	0A2B	074F	085A
3	3	2	0A13	01A0	09F8	02E0	0A4B	0484	0A10	06A8	0A3B	079A	08F0
4	4	3	0A4A	0222	0A01	032E	0A31	03EC	0A17	07F6	0A42	0868	091E
5	1	0	0A49	03D0	----	----	----	----	----	----	----	----	05D4
6	3	2	0A25	0452	090A	0542	0A1B	0736	0900	0788	09FF	078A	0858
7	1	0	0A0A	03EA	----	----	----	----	----	----	----	----	0760
8	4	3	0A2B	02B2	090F	0336	0A10	0348	090E	0652	0A0F	065C	074A
9	3	2	0A2D	0234	0912	0406	0A10	040A	09D4	0686	0A13	087A	09CE
10	1	0	09E8	0302	----	----	----	----	----	----	----	----	0684
11	3	2	0A68	0186	094D	01C8	0AB1	03A0	0A63	04FC	0AA7	0582	068A
12	2	1	0A20	043C	09FD	0600	0A1B	06A0	----	----	----	----	07D4

*T10S2	#Mx	#Mn	Mx1	Tx1	Mn1	Tn1	Mx2	Tx2	Mn2	Tn2	Mx3	Tx3	T
1	1	0	09EE	031C	----	----	----	----	----	----	----	----	063E
2	3	2	0A32	01A0	0917	02C0	0A7B	0482	0A32	068E	0A65	0766	08D2
3	4	3	0A1D	026E	0902	02F2	0A00	0306	09D6	0874	0A14	0B00	0C54
4	1	0	09F0	0432	----	----	----	----	----	----	----	----	08A2
5	1	0	09F1	0382	----	----	----	----	----	----	----	----	073E
6	7	6	0A46	0200	092A	0270	0A59	0466	0A49	08BE	0A93	0964	0A52
7	3	2	0A47	01EC	09E7	043E	0A3C	05E8	0920	0620	0A1F	0622	06EE
8	3	2	0A1C	01B8	09FF	02F8	0A57	04E6	0A16	070E	0A41	07E4	0956
9	1	0	0A07	046C	----	----	----	----	----	----	----	----	088E
10	1	0	09E5	02C8	----	----	----	----	----	----	----	----	068C
11	1	0	09F5	0780	----	----	----	----	----	----	----	----	0556
12	1	0	09E5	02CA	----	----	----	----	----	----	----	----	05EC
13	2	1	09FF	0334	09CD	05D8	0A00	084A	----	----	----	----	096A

* Tolerance value $\epsilon = 1B$

T10S1-1 (ETS Bus)

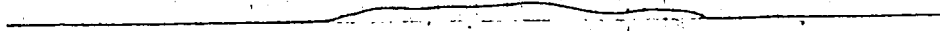

T10S1-2 (ETS Bus)



T10S1-3 (ETS Bus)

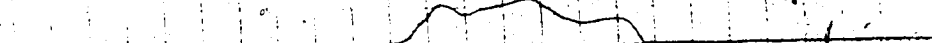

T10S1-4 (Gar w/ Rec. Trailer)

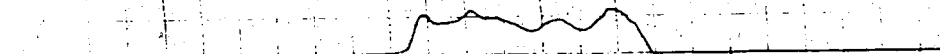

T10S1-5 (ETS Bus)



T10S1-6 (ETS Bus)

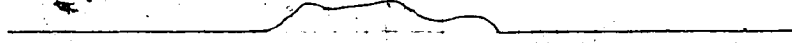

T10S1-7 (ETS Bus)



T10S1-8 (Semi-trailer)

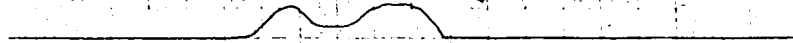

T10S1-9 (Semi-trailer)

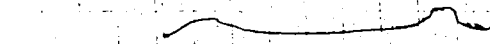

T10S1-10 (ETS Bus)

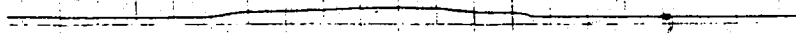

T10S1-11 (ETS Bus)

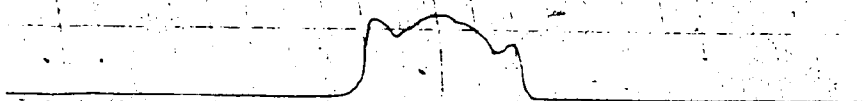

T10S1-12 (ETS Bus)

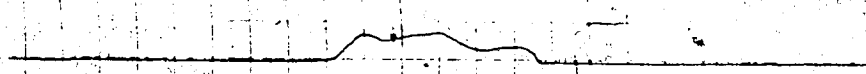

T10S2-1 (ETS Bus)

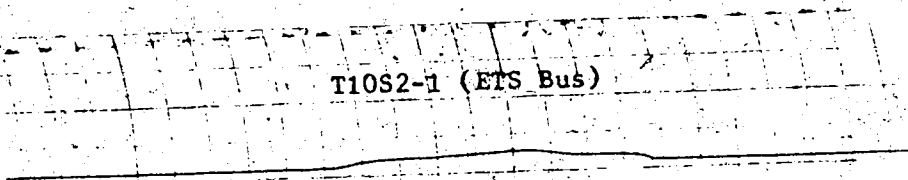

T10S2-2 (ETS Bus)

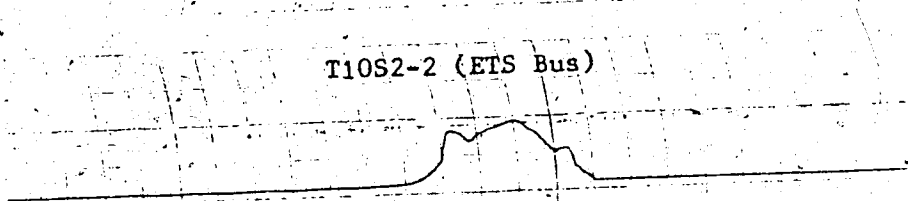

T10S2-3 (Semi-trailer)

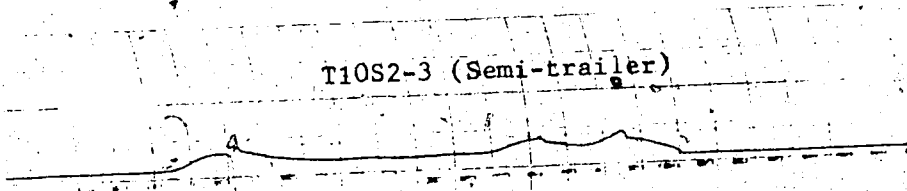

T10S2-4 (ETS Bus)

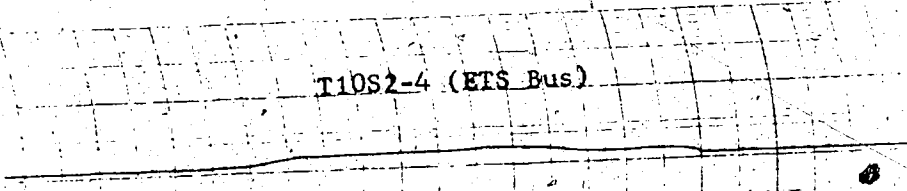

T10S2-5 (ETS Bus)

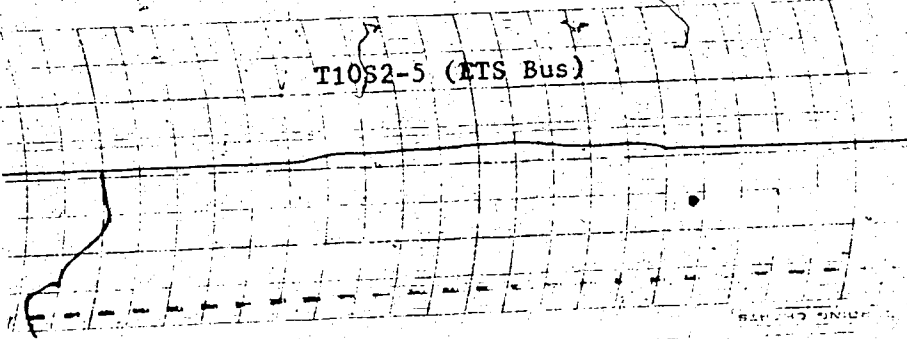

T10S2-6 (Auto Carrier)

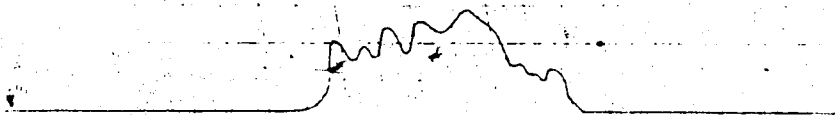

T10S2-7 (Semi-trailer)

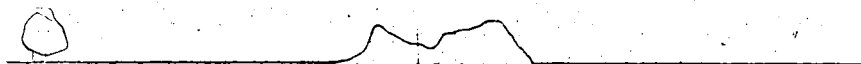

T10S2-8 (Ets Bus)



T10S2-9 (ETS Bus)

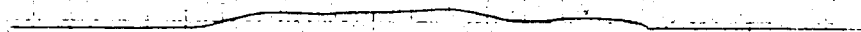

T10S2-10 (ETS Bus)



T10S2-11 (ETS Bus)

T10S2-12 (ETS Bus)

T10S2-13 (Semi-trailer)

*T11S1	#Mx	#Mn	Mx1	Tx1	Mn1	Tn1	Mx2	Tx2	Mn2	Tn2	Mx3	Tx3	T
1	-	-	----	----	----	----	----	----	----	----	----	----	----
2	2	1	0AA0	03E2	0A55	0556	0A9F	05E2	----	----	----	----	0700
3	3	2	0A58	0172	0A36	022E	0AA1	0354	0A56	0498	0A95	051A	05FC
4	1	0	0A19	0354	----	----	----	----	----	----	----	----	0630
5	3	2	0A7A	0250	0A44	0422	0AAD	0830	0A5D	0C20	0AA0	0DAA	1050
6	3	2	0A26	0198	0A09	0290	0A63	03F8	0A22	05A0	0A56	0646	076A
7	3	2	0A33	0192	0A18	0280	0A7D	03D8	0A33	0578	0A6E	0608	0712
8	-	-	----	----	----	----	----	----	----	----	----	----	----
9	1	0	09EE	0364	----	----	----	----	----	----	----	----	06F0
10	3	2	0A5C	017C	0A3B	0226	0AA3	0380	0A5A	048A	0A9B	0514	05EE
11	-	-	----	----	----	----	----	----	----	----	----	----	----
12	-	-	----	----	----	----	----	----	----	----	----	----	----
13	3	2	0A69	0184	0A49	022C	0AB8	0368	0A6E	04A2	0ABA	0518	0606

*T11S2

1	3	2	0A5C	018A	0A33	0246	0A9B	03D8	0A51	0562	0A93	05F0	070E
2	1	0	0A0F	03EA	----	----	----	----	----	----	----	----	075A
3	1	0	09E9	0302	----	----	----	----	----	----	----	----	0652
4	2	1	0A2A	044E	090E	05D4	0A29	06FE	----	----	----	----	0836
5	1	0	0A16	03B2	----	----	----	----	----	----	----	----	06C2
6	3	2	0A83	01C0	0A4F	02B2	0AB7	0486	0A66	0660	0AAB	0720	088C
7	3	2	0A3C	019A	0A1D	0274	0A86	0400	0A38	05A4	0A70	064E	0770
8	2	1	0A2D	0488	0912	057A	0A24	0768	----	----	----	----	08BE
9	1	0	0A1B	03D6	----	----	----	----	----	----	----	----	0760
10	3	2	0A36	01A0	0A13	02A6	0A73	0436	0A2E	05F8	0A64	06B6	07EE
11	2	1	0ABC	03D0	0A67	0526	0AB3	05CE	----	----	----	----	06D6
12	1	0	09FF	03B0	----	----	----	----	----	----	----	----	071E
13	3	2	0A0E	01A2	09F3	02E2	0A35	04A0	0A0A	06AA	0A33	0784	08DA

* Tolerance value $\epsilon = 1B$

T11S1-1 (ETS Bus)

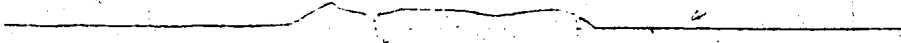

T11S1-2 (ETS Bus)

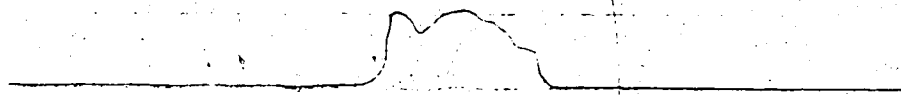

T11S1-3 (ETS Bus)

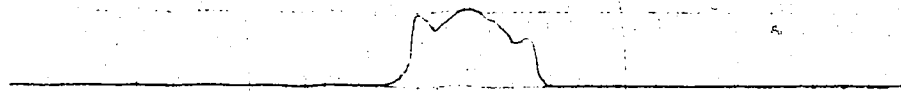

T11S1-4 (ETS Bus)

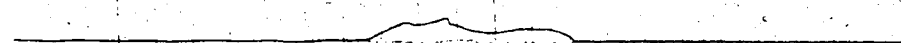

T11S1-5 (ETS Bus)

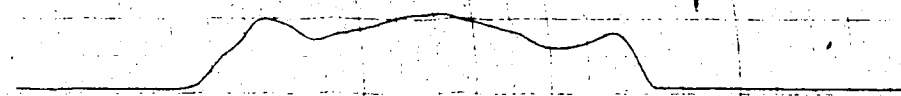

T11S1-6 (ETS Bus)

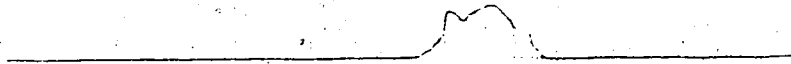

T11S1-7 (ETS Bus)



T11S1-8 (ETS Bus)

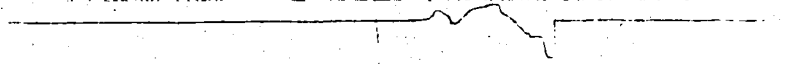

T11S1-9 (ETS Bus)

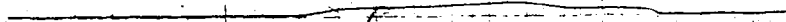

T11S1-10 (ETS Bus)

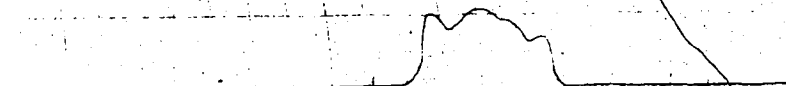

T11S1-11 (ETS Bus)



T11S1-12 (Semi-trailer)

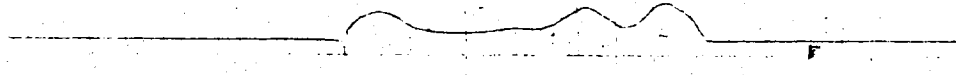

T11S1-13 (ETS Bus)

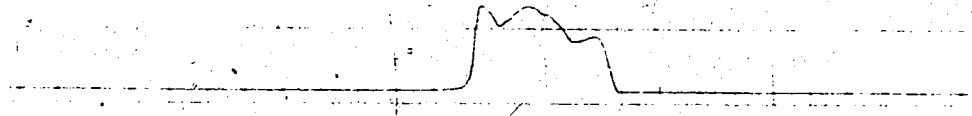

T11S2-1 (ETS Bus)



T11S2-2 (ETS Bus)

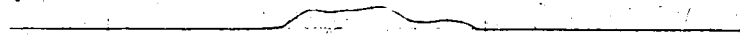

T11S2-3 (ETS Bus)

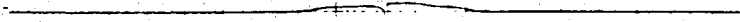

T11S2-4 (ETS Bus)



T11S2-5 (ETS Bus)

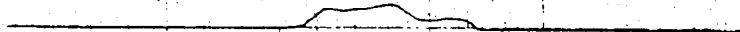

T11S2-6 (ETS Bus)

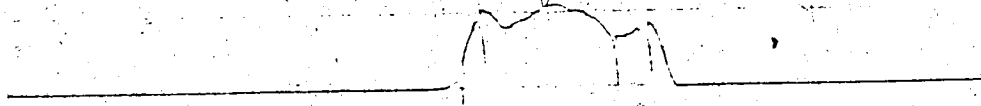

T11S2-7 (ETS Bus)

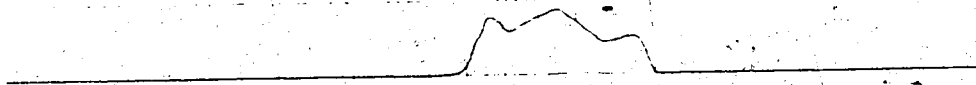

T11S2-8 (ETS Bus)

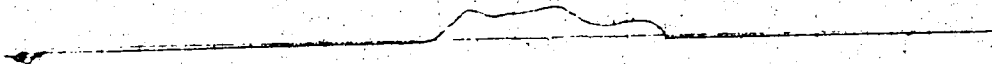

T11S2-9 (ETS Bus)

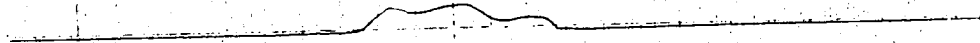

T11S2-10 (ETS Bus)



T11S2-11 (ETS Bus)

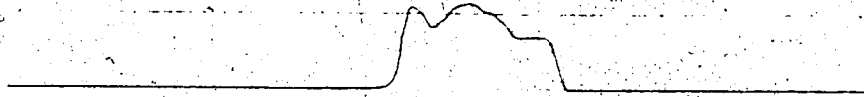

T11S2-12 (ETS Bus)

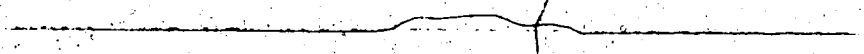

T11S2-13 (ETS Bus)

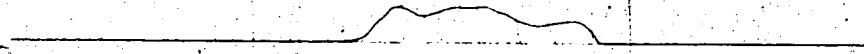

DATE: 10/10/80 TIME: 11:00

APPENDIX 3 DATA ACQUIRED VIA FEATURE

This appendix includes data acquired via the program FEATURE which extracts real-time features and stores them into designated memory locations.

No.	Veh. Type	#Mx	Mx1	Tx1	Mn1	Tn1	Mx2	Tx2	Mn2	Tn2	Mx3	Tx3	T
1	ETS Bus	3	0080	0198	FF65	01E7	006A	01FC	004E	0273	006F	02D1	02F0
2	Car	1	0100	009D	----	----	----	----	----	----	----	----	00E2
3	Car	1	0143	00A1	----	----	----	----	----	----	----	----	00BB
4	Stn. Wgn.	1	0111	00A8	----	----	----	----	----	----	----	----	00EB
5	½ Ton Tr.	1	00BA	0077	----	----	----	----	----	----	----	----	00C4
6	Van	1	00EB	007B	----	----	----	----	----	----	----	----	00CA
7	ETS Bus	1	004D	01A6	----	----	----	----	----	----	----	----	028D
8	½ Ton Tr.	1	00B2	008A	----	----	----	----	----	----	----	----	00B6
9	½ Ton Tr.	1	00CA	007A	----	----	----	----	----	----	----	----	00A0
10	Dairy Van	1	00DD	008D	----	----	----	----	----	----	----	----	00B8
11	Police C.	1	00F9	0085	----	----	----	----	----	----	----	----	00CA
12	Moving V.	2	0070	0069	FF54	00C8	005C	015A	----	----	----	----	01B8
13	Semi-T.	3	0089	0099	001B	01A7	0037	0234	0035	0238	0051	0265	028B
14	ETS Bus	2	006F	01EF	FF54	025C	0066	0377	----	----	----	----	03A4
15	Semi-T.	4	0064	0081	FF49	00FA	004F	0100	0026	0264	005A	0330	0381
16	ETS Bus	2	0060	0151	FF45	01D4	0055	0267	----	----	----	----	0293
17	ETS Bus	3	0095	0067	FF19	00A1	00DB	01E4	0090	02C6	00D2	0336	0352
18	Deli. Van	2	0077	0076	FF5C	00D3	006D	01BD	----	----	----	----	01F5
19	Moving V.	2	0089	006B	0025	01E8	0055	0269	----	----	----	----	028C
20	Semi-T.	5	0062	0090	FF47	00E9	0046	00EF	FF59	053F	005F	0546	058B
21	ETS Bus	2	0041	004B	0026	00DC	0061	0191	----	----	----	----	01E3
22	Semi-T.	4	004D	00D0	0010	0232	0049	0371	FF47	0B6E	004D	0B74	0BD0
23	Semi-T.	3	0082	00CC	FF67	0D00	0072	0D49	0031	0DE6	0080	0EB6	0EEC
24	ETS Bus	2	006D	018E	FF50	01DC	005A	02D4	----	----	----	----	02FE
25	Semi-T.	2	009C	008F	0026	01FE	0057	0267	----	----	----	----	028F
26	Dump Tr.	3	0087	009C	FF6A	00EA	006D	00EB	004C	012F	0080	01C9	01F3
27	Dump Tr.	3	0080	0081	FF65	00B8	0068	00B9	0042	0106	006A	01A2	01CB
28	Dump Tr.	2	004F	006A	002F	00D6	004D	014B	----	----	----	----	017F
29	Semi-T.	4	00A8	00B4	FF8D	00F9	0092	0101	008F	06AB	00C6	07C8	080D
30	ETS Bus	3	0073	0048	FF57	00B1	00AE	0184	0068	0260	0092	02B2	02CD
31	ETS Bus	2	006B	0176	FF50	01EC	0061	028A	----	----	----	----	02CA
32	Semi-T.	4	005F	0082	FF00	00B7	0045	00B8	0020	0219	004E	02CD	031D
33	ETS Bus	3	00AD	005B	FF92	0084	00DC	01C9	0097	02A5	00D5	0302	031A
34	ETS Bus	3	0073	0042	004B	00BA	00A4	01A3	0065	01F5	00A9	0286	029F

No.	Veh.Type	#Mx	Mx1	Tx1	Mn1	Tn1	Mx2	Tx2	Mn2	Tn2	Mx3	Tx3	T
35	Car	1	0118	006C	----	----	----	----	----	----	----	----	0096
36	ETS Bus	3	007D	01A4	FF62	01EA	0068	01F0	004D	028E	0070	02DF	0305
37	Car	1	012E	0159	----	----	----	----	----	----	----	----	0186
38	ETS Bus	3	0089	01D4	FF6E	0224	0073	022C	0052	02D8	0077	0340	036B
39	Dump Tr.	2	0072	0073	FF57	0095	0077	0125	----	----	----	----	0141
40	Semi-T.	3	0059	0123	FF3E	0164	003D	0165	0022	01B5	004D	023E	0272
41	Car	1	0110	009C	----	----	----	----	----	----	----	----	00DE
42	½ Ton Tr.	2	00D4	006D	FFB9	00BB	00B8	00C4	----	----	----	----	00E2
43	Moving V.	2	0068	006D	FF4C	00A2	005C	011F	----	----	----	----	0177
44	Semi-T.	4	0074	008F	FF59	00C8	0069	014D	0039	0332	006F	0392	03BA
45	Car-on-Tow	2	00AA	0077	0029	0153	0101	023E	----	----	----	----	0264
46	ETS Bus	3	004E	0067	0030	011E	0071	0229	0047	0378	0068	03F0	0433
47	Semi-T.	3	0096	005E	FF7B	007B	0078	007D	0024	01C1	004F	02CB	02F4
48	ETS Bus	3	00BC	0080	FFA1	00AA	00ED	0222	00AC	0323	00E6	038E	03AE
49	Semi-T.	5	0085	0086	FF6A	00AA	006A	00AC	FF58	035E	005B	0362	0377
50	Semi-T.	3	007B	0075	FF5E	00AD	0061	00B3	0019	01CB	00B5	0211	0212
51	Semi-T.	3	007F	009B	001D	01B4	013B	0231	FF3D	0233	0053	0268	0291
52	Dump Tr.	2	006B	007F	FF4F	00B8	006C	016E	----	----	----	----	0198
53	Car	1	011C	009D	----	----	----	----	----	----	----	----	00BE
54	ETS Bus	3	0058	005C	003C	00DF	008E	01D2	0059	02D3	0086	033D	0369
55	ETS Bus	4	00B9	005C	FF9D	007A	009B	0083	0091	0280	00E1	031F	033B
56	Semi-T.	3	006C	0074	FF50	00DE	0063	0118	002C	0183	0058	0206	023B
57	Semi-T.	4	007B	009C	FF5F	00D0	0072	0159	FF3E	0374	0061	03DF	0435
58	ETS Bus	3	0055	0052	0038	00FB	0084	01B0	004C	02CD	006F	0338	0358
59	Van	1	00D7	0078	----	----	----	----	----	----	----	----	00F0
60	Cement Tr.	3	0059	008D	FF3D	00B9	0040	00BF	001F	011F	0066	01AD	01E6
61	Tr.&Trailr	3	00C5	00DB	FFA8	0131	00A8	0132	0031	02BC	009E	040F	0444
62	ETS Bus	3	008D	0088	006B	0147	00D3	029D	008C	03EE	00CD	0477	0496
63	ETS Bus	2	00F3	02A6	00A7	03CD	00EC	0457	----	----	----	----	0483
64	Dump Tr.	3	0075	00C7	FF5A	010E	005D	011A	0034	019E	0070	0274	02B4
65	Semi-T.	4	005E	025C	FF43	02A5	0049	02B1	FF40	06FB	0045	0705	0733
66	Dump Tr.	2	00AE	0100	FF92	0143	0093	0153	----	----	----	----	01D6
67	Tr.&Trailr	2	00A6	00DA	FF8B	01BE	008C	01BF	----	----	----	----	01D9
68	ETS Bus	2	0061	027D	0040	03C1	005D	045B	----	----	----	----	0494

No.	Veh. Type	#Mx	Mx1	Tx1	Mn1	Tn1	Mx2	Tx2	Mn2	Tn2	Mx3	Tx3	T
69	ETS Bus	3	003D	0094	0022	016D	0064	02A5	FF48	037D	005F	04C1	0507
70	Dump Tr.	3	0081	00DC	FF65	011F	0066	0121	0043	0173	0075	023A	027C
71	Semi-T.	4	0069	01A8	FF4E	0202	005B	03ED	0022	0746	0055	0960	09D3
72	Semi-T.	5	0064	00B3	FF48	00F8	004B	00FE	002E	0535	0076	05E3	0614
73	ETS Bus	3	004F	0084	0029	0159	005B	030E	003D	0397	0067	0500	0535
74	ETS Bus	3	004F	009A	002E	0194	0074	02EA	0046	04A3	0068	0553	05A9
75	Car	1	011F	00FF	----	----	----	----	----	----	----	----	0132
76	Dump Tr.	3	0062	0118	FF44	016E	0047	016F	0029	01EE	004E	02EA	034A
77	ETS Bus	3	0068	006A	FF4D	0119	009F	025C	0061	039D	0094	0420	044F
78	Semi-T.	4	0090	0122	00C3	0212	0065	02A7	003B	060B	0070	068B	06FA
79	Semi-T.	5	009D	00C9	FF82	0107	0083	0108	003E	04C2	0066	0541	05B0
80	ETS Bus	3	00BF	00A7	0097	0157	00F5	02C1	00AD	03FF	00EA	049A	04C2
81	ETS Bus	3	0089	009C	005A	0185	00B6	0343	0072	041C	00B5	0545	0573
82	ETS Bus	3	006A	031B	FF4F	03F7	005F	0443	0043	0503	0062	05B1	0609
83	½Ton Tr.	2	00C5	00Ac	FFAA	00DF	00A9	00E1	----	----	----	----	09BA
84	Semi-T.	5	008C	00A9	002C	0147	0082	01E4	0039	0463	0076	0500	054F
85	Semi-T.	5	0087	0090	FF68	00AA	006B	00AB	0021	02D1	003D	031D	031E
86	Moving V.	2	006A	0080	0021	019B	013E	021B	----	----	----	----	021C
87	Semi-T.	2	0064	006F	0020	01EE	013C	9232	----	----	----	----	09C0
88	Car	1	00FA	009F	----	----	----	----	----	----	----	----	00E5
89	ETS Bus	2	0065	021C	FF49	0305	0065	03B3	----	----	----	----	03EA
90	Semi-T.	3	0077	006E	002F	00CD	004C	0128	0024	01CD	0042	023B	0264
91	Semi-T.	4	0071	010E	FF56	0139	0058	0140	FF47	03AC	0046	03AD	03C4
92	Garbage Tr.	3	008E	0051	FF73	0088	007A	0090	0047	00E4	0074	0143	016D
93	ETS Bus	2	005C	0190	FF41	0208	004E	02CD	----	----	----	----	0305
94	Semi-T.	4	0081	0085	FF66	00B4	0064	00B6	002B	0231	0069	02D0	0317
95	ETS Bus	3	0081	0066	0058	0113	00C1	0217	0078	0325	00B0	039D	03B9
96	Dump Tr.	2	0068	0066	0040	00C4	0062	0124	----	----	----	----	014C
97	ETS Bus	3	0095	0054	0076	00BE	00D7	0184	0090	023A	00CF	028D	02A1
98	ETS Bus	2	0043	0083	0028	015D	0063	0284	----	----	----	----	0355
99	ETS Bus	3	00BA	0055	0090	00B0	00EF	0199	00AB	024F	00EB	02A3	02B6
100	Moving V.	2	008B	009C	0041	01C4	0080	02A3	----	----	----	----	02D0
101	Moving V.	2	005F	0076	FF44	00AF	0054	0133	----	----	----	----	018D
102	ETS Bus	3	00AE	0056	FF93	00A1	00EE	0199	00AC	025D	00ED	02AE	02D4

This appendix includes:

1. Data used in Fig. 4.4 Artificial Test Data in Chapter 4, and the emulated result (underlined) from FETD using the Motorola M6800 Emulator via the AMDAHL computer.
2. Program listing of CLASSIF.

```

IM
SM 0016,01,4E
SM 0018,30
SM 0100,09 0AC,09,0CB,09,0DB,09,0FA,0A,2C,0A,1B,09,0FE,0A,24
SM 0110,0A,20,0A,1B,0A,2E,0A,02,09,0F0,09,0EA,0A,06,09,0EE
SM 0120,09,0F0,0A,0B,09,0FB,0A,2E,0A,30,0A,4E,0A,35,0A,4F
SM 0130,0A,2E,0A,3B,0A,28,0A,20,09,0FE,0A,2A,0A,30,0A,4C
SM 0140,0A,32,0A,5D,0A,28,0A,00,0A,20,09,0BE,09,0DD,09,77
DM 0000,30
DM 0100,50
SR F 3000
R 389
DM 0000,30
EX

```

Data values (artificial) in Fig. 4.4 of Chapter 4.

M68EML is the property of Motorola Ssd, Inc.
Copyright 1975 by Motorola Inc.

Motorola M6800 Emulator, Release 1.0

HH'IA	OC	EA	F	X	A	B	C	S	T
0000	***	0000	0000	0000	00	00	000000	0000	00000000
0000	00	00	00	00	00	00	00	00	00 00 00 00 00 00 00 00
0010	00	00	00	00	00	01	4E 30	00	00 00 00 00 00 00 00 00
0020	00	00	00	00	00	00	00	00	00 00 00 00 00 00 00 00
0100	09	AC	09	CB	09	DB	09	FA	0A 2C 0A 1B 09 FE 0A 24
0110	0A	20	0A	1B	0A	2E	0A	02	09 F0 09 EA 0A 06 09 EE
0120	09	F0	0A	0B	09	FB	0A	2E	0A 30 0A 4E 0A 35 0A 4F
0130	0A	2E	0A	3B	0A	28	0A	20	09 FE 0A 2A 0A 30 0A 4C
0140	0A	32	0A	5D	0A	28	0A	00	0A 20 09 BE 09 DD 09 77
Memory Fault at FFFA									
*3123	SWI	*7FFB	0000	*014E	*01*4E	010Z00	*FFF9	0003425	
0000	24	02	<u>0A 2E</u>	01	14	<u>09 EA</u>	01	1A	<u>0A 4F</u> 01 2E 09 FE
0010	01	38	<u>0A 5D</u>	01	42	<u>01 4E</u>	30	09	<u>BE 0A</u> DD CE 01 4A
0020	01	4E	00	00	00	00	00	00	00 00 00 00 00 00 00 00

#10:50:58 T=.785 RC=0

Emulated result from FETD.

[N.B.] Underlined values are the local maxima and the local minima
extracted by FETD.

M68SAM is the property of Motorola Spd, Inc.
Copyright 1974 by Motorola Inc.

Motorola M6800 Cross Assembler, Release 1.1

		NAM	CLASSIF	
* DATA STORAGE				
0000	0001	MXCNT	RMB	\$1 # OF MAXIMA DETECTED
0001	0001	MNCNT	RMB	\$1 # OF MINIMA DETECTED
0002	0001	MX1H	RMB	\$1 MSB OF 1ST MAX
0003	0001	MX1L	RMB	\$1 LSB OF 1ST MAX
0004	0002	TMX1	RMB	\$2 TIME OF THE 1ST MAX
0006	0001	MN1H	RMB	\$1 MSB OF 1ST MIN
0007	0001	MN1L	RMB	\$1 LSB OF 1ST MIN
0008	0002	TMN1	RMB	\$2 TIME OF THE 1ST MIN
000A	0001	MX2H	RMB	\$1 MSB OF 2ND MAX
000B	0001	MX2L	RMB	\$1 LSB OF 2ND MAX
000C	0002	TMX2	RMB	\$2 TIME OF THE 2ND MAX
000E	0001	MN2H	RMB	\$1 MSB OF 2ND MIN
000F	0001	MN2L	RMB	\$1 LSB OF 2ND MIN
0010	0002	TMN2	RMB	\$2 TIME OF THE 2ND MIN
0012	0001	MX3H	RMB	\$1 MSB OF 3RD MAX
0013	0001	MX3L	RMB	\$1 LSB OF 3RD MAX
0014	0002	TMX3	RMB	\$2 TIME OF THE 3RD MAX
0016	0001	LADXH	RMB	\$1 LAST ADX OF DATA (HIGH)
0017	0001	LADXL	RMB	\$1 LAST ADX OF DATA (LOW)
0018	0001	EPSILO	RMB	\$1 TOLERANCE VALUE (\$1B)
0019	0001	BIASH	RMB	\$1 MSB OF BIASED VOLTAGE
001A	0001	BIASL	RMB	\$1 LSB OF BIASED VOLTAGE
001B	0001	HITHD	RMB	\$1 MSB OF INPUT THRESHOLD
001C	0001	LITHD	RMB	\$1 LSB OF INPUT THRESHOLD
001D	0001	HOTHD	RMB	\$1 MSB OF OUTPUT THRESHOLD
001E	0001	LOTHD	RMB	\$1 LSB OF OUTPUT THRESHOLD
001F	0001	TIME	RMB	\$1 SAMPLING TIMER (\$E0)
0020	0001	XHI1	RMB	\$1 DATA SCRATCH
0021	0001	XLI1	RMB	\$1 DATA SCRATCH
0022	0001	XTHI	RMB	\$1 DATA SCRATCH
0023	0001	XTLI	RMB	\$1 DATA SCRATCH
0024	0001	XT	RMB	\$1 DATA SCRATCH
0025	0001	TSX1	RMB	\$1 DATA SCRATCH
0026	0001	TSX2	RMB	\$1 DATA SCRATCH
0027	0001	TSX3	RMB	\$1 DATA SCRATCH
0028	0001	TSX4	RMB	\$1 DATA SCRATCH
0029	0001	MULT	RMB	\$1 MUXN FACTOR (SCRATCH)
002A	0001	TT22	RMB	\$1 MUXN FACTOR, K-1 (1,2)
002B	0001	TT21	RMB	\$1 MUXN FACTOR, K-1 (5)
002C	0001	TT3	RMB	\$1 MUXN FACTOR, K-1 (1,2)
002D	0001	INVTXH	RMB	\$1 TIMING (K X TMX1-H)

BI

Motorola M68SAM Cross-Assembler

Page 2

```

002E 0001   INVTXL RMB   $1   TIMING (K X TMX1-L)
002F 0002   STORE  RMB   $2   DATA SCRATCH
0031 0001   TEMP1  RMB   $1   DATA SCRATCH
0032 0002   XTEMP  RMB   $2   DATA SCRATCH
0034 0002   DTEMP1 RMB   $2   PRESENT CHANNEL
0036 0002   DTEMP2 RMB   $2   DATA SCRATCH
0038 0002   TEMP20 RMB   $2   OUTPUT TIMER (FFFF)
003A 0001   IPTHR  RMB   $1   INPUT THRESHOLD ($1B)
003B 0001   OPTHR  RMB   $1   OUTPUT THRESHOLD ($0E)
003C 0002   DTEMP3 RMB   $2   DATA SCRATCH
003E 0002   DTEMP4 RMB   $2   DATA SCRATCH
0040 0001   TEMP5  RMB   $1   DATA SCRATCH

```

```

*
*   THIS PROGRAMME SCANS TWO INPUT A/D CHAN-
*   NELS (ONE FROM EACH LOOP) AND TWO
*   OUTPUT D/A CHANNELS ($4100 AND
*   $4101, $4102 AND $4103) TO ACTUATE
*   TWO CONTROL DEVICES

```

```

*
*   GATE 1
*   CHANNEL 1 $0050 TO $0055
*   GATE 2
*   CHANNEL 2 $0058 TO $005D

```

```

E000          ORG   $E000

```

```

*
*   INPUT AND OUTPUT THRESHOLD VALUES SETTING
*

```

```

E000 8E 00FF NEW   LDS   #$00FF
E003 CE 0800      LDX   #$0800
E006 FF 4100      STX   $4100
E009 FF 4102      STX   $4102
E00C 86 10        LDA  A  #$10
E00E 97 31        STA  A  TEMP1
*
E010 CE 4000 AVG   LDX   #$4000
E013 86 50        LDA  A  #$50
*
E015 7F 002F SCAN CLR   STORE
E018 97 30        STA  A  STORE+1
E01A A7 00        STA  A  00,X
E01C 01          NOP
E01D A6 00        LDA  A  00,X
E01F E6 01        LDA  B  01,X
E021 BD E296      JSR   THRESET
E024 08          INX
E025 08          INX
E026 96 30        LDA  A  STORE+1
E028 8B 08        ADD  A  #$08
E02A 8C 4004      CPX   #$4004

```

51

Motorola M68SAM Cross-Assembler

Page 3

```

E02D 26 E6          BNE     SCAN
E02F 7A 0031        DEC     TEMP1
E032 26 DC          BNE     AVG

```

```

*
* INPUT THRESHOLD TESTING (VEHICLE PRESENT ?)
*
* A THRESHOLD UPDATE SEQUENCE AT 0.12
* SEC INTERVALS IS INCLUDED TO RESET
* THE THRESHOLD VALUES AFTER A DISABLE
* VEHICLE LEAVES THE DETECTION ZONE
*

```

```

E034 86 FF          LDA A   #$FF
E036 97 40          STA A   TEMP5
E038 CE 4000 START0 LDX   #$4000
E03B 7F 002F CHGE  CLR   STORE
E03E 86 50          LDA A   #$50
E040 97 30          STA A   STORE+1

*
* START1
E042 DF 32          STX   XTEMP
E044 DE 2F          LDX   STORE
E046 A6 00          LDA A   00,X
E048 E6 01          LDA B   01,X
E04A 97 19          STA A   BIASH
E04C D7 1A          STA B   BIASL
E04E A6 02          LDA A   02,X
E050 E6 03          LDA B   03,X
E052 97 1B          STA A   HITHD
E054 D7 1C          STA B   LITHD
E056 A6 04          LDA A   04,X
E058 E6 05          LDA B   05,X
E05A 97 1D          STA A   HOTHD
E05C D7 1E          STA B   LOTHD
E05E DE 32          LDX   XTEMP
E060 A7 00          STA A   00,X
E062 01            NOP
E063 A6 00          LDA A   00,X
E065 91 1B          CMP A   HITHD
E067 2D 0A          BLT   NEXT
E069 2E 1D          BGT   CONV
E06B E6 01          LDA B   01,X
E06D D1 1C          CMP B   LITHD
E06F 22 17          BHI   CONV
E071 27 15          BEQ   CONV
E073 96 30          LDA A   STORE+1
E075 8B 08          ADD A   #$08
E077 97 30          STA A   STORE+1
E079 08            INX
E07A 08            INX
E07B 8C 4004        CPX   #$4004
E07E 26 C2          BNE     START1

```

BI

Motorola M68SAM Cross-Assembler

Page 4

```

EQ80 7A 0040      DEC      TEMP5
EQ83 26 B3        BNE      START0
EQ85 7E E000      JMP      NEW

*
EQ88 DF 34        CONV     STX      DTEMP1
*
*      INITIALIZATION
*
EQ8A CE 0000      LDX      #0000      (RESET TIME COUNTER)
EQ8D 7F 0000      CLR      MXCNT      (RESET MAXIMA COUNTER)
EQ90 7F 0001      CLR      MNCNT      (RESET MINIMA COUNTER)
EQ93 BD E2B7      JSR      FETCHA

*
*      MAXIMA DETECTION
*
EQ96 97 20        MXD      STA A   XHI1
EQ98 07 21        STA B   XLI1
EQ9A DF 25        STX      TSX1
EQ9C 08          FLSMX    INX
EQ9D BD E277      JSR      TLI
EQA0 BD E2B7      JSR      FETCHA
EOA3 91 20        CMP A   XHI1
EOA5 2E EF        BGT      MXD      (A>XHI1)
EOA7 2D 10        BLT      LESS
EOA9 01 21        CMP B   XLI1      (A=XHI1)
EOAB 22 E9        BHI      MXD      (B> OR = XLI1)
EOAD 27 E7        BEQ      MXD
EOAF D7 23        STA B   XTLI      (B<XLI1)
EOB1 CB 1B        ADD B   #1B
EOB3 25 E7        BCS     FLSMX
EOB5 01 21        CMP B   XLI1
EOB7 20 17        BRA     CPMX
EOB9 97 22        LESS    STA A   XHI1      (A<XHI1)
EOBB D7 23        STA B   XTLI
EOBD 01 21        CMP B   XLI1
EOBF 23 11        BLS     STRMX      (B< OR = XLI1)
EOC1 D0 21        SUB B   XLI1      (B>XLI1)
EOC3 5A          DEC B
EOC4 D7 24        STA B   XT
EOC6 C6 FE        LDA B   #FF
EOC8 D0 24        SUB B   XT
EOCA C1 1B        CMP B   #1B
EOCC 2D CE        BLT     FLSMX
EOCE 20 02        BRA     STRMX
EOD0 22 CA        CPMX    BHI     FLSMX
EOD2 7C 0000      STRMX   INC     MXCNT
EOD5 D6 00        LDA B   MXCNT
EOD7 C1 02        CMP B   #02
EOD9 27 17        BEQ     NDMX
EODB 22 2A        BHI     RDMX

```

```

E0DD 96 20      LDA A  XHI1      (STORE 1ST MAX.)
E0DF D6 21      LDA B  XLI1
E0E1 BD E27D    JSR    BIASED
E0E4 97 02      STA A  MX1H
E0E6 D7 03      STA B  MX1L
E0E8 DF 27      STX   TSX3
E0EA DE 25      LDX   TSX1
E0EC DF 04      STX   TMX1
E0EE DE 27      LDX   TSX3
E0F0 20 28      BRA   CONTD
E0F2 96 20      NDMX  LDA A  XHI1      (STORE 2ND MAX.)
E0F4 D6 21      LDA B  XLI1
E0F6 BD E27D    JSR    BIASED
E0F9 97 0A      STA A  MX2H
E0FB D7 0B      STA B  MX2L
E0FD DF 27      STX   TSX3
E0FF DE 25      LDX   TSX1
E101 DF 0C      STX   TMX2
E103 DE 27      LDX   TSX3
E105 20 13      BRA   CONTD
E107 96 20      RDMX  LDA A  XHI1      (STORE 3RD MAX.)
E109 D6 21      LDA B  XLI1
E10B BD E27D    JSR    BIASED
E10E 97 12      STA A  MX3H
E110 D7 13      STA B  MX3L
E112 DF 27      STX   TSX3
E114 DE 25      LDX   TSX1
E116 DF 14      STX   TMX3
E118 DE 27      LDX   TSX3
E11A 96 22      CONTD LDA A  XTHI
E11C D6 23      LDA B  XTLI

*
*   MINIMA DETECTION
*
E11E 97 20      MND   STA A  XHI1
E120 D7 21      STA B  XLI1
E122 DF 25      STX   TSX1
E124 08      FLSMN INX

*
*   OUTPUT THRESHOLD TESTING
*
E125 96 1D      LDA A  HOTHD
E127 91 20      CMP A  XHI1
E129 2E 08      BGT   STLST      (HOTHD>XHI1)
E12B 2D 0C      BLT   CONTD2     (HOTHD<XHI1)
E12D D6 1E      LDA B  LOTHD      (HOTHD=XHI1)
E12F D1 21      CMP B  XLI1
E131 2D 06      BLT   CONTD2     (LOTHD<XLI1)
E133 DE 27      STLST LDX   TSX3      (LOTHD>XLI1)
E135 DF 16      STX   LADXH

```

SI

Motorola M68SAM Cross-Assembler

Page 6

```

E137 20 76          BRA      EXIT
                *
E139 BD E277 CONTD2 JSR      TLI
E13C BD E2B7        JSR      FETCHA
E13F 91 20          CMP     A    XHI1
E141 2D 0B          BLT     MND      (A<XHI1)
E143 2E 0E          BGT     GRE
E145 D1 21          CMP     B    XLI1      (A=XHI1)
E147 23 05          BLS     MND      (B< OR =XLI1)
E149 07 23          STA     B    XTLI      (B>XLI1)
E14B C0 1B          SUB     B    #1B
E14D 25 05          BCS     FLSMN
E14F D1 21          CMP     B    XLI1
E151 20 1D          BRA      CMPMN
E153 97 22          GRE     STA     A    XTHI      (A>XHI1)
E155 07 23          STA     B    XTLI
E157 D1 21          CMP     B    XLI1
E159 22 17          BHI     STRMN      (B> OR = XLI1)
E15B 27 15          BEQ     STRMN
E15D 07 24          STA     B    XT      (B<XLI1)
E15F D6 21          LDA     B    XLI1
E161 D0 24          SUB     B    XT
E163 07 24          STA     B    XT
E165 C6 FF          LDA     B    #6FF
E167 D0 24          SUB     B    XT
E169 5C            INC     B
E16A C1 1B          CMP     B    #1B
E16C 23 B6          BLS     FLSMN
E16E 20 02          BRA      STRMN
E170 23 B2          CMPMN  BLS     FLSMN
E172 7C 0001 STRMN  INC     MNCNT
E175 D6 01          LDA     B    MNCNT
E177 C1 01          CMP     B    #01
E179 26 1A          BNE     NDMN
E17B 96 20          LDA     A    XHI1      (STORE 1ST MIN.)
E17D D6 21          LDA     B    XLI1
E17F BD E27D        JSR      BIASED
E182 97 06          STA     A    MN1H
E184 D7 07          STA     B    MN1L
E186 DF 27          STX     TSX3
E188 DE 25          LDX     TSX1
E18A DF 08          STX     TMN1
E18C DE 27          LDX     TSX3
E18E 96 22          LDA     A    XTHI
E190 D6 23          LDA     B    XTLI
E192 7E E096        JMP     MXD
E195 96 20          NDMN  LDA     A    XHI1      (STORE 2ND MIN.)
E197 D6 21          LDA     B    XLI1
E199 BD E27D        JSR      BIASED
E19C 97 0E          STA     A    MN2H

```

```

E19E D7 0F      STA B  MN2L
E1A0 DF 27      STX   TSX3
E1A2 DE 25      LDX   TSX1
E1A4 DF 10      STX   TMN2
E1A6 DE 27      LDX   TSX3
E1A8 96 22      LDA A  XTHI
E1AA D6 23      LDA B  XTLL
E1AC 7E E096    JMP   MXD

```

```

*
* CLASSIFICATION ROUTINE
* THE ALGORITHM IS BASED ON THE NUMBER
* OF MAXIMA, THE RATIO BETWEEN THE TIME
* THE FIRST MAXIMUM IS DETECTED AND THE
* DURATION OF THE SIGNATURE, AND THE
* MAGNITUDE OF THE FIRST MAXIMUM COM-
* PARED TO THE MAGNITUDE OF THE SECOND
* MAXIMUM

```

```

E1AF 96 00      EXIT   LDA A  MXCNT
E1B1 81 02      CMP A  #02
E1B3 2D 6F      BLT   RETURN
E1B5 27 2A      BEQ   NEG2
E1B7 81 04      CMP A  #04
E1B9 22 69      BHI   RETURN

```

```

*
E1BB 96 02      NEG3   LDA A  MX1H
E1BD 91 0A      CMP A  MX2H
E1BF 22 16      BHI   TMTST3
E1C1 27 06      BEQ   LBTST3
E1C3 BD E244    JSR   BUS
E1C6 7E E224    JMP   RETURN

```

```

*
E1C9 D6 03      LBTST3 LDA B  MX1L
E1CB D1 0E      CMP B  MX2L
E1CD 22 08      BHI   TMTST3
E1CF 27 06      BEQ   TMTST3
E1D1 BD E244    JSR   BUS
E1D4 7E E224    JMP   RETURN

```

```

*
E1D7 86 02      TMTST3 LDA A  #02
E1D9 97 29      STA A  MULT
E1DB BD E2C5    JSR   HALF (2)
E1DE 7E E204    JMP   HI12

```

```

*
E1E1 96 02      NEG2   LDA A  MX1H
E1E3 81 01      CMP A  #01
E1E5 27 3B      BEQ   RETURN
E1E7 91 0A      CMP A  MX2H
E1E9 22 12      BHI   TMTST2
E1EB 27 0A      BEQ   LBTST2

```

SI

Motorola M68SAM Cross-Assembler

Page 8

```

*
E1ED 86 05 BACK LDA A #405 (MX1H<MX2H)
E1EF 97 29 STA A MULT
E1F1 BD E22A JSR INVNOR
E1F4 7E E215 JMP L012
*
E1F8 06 03 LBTST2 LDA B MX1L
E1F9 D1 0B CMP B MX2L
E1FB 23 F0 BLS BACK
*
E1FD 86 02 TMTST2 LDA A #402 (MX1>MX2)
E1FF 97 29 STA A MULT
E201 BD E205 JSR HALF (2)
*
E204 91 16 H112 CMP A LADXH
E206 22 0B BHI HIBUS
E208 27 02 BEQ HIEQU
E20A 20 1B BRA RETURN
E20C D1 17 HIEQU CMP B LADXL
E20E 23 14 BLS RETURN
E210 BD E244 HIBUS JSR BUS (K X TMX1>LADXH)
E213 20 0F BRA RETURN
*
E215 91 16 L012 CMP A LADXH
E217 22 0B BHI RETURN
E219 27 02 BEQ LOEQU
E21B 20 04 BRA LOBUS
E21D D1 17 LOEQU CMP B LADXL
E21F 22 03 BHI RETURN
E221 BD E244 LOBUS JSR BUS (K X TMX1< OR = LADXH)
E224 BD E2E1 RETURN JSR LEFT
E227 7E E000 JMP NEW
*
* SUBROUTINE INVNOR
* THIS SUBROUTINE MULTIPLIES TMX1 BY
* A FACTOR N SUCH THAT WE CAN DETER-
* MINE WHERE THE FIRST MAXIMUM IS
* COMPARING TO THE TOTAL DURATION OF
* THE SIGNATURE
*
E22A 96 04 INVNOR LDA A TMX1
E22C D6 05 LDA B TMX1+1
E22E 0C CLC
E22F DB 05 ADB ADD B TMX1+1
E231 25 09 BCS CARRY
E233 9B 04 ADA ADD A TMX1
E235 7A 0029 DEC MULT
E238 26 F5 BNE ADB
E23A 20 03 BRA KEEP
E23C 4C CARRY INC A

```

SI

Motorola M68SAM Cross-Assembler

Page 9

```

E23D 20 F4          BRA      ADA
E23F 97 2D      KEEP    STA A   INVTXH
E241 D7 2E      .        STA B   INVTXL
E243 39          RTS

*
*              SUBROUTINE BUS
*              THIS ROUTINE OUTPUTS A VOLTAGE OF
*              +10 VDC TO THE ANALOG OUTPUT OF THE
*              ST6800 D/A-A/D BOARD TO INDICATE
*              THAT A BUS IS DETECTED
*
E244 96 35      BUS     LDA A   DTEMP1+1
E246 81 02          CMP A   #402
E248 26 0C          BNE     GATE1
E24A 86 0F          LDA A   #40F
E24C C6 FF          LDA B   #4FF
E24E B7 4102        STA A   #4102
E251 F7 4103        STA B   #4103
E254 20 0A          BRA     TIMER1
E256 86 0F      GATE1  LDA A   #40F
E258 C6 FF          LDA B   #4FF
E25A B7 4100        STA A   #4100
E25D F7 4101        STA B   #4101
E260 CE 2000      TIMER1 LDX   #42000
E263 09          TIMER  REX
E264 26 FD          BNE     TIMER
E266 86 08          LDA A   #408
E268 C6 00          LDA B   #400
E26A B7 4100        STA A   #4100
E26D B7 4102        STA A   #4102
E270 F7 4101        STA B   #4101
E273 F7 4103        STA B   #4103
E276 39          OUT     RTS

*
*              TIMING LOOP
*
E277 C6 E0      TL1    LDA B   #4E0
E279 5A          LOOP1  DEC B
E27A 26 FD          BNE     LOOP1
E27C 39          RTS

*
*              THIS ROUTINE OFFSETS THE BIASED
*              VOLTAGE LEVEL BY SUBTRACTING THIS
*              VOLTAGE LEVEL FROM THE DETECTED
*              MAXIMA AND MINIMA
*
E27D D1 1A      BIASED  CMP B   BIASL
E27F 23 04          BLS     HI
E281 D0 1A          SUB B   BIASL
E283 20 0E          BRA     AL1

```

31

Motorola M6800M Cross-Assembler

Page 10

```

E285 D7 24 HI STA B XT
E287 D8 1A LDA B BIASL
E289 D0 24 SUB B XT
E28B 5A DEC B
E28C D7 24 STA B XT
E28E C6 FF LDA B #FF
E290 D0 24 SUB B XT
E292 4A DEC A
E293 90 19 RLI SUB A BIASH
E295 39 RTS

```

*

*

SUBROUTINE THRESE

*

*

*

*

*

THIS SUBROUTINE SETS THE BIASED

VOLTAGE LEVEL, THE INPUT AND THE

OUTPUT THRESHOLD VALUES FOR THE

MULTIPLEXED A/D CHANNELS

```

E296 DF 32 THRESE STX XTEMP
E298 DE 2F LDX STORE
E29A A7 00 STA A 00,X
E29C E7 01 STA B 01,X
E29E CB 1B ADD B #1B
E2A0 24 01 BCC LTAVI
E2A2 4C INC A
E2A3 A7 02 LTAVI STA A 02,X
E2A5 E7 03 STA B 03,X
E2A7 A6 00 LDA A 00,X
E2A9 E6 01 LDA B 01,X
E2AB CB 0E ADD B #0E
E2AD 24 01 BCC LTAUO
E2AF 4C INC A
E2B0 A7 04 LTAUO STA A 04,X
E2B2 E7 05 STA B 05,X
E2B4 DE 32 LDX XTEMP
E2B6 39 RTS

```

*

*

SUBROUTINE FETCHA

*

*

*

*

THIS SUBROUTINE FETCHES THE INPUT

DATA FROM EACH OF THE INPUT A/D

CHANNELS

```

E2B7 DF 36 FETCHA STX DTEMP2
E2B9 DE 34 LDX DTEMP1
E2BB A7 00 STA A 00,X
E2BD 01 NOP
E2BE A6 00 LDA A 00,X
E2C0 E6 01 LDA B 01,X
E2C2 8D 6E BSR DISVEN
E2C4 39 RTS

```

*

```

*      SUBROUTINE HALF
*      THIS SUBROUTINE DOES THE SAME FCN
*      AS INVOR EXCEPT THAT HALF VALUE
*      OF TMX1 IS INCLUDED TO GENERATE A
*      DECISION LINE AT 0.4T
*
E2C5 96 04  HALF  LDA A  TMX1
E2C7 06 05          LDA B  TMX1+1
E2C9 46          ROR A
E2CA 56          ROR B
E2CB 0C          CLC
E2CC 08 01  HADB  ADD B  TMX1+1
E2CE 25 09          BCS  HCARY
E2D0 98 04  HADA  ADD A  TMX1
E2D2 7A 0029      DEC  MULT
E2D5 26 F5          BNE  HADB
E2D7 20 03          BRA  HEFP
E2D9 4C          HCARY  INC A
E2DA 20 F4          BRA  HADA
E2DC 97 2D  HEFP  STA A  INVTXH
E2DE D7 2E          STA B  INVTXL
E2E0 39          RTS

*
*      SUBROUTINE LEFT
*      THIS SUBROUTINE ENSURES THAT THE
*      VEHICLE HAS LEFT THE DETECTION
*      ZONE BEFORE THE RESET OF THE I/O
*      THRESHOLD BARAMETERS
*
E2E1 DE 34  LEFT  LDX  DTEMP1
E2E3 86 40          LDA A  #40
E2E5 97 31          STA A  TEMP1
E2E7 96 1D          LDA A  HOTH0
E2E9 06 1E          LDA B  LOTH0
E2EB 97 3C          STA A  DTEMP3
E2ED 07 3D          STA B  DTEMP3+1
E2EF A7 00  HIGH  STA A  00,X
E2F1 01          NOP
E2F2 A6 00          LDA A  00,X
E2F4 E6 01          LDA B  01,X
E2F6 91 3C          CMP A  DTEMP3
E2F8 22 F5          BHI  HIGH
E2FA 27 02          BEQ  EQU
E2FC 20 06          BRA  NOTYET
E2FE D1 3D  EQU  CMP B  DTEMP3+1
E300 22 ED          BHI  HIGH
E302 27 09          BEQ  READY
E304 97 3C  NOTYET STA A  DTEMP3
E306 D7 3D          STA B  DTEMP3+1

```

SI

Motorola M68SAM Cross-Assembler

Page 12

```

E308 7A 0031      DEC      TEMP1
E30B 26 E2        BNE      HIGH
E30D 97 19  READY STA  A    BIASH
E30F 96 35        LDA  A    DTEMP1+1
E311 81 00        CMP  A    #400
E313 27 08        BEQ      CH1
E315 96 19        LDA  A    BIASH
E317 97 58        STA  A    $58
E319 D7 59        STA  B    $59
E31B 20 06        BRA      OK
E31D 96 19  CH1  LDA  A    BIASH
E31F 97 50        STA  A    $50
E321 D7 51        STA  B    $51
E323 39          OK   RTS

*
*   THIS IS A TIME DELAY PROGRAMME
*   THIS ROUTINE DELAYS THE START OF
*   SAMPLING INPUT DATA IN ORDER TO
*   ALLOW THE DETECTOR/AMPLIFIER TO
*   SETTLE DOWN
*
E324 86 40  RESTART LDA  A    #40
E326 CE FFFF LX     LDX   #FFFF
E329 09          DX     DEY
E32A 26 FD        BNE     DX
E32C 4A          DEC  A
E32D 26 F7        BNE     LX
E32F 7E E000     JMP   NEW

*   SUBROUTINE DISVEH
*   THIS SUBROUTINE TESTS FOR VEHICLES
*   WHICH OCCUPY ONE OF THE LOOPS FOR
*   MORE THAN A PREDEFINED PERIOD OF
*   TIME (7 SECONDS, I.E., EQUIVALENT
*   TO A BUS TRAVELLING AT LESS THAN
*   8 KM/HR) IF THIS PERIOD IS EXPIRED
*   THE SYSTEM WILL DISCARD THE LOOP
*   AND CONSIDERS ONLY THE UNOCCUPIED
*   LOOP
*
E332 97 3E  DISVEH STA  A    DTEMP4
E334 D7 3F        STA  B    DTEMP4+1
E336 96 36        LDA  A    DTEMP2
E338 81 16        CMP  A    #16
E33A 2D 11        BLT   OKAY
E33C C6 00        LDA  B    #400
E33E D1 35        CMP  B    DTEMP1+1
E340 27 04        BEQ   CHNL2
E342 D7 35        STA  B    DTEMP1+1
E344 20 04        BRA   JUMP
E346 C6 02  CHNL2 LDA  B    #402

```

```

E348 D7 35          STA B DTEMP1+1
E34A 7E E000 JUMP  JMP NEW
E34D DE 36 OKAY    LDX DTEMP2
E34F 96 3E        LDA A DTEMP4
E351 D6 3F        LDA B DTEMP4+1
E353 39          RTS
* RESTART VECTOR SETTING
*
E3FE              ORG $E3FE
E3FE E324        FDB RESTART (RESTART INTERRUPT VECTOR)
                  FDB RESTART (RESTART INTERRUPT VECTOR)

```