

9908

NATIONAL LIBRARY
OTTAWA



BIBLIOTHÈQUE NATIONALE
OTTAWA

NAME OF AUTHOR..... DENNIS HUNT

TITLE OF THESIS.... An Investigation of Selective
attentional responses in a discrimination
shift paradigm

UNIVERSITY..... Alberta

DEGREE FOR WHICH THESIS WAS PRESENTED..... Ph.D

YEAR THIS DEGREE GRANTED..... 1971

Permission is hereby granted to THE NATIONAL LIBRARY
OF CANADA to microfilm this thesis and to lend or sell copies
of the film.

The author reserves other publication rights, and
neither the thesis nor extensive extracts from it may be
printed or otherwise reproduced without the author's
written permission.

(Signed)..... Dennis Hunt

PERMANENT ADDRESS:

..... 435 7th St. E
..... Saskatoon, Sask.
.....

DATED... Aug. 13 1971

THE UNIVERSITY OF ALBERTA

AN INVESTIGATION OF SELECTIVE ATTENTIONAL
RESPONSES AND OVERTRAINING IN A
DISCRIMINATION SHIFT PARADIGM

by

DENNIS HUNT

A THESIS

SUBMITTED TO THE FACULTY OF GRADUATE STUDIES
IN PARTIAL FULFILMENT OF THE REQUIREMENTS FOR THE DEGREE
OF DOCTOR OF PHILOSOPHY

DEPARTMENT OF EDUCATIONAL PSYCHOLOGY

EDMONTON, ALBERTA

FALL, 1971

THE UNIVERSITY OF ALBERTA

AN INVESTIGATION OF SELECTIVE ATTENTIONAL
RESPONSES AND OVERTRAINING IN A
DISCRIMINATION SHIFT PARADIGM

by

DENNIS HUNT

A THESIS
SUBMITTED TO THE FACULTY OF GRADUATE STUDIES
IN PARTIAL FULFILMENT OF THE REQUIREMENTS FOR THE DEGREE
OF DOCTOR OF PHILOSOPHY

DEPARTMENT OF EDUCATIONAL PSYCHOLOGY
EDMONTON, ALBERTA
FALL, 1971

© Dennis Hunt 1972

UNIVERSITY OF ALBERTA

FACULTY OF GRADUATE STUDIES

The undersigned certify that they have read, and recommend to the Faculty of Graduate Studies for acceptance, a thesis entitled An Investigation of Selective Attentional Responses and Overtraining in a Discrimination Shift Paradigm submitted by Dennis Hunt in partial fulfilment of the requirements for the degree of Doctor of Philosophy.

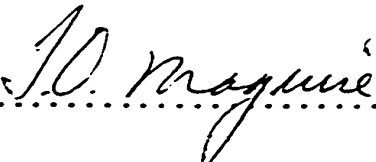

.....
Supervisor

.....

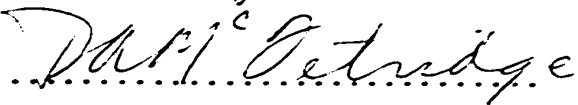
.....

.....

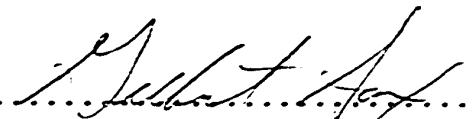
Date .. August .. 11, .. 71 ..

.....
External Examiner

ABSTRACT

This study investigated choice responses and selective attentional responses in a tactile discrimination task under the effect of overlearning.

A sample of 95 Grade III Ss were trained to criterion on a two dimensional tactile discrimination shift task. One half of the Ss were overtrained, and all Ss executed either an intradimensional, extradimensional or control shift. Recordings of the choice responses, and the time spent touching each value of the dimensions were obtained.

An analysis of the postshift choice responses showed the number of errors was least in the intradimensional shift, greatest in the extradimensional shift, with the number of control shift errors falling midway between. Overlearning resulted in an increased ease of learning in the ID shift, decreased ease of learning in the extradimensional shift and no change in the ease of learning in the control shift, but these results did not reach statistical significance at the .05 level. Further evidence for the effect of overlearning was provided by examining the backward learning curves and the selective attentional responses for each group.

An analysis of the selective attentional responses in the preshift stage showed that the percentage time spent touching the relevant dimension gradually increased in the preshift stage and continued to increase in the overlearning

stage. In the postshift stage positive transfer of a mediating response was shown in the intradimensional groups, negative transfer in the extradimensional groups and no transfer in the control groups.

The results obtained in the study were interpreted as substantiating selective attentional mediating theory in the haptic modality. Further areas of research, which use the technique developed in this study, were suggested.

ACKNOWLEDGEMENTS

The writer would like to thank the many people who so kindly assisted in the development of this study.

In particular he would like to thank Bob Mullen for his help in the writing of the computer programmes and the principal and staff of Braemar school for their cooperation during the testing period.

The writer would also like to thank his committee members for their friendly and helpful contributions, and especially his adviser, Dr. Don Fitzgerald, whose unflagging interest and extreme thoughtfulness throughout the writer's doctoral work have been immeasurable. Any success of the study is due in large part to his efforts.

Finally the writer wishes to thank his wife, Rosemary, for her contribution to the study and also for her interest in his work over the last two years.

TABLE OF CONTENTS

| Chapter | | Page |
|---------|---|------|
| I | INTRODUCTION..... | 1 |
| | Delimitation of the Study..... | 2 |
| | Reasons for the Study..... | 5 |
| | Problem..... | 6 |
| | Definition of Terms..... | 7 |
| II | RELATED BACKGROUND THEORY..... | 8 |
| | History of Discrimination Learning... | 8 |
| | Main Discrimination Theories..... | 10 |
| | Kendler and Kendler: Verbal Mediation..... | 11 |
| | Wyckoff: Observing Response..... | 12 |
| | Goodwin-Lawrence: Acquired Distinctiveness of Cues..... | 13 |
| | Sutherland-Mackintosh: Stimulus Analysing Mechanisms..... | 14 |
| | Zeaman-House: Attention Deficiency | 15 |
| | Lovejoy: Selective Attention..... | 17 |
| | Differentiation Theory..... | 19 |
| | Related Selective Attention Theories. | 21 |
| | Discrimination Shift Paradigms..... | 24 |
| III | REVIEW OF RELATED LITERATURE..... | 29 |
| | Overlearning Reversal Effect..... | 29 |
| | Overlearning Reversal Effect in Children..... | 32 |
| | Overlearning and Intra- and Extra- dimensional Shifts..... | 33 |
| | Summary of Theory and Resulting Experimental Hypotheses..... | 36 |
| | Hypothesis 1..... | 37 |

| Chapter | | Page |
|-----------|--|-----------|
| | Hypothesis 2..... | 39 |
| | Hypothesis 3..... | 39 |
| | Hypothesis 4..... | 39 |
| | Hypothesis 5..... | 39 |
| IV | METHODS AND PROCEDURES..... | 40 |
| | Sample..... | 40 |
| | Paradigm Design..... | 40 |
| | Experimental Design..... | 42 |
| | Description of Apparatus..... | 44 |
| | Stimulus Blocks and Plates..... | 44 |
| | Discrimination Box..... | 44 |
| | Experimental Procedure..... | 50 |
| | Statistical Hypotheses..... | 54 |
| V | PRESENTATION AND ANALYSIS OF THE DATA... | 56 |
| | Analysis of Original Learning..... | 59 |
| | Analysis of Postshift Choice Responses..... | 59 |
| | Analysis of Tactile Responses..... | 64 |
| VI | DISCUSSION OF RESULTS..... | 74 |
| | Preshift Learning..... | 74 |
| | Postshift Learning..... | 76 |
| | Overlearning and Postshift Learning.. | 77 |
| | Backward Learning Curves..... | 79 |
| | Preshift and Postshift Tactile Responses..... | 82 |
| | Summary..... | 98 |

| Chapter | | Page |
|---------|---|------|
| VII | SUMMARY, CONCLUSIONS AND FURTHER RESEARCH..... | 99 |
| | Summary..... | 99 |
| | The Purpose of the Study..... | 99 |
| | The Sample..... | 99 |
| | The Method..... | 99 |
| | The Findings..... | 100 |
| | Conclusions..... | 101 |
| | Further Research..... | 106 |
| | SELECTED REFERENCES..... | 107 |
| | APPENDIX A - RECORDING SHEETS FOR TRIAL BY TRIAL INSTRUMENTAL RESPONSES..... | 115 |
| | APPENDIX B - SPECIMEN COMPUTER PRINTOUT FOR ONE SUBJECT..... | 118 |
| | APPENDIX C - RAW SCORE DATA FOR SAMPLE..... | 121 |

LIST OF TABLES

| Table | | Page |
|-------|---|------|
| 1 | Stimuli Combinations in the Preshift, Control and Postshift Groups..... | 52 |
| 2 | Means and Standard Deviations of the Total Errors in the Pre- and Postshift Stages..... | 57 |
| 3 | Correlations Between Total Trials (1); Trials to Last Error (2), and Total Errors (3) in Logarithmic Form..... | 58 |
| 4 | Means and Standard Deviations of Log (Total Errors Plus One) in the Preshift Phase..... | 58 |
| 5 | Means and Standard Deviations of Log (Total Errors Plus One) in the Postshift Phase..... | 59 |
| 6 | Analysis of Variance for Preshift Choice Responses..... | 60 |
| 7 | Analysis of Variance for Postshift Choice Responses..... | 61 |
| 8 | Planned Comparisons of the ID, ED and Control Means at Two Levels of Learning..... | 64 |
| 9 | Correlated t Test Results for Individual First and Second Half Series of Trials in the Preshift ID-ED-crit.-OL Group..... | 65 |
| 10 | t Test Results for the Combined ID-ED Group Means at Two Levels of Learning... | 66 |
| 11 | Two-Way Analysis of Variance (Repeated Measures on Subjects) for H_0 : 3-1 and H_0 : 3-2..... | 68 |
| 12 | Two-Way Analysis of Variance (Repeated Measures on Subjects) for H_0 : 4-1 and H_0 : 4-2..... | 70 |
| 13 | Cell Means Obtained from Table 12 Analysis of Variance..... | 71 |

| Table | | Page |
|-------|---|------|
| 14 | Two-Way Analysis of Variance (Repeated Measures on Subjects) of the Postshift Control Groups for $H_0: 5-1$, $H_0: 5-2$ and $H_0: 5-3$ | 72 |
| 15 | Cell Means for Two-Way Analysis of Variance of Table 14 (N=16)..... | 72 |

LIST OF FIGURES

| Figure | | Page |
|--------|---|------|
| 1 | Form Square and Texture A..... | 45 |
| 2 | Discrimination Box..... | 46 |
| 3 | Circuit Diagram of Electrical Apparatus Used in the Study..... | 48 |
| 4 | Typical Output from Ink Recorder for Two Trials..... | 49 |
| 5 | ID, ED and Control Group Means for Two Levels of Learning in the Post- shift Stage..... | 63 |
| 6 | Cell Means for the ID Criterion and ID Overlearning Blocks..... | 69 |
| 7 | Backward Learning Curves for ID, ED and Control Groups for Two Levels of Learning Plotted in Blocks of Three Trials..... | 81 |
| 8 | Mean Percentage Backward Curves for the Combined Preshift ID-ED-OL-crit. Group (N=64)..... | 84 |
| 9 | Mean Percentage Curves for the Crite- rion Intradimensional Group (N=16)..... | 85 |
| 10 | Mean Percentage Curves for the Crite- rion Extradimensional Group (N=16)..... | 86 |
| 11 | Mean Percentage Curves for the Crite- rion Control Group (N=16)..... | 87 |
| 12 | Mean Percentage Postshift Backward Curves for the Criterion Extra- dimensional Group (N=16)..... | 89 |
| 13 | Mean Percentage Postshift Backward Curves for the Criterion Intra- dimensional and Criterion Control Groups (N=16)..... | 90 |
| 14 | Mean Percentage Curves for the Over- learning Intradimensional Group (N=16).. | 91 |

| Figure | | Page |
|--------|--|------|
| 15 | Mean Percentage Curves for the Over- learning Extradimensional Group (N=16).. | 92 |
| 16 | Mean Percentage Curves for the Over- learning Control Group (N=16)..... | 93 |
| 17 | Mean Percentage Postshift Backward Curves for the Overlearning Extra- dimensional Group (N=16)..... | 95 |
| 18 | Mean Percentage Postshift Backward Curves for the Overlearning Intra- dimensional and Overlearning Control Groups (N=16)..... | 96 |
| 19 | Summary Graphs for the Criterion ID, ED, Cont. Groups..... | 102 |
| 20 | Summary Graphs for the Overlearning ID, ED, Cont. Groups..... | 103 |

CHAPTER I

INTRODUCTION

From the first moment of life, the child has to learn to choose one thing over another, and to utilize certain aspects of his choice to shape subsequent behaviour. At first, he may be concerned only with the difference between his mother and a stranger, smiling at the former and crying at the latter. Later he will learn to respond differentially to more complex situations, such as deciding what constitutes a good play toy and what does not, what particular number a symbol stands for or which belief is better than another. In order to make a choice or select a particular stimulus, the child has to be able to tell the difference between alternatives, attending to some attributes and ignoring others. What governs a child's selection when he discriminates between alternatives, the cognitive processes that take place during that choice, and the subsequent building of concepts, are a fundamental issue of learning. The teacher, who is intimately connected with all facets of learning, must try to understand the processes involved if he is to enhance the learning situation. Studies that investigate such basic cognitive processes provide the teacher with some insight into the nature of learning.

This study concerns itself with the cognitive functions that are involved when a child learns to discriminate between alternatives and develops concepts which have

remains relevant in the postshift stage, then the shift is known as an intradimensional shift (ID). When the relevant training dimension becomes an irrelevant dimension in the postshift stage, then the shift is known as an extradimensional shift (ED). The responses of the S in the postshift stage are assumed to reflect the type of learning that has taken place in the preshift phase (Wolff, 1967). Slamecka (1968) has criticized the basic format of the discrimination paradigm, and in view of his criticisms this study uses shifts within a dimension (ID) and between dimensions (ED) only, and uses different values of the dimension in the preshift and the postshift phases.

Discrimination learning theories fall into two main classes. In one class of theory, commonly called the one-stage theory, a direct association is assumed to be built up between the stimulus and the response, and in the other class of theory, commonly called the two-stage mediation theory, the S is assumed to make an inner response of some kind which mediates between the original stimulus and the actual response made. In general, these responses have been thought of as attentional in nature (Zeaman & House, 1963; Lovejoy, 1968), or verbal in nature (Kendler & Kendler, 1959).

The Kendlers, as well as advancing the idea of verbal mediating responses, propose a developmental theory which assumes that nonarticulate Ss (animals and young children) behave as if they operate under a one-stage theory, whilst

articulate Ss (older children) behave as if they operate under a verbal two-stage theory (Kendler & Kendler, 1962). Empirical evidence for and against this developmental theory is abundant (Wolff, 1967). Although Zeaman and House and Lovejoy do not advance developmental predictions, their models are capable of predicting similar developmental results to those predicted by the Kendler model, when appropriate parameters are used. Evidence to support the adoption of either an attentional or a verbal mediating theory is not conclusive, but reviewers in general agree that most evidence supports the attentional theory (Shepp & Turrisi, 1967; Wolff, 1967; Turrisi, 1970; Eimas, 1970).

This study adopts the general approach of the Zeaman and House model (1963) and the Lovejoy model (1968) as models for general interpretation. Attention in the Zeaman and House model is identified with a dimensional observing response which, like the instrumental response, can undergo acquisition and extinction through reinforcement and non-reinforcement. Attention in the Lovejoy model is identified with two selective processes, selective learning and selective control. Both of these processes are dependent upon the dimensional distinctiveness of the cues.

The attentional models predict that the probability of making a relevant observing response approaches an asymptote more slowly than does the probability of making a correct instrumental response. As this study is interested in the mediating response, and as the strength of this

response is dependent upon the amount of original learning that takes place, overlearning is incorporated into the study in order to examine its effect on the mediating response.

The present research, therefore, is delimited to an investigation of the effect of overlearning on the selective attentional response in a discrimination shift paradigm.

Reasons for the Study

The difficulty in the past with studies involving selective attentional mediating responses has been that the nature of the mediating response could only be inferred from observations of the Ss' choice responses. The result has been that in many studies the emphasis has been placed on reconciling the different outcomes from the various shift paradigms rather than examining the underlying processes involved (Turrisi, 1970). Experimentation in discrimination learning has now reached the stage where methods need to be devised to allow the examination of the discrimination process in more detail. The study of Eimas (1969) with third grade Ss, and the series of Rydberg studies (Rydberg, Kashdan & Trabasso, 1966; Rydberg, 1969; Rydberg & Arnberg, 1969a; Rydberg & Arnberg, 1969b) were designed with this in view. The latter studies allow a direct measure of tactile observing responses to stimulus dimensions by using a dependent variable based on percentage contact time to index selective attentional responses. This study

incorporates the experimental approach of the Rydberg series of studies, but extends the approach into discrimination learning.

The above mentioned studies did not incorporate a control group in the design, therefore an investigation of the amount and direction of transfer of the mediating response was not possible. A control group is used in the current study.

Other than the cross-modal studies of Blank, Altman and Bridger (1968), Bloom and Moore (1969) and Blank and Klig (1970), which did not involve direct measurement of attentional responses, and the above Rydberg studies with graduate Ss, little or no work has been done in discrimination learning in the haptic modality.

Problem

The main aim of the present study is to investigate in a tactile discrimination task the mediating response of selective attention under the effect of overlearning. The study analyses in detail the transfer of the mediating response by incorporating into the design a control group and utilizing a direct measure of selective attention.

Additionally, the present study permits a comparison of results obtained in a discrimination task in the haptic modality with those already obtained in the visual modality.

Definition of Terms

The following terms are used throughout the thesis, and are defined as follows:

Trial - one presentation of the stimuli.

Dimension - a class of cues having a common discriminative property.

Criterion - a prescribed number of trials needed to justify saying learning has taken place.

Overlearning - a prescribed number of trials given above the criterion.

Preshift stage - all trials prior to the shift in task.

Postshift stage - all trials following the shift in task up to and including the point where learning is considered to have taken place.

Relevant dimension - a dimension whose cues are differentially correlated with reinforcement.

Irrelevant dimension - a dimension whose cues are equally correlated with reinforcement.

ID shift - a shift in which the relevant preshift dimension remains relevant in the postshift stage.

ED shift - a shift in which the relevant preshift dimension becomes a variable-within irrelevant dimension in the postshift stage.

Control shift - a shift in which the preshift dimensions become either constant within or absent in the postshift stage.

Selective attention - overt tactile dimensional specific responses measured in terms of contact time per trial.

CHAPTER II

RELATED BACKGROUND THEORY

In this chapter the main discrimination theories are reviewed, and particular emphasis is placed on those incorporating the construct of selective attention. A review of some of the criticisms of the discrimination paradigm is included.

History of Discrimination Learning

Discrimination is a term used to describe the control achieved during the process of discrimination learning. If a S has learnt to discriminate, then he responds differently to differing stimuli in a reliable way. If a learning situation consists of two discriminable stimuli, one of which is correct (S^+), and one of which is not (S^-), then in order for discrimination learning to have taken place, S must reliably respond to S^+ and avoid S^- . This learning is achieved by reinforcing a response to S^+ and not reinforcing S^- . The stimuli may be presented both at the same time (simultaneous presentation), or consecutively at each trial (successive presentation).

Although the roots of discrimination learning can be traced back to basic behaviourism (Watson, 1919), and even further, it was not until the time of Hull (1952) that discrimination ideas were synthesized into something concrete.

Hull visualized discrimination learning as the algebraic sum of reinforcement-produced excitatory and inhibitory habit strength increments. From these ideas Spence (1936) and Kendler, Basden and Bruckner (1970) further clarified the process of discrimination learning in animals. To Spence the process followed the pattern:

(1) S approaches a stimulus and is rewarded, and thus all stimulus components, positive and negative, receive an increment in their association to this approach. The positive cue is incremented directly, whilst the negative cue is incremented by an amount that is directly related to the psychophysical similarity between the two cues.

(2) The converse applies for a non-reward situation.

(3) The net tendency to approach is the summation of these increments.

(4) Given a choice, S will choose to approach the stimuli with the highest net reaction tendency, providing a threshold value has been reached. Spence's ideas have become synonymous with what has become known as the one-stage theory of discrimination learning in contrast to the two-stage or chaining theories involving the process of mediation.

The contemporary approach to discrimination learning has revolved around the mediation mechanism. Hull (1930) was the first to suggest the basic ideas of mediation with his development of the "pure stimulus act," and it was this foundation that led to the concept of the implicit response

produced cue (Miller & Dollard, 1941). The influence of gestalt psychology and the resulting exchanges on continuity and non-continuity issues further helped to crystallize the mediation concepts (Spence, 1936; Ehrenfreund, 1948; Lashley, 1938). Mediation theory forms a link between simple and complex behaviour patterns, without violating the basic assumptions of S-R reinforcement theory. A mediated response is an implicit response, made to some external stimulus, which produces stimulation, usually covert, that influences the resulting behaviour (Kendler & Kendler, 1966).

Main Discrimination Theories

Tighe and Tighe (1966) differentiate between additive and subtractive mediation theories. Additive mediation theories are those that assume that stimuli arising from response processes are added to external stimuli and thereby increase the discriminability of otherwise initially similar stimuli. The obvious example of such a mediation is the attaching of verbal labels to stimuli (Kuenne, 1946; Kendler & Kendler, 1962). Subtractive mediation theories involve processes that increase the probability that only the relevant stimuli are observed and come to control the response. This implies, in a most general way, that the mediation process operates in a selective capacity, and as Tighe and Tighe (1966) suggest "subtract irrelevant stimuli from the total stimulation." Subtractive mediation

theories include the observing response theory of Wyckoff (1952), the stimulus analysing mechanisms theory of Sutherland (1959), the acquired distinctiveness of cues theory of Lawrence (1949, 1950), the attention deficiency theory of Zeaman and House (1963), and the selective attention theory of Lovejoy (1968). The above theories are not exhaustive. For example the differentiation theory of Gibson and Gibson (1955) and Tighe and Tighe (1966) are distinct from both additive and subtractive mediation theories. The reader is referred to Fellows (1968) for additional references.

Kendler and Kendler: Verbal Mediation (Kendler & Kendler, 1962)

To the Kendlers, discrimination learning can be represented by one of two models, a single-stage S-R model or a two-stage S-r-s-R model. As already outlined, a single-stage model assumes a direct association between the stimulus and the response, where the strength of the association is determined by the algebraic sum of the increments and decrements resulting from reward and non-reward (Spence, 1936). The two-stage model assumes S makes an implicit response to a stimulus which modifies the stimulus to produce a transformed stimulus which in turn elicits behaviour (Kendler & Kendler, 1966). A reversal shift under a single-stage model would be more difficult to execute than a non-reversal shift, as a reversal shift involves the replacement of a response that had been, previously, consistently rein-

forced with a response that had been, previously, consistently extinguished (Kendler & Kendler, 1962), whilst non-reversal involves a change to stimuli that had in the pre-shift stage been reinforced fifty per cent of the time. A mediational model would predict the opposite result. In a reversal shift, the relevant dimension remains the same, and the mediated response needs only to change its overt response, but in a non-reversal shift the acquired mediator is no longer relevant and a new mediating response must be built up. Kendler and Kendler favour the view that the mediator is verbal in nature where the verbal label is related to the dimension, or cue within a dimension (Kendler, Kendler & Learnard, 1962), although they do not deny the possibility that observing responses play an important part (Kendler & Kendler, 1966; Kendler, Kendler & Sanders, 1967). The outcome of this approach is the Kendlers' hypothesis that, from the developmental point of view, a one-stage model fits the behaviour of both infrahuman Ss and children who are not verbally proficient, whilst the two-stage model is more likely to apply as the child matures and acquires the necessary verbal mediators (Kendler & Kendler, 1962).

Wyckoff: Observing Response (Wyckoff, 1952)

In general, attention theory assumes a stimulus is analyzed by learned or inherent mechanisms into its constituent parts. These analyzers vary in effectiveness, and

may operate singly or in groups. Attention theory revolves around the number and kind of analyzers operating, and the relative effectiveness of each. Wyckoff proposed the idea of the observing response as an analyzer, where the observing response refers to any response which results in the S being exposed to the discriminative stimuli, whether the response be an attending, orienting, perceiving or sensory organizational one (Wyckoff, 1952). Wyckoff's approach is what Trabasso and Bower (1968) term the "one-look model," because the major interest is on the analyzer and the probability of its being selected. Wyckoff (1952) assumes that the probability of the occurrence of an observing response will increase or decrease under conditions of secondary reinforcement and non-reinforcement, and that when a discrimination has been established and then a reversal shift is performed, the probability of the observing response will decrease temporarily and then recover. Wyckoff's contribution of the concept of the observing response remains a highly relevant one, although most of what he had to say about the discrimination process has been incorporated into more sophisticated discrimination behaviour models such as the multiple-look model of Trabasso and Bower (1968) and the selective attention model of Lovejoy (1968).

Goodwin-Lawrence: Acquired Distinctiveness of Cues
(Lawrence, 1949, 1950; Goodwin & Lawrence, 1955)

Lawrence (1949, 1950) showed that if animals used certain stimuli for the solution of a problem, they tended

to use the same cues to solve a new problem. This phenomenon he called acquired distinctiveness of cues. Goodwin and Lawrence (1955) introduced a similar concept to Wyckoff's observing response to account for this phenomenon in human discrimination. In the discrimination process, S tries out different coding operations which may or may not be of similar initial strength, resulting in the stimulus-as-coded (sac) response. The sac controls the instrumental response made on any trial, and the outcome of the trial influences the associative connection of the sac used in that trial. The differential learning rates of the two operations give predictable outcomes for the discrimination process which are similar to those obtained by the use of the Sutherland-Mackintosh theory.

Sutherland-Mackintosh: Stimulus Analysing Mechanisms
(Sutherland, 1959; Mackintosh, 1962, 1964)

In many ways similar to the previous theory, the Sutherland-Mackintosh theory proposes a two-stage process in discrimination learning. Using similar notions to Broadbent's filtering processes, Sutherland introduced the idea of a stimulus analyzer as a selective mechanism. The first stage of the discrimination process is to learn to switch in the appropriate stimulus analyzer, and the second stage entails the attaching of the appropriate response from this analysis to the output, mostly through the effects of reinforcement. In later revisions of the theory, Mackintosh (1970) suggests that more than one analyzer can be switched

in at one time and at differing intensities, the intensity being governed by the acceptability of the mediated outcome. The more strongly one analyzer is switched in, the less strongly others will be (Inverse hypothesis). This model, like the previous one of Goodwin and Lawrence, assumes a differential acquisition and extinction rate for the two stages. Learning which analyzer to switch in is a comparatively slow one and not easily extinguished, whilst learning which response to connect to which analyzer occurs quickly but is easily extinguished. Based on these analyzer concepts, Lovejoy (1968) formulated his selective attention concepts, but, as we shall see, built into his model one stage that was not accounted for in the Sutherland-Mackintosh model and that specifically accommodates the possibility of perceptual learning.

Zeaman-House: Attention Deficiency (Zeaman & House, 1963)

The Zeaman-House theory is identical to the Goodwin-Lawrence theory except that in the Zeaman-House theory the word attention is substituted for identification of a dimension, where attention to Zeaman and House is in the form of a dimensional observing response. The second stage of the process is that of acquiring a response to the relevant cue by a process of instrumental conditioning. If the correct observing response is made and is followed by the correct instrumental response, then the instrumental response and the observing response are strengthened by

increments proportional to their complements. If the correct observing response is made and is followed by an incorrect instrumental response, then the instrumental response and the observing response are weakened by decrements proportional to their magnitude. When a relevant observing response is made and is followed by a response which ends in non-reward, the probabilities of all non-elicited observing responses gain a fraction of the probability lost by the initial observing response. Similarly, if the irrelevant observing response is followed by an instrumental response which is rewarded, then the probability of the relevant observing response is decreased. If the observing response is to the correct dimension the probability of reward for the instrumental response is 100% or 0%; however, if the observing response is to an irrelevant dimension, then the probability of reward is one half. The probability of making a correct instrumental response is increased in both cases as the probability of making an incorrect instrumental response followed by non-reward gives an increase in the probability of making a correct instrumental response. From these remarks it can be seen that the probability of making a correct instrumental response is never decreased directly or indirectly, but the probability of making a correct observing response is changed each trial. Thus the probability of making a relevant observing response will approach unity more slowly than the probability of making a correct instrumental response. Zeaman and House,

through an analysis of learning curves, suggest that differences in learning a discrimination task are dependent upon the length of the initial flat portion of the learning curve rather than the rate of learning. They suggest that the length of the flat portion of the learning curve is reflected in the time it takes the S to attend to the relevant dimension. According to Zeaman and House (1963), retardate Ss are deficient in this attentional attribute.

Lovejoy: Selective Attention (Lovejoy, 1965, 1966, 1968)

Lovejoy has formulated a number of mathematical models of discrimination learning involving selective attention in which selective attention is viewed not as a unitary process, but rather as two processes occurring simultaneously, those of selective control and selective learning. Selective control, or the probability of being controlled by a single cue, is dependent jointly upon the distinctiveness of that cue, and the strength of S's opinion about that cue. This combination Lovejoy calls the control strength of a cue, which is, therefore, defined as a function of the distinctiveness of the cue and the response strength, where the value of the response strength is defined as lying between the value of 0 and 1 and is a measure of S's preference for one stimulus over the other. Thus, the control strength of each cue having been defined, the probability of being controlled by a specific cue is the proportion that cue has of the total cue control strength. This process is the

selective control aspect of attention.

As control by a single cue is dependent partly on response strength and partly upon distinctiveness, it is necessary to show how these response strengths change in value with experience, or how learning takes place. The S need not always learn exclusively about the cue that controls behaviour. However, if this non-control cue learning takes place, it is necessary to postulate a probability memory parameter (learning selector) which allows the S to remember which cue was used in control and to learn about that cue. If this parameter equals one, then S always learns about the cue that controls behaviour, and complete non-continuity learning occurs. If the parameter equals zero, then no learning about the controlling cue takes place, and for intermediate values of the parameter a weighted mixture of the two previous positions takes place. This process is what Lovejoy calls selective learning, or the choice of a dimension about which to learn.

The distinctiveness of a stimulus is a factor which influences the probability of control by a stimulus (selective control) and the probability of learning about the stimulus (selective learning). The process by which the value of the distinctiveness can change through prior experience is based on the assumption that each cue has a fixed, unmodifiable base-level distinctiveness which is dependent upon the stimulus itself and the sensory system of the S. A further assumption is made that there is one

unit of changeable distinctiveness which is directable as a result of prior experiences. Thus, the effective distinctiveness of a particular cue at any trial is made up of the sum of its base-level distinctiveness and its momentary share of the directable distinctiveness. Lovejoy assumes that the S will tend to build up distinctiveness on those cues which the S uses successfully, or those cues on which the S obtains reward.

More specifically, it will be assumed that when an animal uses a cue and ... remembers which cue he used, then he will modify the distribution of directiveness. If he is rewarded, he will increase the directable distinctiveness of the cue he used, approaching a limit where all the directable distinctiveness is assigned to that cue. If he is not rewarded, it will be assumed that he modifies the distribution of directable distinctiveness so as to bring it closer to the starting distribution. Such a rule implies that a long run of extinction trials will tend to remove the effects of earlier training, returning the animal towards his naive state. (Lovejoy, 1968, p. 61).

It would appear that the Lovejoy model incorporates all the facets of discrimination attention models so far advanced, together with some reasonable concepts not previously considered. In terms of a discrimination shift paradigm, both the Zeaman and House model and the Lovejoy model predict similar outcomes.

Differentiation Theory

In the theories just outlined, the emphasis is placed on the mediators, with the stimuli reduced to a secondary role. Differentiation theory places the emphasis on the

stimulus patterns themselves, and views these as the primary determiners of discrimination behaviour. Whereas discrimination learning based on mediating theories assumes S perceives the differential between stimuli at the outset of the discrimination, differential theory assumes that the final discrimination behaviour is not necessarily based on initial noticeable differences, but that S learns by detecting and utilizing differential stimuli which are present in the discrimination task itself. The consequence is that the individual differences in discrimination behaviour are the result of differences in the nature of the discriminative stimuli, and are developmental in nature depending upon the opportunities for perceptual learning the S has had (Tighe & Tighe, 1966). The ease of learning a reversal shift from a differentiation theory viewpoint is dependent upon S's ability to isolate and utilize the invariant properties of the stimuli (Gibson & Gibson, 1955). Young children at a low level of perceptual training respond to the stimuli as "undifferentiated wholes" (Tighe & Tighe, 1968a), whilst more sophisticated Ss respond to a relevant dimension. Older Ss, therefore, are predicted to find a reversal shift easier than an ED shift as the isolated dimension remains relevant in the reversal shift, whilst in the ED shift S must isolate out the former irrelevant dimension. Young Ss, on the other hand, have to change two relationships in the reversal shift but only one relationship in the ED shift. Pretraining, and presumably over-

training, in differentiation theory, results in an increasing sensitivity to stimuli or an increase in the attention to the distinguishing features of the discrimination paradigm (Tighe & Tighe, 1965, 1968b).

Related Selective Attention Theories

Turrisi (1970) suggests that selective attention is a "rubric for many interacting mechanisms rather than a unitary process." The diversity of interpretation of the construct of selective attention throughout psychological literature bears this out. As pointed out by Trabasso and Bower (1968), attention theory has resolved itself into the three major experimental domains of discrimination learning, neurophysiological research and information processing. These three areas will not be reviewed in detail, but one or two of the more important points will be emphasized in order to see attention theory in discrimination learning from a wider angle.

Selective attention in discrimination learning has already been extensively covered elsewhere by the review of the work of Zeaman and House, Lovejoy, Lawrence, Mackintosh and the Kendlers. In addition to this review, it would be profitable to distinguish the relationship between observing or orienting responses and the orientation response, and their link with the construct of attention.

The observing response, as originally advanced by Spence (1940) and Wyckoff (1952) was clearly a peripheral

response, and in the case of Spence resulted from the continuity-non-continuity controversy as outlined elsewhere (p. 30). Spence concedes that S in order to discriminate must "learn to orient and fixate its head and eyes so as to receive the critical stimuli (Spence, 1940)." Wyckoff defined the observing response as "any response which results in exposure to the pair of discriminating stimuli involved (Wyckoff, 1952)," and hypothesized that the observing response was conditionable. The psychological Zeitgeist has, however, relegated the observing response of Spence (1940) and Wyckoff (1952) to a secondary position because of its peripheral connotations (Trabasso & Bower, 1968; Mostofsky, 1970). Eimas (1970) points out that the observing response as used in the Zeaman and House model was intended by Zeaman and House to be an attentional response which was central and selective. The Zeaman and House studies showing the effect of novelty on the observing response bear this out.

The orientation response is an outgrowth of the observing response. The Russians, starting from the "orientational reflex" of Pavlov, developed a range of psychophysiological measures which collectively came to be known as the orientation response, and which, for some Soviet psychologists, became synonymous with the construct of attention (Zaporozhets, 1961). One of the motor components of the orientation response is the turning or orienting of the head. The orientation response is then a complex

of events which,

increases the organism's capacity to extract information from the environment and prepares the organisms to act rapidly and vigorously which a novel stimulus might well require. (Berlyne, 1960, p. 178).

Research in the field of neurophysiology suggests that selective attention can be identified with the inhibitory influences on afferent impulses carried out at various points in the sensory pathways (Hernández-Peón, 1966). Studies in this area have indicated that suppression of stimuli in one modality takes place whilst stimuli from another are receiving attention. This blocking at the peripheral level links with the work of the information processing theorists such as Broadbent (1957) who advances the concept of selective filtering, where the unwanted stimuli are rejected before a complete analysis of all the stimuli takes place. Thus the information content of the message determines the selective attention of the S. Deutsch and Deutsch (1963) favour the view that all stimulus inputs are analyzed and the selection is made after the analysis, whilst Treisman talks of "attenuation of irrelevant messages rather than complete rejection (Treisman & Geffen, 1967)." For Berlyne (1970), attentional behaviour is of two kinds, intensive and selective. The intensive aspect is the amount of attention being given to the stimulus as a whole, and the selective aspect is the way in which the attention is divided among the individual stimuli. Furthermore, selective attention for Berlyne

(1970) has three divisions: attention in performance, attention in learning, and attention in remembering.

The construct of attention can be seen to have many facets. Berlyne (1970) commenting on this aspect says,

If, from the outset of our research we cavalierly regard a multiplicity of phenomena as manifestations of some unitary process called 'attention', we are asking to be led astray by unfounded assumptions (p. 29).

Turrisi (1970), on the other hand, defines selective attention as,

any or all of the mechanisms which an organism uses to respond to those aspects of the environment which are important... These mechanisms may range from gross, peripheral, receptor-orienting responses, through more central, perceptual processes, still more central information-processing systems, possibly, in some cases, to the semantic and/or sy(n)tactic components of the language system itself (p. 4).

The multidimensional nature of the attention construct has prompted many theorists to drop the term attention altogether, and to define it operationally for the research study in question.

Discrimination Shift Paradigms

In all studies involving discrimination learning, the choice of paradigm is crucial. A discrimination paradigm is devised to test a particular theory or a particular transfer of learning, but it also often, inadvertently, creates further theoretical confounding. Shepp and Turrisi (1967) point out, having analyzed many shift paradigms, that some paradigms classified as alike are sometimes opera-

tionally quite different, and need not produce the same empirical results. Slamecka (1968) advances the same line of argument in an important paper on the methodology of discrimination learning where he outlines five sources of bias that are likely to confound the data obtained from shift-paradigm results. These sources of bias are: intermittent reinforcement, shift detection, obviousness of solution, stimulus novelty and negative transfer. A brief review of these biases will be given.

Intermittent reinforcement is a bias that operated in the original paradigm as used by Buss (1953) and Kendler and D'Amato (1955). This bias hinders the execution of a non-reversal shift because of fortuitous intermittent reinforcement of preshift relevant dimensions during the postshift stage. This intermittent reinforcement could give reversal learning an advantage over non-reversal learning.

Because of the natural development of discrimination learning from infrahuman to human subjects, there has been an unavoidable tendency to keep Ss ignorant of the point at which the shift takes place. The detection of the point is easier in the reversal shift than the non-reversal shift because in the reversal shift every postshift response based on preshift learning is incorrect, whilst in the non-reversal shift only one half of the postshift responses based on preshift learning are correct. This is called differential opportunity for detection. Informing S when the shift was to take place would, according to Slamecka, equa-

lize the opportunity for detection. A further method of equalization would be to employ completely new stimuli in the postshift stage.

Closely linked with the bias of shift detection is the bias of differential obviousness of postshift solutions. Slamecka argues that at the onset of a reversal shift, S, suddenly encountering an unbroken sequence of non-reinforcements, is alerted that a shift has taken place, and automatically reverses his choices, and is able to do so without remembering any features of the preceding shift stimulus. In the ED shift, however, there is no regular sequence of non-reinforcements, and no cues are given as to the correct responses required. Shift obviousness tends to favour a more rapid acquisition of reversal shift than a non-reversal shift.

The fourth bias listed by Slamecka is the differential consequences of partial stimulus novelty. The effect of preferential attention resulting from stimulus preference of the S is well established (Imai & Garner, 1965; James et al., 1969; Suchman & Trabasso, 1966; Trabasso, Stave & Eichberg, 1969; White & Johnson, 1968). The concern here is with the differential attention resulting from the nature of the construction of the discrimination task. In the partial change task (Harrow & Friedman, 1958), new stimuli are introduced at the time of the shift on the irrelevant dimension in the ED shift and on the irrelevant dimension in the reversal shift. In the ID shift introduced by

Isaacs and Duncan (1962), the new dimensions are introduced on the relevant dimension. The resulting novel stimulus would hinder performance in the ED shift and reversal shift, but would attract correct responses in the ID shift.

Slamecka cites differential transfer of sorting responses as the final bias. The reversal paradigm has inherent a negative instrumental response transfer of unknown magnitude operating at the same time as a positive mediating transfer. With this particular paradigm there is no experimental way of eliminating the inhibiting effect of the negative transfer, and thus the execution of the reversal shift would be inhibited.

Slamecka concludes that the shift paradigm is free of all the above biases only when the reversal shift is eliminated and both the ID and ED groups have in the post-shift stage completely new values, preferably symbolic in nature, on all dimensions. Much of the research done prior to the Slamecka paper failed to take account of these influencing factors, and therefore care must be taken when comparing the results based on different experimental paradigms. Slamecka's discussion of the biasing factors in discrimination paradigms has been dealt with in detail in order that the reader may understand the complexity of the experimental designs in discrimination learning studies.

This chapter has attempted to place discrimination learning in context, by reviewing the main discrimination

theories, in particular those incorporating the construct of selective attention. Also, by highlighting the wider approach to selective attention, it has tried to show the interrelationship between these various theories. Finally the chapter has reviewed the weaknesses of discrimination shift paradigms.

CHAPTER III

REVIEW OF RELATED LITERATURE

This chapter reviews the research of overlearning in discrimination learning by looking at the continuity-non-continuity problem in animal discrimination learning and the resulting carry-over into human discrimination learning. A review of pertinent overlearning studies with children is given and from this discussion the experimental hypotheses are developed.

For the purpose of this thesis, overlearning (OL) was defined as any number of additional trials given above the number needed to justify saying S had learned the discrimination concept. The criterion of learning has varied from study to study, but is usually within the range of six to ten correct responses.

Two aspects of overlearning will be considered (a) OL and its effect on the reversal shift, resulting in the overlearning reversal effect, and (b) OL and the effect on intra- and extradimensional shifts.

Overlearning Reversal Effect

The overlearning reversal effect (ORE) was a natural outcome of the continuity-non-continuity (C-NC) controversy, and to place the ORE in context it is necessary to note the basic differences between the C-NC positions.

The origins of the C-NC controversy lie in animal discrimination learning (Riley, 1968), and the emphasis or non-emphasis on peripheralism. The continuity theory assumes that all stimuli impinging on the senses become associated with the response to a varying degree (Spence, 1936), whilst the non-continuity theory implies the selective nature of the observer's role (Lashley, 1929; Krechevsky, 1938; Ehrenfreund, 1948). Basic to the Lashley-Krechevsky original position is that the behaviour of the animal is related to the stimulus complex, and that the animal tries differing "hypotheses" until an insightful behaviour pattern is manifested. Furthermore, the non-continuity position would suggest that, during learning, more than just the attaching of responses to the positive and negative stimuli takes place. There is some general factor learned which is used in other circumstances of discrimination learning, and which facilitates the transfer of training from one situation to another.

Attacks on the continuity position such as Harlow's learning set (1959) and Lawrence's acquired distinctiveness of cues (1949, 1950) gathered strength when Reid (1953) demonstrated with rats that, after reaching a criterion on a discrimination task, overlearning facilitated the acquisition of a reversal shift; thus identifying the ORE. The continuity position predicts that the number of trials needed to reach criterion in the postshift stage of a reversal shift, after OL in the preshift stage, is greater and

not fewer as Reid advanced, for the OL increases the habit strength, and hence there is a greater resistance to extinction. As reversal learning involves extinguishing old reinforced habits and learning the opposite ones, the stronger the habit strength, the more postshift trials are needed to make the shift.

The continuity defendants advanced a variety of explanations to explain the ORE, such as the possible creation of frustration tendencies which aid extinction (Birch, Ison & Sperling, 1960; Amsel, 1962), and the non-practice hypothesis (D'Amato & Jagoda, 1961), where the inhibition acquired from the negative cue during OL is considered to be reduced because of the constant approach to the positive cue during OL.

In contrast to these habit strength explanations, non-continuity theorists proposed the attention hypothesis (Mackintosh, 1962, 1964). Lovejoy (1968) was the first to present a mathematical model of attention theory which among other things simulated the ORE using stat-rats. The stat-rats method programmes the computer to produce sample responses for a discrimination learning task based on the assumptions implicit in the model. Lovejoy's selective attention theory has already been reviewed (p. 17). The basic prediction in the model is that the probability of the attentional response reaching an asymptote is less than the probability that the instrumental response does so. Animals that have been overtrained will continue to attend

to the relevant attribute after reversal, i.e., show perseverative errors with fewer irrelevant cue responses, thus allowing the incorrect responses in the reversal phase to be extinguished and the new correct instrumental responses formulated more quickly. With learning to criterion only, the animal quickly ceases to attend to the previous relevant, but now non-reinforced, dimension, and attends to other dimensions, thereby preventing the extinction of old responses and acquisition of new ones.

Overlearning Reversal Effect in Children

After placing the ORE in perspective as far as animal discrimination learning is concerned, the next stage is to analyze the ORE as exemplified in human learning. Eight studies using children as Ss have upheld the ORE (Marsh, 1964; Youniss & Furth, 1964; Furth & Youniss, 1964; Sugimura, 1965; Cross & Tyler, 1966; Eimas, 1966b; Heal, 1966; Eimas, 1969). Six studies using children have not upheld the ORE, i.e., have not shown any facilitation of learning in the postshift stage (Stevenson & Zigler, 1957; Stevenson & Weir, 1959; Gollin, 1964; Tighe & Tighe, 1965; Tempone, Capehart, Atwood & Golding, 1966; Eimas, 1966b, Exp. 2).

In the study of Eimas (1966b) with kindergarten Ss, a negative effect on the number of trials to criterion in the postshift stage after OL was obtained. Eimas concluded from his results that the ORE is not apparent when

the S is trained on a prepotent or perceptually dominant dimension, for in such a case the OL does little or nothing to strengthen the attending response as the attentional mediator is almost at asymptotic value before the OL begins. Thus the OL merely increases the strength of the instrumental response, and thus retards reversal learning. Eimas suggests that for young children position is a predominant dimension and thus accounts for his non-ORE finding with kindergarten children when using a position-type paradigm. In a later study by Eimas (1969) with third-grade Ss on a successive discrimination task, Eimas found OL upheld the ORE, and did so in a manner that confirmed predictions from attentional models of learning.

As Wolff (1967) points out, many of these results are in striking conflict, and there is a great deal of confounding of results because of such factors as nature of the transfer dimension (position or visual), age of S, and the type of paradigm used in the study.

Overlearning and Intra- and Extradimensional Shifts

Studies dealing with the effect of OL on ID or ED shifts will not be reviewed individually. Only those studies involving children which show the comparative effect of OL on ID and ED shifts will be examined. Wolff (1967) gives a thorough review of individual studies, and concludes that there is much confounding of results by the factors of age, intelligence and paradigm used. Furth and Youniss

(1964) using 64 second- and third-grade children in a successive discrimination task showed superiority of ID learning over ED learning at both levels of OL, but no interaction between shift and OL. However, because of the type of paradigm used, these results are hardly comparable with other studies in this area. Eimas (1966a) with 5- to 7-year-old children, using a paradigm that involved a total change design at the shift level, showed that both ID and ED shifts were facilitated by OL. The establishment in the training period of a learning set which could have given positive transfer to the ED shift is possible, but no control group was used to measure this possibility. The fact that the study dropped several Ss, together with the fact that there was a difference in ease of original learning in two of the ED groups, could have influenced the resulting ED transfer.

Shepp and Turrisi (1969) working with retardate Ss showed that ID shifts became progressively easier and ED shifts became progressively harder with each level of OL. No control group was incorporated in the study.

Brown (1970), in a study involving second grade and kindergarten Ss, found with fifty OL trials on an oddity type shift that both ID and ED shift performances were facilitated with the older Ss. Brown interpreted her results in terms of an attentional model; however, as an oddity problem is a complex discrimination task, additional processes may be involved.

The study of Eimas (1969) with third-grade Ss, and the series of Rydberg studies (Rydberg, 1969; Rydberg & Arnberg, 1969a; Rydberg & Arnberg, 1969b; Rydberg, Kashdan & Trabasso, 1966) with graduate student Ss were designed to investigate directly the underlying mediation processes involved in discrimination learning. The Eimas design allowed the discrimination process to be analyzed in terms of both observing and instrumental responses. The study showed that OL did facilitate reversal learning and did so by reducing the number of observing responses to irrelevant dimensions and decreasing the number of mid-reversal errors. OL also reduced the number of instrumental shifts and increased the number of perseverative errors. These observations fitted well the available attentional models of discrimination learning. The Rydberg studies allowed a direct measure of selective attention to spatially separate tactile stimuli by recording direct observations of each overt tactile observing response. In their method of measuring observing responses it is unlikely that the observing responses are influenced by verbal cues. They found that relative relevant touching increased before the criterion period (the increase taking place in the trial of last error). After extinction began, relative touching fell to chance, and the mean percentage relative observing responses increased during OL.

From the above review, certain conclusions can be drawn.

(1) There is conflicting evidence that the ORE occurs.

(2) There is evidence that OL facilitates intradimensional shift performance but not extradimensional shift performances under certain conditions.

(3) It is evident that much of the research is confounded by paradigm and age factors.

(4) The level of experimentation in discrimination learning has now reached the stage where new methods need to be devised in order to be able to examine in more detail the underlying processes in discrimination learning.

(5) There is much evidence indicating that the mediating response is attentional in nature.

The present study investigates selective attentional responses under the effect of overlearning. An index of selective attention is recorded by tactile observing responses measured in terms of percentage dimensional touching time per trial.

Summary of Theory and Resulting Experimental Hypotheses

The Zeaman and House model and Lovejoy model predict similar mediating processes and overlearning effects.

During a discrimination concept shift task, dimensional-specific responses are built up in the preshift stage, and are subsequently transferred to the postshift stage. In the ID group, the relevant preshift dimension remains relevant in the postshift stage which results in a

positive transfer of the mediating response. In the ED group, the relevant preshift dimension becomes irrelevant in the postshift phase which results in a negative transfer of the mediating response. In the control group, as the dimensions in the postshift stage are different from those in the preshift stage, there is no transfer of the preshift mediating response into the postshift stage. With increasing amounts of overlearning, the mediating response is strengthened. In the ID group, with each level of overlearning, there is an increased positive transfer of the mediating response. In the ED group, with each level of overlearning, there is an increased negative transfer of the mediating response. In the control group there is no transfer of the mediating response with each level of overlearning.

The amount of transfer, and the nature of these mediated responses in the three shift groups, at the two levels of learning, can be inferred from the choice responses made in the postshift stage. The direction of the transfer in the ID and ED groups at each level of overlearning can be inferred from examining the transfer in these groups relative to the transfer in the control group.

Hypothesis 1

At both levels of learning, the mean number of trials taken to criterion in the postshift stage in the intradimensional group will be fewer than the mean number of trials taken to criterion in the control group which in turn will be fewer than the mean number of trials taken to criterion in the extradimensional group, and the mean number of

trials in the control group will be the average of the mean number of trials in the intra- and extradimensional groups.

A further method of examining the mediating response is a graphical one. Backward learning curves (Hayes, 1953) can be drawn for each level of learning. These graphs of the percentage of correct instrumental responses per trial are predicted to show increasing presolution plateau lengths in the ED groups, decreasing presolution plateau lengths in the ID groups, and no difference in the lengths of the presolution plateaus in the C groups at the two successive levels of learning.

Dimensional attentional responses are reflected in the tactile explorations of the S. The attentional response strength is established in the preshift stage. Any changes in the attentional response strength occurring during the preshift stage may be inferred from changes in the tactile exploration of the S. In the trials immediately following the shift, the probability of attending to the preshift relevant dimension increases to asymptote or remains relatively constant at asymptote in the ID groups, and decreases in the ED groups as the probability of attending to the new relevant dimension is established. In each case the instrumental response strength rises from chance to asymptote. The preshift relevant dimension has no influence on the performance of Ss in the control groups at the postshift stage. A new relevant postshift attentional response is established for the control Ss.

CHAPTER IV

METHODS AND PROCEDURES

Sample

Forty-eight male and forty-eight female subjects were used in the study. They were randomly drawn from 113 Grade III students at Braemar Public School in the City of Edmonton Public School system. The school draws from an area of average socio-economic population status. The mean chronological age at the time of testing was 103.5 months. One subject was excluded for failing to reach criterion in the overlearning group and five subjects who failed to reach criterion in the criterion group were trained and then included (cf. p. 53).

Paradigm Design

In deciding upon the design of the paradigm to be used in this study, three considerations had to be made.

First, the paradigm had to avoid as far as possible the bias factors, detailed by Slamecka, (see page 25). A paradigm was used incorporating a total change in stimuli in the postshift stage which eliminates the transfer of instrumental response strength and allows an unbiased assessment of the transfer of the mediating response strength. This paradigm still does not eliminate the influence of stimulus generalization, that is, the tendency to respond

to all stimuli lying on the same physical continuum as the original training stimulus; however, as pointed out by Slamecka (1968, p. 437), "the justification for postulating such a mechanism has been seriously questioned from time to time as in the paper by Prokasy and Hall (1963)."

Secondly, the paradigm had to incorporate a control in order that an assessment could be made of the nonspecific transfer effect and hence the amount and direction of the mediating responses. As pointed out earlier, few studies have incorporated a control group. The control stimuli in the preshift stage had to be on dimensions which were either constant within or absent during the postshift stage.

Finally, the stimuli had to be such that dimensional responses could be recorded directly. This necessitates a certain amount of separation of the dimensions, while keeping the design compatible with the paradigms used in previous studies.

In the experimental preshift stage two values of the dimension form (square and circle), and two values of the dimension texture (A and B) were used. In the control preshift stage two values of position (horizontal and vertical) and two values of size (large and small) were used. In the postshift stage, in both the experimental and control groups, two values of form (triangle and cross) and two values of texture (C and D) were used. The values of the relevant dimensions in the preshift control group became constant within in the postshift experimental and control groups, and

the relevant dimensions in the experimental preshift groups were constant within in the preshift control groups. For example, in the control preshift groups, the dimensions of orientation and size had an equal representation using circles and squares presented an equal number of times on two samples of texture A and two samples of texture B respectively.

Experimental Design

The experimental design used in this study was a fully factorial design. In the preshift stage there were three levels of shift (ID, ED, and control), two levels of learning (criterion and overlearning), and sex. In the postshift stage there were three levels of shift (ID, ED, and control), two levels of learning (criterion and overlearning), two levels of relevant dimension (form and texture) and sex. Within each of these six learning-shift groups one half of the Ss were trained on form and one half on texture in the experimental preshift groups, and one half on size and one half on orientation in the control preshift groups. Within each of these dimension-groups, there was an equal number of male and female subjects. Within sex groups, Ss were assigned randomly as they presented themselves for testing. Use of this type of design allows error variation due to dimensional preferences and sex differences to be reduced. Stimulus preferences in the visual modality have been found with the dimensions of

shape and colour (Lee, 1965; Corah, 1966; Suchmann & Trabasso, 1966). Tighe and Tighe (1966) reported Ss trained on a preferential dimension made more reversals than non-reversals in an optional shift task (Kendler & Kendler, 1962). Suchmann and Trabasso (1966) found, also, that dimensional preferences facilitated learning when the preferential dimension was relevant. In the haptic modality Gliner et al. (1969) found that kindergarten Ss learned a discrimination task on a basis of texture whilst third grade Ss learned the task on a basis of shape. There are two ways of attempting to control dimensional preferences. One is to obtain each S's dimensional preference and train him on the non-preferred dimension; however, Tighe and Tighe (1968) suggest preference tasks may "not only reveal selective responses to aspects of the stimulus situation but also in-state or augment such selective responses." The second method, as used in this study, is to counter-balance the training dimensions across Ss.

In summary, there were four male and four female subjects within each level of dimension giving sixteen Ss in each cell. For future reference these cells will be labelled as follows: criterion intradimensional (ID-crit.), criterion extradimensional (ED-crit.), criterion control (cont.-crit.), overlearning intradimensional (ID-OL), overlearning extradimensional (ED-OL), overlearning control (cont.-OL).

Description of Apparatus

Stimulus Blocks and Plates

The stimuli were three dimensional plastic forms (2" x 2" x 1") with conductive metal plates cemented to the upper surface of each form. A male jack was screwed into the base of the plastic form to give contact with the metal plate on the surface of the form. The male jack, when inserted through the textured plate, plugged into the female jack on the underside of the discrimination box, establishing two entirely separate electrical circuits - one from the dimension form and one from the dimension texture. Figure 1 shows form square and the texture A. The textured plates, five inches by seven inches in size, were made from 1/4" 6061 T6 aluminum. The four textures used were obtained by milling the aluminum plates using a 3/8" and 1/4" ball and mill until four distinct textures were produced.

Discrimination Box

The discrimination box used in this study was designed and built by the author. The stimulus forms and textures, separated by a dividing ledge, were housed in the box as shown in Figure 2. A detachable curtain made of elasticized cloth covered the opening. A metal ring was fastened at the centre of the curtain which allowed the S's finger to make contact with the stimuli. The elastic curtain afforded freedom of movement of the hand. When the S's

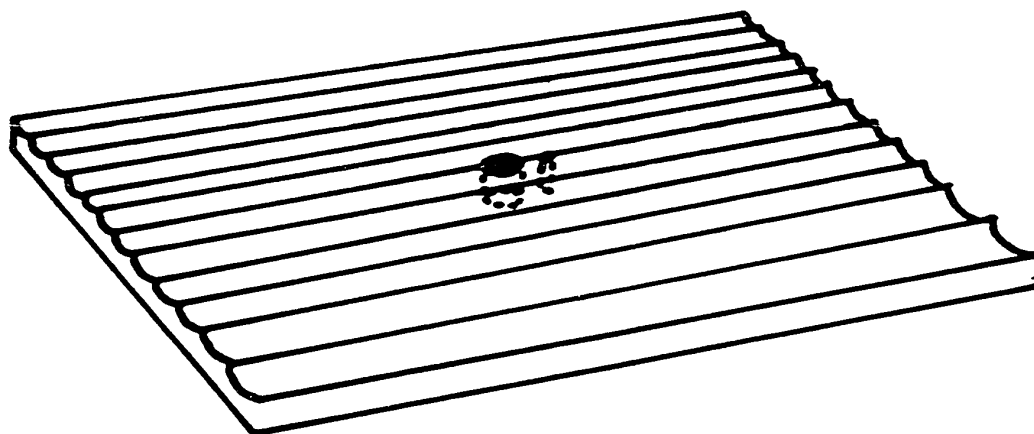
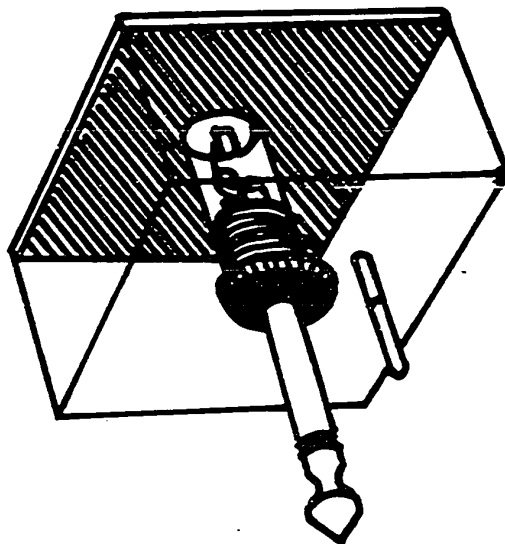

Fig. 1. Form Square and Texture A

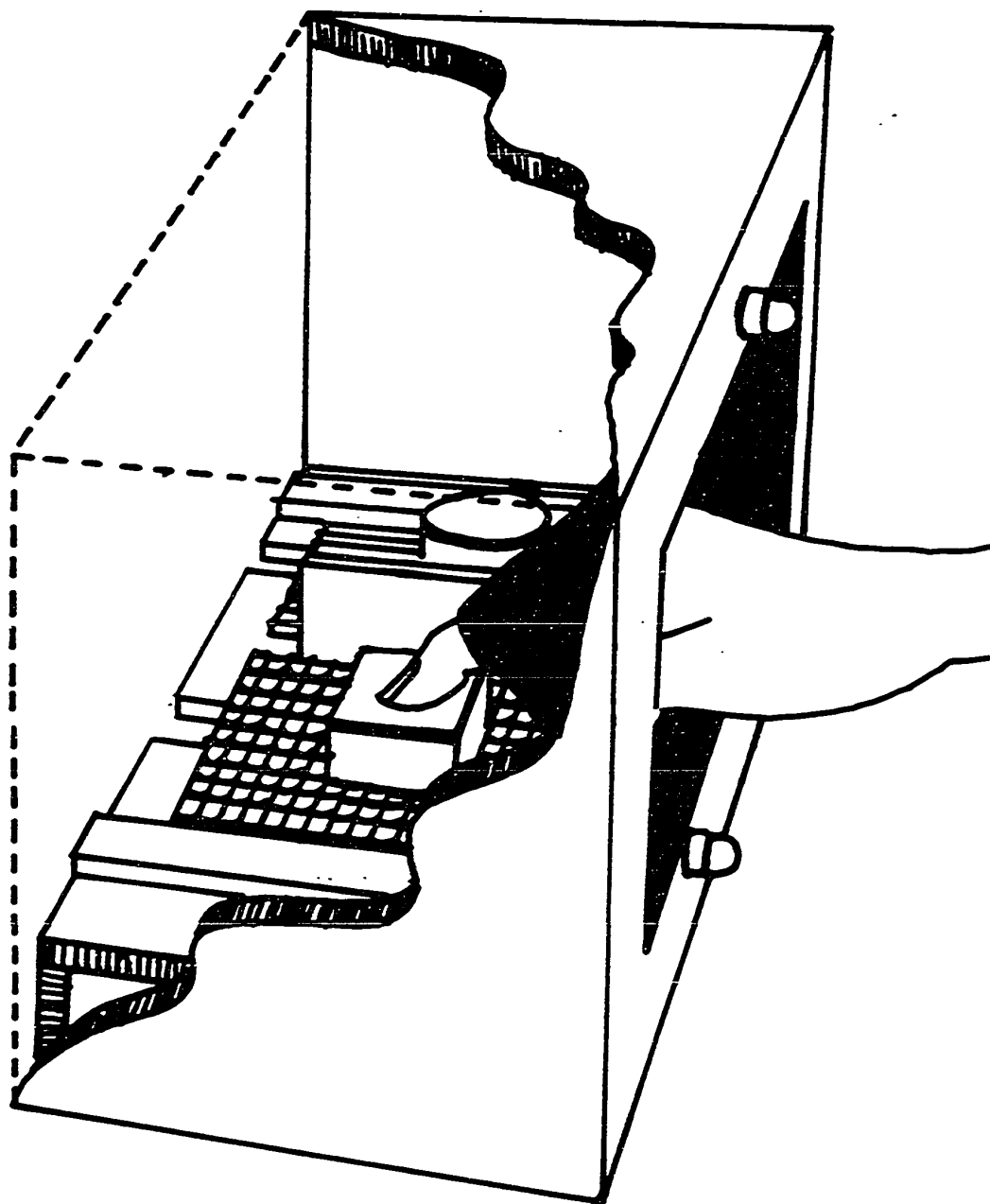

Fig. 2. Discrimination Box

finger touched the stimulus, a relay was closed by body capacitance, which in turn deflected a pen on a six-track Lafayette ink recorder. When the S's finger was removed, the pen returned to its baseline. To make a choice response, the S pointed to the chosen stimulus. The E then activated a micro-switch situated immediately above the chosen stimulus, which in turn recorded the event on the recorder, and, if correct, activated a green light, situated on the front of the box, for a duration of ten seconds. At the same moment as the light came on, a candy-dispenser deposited a smartie into a plastic bag placed at the side of the box but in full sight of the S. When the response was incorrect, S heard only the click of the micro-switch. The position of the correct exemplar changed from trial to trial (see p. 51), therefore the light and dispenser electric circuit was pre-programmed by the E for each trial. An electrical circuit diagram is given in Figure 3.

A typical output from the pen-and-ink-recorder is given in Figure 4. The first four tracks are, in order, recordings of the touching time to left form, right form, left texture and right texture. Tracks E and F give the S's choice, either left or right, for each trial. At the end of each trial, that is after recording the S's choice response, E activated all pens simultaneously. The resulting line on the output sheet separates the trial recordings. The recorder ran at a speed of six inches per minute, so that each small square on the output represents a time

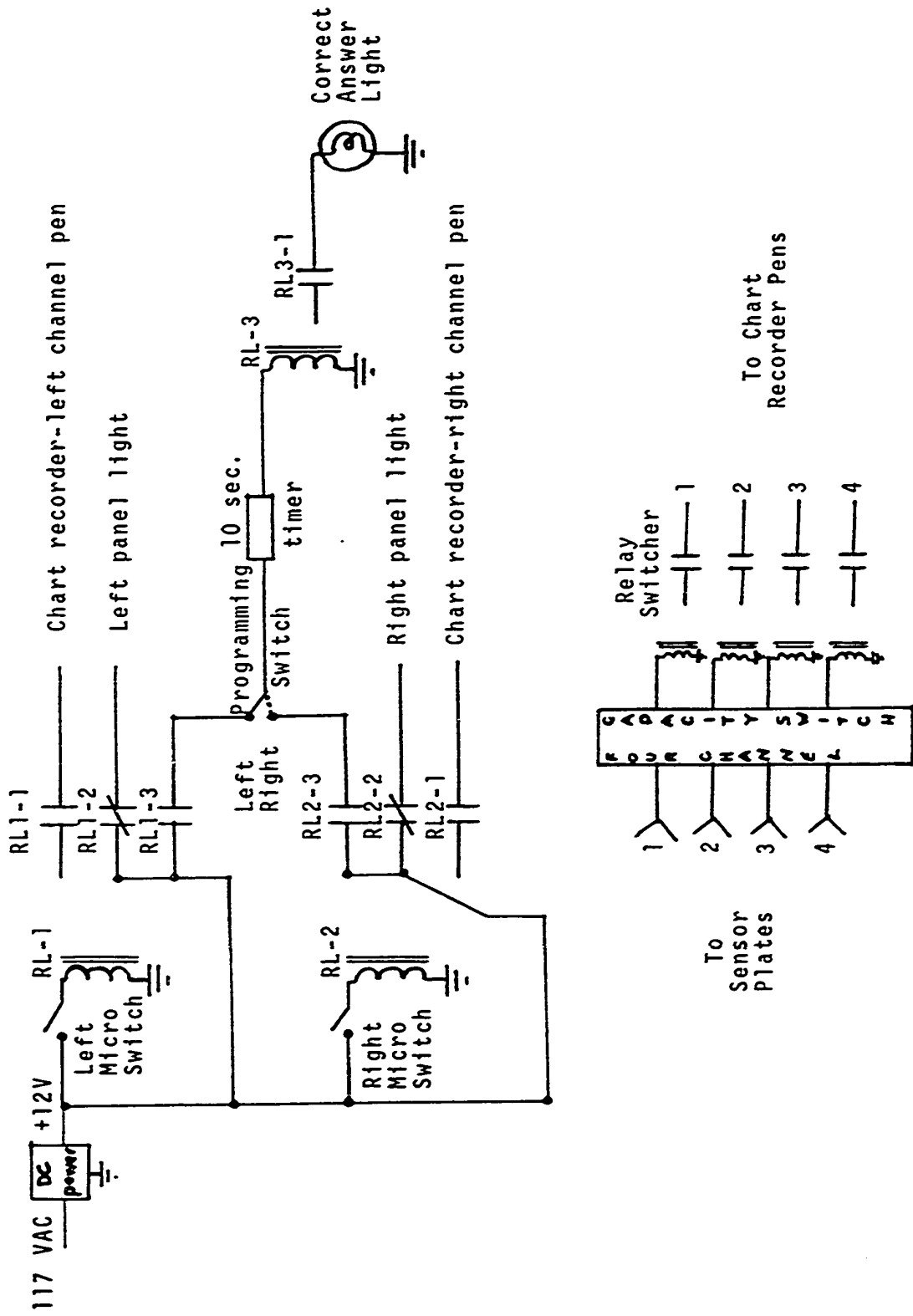

Fig. 3. Circuit Diagram of Electrical Apparatus Used in the Study

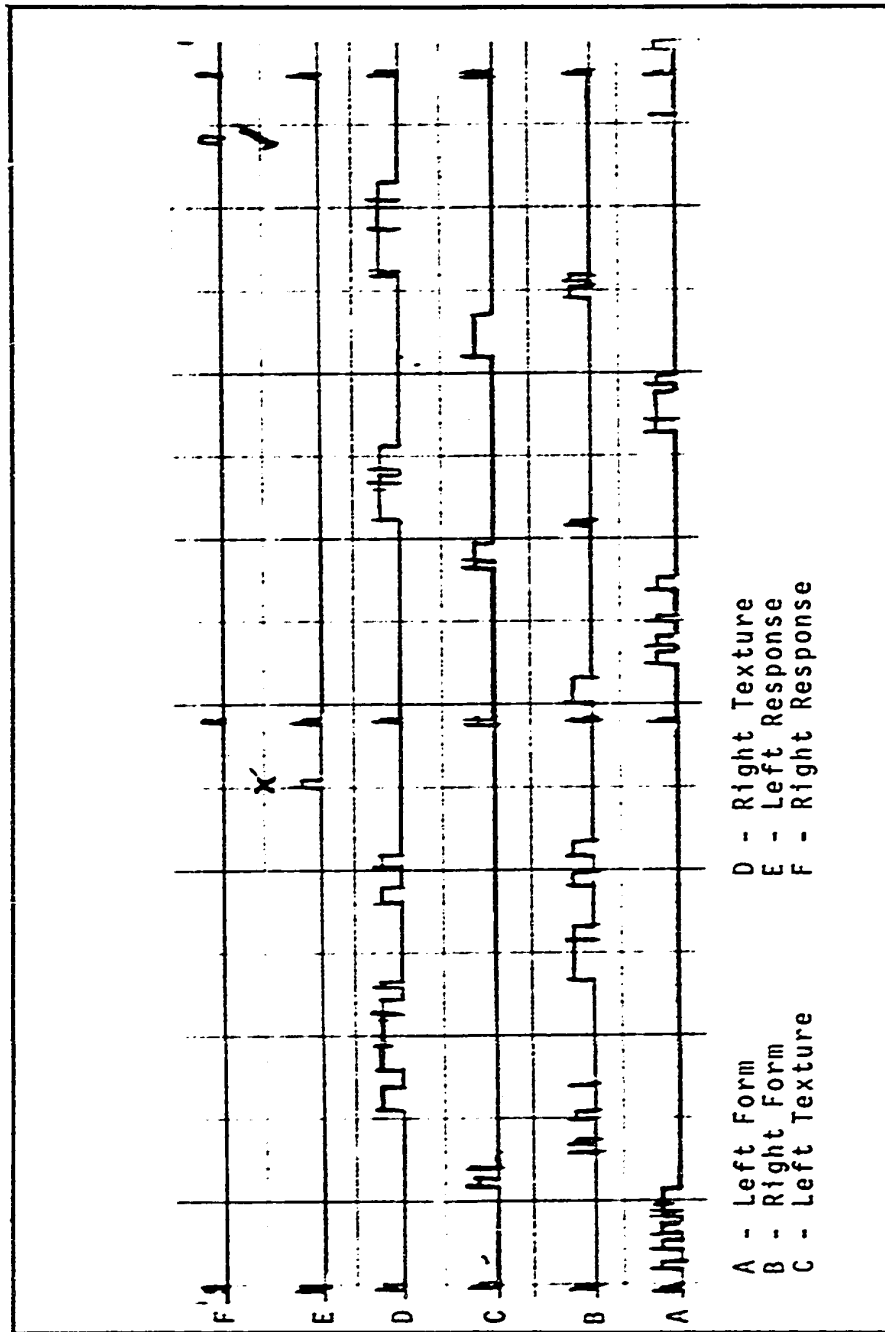

Fig. 4. Typical Output from Ink Recorder for Two Trials

period of one second.

Experimental Procedure

Each S was tested individually. At the commencement of the testing, S was seated in front of the discrimination box with the curtain raised allowing him to see the empty interior of the box and also the E seated behind the box. The following instructions were given.

We are going to play a game. I'm going to put something inside this box here (E points to the right side) which will fill up the whole of this space, (E indicates the right area to be occupied by the stimulus) and something on this side (E points to the left side) which will fill up the whole of this space (E indicates the left area to be occupied by the stimulus). I'm not going to let you see what I put in here because I'm going to put this curtain down (E points), but I'll explain that later.

Now one of the things I put in here will be a winning one and one will be a losing one. The game is to see if you can pick the winning one each time. If you can point to the winning one, the green light here (E points) will come on and a candy will drop down here (E points) into the bag for you to take away with you at the end of the game. If you point to the losing one, the green light will not come on, and a candy will not drop into the bag; instead you will here a click. I shall then take the things out (E mimes taking the stimuli out), change them around (E mimes again) and put them back in again, and you can have another go. You have won the game if you can make the green light come on and a candy drops into the bag everytime. Do you understand so far? Good.

Now I'm going to put the curtain down (E drops the curtain and fastens it into place with the studs) so that you cannot see what I put in the box, but I will let you touch them with your finger through the hole here (E points to the ring in the curtain and shows S how to place finger through). Good. You can see the curtain stretches (E takes S's finger and firmly moves it to the extremities of the box to allow S to become used to the required tension in the curtain and also runs S's finger down the dividing ledge). When you think you know which is the winning one you point with your finger like this, (E moves S's finger to the right) or like this (E moves S's finger to the left)

and then place your finger on here. (E places S's finger on the middle ledge). If you have pointed to the winning one, the green light will come on and a candy will drop into the bag. If you have pointed to the losing one, the green light will not come on and the candy will not drop into the bag; instead you will hear a click. I shall then take the things out, change them around and you will have another go.

You may touch the things inside the box as many times as you like, and you may go back and forth from one to the other as many times as you like, but when you have picked the winning one - point. Alright. Do you understand? Good. Let's begin.

The instructions were developed over a series of trials in pilot studies with Ss at various ages. The author found that with these instructions no previous practice with the stimuli was necessary. However to make quite sure the Ss were aware of all aspects of the stimuli, E gave the following comments during the first trial.

Make sure you feel everything. Reach right to the back. Good. Now reach right to the front. Good. Run your finger over everything that's there. Don't miss anything. Good.

At each experimental level there were four possible arrangements of the two respective forms and textures. These arrangements are given in Table 1. Position was an irrelevant dimension throughout, and was controlled by using a Gellerman (1933) order of presentation. The order used was 132344231142314214342312143342342112311424233421 where the digits stand for the combinations listed in Table 1. Where necessary the series was repeated. As a check on the recorder output, a record of each S's responses was kept by the E. Recording sheets for the pre- and postshift experimental groups are shown in Appendix A. Each S was

TABLE 1
 STIMULI COMBINATIONS IN THE PRESIFT, CONTROL
 AND POSTSHIFT GROUPS

| Number | Preshift | Control | Postshift |
|--------|--------------------|----------------------------------|---------------------|
| 1 | Square-A, Circle-B | Horizontal-large, Vertical-small | Triangle-C, Cross-D |
| 2 | Circle-B, Square-A | Vertical-small, Horizontal-large | Cross-D, Triangle-C |
| 3 | Square-B, Circle-A | Horizontal-small, Vertical-large | Triangle-D, Cross-C |
| 4 | Circle-A, Square-B | Vertical-large, Horizontal-small | Cross-C, Triangle-D |

trained to a criterion of nine out of ten correct responses. At this point, without warning, each S was either shifted to the postshift stage or first given fifteen overlearning trials and then shifted.

Testing was continued in the postshift stage until nine out of ten correct responses were obtained. The following order of shifting was adopted. In each group, of the eight Ss trained on either form or texture, four were trained on one attribute of the dimension and four were trained on the other attribute. Each group of four Ss were then shifted to a predetermined attribute. For example, in the ED group, of the four male Ss trained on form, two were trained on square and two were trained on circle. Of the two Ss trained on square, one shifted to texture C and one shifted to texture D. Of the two Ss trained on circle one shifted to texture C and one shifted to texture D. Similarly of the four males trained on texture, two were trained on texture A and two on texture B. Of the two trained on texture A, one shifted to the form cross and one shifted to the form triangle. Of the two trained on texture B, one shifted to the form cross and one shifted to the form triangle. Similar arrangements were used for the female Ss within each group. If S had not reached criterion in the preshift stage after 50 trials, he was trained and then shifted. Training consisted of asking S to say how the stimuli differed, and to try and give a reason why a particular stimulus was chosen. This analysis was continued

until the S reached criterion. The five Ss concerned were able to reach criterion in the postshift stage.

Statistical Hypotheses

The experimental hypotheses developing from the review of the literature have been stated (p. 37). The following statistical null hypotheses arise from these experimental hypotheses.

- H_0 : 1-1 In the postshift stage, the mean number of errors to criterion in the ID, ED, and control groups are equal.
- H_0 : 1-2 In the postshift stage the mean number of errors to criterion at each level of learning are equal.
- H_0 : 1-3 In the postshift stage the mean number of errors to criterion in the cont.-crit. group is equal to the average of the mean number of errors to criterion in the ID-crit. and ED-crit. groups.
- H_0 : 1-4 In the postshift stage the mean number of errors to criterion in the cont.-OL group is equal to the average of the mean number of errors to criterion in the ID-OL and ED-OL groups.
- H_0 : 2-1 In the ID-ED-crit. and ID-ED-OL groups in the pre-shift stage, the mean percentage touching time to the relevant dimension of all individual first-half series of trials is equal to the mean percentage touching time to the relevant dimension of all individual second-half series of trials.
- H_0 : 2-2 The mean percentage touching time to the relevant dimension in the ten trials immediately prior to the shift in the ID-crit. and ED-crit. groups is equal to the mean percentage touching time to the relevant dimension in the first ten overlearning trials of the ID-OL and ED-OL groups.
- H_0 : 3-1 The mean percentage touching time to the relevant dimension in the ten trials immediately prior to the shift in the ID-crit. group is equal to the mean percentage touching time to the relevant dimension in the first ten trials immediately following the shift in the ID-crit. group.

- H_0 : 3-2 The mean percentage touching time to the relevant dimension in the ten trials immediately prior to the shift in the ID-OL group is equal to the mean percentage touching time to the relevant dimension in the first ten trials immediately following the shift in the ID-OL group.
- H_0 : 4-1 In the first ten trials of the postshift stage in the ED-crit. group, the mean percentage touching time to the preshift relevant dimension in the first five trials is equal to the mean percentage touching time to the preshift relevant dimension in the second five trials.
- H_0 : 4-2 In the first ten trials of the ED-OL group in the postshift stage, the mean percentage touching time to the preshift relevant dimension in the first five trials is equal to the mean percentage touching time to the preshift relevant dimension in the second five trials.
- H_0 : 5-1 In the cont.-crit. group in the postshift stage, the mean percentage touching time to the relevant dimension of all individual first-half series of trials is equal to the mean percentage touching time to the relevant dimension of all individual second-half series of trials.
- H_0 : 5-2 In the cont.-OL group in the postshift stage the mean percentage touching time to the relevant dimension of all individual first-half series of trials is equal to the mean percentage touching time to the relevant dimension of all individual second-half series of trials.
- H_0 : 5-3 In the control groups, in the postshift stage, the mean percentage touching time to the relevant dimension of all individual first-half series of trials in the cont.-crit. group is equal to the mean percentage touching time to the relevant dimension of all individual second-half series of trials in the cont.-OL group.

CHAPTER V

PRESENTATION AND ANALYSIS OF THE DATA

In this chapter the analysis of the raw data is presented, and the hypotheses stated in Chapter IV are tested. The statistical methods used, the variables adopted, and the results obtained are given. Discussion of the results can be found in Chapter VI. Analysis of the original learning is given in this chapter. No hypotheses were advanced for this phase, but the results of preshift learning are relevant to the interpretation of the postshift results.

A summary of the performance of each \underline{S} , giving the actual time and percentage time spent touching each specific cue of the dimensions, the actual time and percentage time spent touching each of the dimensions, the number of interdimensional and intradimensional touches, the position response (left-right) and the choice response per trial, was obtained. For each \underline{S} , a summary of the total trials to criterion, trials to last error, and total errors was also obtained. A specimen output for one \underline{S} is given in Appendix B. The raw data for the ninety-six \underline{S} s in the pre- and postshift can be found in Appendix C.

Table 2 shows the means and standard deviations of the total errors in the pre- and postshift stage.

The Bartlett test for homogeneity of variances in the pre- and postshift stages using raw scores gave χ^2 prob-

TABLE 2
 MEANS AND STANDARD DEVIATIONS OF THE TOTAL
 ERRORS IN THE PRE- AND POSTSHIFT STAGES

| | | ID | | ED | | Control | |
|-----------|--------------|-----------|------|-----------|------|-----------|------|
| | | \bar{x} | s.d. | \bar{x} | s.d. | \bar{x} | s.d. |
| Preshift | Criterion | 4.06 | 5.39 | 6.12 | 7.06 | 11.50 | 8.09 |
| | Overlearning | 3.94 | 5.65 | 4.19 | 5.27 | 6.50 | 6.26 |
| Postshift | Criterion | 1.19 | 1.09 | 9.06 | 6.46 | 4.50 | 4.28 |
| | Overlearning | 0.94 | 1.23 | 13.06 | 9.25 | 6.44 | 6.96 |

abilities of 0.50 and 0.0 respectively. When the raw scores were transformed by a logarithmic transformation the χ^2 probabilities were increased to 0.97 and 0.14 respectively. As the logarithmic transformation improved the homogeneity of variances, the analyses of the data were carried out on a logarithmic transformation of the raw data. The three transformed measures of trials to criterion, trials to last error and total errors, in the pre- and postshift stage, were correlated. The results are given in Table 3. Because of the high correlations between variables 1, 2 and 3 in each stage ($p < .001$), the analyses were carried out on the $\log(\text{total errors} + 1)$ variable only. The means and standard deviations of the total errors plus one in the pre- and postshift stages expressed in logarithms are given in Tables 4 and 5.

TABLE 3
CORRELATIONS BETWEEN TOTAL TRIALS (1),
TRIALS TO LAST ERROR (2), AND TOTAL
ERRORS (3) IN LOGARITHMIC FORM

| | Preshift | | | Postshift | | |
|---|----------|------|------|-----------|-------|--------|
| | 1 | 2 | 3 | 1 | 2 | 3 |
| 1 | | .909 | .932 | -0.091 | 0.016 | -0.034 |
| 2 | | | .961 | -0.047 | 0.070 | 0.011 |
| 3 | | | | -0.076 | 0.025 | -0.031 |
| 1 | | | | | .913 | .922 |
| 2 | | | | | | .966 |
| 3 | | | | | | |

TABLE 4
MEANS AND STANDARD DEVIATIONS OF LOG (TOTAL
ERRORS PLUS ONE) IN THE PRESHIFT PHASE

| | ID | | ED | | Control | |
|--------------|-----------|------|-----------|------|-----------|------|
| | \bar{x} | s.d. | \bar{x} | s.d. | \bar{x} | s.d. |
| Criterion | .507 | .416 | .672 | .420 | .971 | .396 |
| Overlearning | .531 | .359 | .498 | .453 | .701 | .422 |

TABLE 5
 MEANS AND STANDARD DEVIATIONS OF LOG (TOTAL
 ERRORS PLUS ONE) IN THE POSTSHIFT PHASE

| | ID | | ED | | Control | |
|--------------|-----------|------|-----------|------|-----------|------|
| | \bar{x} | s.d. | \bar{x} | s.d. | \bar{x} | s.d. |
| Criterion | .291 | .212 | .901 | .338 | .613 | .358 |
| Overlearning | .227 | .213 | 1.038 | .341 | .707 | .389 |

Analysis of Original Learning

A three-way analysis of variance (Learning x Shifts x Sex) was carried out on the preshift transformed scores. The results are given in Table 6. A significant difference was revealed in preshift learning among the experimental groups ($F = 5.1, p < .01$). No interaction reached statistical significance. Scheffé multiple comparisons of main effects showed that the difference in learning was between the control group and ID group ($F = 4.7, .01 < p < .02$). The difference between the ED and control group was not significant at the .05 level ($F = 2.9, .05 < p < .06$). There was no statistically significant difference in preshift learning between the ID and ED groups.

Analysis of Postshift Choice Responses

$H_0: 1-1$ In the postshift stage, the mean number of errors to criterion in the ID, ED and control groups are equal.

TABLE 6
ANALYSIS OF VARIANCE FOR PRESHIFT
CHOICE RESPONSES

| Source | Sum of Squares | df | Mean Square | F |
|--------------|----------------|----|-------------|-------|
| Learning (A) | 0.172 | 1 | 0.172 | 0.98 |
| Shift (B) | 1.78 | 2 | 0.892 | 5.10* |
| A x B | 0.162 | 2 | 0.081 | 0.46 |
| Sex (C) | 0.111 | 1 | 0.111 | 0.63 |
| A x C | 0.178 | 1 | 0.178 | 1.01 |
| B x C | 0.495 | 2 | 0.248 | 1.42 |
| A x B x C | 0.318 | 2 | 0.159 | 0.91 |
| Error | 14.69 | 84 | 0.175 | |

* $p < .01$

H_0 : 1-2 In the postshift stage, the mean number of errors to criterion at each level of learning are equal.

A four-way analysis of variance (Learning x Shift x Dimensions x Sex) was carried out on the postshift log (total errors + one). A significant main effect due to shift ($F = 38.00$, $p < .001$) was obtained. The main effect due to learning was not statistically significant ($F = .70$, $p < .40$). There were no significant interactions obtained. The results are given in Table 7. A Scheffé multiple comparison of means gave a significant difference between the ID and ED groups ($F = 40.15$, $p < .001$), ID and control groups

TABLE 7
ANALYSIS OF VARIANCE FOR POSTSHIFT
CHOICE RESPONSES

| Source | Sum of Squares | df | Mean Square | F |
|---------------|----------------|----|-------------|--------|
| Learning (A) | 0.075 | 1 | 0.075 | 0.70 |
| Shift (B) | 8.116 | 2 | 4.06 | 38.00* |
| A x B | 0.181 | 2 | 0.09 | 0.85 |
| Dimension (C) | 0.008 | 1 | 0.01 | 0.08 |
| A x C | 0.009 | 1 | 0.01 | 0.09 |
| B x C | 0.047 | 2 | 0.02 | 0.22 |
| A x B x C | 0.049 | 2 | 0.02 | 0.23 |
| Sex (D) | 0.001 | 1 | 0.00 | 0.01 |
| A x D | 0.073 | 1 | 0.07 | 0.68 |
| B x D | 0.357 | 2 | 0.18 | 1.67 |
| A x B x D | 0.115 | 2 | 0.06 | 0.54 |
| C x D | 0.171 | 1 | 0.17 | 1.60 |
| A x C x D | 0.351 | 1 | 0.35 | 3.28 |
| B x C x D | 0.032 | 2 | 0.02 | 0.15 |
| A x B x C x D | 0.145 | 2 | 0.07 | 0.68 |
| Error | 7.699 | 72 | 0.11 | |

* $p < .001$

($F = 12.76$, $p < .001$) and ED and control groups ($F = 7.64$, $p < .001$). $H_0: 1-1$ was therefore rejected and it is concluded that there was a significant difference in the learn-

ing between all pairs of groups in the postshift stage at both levels of learning. $H_0: 1-2$ was not rejected and it is concluded that there was no statistically significant effect of learning on learning in the postshift stage. As mentioned in the section on procedure, five Ss were trained in the preshift stage. Four of these Ss were in the cont.-crit. group and one in the ED-crit. group. A second analysis of postshift data was made excluding these five Ss. A significant main effect due to shift was obtained ($F = 42.15, p < .001$). No effect due to learning and no significant interactions were obtained. As these results were essentially the same as those obtained when all Ss were included in the analysis, it was concluded that the data from the five Ss who were trained in the preshift stage had no significant effect on the interpretation of the postshift performance of the sample. They were, therefore, included in all the analyses reported.

$H_0: 1-3$ In the postshift stage the mean number of errors to criterion in the cont.-crit. group is equal to the average of the mean number of errors to criterion in the ID-crit. and ED-crit. groups.

$H_0: 1-4$ In the postshift stage the mean number of errors to criterion in the cont.-OL group is equal to the average of the mean number of errors to criterion in the ID-OL and ED-OL groups.

Figure 5 shows the plotted cell means expressed in logarithms for each level of learning. A planned comparison of means is given in Table 8. As the F values did not approach significance ($F = 0.004, p > .9$; $F = 0.52, p > .1$), $H_0: 1-3$ and $1-4$ were not rejected, and it is concluded that

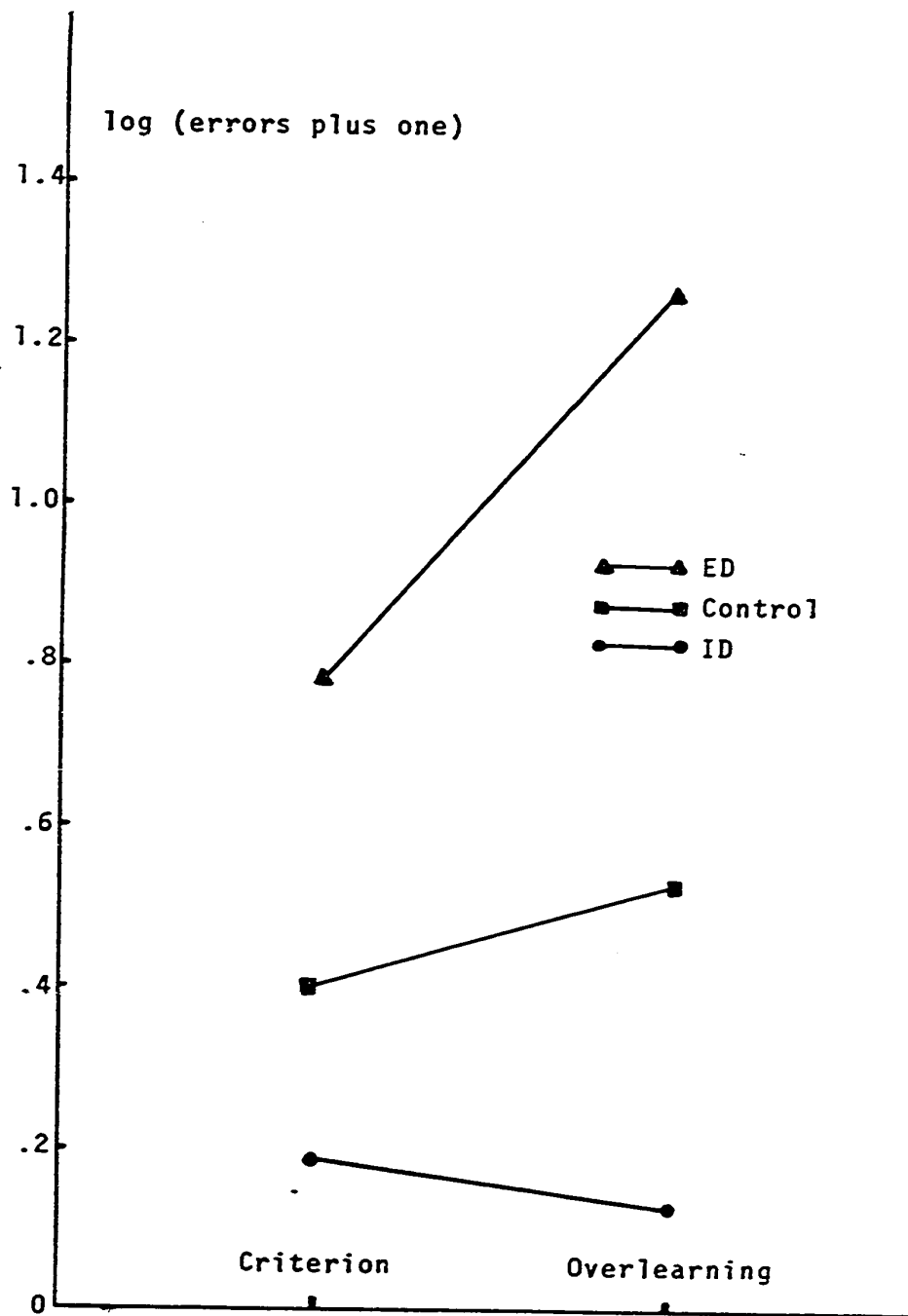

Fig. 5. ID, ED and Control Group Means for Two Levels of Learning in the Post-shift Stage

TABLE 8
 PLANNED COMPARISONS OF THE ID, ED AND CONTROL
 MEANS AT TWO LEVELS OF LEARNING

| | ID | Cont. | ED | $(\sum c\bar{x})^2$ | $\sum \frac{c^2}{n}$ | MS | F |
|--------------------|------|-------|------|---------------------|----------------------|-------|-------|
| Criterion Means | .291 | .613 | .901 | | | | |
| Contrasts | -1 | 2 | -1 | 0.00116 | 3/8 | .1068 | 0.004 |
| Overlearning Means | .227 | .707 | 1.04 | | | | |
| Contrasts | -1 | 2 | -1 | 0.147 | 3/8 | .1068 | .052 |

at each level of learning the mean of the control group was not different from the average of the means of the ID and ED groups.

Analysis of Tactile Responses

H_0 : 2-1 In the ID-ED-crit. and ID-ED-OL groups in the pre-shift stage, the mean percentage touching time to the relevant dimension of all individual first half series of trials is equal to the mean percentage touching time to the relevant dimension of all individual second half series of trials.

In the analysis of tactile observing responses, the dependent variable is the mean percentage touching time per trial to a specific dimension. This variable is dependent upon the number of Ss used to calculate the mean, and as each S reaches the criterion of nine out of ten correct responses, the calculated mean becomes more unreliable. There

are two ways of approaching this problem. The first method is to keep the analysis within the range of ten trials, whether it be the first ten trials of a forward learning curve or the first ten trials of a backward learning curve. The second method is to "Vincentize" the data (Vincent, 1912). In the latter method each \underline{S} 's total number of trials is divided into an arbitrary number of blocks so that for each \underline{S} the number of trials within the blocks is variable, but the number of blocks is constant. To test $H_0: 2-1, 2-2, 5-1$ and $5-2$ the dependent variable was the mean percentage touching time to the relevant dimension obtained by "Vincentizing" each \underline{S} 's trials into two blocks. The correlated \underline{t} test results for testing $H_0: 2-1$ are given in Table 9.

TABLE 9
CORRELATED \underline{t} TEST RESULTS FOR INDIVIDUAL FIRST
AND SECOND HALF SERIES OF TRIALS IN THE
PRESHIFT ID-ED-crit.-OL GROUP

| | N | Means | df | t |
|-------------|----|-------|----|--------|
| First half | 64 | 56.88 | 63 | -5.68* |
| Second half | | 68.41 | | |

* $p < .001$

As the \underline{t} value ($\underline{t} = -5.68, p < .001$) was significant, $H_0: 2-1$ was rejected and it is concluded that the mean percentage touching time to the relevant dimension in the first half of all preshift trials in the combined ID-ED-crit.-OL groups is less than the mean percentage touching time to the relevant dimension in the second half of all preshift trials in the combined ID-ED-crit.-OL groups.

$H_0: 2-2$ The mean percentage touching time to the relevant dimension in the ten trials immediately prior to the shift in the ID-crit. and ED-crit. groups is equal to the mean percentage touching time to the relevant dimension in the first ten overlearning trials of the ID-OL and ED-OL groups.

$H_0: 2-2$ was tested using a \underline{t} test. Table 10 shows the results.

TABLE 10
 \underline{t} TEST RESULTS FOR THE COMBINED ID-ED GROUP
 MEANS AT TWO LEVELS OF LEARNING

| | N | Means | df | \underline{t} |
|-------|----|-------|----|-----------------|
| Crit. | 10 | 67.0 | 18 | -5.64* |
| OL | 10 | 79.4 | | |

* $p < .001$

As the \underline{t} value ($\underline{t} = -5.64$) was significant $H_0: 2-2$ was rejected and it is concluded that the mean percentage touching time to the relevant dimension in the ten trials immediately

prior to the shift in the ID-crit. and ED-crit. groups is less than the mean percentage touching time to the relevant dimension in the first 10 trials of the ID-OL and ED-OL groups, i.e., overlearning had a significant effect on the percentage touching time to the relevant dimension.

H_0 : 3-1 The mean percentage touching time to the relevant dimension in the ten trials immediately prior to the shift in the ID-crit. group is equal to the mean percentage touching time to the relevant dimension in the first ten trials immediately following the shift in the ID-crit. group.

H_0 : 3-2 The mean percentage touching time to the relevant dimension in the ten trials immediately prior to the shift in the ID-OL group is equal to the mean percentage touching time to the relevant dimension in the first ten trials immediately following the shift in the ID-OL group.

A two-way (Overlearning x Blocks of ten trials) analysis of variance with repeated measures was carried out, with the variable being the mean percentage touching time per trial to the relevant dimension. The results of the analysis are given in Table 11. All F values were significant ($p < .001$). The cell means are plotted in Figure 6. As the test of simple main effects of Blocks at crit. learning was significant ($F = 13.7, p < .001$), and at OL learning was not significant ($F = 0.13, p > .1$), H_0 : 3-1 was rejected and H_0 : 3-2 was not rejected, and it is concluded that in the first ten trials of the postshift stage in the ID-crit. group, the mean percentage touching time to the relevant dimension increases, and in the first ten trials of the postshift stage in the ID-OL group the mean percentage touching time to the relevant dimension remains constant.

TABLE 11
 TWO-WAY ANALYSIS OF VARIANCE (REPEATED MEASURES ON SUBJECTS) FOR $H_0: 3-1$ AND $H_0: 3-2$

| Source | Sum of Squares | df | Mean Square | F |
|--------------------------|----------------|----|-------------|-------|
| Between Subjects | 663.8 | 19 | | |
| Learning | 357.8 | 1 | 357.8 | 21.0* |
| Subjects within groups | 306.3 | 18 | 17.0 | |
| Within Subjects | 851.8 | 20 | | |
| Blocks | 366.2 | 1 | 366.2 | 27.6* |
| Learning x Blocks | 246.7 | 1 | 246.7 | 18.6* |
| Blocks x subjects within | 238.7 | 18 | 13.3 | |

* $p < .001$

$H_0: 4-1$ In the first ten trials of the postshift stage in the ED-crit. group, the mean percentage touching time to the preshift relevant dimension in the first five trials is equal to the mean percentage touching time to the preshift relevant dimension in the second five trials.

$H_0: 4-2$ In the first ten trials of the postshift stage in the ED-OL group, the mean percentage touching time to the preshift relevant dimension in the first five trials is equal to the mean percentage touching time to the preshift relevant dimension in the second five trials.

A two-way (Learning x Blocks) analysis of variance with repeated measures was carried out with the variable being the mean percentage touching time per trial to the preshift relevant dimension. The results of the analysis of variance are given in Table 12, with the cell means given

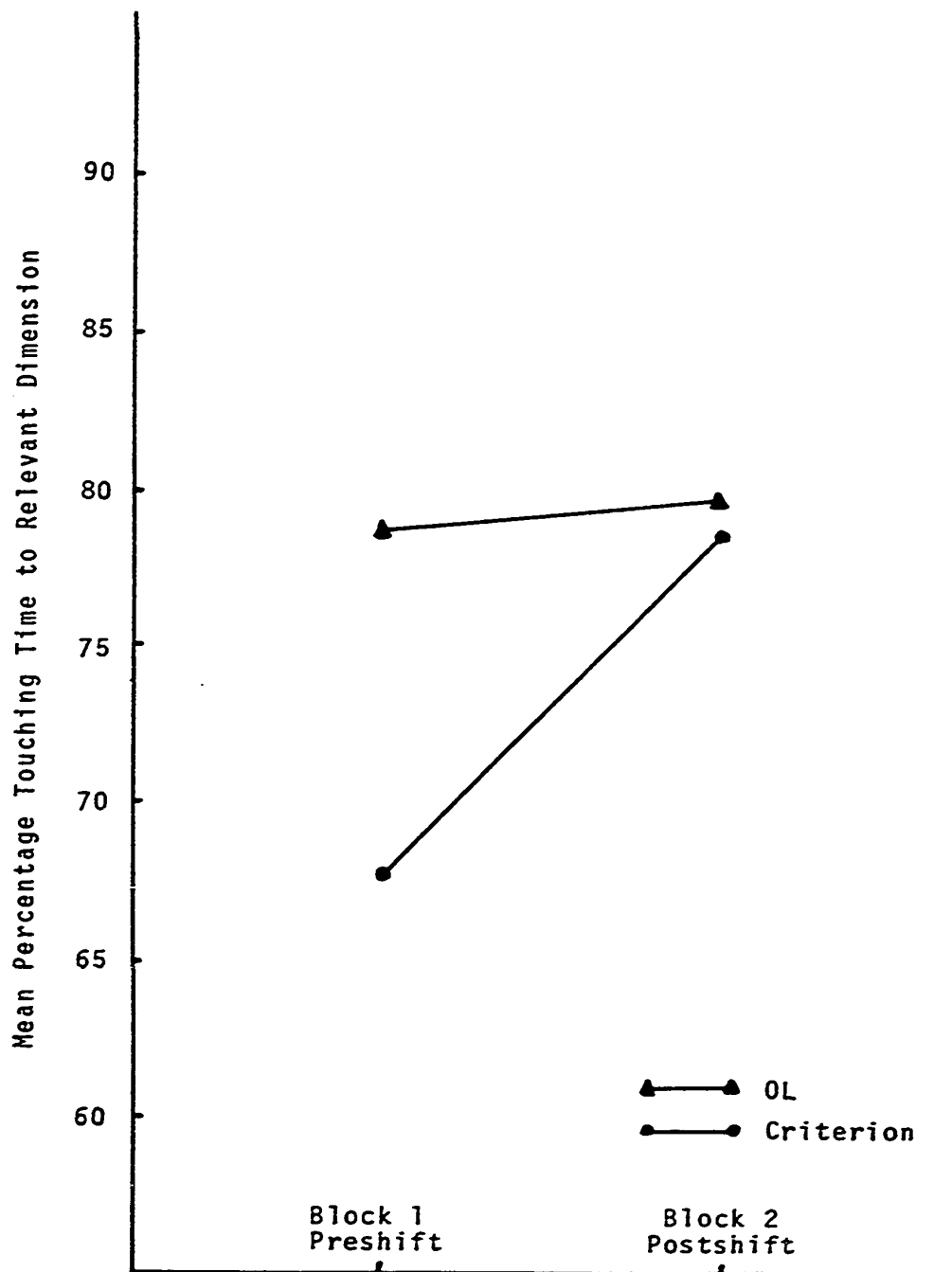

Fig. 6. Cell means for the ID criterion and ID overlearning blocks

TABLE 12
 TWO-WAY ANALYSIS OF VARIANCE (REPEATED MEASURES ON SUBJECTS) FOR $H_0: 4-1$ AND $H_0: 4-2$

| Source | Sum of Squares | df | Mean Square | F |
|--------------------------|----------------|----|-------------|--------|
| Between Subjects | 432.8 | 9 | | |
| Learning | 191.0 | 1 | 191.0 | 6.3* |
| Subjects within groups | 241.8 | 8 | 30.2 | |
| Within Subjects | 989.8 | 10 | | |
| Blocks | 686.8 | 1 | 686.8 | 22.4** |
| Learning x Blocks | 57.7 | 1 | 57.7 | 1.9 |
| Blocks x subjects within | 245.3 | 8 | 30.7 | |

* $.01 < p < .05$

** $p < .001$

in Table 13. As the main effects were significant and there was no statistically significant interaction $H_0: 3-1$ and $H_0: 3-2$ were rejected, and by an inspection of Table 13 it may be observed that at both levels of learning in the ED groups, the mean percentage touching time to the preshift relevant dimension in the first block of five trials of the postshift stage is greater than the mean percentage touching time to the second block of five trials of the postshift stage.

TABLE 13
CELL MEANS OBTAINED FROM TABLE 12
ANALYSIS OF VARIANCE

| | Block 1 | Block 2 |
|--------------|---------|---------|
| Criterion | 72.12 | 63.82 |
| Overlearning | 81.70 | 66.60 |

- H₀: 5-1 In the cont.-crit. group in the postshift stage, the mean percentage touching time to the relevant dimension of all individual first-half series of trials is equal to the mean percentage touching time to the relevant dimension of all individual second-half series of trials.
- H₀: 5-2 In the cont.-OL group in the postshift stage the mean percentage touching time to the relevant dimension of all individual first-half series of trials is equal to the mean percentage touching time to the relevant dimension of all individual second-half series of trials.
- H₀: 5-3 In the control groups, in the postshift stage, the mean percentage touching time to the relevant dimension of all individual first-half series of trials in the cont.-crit. group is equal to the mean percentage touching time to the relevant dimension of all individual second-half series of trials in the cont.-OL group.

A two-way (Learning x Blocks) analysis of variance with repeated measures was carried out on the control groups with the variable being the mean percentage touching time to the relevant dimension obtained by "Vincentizing" each S's trials into two equal blocks. The analysis results are given in Table 14. Table 15 gives the cell means. There was a significant main effect due to the blocks

TABLE 14
 TWO-WAY ANALYSIS OF VARIANCE (REPEATED MEASURES
 ON SUBJECTS) OF THE POSTSHIFT CONTROL GROUPS
 FOR $H_0: 5-1$, $H_0: 5-2$ AND $H_0: 5-3$

| Source | Sum of Squares | df | Mean Square | F |
|--------------------------|----------------|----|-------------|--------|
| Between Subjects | 46721.5 | 31 | | |
| Learning | 287.7 | 1 | 287.7 | 0.67 |
| Subjects within groups | 46433.8 | 30 | 1547.8 | |
| Within Subjects | 8313.5 | 32 | | |
| Blocks | 3537.7 | 1 | 3537.7 | 22.32* |
| Learning x Blocks | 21.4 | 1 | 21.4 | 0.14 |
| Blocks x subjects within | 4754.4 | 30 | 158.5 | |

* $p < .001$

Table 15
 CELL MEANS FOR TWO-WAY ANALYSIS OF
 VARIANCE OF TABLE 14 (N=16)

| | Block 1 | Block 2 |
|--------------|---------|---------|
| Criterion | 61.1 | 74.8 |
| Overlearning | 55.7 | 71.7 |

($F = 22.3$, $p < .001$), but not to the learning, and no statistically significant interaction, therefore $H_0: 5-1$ and $H_0: 5-2$ were rejected and $H_0: 5-3$ was not rejected, and it is concluded that the mean percentage touching time to the relevant dimension in the postshift control group in the first half of all trials at both levels of overlearning, is less than the mean percentage touching time to the relevant dimensions in the second half of all trials, and the mean percentage touching time in the criterion-control group is equal to the mean percentage touching time in the overlearning control group in the postshift stage.

CHAPTER VI

DISCUSSION OF RESULTS

Chapter V presented the statistical analysis and results, and in this chapter the results that were obtained are discussed. The presentation of the discussion follows the same format as the presentation of the hypotheses. First, the preshift choice responses are discussed, then the postshift choice responses, and finally the tactile attentional responses are considered. All of the hypotheses are related to graphs (cf. p. 84), which serve as a summary of the processes shown by this study to be involved in discrimination learning.

Preshift Learning

The ease of original learning was not consistent across groups. The learning in the control group involving the dimensions of orientation and size proved to be more difficult than the learning in the experimental groups involving the dimensions of form and texture. The difference in difficulty of learning could be due, in part, to the stimuli and method used, or, in part, to a sampling bias. As no difference in ease of learning was exhibited between the groups trained on the task involving the same dimensions, the former reason would appear more likely. Orientation has been shown to be a difficult concept for young ss.

Reudal and Teuber (1963) working with children of 3-9 years of age, found, that although there were few failures, many Ss had great difficulty in an orientation discrimination. Similar results with four-year-olds was shown by Huttenlocker (1967). The current study restricted Ss to touching the stimuli with the index finger only, and this restriction tends to compound the difficulty. For example, E noticed during the experiment that many of the successful Ss in the orientation and size discrimination were those who used the vertical dividing strip as a base line. When asked at the end of the testing what the positive cue was, these Ss gave answers which involved not size and orientation but how near or far the stimulus was from the dividing line. The control group, as already outlined, shifted to the same task as the experimental groups, and its purpose was to provide a basis for the comparison of transfer of such learning as might be engendered through warm-up, anxiety reduction or any effect which might be classified under the general rubric of learning set. The task in the control group was chosen to involve the same stimuli as in the experimental group in order to equate any transfer that might be involved. As this transfer, if any, and its resulting effects on post-shift learning was the important issue in this study, it was considered that the discrepancy in learning in the pre-shift stage between the control group and the experimental groups is not a crucial issue. Eimas (1966a) found a difference in ease of original learning between two of the ED

groups. However, in the Eimas study, because the task in the ED groups was the same, sampling bias may have been a significant factor.

Postshift Learning

If it is assumed that mediating dimensional-specific responses are built up in the preshift stage, then an intradimensional shift, where the relevant preshift dimension remains relevant in the postshift stage, should result in a positive transfer of the mediating response. In an extradimensional shift, where the preshift relevant dimension becomes irrelevant in the postshift stage, negative transfer should occur, and in the control shift, where the dimensions in the postshift stage are unrelated from those in the preshift stage, there should be no transfer of mediating responses. These predictions were upheld in this study using a sample of eight-year old Ss. The results are consistent with previous studies in the visual modality (Furth & Youniss, 1964; Dickerson, 1966; Eimas, 1966a), and are in agreement with mediational theories of discrimination learning. However, the results, like those of most previous studies, offer no direct indication of the underlying mediating process taking place.

Although the positive and negative transfer of a mediating response have been shown before, few studies have investigated the direction of the transfer of the mediating response. A difference between the ease of learning an ID

and ED discrimination task may be attributable to a large negative transfer in the ED group and a small positive transfer in the ID group, or vice-versa. $H_0: 1-3$ and $H_0: 1-4$ were designed to investigate this aspect of transfer. The failure to reject $H_0: 1-3$ and $H_0: 1-4$ may have been due to the fact that the test was carried out on transformed raw scores. When the original raw scores were used however, non-significant F values of .05 and .74 were also obtained for the comparison of the criterion and overlearning means. As the hypotheses were not rejected in either case it can be concluded that negative transfer of the mediating response in the ED group, and positive transfer of the mediating response in the ID group, at both levels of overlearning, took place. Shepp and Turrisi (1967) suggest that normal SS may transfer responses to the relevant dimension to a greater extent than to the irrelevant dimension. The present study did not substantiate the Shepp and Turrisi results.

Overlearning and Postshift Learning

A further method of analyzing the underlying process of mediation is by examining the effect of overlearning on the postshift choice responses. If the assumption of mediating attentional responses is made, the Zeaman and House model and the Lovejoy model predict that the rate the relevant attentional response approaches unity is less than the rate the choice response approaches unity. Overlearn-

ing provides time for the attentional response to increase in strength, and the resulting negative and positive transfer of the mediating response is greater. The means of the postshift errors were presented in Table 4 and the plot of the means was given in Figure 5. Although there appears to be an increase in positive transfer in the ID group due to OL, increased negative transfer in the ED group, and zero transfer in the control group, the difference in ease of learning, at the two learning levels, did not approach statistical significance.

One possible reason for the lack of significance of the overlearning condition is that the task used in the pre-shift stage was not of sufficient difficulty to allow, as a result of overlearning, a difference in the learning in the ID groups to appear. The difficulty of a task for a particular age level is hard to establish, even with pilot work, and in this study a ceiling effect was evident. If the task had been such that the criterion group had taken more trials to reach criterion, then the difference in the performance at the two levels of learning in the ID groups might have been greater, thus resulting in a significant overlearning effect. A second possible reason for the non-significance of the overlearning can be advanced in terms of mediating attentional theory. The difference, in performance at the two levels of learning, depends upon the difference in magnitude of the attentional response to the relevant dimension at the outset of the shift. This in turn

is dependent upon the trials to criterion used in the pre-shift stage and the period of overlearning. If the number of criterion trials is left constant and the period of overlearning increased, or the criterion is made less stringent and the period of overlearning left constant, or the criterion is made less stringent and the period of overlearning increased, a greater dimensional-specific attentional response difference may result. If it is assumed that the attentional response strength increases during these periods, then the non-significant overlearning results are explainable by one or both of the above analyses. This study affords an opportunity of pursuing this approach in more detail when the tactile responses are analyzed (cf. p. 100).

Backward Learning Curves

The effect of overlearning on the respective shift performance can be further examined by analyzing backward learning curves (Hayes, 1953). In the method of backward curves, individual curves are displaced horizontally so that their final points coincide. The method of drawing these curves involves plotting the percentage of correct responses, not starting at the first trial and working forward, but starting at the criterion and working backward. The resulting curve indicates the average accuracy of performance for the sample on the xth trial before reaching criterion. Backward learning curves suffer from similar

limitations to forward learning curves in that the further away from the starting point, the fewer Ss are involved in the calculation of the average, and the less valid the points become; however, they do allow learning in the vicinity of criterion to be examined. Figure 7 shows the backward learning curves plotted for each group for each level of learning. The curves in Figure 7 are plotted in blocks of three trials with an abscissa starting point obtained by averaging using no fewer than six Ss. The right hand point of each curve represents performance on the trial block in which criterion was reached, and the immediately preceding point represents the performance on the trial block immediately preceding criterion performance etc.

As overlearning increases the length of the presolution plateau increases for the ED groups, remains much the same for the control group, and decreases for the ID group. The ID group does not exhibit a great difference in the length of the presolution plateau because of the ceiling effect already mentioned (p. 78). Similar results were obtained by Shepp and Turrisi (1969) using retardate Ss. The differences in the lengths of the prelearning plateaus can be adequately explained in terms of attentional mediating theory. The length of the pretraining plateau is directly reflected in the initial probability of attending to the relevant dimension. When this probability is high the length is short; when it is low the length is long. Because the initial probabilities are dependent upon the amount

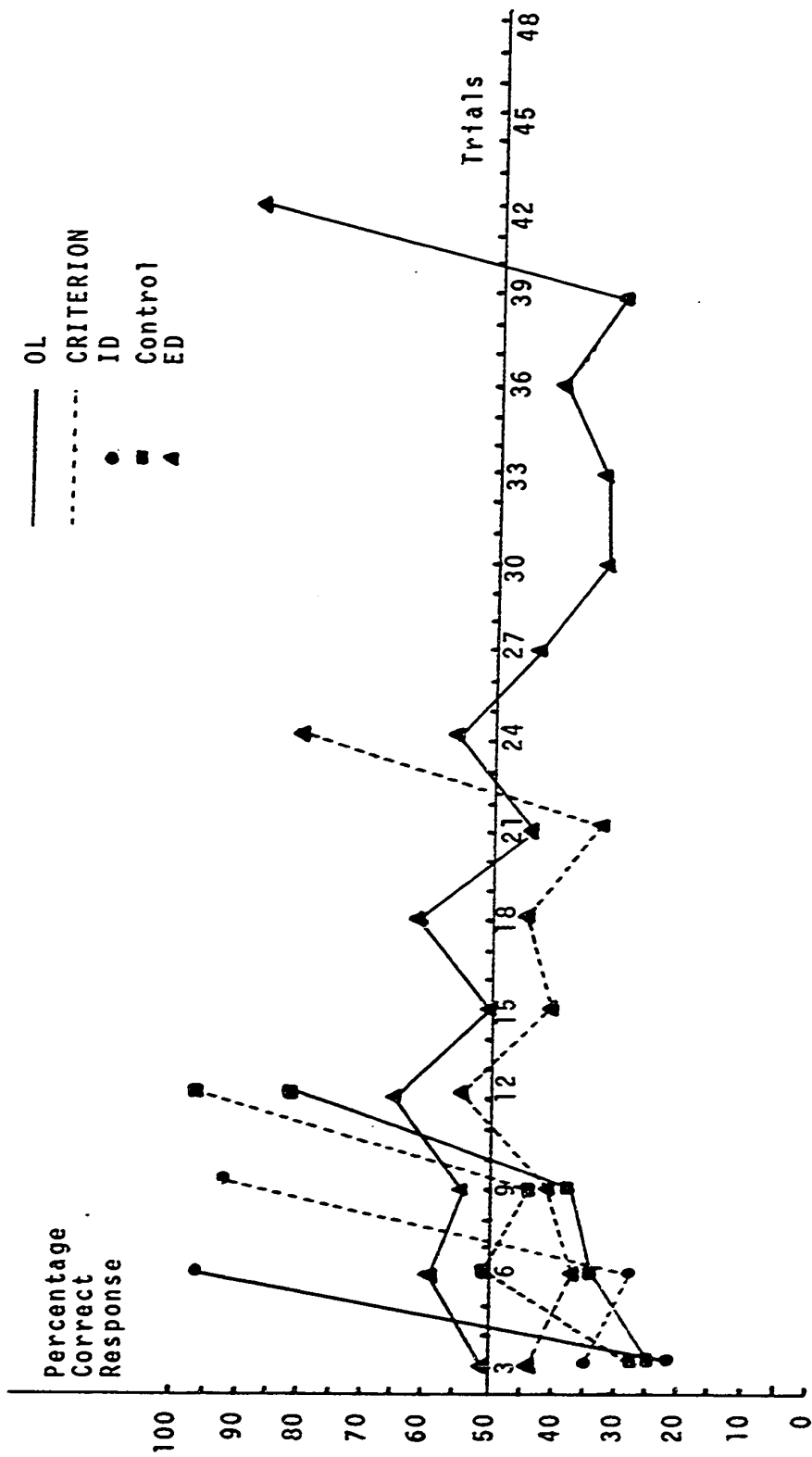

Fig. 7. Backward learning curves for ID, ED and control groups for two levels of learning plotted in blocks of three trials

of training in the preshift stage, the effect of OL on the length of the plateaus is predictable (Zeaman & House, 1963; Lovejoy, 1968). The inferred increase in attentional dimensional-specific responses will be examined further in the analysis of tactile observing responses.

In summary, an analysis of the choice responses in the postshift stage would suggest a negative and positive transfer of mediating responses at both levels of learning, with an increased transfer with increased training which did not reach statistical significance at the .05 level of probability.

Preshift and Postshift Tactile Responses

In this study, selective attention was operationally defined in terms of tactile observing responses, measured in percentage contact time to stimulus dimensions. This definition of selective attention allows a measure to be made of selective attention, and at the same time, the definition is interpretable in terms of the Zeaman and House model and Lovejoy model of discrimination learning. Any changes in the selective attentional response is, by definition, directly reflected in a change in the tactile observing responses.

The discussion of the results of the hypotheses related to the dependent variable of percentage contact time is made with reference to graphs. These graphs are forward and backward curves modified to include all mean percentage

correct responses per trial and mean percentage touching time per trial for all phases of the discrimination process. The limitations on the validity of the points as they increase away from an initial starting point is still applicable, but during the criterion run and overlearning run this does not hold, as the full sample of Ss is used. These graphs are given as illustrative summaries of the results of the hypotheses tested. Figure 8 shows the pre-shift curves for the combined ID-ED groups over both levels of learning, giving a sample of sixty-four Ss. In Figure 8, the attentional response to the relevant dimension increased in the preshift stage ($H_0: 2-1$). The gradual trial by trial increase of the attentional response strength, even when the Ss were responding correctly, is clearly indicated. Figures 9, 10, 11 show the pre- and postshift stages of the separate treatment groups. The group size is now reduced to sixteen and hence the curves are less smooth. In the ID group (Figure 9), because the relevant preshift dimension remained relevant in the postshift stage, the attentional response transferred through the shift into the postshift stage and increased in strength ($H_0: 3-1$). Whilst the attentional response transferred through the shift, the correct response strength dropped to chance on the first trial and then regained its former strength. In the ED group (Figure 10) because the preshift relevant dimension became irrelevant in the postshift stage, the attentional response slowly dropped back to chance ($H_0: 4-1$) as the

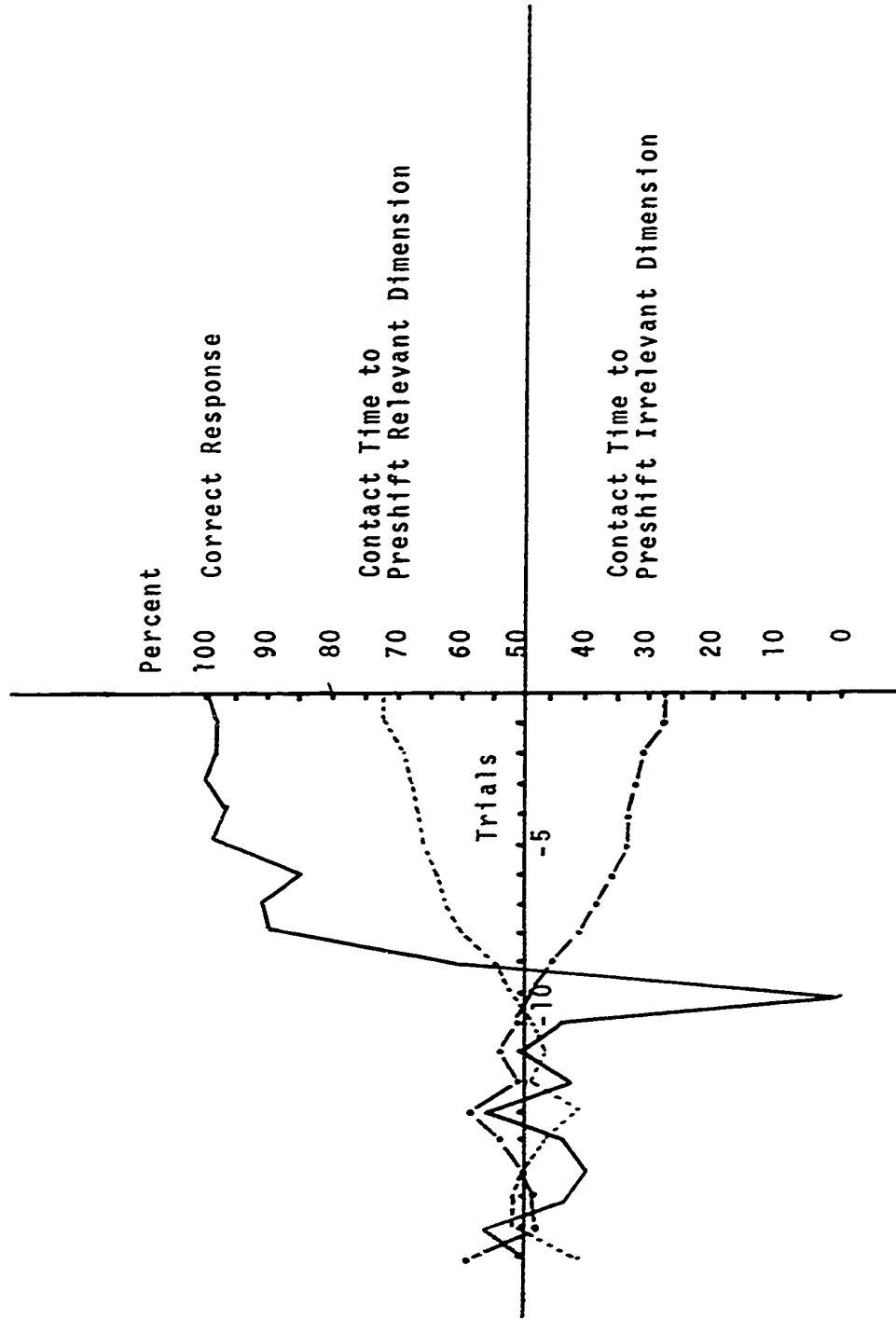

Fig. 8. Mean percentage backward curves for the combined preshift 10-ED-0L-crit. group (N=64)

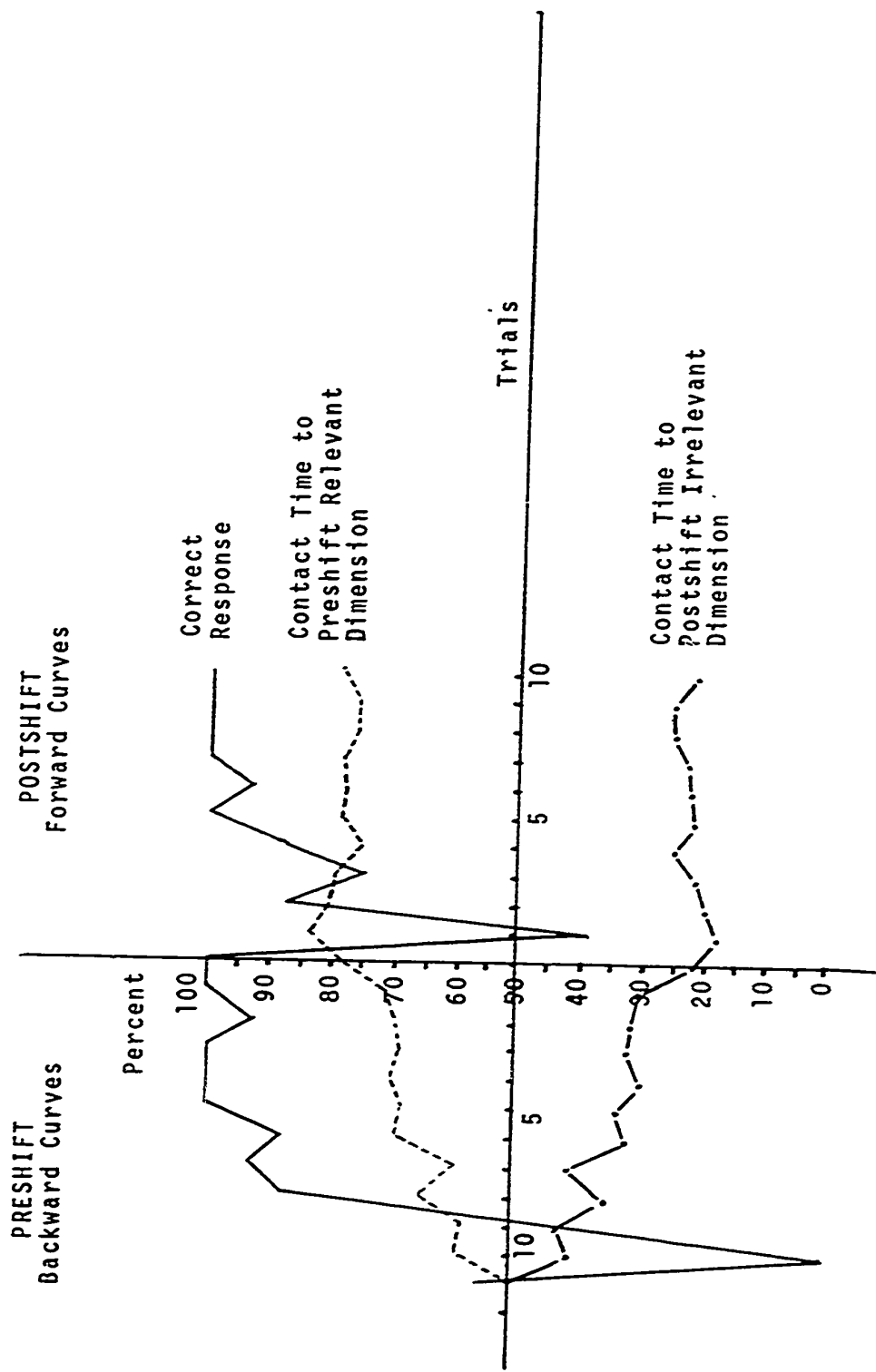

Fig. 9. Mean percentage curves for the criterion intradimensional group (N=16)

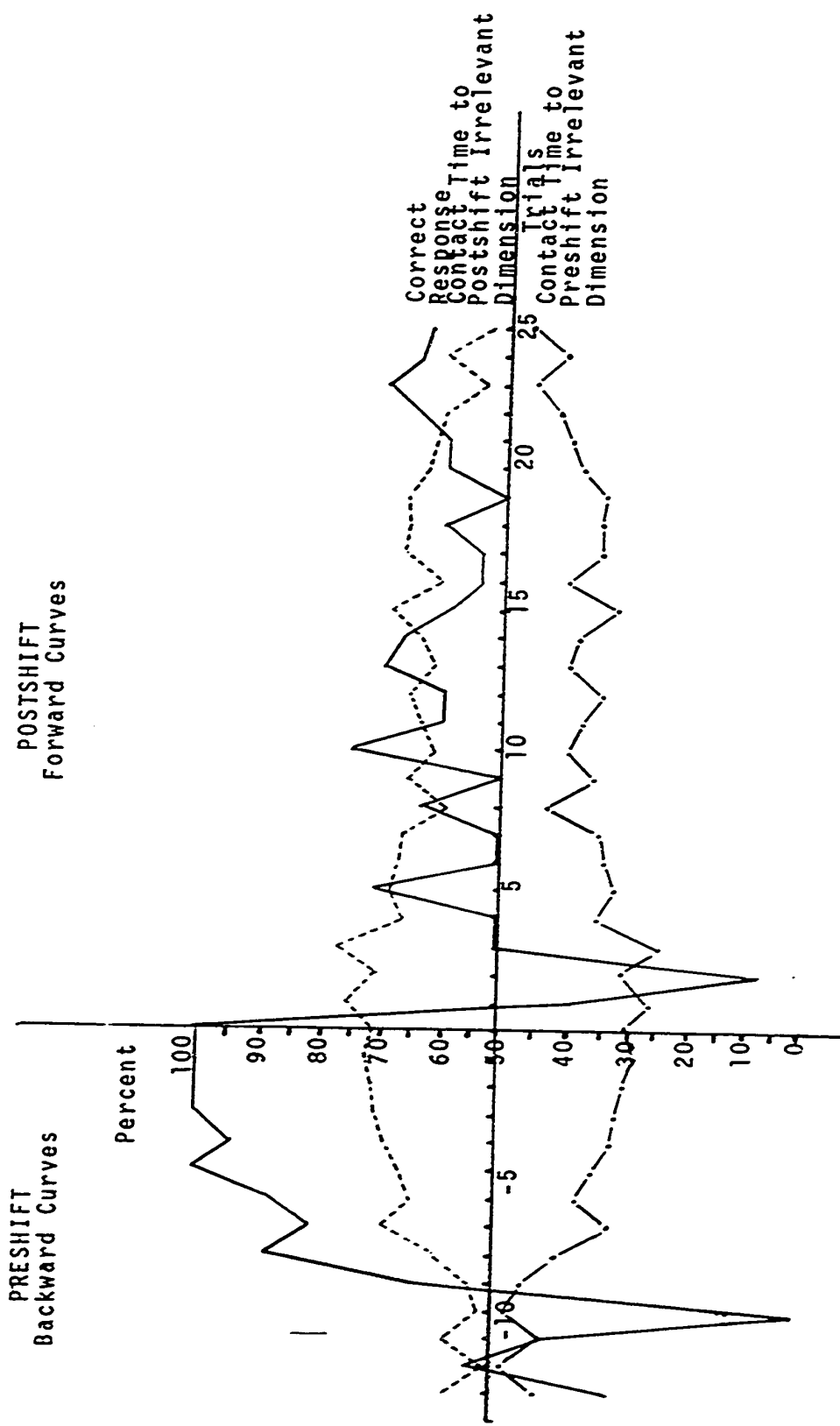

Fig. 10. Mean percentage curves for the criterion extradimensional group (N=16)

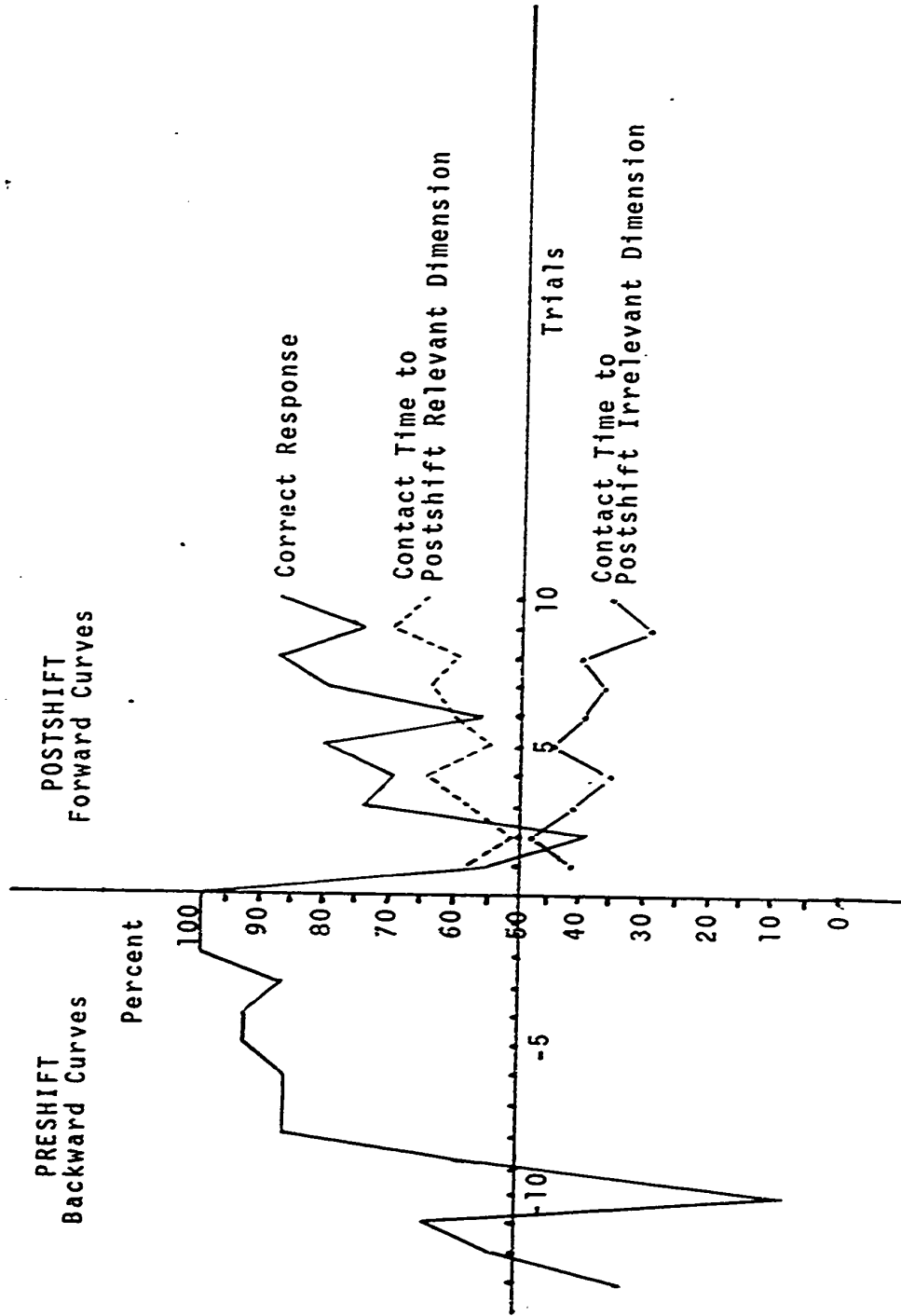

Fig. 11. Mean percentage curves for the criterion control group (N=16)

correct response strength fluctuated around the chance level. The attentional response to the preshift relevant dimension remained above chance in the ED shift until the postshift learning took place, when it dropped below the chance level. In the control group (Figure 11), no measures were taken of the attentional responses in the preshift stage because of the nature of the dimensions involved. In the control group, because new dimensions were introduced in the postshift stage, the attentional responses to the postshift relevant dimension increased from chance as the trials progressed ($H_0: 5-1$).

Figures 12 and 13 show the postshift learning phase of each criterion group. These graphs would be the corresponding end section of Figures 9, 10 and 11 plotted as backward curves. In the ED criterion group (Figure 12) when learning occurred, the attentional response to the preshift relevant dimension dropped to below chance, whilst the attentional response to the preshift irrelevant dimension increased. In the ID group (Figure 13) when learning occurred, the attentional response to the preshift relevant dimension was still high. In the control group (Figure 13), when learning took place, the attentional response to the postshift relevant dimension increased ($H_0: 5-1$).

Figures 14, 15 and 16 show the pre- and postshift curves for the overlearning groups. In the ID and ED groups (Figures 14 and 15) the attentional response continued to increase during the overlearning phase ($H_0: 2-2$), even

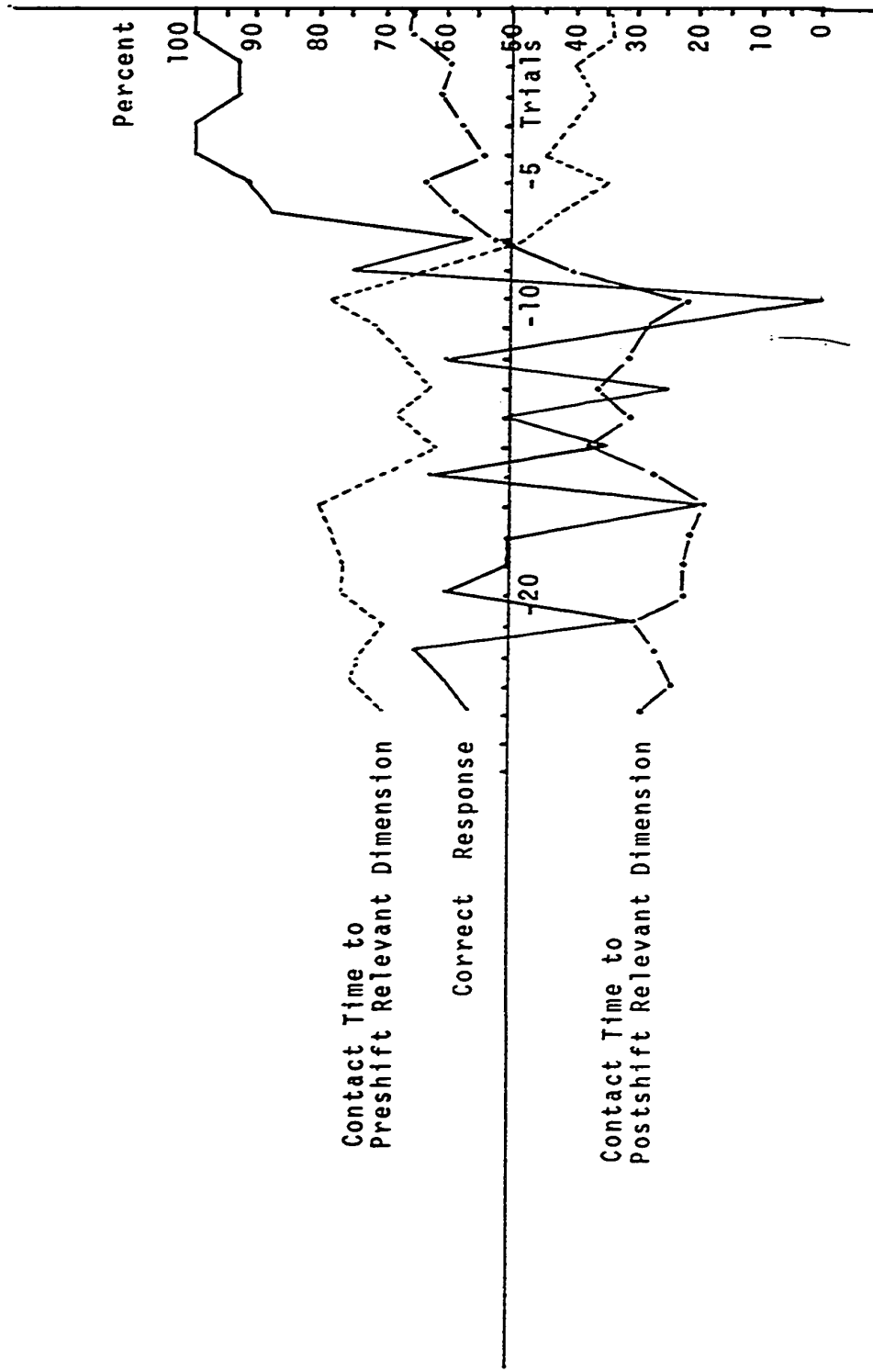

Fig. 12. Mean percentage postshift backward curves for the criterion extradimensional group (N=16)

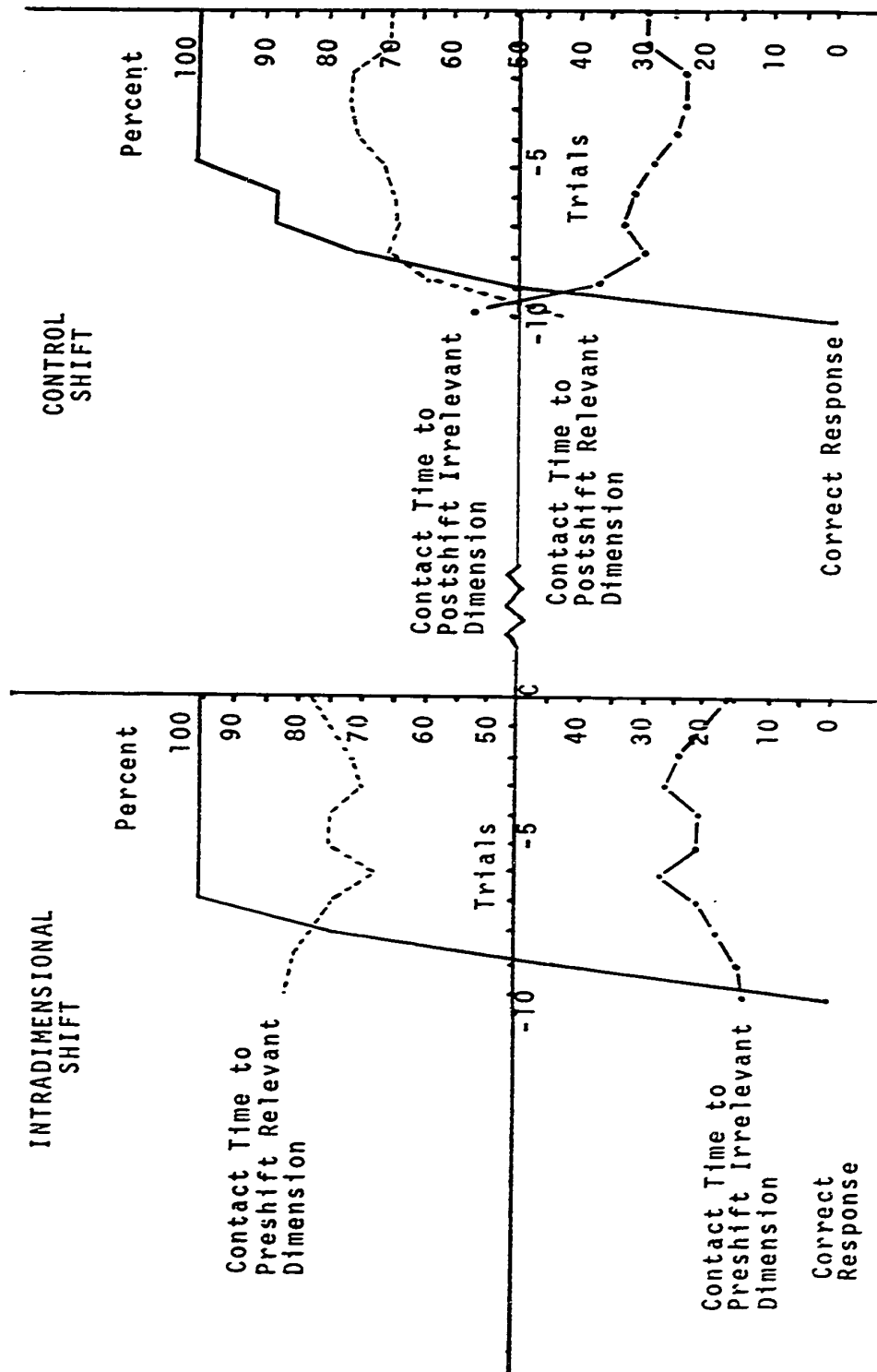

Fig. 13. Mean percentage postshift backward curves for the criterion intradimensional and criterion control groups (N=16)

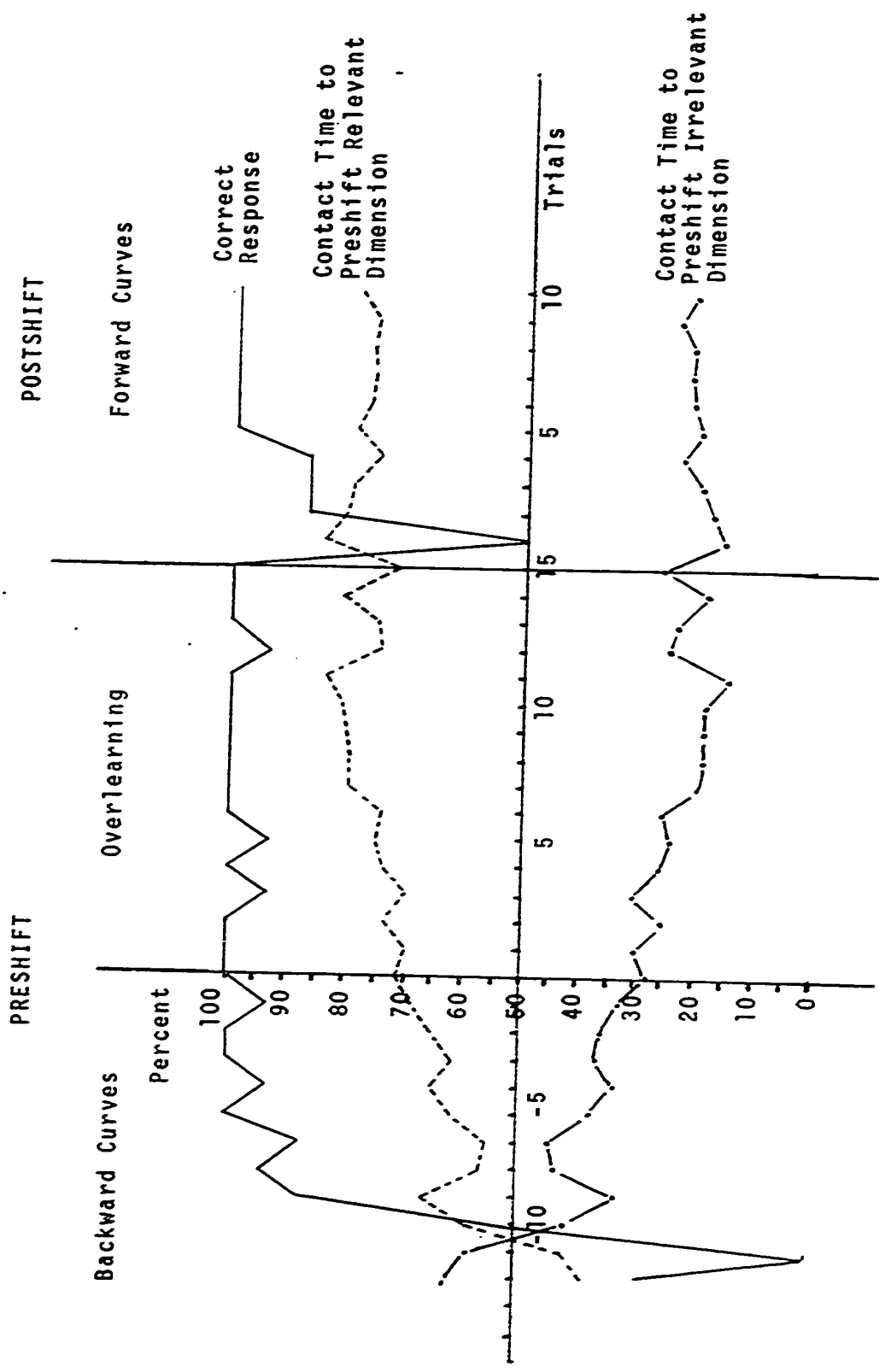

Fig. 14. Mean percentage curves for the overlearning intradimensional group (N=16)

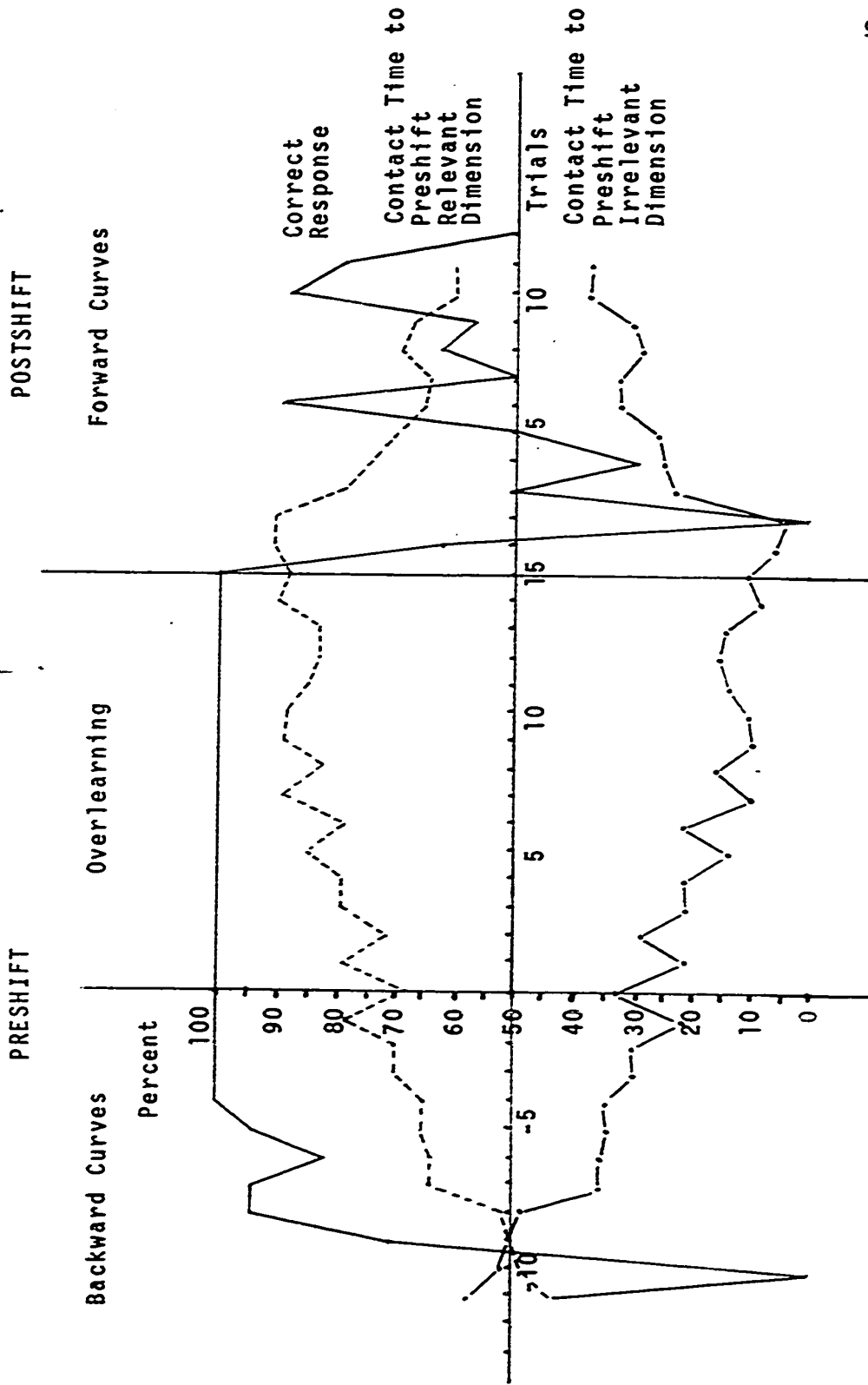

Fig. 15. Mean percentage curves for the overlearning extradimensional group (N=16)

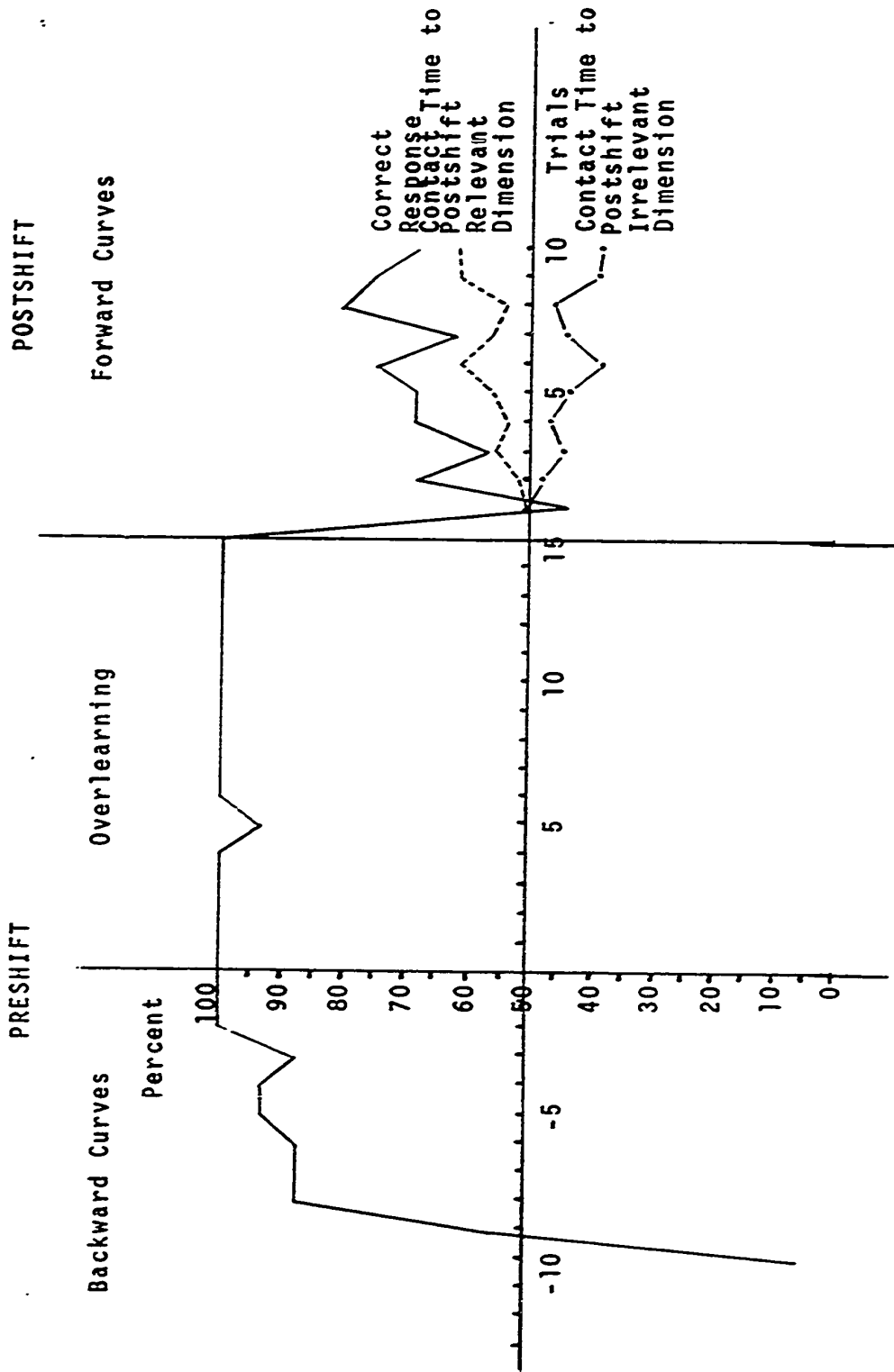

Fig. 16. Mean percentage curves for the overlearning control group (N=16)

though the Ss were responding correctly. In the ID group postshift stage, the attentional response strength remained high ($H_0: 3-2$), whilst the correct response strength fell to chance and regained its former strength on the second trial. In the ED overlearning postshift stage (Figure 15), the attentional responses dropped ($H_0: 4-2$) as the correct response strength fell and fluctuated. The attentional response strength to the preshift relevant dimension, as in the criterion ED group, remained well above the chance level until postshift learning took place. In the control overlearning group (Figure 16), the attentional response to the postshift relevant dimension built up in the postshift stage ($H_0: 5-2$) as postshift learning took place. The effect of overlearning on the control group had no effect on the postshift percentage touching time ($H_0: 5-3$). It was shown previously (p. 59) that the mean total errors in the two postshift control groups were not significantly different. Failure to reject $H_0: 5-3$ adds further weight to the evidence for non-transfer of a mediating attentional response in the control groups.

Figures 17 and 18 show the postshift learning phase for the overlearning groups. These curves correspond to the curves of the criterion groups (Figures 13 and 14), and are similarly interpretable. From the graphs (Figures 17, 18, 12 and 13) it can be seen that the magnitudes of the relevant attentional responses at the end of the postshift learning in both the criterion and overlearning groups were

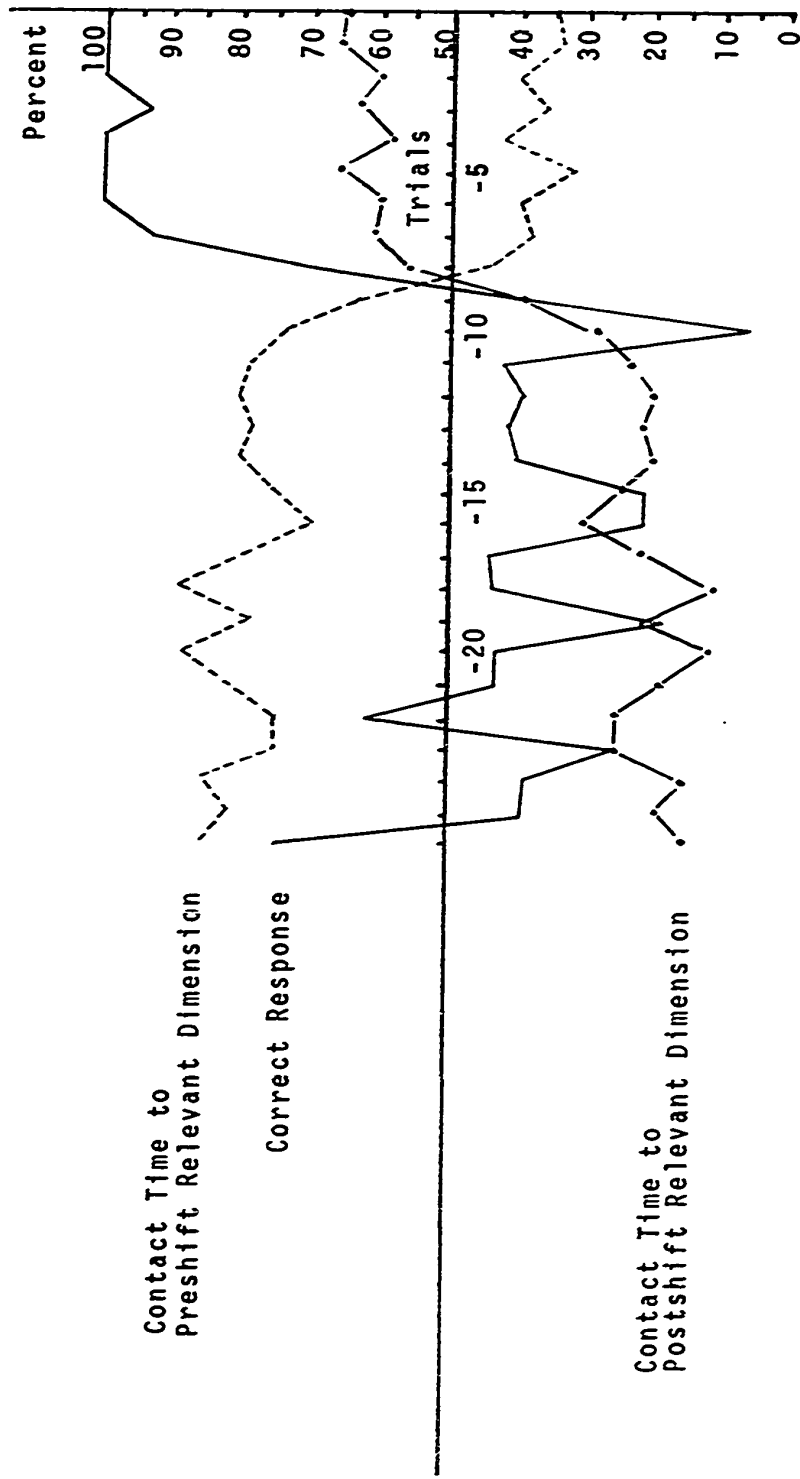

Fig. 17. Mean percentage postshift backward curves for the overlearning extradimensional group (N=16)

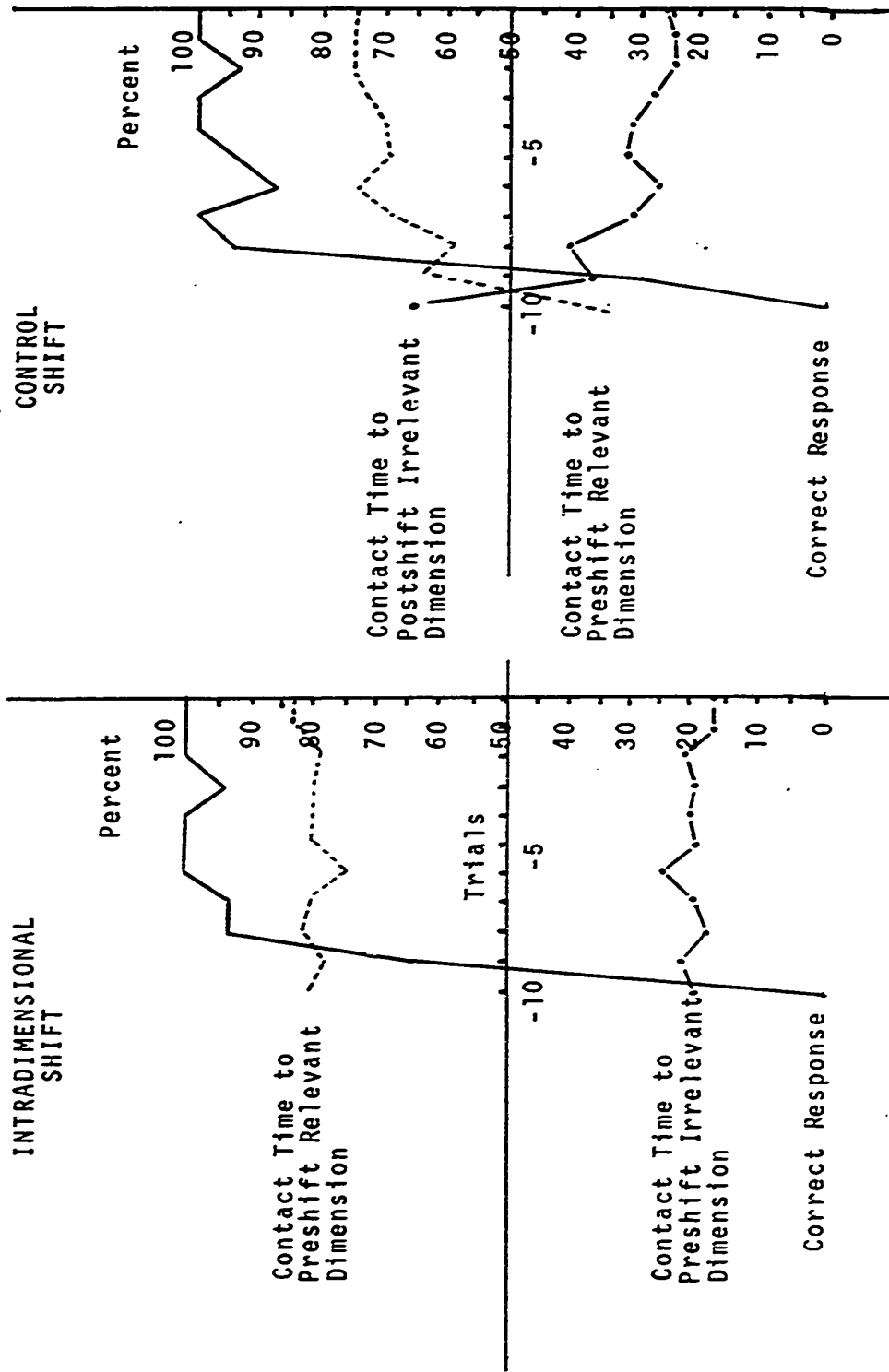

Fig. 18. Mean percentage postshift backward curves for the overlearning intradimensional and overlearning control groups (N=16)

approximately the same. In the ID groups this is to be expected as the relevant dimension in the preshift stage is the relevant dimension in the postshift stage, and the attentional response has, by the end of the postshift learning, reached a maximum. In the ED group, the fact that the strength of the attentional response at the end of the postshift stage is approximately the same for the criterion and OL groups is indicative of similar rates of acquisition of the relevant postshift attentional response once the postshift learning has taken place. It follows that the difference in ease of learning between the criterion and OL groups is a product of the difference in the strength of the preshift relevant dimensional attentional responses at the commencement of the postshift phase. Figures 9, 10, 14 and 15 further illustrate this point and support the comments on the overlearning effects made earlier in the chapter (p. 78). If the criterion for learning were made four out of five correct responses instead of nine out of ten as in this study, then the effect would be one of moving the zero vertical line on the graphs illustrated in Figures 10 and 15 over to the left (say five trials). If the number of overlearning trials were increased to twenty (arbitrarily chosen so that the graphs illustrate the argument), then the difference in the final strength of the attentional response would be increased accordingly. Figures 9 and 14 illustrate this point further. The resulting differential positive and negative transfer of the mediating response is

greater, and the overlearning effect more pronounced. These results illustrate the great care that must be taken in comparing apparently similar studies that differ in criterion for learning.

Summary

In this chapter the analysis of the preshift and postshift learning, and the analysis of the attentional dimensional-specific responses were discussed. Backward learning curves and graphs of the trial by trial learning and trial by trial changes in the tactile attentional responses were presented. The results of the study were shown to substantiate a mediating selective attentional model of discrimination learning such as the Zeaman and House model or the Lovejoy model.

CHAPTER VII

SUMMARY, CONCLUSIONS AND FURTHER RESEARCH

Summary

The Purpose of the Study

The main aim of the study was to investigate, in a tactile discrimination shift task, selective attentional responses under the effect of overlearning. In order to do this, it was necessary to derive an index of selective attention. A measure of this response was obtained in terms of percentage dimensional touching time per trial.

The Sample

The sample consisted of 48 male and 48 female subjects, randomly chosen from the total Grade III population at Braemar Public School in the Edmonton School system.

The Method

Ss were trained on a tactile discrimination task involving two values of each of two distinct dimensions, and using the index finger only as a means of discriminating between the stimuli. One half of the Ss were overtrained, then the Ss executed either an ID shift, an ED shift, or a control shift. Measures of the choice responses and the time spent touching each particular value of the dimension were obtained.

The Findings

An analysis of the postshift choice response data showed that, in ease of learning, the intradimensional shift was the easiest, the extradimensional shift was most difficult, and the control group was midway between. A similar relative position was obtained after overlearning. When the control group was used as a reference, the study showed that both negative and positive transfer of mediating responses took place at both levels of learning.

The effect of overlearning on the shift performance was to make the ID shift easier, and the ED shift harder, with the control group performance remaining relatively constant; however, these findings did not reach statistical significance at the .05 level. Further evidence for the effect of OL on the shift performance was provided by examining the differing lengths of the presolution plateau in backward learning curves plotted for each group during postshift learning. The results of this analysis showed that, in the two levels of learning, the ID group presolution plateau became shorter, the ED group presolution plateau became longer, and the control group presolution plateau remained relatively constant. All of these results are directly interpretable in terms of a mediational theory of discrimination learning.

An analysis of tactile responses gave support to a selective attentional mediating theory. In the preshift stage the relevant attentional responses built up in the

criterion groups and continued to approach asymptote during the OL period. In the ID groups, in the trials immediately following the shift, the relevant attentional responses increased in the criterion level of learning, and remained relatively constant in the OL group, whilst the correct response strength dropped to chance and then recovered its former strength. In the trials immediately following the shift in the ED groups, the preshift relevant attentional responses slowly dropped to chance level, and then fell below chance level as the postshift relevant attentional response built up. In the same period the correct response strength dropped to chance and remained there until postshift learning took place. In the control group, the postshift attentional responses increased from chance as postshift learning took place. Figures 19 and 20 show a summary in graph form of the results of the study. As these graphs have already been discussed no further comment is necessary.

Conclusions

The results of this study give strong support to a selective attentional mediating theory of discrimination learning. Whether similar results using a visual index of selective attention would be obtained for the visual modality remains an open question. The work of Zaporozhets (1965) in the study of exploratory movements in the visual and haptic modalities suggests similar developmental modal

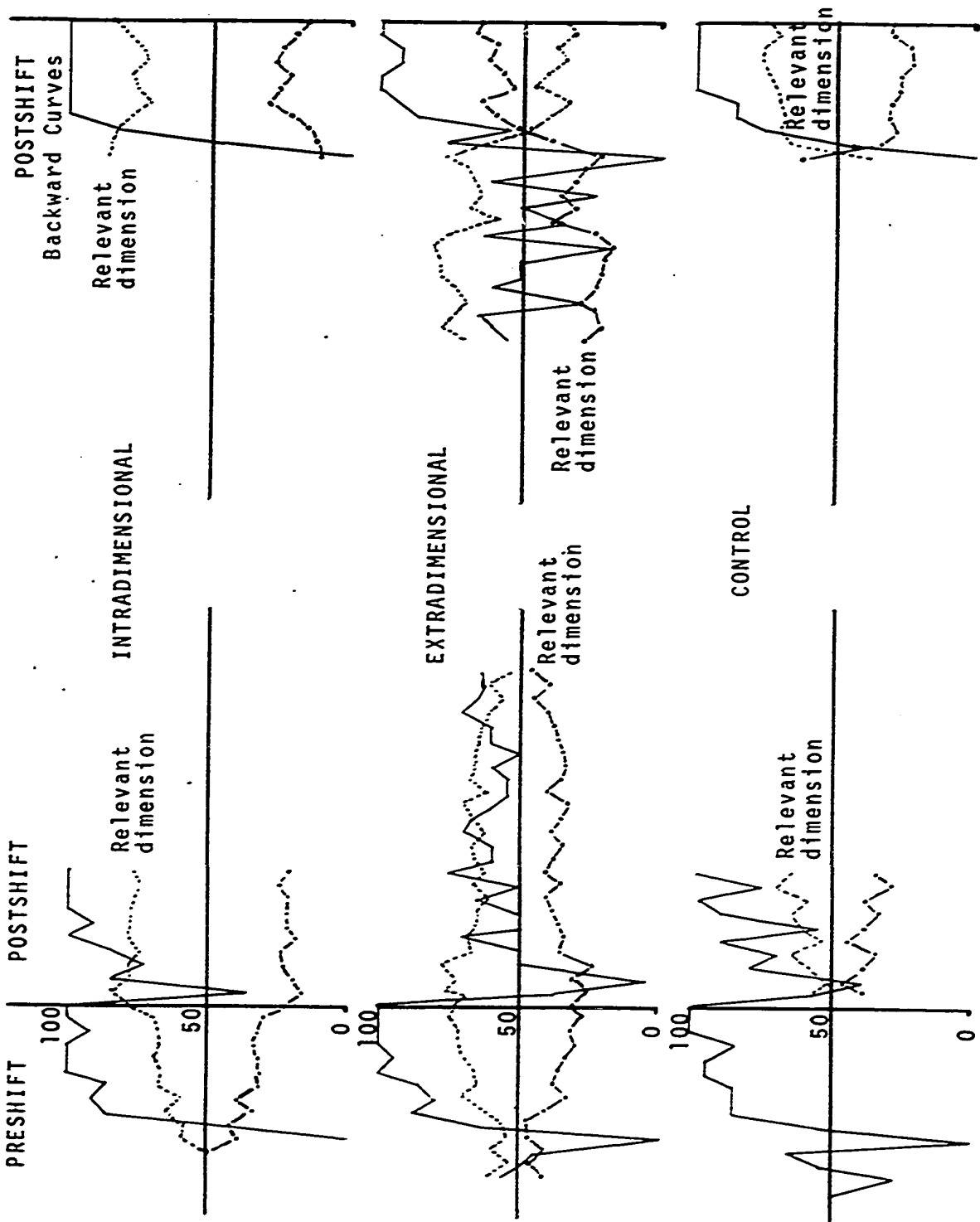

Fig. 19. Summary graphs for the criterion ID, ED, Cont. groups

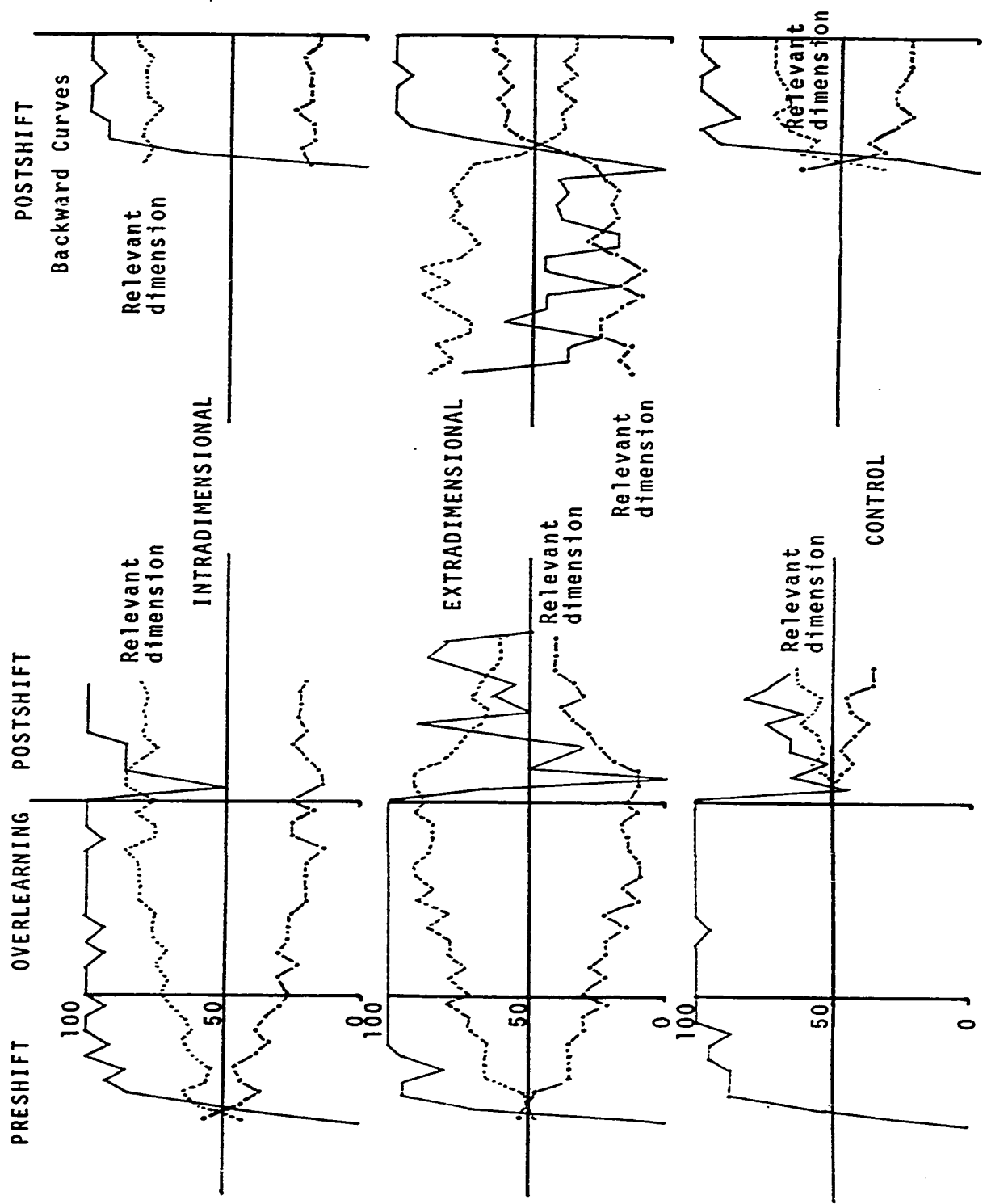

Fig. 20. Summary graphs for the overlearning ID, ED, Cont. groups

processes. At the same time there is evidence that these modal processes may differ when a distinction is made between preferential and forced mode of behaviour (Reese & Lipsitt, 1970). The writer is inclined to assume the functioning of similar processes in the two modalities, with the haptic modality being less subject to noise factors. Research on discrimination learning using eye movement measurements could offer comparative information in the visual modality.

Although this study offers strong support for selective attentional mediating theories, it does not deny the importance of verbal or imagery activities in organizing selective attention. The extent to which verbal labels direct the selective attention and developmental differences in the organization of attention by verbal cues needs further research. Previous studies along these lines have, by nature of the design, failed to isolate the factors of selective attention and verbal ability. Now that this study has shown, in the haptic modality, that a measure of selective attention is interpretable in terms of selective attentional models, then a study, with differing age levels, using the techniques of the present study and incorporating verbal factors in the design, could provide information on the relative strengths of the verbal and attentional factors at particular age levels.

Blank and Klig (1970) in a study of cross-modal transfer with four-year-old Ss, suggest imagery as a possible

means of mediating transfer. A number of Ss in the present study were asked to draw and label, if possible, the stimuli after they had finished the task. Some Ss were unable to do this or provide verbal labels, even though they had no difficulty with the task proper. Of the Ss who were able to provide drawings, many of the drawings were abnormal in the sense that certain features were grossly exaggerated. For example, the square was drawn with points like a star, which fact suggests the corner of the square was the identifying feature when compared with the circle. The cross was drawn with as many as nine arms, which suggests the arms were the identifying feature when compared with a triangle. In some cases even the influence of preshift forms was clearly evident. From these observations it seems that some Ss use only certain parts of the stimuli for identification purposes and form images which are peculiar to the S himself. These individual styles of identification, like verbal facilitation, may very well be developmental in nature.

The results of this study show that selective attention, as defined in this study, is directly or indirectly influenced by reinforcement. This has important implications for education. In concept formation the sooner the S can abandon irrelevant cues and attend to relevant attributes, the sooner he is able to acquire the concept. Similarly, problem-solving transfer will be facilitated with procedures that increase the probability of attending

to relevant cues. Teachers need to decide what is important in a problem and to emphasize the important features, whilst at the same time "impoverishing the environment of distracting cues (Meacham and Wiesen, 1969)."

Further Research

Possible research areas have already been hinted at in the preceding section. The following areas are given in summary.

- (1) More studies in the haptic modality at differing age levels to investigate the changes, if any, of selective attentional responses in Ss of different age levels.
- (2) More studies in the haptic modality investigating and controlling such factors as verbal and imagery influences.
- (3) A more detailed analysis of dimensional-specific responses in terms of the selective attentional theory models with the aim of identifying parameters.
- (4) Comparative studies using eye movement recordings to investigate the differences, if any, in selective attention patterns in the different modalities.
- (5) More discrimination studies in the haptic modality with the aim of getting at individual styles of learning.
- (6) A replication using the techniques of this study and using prescaled stimuli, of the more important studies in visual discrimination, such as those indicating the importance of dimensional preferences.
- (7) An investigation of the overlearning reversal effect using the techniques of this study.
- (8) The effect of varying the criterion for learning on the attentional response investigated, using the techniques developed in this study.

SELECTED REFERENCES

- Amsel, A. Frustrative nonreward in partial reinforcement and discrimination learning: Some recent history and a theoretical extension. Psychological Review, 1962, 69, 306-328.
- Berlyne, D. E., Conflict, Arousal and Curiosity, N.Y.: McGraw-Hill, 1960.
- Berlyne, D. E., Attention as a problem in behaviour theory. In D. I. Mostofsky (Ed.), Attention: Contemporary Theory and Analysis, N.Y.: Appleton-Century-Crofts, 1970.
- Biederman, G. B. Continuity theory revisited: A failure in a basic assumption. Psychological Review, 1970, 77, 225-256.
- Birch, D., Ison, J. R., & Sperling, S. E. Reversal learning under single stimulus presentation. Journal of Experimental Psychology, 1960, 60, 36-40.
- Blank, M., & Altman, D. L. Effect of stimulus modality and task complexity on discrimination and reversal learning in preschool children. Journal of Experimental Psychology, 1968, 598-606.
- Blank, M., Altman, D. L., & Bridger, W. H. Crossmodal transfer of form discrimination in preschool children. Psychonomic Science, 1968, 10(2), 51-52.
- Blank, M., & Klig, S. Dimensional learning across sensory modalities in nursery school children. Journal of Experimental Child Psychology, 1970, 166-173.
- Broadbent, D. E., A mechanical model for human attention and immediate memory. Psychological Review, 1957, 64, 205-215.
- Brown, A. Transfer performance in oddity learning. Journal of Experimental Psychology, 1970, 9, 307-319.
- Buss, A. H. Rigidity as a function of reversal and non-reversal shifts in the learning of successive discriminations. Journal of Experimental Psychology, 1953, 45, 75-81.
- Corah, N. L. The influence of some stimulus characteristics on color and form perception in nursery school children. Child Development, 1966, 37, 205-212.

- Cross, H. A., & Tyler, Z. E. The overlearning reversal effect in preschool children as a function of age. Psychonomic Science, 1966, 6, 175-176.
- D'Amato, M. R. & Jagoda, H. Analysis of the role of overlearning in discrimination learning. Journal of Experimental Psychology, 1961, 1, 45-50.
- Deutsch, J. A., & Deutsch, D. Attention: Some theoretical considerations. Psychological Review, 1963, 70, 80-90.
- Ehrenfreund, D. Experimental test of the continuity theory of discrimination learning with pattern vision. Journal of Comparative Psychology, 1948, 41, 408-422.
- Eimas, P. D. Effects of overtraining and age on intradimensional and extradimensional shifts in children. Journal of Experimental Child Psychology, 1966a, 3, 348-355.
- Eimas, P. D. Effect of overtraining, irrelevant stimuli, and training track on reversal discrimination learning in children. Journal of Experimental Psychology, 1966b, 3, 315-323.
- Eimas, P. D. Observing responses, attention, and the overlearning reversal effect. Journal of Experimental Psychology, 1969, 82, 499-502.
- Eimas, P. D., Attentional processes. In H. W. Reese & L. P. Lipsitt (Eds.), Experimental Child Psychology. N. Y., Academic Press, 1970.
- Elkind, D. A Sympathetic Understanding of the Child Six to Sixteen. Boston: Allyn and Bacon, Inc., 1971.
- Fellows, B. J. The Discrimination process and development. Oxford. Pergamon Press Ltd., 1968.
- Furth, H. G. & Youniss, J. Effects of overtraining on three discrimination shifts in children. Journal of Comparative and Physiological Psychology, 1964, 57, 290-293.
- Gellerman, L. W. Chance orders of alternating stimuli in visual discrimination experiments. Journal of Genetic Psychology, 1933, 42, 206-208.
- Gibson, J. J., & Gibson, E. J. Perceptual learning: Differentiation or enrichment. Psychological Review, 1955, 62, 32-41.

- Gliner, C. R., Pick, A. D., Pick, H. L., & Hales, J. J. A developmental investigation of visual and haptic preferences for shape and texture. Monographs of the Society for Research in Child Development, 1969, 34, 6, No. 130.
- Goodwin, W. R., & Lawrence, D. H. The functional independence of two discrimination habits associated with a constant stimulus situation. Journal of Comparative and Physiological Psychology, 1955, 48, 437-443.
- Gollin, E. S. Reversal learning and conditional discrimination learning in children. Journal of Comparative and Physiological Psychology, 1964, 58, 441-445.
- Harlow, H. F. Learning set and error factor theory. In S. Koch (Ed.) Psychology: A Study of Science, Vol. 2., N. Y., McGraw Hill, 1959.
- Harrow, M., & Friedman, G. B. Comparing reversal and non-reversal shifts in concept formation with partial reinforcement controlled. Journal of Experimental Psychology, 1958, 55, 592-598.
- Hayes, K. G. The backward curve: A method for the study of learning. Psychological Review, 1953, 60, 269-275.
- Heal, L. W. The role of cue value, cue novelty, and over-training in the discrimination shift performance of retardates and normal children of comparable discrimination ability. Journal of Experimental Child Psychology, 1966, 4, 126-142.
- Hernandez-Peon, R. Physiological mechanisms in attention. In R. W. Russell (Ed.) Frontiers in Physiological Psychology, N. Y.: Academic Press, 1963.
- Hull, C. L. A Behaviour System. New Haven: Yale University Press, 1952.
- Hull, C. L. Knowledge and purpose as habit mechanisms. Psychological Review, 1930, 37, 511-525.
- Huttenlocher, J. Children's ability to order and orient objects. Child Development, 1967, 38, 1169-1176.
- Imai, S., & Garner, S. I. Discriminability and preference for attributes in free and constrained classification. Journal of Experimental Psychology, 1965, 69, 596-608.

- Isaacs, I. D., & Duncan, C. P. Reversal and nonreversal shifts within and between dimensions in concept formation. Journal of Experimental Psychology, 1962, 64, 580-585.
- James, L. M., O'Brien, T. G., & Brinley, J. F. The effect of dimensional preference on reversal shift behaviour of young children. Psychonomic Science, 1969, 14, 56-58.
- Kendler, H. H., & D'Amato, M. F. A comparison of reversal and non-reversal shifts in human concept formation behaviour. Journal of Experimental Psychology, 1955, 49, 165-174.
- Kendler, T. S., Basden, B. H., & Bruckner, J. B. Dimensional dominance and continuity theory. Journal of Experimental Psychology, 1970, 83, 309-318.
- Kendler, H. H., & Kendler, T. S. Vertical and horizontal processes in problem solving. Psychological Review, 1962, 69, 1-16.
- Kendler, T. S. & Kendler, H. H. Reversal and non-reversal shifts in kindergarten children. Journal of Experimental Psychology, 1959, 58, 56-60.
- Kendler, T. S., & Kendler, H. H. Optional shifts of children as a function of number of trials on the initial discrimination. Journal of Experimental Child Psychology, 1966, 3, 216-229.
- Kendler, T. S., Kendler, H. H., & Learnard, B. Mediated responses to size and brightness as a function of age. American Journal of Psychology, 1962, 75, 571-586.
- Kendler, H. H., Kendler, T. S., & Sanders, J. Reversal and partial reversal shifts with verbal materials. Journal of Verbal Behaviour and Verbal Learning, 1967, 6, 117-127.
- Kendler, H. H., & Kendler, T. S. Reversal shift behaviour: Some basic issues. Psychological Bulletin, 1969, 72, 229-232.
- Krechavsky, I. A study of the continuity of the problem solving process. Psychological Review, 1938, 45, 107-133.
- Kuenne, M. K. Experimental investigation of the relation of language to transposition behaviour in young children. Journal of Experimental Psychology, 1946, 36, 471-490.

- Lashley, K. S. Brain Mechanisms and Intelligence. University of Chicago Press, 1938.
- Lawrence, D. H. Acquired distinctiveness of cues: I Transfer between discriminations as the basis of familiarity with the stimulus. Journal of Experimental Psychology, 1949, 39, 770-784.
- Lawrence, D. H. Acquired distinctiveness of cues: II Selective association in a constant stimulus situation, Journal of Experimental Psychology, 1950, 40, 175-188.
- Lee, L. C. Concept utilization in pre-school children. Child Development, 1965, 36, 221-227.
- Lovejoy, E. P. An attention theory of discrimination learning. Journal of Mathematical Psychology, 1965, 2, 342-362.
- Lovejoy, E. P. Analysis of the overlearning reversal effect. Psychological Review, 1966, 73, 87-103.
- Lovejoy, E. P. Attention in Discrimination Learning. San Francisco: Holden Day, 1968.
- Mackintosh, N. J. The effect of overtraining on a reversal and a nonreversal shift. Journal of Comparative and Physiological Psychology, 1962, 55, 555-559.
- Mackintosh, N. J. The role of selective attention in animal discrimination learning, Psychological Bulletin, 1964, 2, 124-250.
- Mackintosh, N. J. Attention and probability learning. In D. I. Mostofsky (Ed.), Attention: Contemporary Theory and Analysis. N. Y.: Appleton-Century-Crofts, 1970.
- Marsh, G. Effect of overtraining on reversal and non-reversal shifts in nursery school children. Child Development, 1964, 35, 1367-1372.
- Meacham, M. L., & Wiesen, A. E. Changing Classroom Behaviour. International Text Book, 1969.
- Mostofsky, D.I. The semantics of attention. In D. I. Mostofsky (Ed.), Attention: Contemporary Theory and Analysis, N. Y.: Appleton-Century-Crofts, 1970.
- Miller, N. E., & Dollard, J. C. Social Learning and Imitation, New Haven, Yale University Press, 1941.
- Prokasy, W. F., & Hall, J. F. Primary Stimulus generalization. Psychological Review, 1963, 70, 310-322.

- Reese, H. W., & Lipsett, L.P. (Eds.), Experimental Child Psychology, N. Y.: Academic Press, 1970.
- Reid, L. S. The development of non-continuity behaviour through continuity learning. Journal of Experimental Psychology, 1953; 46, 107-112.
- Reudal, R. G., & Teuber, H. L. Discrimination of direction of line in children. Journal of Comparative Physiological Psychology, 1963, 56, 892-898.
- Riley, D. A. Discrimination Learning, Allyn and Bacon, Inc., Boston, 1968.
- Rydberg, S. Concept learning: Measured selective attending changes. Psychonomic Science, 1969, 16, 293-295.
- Rydberg, S., & Arnberg, P. W. Selective attending changes during concept learning, extinction and superstition. Psychonomic Science, 1969a, 17, 99-100.
- Rydberg, S. & Arnberg, P. W. Overlearning, extinction and superstition effects on observing behaviour in concept learning. Psychonomic Science, 1969b, 17, 343-344.
- Rydberg, S., Kashdan, R., & Trabasso, T. Recordings of tactile observing responses for the study of selective attention. Psychonomic Science, 1966, 6, 197-198.
- Shepp, B. B., & Turrisi, F. D. Learning and transfer of mediating responses in discrimination learning. In N. R. Ellis (Ed.), International Review of Research in Mental Retardation. Vol. 2. N.Y., Academic Press, 1967.
- Shepp, B. B., & Turrisi, F. D. Effects of overtraining on the acquisition of intradimensional and extradimensional shifts. Journal of Experimental Psychology, 1969, 82, 46-51.
- Slamecka, N. J. A methodological analysis of shift paradigms in human discrimination learning. Psychological Bulletin, 1968, 69, 423-438.
- Spence, K. W. The nature of discrimination learning in animals. Psychological Review. 1936, 43, 427-449.
- Spence, K. W. Continuous vs. noncontinuous interpretations of discrimination learning. Psychological Review, 1940, 47, 271-288.

- Stevenson, H. W., & Zigler, E. F. Discrimination learning and rigidity in normal and feebleminded individuals. Journal of Personality, 1957, 25, 699-711.
- Suchman, R. G., & Trabasso, T. Color and form preferences in young children. Journal of Experimental Child Psychology, 1966, 3, 177-187.
- Sugimura, T. Effects of overtraining and reward magnitude on reversal learning in nursery school children. Journal of Nara Gakuji University, 1965, 183-191.
- Sutherland, N. S. Stimulus analysing mechanisms in Proceedings of a Symposium on the Mechanization of Thought Processes, Vol. 2, London, H.M.S.O., 1959.
- Tempone, B. J., & Capehart, J., Atwood, G. L., & Golding, S. The overtraining reversal effect under two types of discrimination. Psychonomic Science, 1966, 5, 229-230.
- Tighe, L. S., & Tighe, T. J. Overtraining and discrimination shift behaviour in children. Psychonomic Science, 1965, 2, 365-366.
- Tighe, L. S., & Tighe, T. J. Discrimination learning. Two views in historical perspective. Psychological Bulletin, 1966, 5, 353-370.
- Tighe, T. J., & Tighe, L. S. Perceptual learning in the discrimination processes of children: an analysis of five variables in perceptual pretraining. Journal of Experimental Psychology, 1968, 77, 125-234. (a)
- Tighe, T. J., & Tighe, L. S. Transfer from perceptual pretraining as a function of number of stimulus values per dimension, Psychonomic Science, 1968, 12, 135-136. (b)
- Trabasso, T., & Bower, G. H. Attention in Learning, N. Y., Wiley, 1968.
- Trabasso, T., Stave, M., & Eichberg, R. Attribute preferences and discrimination shifts in young children. Journal of Experimental Child Psychology, 1969, 8, 195-209.
- Treisman, A., & Geffen, G. Selective Attention: Perception or Response? Quarterly Journal of Experimental Psychology, 1967, Vol. XIX, Part 1.

- Turrisi, F. D. Discrimination learning: whence and where to. Unpublished paper presented at Gatinburg conference on mental retardation, March, 1970.
- Vincent, S. B. The function of the vibissae in the behavior of the white rat. Behavior Monographs, 1912, 1, No. 5.
- Vurpillot, E. The development of scanning strategies and their relation to visual differentiation. Journal of Experimental Child Psychology, 1968, 6, 632-650.
- Watson, J. B. Psychology from the standpoint of a Behaviorist. Philadelphia, Lippincott, 1919.
- White, S. H. Evidence for a hierarchial arrangement of learning processes in L.P. Lipsitt & C. C. Spiker, (Eds.), Advances in Child Psychology, Vol. 2.
- White, R. M., & Johnson, P. J. Concept of dimensionality and optional shift performance in nursery school children. Journal of Experimental Child Psychology, 1968, 6, 113-119.
- Wolff, J. L. Concept-shift and discrimination-reversal learning in humans. Psychological Bulletin, 1967, 68, 369-407.
- Wyckoff, L. B. The role of the observing response in discrimination learning. Psychological Review, 1952, 59, 431-442.
- Youniss, J., & Furth, H. G. Reversal learning in children as a function of overtraining and delayed transfer. Journal of Comparative and Physiological Psychology, 1964, 57, 155-157.
- Zaporozhets, A. V. The development of perception in the preschool child. In P. H. Mussen (Ed.), European research in cognitive development. Monographs of the Society for Research in Child Development, 1965, 30 (2, whole No. 100). Pp.82-101.
- Zaporozhets, A. V. The origin and development of the conscious control of movements in man. In N. O'Conner (Ed.), Recent Soviet Psychology. New York: Macmillan (Pergamon), 1961. Pp. 273-289.
- Zeaman, D., & House, B. J. The role of attention in retardate discrimination learning. In N. R. Ellis (Ed.), Handbook of Mental Deficiency. New York: McGraw-Hill, 1963.

APPENDIX A
RECORDING SHEETS FOR TRIAL BY TRIAL
INSTRUMENTAL RESPONSES

| | | | | | | | | | | | | | | | | | | | | |
|----|---|---|---|---|--|--|----|---|---|---|---|--|--|----|---|---|---|---|--|--|
| 1 | A | □ | B | ○ | | | 17 | A | □ | B | ○ | | | 33 | B | ○ | A | □ | | |
| 2 | B | □ | A | ○ | | | 18 | A | ○ | B | □ | | | 34 | A | □ | B | ○ | | |
| 3 | B | ○ | A | □ | | | 19 | B | □ | A | ○ | | | 35 | A | □ | B | ○ | | |
| 4 | B | □ | A | ○ | | | 20 | A | ○ | B | □ | | | 36 | B | ○ | A | □ | | |
| 5 | A | ○ | B | □ | | | 21 | B | ○ | A | □ | | | 37 | B | □ | A | ○ | | |
| 6 | A | ○ | B | □ | | | 22 | B | □ | A | ○ | | | 38 | A | □ | B | ○ | | |
| 7 | B | ○ | A | □ | | | 23 | A | □ | B | ○ | | | 39 | A | □ | B | ○ | | |
| 8 | B | □ | A | ○ | | | 24 | B | ○ | A | □ | | | 40 | A | ○ | B | □ | | |
| 9 | A | □ | B | ○ | | | 25 | A | □ | B | ○ | | | 41 | B | ○ | A | □ | | |
| 10 | A | □ | B | ○ | | | 26 | A | ○ | B | □ | | | 42 | A | ○ | B | □ | | |
| 11 | A | ○ | B | □ | | | 27 | B | □ | A | ○ | | | 43 | B | ○ | A | □ | | |
| 12 | B | ○ | A | □ | | | 28 | B | □ | A | ○ | | | 44 | B | □ | A | ○ | | |
| 13 | B | □ | A | ○ | | | 29 | A | ○ | B | □ | | | 45 | B | □ | A | ○ | | |
| 14 | A | □ | B | ○ | | | 30 | B | ○ | A | □ | | | 46 | A | ○ | B | □ | | |
| 15 | A | ○ | B | □ | | | 31 | B | □ | A | ○ | | | 47 | B | ○ | A | □ | | |
| 16 | B | ○ | A | □ | | | 32 | A | ○ | B | □ | | | 48 | A | □ | B | ○ | | |

| | | | | | | | | | | | |
|----|----------------|--|--|----|----------------|--|--|----|----------------|--|--|
| 1 | C Δ D + | | | 17 | C Δ D + | | | 33 | D + C Δ | | |
| 2 | D Δ C + | | | 18 | C + D Δ | | | 34 | C Δ D + | | |
| 3 | D + C Δ | | | 19 | D Δ C + | | | 35 | C Δ D + | | |
| 4 | D Δ C + | | | 20 | C + D Δ | | | 36 | D + C Δ | | |
| 5 | C + D Δ | | | 21 | D + C Δ | | | 37 | D Δ C + | | |
| 6 | C + D Δ | | | 22 | D Δ C + | | | 38 | C Δ D + | | |
| 7 | D + C Δ | | | 23 | C Δ D + | | | 39 | C Δ D + | | |
| 8 | D Δ C + | | | 24 | D + C Δ | | | 40 | C + D Δ | | |
| 9 | C Δ D + | | | 25 | C Δ D + | | | 41 | D + C Δ | | |
| 10 | C Δ D + | | | 26 | C + D Δ | | | 42 | C + D Δ | | |
| 11 | C + D Δ | | | 27 | D Δ C + | | | 43 | D + C Δ | | |
| 12 | D + C Δ | | | 28 | D Δ C + | | | 44 | D Δ C + | | |
| 13 | D Δ C + | | | 29 | C + D Δ | | | 45 | D Δ C + | | |
| 14 | C Δ D + | | | 30 | D + C Δ | | | 46 | C + D Δ | | |
| 15 | C + D Δ | | | 31 | D Δ C + | | | 47 | D + C Δ | | |
| 16 | D + C Δ | | | 32 | C + D Δ | | | 48 | C Δ D + | | |

APPENDIX B

SPECIMEN COMPUTER PRINTOUT FOR
ONE SUBJECT

HUNT DISCRIMINATION DATA
 UNTRAINED IN FORM

| TOTAL | TRACK 1 | TRACK 2 | TRACK 3 | TRACK 4 | FORM | TRPTURE | TCV | F | T | S | L/R | E |
|-------|------------|------------|-----------|-----------|------------|-----------|-----|---|---|----|-----|---|
| 1 | 0.2 50.0E | 0.1 60.0E | 0.5 40.0E | 0.5 50.3E | 0.5 50.3E | 0.4 49.7E | 1.6 | 0 | 4 | 11 | L | R |
| 2 | 1.4 40.0E | 2.1 60.0E | 1.5 41.7E | 2.1 50.3E | 2.6 50.7E | 1.5 49.3E | 2.0 | 1 | 0 | 7 | L | R |
| 3 | 2.5 40.0E | 2.6 41.0E | 3.6 42.0E | 4.4 47.1E | 6.4 62.2E | 5.1 37.0E | 2.0 | 1 | 2 | 16 | P | R |
| 4 | 0.0 0.0E | 0.7 100.0E | 0.1 46.4E | 7.6 45.5E | 16.7 96.0E | 0.7 4.0E | 3.5 | 5 | 0 | 3 | P | |
| 5 | 1.0 100.0E | 0.0 0.0E | 4.6 56.1E | 3.6 43.9E | 0.2 89.1E | 1.0 10.9E | 1.8 | 2 | 0 | 2 | L | |
| 6 | 0.0 0.0E | 0.0 100.0E | 1.5 50.5E | 2.3 60.5E | 3.8 60.9E | 0.9 19.1E | 1.6 | 1 | 0 | 1 | L | |
| 7 | 0.4 26.7E | 1.1 71.3E | 3.5 67.3E | 1.7 37.7E | 5.2 77.6E | 1.5 22.4E | 1.2 | 1 | 1 | 2 | L | |
| 8 | 0.6 40.0E | 0.0 60.0E | 3.5 67.3E | 1.7 37.7E | 5.2 77.6E | 1.5 22.4E | 0.7 | 2 | 1 | 2 | R | |
| 9 | 0.2 100.0E | 0.0 0.0E | 1.5 37.5E | 2.5 62.8E | 4.0 91.2E | 0.2 4.4E | 0.8 | 1 | 0 | 1 | P | |
| 10 | 0.5 40.0E | 0.5 60.0E | 2.2 59.5E | 1.5 40.4E | 3.7 78.7E | 1.0 21.3E | 1.0 | 1 | 0 | 4 | R | |
| 11 | 0.5 83.1E | 0.1 16.7E | 4.1 56.7E | 3.4 45.3E | 7.5 92.6E | 0.6 7.4E | 1.5 | 2 | 0 | 4 | L | |
| 12 | 0.0 0.0E | 0.0 100.0E | 1.0 59.4E | 1.0 40.6E | 3.2 91.4E | 0.3 9.6E | 1.5 | 1 | 0 | 2 | L | |

SUMMARY

TOTALS TO CRITERION = 12 TRIALS TO LAST ERROR = 3 ERRORS TO CRITERION = 3

INTERLEARNING STAGE

| | | | | | | | | | | | | |
|----|------------|------------|------------|-----------|------------|-----------|-----|---|---|---|---|--|
| 1 | 0.4 44.4E | 0.5 55.6E | 2.0 66.6E | 1.1 35.5E | 3.1 77.6E | 0.9 22.5E | 1.5 | 1 | 1 | 1 | R | |
| 2 | 0.0 0.0E | 0.0 0.0E | 1.2 57.7E | 1.1 47.3E | 2.6 100.0E | 0.0 0.0E | 1.9 | 1 | 0 | 0 | P | |
| 3 | 0.0 0.0E | 0.2 100.0E | 2.1 51.6E | 1.8 46.2E | 3.9 95.1E | 0.2 4.9E | 0.8 | 2 | 0 | 2 | L | |
| 4 | 0.4 100.0E | 0.0 0.0E | 3.9 55.7E | 3.1 44.3E | 7.0 94.6E | 0.4 5.4E | 1.5 | 2 | 0 | 2 | L | |
| 5 | 0.0 0.0E | 0.0 0.0E | 1.0 45.7E | 2.0 51.3E | 3.9 100.0E | 0.0 0.0E | 1.2 | 1 | 0 | 0 | R | |
| 6 | 0.5 55.6E | 0.4 44.4E | 2.1 45.7E | 2.5 54.1E | 4.6 83.6E | 0.9 16.4E | 1.1 | 1 | 1 | 2 | L | |
| 7 | 0.0 0.0E | 0.0 0.0E | 2.5 49.1E | 1.8 41.9E | 4.3 100.0E | 0.0 0.0E | 1.6 | 1 | 0 | 0 | R | |
| 8 | 0.5 100.0E | 0.0 0.0E | 2.8 30.4E | 6.4 69.4E | 9.2 94.8E | 0.5 5.2E | 1.5 | 2 | 0 | 1 | L | |
| 9 | 0.0 0.0E | 0.0 0.0E | 2.4 61.5E | 1.4 38.5E | 3.9 100.0E | 0.0 0.0E | 0.7 | 1 | 0 | 0 | L | |
| 10 | 0.1 100.0E | 0.0 0.0E | 2.2 48.7E | 1.0 31.3E | 3.2 97.0E | 0.1 3.0E | 1.0 | 1 | 0 | 1 | R | |
| 11 | 0.0 0.0E | 0.0 0.0E | 1.0 100.0E | 0.0 0.0E | 1.4 100.0E | 0.0 0.0E | 1.5 | 0 | 0 | 0 | R | |

| | | | | | | | | | | | | | | | | |
|----|-----|------|-----|------|-----|--------|-----|-------|-----|--------|-----|------|-----|---|---|---|
| 12 | 0.0 | 0.0% | 0.0 | 0.0% | 1.4 | 100.0% | 0.0 | 0.0% | 1.4 | 0.0% | 1.4 | 0 | 0 | 0 | L | |
| 13 | 0.0 | 0.0% | 0.0 | 0.0% | 1.5 | 100.0% | 0.0 | 0.0% | 1.5 | 0.0% | 1.5 | 0 | 0 | 0 | R | |
| 14 | 0.0 | 0.0% | 0.0 | 0.0% | 1.1 | 100.0% | 0.0 | 0.0% | 1.1 | 0.0% | 1.1 | 0 | 0 | 0 | L | |
| 15 | 0.0 | 0.0% | 0.0 | 0.0% | 1.5 | 55.6% | 1.2 | 44.4% | 2.7 | 100.0% | 0.0 | 0.0% | 1.5 | 1 | 0 | R |

SUMMARY

TRIALS TO CRITERION = 15 TRIALS TO LAST FRPD = 0 ERRORS TO CRITERION = 0

POST - SHIFT STAGE

| TOTAL | TRACK 1 | TRACK 2 | TRACK 3 | TRACK 4 | FORM | TEXTURE | LICY | F | T | S | L/R | E | | |
|-------|---------|---------|---------|---------|------|---------|------|--------|-----|-------|-----|---|---|---|
| 1 | 0.0 | 0.0% | 1.1 | 100.0% | 0.0 | 0.0% | 1.1 | 100.0% | 0.0 | 0.0% | 0 | 0 | R | |
| 2 | 0.1 | 100.0% | 4.1 | 51.2% | 3.0 | 48.7% | 8.0 | 98.8% | 0.1 | 1.7% | 1.5 | 2 | 0 | 1 |
| 3 | 0.0 | 0.0% | 2.1 | 50.0% | 2.1 | 50.0% | 4.2 | 100.0% | 0.0 | 0.0% | 1.4 | 1 | 0 | 0 |
| 4 | 0.0 | 0.0% | 1.0 | 56.3% | 1.6 | 45.7% | 3.5 | 100.0% | 0.0 | 0.0% | 1.1 | 1 | 0 | 0 |
| 5 | 0.0 | 0.0% | 3.4 | 66.7% | 1.7 | 33.3% | 5.1 | 96.2% | 0.2 | 3.8% | 1.0 | 0 | 0 | 2 |
| 6 | 0.0 | 0.0% | 1.8 | 50.0% | 1.8 | 50.0% | 3.6 | 100.0% | 0.0 | 0.0% | 1.7 | 1 | 0 | 0 |
| 7 | 0.1 | 83.3% | 1.9 | 59.4% | 1.3 | 40.6% | 3.2 | 84.2% | 0.6 | 15.8% | 1.0 | 0 | 0 | 3 |
| 8 | 0.0 | 0.0% | 3.1 | 66.6% | 1.7 | 33.4% | 4.8 | 100.0% | 0.0 | 0.0% | 1.6 | 1 | 0 | 0 |
| 9 | 0.1 | 60.0% | 2.4 | 60.0% | 2.5 | 51.0% | 4.9 | 90.7% | 0.5 | 9.3% | 1.5 | 0 | 0 | 3 |
| 10 | 0.2 | 50.0% | 2.1 | 47.7% | 2.3 | 52.3% | 4.4 | 91.7% | 0.4 | 8.3% | 1.5 | 0 | 0 | 3 |

SUMMARY

TRIALS TO CRITERION = 10 TRIALS TO LAST FRPD = 1 ERRORS TO CRITERION = 1

APPENDIX C

RAW SCORE DATA FOR SAMPLE

RAW SCORES IN PRESHIFT STAGE (N=96)

| | MALE FORM | | | FEMALE FORM | | | MALE TEXTURE | | | FEMALE TEXTURE | | |
|-------------|----------------------|----------------------|--------------------|------------------------|------------------------|-----------------------|-----------------------|----------------------|---------------------|-----------------------|----------------------|----------------------|
| | Trials to Crit. | Trials to Last Error | Total Errors | Trials to Crit. | Trials to Last Error | Total Errors | Trials to Crit. | Trials to Last Error | Total Errors | Trials to Crit. | Trials to Last Error | Total Errors |
| ID CRIT. | 28 10 10 10 | 26 1 2 0 | 8 1 1 0 | 12 10 22 10 | 3 1 15 1 | 2 1 7 1 | 32 14 28 10 | 26 5 22 2 | 12 3 8 1 | 10 32 10 10 | 1 23 0 0 | 1 9 0 0 |
| ED CRIT. | 19 34 16 17 | 12 30 9 9 | 7 15 3 6 | 14 10 10 10 | 5 0 0 1 | 2 0 0 1 | 15 17 10 19 | 6 11 1 10 | 4 5 1 7 | 57* 10 31 25 | 49* 1 24 19 | 27* 1 13 6 |
| CONT. CRIT. | 12 22 22 40 | 9 15 19 34 | 2 8 8 12 | 59* 40 50* 22 | 50* 34 44* 14 | 26* 15 21* 9 | 57* 25 10 11 | 48* 16 0 4 | 25* 10 0 2 | 24 13 33 56* | 15 5 24 47* | 11 3 13 20* |
| ID OL | 11 15 12 11 | 7 6 3 2 | 2 5 3 2 | 22 11 10 34 | 14 2 1 24 | 7 2 1 9 | 10 10 10 10 | 1 0 0 1 | 1 0 0 1 | 10 46 12 14 | 1 40 11 7 | 1 23 3 3 |
| ED OL | 10 10 12 17 | 5 4 6 8 | 1 1 3 6 | 11 10 23 17 | 3 0 16 11 | 2 0 12 4 | 21 10 10 34 | 12 0 0 25 | 8 0 0 14 | 10 10 33 10 | 0 1 24 0 | 0 1 15 0 |
| CONT. OL | 28 10 46 11 | 23 1 37 2 | 10 1 18 2 | 18 26 22 32 | 9 18 16 27 | 5 10 7 14 | 10 33 10 10 | 3 32 3 1 | 1 16 1 1 | 32 10 19 10 | 24 1 10 0 | 14 1 3 0 |

* trained (N=5)

RAW SCORES IN POSTSHIFT STAGE (N=96)

| | MALE FORM | | | FEMALE FORM | | | MALE TEXTURE | | | FEMALE TEXTURE | | |
|-------------|-----------------|----------------------|--------------|-----------------|----------------------|--------------|-----------------|----------------------|--------------|-----------------|----------------------|--------------|
| | Trials to Crit. | Trials to Last Error | Total Errors | Trials to Crit. | Trials to Last Error | Total Errors | Trials to Crit. | Trials to Last Error | Total Errors | Trials to Crit. | Trials to Last Error | Total Errors |
| ID CRIT. | 10 | 1 | 1 | 13 | 4 | 2 | 10 | 0 | 0 | 10 | 0 | 0 |
| | 11 | 3 | 2 | 10 | 1 | 1 | 10 | 0 | 0 | 10 | 1 | 1 |
| | 10 | 1 | 1 | 10 | 2 | 1 | 14 | 6 | 4 | 10 | 1 | 1 |
| | 10 | 1 | 1 | 10 | 0 | 0 | 12 | 3 | 3 | 10 | 1 | 1 |
| ED CRIT. | 24 | 16 | 10 | 32 | 24 | 15 | 10 | 2 | 1 | 12 | 4 | 3 |
| | 22 | 14 | 10 | 50 | 41 | 23 | 34 | 25 | 16 | 34 | 26 | 12 |
| | 12 | 3 | 3 | 49 | 42 | 18 | 17 | 8 | 6 | 15 | 3 | 5 |
| | 10 | 2 | 1 | 13 | 7 | 4 | 25 | 18 | 8 | 23 | 20 | 10 |
| CONT. CRIT. | 23 | 15 | 5 | 14 | 7 | 2 | 10 | 0 | 0 | 11 | 2 | 2 |
| | 10 | 0 | 0 | 16 | 10 | 3 | 12 | 3 | 2 | 28 | 19 | 10 |
| | 14 | 5 | 3 | 14 | 6 | 4 | 15 | 7 | 6 | 29 | 22 | 10 |
| | 18 | 9 | 8 | 10 | 1 | 1 | 38 | 29 | 15 | 10 | 2 | 1 |
| ID OL | 14 | 11 | 4 | 10 | 0 | 0 | 10 | 0 | 0 | 10 | 0 | 0 |
| | 10 | 1 | 1 | 10 | 0 | 0 | 10 | 0 | 0 | 10 | 1 | 1 |
| | 10 | 1 | 1 | 10 | 0 | 0 | 10 | 1 | 1 | 11 | 4 | 2 |
| | 10 | 1 | 1 | 11 | 3 | 2 | 10 | 0 | 0 | 11 | 2 | 2 |
| ED OL | 27 | 19 | 13 | 15 | 8 | 5 | 37 | 29 | 17 | 60 | 51 | 32 |
| | 14 | 5 | 5 | 12 | 4 | 2 | 11 | 2 | 2 | 47 | 38 | 23 |
| | 42 | 39 | 14 | 43 | 35 | 16 | 22 | 13 | 9 | 13 | 4 | 4 |
| | 64 | 56 | 23 | 47 | 38 | 25 | 14 | 5 | 4 | 31 | 22 | 15 |
| CONT. OL | 47 | 38 | 21 | 10 | 4 | 1 | 10 | 1 | 1 | 18 | 6 | 7 |
| | 10 | 1 | 1 | 17 | 8 | 6 | 10 | 1 | 1 | 15 | 7 | 5 |
| | 24 | 15 | 9 | 16 | 10 | 4 | 53 | 44 | 23 | 10 | 1 | 1 |
| | 24 | 15 | 9 | 10 | 5 | 1 | 27 | 18 | 11 | 11 | 2 | 2 |