

Synthetic strategies for modified glycosphingolipids and their design as probes

Carmanah D. Hunter, Tianlin Guo, Gour Daskhan, Michele R. Richards, and Christopher W.

Cairo*

Alberta Glycomics Centre, Department of Chemistry, University of Alberta, Edmonton, Alberta,

T6G 2G2, Canada

*To whom correspondence should be addressed. Tel.: 780 492 0377; fax: 780 492 8231; e-mail:

ccairo@ualberta.ca

Table of Contents

Abstract.....	4
Introduction.....	4
1.1 Glycolipid structure, classification, and nomenclature	5
1.1.1 Vertebrate glycolipid structures.....	5
1.1.2 Classification and nomenclature.....	6
1.2 Physical properties and analytical methods for GSLs.....	15
1.3 Biological roles of glycolipids and gangliosides.....	17
1.4 Scope of this review	19
2 Chemical synthesis of glycolipids	20
2.1 Chemical synthesis of sphingoid bases and ceramides	21
2.2 Chemical synthesis of cerebroside, sulfatides, and derivatives.....	24
2.3 Chemical synthesis of gangliosides	26
2.4 Neoglycolipids	31
2.5 Chemical degradation methods for semisynthesis	33
2.5.1 Removal of the fatty acid chain	34
2.5.2 Sphingosine degradation.....	35
2.5.3 Glycan degradation	36
3 Chemoenzymatic synthesis of glycolipids.....	37
3.1 Chemoenzymatic synthesis using glycosyltransferases	37
3.1.1 Synthesis of ganglio-series glycosphingolipids	39
3.1.2 Synthesis of globo/isoglobo and lacto/neolacto series glycosphingolipids	41
3.1.3 Engineered microorganisms.....	46
3.2 Chemoenzymatic synthesis using glycosidases and glycosynthases	48
3.3 Degradation enzymes for semisynthesis	52
3.3.1 Endoglycoceramidase (EGCase)	53
3.3.2 Sphingolipid ceramide deacylase (SCDase).....	54
3.3.3 Galactose-6-oxidase.....	55
3.3.4 Exoglycosidases.....	56
Table 4. Enzyme abbreviations.....	58
4 Labelled glycolipid analogs	60
4.1 Radiolabelled glycolipids.....	64
4.1.1 Metabolic radiolabelling.....	64

4.1.2	Semisynthetic radiolabeling approaches.....	65
4.2	Fluorescent glycolipids	66
4.2.1	Lipid labelling.....	67
4.2.2	Glycan labeling.....	69
4.3	FRET-based glycolipid probes.....	71
4.3.1	Intermolecular FRET assays.....	71
4.3.2	Intramolecular FRET assays.....	74
4.4	Bioorthogonal-tagged glycolipids.....	75
4.4.1	Tagging the glycan.....	76
4.4.2	Tagging the lipid.....	78
4.5	Photoresponsive glycolipids.....	79
4.5.1	Glycan photocrosslinkers.....	80
4.5.2	Lipid photocrosslinkers.....	81
4.5.3	Caged glycolipids.....	82
4.5.4	Photoswitchable glycolipids	84
4.6	Glycolipid microarrays.....	84
4.6.1	Non-covalent attachment	85
4.6.2	Covalent attachment.....	86
5	Conclusions and outlook.....	87
	ORCID	88
	Author Biographies.....	88
	Acknowledgements.....	89
	Abbreviations	90
	References.....	93

Abstract

The plasma membrane of cells contains a diverse array of lipids that provide important structural and biological features. Glycolipids are typically a minor component of the cell membrane and consist primarily of glycosphingolipids (GSLs). GSLs in vertebrates contain a multifarious assortment of glycan headgroups, which can be important to biological functions based on lipid-lipid and lipid-protein interactions. The design of probes to study these complex targets requires advanced synthetic methodologies. In this review, we will discuss recent advances in chemical and chemoenzymatic synthesis of GSLs in conjunction with the use of these approaches to design new probes. Examples using either chemical or enzymatic semisynthesis methods starting from isolated GSLs will also be reviewed. Focusing primarily on vertebrate glycolipids, we will highlight examples of radionuclide, fluorophore, photoresponsive, and bioorthogonal tagged GSL probes.

Introduction

The lipid bilayers of vertebrate cells contain a surprising diversity of glycolipids which play a number of important roles in cell biology. While the bilayers of the plasma membrane and organelles are more abundant in phospholipids;¹ glycolipids provide a rich source of binding epitopes and physical properties distinct from those of phospholipids and glycoproteins.² Similar to phospholipids in these cells, glycolipids contain a bifurcated lipid tail. However, vertebrate glycolipids are largely built on a ceramide (Cer) core, containing a sphingosine (Sph) chain and a fatty acid linked via an amide, as opposed to the diacyl chains attached as esters in phospholipids. These features make glycosphingolipids (GSLs) more akin to sphingolipids, which have received renewed attention in recent decades as their roles in signaling have been more fully elucidated.³ The simplest GSLs, such as glucosylceramide (GlcCer), contain only a single carbohydrate residue in the headgroup; while larger structures may feature nine or more carbohydrate residues (e.g. GP1c). The amount of GSLs found in specific membranes is highly variable, with the highest

levels found in neuronal tissues where GSLs can act as the major carrier of sialosides.⁴ The complexity of GSL structures, coupled with their low abundance makes investigation of their biological functions challenging. The biological function, nomenclature, and structures of GSLs are well reviewed elsewhere.^{2,5,6} This review will focus on describing strategies for the synthesis of GSL probes that can be used to investigate their function in biological systems (see **Sec 1.4**). We include a short introduction to the biological roles of GSLs before providing a detailed review of the synthesis of glycolipids and analogs which can be used as probes.

1.1 Glycolipid structure, classification, and nomenclature

Several book chapters^{2,5,7} and reviews^{8,9} provide detailed descriptions of glycolipid structure, classification, and nomenclature.¹⁰⁻¹² As such, we will only briefly discuss the topic here to provide essential context.

1.1.1 Vertebrate glycolipid structures

Glycolipids are amphiphilic molecules with a polar head group containing a mono- or oligo-saccharide attached to a nonpolar lipid tail via a glycosidic bond.¹³ In bacteria and plants, the lipid tail is most commonly a diacyl glycerol, whereas in insects and vertebrates, it is predominantly an acylated Sph.⁸ The most common form of Sph is *D-erythro*-sphingosine d18:1 (**Figure 1**), which is biosynthesized from palmitoyl-CoA and L-serine,^{7,8} although 16- and 20-carbon sphingosines are found in mammalian cells.^{2,7} Cer has a fatty acid attached via an amide bond to sphingosine, and fatty acids from 14 to 32 carbon atoms have been observed in mammalian systems (**Figure 1**).⁷ There are several ways of classifying GSLs; for example, those with a single carbohydrate residue in the headgroup are known as cerebrosides, and those containing at least one sialic acid (Sia) residue are named as gangliosides (**Table 2**). Other amphiphilic glycoconjugates are found

in vertebrates, including glycosylphosphatidylinositol-linked (GPI-linked) proteins and lipopolysaccharides or saccharolipids.¹⁴

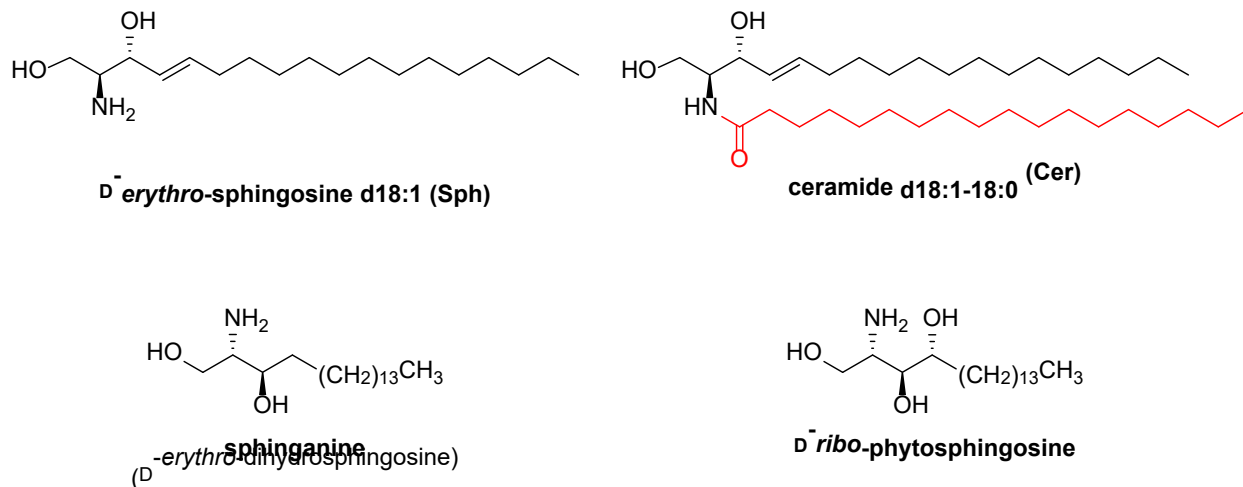

Figure 1. The structures of Sph and Cer, sphinganine, and an example of a phytosphingosine. For Cer, the stearate (C-18 fatty acid) is shown in red. The length of the alkyl chains in Sph and Cer are indicated for each chain as “d18:1” or “d18:1-18:0”, respectively, where the first number denotes the number of carbon atoms in the chain and the second number indicates the number of unsaturated bonds. The chain of the sphingosine base (a 1,3-diol) is indicated by a preceding “d”.¹¹

1.1.2 Classification and nomenclature

The complexity of lipids is a result of variations in their polar head groups and nonpolar tails. With the rise of lipidomics, a systematic classification and database structure has been developed to complement those for nucleic acids and proteins.¹⁵ The LIPID MAPS (Lipid Metabolites and Pathways Strategy) consortium has developed a system and tools; specifically, online tools^{12,16-18} and a searchable, structural database.¹⁹ The classification system divides lipids into eight categories based on their lipid tails – fatty acyls, glycerolipids, glycerophospholipids, sphingolipids, saccharolipids, polyketides, sterol lipids, and prenol lipids. Each category is then broken into subclasses, and the individual lipids are given a 12- or 14-character identifier with the

first six or eight characters identifying the lipid class and subclass.¹⁵ For example, gangliosides would all start with the characters “LMSP0601”.¹²

It is important to note that the lipid tails of GSLs are not always determined,¹² so they are often categorized solely by their glycan structure, which can vary from a simple monosaccharide up to 50 carbohydrate residues.^{8,14} The glycan structures of the GSLs, as well as their abbreviated chemical names, reflect their complexity and diversity. To simplify this complexity, glycolipids can be represented using abbreviated symbol nomenclature,²⁰⁻²² in addition to traditional chemical structures (**Figure 2, Table 1**).¹⁰ Additionally, several methods of classification have been developed, including an abbreviated systematic convention^{8,13,14} and a series of trivial names based partly on the chromatographic separation of gangliosides introduced by Svennerholm (**Table 2**).^{23,24} We will mainly use the latter in this review. Svennerholm’s system begins with a G to indicate a ganglioside structure, where the second letter refers to the number of sialic acid residues (M, mono; D, di; T, tri; Q, quad; P, penta). Finally, the name ends with a number to indicate the relative R_f value during normal phase chromatographic separation, for example in the monosialo-series, GM1 has the lowest R_f value, and GM3 the highest (**Table 2**).²³

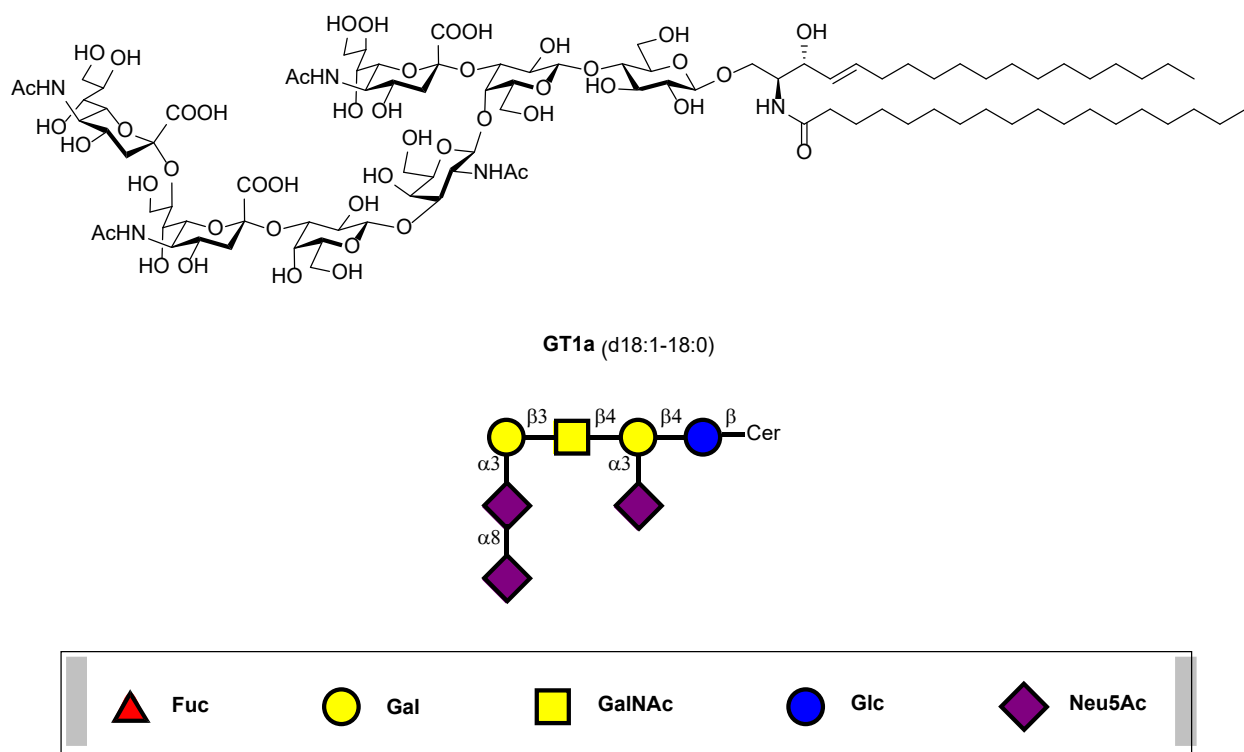
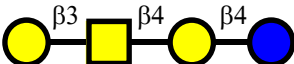





Figure 2. Bond-line structure and Symbol Nomenclature for Glycans (SNFG)²⁰ for GT1a. For clarity, sialic acids are drawn in neutral form throughout. *N*-acetylneuraminic acid has a pKa of 2.6 and is anionic at neutral pH.²⁵



As mentioned above, the majority of glycolipids in mammalian systems are GSLs, with galactosyl ceramide (GalCer) making up 16% of the total lipid composition in the brain.⁸ If GalCer contains a 3-*O*-sulfo modification, the lipid is known as sulfatide. More complex GSLs are generally based on lactosyl ceramide (LacCer), and the five common tetrasaccharide cores present in mammalian systems are listed in **Table 1**.¹⁴ Inspired by a recent review of ganglioside syntheses from the Kiso group,²⁶ we have correlated the nomenclature for these structures with references to chemical and chemoenzymatic total syntheses discussed in this review in **Table 2** (gangliosides) and **Table 3** (other vertebrate glycolipids).

Table 1. Major glycolipids found in mammalian systems ^a

Root	Symbol	Root structure (abbreviations)	Symbol nomenclature ²⁰
ganglio	Gg	Gal(β1-3)GalNAc(β1-4)Gal(β1-4)Glc	
lacto	Lc	Gal(β1-3)GlcNAc(β1-3)Gal(β1-4)Glc	
neolacto	nLc	Gal(β1-4)GlcNAc(β1-3)Gal(β1-4)Glc	
globo	Gb	GalNAc(β1-3)Gal(α1-4)Gal(β1-4)Glc	
isoglobo	iGb	GalNAc(β1-3)Gal(α1-3)-Gal(β1-4)Glc	

^aNomenclature from Chester, M. A. *Eur. J. Biochem.* **1998**, 257, 293–298.

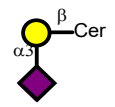
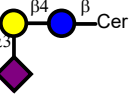
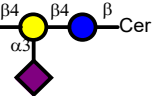
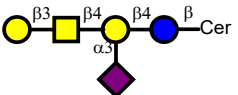
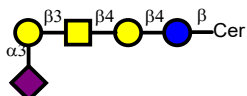
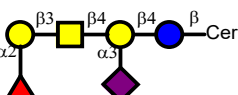
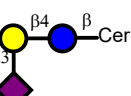
Table 2. Svennerholm's ganglioside nomenclature ^a

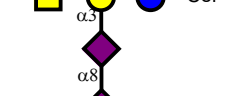
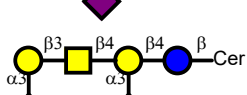
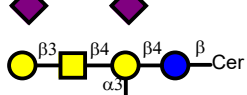
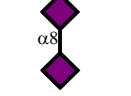
Name	Structure (condensed form)	Symbol nomenclature ^{b,20}	Total syntheses ^c
GM4	Neu5Ac(α 2-3)Gal(β 1-1')Cer		27 Reviewed in ²⁶
GM3	Neu5Ac(α 2-3)Gal(β 1-4)Glc(β 1-1')Cer		28-36 Reviewed in ^{26,37,38}
GM2	GalNAc(β 1-4)[Neu5Ac(α 2-3)]Gal(β 1-4)Glc(β 1-1')Cer		39,40 Reviewed in ^{26,37}
GM1 ^d	Gal(β 1-3)GalNAc(β 1-4)[Neu5Ac(α 2-3)]Gal(β 1-4)Glc(β 1-1')Cer		41-43 Reviewed in ²⁶
GM1b ^e	Neu5Ac(α 2-3)Gal(β 1-3)GalNAc(β 1-4)Gal(β 1-4)Glc(β 1-1')Cer		Reviewed in ²⁶
Fuc-GM1	Fuc(α 1-2)Gal(β 1-3)GalNAc(β 1-4)[Neu5Ac(α 2-3)]Gal(β 1-4)Glc(β 1-1')Cer		Reviewed in ³⁷
GD3	Neu5Ac(α 2-8)Neu5Ac(α 2-3)Gal(β 1-4)Glc(β 1-1')Cer		44-47 Reviewed in ²⁶
GD2	GalNAc(β 1-4)[Neu5Ac(α 2-8)Neu5Ac(α 2-3)]Gal(β 1-4)Glc(β 1-1')Cer		Reviewed in ²⁶
GD1a	Neu5Ac(α 2-3)Gal(β 1-3)GalNAc(β 1-4)[Neu5Ac(α 2-3)]Gal(β 1-4)Glc(β 1-1')Cer		42 Reviewed in ^{26,37}
GD1b	Gal(β 1-3)GalNAc(β 1-4)[Neu5Ac(α 2-8)Neu5Ac(α 2-3)]Gal(β 1-4)Glc(β 1-1')Cer		Reviewed in ²⁶
Fuc-GD1b	Fuc(α 1-2)Gal(β 1-3)GalNAc(β 1-4)[Neu5Ac(α 2-8)Neu5Ac(α 2-3)]Gal(β 1-4)Glc(β 1-1')Cer		Reviewed in ²⁶
GT3	Neu5Ac(α 2-8)Neu5Ac(α 2-8)Neu5Ac(α 2-3)Gal(β 1-4)Glc(β 1-1')Cer		Reviewed in ²⁶

Name	Structure (condensed form)	Symbol nomenclature ^{b,20}	Total syntheses ^c
GT1a	Neu5Ac(α2-8)Neu5Ac(α2-3)Gal(β1-3)GalNAc(β1-4)[Neu5Ac(α2-3)]Gal(β1-4)Glc(β1-1')Cer		42 Reviewed in ^{26,37}
GT1b	Neu5Ac(α2-3)Gal(β1-3)GalNAc(β1-4)[Neu5Ac(α2-8)Neu5Ac(α2-3)]Gal(β1-4)Glc(β1-1')Cer		Reviewed in ²⁶
GT1c	Gal(β1-3)GalNAc(β1-4)[Neu5Ac(α2-8)Neu5Ac(α2-8)Neu5Ac(α2-3)]Gal(β1-4)Glc(β1-1')Cer		
GQ1b	Neu5Ac(α2-8)Neu5Ac(α2-3)Gal(β1-3)GalNAc(β1-4)[Neu5Ac(α2-8)Neu5Ac(α2-3)]Gal(β1-4)Glc(β1-1')Cer		48 Reviewed in ^{26 37,38}
GQ1c	Neu5Ac(α2-3)Gal(β1-3)GalNAc(β1-4)[Neu5Ac(α2-8)Neu5Ac(α2-8)Neu5Ac(α2-3)]Gal(β1-4)Glc(β1-1')Cer		
GP1b	Neu5Ac(α2-8)Neu5Ac(α2-8)Neu5Ac(α2-3)Gal(β1-3)GalNAc(β1-4)[Neu5Ac(α2-8)Neu5Ac(α2-3)]Gal(β1-4)Glc(β1-1')Cer		
GP1c	Neu5Ac(α2-8)Neu5Ac(α2-3)Gal(β1-3)GalNAc(β1-4)[Neu5Ac(α2-8)Neu5Ac(α2-8)Neu5Ac(α2-3)]Gal(β1-4)Glc(β1-1')Cer		49

^a Nomenclature from Svennerholm, L. *Progress in Brain Research* **1994**, *101*, xi–xiv.

^b The key for the Symbol Nomenclature for Glycans (SNFG) is provided in Figure 2.

^c References for the synthesis of each lipid, or reviews thereof.



^d Also called GM1a



^e Also called *cis*GM1.^{13,24}

While gangliosides are defined by the presence of at least one sialic acid residue, there are multiple forms of sialic acid (Neu5Ac) that may occur in vertebrates. The most predominant of

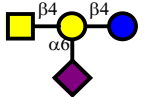
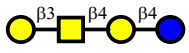
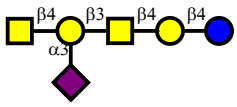
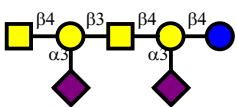
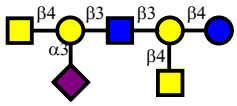
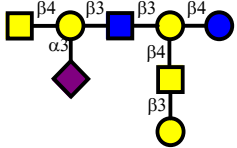
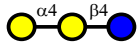
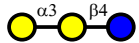
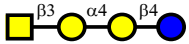
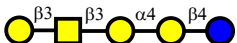
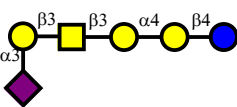
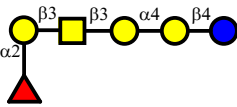
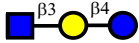
these are Neu5Ac and Neu5Gc, and *O*-acetylated forms thereof. Several *O*-acetylated forms of GSLs are thought to be important in disease.^{9,50} Humans lack the ability to express a functional cytidine monophosphate *N*-acetylneuraminic acid hydroxylase (CMAH) enzyme, preventing native biosynthesis of CMP-Neu5Gc from CMP-Neu5Ac and, therefore, the incorporation of Neu5Gc in glycoproteins and glycolipids. Human ganglioside structures that incorporate Neu5Gc are likely acquired from dietary sources.^{51,52} Interestingly, gangliosides of vertebrate brains in organisms which express functional CMAH also have remarkably low amounts of Neu5Gc gangliosides despite its occurrence in other tissues.⁵³ Gangliosides found in dietary sources have been recently analyzed by high resolution mass spectrometry.⁵⁴ Bovine milk is a useful source of GD3 and GM3 gangliosides,^{55,56} which tend to be composed primarily of Neu5Ac with minor amounts of Neu5Gc (2%).⁵⁷

Table 3. Oligosaccharide portions of other glycolipids discussed in this review

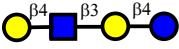
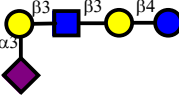
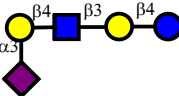
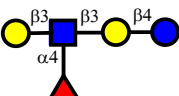
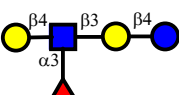
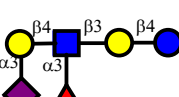
Name	Structure (condensed form)	Symbol nomenclature ^{a,20}	Total syntheses ^b
6'-Neu5Ac-GM2	GalNAc(β1-4)[Neu5Ac(α2-6)]Gal(β1-4)Glc(β)		40
GA1	Gal(β1-3)GalNAc(β1-4)Gal(β1-4)Glc(β)		58
GalNAc-GM1b	GalNAc(β1-4)[Neu5Ac(α2-3)]Gal(β1-3)GalNAc(β1-4)Gal(β1-4)Glc(β)		59 Reviewed in ²⁶
GalNAc-GD1a	GalNAc(β1-4)[Neu5Ac(α2-3)]Gal(β1-3)GalNAc(β1-4)[Neu5Ac(α2-3)]Gal(β1-4)Glc(β)		32,60 Reviewed in ^{26,38}
Ganglioside X1	GalNAc(β1-4)[Neu5Ac(α2-3)]Gal(β1-3)GlcNAc(β1-3)[GalNAc(β1-4)]Gal(β1-4)Glc(β)		61,62 Reviewed in ²⁶
Ganglioside X2	GalNAc(β1-4)[Neu5Ac(α2-3)]Gal(β1-3)GlcNAc(β1-3)[GalNAc(β1-4)Gal(β1-3)]Gal(β1-4)Glc(β)		62 Reviewed in ²⁶
Gb3	Gal(α1-4)Gal(β1-4)Glc(β)		34,63-72
iGb3	Gal(α1-3)Gal(β1-4)Glc(β)		63,70,72,73
Gb4	GalNAc(β1-3)Gal(α1-4)Gal(β1-4)Glc(β)		63,64,69,74
Gb5	Gal(β1-3)GalNAc(β1-3)Gal(α1-4)Gal(β1-4)Glc(β)		63,64,74
Sialyl-Gb5 (SSEA4)	Neu5Ac(α2-3)Gal(β1-3)GalNAc(β1-3)Gal(α1-4)Gal(β1-4)Glc(β)		63,64,66,75
Globo-H	Fuc(α1-2)Gal(β1-3)GalNAc(β1-3)Gal(α1-4)Gal(β1-4)Glc(β)		64,66,75
Lc3	GlcNAc(β1-3)Gal(β1-4)Glc(β)		63,65,76
Lc4	Gal(β1-3)GlcNAc(β1-3)Gal(β1-4)Glc(β)		76,77

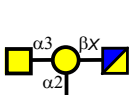
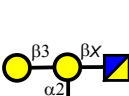
Name	Structure (condensed form)	Symbol nomenclature ^{a,20}	Total syntheses ^b
nLc4	Gal(β1-4)GlcNAc(β1-3)Gal(β1-4)Glc(β)		63,65,78-80
Sialyl Lc4	Neu5Ac(α2-3)Gal(β1-3)GlcNAc(β1-3)Gal(β1-4)Glc(β)		63
Sialyl nLc4	Neu5Ac(α2-3)Gal(β1-4)GlcNAc(β1-3)Gal(β1-4)Glc(β)		63,78
Lewis ^a	Gal(β1-3)[Fuc(α1-4)]GlcNAc(β1-3)Gal(β1-4)Glc(β)		81
Lewis ^x	Gal(β1-4)[Fuc(α1-3)]GlcNAc(β1-3)Gal(β1-4)Glc(β)		63,78,81-84
Sialyl Lewis ^x	Neu5Ac(α2-3)Gal(β1-4)[Fuc(α1-3)]GlcNAc(β1-3)Gal(β1-4)Glc(β)		63,82,85-88 Reviewed in ^{26,37}
H type I antigen	Fuc(α1-2)Gal(β1-3)GlcNAc(β)		89
H type II antigen	Fuc(α1-2)Gal(β1-4)GlcNAc(β)		89-91
A antigen	GalNAc(α1-3)[Fuc(α1-2)]Gal(β1-X)HexNAc(β) ^c		89,90
B antigen	Gal(β1-3)[Fuc(α1-2)]Gal(β1-X)HexNAc(β) ^c		89

^a The key for the Symbol Nomenclature for Glycans (SNFG) is provided in Figure 2.

^b References for the synthesis of each lipid.

^c The reducing end monosaccharide may be a GlcNAc or a GalNAc linked (β1-3) or (β1-4) to the neighboring Gal, depending on blood group subtype.⁹²

1.2 Physical properties and analytical methods for GSLs

GSLs which do not contain sialic acids or modified residues are generally neutral, while gangliosides and sulfatides are negatively charged (acidic). The amphipathic nature of glycolipids is critical for their function and their formation of aggregates.⁹³ Glycolipids, much like phospholipids,⁹⁴ tend to self-associate in aqueous solution forming micelles.⁹⁵ The minimum concentration at which gangliosides will form micelles (the critical micelle concentration, or CMC) is remarkably low as compared with other lipids.⁹⁵ Additionally, gangliosides form clusters or domains within their native membrane environments.^{96,97} When studying GSLs *in vitro*, they are often prepared in mixtures of other phospholipids to mimic their low abundance in biological membranes.⁹⁸ Lipids can be taken up by cell membranes, providing a tool commonly used for investigation of their roles in cells.^{99,100} Spontaneous transfer of gangliosides between membranes is temperature and lipid dependent.^{101,102} The uptake of exogenous gangliosides into the plasma membrane is complex, and can involve multiple mechanisms, including non-specific association and protein-mediated binding.¹⁰³ The shedding and uptake of gangliosides between cells is a known biological mechanism that is likely mediated by transfer proteins.¹⁰⁴ The mixed polarity of GSLs also presents challenges for purification of these compounds from complex mixtures or in large scale. The most common forms of analytical separation are high performance thin layer chromatography (HP-TLC)¹⁰⁵⁻¹⁰⁷ and liquid-chromatography mass spectrometry (LC-MS).¹⁰⁸

Common models for study of GSLs *in vitro* include supported bilayers and unilamellar vesicles. Bilayers are prepared from liposomes which can interact with a glass surface to provide a supported bilayer.¹⁰⁹ Artificial bilayers (also called supported bilayers) are commonly used to provide an oriented, and freely-diffusing, model of the lipid bilayer. Membrane proteins can be incorporated for binding and diffusion measurements,¹¹⁰⁻¹¹² and micropatterning can be used to study mechanisms of diffusion.¹¹³ The lateral mobility of GSLs is affected by their immediate environment. Measurements of GSL or spectator lipid diffusion have found reductions in lateral

mobility for GSLs that participate in microdomains or protein binding.¹¹⁴⁻¹¹⁶ Membrane sheets are excised sections of lipid bilayer attached to poly-lysine coated surfaces and have been found to retain the activity of integral membrane proteins as well as the fluidity in both leaflets of the membrane.¹¹⁷ The method has been applied to the study of membrane proteins,¹¹⁸ and localization of gangliosides.¹¹⁹⁻¹²¹ Giant unilamellar vesicles (GUV) have provided a model system for examining the lateral partitioning of GSLs within complex mixtures.^{116,122,123} Scaffold proteins can be used to generate bicellar GSL-protein complexes, referred to as nanodiscs^{124,125} or picodiscs.¹²⁶⁻¹²⁸ Methods used to investigate protein-GSL interactions have included mass spectrometry,^{129,130} ESR,¹³¹ NMR,^{132,133} neutron scattering,^{134,135} DSC,¹³⁶ microarrays,¹³⁷ and computational methods.¹³⁸⁻¹⁴¹ Mass spectrometry-based methods have the potential to provide data on binding interactions in the context of a bilayer-like model, including lipid-lipid or lipid-protein affinities.¹²⁹

The molecular size and complexity of GSLs present specific challenges for the development of probes to study these molecules in their native environment. Unlike proteins, which generally contain a number of ancillary groups that can be used for chemical modification, GSLs have only a few sites to choose for attachment points. Furthermore, one has to consider that any new chemical appendage introduced to a GSL structure may have a large influence on its physical properties and associations.¹⁴² This is perhaps nowhere more critical than in the use of synthetic fluorophores on GSLs. If one considers the relative molecular mass of a typical GSL, such as GM1, and one of the smallest fluorochromes, 7-nitro-1,2,3-benzoxadiazole (NBD) – the ratio of masses is approximately 10:1 (GSL:Fluor). Compare this to a typical membrane protein of even moderate size (~25 kDa), and that ratio drops to 150:1 (Protein:Fluor), or even smaller for larger proteins. As a result, successful probes must consider the molecular mass, polarity, and attachment point in their design (see Sec 4).

1.3 Biological roles of glycolipids and gangliosides

Gangliosides are known to play important roles in membrane structure and function,¹⁴³ most notably in myelination of nerve tissue.¹⁴⁴ Early murine models which disrupted the biosynthesis of more complex GSLs had suggested that gangliosides might not be essential for neuronal function.¹⁴⁵ However, more recent animal models which ablate the biosynthesis of all ganglio-series GSLs show “rapid and profound neurodegeneration”, leaving no doubt that GSLs are critical components of a functioning nervous system.^{146,147} GSLs may carry important binding epitopes, such as ABH blood group antigens (**Table 3**),^{92,148,149} or ligands for the selectins.^{150,151} The presentation of GSL binding epitopes may be complex, as heterogenous mixtures can produce novel epitopes.¹⁵²

Interactions of GSLs with intracellular and exogenous proteins are critical for membrane organization, signaling, and recognition events. Direct interactions of gangliosides with important signaling receptors, such as the endothelial growth factor receptor (EGFR) are well known.^{153,154} A number of membrane proteins are known to have ganglioside-binding domains.^{155,156} Caveolin proteins (Cav) are known to associate with GSL-rich microdomains and are likely important to their organization.^{157,158} Cav is known to interact directly with GM1, leading to enrichment of GM1 in Cav domains.¹⁵⁹ Photocrosslinking of GM1 (containing an aryl-azide in the acyl chain) has been used to capture Cav-1,¹⁶⁰ a finding supportive of direct ganglioside-protein interactions within the membrane environment. GSL interactions with flotillin-1 and flotillin-2 are required for GSL trafficking and endocytosis.¹⁶¹ Flotillins have also been captured through photocrosslinking of fatty acid chains, supporting a direct ganglioside-protein interaction.¹⁶² Exogeneous proteins, such as bacterial toxins, specifically bind to glycolipids as cellular receptors.^{163,164} The specificity of bacterial toxins may be used for the detection of GSLs by fluorescence imaging.¹⁶⁵ It should be noted, however, that methods for detection of GM1 that exploit the binding of cholera toxins may

be confounded by the mixed binding specificity for this lectin.¹⁶⁶ Other proteins or peptides with high affinity for specific GSLs have been developed as probes.¹⁶⁷⁻¹⁶⁹

Glycosphingolipids likely play central roles in the heterogenous organization of lipids and proteins within the membrane environment.^{170,171} Membrane domains are enriched in particular lipids and proteins, and these structures are generally referred to as lipid rafts or microdomains.¹⁷²⁻¹⁷⁴ The enrichment of GSLs in lipid rafts (and detergent-resistant microdomains) has been observed in numerous systems.¹⁷⁵⁻¹⁷⁹ Partitioning of GSL into microdomains is influenced by structural features of the GSL.¹⁸⁰⁻¹⁸⁵ Lipid raft organization is proposed to be critical for signal transduction,¹⁸⁶ and membrane microdomains where glycan-binding domains are enriched have been termed a glycosynapse.^{187,188} Glycan-glycan interactions may play a role in lateral interactions of GSLs within the membrane.¹⁸⁹ Glycans of the ABH antigens, and other sialosides, have been proposed to form “saccharide patches” on erythrocyte membranes.¹⁴⁹ As the structures of GSLs are important for inter-molecular interactions, enzymes which modify GSL in the membrane environment may influence membrane organization.^{190,191}

As membrane components, glycosphingolipids traffic into and out of the cell through various mechanisms. Incorporation of exogenous gangliosides into cellular membranes can occur through endocytosis and redistribution of gangliosides to the plasma membrane.⁹⁹ Cholesterol (Chol) interactions with GSLs may be important for endocytosis.¹⁹² In addition, gangliosides can traffic along endocytic and retrograde pathways¹⁹³ and can be found in a specialized structure of the endoplasmic reticulum that is associated with mitochondria (mitochondria-associated membranes or MAM).^{194,195} Exosomes have been reported to contain gangliosides;^{196,197} however, extensive analyses of exosomes for ganglioside content have been limited.^{198,199} Glycosphingolipids and flotillins are implicated in regulating the release of exosomes from cells.²⁰⁰

Gangliosides and other GSLs are implicated in a range of human diseases.^{9,147,201,202} Gangliosides have emerged as important biomarkers in cancers,²⁰³ and are even used as therapeutic

targets.^{204,205} Variations in the structures of gangliosides have been correlated with metabolic diseases.²⁰⁶ GSLs have been found to play roles in transmembrane signaling and can modulate the function of membrane proteins through a variety of proposed mechanisms, primarily protein-GSL and lipid-GSL interactions.^{143,207} Deficiencies in enzymes that process GSLs can lead to excess storage of these lipids, known as gangliosidosis,^{208,209} and are also responsible for Tay-Sachs disease.²¹⁰ Therapeutic strategies for forms of these diseases which result from misfolded proteins include enzyme replacement and pharmacological chaperones, or substrate reduction through inhibiting biosynthesis of lipids.²¹¹⁻²¹⁵ Amyloid protein undergoes increased aggregation in the presence of exosomes containing GSLs and is sensitive to the glycan structure of these lipids.²¹⁶

1.4 Scope of this review

GSLs possess a unique set of molecular properties which allow them to participate in diverse roles in cell biology. Furthermore, the remarkable complexity of these structures and their low abundance have made them extremely challenging to study as components of the cell membrane. Chemists have found synthesis of analogs to be a powerful strategy in the examination of protein and phospholipid biochemistry. GSLs present substantial synthetic challenges that have slowed progress in the development of new chemical tools for these systems. Chemical and chemoenzymatic approaches towards GSL targets have matured in recent years, opening the door to more elaborate strategies for the development of glycolipid probes. This review will begin with a survey of recent developments in chemical and chemoenzymatic strategies towards GSL structures, with selected formative examples provided for context. In general, we have restricted our discussion to vertebrate GSLs as these are most central to understanding human physiology and disease. These two approaches form the foundation of any successful probe design by enabling access to the required complex intermediates. Subsequently, we discuss examples of synthetic strategies used to design chemically modified GSL probes. These probes feature tags which can

be used to report on the fate or interactions of GSLs within a biological system. In comparison to other biomolecules, GSLs have not been as thoroughly explored and the development of new and more versatile probes is likely to improve our understanding of their function. It is our hope that collecting the examples here alongside advances in synthetic methodology will inspire new strategies and tools for glycolipid research.

2 Chemical synthesis of glycolipids

The chemical synthesis of GSLs and other vertebrate glycolipids is a fundamental tool for the development of new GSL probes. A successful strategy for the synthesis of a native GSL can typically be adapted to introduce modifications into the target with precise control of regio- and stereochemistry. Over the last decade, reliable chemical methodologies have been established for the total synthesis of GSLs, particularly gangliosides and their analogues. These methods have been highlighted by the Kiso group^{26,38,217} and by Kulkarni.³⁷ Thorough reviews of GPI-anchors and GPI-linked proteins are available elsewhere,²¹⁸⁻²²⁰ along with the synthesis and biological applications of inositols.²²¹ General synthetic strategies towards GSLs are outlined in **Figure 3**. The most intuitive disconnection begins with glycosylation of Cer with an appropriate oligosaccharide donor, and the synthesis of these respective components. More recent methodologies begin from disconnecting the glycan to GlcCer plus the non-reducing end residue, in what is referred to as a “cassette strategy” pioneered by Kiso and coworkers.²⁶ This approach provides improved yields for more complex GSL structures.⁴⁸

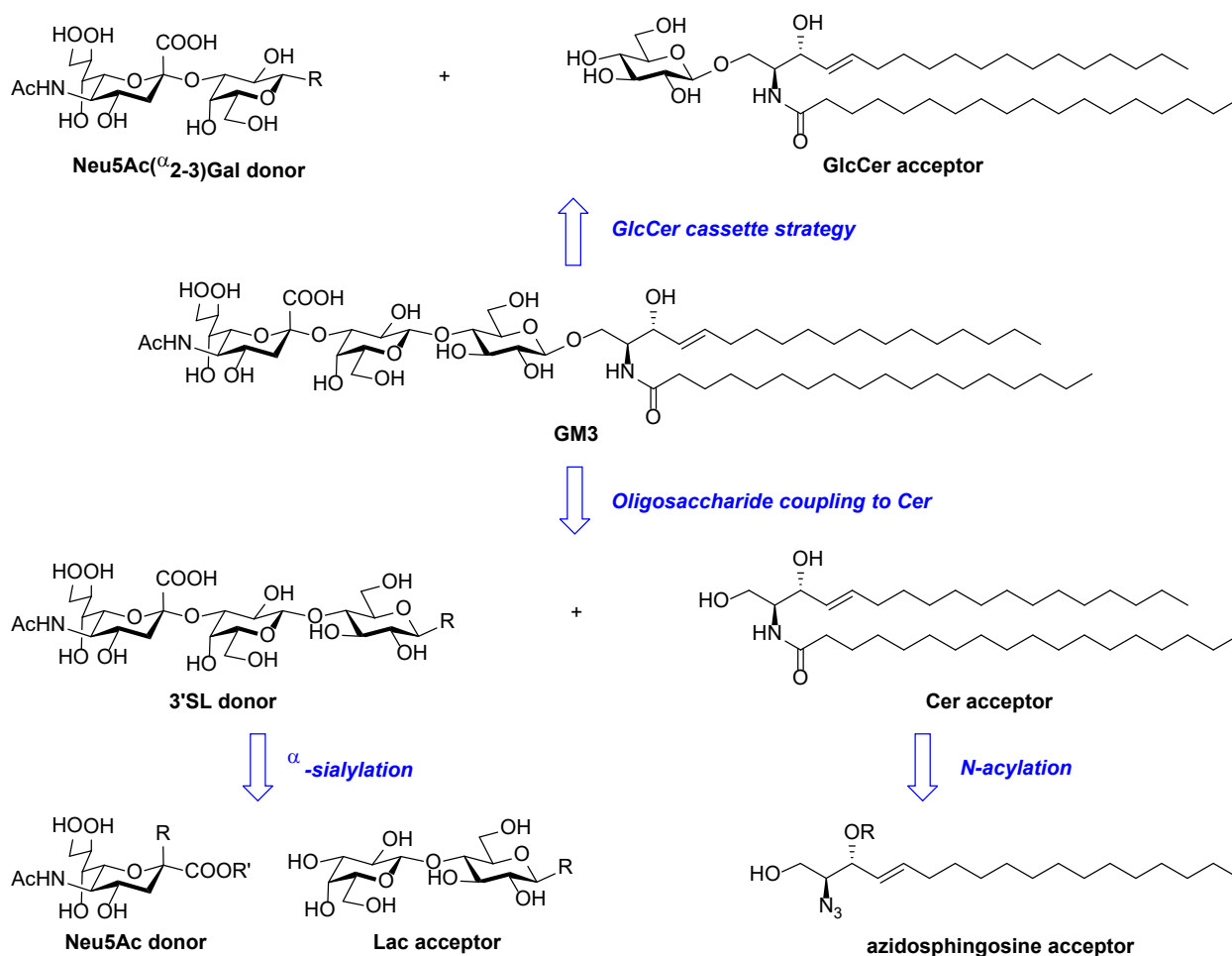

Figure 3. General synthetic approaches toward gangliosides, with GM3 shown as an example.

2.1 Chemical synthesis of sphingoid bases and ceramides

GSLs consist of a polar oligosaccharide head group, and an apolar tail, which is made up of a sphingoid base linked to a fatty acid via an amide bond (**Figure 1**). In vertebrate systems, the sphingoid base is *D-erythro*-sphingosine (*2S,3R* configuration), and synthesis of the Sph represents one of the major challenges in the construction of GSLs.^{37,222} Sphingoid bases fall into three major classes: Sph, sphinganine, and the four diastereomers of phytosphingosine (**Figure 1**). The major challenges associated with the synthesis of sphingoid bases involve setting the *erythro* stereochemistry, and for sphingosine in particular, setting the *trans* stereochemistry of the alkene.²²² In general, *erythro* stereochemistry has been achieved from stereochemical starting

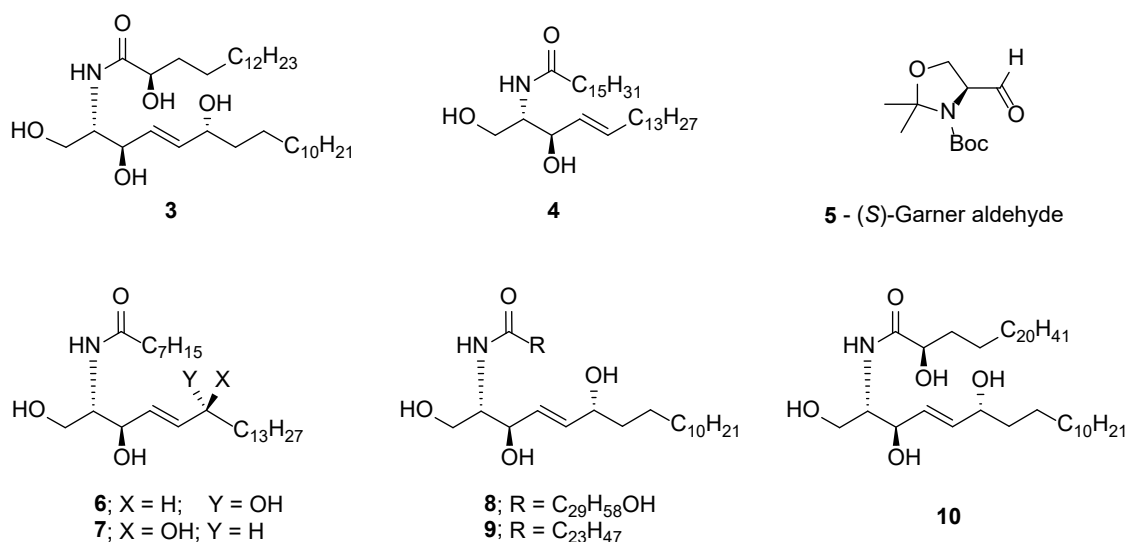

Figure 4. Ceramides prepared by cross-metathesis strategies.

The presence of additional modifications of the sphingosine, such as those in 6-hydroxyceramide analogue **3**, complicate the syntheses of sphingolipids further, and various approaches have appeared for their stereoselective synthesis.^{228-231,264,267} Many strategies rely on the utilization of the L-serine-derived (*S*)-Garner aldehyde (**5**) as the central precursor. Bitmann and coworkers reported the asymmetric synthesis of **6** and **7** starting from **5**,²²⁸ as well as the *5S* and *5R* diastereoisomers of *N*-acyl 5-hydroxy-3-sphingenines.²²⁸ Masuda and Mori also employed a similar strategy to make a TBS-protected sphingenine **7**. The 6-hydroxylated ceramides (**8–10**) were prepared by *N*-acylation, followed by deprotection.²³⁰ More recently, Vávrová and coworkers used a ruthenium catalyst to selectively reduce an alkyne as a key reaction to provide **9**.²⁶⁷ Yadav and coworkers employed a double elimination strategy for the total synthesis of the (*6R*)- and (*6S*)-diastereomers of 6-hydroxysphingosine.²³¹ Sharpless asymmetric epoxidation of an allylic alcohol followed by reductive ring opening of the chiral epoxy chloride were key reactions.

Recently, Iga et al. developed two complementary methods for the synthesis of ceramide and sphingosine.²⁶⁸ The strategy used sequential periodate oxidation, sodium borohydride mediated reduction, and acidic hydrolysis of galacto- or gluco-cerebrosides to form Cer analogues.

The major difficulty associated with this method is that periodate oxidation can destroy phytosphingosine-derived ceramides. Alternatively, sphingolipids isolated from natural sources could be converted into ceramides via sequential acidic hydrolysis followed by isolation of the sphingosine, and subsequent *N*-acylation with a suitable fatty acid (see **Sec 4**).

2.2 Chemical synthesis of cerebrosides, sulfatides, and derivatives.

Cerebrosides are GSLs containing only a monosaccharide head group, and as mentioned in **Sec 1.1.2**, GalCer is a common cerebroside found in the human brain, along with the 3-*O*-sulfated GalCer, sulfatide.⁸ Several examples of GalCer, differing in the Cer moiety, are shown in **Figure 5 (11, 15–17)**, and their syntheses from 1969 to 2003 have been reviewed.²⁶⁹ The synthesis of sulfatides (e.g. **12** and **14**), have been reviewed by Compostella, et al.²⁷⁰

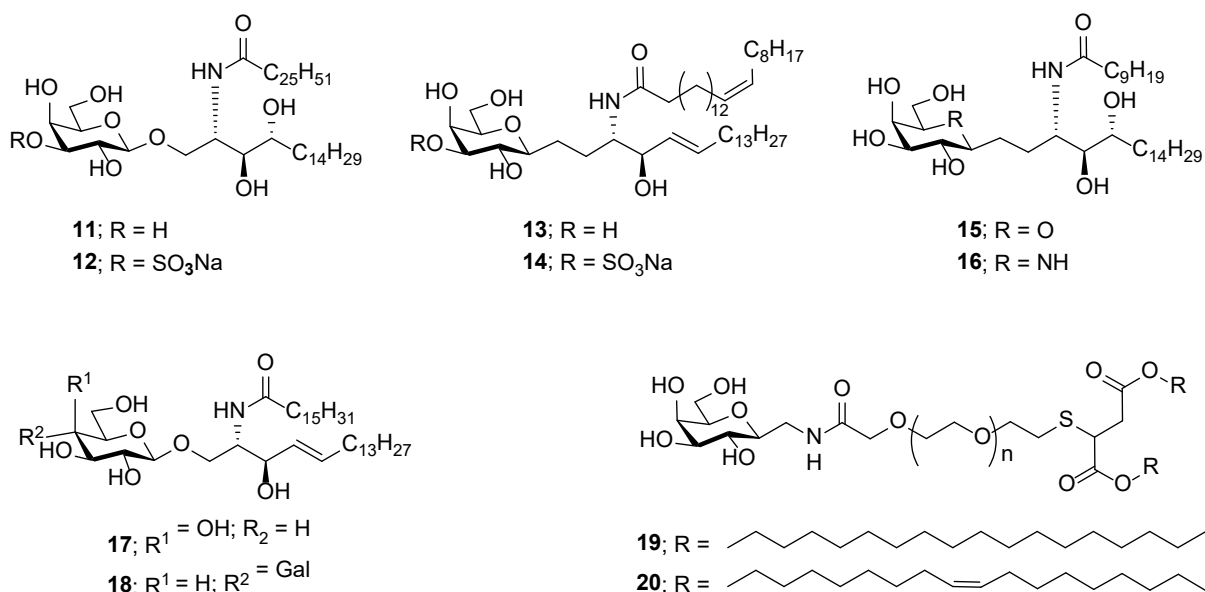

Figure 5. Structure of GalCer analogues

Various β -*C*- and β -*O*-glycoside GalCer analogues have been synthesized; many of which were for tested as inhibitors of HIV infection.²⁷¹⁻²⁷⁹ For example, sulfatide **12** was synthesized in five steps via glycosylation of azidosphingosine with a trichloroacetimidate donor.²⁷¹ Both the β -

C- and β -*O*-glycosides of sulfatide **14** have been synthesized.²⁷² A Wittig sigmatropic rearrangement was followed by a Horner-Wadsworth-Emmons olefination (HWE) to install the Sph backbone for the stereoselective synthesis of derivative **13** over thirteen steps. This was followed by regioselective sulfation of Gal to provide **14**. Lankalapalli and Gorantla also employed the HWE reaction to synthesize β -*C*-GalCer **15**, as well as aza-*C*-GalCer **16**.²⁷⁵ Stannyl Cer was directly glycosylated with an α -iodo galactoside donor in a chemo- and stereo-selective route to access GalCer **17**.^{273,274} Disarmed glycosyl donor-promoter pairs provided excellent yields and stereoselectivity when glycosylated with a broad range of stannylated glycosyl acceptors.²⁷⁴ Recently, Taylor and coworkers developed a concise, convergent route to glycosyl ceramides using diphenylboronic acid-promoted β -selective glycosylation of unprotected ceramide with a glycosyl methansulfonate.²⁷⁷ Selective activation of the ceramide 1,3-diol with diphenylborinic anhydride, followed by glycosylation with the corresponding glycosyl mesylates, and subsequent cleavage of the protecting groups afforded GalCer **17** and LacCer **18** in two steps. This synthetic route could have applications to the GlcCer cassette strategy for more complex GSLs (see **Sec 2.3**).²⁶ Thota, et al., synthesized the *C*-glycoside derivative of **17** as a potential HIV inhibitor, over sixteen steps using a Sharpless dihydroxylation, followed by a CM reaction, and subsequent manipulations to install the ceramide moiety.²⁷⁸ To test variations in fatty acid chains, LaBell, et al., synthesized glycolipids **19** and **20** with unnatural saturated and unsaturated lipid tails.²⁷⁹ Synthesis was achieved through a convergent coupling between methylene amine functionalized β -galactoside and pentafluorophenyl activated lipids.

Isolation of marine-derived α -linked galactosyl ceramides from *Agelas mauritanus* was first reported by researchers at Kirin Pharma, and these compounds, called agelasphins, were found to act as stimulants of human leukocytes.²⁸⁰⁻²⁸² Since then, the synthesis of α -linked GalCer KRN7000 and analogues has been an active area of research and is reviewed in detail elsewhere.^{283,284} Synthesis of α -GalCer has primarily relied on three strategies: direct glycosylation

of functionalized ceramide with an activated sugar;^{73,285-289} coupling of the azidosphingosine with an activated sugar followed by attachment of the fatty acid;^{236,238,290-295} or construction of the glycosyl ceramide from a disaccharide precursor.²⁹⁶⁻²⁹⁹ Of these methods, a one-pot strategy developed by Gervay-Hague and co-workers has also been applied to the synthesis the vertebrate β -GalCer.³⁰⁰

2.3 Chemical synthesis of gangliosides

Many synthetic strategies to construct gangliosides focus on regio- and stereo-selective α -sialylation of the oligosaccharide, and Ando et al. have recently catalogued synthetic methods for α -sialylation with modified sialic acids.³⁸ Subsequent glycosylation of the ceramide, a protected sphingosine (like azidosphingosine, **Figure 3**),²²² or GlcCer provides the target. As mentioned earlier, the latter is often referred to as the GlcCer “cassette strategy”.²⁶ This section summarizes the synthesis of a mammalian ganglio-, lacto- and neolacto-series of GSL structures, focusing on those not previously reviewed elsewhere.

Various syntheses of GM3²⁸⁻³⁰ and derivatives^{30,301-305} have been reported. Synthetic equivalents derived from the ganglioside GM3 have been used as a precursor for synthesis of other ganglio-series gangliosides such as GM1⁴¹⁻⁴³ and GD3.⁴⁴ Other chemical methods for the synthesis of gangliosides including GM2^{39,40} and GP1c⁴⁹ have been reported, along with analogues of GM4²⁷ and GD3.^{45-47,306} In particular, the GlcCer cassette strategy has been exploited for the synthesis of a series of natural gangliosides including GM3,³² GM2,³² GM1,³² GQ1b,⁴⁸ *N*-acetylgalactosamine (GalNAc)-GD1a,³² and gangliosides X1^{61,62} and X2.⁶²

Duclos reported one of the first total syntheses of GM3,²⁹ in which a GM3 trichloroacetimidate donor was directly coupled with a protected Cer acceptor using a convergent strategy. Selective α -sialylation was obtained with a β -phosphite donor of Neu5Ac. Kurosu et al. employed a similar procedure in synthesis of GM3 derivatives with truncated Cer moieties.³⁰ In

their synthesis of GD3, Schmidt and coworkers also used a β -sialyl phosphite donor.⁴⁴ Li and coworkers used a sialyl *N*-phenyltrifluoroacetimidate donor (**21**, Scheme 2) to synthesize an (α 2-3)-sialoside intermediate that was subsequently converted to the GM3 trisaccharide *N*-phenyltrifluoroacetimidate (**22**).³¹ The trisaccharide donor was then coupled with an azidosphingosine acceptor (**23**), followed by further manipulations to provide the target. Derivatives of GM3 have been synthesized including those with different acyl moieties either at the *N*-5 of Neu5Ac, *N*-3 of the Cer,³⁰¹ or with a phytoceramide.³⁰²

Scheme 2. Synthesis of GM3 using sialyl *N*-phenyltrifluoroacetimidate donor **21**

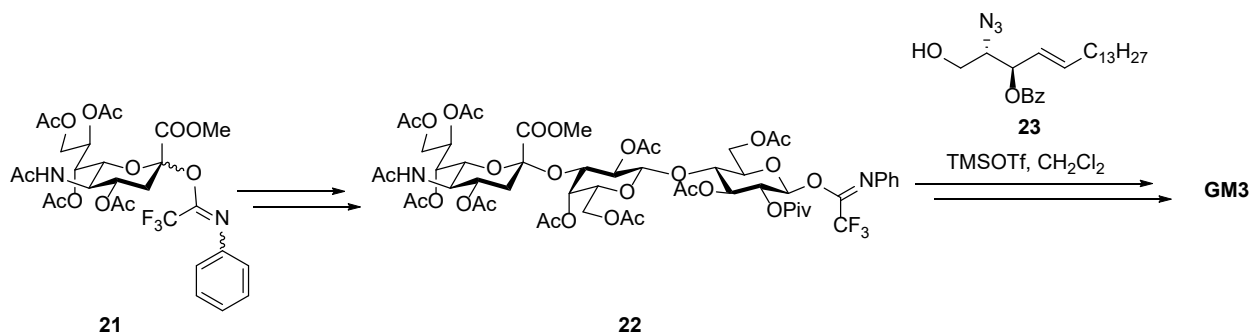

Kiso and coworkers synthesized GM2 analogs with various glycosyl lipid units using a strategy of adding the lipid acceptors to GM2-core tetrasaccharide donors.³⁹ The same group extended their studies with a more general route to construct both GM2 and its isomer 6'-Neu5Ac-GM2.⁴⁰ The route was a sequential process with the key step involving an *N*-Troc-protected sialyl donor reacting with the appropriate Lac acceptors in a regio- and α -selective manner to form the 3'- or 6'-sialylated trisaccharide intermediates. Addition of a protected GalNAc and an azidosphingosine, followed by further manipulations, provided GM2, as well as its 6'-Neu5Ac-GM2 isomer. Kiso and coworkers later used the Troc-protected GM2 acceptor intermediate for synthesis of GM1, GD1a, and GT1a.⁴²

To evaluate the influence of the core carbohydrate domain of GM1 in binding to *P. aeruginosa*, Danishefsky and coworkers reported a total synthesis of the methyl glycoside of the

GM1 oligosaccharide (GM1-OMe) using a [3+2] glycosylation strategy.⁴¹ The key step was azaglycosidation of sialylated glycal acceptor **24** with thioethyl glycoside **25**. The resulting protected pentasaccharide was transformed to GM1-OMe over six steps (**Scheme 3**). A similar strategy was followed by Huang and coworkers to produce a GM1 glycoside functionalized with an aminopropyl linker moiety.⁴³

Scheme 3. Synthesis of GM1-OMe

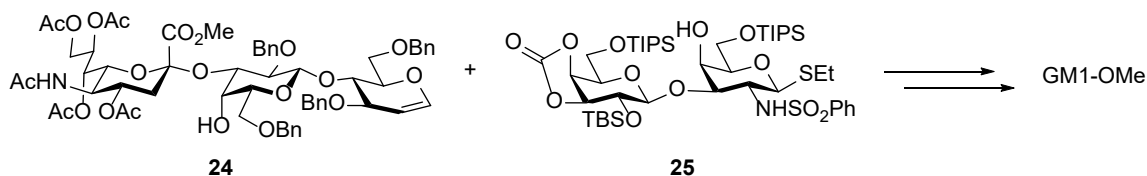

In the synthesis of the methyl glycoside of the GD3 oligosaccharide (GD3-OMe), De Meo, et al., formed the α -disialoside from a 2-thioglycoside of Neu5Ac and a suitably protected sialyl acceptor.⁴⁶ The disialoside was then converted into a thiosialoside and reacted with 3'- and 4'-unprotected Lac to give the GD3 tetrasaccharide. Tsvetkov and coworkers reported an improved synthesis of GD3-OMe using an *N*-trifluoroacetyl sialoside as an efficient sialyl donor.⁴⁷ Electron withdrawing protecting groups enhanced the reactivity and stereoselectivity of sialyl donors in (α 2-8)-sialylation with various sialyl and glycosyl acceptors.

The first total synthesis of a hybrid-type ganglioside structure, ganglioside X1,⁶¹ was achieved by Kiso and coworkers using a convergent strategy based on direct coupling between the oligosaccharide and Cer. An α -sialylated heptasaccharide trichloroacetimidate donor with a *C*-2 pivaloate on the reducing-end Glc was employed to increase efficiency of glycosylation to the Cer. Next, the same group reported the total synthesis of GQ1b⁴⁸ based on a GlcCer cassette approach. This strategy was further expanded to use a cyclic GlcCer cassette as an acceptor for the total syntheses of highly branched gangliosides, like GalNAc-GD1a (**Scheme 4**).^{32,60} The macrocyclic acceptor **27** was obtained via an intramolecular glycosylation between a glucosyl imidate donor

and a ceramide acceptor as a critical step.³⁰⁷ Acceptor **27** was then reacted with the GM2-core imidate donor **26**, followed by global deprotection to give GalNAc-GD1a.⁶⁰ A similar approach was used for the synthesis of GalNAc-GM1b,⁵⁹ as well as gangliosides X1^{61,62} and X2.⁶²

Scheme 4. Synthesis of ganglioside GalNAc-GD1a

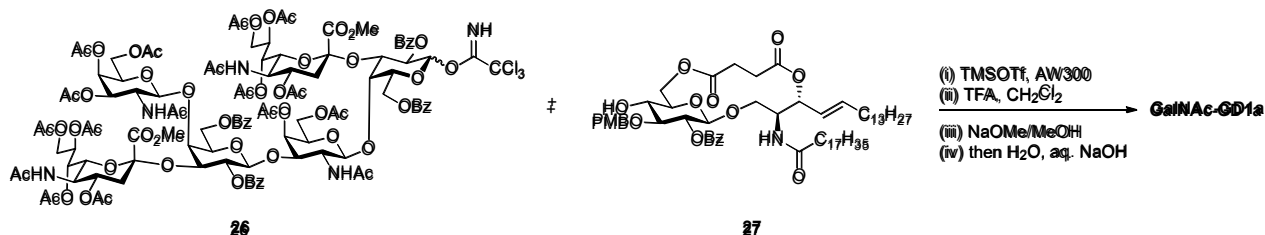

GP1c is one of the most complex gangliosides known, and its synthesis has been realized by Takahashi and coworkers (Scheme 5).⁴⁹ A convergent synthesis of ganglioside GP1c oligosaccharide **33** was achieved via coupling of the tetrasaccharide donor **28** with tetradecyl glucoside **29** in the presence of TMSOTf to provide pentasaccharide **30**. Removal of the Troc-protecting group provided acceptor **31** in excellent yield. Condensation of acceptor **31** with two equivalents of the protected thioglycoside donor **32** followed by global deprotection and *N*-acylation of the *C5* amino groups provided nonasaccharide **33**.

Scheme 5. Synthesis of tetradecyl GP1c glycoside.

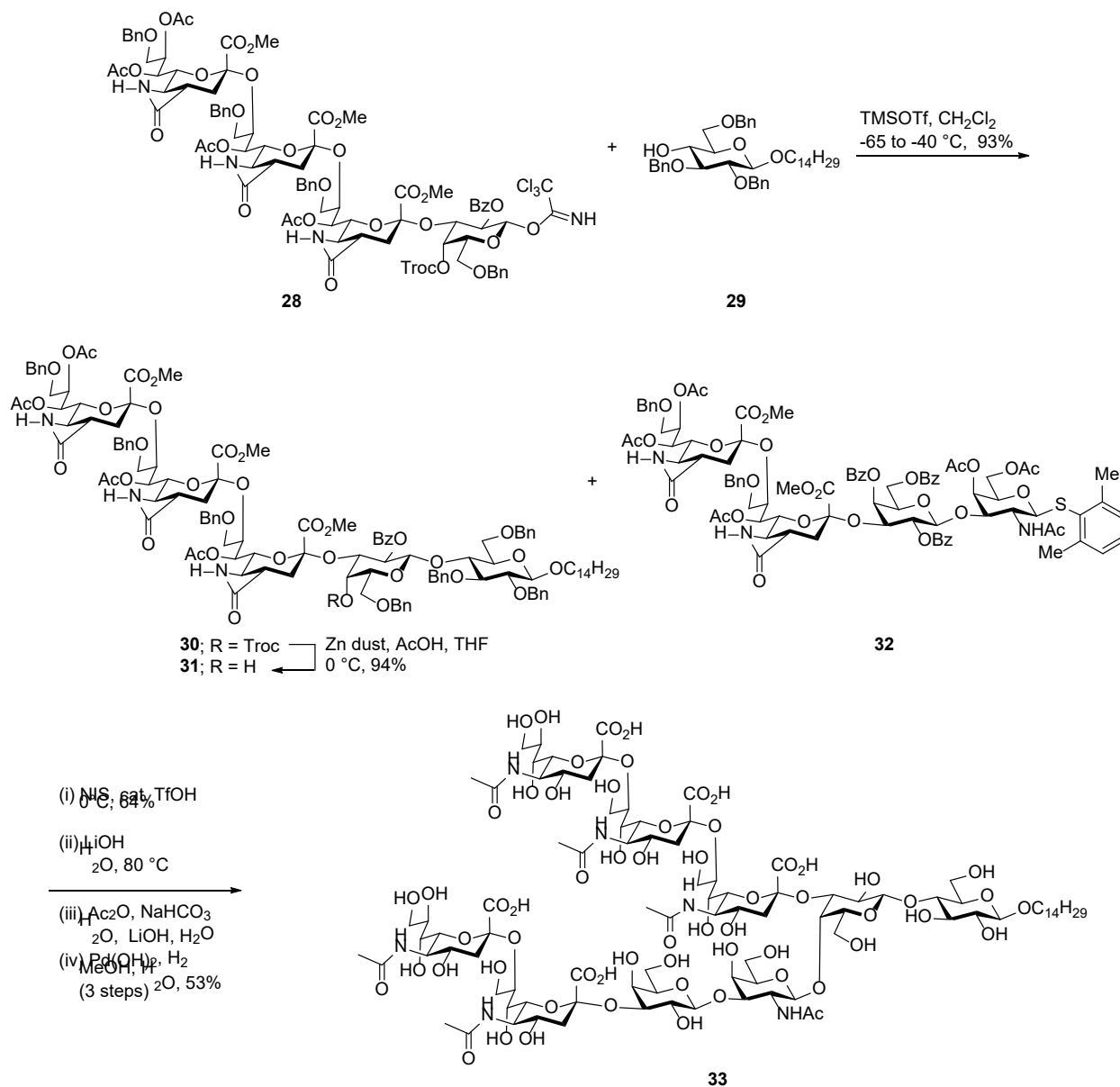

Hydrolytically stable derivatives of GM3, GM4, and GD3 have been synthesized using a number of strategies. Hossain et al. described synthesis of the GM3-tetrasaccharide lactam **34** (Figure 6).³⁰⁶ Tietze et al. synthesized a cyclic-ether containing stable analogue of GM3 **35**.³⁰³ Bundle and coworkers have used two different strategies to synthesize a glycosidase-resistant S-linked Neu5Ac-analogues of GM3 (**36–37**).^{304,305} Sodeoka and coworkers developed a stereoselective route using an Ireland-Claisen rearrangement to synthesize a nonhydrolyzable

GM4 analogue (**38**).²⁷ Elleruk and Meijer used an interhalogen-promoted α -sialylation of a disialoside donor to synthesize GD3 bislactams **39** and **40**.⁴⁵

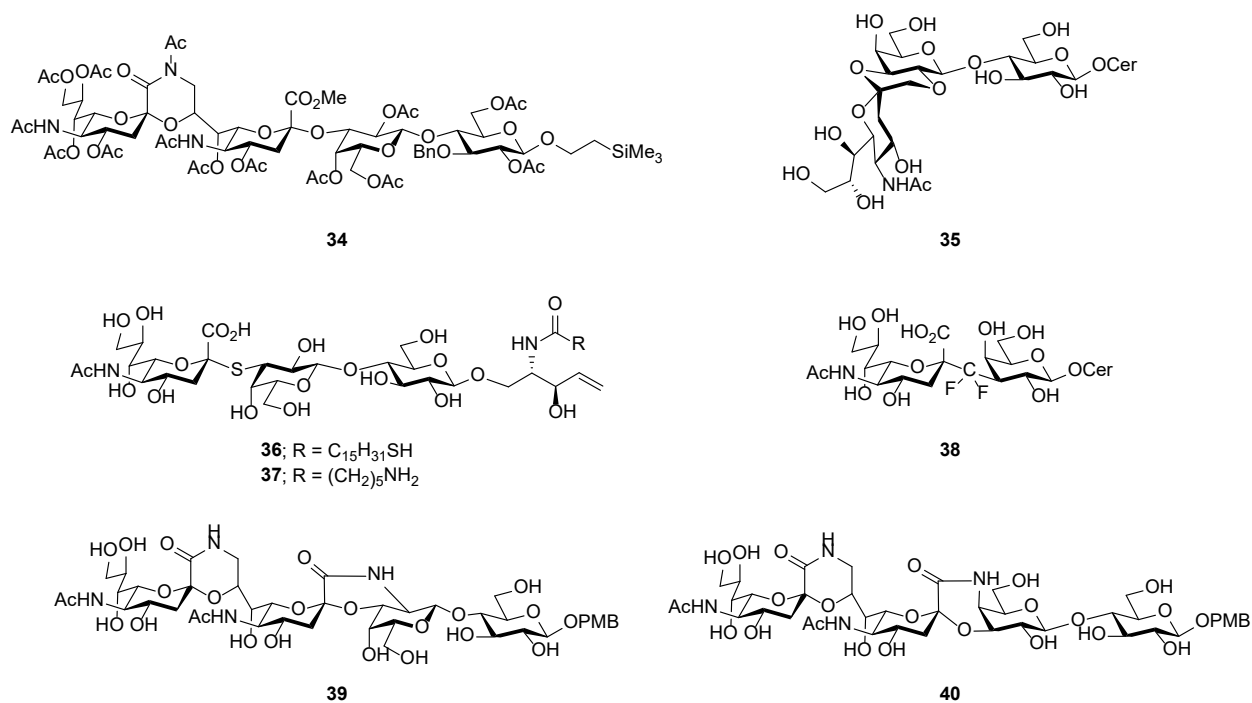

Figure 6. Nonhydrolyzable derivatives of GM3, GM4, and GD3

2.4 Neoglycolipids

Various syntheses of neoglycolipids have been reported to investigate their physical properties,³⁰⁸ as well as to develop novel compounds that mimic their natural analogues.^{309,310} Kiso and coworkers synthesized sialyl Lewis X (sLe^x) neoglycolipids containing a novel, *N*-deacetylated and lactamized sialic acid **41**.³¹¹ They also synthesized a neoglycolipid containing sLe^x on the mucin GlcNAc(β 1-6)GalNAc(α) core structure.⁸⁵ Other sLe^x neoglycolipids with different spacer lengths and structures (e.g. **42**, **Figure 7**) have been synthesized to determine their effects on leukocyte rolling⁸⁶ and sLe^x presentation.³¹² Simplified sLe^x neoglycolipids embedded in liposomes were recognized by E-selectin.³¹³ These derivatives were more selective for E-selectin than native sLe^x, suggesting that simplified glycolipid derivatives could be a fruitful approach to targeting adhesion receptors.

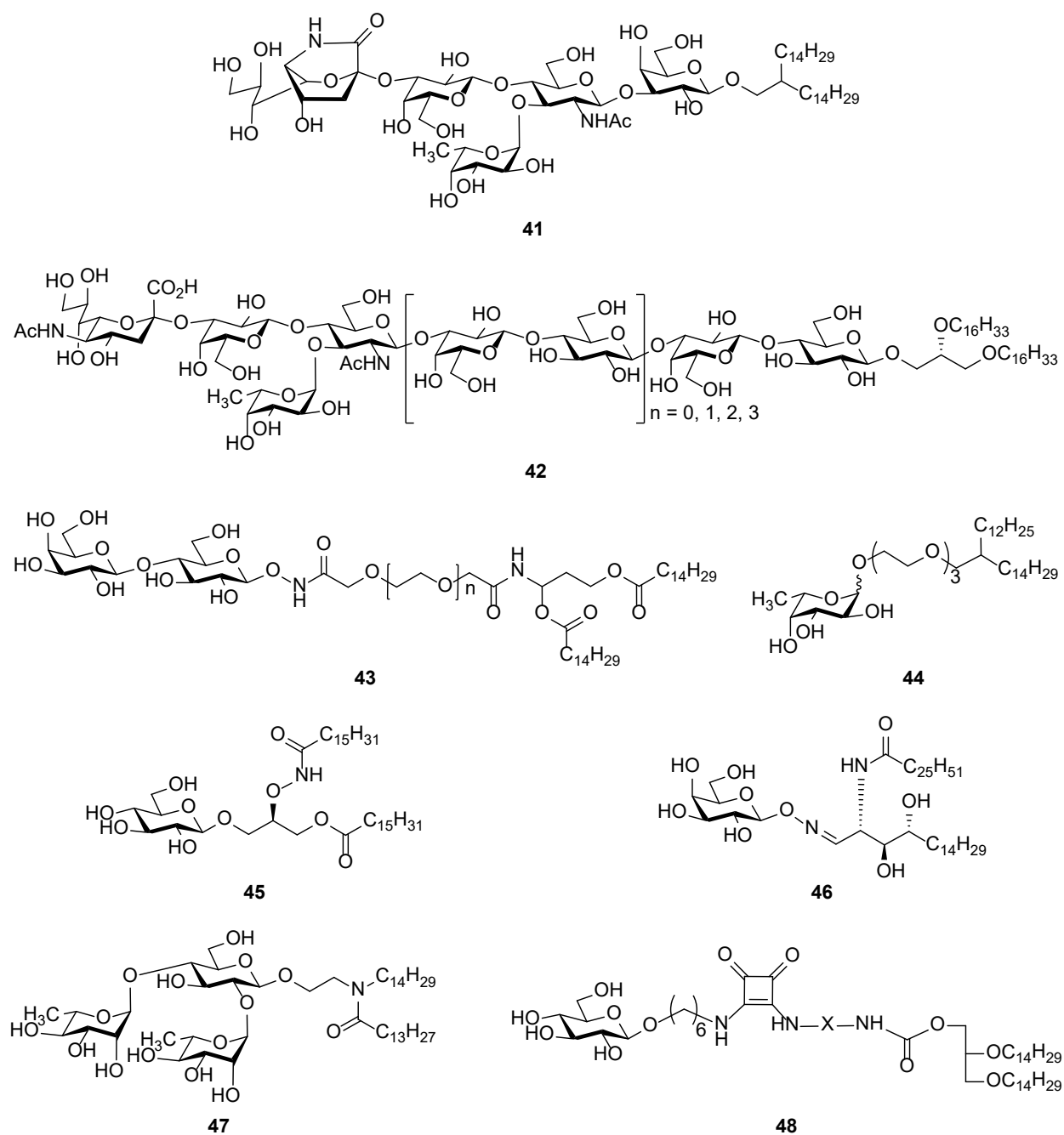

Figure 7. Structures of neoglycolipids discussed in this section.

Amphiphilic Lac-based neoglycolipids differing in the length of the spacer fragment, or the aliphatic chain have served as components of targeted drug delivery systems.³¹⁴⁻³¹⁶ A series of Lac-based neoglycolipids with varying ethylene-glycol aglycones were prepared, and a representative, **43**, is shown in **Figure 7**.^{315,316} Fuc derivatives with ethylene glycol linkers, such

as **44**, were synthesized by Faivre et al., and assessed for their potential as amphiphilic drug carriers. The anomeric configuration of Fuc influenced the organization of monolayers but not the fluidity of liposomes.³¹⁷

Various *N*-oxyamide-linked neoglycolipids (**45**) were prepared as a way to improve metabolic stability and hydrogen bonding properties of the glycolipid,³¹⁸ as oxime linkages are hydrolytically stable under physiological conditions.³¹⁹ Other synthetic neoglycolipid probes have been generated via oxime ligation of the reducing end with an aminoxy-functionalized lipid.³²⁰ Wang et al. developed a concise route to synthesize GalCer analogues (**46**) via oxime ligation from β -D-galactose pentaacetate-derived galactosyl oxyamines.³²¹ GM3 neoglycolipid analogs with *N*-methylaminoxy-modified ceramide lipid tails have been evaluated for activity against matrix metalloprotein-9 as inhibitors of tumor migration.³²²

Nohara and coworkers reported a coupling of a chactrioside (L-rhamnosyl-(α 1-4)-[L-rhamnosyl-(α 1-2)]-D-Glc)-based neoglycolipids exemplified by **47**.³²³ Maslov et al. used a bivalent squaramide linker to connect a galactose derivatives with the glycerol moieties of neoglycolipids like **48**.³²⁴ A multicomponent strategy for the synthesis of ceramide analogues and their application for the synthesis of glycolipids was established using an Ugi four-component reaction.³²⁵ Recently, a report of using boronic acids as phase transfer reagents has allowed for the direct coupling of unprotected monosaccharides to sterol-derived aglycones.³²⁶

2.5 Chemical degradation methods for semisynthesis

Advanced intermediates for GSL syntheses are commonly obtained by partial degradation of glycolipids isolated from natural sources. Semisynthetic methods for glycolipid synthesis involve the controlled degradation of isolated GSLs and can be essential for generating targets that incorporate modified groups, such as tags or labels. Both chemical and enzymatic methods have

found use in semisynthesis and analysis of glycolipids. This section introduces some common chemical strategies for semisynthetic degradation available for the synthesis of GSL targets.

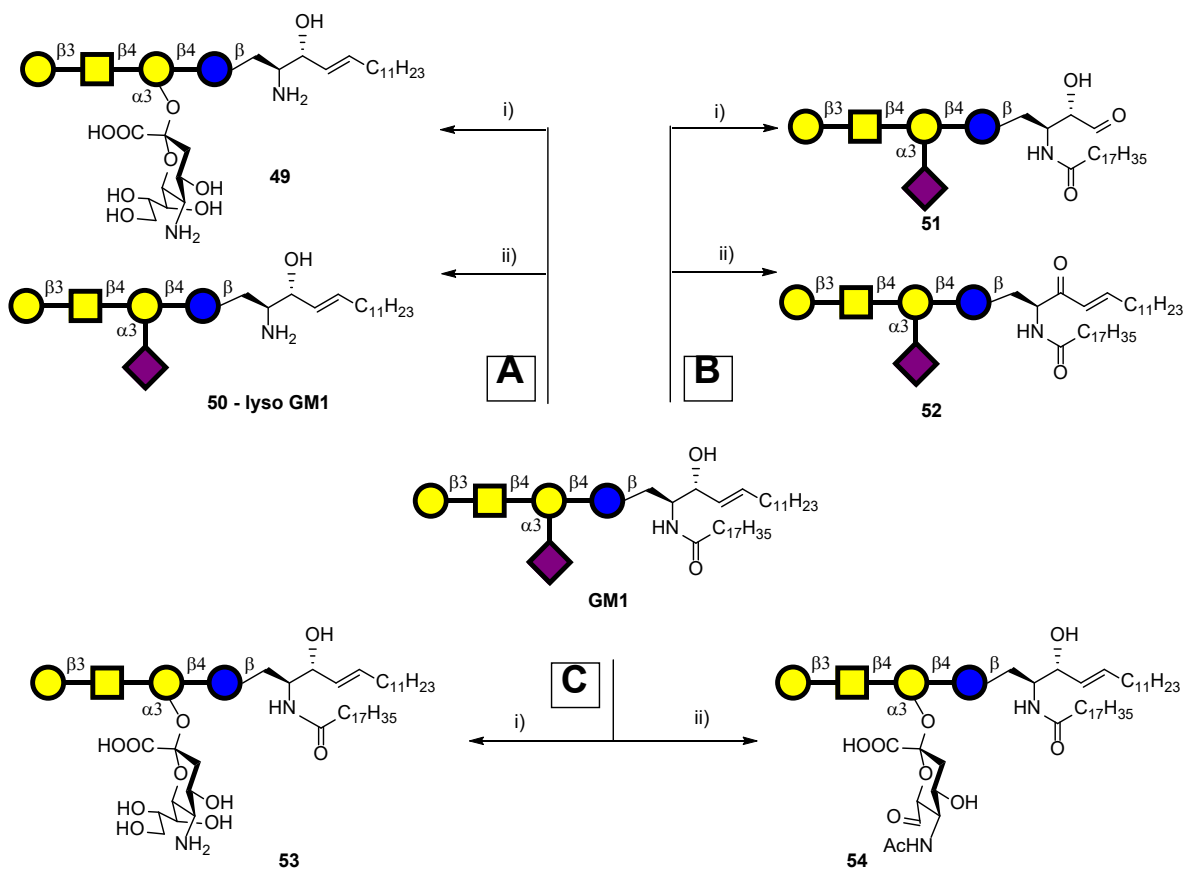

Figure 8. Common methods for the selective chemical degradation of glycolipids, using GM1 as an example. A) Removal of the fatty acid by alkaline hydrolysis, as detailed in Sec 2.5.1; general conditions: i) KOH to give amine **49** (49), ii) to produce lyso GM1 (**50**). B) Oxidation of the sphingosine alcohol or alkene, as detailed in Sec 2.5.2; general conditions: i) O₃, or NaIO₄ with OsO₄ to yield an aldehyde (**51**), ii) DDQ-mediated oxidation to provide the α,β -unsaturated ketone **52**. C) Chemical degradation of the glycan; general conditions: i) selective sialic acid de-*N*-acetylation to give amine **53**, ii) NaIO₄ oxidation to produce aldehyde **54**.

2.5.1 Removal of the fatty acid chain

Perhaps the most common semisynthetic approach to generate glycolipid probes involves alkaline hydrolysis of the fatty acid chain to produce a lyso-glycolipid that contains a free amine for further functionalization. A discussion of the re-acetylation of lyso-glycolipids with labeled fatty acids to

generate glycolipid probes can be found throughout **Sec 4**. Early hydrolysis conditions used 1 M KOH in 90 % butanol (**49, Figure 8 A.i.**),^{327,328} but modifications include changing the solvent to aqueous methanol³²⁹ or mild basic conditions, such as 0.3 M KOH³³⁰ or 1 M NaOH.³³¹ Even under these milder conditions, the sialic acid *N*-acetamido group is typically cleaved, while *N*-acetylgalactosamine residues tend to be stable. Lyso-gangliosides have been obtained after selective sialic acid *N*-acylation of deacetyl-deacyl gangliosides.³²⁹ Changing the base to (CH₃)₄NOH has improved yields of the lyso-gangliosides.³³² Sodium *tert*-butoxide in anhydrous methanol is reported to selectively remove the *N*-acyl fatty acid and generate lyso-GM3 (**Figure 8 A.ii.**)³³³

2.5.2 *Sphingosine degradation*

Selective oxidation can be used to introduce a variety of functional groups into the sphingosine portion of GSLs. Methods have typically targeted either the *C*-3 alcohol or the *C*-4 alkene of the sphingosine moiety. Ozonolysis of the sphingosine *C*-4 alkene generated an aldehyde-containing GSL^{334,335} (**51, Figure 8 B.i.**), which can be further functionalized. The resulting α -hydroxyaldehyde GSLs are sensitive to alkaline conditions, which can release the carbohydrate moiety through a β -elimination mechanism.³³⁵ The glycan of ozone-treated GSLs can be released in near-neutral conditions, allowing more reliable analysis of glycan composition.³³⁶ Further treatment of aldehyde-containing GSLs with H₂O₂ generated a *C*-4 carboxylic acid, which could then be used for amide bond-forming reactions.³³⁷ Quenching of the ozonolysis reaction with Me₂S^{338,339} or PPh₃³⁴⁰ allowed for the isolation of the aldehyde-containing GSLs, which could be further derivatized via the aldehyde. Ozonolysis of peracetylated GSLs, followed by reduction with NaBH₄, generated GSLs with a truncated sphingosine containing a *C*-4 primary alcohol.³⁴¹

Oxidation of the GSL alkene with periodate is an alternative to ozonolysis but requires protection of the glycan. After peracetylation of the GSL, OsO₄ was used to catalyze oxidation by

sodium periodate to generate a GSL containing a C-4 sphingosine aldehyde (**51**, **Figure 8 B.i**.) Subsequent hydrolysis under alkaline conditions released the carbohydrate moiety.³⁴² Using periodic acid instead of sodium periodate improved the yields of the GSL aldehyde **51**, which could then be used to release the glycan (under alkaline conditions), or could be oxidized to a carboxylic acid using performic acid.³⁴³ Treatment of peracetylated GSLs with KMnO₄ in the presence of dicyclohexyl-18-crown-6 or acetone generated carboxylic acid-containing GSLs directly.^{343,344} This method has been further modified to use less potassium permanganate and an excess of sodium periodate.^{345,346} Oxidation under basic conditions produced the further truncated serine acids.³⁴⁶

Methods targeting the alcohol at C-3 of sphingosine for oxidation have primarily employed 2,3-dichloro-5,6-dicyano-1,4-benzoquinone (DDQ) as the oxidizing agent. DDQ specifically oxidized the C-3 alcohol to a ketone in neutral glycosphingolipids^{347,348} and gangliosides (**52**, **Figure 8 B.ii**.)³⁴⁹ Although this degradation method has primarily been used for radiolabeling of glycosphingolipids through subsequent reduction of the ketone with NaB³H₄ (see **Section 4.1.1**), treatment of the 3-keto-GSLs, like **52**, with triethylamine has been used to promote β-elimination release of the carbohydrate moiety.^{350,351} Recently, a new approach to oxidative degradation was reported in which NaClO was used to release glycan nitriles from GSLs, which could be reduced with NiCl₂-NaBH₄ to generate an ethylamine aglycone. The proposed oxidative mechanism does not involve the alkene or the alcohol at C-3, but rather the oxidative elimination of the amide.³⁵²

2.5.3 Glycan degradation

Residue-selective degradation methods for the glycan of GSLs typically target sialic acid residues. The selective removal of the *N*-acyl group of sialic acid was applied to the semisynthesis of Neu5Gc GM1.^{332,353} Hydrazinolysis was also used to selectively remove the sialic acid *N*-acyl group (**53**, **Figure 8 C.i**.)³⁵⁴ A milder and more versatile sialic acid degradation method has been

periodate oxidation of the glycerol side chain to generate an aldehyde at *C*-7 of sialic acid (**54**, **Figure 8 C.ii.**)^{355,356} The first application of sialic acid oxidation with sodium periodate for semisynthetic labeling was on a sialoglycoprotein substrate,³⁵⁷ however, the method was expanded to a range of ganglioside substrates^{358,359} and is still used for the controlled degradation of sialic acids on ganglioside substrates.^{161,360 (refs therein) 195,361} Mild periodate oxidation conditions are compatible with sialic acid labeling on live cells (see **Sec 4.4.1**).³⁶²⁻³⁶⁵

3 Chemoenzymatic synthesis of glycolipids

A major challenge to the synthesis of glycolipids lies in generating the glycan moiety with regio- and stereo- selectivity. Chemical approaches, such as those described in **Sec 2** of this review, typically involve careful manipulation of protecting groups and glycosylation strategies that may require long synthetic routes. In contrast, chemoenzymatic approaches exploit the selectivity of enzymes to catalyze glycosylation without the need for protecting groups. The advantages of using enzymes for glycan synthesis were recognized as soon as biosynthetic enzymes were identified;³⁶⁶ however, due to limited access to the enzymes and sugar nucleotide donors,³⁶⁷ the application of enzymatic approaches were initially limited. Excellent reviews pertaining to the biosynthesis of glycosphingolipids are available.^{6,368,369} An improved understanding of glycan anabolism, catabolism, enzyme mechanisms, and the development of protein engineering techniques have led to improved efficiency and reduced costs for enzymatic approaches. Several recent reviews are available on this topic.³⁷⁰⁻³⁷⁶ This section will give a brief overview of the development and principles of enzymatic synthesis as applied to GSLs and glycolipids.

3.1 Chemoenzymatic synthesis using glycosyltransferases

Most mammalian glycosyltransferases are membrane-associated and difficult to purify, making them incompatible with large scale preparations. This limitation, along with the high cost of sugar

nucleotides, was a major limitation for early chemoenzymatic approaches to the synthesis of simple oligosaccharide fragments.^{367,377} A major breakthrough for chemoenzymatic approaches to glycan synthesis was the finding that many pathogenic bacteria expressed oligosaccharide epitopes that mimic mammalian carbohydrate structures,³⁷⁸ which led to the discovery of bacterial glycosyltransferases with similar functions to mammalian enzymes.³⁷⁹ Bacterial glycosyltransferases are more easily expressed as soluble recombinant proteins and often have broad substrate scope for glycosyl acceptors.³⁷⁹ The substrate scope, physical properties, and efficiencies of these enzymes may be further improved through protein engineering.³⁷⁴

Ceramides tend to be too hydrophobic to act as acceptors in glycosyltransferase-mediated glycosylation.³⁸⁰ The chemoenzymatic synthesis of GSLs has instead employed sphingosine or 2-azidosphingosine as the glycosyl acceptor, with the fatty acid introduced in the last step of the synthesis, similar to many chemical synthetic methods.^{29,35,36,380-382} This approach is still relevant for the total synthesis of glycolipids using chemoenzymatic methods.^{33,383} The glycans of glycolipids can be synthesized in a combinatorial manner analogous to their biosynthetic pathways.^{384,385} The high cost of sugar nucleotides used as donors in enzymatic glycosylation was lowered by the development of sugar nucleotide generating systems, where the donors were generated in situ from cheap starting materials. Sugar nucleotides such as UDP-GlcNAc, UDP-GalNAc, UDP-Gal, and GDP-Fuc can be generated from monosaccharides using glyco kinase and sugar nucleotide pyrophosphorylase (or nucleotidyltransferase).³⁷⁵ CMP-Sia can be generated from sialic acids and CTP using the CMP-sialic acid synthetases (CSS). Sialic acids may also be generated in situ from mannose analogues and pyruvate using aldolase enzymes.³⁸⁶ These sugar donor-generating systems have been used in combination with different bacterial glycosyltransferases in glycolipid synthesis.³⁷⁵ In practice, the generation of sugar donors and glycosyltransferase-catalyzed glycosylation can be conducted in one pot, and this strategy is known as a one-pot multienzyme (OPME) system.^{375,387} The OPME systems reduced the

purification steps needed for chemoenzymatic syntheses, leading to more straightforward synthetic procedures and higher product yields.³⁷⁵ Strategies to simplify this approach have included immobilization of the panel of enzymes onto solid-support, known as “super beads”.^{388,389} A summary of enzymes relevant for chemoenzymatic synthesis of glycolipids discussed in this review is provided in **Table 4**.

3.1.1 Synthesis of ganglio-series glycosphingolipids

For ganglio-series glycolipids, chemoenzymatic strategies have typically started from Lac or lactosides (**Figure 9**). Selective sialylation of lactoside was achieved using three (α 2-3)-sialyltransferases (SiaT) identified from *P. multocida*: PmST1^{M144D33,63}, PmST2³⁹⁰, or PmST3.³⁹¹ PmST1^{M144D} is a mutant form of the multifunctional enzyme PmST1. The M144D mutation has decreased (α 2-3)-sialidase and donor hydrolysis activities without impeding (α 2-3)-SiaT activity.³⁹² PmST1 preferred oligosaccharide acceptors, so Lac was primarily used as the acceptor, and the lipid moiety was incorporated afterwards using chemical synthesis.^{33,63} PmST2 and PmST3 are both monofunctional (α 2-3)-SiaTs, which can use lactosyl lipids as acceptors. PmST2 preferred glycolipids and PmST3 accepted both oligosaccharides and glycolipids.^{390,391}

Several SiaTs responsible for the biosynthesis of lipo-oligosaccharides in *C. jejuni* have found wide application in the synthesis of ganglio-series glycans.³⁹³ The (α 2-3)-SiaT CjCstI was used to sialylate a lactosyl lipid,⁷⁹ and has been applied to the synthesis of fluorescent GM3 analogues as FRET probes for ganglioside-processing enzymes.³⁹⁴ Another multifunctional (α 2-3/8)-SiaT, CjCstII, was used to sialylate the GM3 trisaccharide.^{63,395} The enzyme could also use Lac and GD3 oligosaccharides as acceptors. Starting from lactoside and an excess of CMP-Neu5Ac, CjCstII catalyzed multiple sialylations with the yields of GD3 and GT3 corresponding to the equivalents of CMP-Neu5Ac in the reaction.³⁹⁶ Many SiaTs can tolerate sialic acid modifications. Using PmST1^{M144D}, GM3 trisaccharides with Neu5Gc, Kdn, and Neu5Ac8OMe

sialic acids have been synthesized.⁶³ A mutant form of CjCstII, CjCstIIΔ32^{I53S} was used to make GD3 oligosaccharide analogues with C5 or C9 modifications on the terminal or penultimate sialyl groups.³⁹⁷ In the synthesis of several Neu4,5Ac₂-containing glycans, including GM3, only PmST3 could accommodate CMP-Neu4,5Ac₂ and CMP-Neu4Ac5Gc donors.³⁹⁸ Glycosphingolipid analogs have also been tolerated. The chemoenzymatic synthesis of GM3 and GM2 analogs with a truncated ceramide,³⁹⁹ and GM3 analogs with alkyl aglycones have been reported.^{400,401} Recently, soluble recombinant enzymes have been used to modify glycolipid substrates embedded within a liposome.⁴⁰² An *N*-acetylglucolipid was inserted into a phospholipid liposome and was extended by the sequential action of a (β1-4)-GalT and a trans-sialidase to make liposome-embedded GM3 analogues.⁴⁰²

The glycans of a number of complex gangliosides have been synthesized using chemoenzymatic strategies. The (β1-4)-GalNAcT CjCgtA from *C. jejuni* introduced a GalNAc to GM3/GD3/GT3 to generate the corresponding GM2/GD2/GT2 glycans in high yields. However, the enzyme did not tolerate asialo substrates.⁴⁰³ GM2 and GD2 oligosaccharides were extended to generate GM1 and GD1b using the (β1-3)-GalT CjCgtB (*C. jejuni*).^{63,396} A mammalian (α2-3)-SiaT (ST3GalI)⁴⁰⁴ was used to sialylate GM1 to generate GD1a in high yields.³⁹⁶ The synthesis of gangliosides containing disialylated glycans where the two sialic acids are linked in different configurations is challenging. The SiaTs PmST1 and Pd2,6ST (an (α2-6)-SiaT) were employed to generate the non-reducing end tetrasaccharide of GT1α and GQ1bα in a mixed synthetic and enzymatic approach.⁴⁰⁵ The Neu5Ac(α2-3)Gal linkage was generated with PmST1, followed by chemical 1,4-lactonization between the C1''-carboxyl group of Neu5Ac and the C4'-hydroxyl group of the adjacent Gal, which enabled the selective formation of the Neu5Ac(α2-6)GalNAc linkage using Pd2,6ST.⁴⁰⁵ Thio-oligosaccharides have been used as substrates for glycosyltransferases. The CjCgtA and CjCstII enzymes recognized S-linked GM3 as an acceptor

to synthesize S-linked GM2 and GD3, which were conjugated to proteins and used as immunogens.³⁰⁵

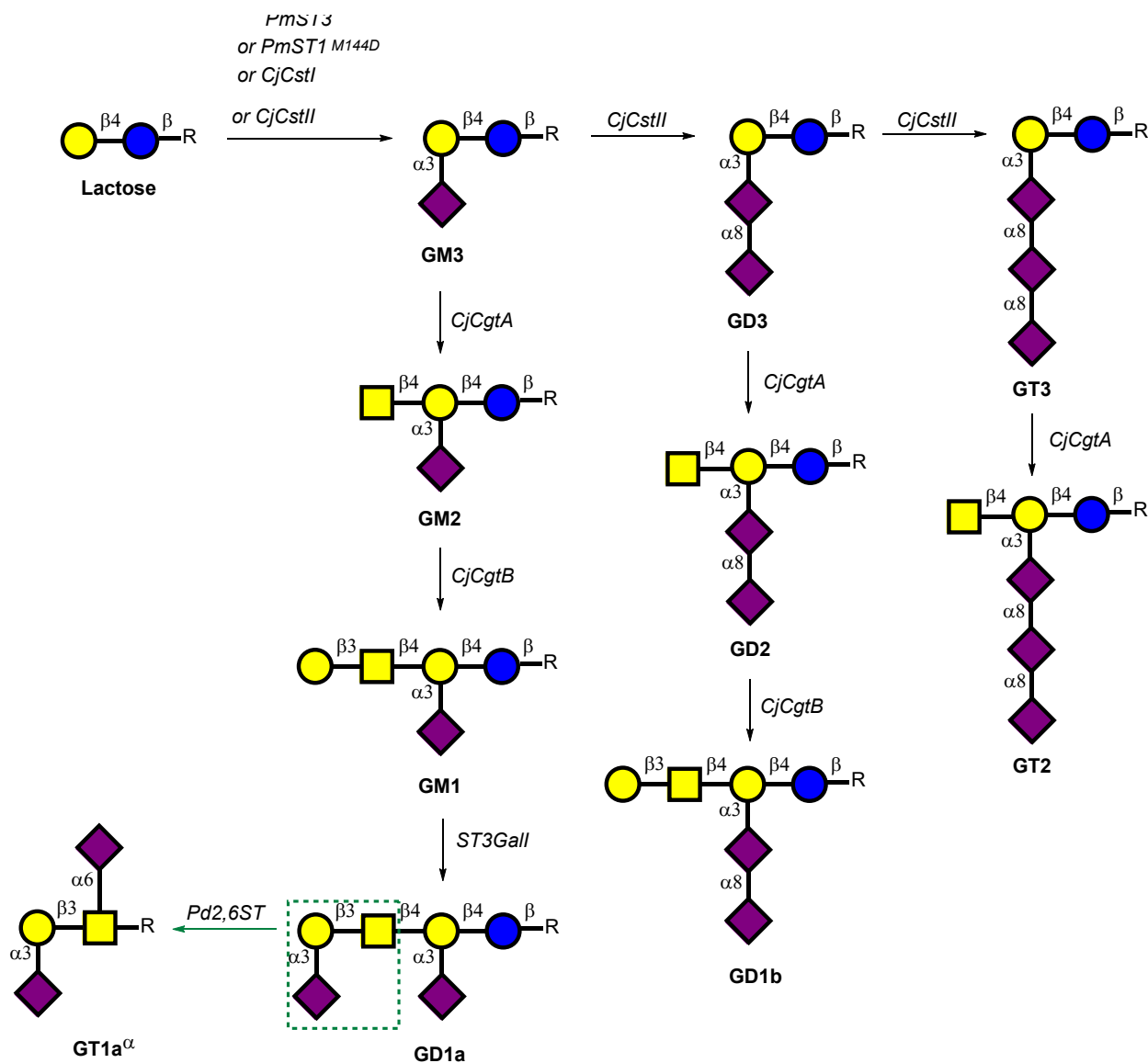

Figure 9. Chemoenzymatic synthesis of ganglio-series oligosaccharides. For clarity, glycolipid names are used to describe only the glycan moiety, where R can be OH in the oligosaccharides or Cer for glycolipids. The green box indicates the partial structure that was used in the transformation described by the green arrow.

3.1.2 Synthesis of globo/isoglobo and lacto/neolacto series glycosphingolipids

Chemoenzymatic syntheses of globo/isoglobo and lacto/neolacto series oligosaccharides have been reported (Figure 10). An (α1-4)-GalT, NmLgtC,⁷¹ was used to construct the (α1-4) linkage

between the two galactose residues in the globotriose Gb3.⁶³⁻⁶⁶ A bovine (α 1-3)-GalT (Ba1-3GalT) catalyzed the formation of the (α 1-3) linkage in isoglobotriose iGb3. The (β 1-3)-GalNAcT activity of HiLgtD was used to convert Gb3/iGb3 to Gb4/iGb4. HiLgtD was also used to synthesize Gb5 (stage-specific embryonic antigen-3, SSEA-3) and iGb5 pentasaccharides in moderate yields.⁶⁴ Improved yields of Gb5 were obtained with the (β 1-3)-GalNAcT, CjCgtB.⁶³ A sialyl group, with or without modifications at the C8 position, could be introduced to Gb5/iGb5 using CjCstI⁷⁵ or PMST1^{M144D}⁶³ to generate sialyl-Gb5 (also called stage-specific embryonic antigen-4, SSEA-4) or sialyl-iGb5. Another sialyltransferase with a broader acceptor scope, JT-FAJ-16 (*Vibrio sp.*),⁴⁰⁶ catalyzed this step.⁶⁴ A large scale chemoenzymatic synthesis of Gb3 and iGb3 has been developed using a chemoenzymatic strategy which exploited an epimerase to convert UDP-Glc to UDP-Gal (GalE, from *E. coli*).⁷² The total synthesis of Gb3 and iGb3 using a combination of chemoenzymatic and synthetic methods has been reported.⁷⁰

The discovery of bacterial fucosyltransferases has allowed for the enzymatic syntheses of more complex globo/isoglobo series oligosaccharides. The (α 1-2)-FucT, EcWbsJ⁴⁰⁷, and HpFutC⁴⁰⁸ enzymes were used to fucosylate Gb5 for the synthesis of Globo H.^{64,75} Using the fucosyltransferase HpFutC, sialyltransferase JT-FAJ-16, and the NTP recycling system, allyl derivatives of Globo H and SSEA4 glycans were made at multi-gram scale.^{64,66}

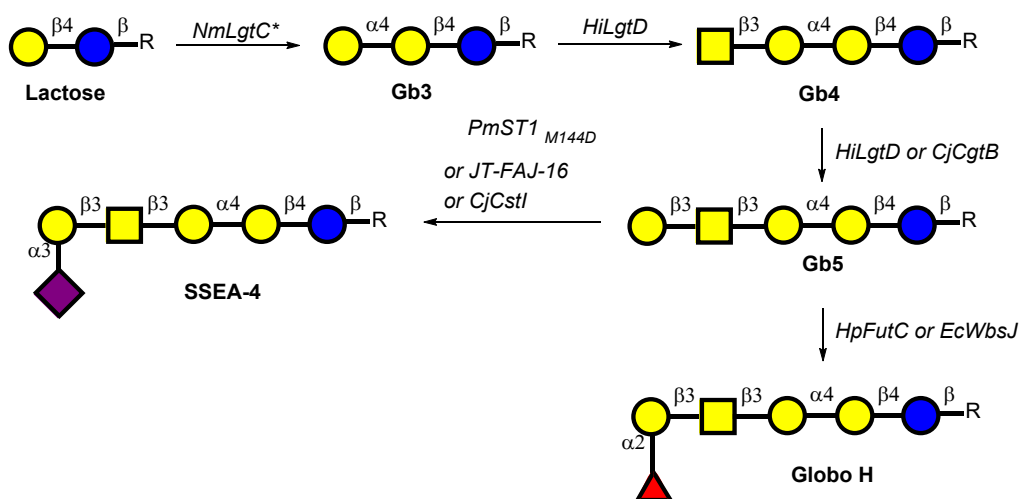

Figure 10. Chemoenzymatic synthesis of globo/isoglobo series oligosaccharides. Steps indicated with a * indicates that if an (α 1-3)-GalT was used in the first transformation, instead of an (α 1-4)-GalT, iGb3 was generated. Additionally, the same enzymes used in the synthesis of Gb4/Gb5/sialyl-Gb5 can be used for iGb4/iGb5/sialyl-iGb5.

The lacto and neolacto-series of glycolipids have been prepared using lactose or lactosides as a starting material (**Figure 11**), and Lc4 and nLc4 share epitopes with the human milk oligosaccharides, lacto-N-tetraose (LNT) and lacto-N-neotetraose (LNnT), respectively. Two (β 1-3)-GlcNAcTs, HpLgtA⁶⁵ and NmLgtA,⁶³ catalyzed the formation of Lc3 from lactoside in good yields. The enzymatic conversion of Lc3 to Lc4 was reported using the (β 1-3)-GalT Ecwbgo,⁷⁷ two (β 1-4)-GalTs – NmLgtB,^{63,65,78} and Hp1,4GalT⁷⁹ – catalyzed the conversion from Lc3 to nLc4. Both Lc4 and nLc4 were sialylated by PmST1^{M144D} to form sialyl-Lc4 and sialyl-nLc4, which could also be prepared with modifications to the sialic acid.^{63,78} Different isomers of disialylated Lc4 and nLc4 with (α 2-3) or (α 2-6)-linked sialyl groups on the terminal Gal residue were made using the (α 2-6)-SiaT Pd2,6ST, and PMST1 mutants including PMST1^{M144D} and PMST1^{P34H/M144L 409-411}.

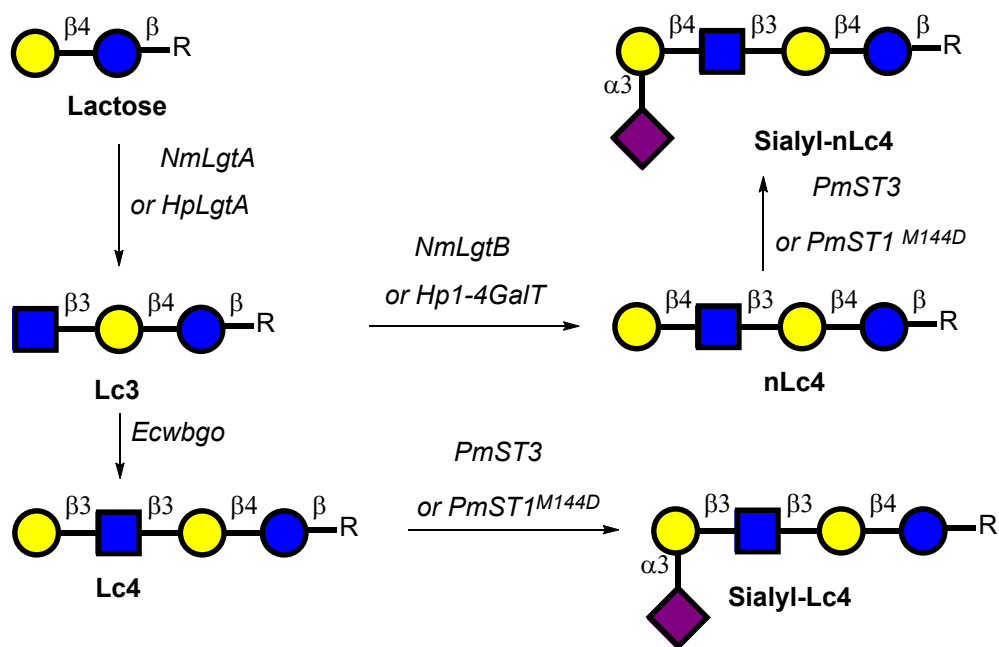

Figure 11. Chemoenzymatic synthesis of lacto/neolacto series oligosaccharides.

Some members of the globo/isoglobo and lacto/neolacto oligosaccharide series share glycan structures with blood group antigens, particularly the ABH, Lewis, and the P¹P^K blood group antigens. For instance, Gb3 shares a triose with the P^K antigen, and Gb4 with the P antigen. These fragments are widely distributed on glycolipids, glycoproteins, and oligosaccharides.⁴¹² Lewis blood group antigens could be synthesized from lacto/neo-lacto series precursors (**Figure 12**). A glycosynthase (see **Sec 3.2**) from *B. bifidum* (BbAfcB^{D703S}) was used to fucosylate the Lc4 tetrasaccharide to generate the Lewis^a (Le^a) pentasaccharide.⁸¹ Fucosylation of *N*-acetyllactosamine (LacNAc) generated the nonreducing-end trisaccharide of the Lewis^x (Le^x) antigen.⁸¹ The full Le^x pentasaccharide was synthesized from nLc4 through fucosylation by Hpα1,3FT^{82,83} or its mutant form Hpα1,3FTΔ66,^{78,82} and sLe^x was generated through sialylation of Le^x by PMST1^{M144D}.⁸⁷ Alternatively, the sLe^x tetrasaccharide was synthesized through fucosylation of Neu5Ac(α2-3)Galβ(β1-4)GlcNAc(β)ProN₃ with Hpα1,3FTΔ66.⁸² A rat liver (α2-3)-SiaT and milk (α1-3)-FucT were used for the synthesis of a trimeric sLe^x.⁸⁸ Fucosylation of the

nonreducing-end disaccharide of Lc4 using (α 1-2)-FucT HpFutC generated the H type I antigen; and the same enzyme was used to generate H type III and type IV antigens from their disaccharide precursors.⁸⁹ The H type IV antigen shares an epitope with the terminal trisaccharide of Globo H. From the non-reducing end disaccharide of nLc4, fucosylation with (α 1-2)-FucT EcWbgL generated the H type II antigen; and the H type VI antigen was generated using the same enzyme.⁸⁹ Starting from the H antigen, the (α 1-3)-GalNAcT HmBgtA enzyme was used to introduce a terminal GalNAc to generate the blood group A antigen tetrasaccharides. Alternatively, a recombinant human blood group B glycosyltransferase (GTB) introduced the (α 1-3)-galactosyl linkage for the blood group B antigens (**Figure 12**). Together, this approach provides access to the 15 naturally occurring human ABH antigen determinants.⁸⁹ A combination of glycosyltransferase and glycosynthase (*vide infra*) activity has also been applied to the synthesis of the A type II antigen. Starting from 4-methylumbelliferyl *N*-acetyl- β -D-glucosaminide (MU- β GlcNAc), the (β 1-4)-galactosynthase Abg^{2F6} catalyzed the addition of (β 1-4)Gal. Subsequent (α 1-2)-fucosylation and (α 1-3)-*N*-acetylgalactosamination, catalyzed by EcWbgL and HmBgtA respectively, could be performed in one pot.⁹⁰

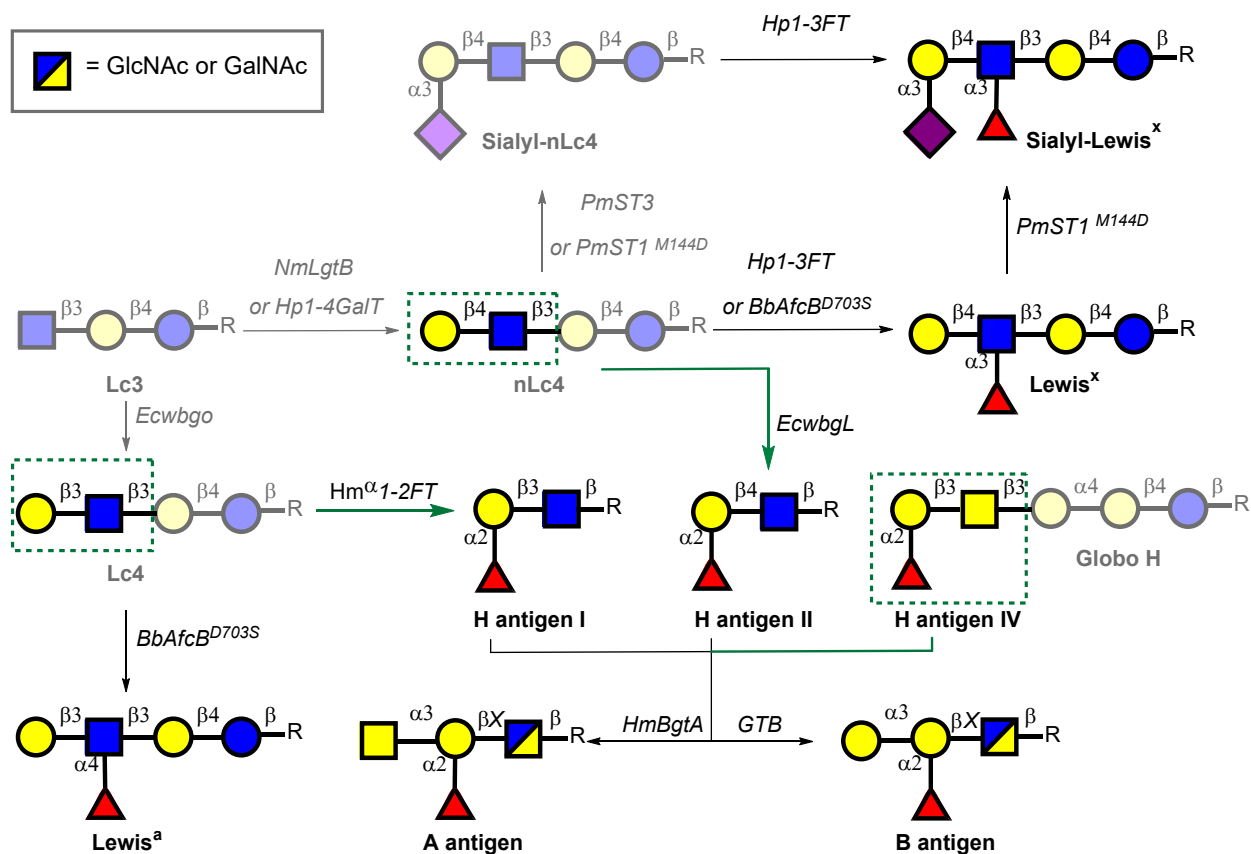

Figure 12. Chemoenzymatic synthesis Lewis and ABH antigen oligosaccharides from lacto/neolacto and globo/isoglobo series oligosaccharides. For clarity, R can represent OH in the case of the oligosaccharide, or an unspecified aglycone. Faded structures indicate glycan structures reproduced from Figure 11. Green boxes indicate the partial structures that were used in the transformations described by the green arrows.

3.1.3 Engineered microorganisms

Although widely used in the assembly of oligosaccharides, the use of OPME systems is limited by its requirement for purified enzymes. Enzyme expression systems, such as engineered microorganisms, with the ability to synthesize glycans without enzyme purification overcome this limitation.^{413,414} Substantial progress to this end has been made using two strategies: bacterial coupling, where the enzymes needed for synthesis are expressed by several bacterial strains,⁶⁷ and single bacteria “superbugs”,^{413,415} where all the enzymes required for synthesis of the target are expressed in a single bacterial strain.^{80,416-418} Engineered bacteria used for this purpose will also

have genes encoding sugar degrading enzymes knocked out to avoid hydrolysis of starting materials or products. Additionally, permeases allow uptake of the sugar precursors by the bacteria.^{413,414} Both strategies have been applied to the synthesis of the oligosaccharide moieties of glycolipids, particularly the ganglio-series, as discussed below.

Bacterial coupling was used to generate a UDP-Gal expression system from three *E. coli* strains transfected with UDP-Gal biosynthetic genes (*galT*, *galK* and *galU*) and one *C. ammoniagenes* strain (for production of UTP). The system generated UDP-Gal upon addition of orotic acid, galactose, and xylene. Adding an α -GalT gene (*N. gonorrhoeae*) and Lac to the system produced Gb3.⁶⁷ Using the same strategy, a LacNAc expression system⁴¹⁹ and a CMP-Sia/Sialyllactose-expression system⁴²⁰ was also developed.

The single bacteria “superbug” strategy has found more applications in the synthesis of glycolipid oligosaccharides and has the potential to be more scalable and cost-effective than other strategies.⁴²¹ An engineered bacterial strain that overexpressed an (α 2-3)-SiaT gene and a CSS gene from *N. meningitidis* produced the GM3 oligosaccharide from exogenous Neu5Ac and lactose.⁸⁰ Additional overexpression of CjCstII generated a strain that produced GD3 and GT3 oligosaccharides. The proportion of GD3 or GT3 produced could be adjusted by varying the lactose:Neu5Ac ratio provided to the bacteria.⁴²² From an engineered GM2 oligosaccharide-producing strain, addition of a (β 1-3)-GalT (CjCgtB), resulted in a GM1 oligosaccharide-producing strain.⁴²³ Using modified Neu5Ac precursors, modified GM2 analogues were produced.⁴²⁴ Modifications to the lactoside were also tolerated, generating saccharide moieties of GM2 and GM3 which could be further conjugated.⁴²⁵ Encoding Neu5Ac synthesizing enzymes avoided the need for exogeneous Neu5Ac, which should further reduce the cost of production for ganglioside oligosaccharides;⁴²⁶ however, complications may include the possibility of excess sialylation.⁴²⁷ Controlled polysialylation of lactosides has been realized in engineered bacteria by overexpressing polysialyltransferases.⁴²⁸

The globo and lacto/neolacto series oligosaccharides have been made using engineered organisms. Gb3 synthesis was achieved using a bacterial coupling approach⁶⁷ as well as using a single engineered *E. coli* “superbug” strain.^{68,69} Engineered bacterial strains were produced for the synthesis of Gb4⁶⁹ and Gb5.⁷⁴ Interestingly, Gb4 and Gb5 could be produced from the same engineered *E. coli* “superbug” where HiLgtD demonstrated (β 1-3)-GalNAcT activity specific for Gb3 acceptors and (β 1-3)-GalT activity specific for Gb4 acceptors.⁷⁴ The Lc3 oligosaccharide was produced by providing lactose to a (β 1-3)-GlcNAcT overexpressing strain. Additional overexpression of a (β 1-3)-GalT in the Lc3-producing strain gave an Lc4-producing strain,⁷⁶ while overexpression of a (β 1-4)-GalT gave an nLc4-producing strain.⁸⁴ Fucosylated nLc4 products, including Le^x analogues, were obtained by the overexpression of an (α 1-3)-FucT to the nLc4 producing strain,⁸⁴ whereas overexpression of an α 1,2-FucT produced the H type II antigen.⁹¹ Interestingly, the (α 1-2)-FucT used (HpFutC) was only able to fucosylate Lc4 scaffolds *in vitro*,⁸⁹ indicating that glycosyltransferases may have different properties *in vitro* and *in vivo*.

3.2 Chemoenzymatic synthesis using glycosidases and glycosynthases

Glycosidases (glycoside hydrolases) are defined by the CAZy database (Carbohydrate-Active enZYmes Database) as enzymes that hydrolyze or rearrange glycosidic bonds.⁴²⁹ They are classified as exo- or endo-glycosidases based on the glycosidic bond they cleave (terminal vs internal). The stereochemical outcomes of the anomeric center could be the same as (retaining glycosidases) or opposite to (invertig glycosidases) the substrate. Both catalytic mechanisms have been thoroughly reviewed elsewhere.⁴³⁰⁻⁴³² Some retaining glycosidases can catalyze transglycosylation reactions, in which a second sugar molecule acts as the nucleophile in place of water.⁴³³ A small portion of glycosidases adopt unusual mechanisms⁴³¹ such as substrate-assistance in *N*-acetylhexosaminidases,⁴³⁴ and β -elimination in bacterial lyases.⁴³⁵

The hydrolysis of glycans mediated by retaining glycosidases is reversible, which offers the potential for using retaining glycosidases to catalyze the formation of glycosidic bonds by optimizing reaction conditions. Glycosidic bond formation by glycosidases has been achieved via thermodynamic control (reverse hydrolysis) or kinetic control (transglycosylation). The formation of glycosidic bonds is thermodynamically unfavorable ($\sim 4 \text{ kcal mol}^{-1}$),⁴³⁶ so reverse hydrolysis strategies tend to require a high concentration of sugars, organic co-solvents, and elevated reaction temperatures to shift the equilibrium towards bond formation.⁴³⁷ Transglycosylation reactions have employed activated glycosides (usually glycosyl fluorides⁴³⁸ or glycosyl phenols with the correct donor configuration) to set the stereochemistry of the products, which could also act as substrates for enzymatic hydrolysis. Control of reaction times has been used to avoid product hydrolysis, however, yields may still be low.^{433,439}

Despite the challenges of glycosidase-mediated glycosylation, glycosidases have been used in the synthesis of some simple glycolipid components. Promiscuous regioselectivity was a problem for some early transglycosylation efforts,⁴⁴⁰⁻⁴⁴³ although others afforded an (α 1-3)Fuc linkage^{444,445} and a (β 1-4)GlcNAc linkage selectively.⁴⁴⁶ The latter study generated a series of sulfated disaccharides that may be useful in the synthesis of sulfated Le^x and Le^a.⁴⁴⁶ A neoglycolipid component was synthesized using reverse hydrolysis of a crude cellulase preparation from *T. reesei*. Lac and a large excess of glycerol were condensed to form 1-*O*- β -lactosyl-(*R,S*)-glycerol and 2-*O*- β -lactosyl glycerol in a ratio of 7:3.⁴⁴⁷ The same cellulase also condensed Lac or LacNAc with excess 1,6-hexanediol to form 6-hydroxylhexyl β -lactoside (Lac β -HD) and 6-hydroxylhexyl β -*N*-acetyllactoside (LacNAc β -HD). These products were conjugated with dipalmitoylphosphatidyl choline (DPPC) using phospholipase D (*Streptomyces sp.*), to form Lac-DPPA (dipalmitoylphosphatidic acid) and LacNAc-DPPA. Introduction of an NBD group into the lipid moiety markedly decreased the yield of transphosphatidylation. The same strategy was employed to make two other neoglycolipid analogues from allyl β -lactose.³¹⁴

A major impediment to glycosidase-mediated glycosylation is the competing hydrolysis reaction, which can severely limit product yields. A clear understanding of the mechanisms of glycosidases has enabled the mutation of these enzymes into efficient transglycosylases, known as glycosynthases.^{448,449} In a pioneering study, Withers and coworkers mutated the active-site nucleophile of *Agrobacterium sp.* β -glucosidase (Abg) to alanine, abolishing its hydrolase activity. Transglycosylation activity could be rescued using activated glycosyl donors that mimicked the glycosyl enzyme intermediate and could be trapped by an acceptor.⁴⁵⁰ Random mutagenesis of this enzyme identified additional glycosynthases.⁴⁵¹ The concept of glycosynthases has since been widely adopted.³⁷² This concept has been applied to endoglycosidases to generate an inverting β -glucansynthase from a retaining (1-3)-(1-4)- β -glucanase (*B. licheniformis*, EC 3.2.1.73).⁴³⁶ This engineered glycosynthase used the activated disaccharide α -laminaribiosyl fluoride as donor, broadening the application of glycosynthases in oligosaccharide synthesis.^{373,436} Other enzymes which have been used to produce glycosynthases include α -retaining glycosidases,^{81,452-454} inverting glycosidases,^{455,456} and *N*-acetylhexosaminidases.³⁷³ Glycosynthases have been widely used in the synthesis of oligosaccharides, glycopeptides, glycoproteins, and glycosylated natural products.³⁷³

The enzymatic synthesis of galactosylceramides was made possible by the development of a galactosynthase to catalyze the formation of lyso- β -GalCer. A β -galactosidase from *T. thermophilus*, TtbGly, was converted to a glycosynthase and applied in the stereoselective β -galactosylation of 2-amino-3-thiazolylpropan-1,3-diol, a precursor for sphingosine synthesis.⁴⁵⁷ Recently, another galactosynthase was generated from *B. circulans* (BgaC^{E233G}), and was found to selectively catalyze the formation of a β 1,3-galactosyl linkage in LacNAc, galacto-*N*-biose analogues,^{458,459} and poly-LacNAc oligomers (in combination with glycosyltransferases).⁴⁶⁰

A glycosynthase was engineered from endoglycoceramidase II (EGCase II, *Rhodococcus*) and used for glycosylation of ceramide precursors. Using D-erythro-sphingosine as the acceptor,

EGCase II^{E351S} catalyzed the formation of lyso-Lac, -GM3, -GM1, -Gb3, and cellobiosyl sphingosines with excellent yields (>90%). Modifications to the sphingosine moiety were moderately tolerated. Intact gangliosides were obtained by fatty acid acylation of their lyso analogues.³⁴ Screening for EGCase II glycosynthases identified a mutant with improved efficacy towards different sphingosine acceptors.⁴⁶¹

Combining glycosyltransferases with EGCase II glycosynthases to build the carbohydrate moiety on sphingosine could be a powerful approach to glycosphingolipid synthesis. This strategy was adopted for the synthesis of lyso-GM3 analogues and two neolacto series GSLs, starting from lactosyl fluoride. The GSLs were constructed either through immediate glycosylation of sphingosine using an EGCase II glycosynthase followed by elaboration of the carbohydrate moiety with glycosyltransferases, or by first expanding the carbohydrate moiety and finishing with EGCase II-mediated glycosylation of Sph.⁷⁹

Although glycosynthases are overwhelmingly made from retaining glycosidases, inverting glycosidases have also been explored. An understanding of the “Hehre resynthesis-hydrolysis mechanism” was credited with inspiring the invention of glycosynthases.^{438,455,462} Glycosynthases generated from inverting glycosidases were obtained by mutating the active site base, rather than the active site nucleophile.^{455,456} The (α 1-2) fucosynthase made from an inverting FucT can be used to generate H-antigens⁴⁶³ and will directly fucosylate GM1.⁴⁶⁴ Mutation of the catalytic acid/base residues has been applied to retaining glycosidases on the principle that once a covalent glycosyl enzyme intermediate was formed, acceptors with a strong nucleophile could compete with water to trap the intermediate despite the absence of a general base. The strategy was first applied to the synthesis of thioglycosides to take advantage of the nucleophilicity of the thiol group, and the mutated enzymes were called thioglycoligases.⁴⁶⁵ The approach was later expanded to *O*-glycoligases.⁴⁶⁶ Glycoligases differ from glycosynthases in that they produce a retaining product from an activated glycoside.

In summary, enzymatic approaches have been used widely in glycolipid synthesis, and the combination of glycosyltransferases and glycosynthases have proven to be powerful tools for the total synthesis of glycolipids. Many GSL analogues, including the ganglio-/globo-/isoglobo-/lacto-/neolacto-series have been successfully synthesized via enzymatic approaches alone, or in combination with, chemical approaches (**Figure 9 – Figure 12**). While glycosyltransferases are primarily applied in the construction of oligosaccharide fragments of glycolipids; the glycosynthase EGCCase II^{E351X} shows great promise in glycosylation of sphingosine. Additionally, glycosynthases complement glycosyltransferases by building linkages (such as the (α1-4)-fucosyl linkage) that have not yet been accomplished using glycosyltransferases.

3.3 Degradation enzymes for semisynthesis

Enzymatic degradation of GSLs (**Figure 13**) provides alternative and complimentary methods to chemical degradation strategies discussed in **Sec 2.5**.⁴⁶⁷ Often, enzymatic methods are preferred as a way to avoid harsh conditions or to provide increased specificity. Enzymes that degrade the glycan of GSLs may not be strongly influenced by the identity of the aglycone; thus, when using them to target glycolipids in crude mixtures, it is prudent to consider sources of contaminating glycans. Enzymes that degrade the lipid moiety and the carbohydrate moiety have been used as tools for the selective degradation of GSLs in analysis and semisynthesis, as detailed below.

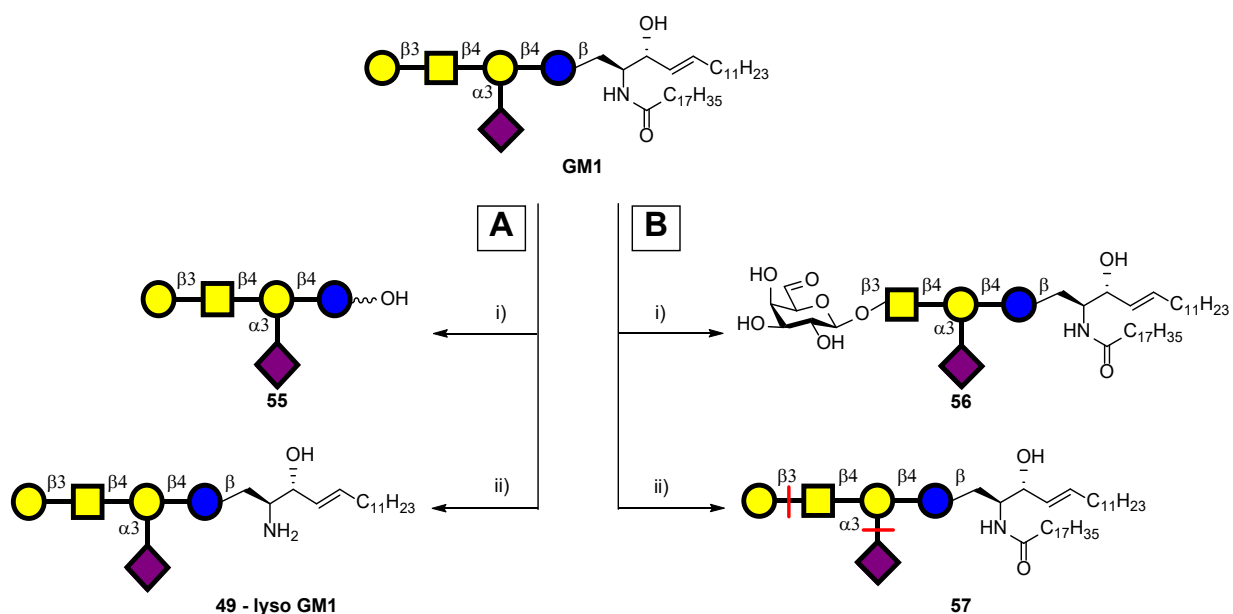

Figure 13. Common methods for the selective enzymatic degradation of glycolipids, using GM1 as an example. A) Enzymatic degradation of the lipid moiety; conditions: i) EGCCase to give the oligosaccharide **55**, ii) SCDase to provide lysoGM1 (**49**). B) Enzymatic degradation of the glycan; conditions: i) oxidation of terminal galactose residues by galactose-6-oxidase to yield aldehyde **56**, ii) hydrolysis by exoglycosidases generating hydrolyzed forms of **57**.

3.3.1 Endoglycoceramidase (EGCase)

Enzymes that hydrolyze the glycosidic bond between ceramide and the carbohydrate moiety of GSLs (**55**, **Figure 13 A.i.**) are referred to as endoglycoceramidasases or ceramide glycanases. The enzymes were first identified nearly simultaneously in *Rhodococcus*⁴⁶⁸ and a species of leech.⁴⁶⁹ For consistency, we will refer to this class of enzymes as endoglycoceramidase (EGCase) throughout the remainder of the section. Although all EGCases exhibit glycosidase activity to release the glycan from ceramide in GSLs, they may have different specificity for mono- (EC 3.2.1.45, 3.2.1.46) or oligosaccharide-containing (EC 3.2.1.123) GSLs; or may exhibit transglycosidase or reverse hydrolysis activity.³⁷³

EGCases have been found in numerous organisms,⁴⁷⁰⁻⁴⁷³ however, the EGCCase from *Rhodococcus* has been the most popular in the study of glycolipids. There have been three molecular species of the enzyme identified and cloned:⁴⁷⁴ EGCCase I,⁴⁷⁵ EGCCase II,⁴⁷⁶ and EGCCase III (also referred to as endogalactosylceramidase, EGALC);⁴⁷⁷ where the numerals indicate the order in which they elute from an anion-exchange column.⁴⁷⁴ EGCCase I has the broadest substrate scope.⁴⁷⁵ Recently, a new EGCCase I was cloned with significantly higher expression levels in *E. coli*, enhancing its utility for GSL analysis and semisynthesis.⁴⁷⁸ Crystal structures of EGCCase I⁴⁷⁸ and EGCCase II⁴⁷⁹ have enabled efforts towards the rational design of EGCases with tailored substrate specificities.⁴⁷⁸

EGCases have been used both for GSL analysis and semisynthesis. The application of EGCCase enzymes for the analysis of GSLs and their functions is reviewed elsewhere.⁴⁸⁰ EGCCase I⁴⁷⁵ and EGCCase III^{481,482} have transglycosylation activity, which has been exploited for the synthesis of glycolipid probes. EGCCase II has been converted to a glycosynthase by mutation of the catalytic nucleophile (see **Sec 3.2** for more details or **Sec 4.3.2** for applications).^{34,461} The transglycosylation capacity of EGCCase enzymes from other organisms has been explored.⁴⁸³ Notably, EGCCase from the jellyfish *Cyanea nozakii* demonstrated both transglycosylation and reverse hydrolysis activity,⁴⁸⁴ condensing Lac and Cer to form LacCer.⁴⁸⁵ The leech EGCCase was able to glycosylate acceptors with a GM1 glycan⁴⁸⁶ and recognized the GM3 glycan immobilized on polyacrylamide for the synthesis of GM3⁴⁸⁷ and lyso-GM3.⁴⁸⁸ The EGCCase enzyme from *Corynebacterium* has also demonstrated transglycosylation activity.⁴⁸⁹

3.3.2 Sphingolipid ceramide deacylase (SCDase)

Enzymes that hydrolyze the amide bond between the fatty acid and Sph of GSLs are known as sphingolipid ceramide deacylase (SCDase) enzymes (EC 3.5.1.69; **Figure 13 A.ii**).⁴⁹⁰ The products of the hydrolysis reaction are lyso-GSLs (**49**), which are often key intermediates in the

semisynthesis of labeled GSLs. Examples using lyso-GSLs as starting material for labeled glycolipids are discussed throughout **Sec 4**. The synthesis of lyso-GSLs by SCDase enzymes has been impeded by competition between hydrolysis and reverse hydrolysis activities,^{491,492} which has limited the yield of lyso-GSLs.⁴⁹³ Historically, the SCDase from *Pseudomonas sp.* has been the most widely used in semisynthesis of glycolipids.⁴⁹⁴ Competing enzyme activities have been controlled by altering reaction conditions,⁴⁹³ and an aqueous/organic biphasic system has been used to favor hydrolysis.⁴⁹⁵ Alternatively, SCDase has been used for transacylation reactions to generate GSLs containing modified fatty acids with various lengths and degrees of unsaturation,⁴⁹⁶ ω -amines,⁴⁹⁷ diazirines,⁴⁹⁸ and NBD fluorophores.⁴⁹⁹ The immobilization of SCDase has been used to facilitate product purification.⁵⁰⁰

Recently, the SCDase from *Shewanella* has gained attention for the semisynthesis of glycolipid probes. Unlike the SCDase from *Pseudomonas*,⁴⁹⁴ the SCDase from *Shewanella* could be overexpressed in *E. coli*,⁵⁰¹ making its production more practical. Further comparisons between the two enzymes indicated that the SCDase from *Shewanella* had a broader substrate specificity towards the fatty acid group, allowing for versatility in condensation reactions with modified fatty acids.⁵⁰² The enzyme accommodated 4,4-difluoro-4-bora-3a,4a-diaza-*s*-indacene (BODIPY)-labeled fatty acid in a condensation reaction for the synthesis of a ganglioside-based FRET probe (see **Sec 4.3.2**).³⁹⁴ Recent improvements to the hydrolysis conditions for glycolipids by SCDase have identified calcium chloride and taurodeoxycholate as additives which drive the hydrolysis towards lyso-glycolipid targets.⁵⁰³

3.3.3 Galactose-6-oxidase

The most popular enzyme for selective modification of the glycan of GSLs is galactose-6-oxidase (EC 1.1.3.9; Gal-6-ox), which oxidizes the C-6 hydroxy group of galactose to an aldehyde (**56**, **Figure 13 B.i**). The enzyme is not specific for glycolipids – it has also been widely used to oxidize

terminal galactose residues on glycoproteins^{504,505} and free sugars.⁵⁰⁶ Gal-6-ox was isolated from what was thought to be *Polyporus circinatus* in 1961.^{506,507} (The fungus was misidentified⁵⁰⁸ and has since been identified as *Fusarium graminearum*.)⁵⁰⁹ Soon after, Gal-6-ox was applied to the oxidation of galactoside glycolipids.⁵¹⁰ The mechanism of Gal-6-ox action has been reviewed.⁵¹¹ Historically, the most common application of Gal-6-ox in the synthesis of glycolipid probes was the selective radiolabeling of galactose through reduction of the aldehyde product with NaB³H₄.^{512,513} More recently it has become popular for conjugation of fluorophores through oxime ligation (see **Sec 4.4.1**).

The substrate specificity of Gal-6-ox has been studied extensively. While GalNAc was cleaved with comparable efficiency to unmodified Gal,⁵⁰⁷ other Gal modifications were not accommodated by the enzyme.^{514,515} Gal-6-ox is specific for terminal Gal residues,^{504,516} for instance, gangliosides GM1 and GM2 were substrates for Gal-6-ox, while GD1a was not.^{517,518} Efforts to expand the substrate scope of Gal-6-ox through mutagenesis have made modest progress.^{519,520}

3.3.4 Exoglycosidases

A less common strategy to generate modified glycolipids is through the degradation of GSL to less complex glycolipids using exoglycosidases (**57, Figure 13 B.ii**.) The exoglycosidases pertinent to the degradation of many vertebrate glycolipids are exo- β -galactosidases, β -*N*-acetylhexosaminidases, and neuraminidases (NEU, also called sialidases), which cleave non-reducing end Gal, GalNAc or GlcNAc, and Neu5Ac residues, respectively.⁵²¹ Exoglycosidases typically have strict substrate specificities towards the monosaccharide that they hydrolyze; the remainder of the glycan chain or aglycone is often more relaxed but still requires scrutiny. Consider the NEU enzymes as an example: NEU from *A. urafaciens* was approximately 100-fold more efficient at cleaving ganglioside GM1 than NEU from *C. perfringens*.⁵²² Furthermore, of the four

human NEU isoenzymes, NEU3 was reported to primarily cleave glycolipid substrates,^{210,401,523} whereas NEU1 did not act on glycolipid substrates.⁵²³

Exoglycosidases have been employed to generate target glycolipids which are naturally present in low abundance. A crude mixture of polysialogangliosides was extracted from rat brains and degraded to GM1 using NEU from *V. cholera*, followed by β -galactosidase to degrade GM1 to GM2.⁵²⁴⁻⁵²⁶ NEU from *C. perfringens* has been used to convert a crude polysialoganglioside mixture to GM1; however, under certain conditions it was able to degrade GM1 to GA1.⁵⁸ Using a similar strategy, GD1b was degraded to GD2⁵²⁷ and GM2.⁵²⁸ GM3 could be generated from GM2 with a β -*N*-acetylhexosaminidase.⁵²⁹ Exoglycosidase degradation strategies have been combined with metabolic radiolabeling (see **Sec 4.1.1**) to obtain radiolabeled gangliosides.^{524,525}

Table 4. Enzyme abbreviations

<i>Subclass</i>	<i>CAZy</i>	<i>Abbreviation</i>	<i>Full Name</i>
GlcNAcT	GT8	HpLgtA	<i>Helicobacter pylori</i> β 1,3-N-acetylglucosaminyltransferase ⁶⁵
	GT2	NmLgtA	<i>Neisseria meningitidis</i> β 1,3-N-acetylglucosaminyltransferase ⁷⁸
GalT	GT6	Bovine α 1,3GalT	Recombinant bovine α 1,3-galactosyltransferase ^{63,530}
	GT2	CjCgtB	<i>Campylobacter jejuni</i> β 1,3-galactosyltransferase ⁶³
	GT 2	Ecwgbo	<i>Escherichia coli</i> O55:H7 β 1,3-galactosyltransferase ⁷⁷
	GT25	Hp1-4GalT	<i>Helicobacter pylori</i> β 1,4-galactosyltransferase ^{79,531,532}
	GT6	Human GTB	Human blood group B glycosyltransferase (GTB) ^{89,533}
	GT25	NmLgtB	<i>Neisseria meningitidis</i> β 1,4-galactosyltransferase ^{63,65,78}
	GT8	NmLgtC	<i>Neisseria meningitidis</i> α 1,4-galactosyltransferase ⁶³⁻⁶⁵
GalNAcT	GT82	CjCgtA	<i>Campylobacter jejuni</i> β 1,4-N-acetylgalactosaminyltransferases ⁶³
	GT2	HiLgtD	<i>Haemophilus influenza</i> β 1,3-N-acetylgalactosaminyltransferase ^{63,64}
	GT6	HmBgtA	<i>Helicobacter mustelae</i> α 1,3-N-acetylgalactosaminyltransferase ^{33,90,534}
SiaT	GT42	CjCstI	<i>Campylobacter jejuni</i> α 2,3-sialyltransferase ^{75,79,394,403}
	GT42	CjCstII	<i>Campylobacter jejuni</i> α 2,3/8-sialyltransferase ^{63,395,396}
	GT42	CjCstII Δ 32 ^{I53S}	A mutant of CjCstII ³⁹⁷
	GT80	JT-FAJ-16	Marine α 2,3-sialyltransferase ⁶⁴
	GT80	PMST1 ^{M144D}	<i>Pasteurella multocida</i> α 2,3-sialyltransferase 1 M144D mutant ^{33,63}
	GT52	PMST2	<i>Pasteurella multocida</i> α 2,3-sialyltransferase 2 ³⁹⁰
	GT42	PMST3	<i>Pasteurella multocida</i> α 2,3-sialyltransferase 3 ^{391,398}
	GT80	Pd2,6ST	<i>Photobacterium damsela</i> α 2,6-sialyltransferase ^{405,409,411}
FucT	GT29	ST3GalI	Mammalian α 2,3-sialyltransferase ⁴⁰⁴
	GT11	Ecwbgl	<i>Escherichia coli</i> O126 α 1,2-fucosyltransferase ^{89,90}
	GT11	HpFutC	<i>Helicobacter pylori</i> α 1,2-fucosyltransferase ^{64,89}
	GT10	Hp1-3FT	<i>Helicobacter pylori</i> α 1,3-fucosyltransferase ^{63,82}
	GT10	Human α 1-3FucT	Human milk α 1,3-fucosyltransferase ⁸⁸

<i>Subclass</i>	<i>CAZy</i>	<i>Abbreviation</i>	<i>Full Name</i>
Glycosidase	GH1	Abg	<i>Agrobacterium sp.</i> β -glucosidase ⁴⁵⁰
	GH29	BbAfcB ^{D703S}	Glycosynthase derived from (α 1-3)-(α 1-4)-L-fucosidase of <i>Bifidobacterium bifidum</i> ⁸¹
	GH35	BgaC ^{E233G}	Galactosynthase from <i>B. circulans</i> ^{458,459}
	GH5	EGALC	Endogalactosylceramidase (another name for EGCCaseIII) ⁴⁷⁷
	GH5	EGCase	Endoglycoceramidase ⁴⁶⁸ /ceramide glycanase ⁴⁶⁹
	GH5	EGCase II ^{E351X}	Glycosynthases derived from endoglycoceramidase II (EGCase II) from <i>Rhodococcus</i> strain M-777 ^{34,79,461}
	GH1	TtbGly	B-galactosidase from <i>T. thermophilus</i> ⁴⁵⁷
	GH33	NEU	Neuraminidase/sialidase ^{401,523}
Sugar Donor Synthesizing Enzymes		EcGalE	<i>Escherichia coli</i> UDP-galactose-4-epimerase ⁷⁸
		EcGalK	<i>Escherichia coli</i> K-12 galactose kinase ^{63-65,89,535,536}
		AGX1	Human UDP-GalNAc pyrophosphorylase ³³
		AtUSP	<i>Arabidopsis thaliana</i> UDP-sugar pyrophosphorylase ⁶⁴
		BiNahK	<i>Bifidobacterium infantis</i> N-acetylhexosamine-1-kinase ^{33,64}
		BiNahK	<i>Bifidobacterium longum</i> N-acetylhexosamine-1-kinase ^{63,89}
		BLUSP	<i>Bifidobacterium longum</i> UDP-sugar pyrophosphorylase ^{63,65,89}
		BfFKP	Bifunctional enzyme from <i>Bacteroides fragilis</i> that has both L-fucokinase and GDP-fucose pyrophosphorylase activities ^{33,63,64,82,89}
		EcGlmU	<i>Escherichia coli</i> N-acetylglucosamine 1-phosphate uridylyltransferase ^{64,65,89}
		Gal-6-ox	Galactose-6-oxidase ⁵⁰⁶⁻⁵⁰⁹
	PmCSS	<i>Pasteurella multocida</i> CMP-sialic acid synthetase ^{64,398}	
	PmGlmU	<i>Pasteurella multocida</i> N-acetylglucosamine 1-phosphate uridylyltransferase ⁶³	
Other		CMAH	Cytidine monophosphate <i>N</i> -acetylneuraminic acid hydroxylase ⁵³
		Gal-6-ox	Galactose-6-oxidase ⁵⁰⁶⁻⁵⁰⁹
		SCDase	Sphingolipid ceramide deacylase ^{490,494,501}

4 Labelled glycolipid analogs

Labeled GSL analogues are important probes to investigate the location, fate, and function of glycolipids in biological systems. These compounds have been developed for in vitro enzyme assays, labeling in cells, and investigating the fate of glycolipids in live animals.^{369,537-541} Early elucidation of GSL biosynthesis and metabolic fate relied heavily on the use of radionuclide glycolipid probes. Glycolipid probes have also been crucial for detecting glycolipid partitioning both *within* and *across* membranes or into specific cellular compartments. In this section, we will discuss the synthesis and applications of labeled GSLs used as biological probes.

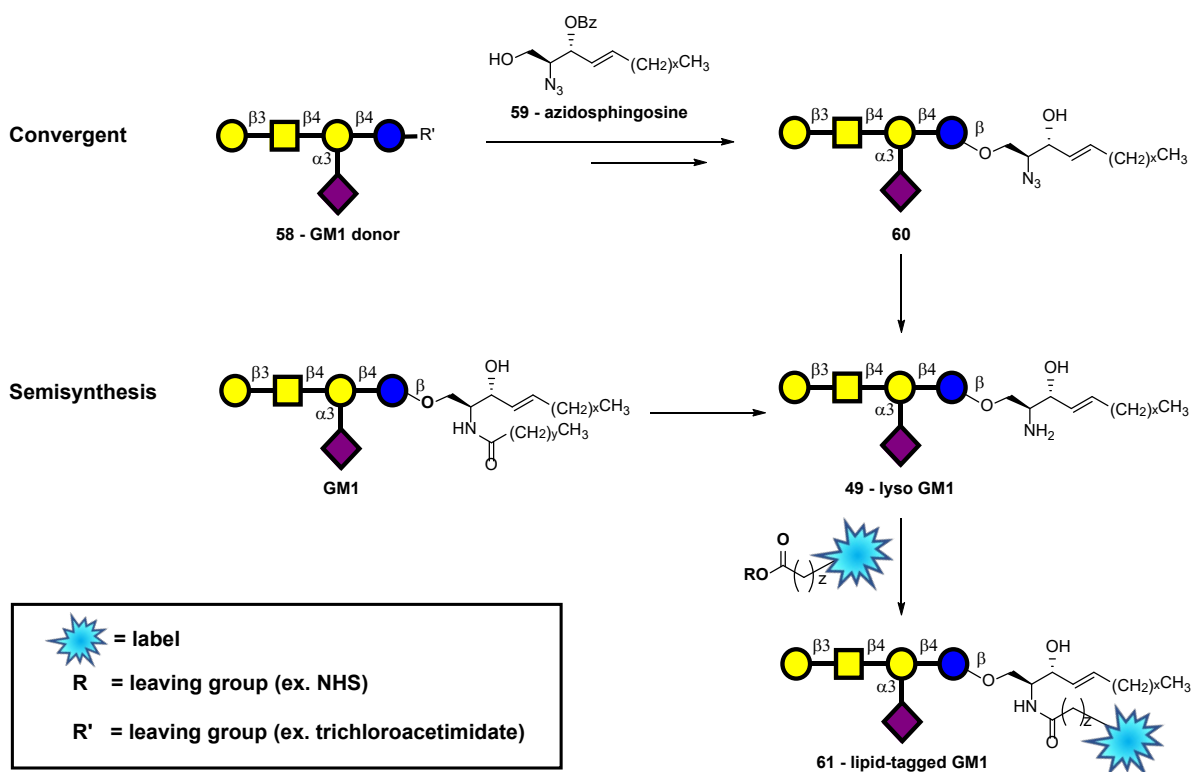

Figure 14. General routes towards glycolipids tagged at the lipid moiety, using GM1 as an example. Lipid chain lengths may vary, and are denoted by x, y, and z subscripts, referring to the sphingosine and fatty acid chains, respectively.

The synthesis of labeled glycolipids is generally accomplished through one of three primary strategies: semisynthesis, convergent synthesis, or metabolic labeling. The basis of most semisynthetic strategies is discussed in **Secs 2.5** and **3.3**. The choice of strategy will often depend on the intended label and the required location within the GSL itself. Labels can be incorporated into in the glycan or lipid moieties, or both. Modifications to the lipid are most often accomplished through the introduction of a modified fatty acid through either a semisynthetic or convergent synthesis (**Figure 14**). In semisynthetic routes, *N*-deacylation of the sphingolipid yields the corresponding lyso-derivative **49**. Re-acylation with a modified fatty acid is typically done through an activated ester or mixed anhydride. Convergent syntheses usually start from *D-erythro*-sphingosine and are most practical for glycolipids with small glycans.

Carbohydrate labels are typically introduced at sites where selective chemical reactivity can be easily achieved (**Figure 15**). Semisynthetic approaches targeting the glycan are almost exclusively applied to glycolipids with *N*-acyl-containing carbohydrates, such as amido sugars or sialic acid, where the revealed amino group can be used as a chemical handle (e.g. **53**). Alternative semisynthetic strategies take advantage of selective oxidation strategies that may target individual terminal residues, such as galactose or sialic acid (e.g. **54** or **56**). Convergent synthetic approaches may also exploit either an *N*-acyl group or the reactivity of the primary alcohol at *C*-6 of hexoses or *C*-9 of Sia.

Metabolic labeling is an alternative to convergent and semisynthetic methods that exploits cellular machinery to develop synthetic targets. A modified precursor (e.g. a monosaccharide, sphingosine, or fatty acid) is provided to cells or whole organisms, where it is taken up into the biosynthetic pathway and incorporated into the glycolipid. This method has been termed “Metabolic Oligosaccharide Engineering” or “Metabolic Glycoengineering” when applied to labeling of glycans, and is used extensively to study the composition of glycans in organisms or to probe the effects of carbohydrate modifications in living systems.⁵⁴²⁻⁵⁴⁷ Potential applications for

this technology also include cancer immunotherapy by generating highly immunogenic gangliosides from modified ManNAc precursors.^{548,549}

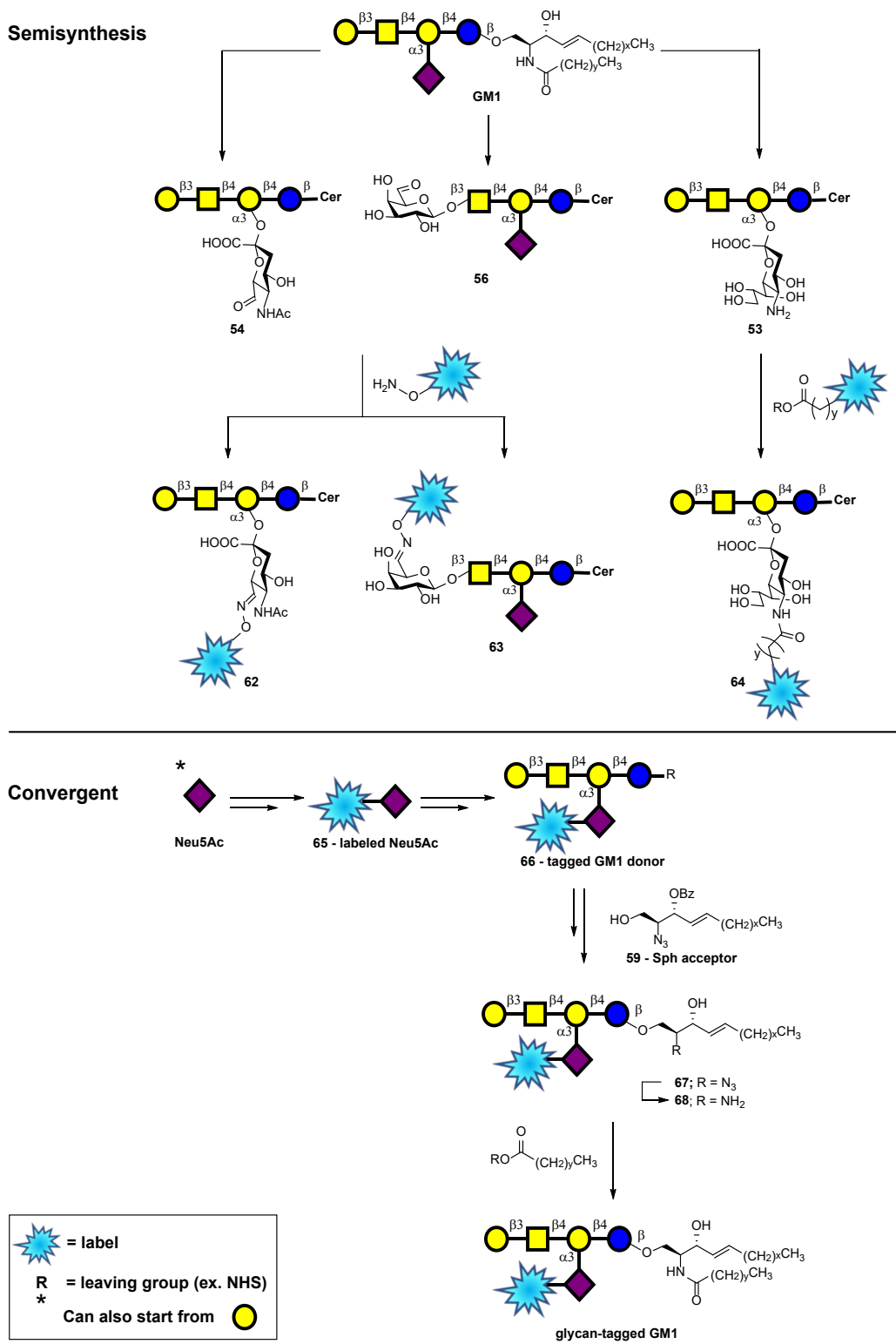

Figure 15: General routes towards glycolipids tagged at the glycan moiety, using GM1 as an example. For clarity, the convergent synthesis only shows an example with Sia labeling; however, labeling the terminal Gal residue is also common.

In this section, we will discuss different approaches to generate labelled GSLs for use as probes in chemical biology. We note that some of the strategies used for GSL have built on methods for labeling of phospholipids or sphingolipids, which are reviewed elsewhere.⁵⁵⁰⁻⁵⁵² However, the unique requirements of the glycan present additional challenges for the design of GSL probes. As above, we will restrict the discussion to vertebrate GSLs or those that interact specifically with vertebrate systems (e.g. α -GalCer). Some strategies which may be relevant for GSL probes have been applied to the construction of probes based on GPI-anchors.⁵⁵³⁻⁵⁵⁷ Our focus will be on how synthetic, semisynthetic, and metabolic labeling methods were used to generate GSL probes with labels in the glycan or the lipid moiety. We have placed more emphasis on publications from the year 2000 onward.

4.1 Radiolabelled glycolipids

Perhaps the most established method of generating labelled glycolipid analogues is through radiolabelling. The development of fluorescent probes and the cost associated with radionuclide use has led to a shift away from radiolabeling in more recent years. Methods that employ radiolabeled substrates may also be incompatible with real-time analyses, be labor intensive, or require specialized equipment. However, radiolabeling produces a probe with minimal structural difference to the native substrate and can provide for sensitive detection. As such, radiolabeled glycolipids maintain their relevance as important probes in modern glycolipid research.

4.1.1 Metabolic radiolabelling

Radiolabelling was the earliest method applied to metabolically labelled glycolipids⁵⁵⁸⁻⁵⁶⁰ and has been reviewed by Diaz and Varki.⁵⁶¹ Studies employing radioactive serine, Sph, palmitic acid, and Gal have been key to the elucidation of GSL biosynthesis.⁵³⁸ Radiolabelling has been used extensively to study ganglioside composition and perturbations to glycolipid and ganglioside

biosynthetic pathways. To this end, ^3H or ^{14}C labeled glucosamine and Gal,⁵⁶²⁻⁵⁷⁴ mannosamine,⁵⁷⁵ serine,⁵⁷⁶⁻⁵⁷⁸ or Sph^{105,567,579-586} were provided to cells, and their incorporation into glycolipids was tracked. GPI has been metabolically labeled with ^3H mannose,⁵⁸⁷⁻⁵⁸⁹ ^3H glucosamine,⁵⁹⁰ ^3H inositol,⁵⁹⁰⁻⁵⁹² and ^3H myristate.⁵⁹³ Radiolabeled monosaccharides such as Glc or Gal are also used in enzyme activity assays.^{594,595} Although the biosynthetic generation of radiolabeled glycolipids is still commonly used for many purposes, this approach generates mixtures of radiolabeled glycolipids from which the glycolipid of interest must be separated and may have low specific radioactivity.⁵⁹⁶ Efforts towards methods that generate homogeneous radiolabelled GSLs with high specific radioactivity are discussed below.

4.1.2 Semisynthetic radiolabeling approaches

Semisynthetic methods to introduce labels into gangliosides have been reviewed extensively.⁵⁹⁶⁻⁵⁹⁸ There are three general semisynthetic approaches used to generate homogeneous radiolabeled glycosphingolipids. Oxidation and reduction with a ^3H source (NaB^3H_4) at the C-6 of Gal or C-3 of Sph is commonly used. Reduction of alkenes with NaB^3H_4 allows for selective labeling of Sph, but destroys the alkene functionality. Deacetylation and re-acetylation of the *N*-acetyl group of Neu5Ac or the fatty acid chain, or both, with ^3H or ^{14}C labeled groups employs the harshest conditions of the three methods.^{596,597}

The methods developed from the 1960s to the 1990s for the selective radiolabeling of gangliosides are still used routinely.⁵⁹⁷ Recently, oxidation of the C-3 position of Sph was used to generate an ^3H labelled GM3,⁵⁹⁹ GD1a,⁶⁰⁰⁻⁶⁰⁴ and GM1.⁶⁰⁵ The Neu5Ac moieties of GD3 were deacetylated and re-acetylated with $^2\text{H}_6$ -acetic anhydride before feeding to rats and detection of labeled GD3 in plasma using LC-MS.⁶⁰⁶ Radiolabelled Sph has been used to perform imaging by electron microscopy.⁶⁰⁷ Radiolabeling has also been used in combination with other labeling strategies to obtain corroborative data sets. Fluorescent and radiolabeled GM1 was generated with

modifications to the oxidation/reduction approach. From GM1, the C-6 hydroxyl of the terminal Gal was oxidized and conjugated to AlexaFluor hydrazide.⁶⁰⁸ The resulting hydrazone was reduced with NaB³H₄, and the probe was used to compare the results of microscopic and biochemical techniques. Finally, labeling of GSL with mass tags has emerged as a method for imaging by mass spectrometry.^{368,609}

4.2 Fluorescent glycolipids

Fluorescent labeling produces sensitive probes that are compatible with real-time monitoring at high resolution. However, the fluorochrome itself is often large and may perturb the very properties of the lipid being investigated, resulting in an undesired influence on biological function.^{142,610} As a result, there has been significant effort towards probes whose overall features resemble that of natural lipids.^{611,612} In systems where the biological properties under investigation relate primarily to the glycan, one may choose to label the fatty acid of the GSL.⁶¹³ However, there is growing recognition of the role of lipid-lipid interactions,^{173,614} and studies of fluorescent lipids have provided a strong counterargument for preserving the integrity of the lipid chain by labeling the carbohydrate moiety.^{614,615} Thoughtful selection of fluorophore location and identity can produce probes with partitioning properties analogous to native lipids.⁶¹⁶

Fluorophores commonly used for labeling glycolipids include NBD, BODIPY, and tetramethylrhodium (TMR). The respective properties, advantages, and disadvantages of these fluorochromes are detailed elsewhere.⁶¹⁷ Polyene chromophores have been used for phospho- and sphingo-lipids^{618,619} and in at least one example have been applied to GSL, such as Gb3.⁶²⁰ Historically, the most common fluorophore used for lipids was NBD because of its small size and increased fluorescence intensity within a non-polar environment.⁶²¹ However, due to its polarity, NBD has been shown to act as a poor mimic of an acyl chain for interactions with natural lipid analogues within the membrane.^{622,623} Cholesterol labeled with NBD did not mimic native

cholesterol activity, and the NBD label was sequestered near the lipid-water interface.⁶²⁴ BODIPY has emerged as the most popular fluorophore for glycolipid labeling because it is neutral, nonpolar, and photostable; it also has a higher fluorescence yield compared to NBD. In addition, its interactions within a membrane environment are more comparable to non-polar acyl chains as determined through excimer formation.⁶²⁵ The popularity of fluorescence as an analytical and imaging tool has led to the commercial availability of a variety of simple fluorescent glycolipids including cerebroside, sphingolipids, and (to a lesser extent) gangliosides.

4.2.1 Lipid labelling

Examples of metabolic glycolipid labeling with fluorophores are limited. Fluorophores are more likely to perturb the natural activity or biosynthesis of glycolipids compared to radiolabels (see **Sec 4.1.1**) or bioorthogonal labels (see **Sec 4.4.1**). In all instances, the Sph or Cer was first fluorescently labeled and introduced to cells. Metabolic conversion of fluorescently labeled Cer to cerebroside has been observed.⁶²⁶⁻⁶²⁸ Metabolic labeling with fluorescent Sph (generated through a cross metathesis reaction between Garner's aldehyde **5** and an alkene labeled with an ω -BODIPY group) enabled the study of both acylated and non-acylated sphingolipids.^{629,630}

Semisynthetic methods employing lysoglycolipids have long been used to generate glycolipids containing NBD and pyrene fluorophores. Fluorescent fatty acids have been coupled to deacylated glycosphingolipids.⁶³¹⁻⁶³⁶ Six-carbon chain NBD fatty acids are known but do not mimic the phase properties of native fatty acids incorporated into Sph mixtures.⁶³⁷ Semisynthetic methods using NHS coupling have been employed to make a variety of BODIPY-labeled⁶³⁸⁻⁶⁴¹ and TMR-labeled glycolipids.⁶⁴²⁻⁶⁴⁴ As an alternative to NHS activation, BODIPY-labeled fatty acids have been activated with benzotriazole-1-yloxy-tris(dimethylamino)phosphonium (BOP)⁶⁴⁵ or as mixed anhydrides.⁶⁴⁶

Complex gangliosides with fluorescent labels in the acyl chain have been prepared by first modifying the amine of lyso-LacCer or GM1 with a BODIPY or TMR fatty acid through NHS activation; followed by sialyltransferase, sialidase, or galactosidase reactions to generate the desired glycan.^{640,642,643,647-650} These probes have been applied in metabolic cytometry experiments.^{650,651} A convergent approach employing both synthetic and chemoenzymatic methods generated TMR-labeled gangliosides with a thioglycosidic linkage between galactose and glucose. Sph was glycosylated with a thiolactoside, after which the amine was acylated with a TMR label. The resulting labeled thiolactosylsphingolipid was further modified using glycosyltransferases.⁶⁵²

The unnatural glycosphingolipid, BODIPY-maltosylceramide, was generated through a convergent approach. Azido-benzylsphingosine was glycosylated with per-*O*-acetylmaltosyl trichloroacetimidate. After deprotection, the azide was reduced, and the BODIPY-labelled fatty acid was incorporated through NHS activation.⁶³⁹ A similar synthetic approach enabled the synthesis LacCer with unnatural stereochemistry to study the role of stereochemistry at *C*-2 and *C*-3 of Sph.^{653,654} This strategy has also been used for the synthesis of more complex labeled GSLs such as sLe^x.^{655,656} A convergent method generated ω -amino- α -GalCer. Sph was acylated with a protected ω -amino fatty acid. After glycosylation and deprotection, the terminal amine on the fatty acid was coupled to a BODIPY^{247,657} or Cy-3⁶⁵⁸ fluorophore. Starting from lyso-GM1, fatty acids with α - or ω -amines were incorporated and then labeled with a variety of fluorophores through NHS activation.³⁶⁰ This method is likely to be compatible with other ganglioside targets. A modification of this approach placed an azido group at the α -methylene position on the fatty acid chain of α -GalCer, which allowed for the incorporation of a fluorophore alkyne using copper-catalyzed click chemistry.⁶⁵⁹

4.2.2 Glycan labeling

Fluorescent glycolipids tagged through the carbohydrate moiety may be more likely to preserve partitioning of the glycolipids into raft-like domains. Fluorescent labeling at C-6 of the Gal residue has been used as an alternative to lipid labeling to study the role of α -GalCer in activation of natural killer T cells. In the first synthetic strategy, α -GalCer was converted to a 6-amino-6-deoxy-galactosyl analogue for conjugation to a dansyl fluorophore.⁶⁶⁰ Sulfatide was prepared with a similar approach.⁶⁶¹ This strategy gave poor yields because glycosylceramides are generally insoluble.⁶⁶⁰ An amended strategy achieved improved yields by labeling Gal with a dansyl group prior to glycosylation.⁶⁶²

Gangliosides can be modified at various positions on the sialic acid moiety or at C-6 of a Gal residue. GM1 was labeled at the glycerol chain of Neu5Ac through a semisynthetic method employing sodium periodate to generate an aldehyde at C-7, which was subsequently conjugated to AlexaFluor hydrazide.¹⁶¹ A more recent study generated fluorescently labelled gangliosides GM1, GM2, GM3, and GD1b (**69–71, Figure 16**) through a convergent synthetic route using the GlcCer cassette strategy⁶⁶³ (see **Sec 2.3**). The general method involved synthesis of the modified carbohydrate moiety with a protected amine at either C-6 of Gal or C-9 of Neu5Ac, followed by glycosylation of GlcCer, global deprotection, and coupling of the free amine (at C-6 of Gal or C-9 of Neu5Ac) onto a hydrophilic fluorophore through NHS activation. Many of the fluorescent ganglioside analogues exhibited lipid raft-partitioning behavior similar to that of the natural lipid.⁶⁶³ A comprehensive discussion of the precedent for the synthesis of these glycan-labelled fluorescent gangliosides has recently been detailed⁶¹⁵ and reviewed.³⁸

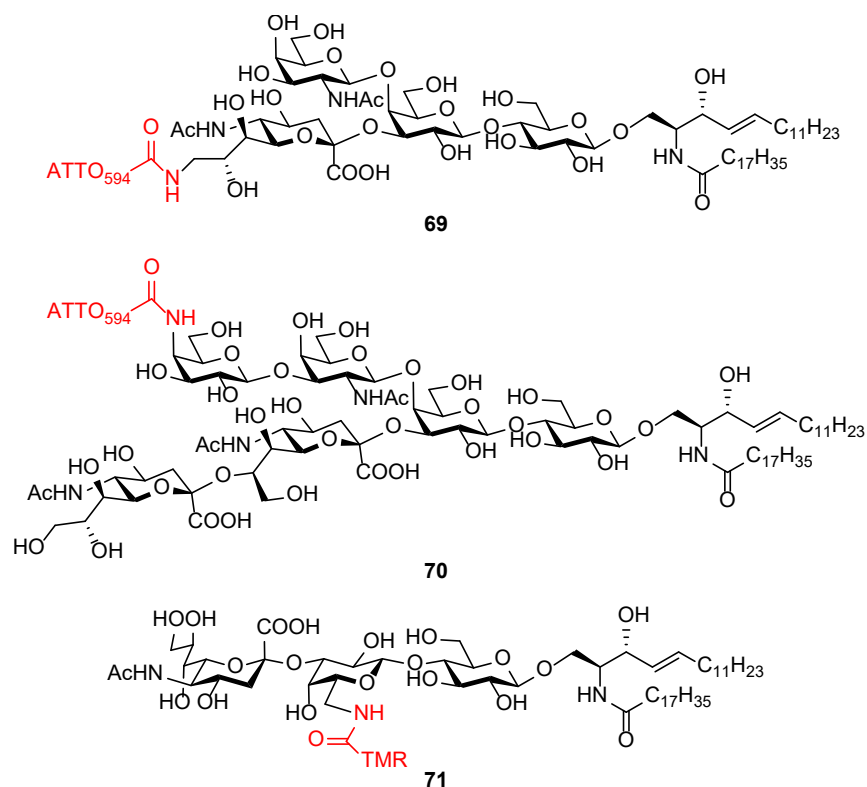

Figure 16: Select fluorescent gangliosides with fluorescent labels in the glycan, made with a convergent approach.⁶⁶³

The fluorescent labels were incorporated in the final step through amine coupling at C-9 of Neu5Ac (**69**), C-6 of a terminal Gal residue (**70**), or C-6 of an internal Gal residue (**71**).

Less conventional methods have been used to generate fluorescently labeled unnatural glycolipids. A pyrene group was used to label *N*-(9-*cis*-octadecenoyl)- β -D-glucosamine through a dehydration reaction between the sugar hydroxyl groups and 1-pyreneboronic acid.⁶⁶⁴ A synthetic glycolipid was formed from a trisaccharide containing a bioorthogonal tag, which was designed as a multifunctional spacer. The trisaccharide crosslinked a cholesterol moiety at its reducing end to a dansyl group at C-4 of the non-reducing end glucose and was used to investigate lipid raft domains.⁶⁶⁵

4.3 FRET-based glycolipid probes

Fluorescent glycolipids can be used in Förster resonance energy transfer (FRET) experiments, which may provide improved sensitivity or be used to monitor chemical reactions and molecular associations. FRET is a non-radiative energy transfer between donor and acceptor chromophores. Intermolecular glycolipid-based FRET systems have been used extensively to measure intermolecular distances, and therefore molecular interactions within membranes,⁶⁶⁶ while intramolecular glycolipid-based FRET systems have been used for monitoring enzymatic processing of glycolipids.

4.3.1 Intermolecular FRET assays

One of the earliest glycolipid-based FRET systems used 3-(*p*-(6-phenyl)-1,3,5-hexatrienyl)phenylpropionic acid (DPH propinoic acid) as the FRET donor, and NBD-aminohexanoic acid as the FRET acceptor to study glycolipid distribution in a membrane. The fluorophores were incorporated into the fatty acid tail using semisynthetic methods. Lyso lipids of GM1, GalCer, sulfatide, and Gal were re-acylated with DPH propinoic acid or NBD-aminohexanoic acid after NHS activation.⁶⁶⁷ Another early glycolipid-based FRET system used anthrylvinyl (AV) as the FRET donor- and perylenoyl as the FRET acceptor. These probes were introduced as lipid-specific probes in 1985 by Bergelson et al.⁶¹¹ The semisynthetic labeling strategy employing NHS activation of fluorescent fatty acids was later expanded to galactocerebrosides and a variety of gangliosides.⁶¹³ AV-labeled GalCer (AV-GalCer) and perylenoyl-triglyceride probes were used in a FRET assay to monitor the activity of the glycolipid transfer protein. Both probes were inserted into a donor vesicle, and the glycolipid transfer protein transferred AV-GalCer from the donor vesicle to an empty acceptor vesicle which led to an increase in anthrylvinyl emission and a decrease in perylenoyl emission.⁶⁶⁸ This FRET system is still popular for studying glycolipid transfer proteins and glycolipid mixing in membranes.^{513,669-}

⁶⁷³ A 3,3'-dihexadecyloxycarbocyanine perchlorate (Dio-C₁₆) acceptor has been used in place of the perylenoyl group acceptor.⁶⁷⁴⁻⁶⁷⁷ Recently, the assay has been implemented with BODIPY-GalCer in place of AV-GalCer⁶⁷⁸ and adapted to a microfluidics platform.⁶⁷⁹

A similar FRET assay was developed to monitor GM2-activator protein (GM2-AP) activity. GM1 and GM2, both with NBD-labelled acyl chains, were incorporated into donor vesicles containing another lipid to act as a FRET acceptor (rhodamine-dioleoyl phosphoglycerol ethanolamine). The transfer of the labeled gangliosides by GM2-AP from the donor vesicle to an empty acceptor vesicle was detected as an increase in NBD fluorescence emission. The NBD labels were incorporated into the α -methylene position of the fatty acid tail (**74**, **Scheme 6**) by acylation of lyso-GM1 **49** or lyso-GM2 **72** with 2-azido-octadecanoic acid, reduction of the azide, and treatment with NBD-fluoride. Reduction of the azide with H₂S left the double bond of the sphingosine intact.⁶⁸⁰

FRET has also been used to detect the binding of proteins specific for GSL. The fatty acid of GM1 was labelled with one of two BODIPY fluorophores (a FRET donor or a FRET acceptor) using a semisynthetic strategy. In the absence of cholera toxin, labeled GM1 was dispersed homogeneously in a phospholipid bilayer. Upon addition of cholera toxin, the FRET donor- and acceptor-labelled GM1 were brought into proximity, causing an increase in the FRET signal which could be observed at the membrane,^{681,682} or using a flow cytometry assay.⁶⁸³ A modification of this assay has used pyrene-labelled phospholipids as the FRET donor within a phospholipid bilayer. An application of GM1 labelled with BODIPY or 4-((4-(dimethylamino)phenyl)azo)benzoic acid (DABCY) as the FRET acceptor was used to detect GM1 clustering upon addition of cholera toxin based on self-quenching.⁶⁸⁴ More recently, GM1 labeled with BODIPY was mixed with vesicles made up of polymerized 10,12-pentacosadiynoic acid (PDA). Insertion of the probe into the lipid vesicle caused fluorescence quenching, but in the

presence of cholera toxin, the ganglioside was blocked from inserting into the vesicle, increasing the fluorescence signal.⁶⁸⁵

Scheme 6. Synthesis of NBD-GM1 and NBD-GM2 FRET donors to probe GM2-AP activity by Schwarzmann et al., 2005.⁶⁸⁰

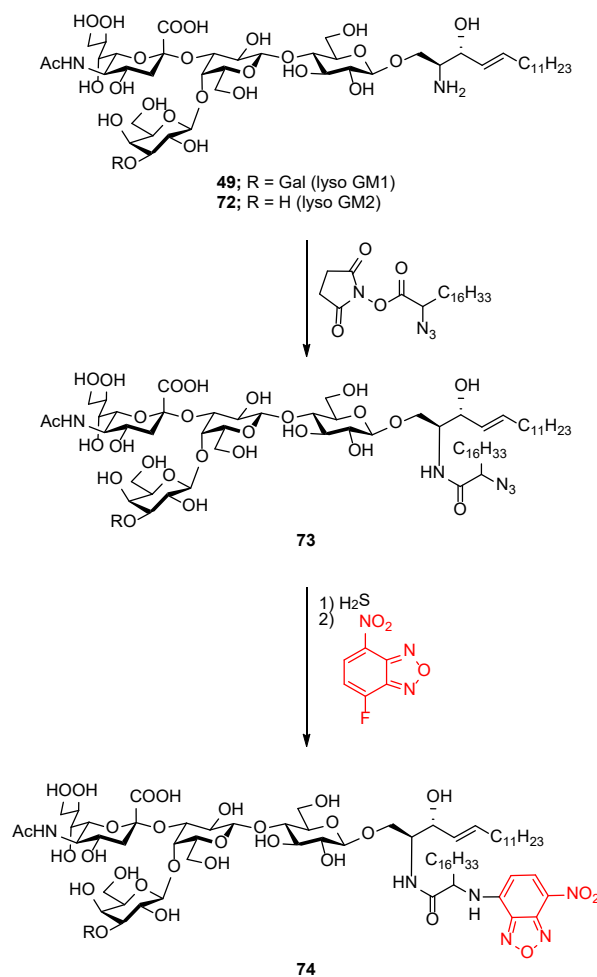

BODIPY-labelled GSLs, prepared using semisynthetic strategies, have also been used to study lipid aggregation. Lyso-sulfatide was re-acylated with BODIPY-pentanoic acid after NHS activation.⁶⁸⁶ Gangliosides GM1 and GD1a were de-acetylated at *N*-5 of Neu5Ac and re-acetylated with a mixed anhydride of BODIPY-pentanoic acid. Notably, GD1a, a disialo-ganglioside, was labelled with two BODIPY groups. Using these probes, evidence of BODIPY dimers and monomer-to-dimer resonance energy transitions were detected.^{646,686} The same synthetic

methodology was used to generate two different BODIPY-labelled GM1 probes as a FRET pair that was used to study the intrinsic self-aggregation properties of GM1.^{687,688}

4.3.2 *Intramolecular FRET assays*

An intramolecular FRET assay has been used to detect SiaT activity. Neu5Ac was labeled with a naphthalene group at C-9 and was used to synthesize the modified CMP-Neu5Ac. Lac was labeled with a dansyl group through a propylamine linker on its aglycone. Sialyltransferase activity brought the two fluorophores into proximity, as detected by FRET.⁶⁸⁹ The assay was also adapted to monitor FucT activity.⁶⁹⁰

Despite the precedent of using FRET to study many lipid-modifying enzymes,^{550,691} intramolecular FRET assays have only recently been implemented to study glycolipid catabolism, most likely due to the synthetic challenges presented by such targets. Intramolecular FRET assays based on lipid probes have been used to study enzyme activity at the membrane including phospholipases^{692,693} and ceramidases.⁶⁹⁴ Ganglioside degradation has been studied with GM3 FRET probe **75** (**Figure 17**), made through a chemoenzymatic approach in which a novel EGCCase II glycosynthase was used for glycosylation. The FRET donor was a coumarin group at C-9 of Neu5Ac, while a BODIPY acceptor was incorporated into the fatty acid.³⁹⁴ The probe was able to insert into cellular membranes and was used to detect SCDase, EGCCase, and NEU activity.

Glucocerebrosidase activity in live mammalian cells has been detected with FRET probe **76**. The key intermediate in the synthesis was a bifunctionalized Glc with a pendant alkyne at C-6 and an aminoalkyl aglycone. From that intermediate, only four synthetic steps were required to obtain the final probe containing BODIPY 576/589 at C-6 of Glc and the FRET acceptor (Black Hole Quencher 2) in the aglycone.^{695,696} The same group also developed a quenched bis-acetal-based substrate (BABS) probe **77** to monitor exo-glycosidase activity. The BABS tethered the fluorophore and the FRET acceptor/quencher close together; however, upon cleavage of the

glycosidic bond, the hemiacetal spontaneously broke down, freeing the fluorophore from the quencher. Although this probe was used to monitor O-GlcNAcase activity (an enzyme that releases GlcNAc from serine and threonine), the study demonstrated that BABS-based quenched FRET probes can be used to monitor glycosidase activity.⁶⁹⁷

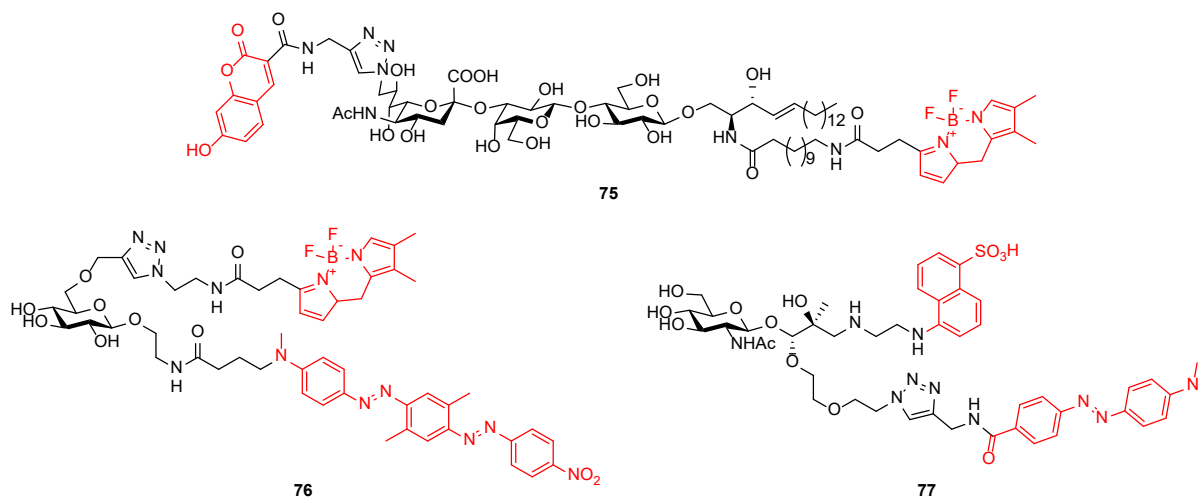

Figure 17. Structure of intramolecular FRET probes to study ganglioside-degrading enzymes (75), glucocerebrosidase (76), and exo-glycosidase enzymes(77).

4.4 Bioorthogonal-tagged glycolipids

Biomolecular probes containing functional groups which undergo selective reactions, or bioorthogonal groups, have become popular tools for elucidating cellular function of specific biomolecules. The specific chemistry of bioorthogonal functional groups should minimize non-specific labeling to allow for detection in a complex cellular environment. In the context of carbohydrate probes, the most popular chemistries are azide-alkyne cycloaddition⁶⁹⁸ and the Staudinger ligation.^{699,700} Bioorthogonal chemical reactivity has been reviewed extensively elsewhere.⁷⁰¹⁻⁷⁰⁵

4.4.1 Tagging the glycan

Metabolic labeling with bioorthogonal probes offers a solution to some of the problems associated with metabolic labeling using radioactive or fluorescent tags. Small bioorthogonal groups are generally more readily incorporated into biosynthetic pathways, and sensitive fluorescence detection can be used to observe the probe after the labelling reaction. The bioorthogonal metabolic labeling of carbohydrates is immensely popular; however, the majority of studies employing this approach have tended to focus on glycoproteins, despite potential incorporation of the probe into both glycoproteins and glycolipids.⁷⁰⁶ *N*-acetylmannose (ManNAc) derivatives, which are incorporated as Neu5Ac residues, are the most common monosaccharides used for metabolic oligosaccharide engineering, and their use has been reviewed.⁷⁰⁷⁻⁷⁰⁹ Providing ManNAc derivatives to cells with bioorthogonal or photoactivatable groups (see **Sec 4.5**) on their *N*-acyl groups has become an invaluable tool for understanding sialic acid biology. Bertozzi and coworkers have summarized the biosynthesis of Neu5Ac from ManNAc.⁷¹⁰ While *C*-9 azido Neu5Ac has been used as a metabolic label,⁷¹¹ the Neu5Ac biosynthetic pathway does not tolerate modifications to *C*-6 of ManNAc; therefore, methods to target this position require production of a modified Sia, rather than its ManNAc precursor. Sia modified both at the *N*-5 acyl side chain and *C*-9 has been used in metabolic labeling experiments and has the potential to expand the applications of bioorthogonal metabolic probes.⁷⁰⁸ Chemoenzymatic glycan labeling using glycosyltransferases to introduce labeled monosaccharides onto specific acceptors presents an alternative to metabolic oligosaccharide engineering.⁷¹²⁻⁷¹⁴

The most common bioorthogonal functional group introduced into carbohydrates is the azide because of its small size, metabolic stability, and requisite bioorthogonal reactivity.⁷¹⁵ Alkynes have been proposed as a less toxic and more metabolically efficient alternative.⁷¹⁶⁻⁷¹⁸ The popular copper-catalyzed azide-alkyne cycloaddition was considered to be incompatible with

living systems because of toxicity from the catalyst. Strategies to mitigate copper toxicity are a partial solution to this problem.^{719,720} To avoid the use of copper in live-cell or live-organism imaging, the Staudinger ligation^{706,721,722} and strain-promoted (3+2) cycloaddition^{715,723,724} have been developed. ManNAc labeled with perfluoroaryl azide is compatible with the Neu5Ac biosynthetic machinery and accelerates the Staudinger ligation.⁷²⁵

An alternative to bioorthogonal metabolic labeling is bioorthogonal *in situ* labeling. This strategy takes advantage of intrinsic reactivity in natural carbohydrates to selectively label the residue of interest. Because of the lack of chemical handles present in carbohydrates, these methods are limited to selective methods such as periodate oxidation and aniline catalyzed oxime ligation (PAL, selective for terminal sialic acids). An analogous approach with Gal-6-ox and aniline catalyzed oxime ligation is known as GAL (selective for terminal Gal residues). Both methods selectively introduce aldehydes into the target carbohydrate residue, followed by the selective addition of a tag through aniline-catalyzed oxime ligation.^{363,726} PAL and GAL are complementary⁷²⁷ and have recently been used together to probe for NEU activity on the cell surface.⁷²⁸ The *in situ* labeling of carbohydrates has been used primarily for studies of glycoproteins; however, these methods should be applicable to glycolipid targets.

The introduction of a bioorthogonal group on glycolipids through metabolic or *in situ* labelling are synthetically inexpensive. However, they are analytically costly as these labels may be incorporated broadly into multiple species. Convergent or semisynthetic methods for the synthesis of glycolipids with bioorthogonal groups incorporated into the carbohydrate moiety, thus, have advantages for restricting the label to a single target. GlcCer was tagged with an azido group at C-6 of the Glc residue.⁷²⁹ Peracetylated C-6 azido Glc was converted to a trichloroacetimidate donor prior to glycosylation with benzoyl-protected Cer in the presence of boron trifluoride diethyl etherate. Azido-LacCer has been generated by a similar convergent approach.⁷²⁹

4.4.2 *Tagging the lipid*

There are few examples of bioorthogonal tags as applied to the lipid portion of GSLs; however, there are several strategies which have been applied on other classes of lipids and could likely be translated to GSLs. The semisynthesis of lipids containing azido- or alkynyl-fatty acids can be accomplished through acylation of lyso-lipids with the appropriately modified fatty acids. Incorporation of a bioorthogonal tag into the lipid moiety of glycolipids is likely to make the bioorthogonal group less accessible for subsequent reaction. Consequently, the tag used to detect the bioorthogonal probe must be membrane permeable, or else the lipid may need to be extracted from the membrane. Reports of glycolipids with bioorthogonal labels in the lipid moiety tend to have poor detection, with the most plausible explanation being that the membrane is shielding reactivity of the bioorthogonal group.^{729,730}

Several strategies for the generation of fatty acids with bioorthogonal tags are known, and acylation of lyso-glycolipids with these fatty acids could be used to generate labeled GSLs. Fatty acids with an ω -azide have been generated through the conjugation of diphenylphosphorylazide to the methyl ester of a hydroxy fatty acid in the presence of diisopropylazodicarboxylate and PPh_3 . The α -azide was obtained by converting the isobutyl 3-hydroxy fatty acid to the isobutyl 3-mesylyl fatty acid. After hydrolysis of the isobutyl ester, reaction with NaN_3 generated the final product.⁷³¹ An azide was introduced to the alkene of oleate by converting the olefin to the 1,2 epoxide and obtaining the azide through treatment with NaN_3 .⁷³² Ceramides were labeled with an azido group at either the α or ω position of the fatty acid through a convergent method. An α - or ω -bromocarboxylic acid was stirred with NaN_3 in dimethylformamide to generate the azide-modified acid. Carbodiimide coupling was used to form the azide-modified Cer.⁷³⁰ These azide-modified ceramides could be glycosylated to generate azide-labeled glycolipids. Azide-labeled Sph has been used for the metabolic labeling of sphingolipids, including glycolipids, *in vitro*.⁷³³

Alkynes may perturb the hydrophobic properties of the lipid moiety less than the more polar azido group. Fatty acids with a pendant alkyne have been generated by converting propargyl alcohol to a trichloroacetimidate and stirring it with a fatty acid ester containing an alcohol at the α or ω position.⁷³¹ Alkyne oleate was made from ω -bromononanol and 9-decynol, followed by oxidation and coupling by Wittig reaction.⁷³⁴ Saturated ω -alkyne fatty acids were generated through the oxidation of ω -hydroxy fatty acid esters, followed by conversion of the aldehyde to an alkyne with the Bestmann-Ohira reagent.⁷³⁴ This method has been applied to the synthesis of alkyne-containing glycolipids.⁷³⁵ Oleate can be converted to a saturated ω -alkyne fatty acid through bromination/debromination, followed by an acetylene zipper reaction.^{736,737} Alkyne-terminated fatty acids have been generated using a convergent method from 1-bromo alkyl chains.⁷³⁸

4.5 Photoresponsive glycolipids

Photosensitive functional groups have been introduced into glycolipids to generate labeled glycolipid probes. These labels undergo a chemical change in response to irradiation with UV light. The most common class of photoresponsive glycolipid probes generated are photocrosslinking glycolipids that can be covalently cross-linked to other biomolecules upon irradiation with UV light, which provides information on interactions of these glycolipids with other biomolecules.^{739,740} This strategy can help to identify proteins that are in proximity to the glycolipid of interest within the cellular environment. Photocrosslinking groups typically incorporated into glycolipids include nitrophenyl azides, diazirines, and benzophenones. Most photocrosslinking glycolipid probes also contain a secondary label (e.g. radionuclide, fluorochrome, or bioorthogonal tag) for detection of the crosslinked product. The location of the photocrosslinking group within the probe may vary depending on the nature of the interactions being investigated.

4.5.1 Glycan photocrosslinkers

Metabolic labeling is a common method for generating glycolipids with a photocrosslinking group contained in the glycan. Like metabolic labeling of glycolipids with bioorthogonal tags, the most extensive work in this field has been done with metabolic labeling of Sia (**Figure 18**). A ManNAc precursor with a pendant *N*-2 acyl group containing a tag (**78**) will be incorporated biosynthetically into Sia with an *N*-5 tag (**79**). Examples of this strategy using ManNAc derivatives containing an *N*-2 diazirine⁷⁴¹ or aryl azide⁷⁰⁹ were incorporated into cell surface glycoconjugates. Modification of the *C*-9 position of Sia with an aryl azide required the use of cells lacking Sia biosynthetic machinery.⁷⁴² Photocrosslinking of *N*-5 diazirine-modified Sia has been used to detect ganglioside–protein interactions.^{743,744} A bifunctional Sia probe containing an azide at *C*-9 and diazirine at the *C*-5 was provided to cells, and was confirmed to incorporate into glycoproteins, while glycolipids were likely also labeled.⁷⁰⁸

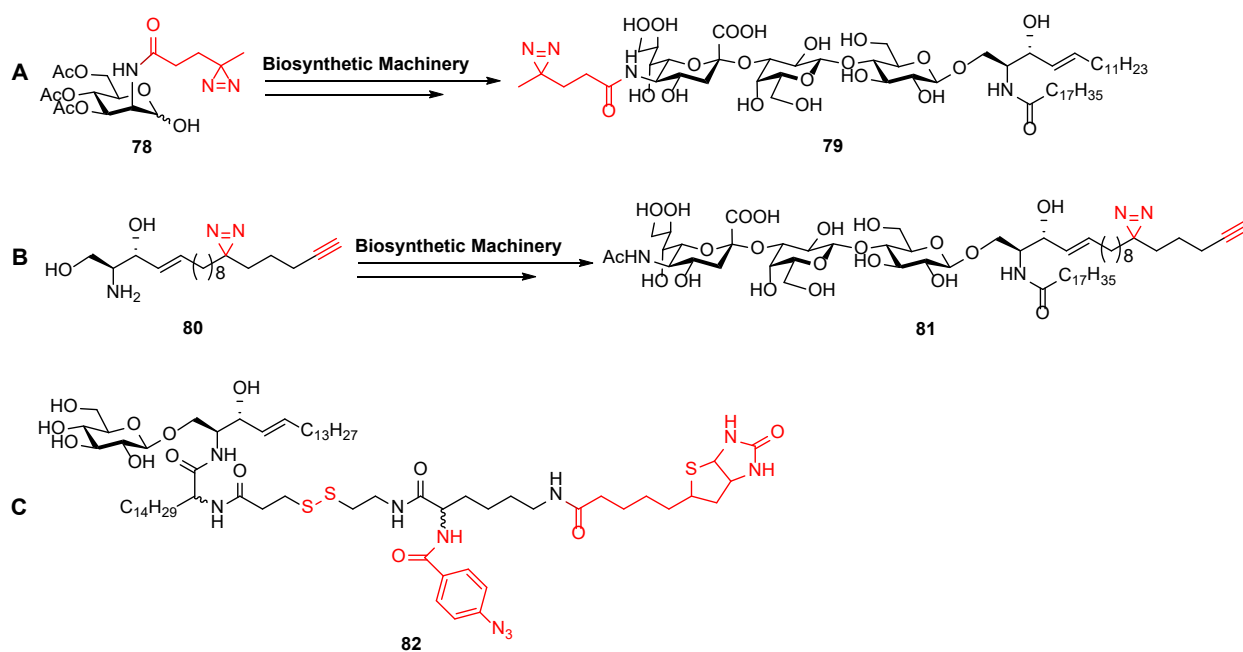

Figure 18. Photoactivatable glycolipids made by A) metabolic labeling of the glycan moiety, B) metabolic labeling of the Sph chain, and C) semisynthesis through removal of the fatty acid and addition of a modified fatty acid.

4.5.2 Lipid photocrosslinkers

Glycolipids labeled with photocrosslinking groups and radiolabels in their lipid chain have been used to study ganglioside-protein interactions. These bifunctional probes were first used by Sonnino et al. in 1989. The Neu5Ac *N*-acetyl group and the fatty acid chain of GM1 were removed using base hydrolysis. Fatty acid acylation was accomplished with an Fmoc-protected ω -amino fatty acid through NHS activation. After re-acetylation of the Sia moiety with ^3H acetic anhydride, the Fmoc group was removed and the free amine was coupled with a nitrophenylazide.⁷⁴⁵ The method has been reviewed elsewhere^{746,747} and has been used to identify several glycolipid-protein interactions.^{739,740} For asialo glycolipids, the *C*-3 position of Cer was labeled with tritium using an oxidation/reduction strategy.⁷⁴⁰ Alternatively, ^{125}I can be incorporated into the phenylazide group.^{748,749} As such, the method can be applied to free sphingolipids.⁶⁰⁵ Glycolipid-like probes were used to obtain information on the depth of proteins and phospholipids in membrane structures. Glucosamine was acylated at *N*-2 with a fatty acid containing a nitrophenyl azide. The photocrosslinking group was located either at the α -position, or near the terminus, of the fatty acid chain.⁷⁵⁰⁻⁷⁵² Diazirines and benzophenones have been used as photoactivatable groups in the lipid portion of glycolipids. Bifunctional Sph-containing diazirine and tritium labels were incorporated into GSLs in a metabolic labeling experiment.⁷⁵³ A bifunctional Sph with a diazirine photocrosslinker and an alkyne tag was incorporated into the GSL metabolic pathway (e.g. **81**).⁷⁵⁴ On the other hand, a bifunctional fatty acid containing diazirine and alkyne labels was reported to be incompatible with the metabolic labeling of GSLs.¹⁶² Bifunctional fatty acids were, however, incorporated into glycolipids synthetically.⁷⁵⁵ A semisynthetic method incorporating an amine into the α position of the fatty acid chain was used to generate a trifunctional GlcCer probe **82** containing an aryl azide, a biotin tag, and a cleavable disulfide bond.⁷⁵⁶ Benzophenone was incorporated into the sphingosine moiety of a glycolipid

using a convergent approach. Following glycosylation of galactose onto a truncated Sph containing a terminal alkene, a cross-metathesis reaction generated the labeled product.⁷⁵⁷

Aryl azide, benzophenone, and diazirine crosslinkers have been incorporated into the lipid moiety of glycolipids through a convergent synthetic approach starting from Boc protected lysine. Comparative studies concluded that the aryl azides had the highest crosslinking yield; however, diazirine groups had the lowest proportion of nonspecific crosslinking.^{758,759} A similar study comparing diazirine labeled glycolipids to trifluoromethylphenyldiazirines found the diazirine had reduced crosslinking yields, but was more specific.⁷⁶⁰

4.5.3 Caged glycolipids

Lipids featuring an unnatural protecting group which can be released upon irradiation with UV light are commonly referred to as “caged lipids.” This term can be misleading because the lipid is not trapped; rather, a photocleavable group is typically attached to the lipid in a position that renders it biologically inactive. The active lipid is released upon irradiation with a suitable wavelength of light. Caged lipids are attractive in their capability for rapid and specific control over the concentration of a single lipid species, making them useful for investigating the role of lipids in signaling.⁷⁶¹ To date, there are few examples of caged glycolipids or GSL probes, and relevant examples are provided below.

The photocleavable *N*-4-carboxymethyl-2-nitrobenzyloxycarbonyl was originally used as a protecting group for the chemoenzymatic synthesis of GSLs. Lyso-LacCer was acylated with 1-methyl-3-(4-carboxymethyl-2-nitrobenzyloxycarbonyl)-imidazolium chloride, which was prepared by stirring methyl-4-hydroxyl-3-methoxybenzoate, 1-methylimidazole, and phosgene in toluene. The protecting group could be removed upon irradiation with light.⁷⁶² This concept was expanded from sphingolipid protecting group chemistry to caged sphingolipids nearly a decade later.⁷⁶³ *N*-2-nitrobenzyl caged lipids have also been prepared.⁷⁶² An *N*-2-nitrobenzyl caged

galactosylsphingosine and glucosylsphingosine were prepared by reaction of nitrobenzyl bromide with the corresponding sphingosine.⁷⁶³ A similar strategy was used for the chemoenzymatic synthesis of *N*-2-nitrobenzyloxycarbonyl-caged lyso-GM3. *N*-2-nitrobenzyloxycarbonyl-caged Sph was glycosylated with per-*O*-acetylated lactosyl bromide. After deprotection to afford caged lyso-LacCer, a SiaT reaction generated caged lyso-GM3.⁷⁶⁴ The compatibility of *N*-2-nitrobenzyloxycarbonyl-caged Sph with both chemical and enzymatic transformations indicate this approach may be feasible for the synthesis of other lyso-gangliosides.

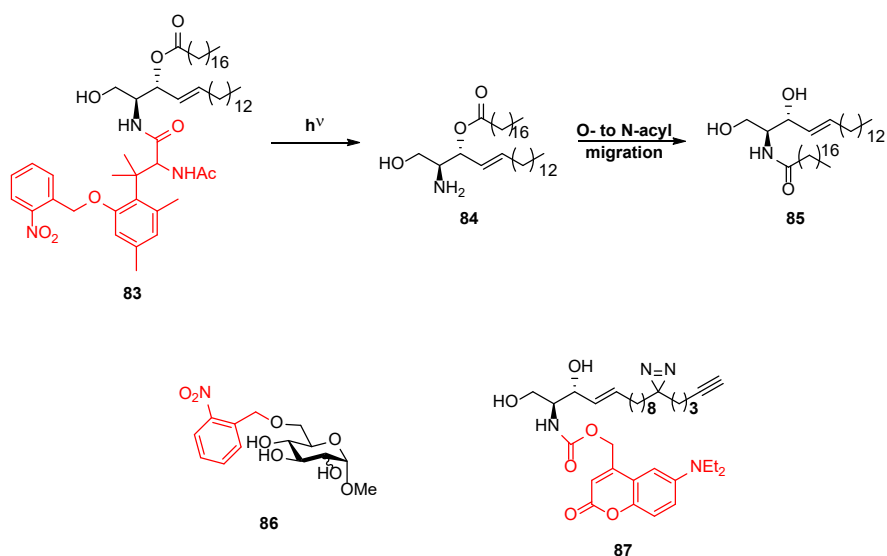

Figure 19. Structures of caged lipids

Approaches to caged phospholipids and sphingolipids may be transferable for the synthesis of caged glycolipids. An elegant caged Cer probe was developed in which release of the photocleavable group induced *O*- to *N*-acyl migration of the fatty acid to generate Cer (**83-85**, **Figure 19**). Starting from protected Sph, *N*-acylation with the photocleavable group was followed by *O*-acylation of the *C*-3 secondary alcohol with a fatty acid.⁷⁶⁵ Although this method has not been applied to the synthesis of caged glycolipids, the primary hydroxyl group of the Cer moiety was not involved and could likely tolerate a glycan. Photocaged glycan residues have been generated using *o*-nitrobenzyl groups incorporated into *C*-6 of methyl glucoside and methyl

mannoside from their 4,6-*O*-*o*-benzylidene acetals through reductive ring opening (**86**).⁷⁶⁶ A trifunctional sphingosine probe was made containing a photocleavable caging group, a bioorthogonal alkyne, and a photocrosslinking diazirine group (**87**).⁷⁶⁷

4.5.4 Photoswitchable glycolipids

Photoswitchable glycolipids are those that change conformation upon irradiation with UV light. Azobenzene derivatives are well known for their photoswitchable properties that have been adapted for applications in biomolecules⁷⁶⁸ and photosensitive materials.⁷⁶⁹ Upon irradiation with UV light, azobenzene switches from a *trans* conformation to a *cis* conformation. Other properties of azobenzene and its applications have been reviewed elsewhere.⁷⁶⁸ Azobenzene-Glc derivatives have been constructed and used to form monolayers.⁷⁷⁰ A similar approach was used for the synthesis of a variety of glycolipids with Glc, Gal, Man, xylose, and Lac sugar units.⁷⁷¹ A photoswitchable Cer was developed to convert ordered domains into disordered domains upon irradiation with UV light, a feature useful to probe lipid function within a membrane environment. Sph was converted in one step to the photoswitchable Cer through amide coupling with an azobenzene-containing fatty acid.⁷⁷² Maltose-based azobenzene-containing glycolipids were designed as photosensitive supramolecular gelators.⁷⁷³ A supramolecular amphiphile with a Gal headgroup and a distal azobenzene group has demonstrated photoswitchable properties.⁷⁷⁴

4.6 Glycolipid microarrays

Carbohydrate microarrays provide a high-throughput method to screen carbohydrate-protein interactions using small amounts of analyte and protein.⁷⁷⁵ Glycolipid microarrays that mimic properties of the lipid membrane can also provide insight into the role of lipid clustering in glycolipid-protein or glycolipid-pathogen interactions. The methods for carbohydrate immobilization onto microarrays fall into two categories: covalent and non-covalent methods.

Methods for glycan microarray construction have been reviewed extensively,^{310,775-778} so keeping with the scope of this review, we will only discuss methods that pertain to the construction of glycolipid microarrays.

4.6.1 Non-covalent attachment

The non-covalent immobilization of carbohydrates on glycolipid microarrays permits lateral mobility of the glycolipids and can mimic clustering that occurs within membranes. Clustering may lead to increased avidity for weak carbohydrate-protein interactions. An early glycolipid array immobilized GSLs through adsorption on a 96-well polystyrene microtiter plate.⁷⁷⁹ An array of synthetic glycolipids with an aglycone consisting of alkyl chains ranging in length from 3-11 carbon atoms was also made by this method.⁷⁸⁰ This strategy has been used by other groups, but requires greater quantities of glycolipid than microarrays.^{781,782}

An early method for construction of carbohydrate microarrays converted carbohydrates to neoglycolipids followed by adsorption onto nitrocellulose coated glass slides.⁷⁸³⁻⁷⁸⁷ Microarrays with glycans from a variety of sources, from synthetic oligosaccharides to whole organs, have been constructed.³¹⁰ These neoglycolipids are typically generated through reductive amination of reducing sugars.⁷⁸³ An alternative which preserves the reducing-end residue is oxime ligation with an aminoxy-linker. Neoglycolipid arrays produced in this way were reported to be more sensitive than an equivalent array generated by reductive amination.³²⁰ An alternative to nitrocellulose membranes is polyvinyl difluoride (PVDF) membranes.⁷⁸⁸ Drawing inspiration from membrane protein microarrays,⁷⁸⁹ glycolipid microarrays have been constructed on γ -aminopropylsilane-coated slides. This surface retained glycolipids yet allowed for their long-range lateral mobility. Gangliosides GM1 and GT1b were incorporated into vesicles and printed on γ -aminopropylsilane-coated slides.⁷⁹⁰ A glycolipid microarray has been made by non-covalent immobilization of

glycolipids on a hydrazide-functionalized dendrimer film. The method is proposed to have reduced autofluorescence as compared to nitrocellulose and PVDF membranes.⁷⁹¹

Glycolipids form heterogeneous microdomains in membranes.¹⁷¹⁻¹⁷³ Combinatorial glycolipid microarrays (where multiple glycolipids are printed on each spot) enable study of the effects of glycolipid clusters and heterodimers on protein recognition. A combinatorial ganglioside microarray was made by spotting mixtures of gangliosides on a PVDF membrane.^{152,792} A variety of lectins and toxins were tested against the microarray; notably, individual gangliosides had different interactions as compared to combinations of gangliosides.¹⁵² These data highlight the complexity of glycolipid membrane interactions,⁷⁹³ and the necessity for analytical technologies to study such complex interactions. Combinatorial glycolipid microarrays have also been printed with neutral glycolipids,⁷⁹⁴ and mixtures of gangliosides and neutral glycolipids.⁷⁹⁵⁻⁷⁹⁷ As many as 11 gangliosides, 8 neutral glycolipids, and their 162 heterodimeric complexes have been assayed on a single combinatorial glycolipid microarray.⁷⁹⁷

4.6.2 Covalent attachment

Although covalent immobilization of glycolipids on microarrays does not permit lateral diffusion, it enables more control over intermolecular distance and may afford improved stability.⁷⁹⁸ Early covalent carbohydrate microarrays immobilized maleimide-linked carbohydrates onto thiol-coated glass slides. The carbohydrate moiety was tethered to the maleimide through alkyl chains of varying length.⁷⁹⁹ Another early method coupled the reducing end sugar of GM1, asialo-GM1, and GM3 to 4-(2-aminoethyl)aniline through reductive amination. The resulting pendant amine was coupled to an NHS-activated glass surface.⁸⁰⁰ The same protocol was used more recently to make a microarray containing GM1-related carbohydrates to probe GM1 interactions with cholera toxin.⁷⁹⁸ An alternative covalent approach has used azide-modified surfaces to link phosphine-containing liposomes via Staudinger ligation. Liposomes doped with phosphine-lipids were loaded

with gangliosides, such as GM1 and GM3, prior to immobilization on the azide-coated surface.⁸⁰¹ The unreacted phosphine reagents provided potential for further synthetic modification.⁸⁰² This approach provides a combination of covalent attachment while presenting gangliosides in a fluid bilayer. Alternative membrane-mimetic platforms include micelles,⁸⁰³ nanodiscs,¹²⁹ and picodiscs.¹²⁸

5 Conclusions and outlook

There has been a definite resurgence in interest for development of modified glycolipids as research tools over the last decade. This is perhaps most attributable to the maturation of synthetic methods which have put complex GSL targets within reach. We hope to see this field expand and begin to address fundamental questions about the association of GSLs with themselves and other molecular species within the membrane environment. It is notable that many of the methods discussed to generate probes in this review were first applied to phospho- or sphingo-lipids before applications in glycolipids. As more groups delve into the synthesis of modified glycolipids, it is likely that we will expand our understanding of the molecular features central to their function. There remains a need for diverse strategies that provide selective modifications in the glycan moiety of GSL. While Gal-6-Ox, periodate oxidation, and glycosyltransferase strategies are well known, there remains a need to expand available tools to address alternative sites common to these oligosaccharides. Furthermore, new analytical methods that can explore the specific interactions of glycolipids may benefit from new probe-based strategies. GSLs serve unique roles within the cell membrane and contain extensive molecular complexity as compared to other membrane lipids. The continued development of new probes to investigate these systems will be essential to revealing the details of protein-lipid and lipid-lipid interactions which GSL take part in and, by extension, the diverse biological processes in which they participate.

ORCID

Christopher W. Cairo: 0000-0003-3363-8708

Carmanah D. Hunter: 0000-0001-8438-0925

Michele R Richards: 0000-0002-1973-5678

Author Biographies

Carmanah D. Hunter completed her B.Sc. with Honours in Chemistry at Mount Allison University in 2014. She began her graduate studies later that year at the University of Alberta with Prof. Christopher W. Cairo, where she is currently a Ph.D. candidate. Her research focuses on studying human neuraminidase substrate specificity towards natural and unstable sialic acids.

Tianlin Guo received her B.A. in Pharmaceutical Science at the Sun Yat-sen University in 2010, and obtained her Ph.D. in Chemical Biology under the supervision of Professor Zhengying Pan at Peking University in 2015. Tianlin then started working as a postdoctoral researcher in the laboratory of Prof. Christopher W. Cairo at the University of Alberta working on small molecules as research tools for the study of human neuraminidases.

Gour Chand Daskhan completed his M.Sc. in Chemistry from the Indian Institute of Technology Kharagpur in 2005 and received his Ph.D. in Organic Chemistry under the supervision of Prof. N. Jayaraman at the Indian Institute of Science, Bengaluru in 2013. He was a postdoctoral researcher with Prof. Olivier Renaudet at the University of Grenoble-Alpes (2013–2015). During this period, he was involved in projects that combined carbohydrate chemistry and peptide chemistry. Gour then joined the laboratory of Prof. Christopher W. Cairo at the University of Alberta as a postdoctoral fellow. His current research is in the areas of synthetic carbohydrate chemistry, bioconjugation chemistry, and glycobiology.

Michele R. Richards received her B.A. in Chemistry at the University of Nebraska-Lincoln in 1996, and her M.Sc. in 1998 from the University of Wisconsin-Madison with Prof. Samuel H. Gellman. After a period in industry, she obtained her Ph.D. with Prof. Todd L. Lowary at the University of Alberta in 2012. Michele is currently a postdoctoral researcher in the Alberta Glycomics Centre working with Prof. Christopher W. Cairo and Prof. John S. Klassen; her research focuses on molecular dynamics simulations of glycolipids, glycoproteins, and glycosyl hydrolase enzymes.

Christopher W Cairo received his B.Sc in Chemistry at the State University of New York at Albany in 1996, and obtained a Ph.D. under the supervision of Prof. Laura L Kiessling at the University of Wisconsin–Madison in 2002. He was an NIH Postdoctoral Fellow in the laboratory of Prof. David Golan at Harvard Medical School (2002-2006). He started as an Assistant Professor in the Department of Chemistry at the University of Alberta in 2006, and was promoted to Associate Professor in 2012. His research group is investigating the biological role of enzymes which modify cell surface glycoconjugates using synthetic probes, medicinal chemistry, bioconjugate chemistry, and cellular biophysics.

Acknowledgements

The authors would like to thank Radhika Chakraborty for helpful discussions. This work was supported by the Natural Sciences and Engineering Research Council (NSERC), the Alberta Glycomics Centre, and the Canadian Glycomics Network (GlycoNet). CH acknowledges support from an NSERC CGS-D Scholarship.

Abbreviations

AV	anthrylvinyl
BABS	bis-acetal-based substrate
Boc	<i>tert</i> -butyloxycarbonyl
BODIPY	4,4-difluoro-4-bora-3a,4a-diaza- <i>s</i> -indacene
BOP	Benzotriazole-1-yloxy-tris(dimethylamino)phosphonium
Cav	Caveolin
CAZy	Carbohydrate Active enZYmes Database
Cer	Ceramide
Chol	Cholesterol
CM	Cross-metathesis
CMC	Critical micelle concentration
CMP	Cytidine monophosphate
CSS	CMP-sialic acid synthetase
CTP	Cytidine triphosphate
Cy-3	Cyanine 3 dye
DABCY	4-((4-(dimethylamino)phenyl)azo)benzoic acid
DDQ	2,3-dichloro-5,6-dicyano-1,4-benzoquinone
Dio-C16	3,3'-dihexadecyloxacarbocyanine perchlorate
DPH	3-(<i>p</i> -(6-phenyl)-1,3,5-hexatrienyl)phenyl
DSC	Differential scanning calorimetry
EGFR	Endothelial growth factor receptor
ESR	Electron spin resonance
Fluor	Fluorophore
Fmoc	Fluorenylmethyloxycarbonyl
FRET	Förster resonance energy transfer

Fuc	Fucose
FucT	Fucosyltransferase
GAL	Galactose-6-oxidase oxidation and aniline catalyzed oxime ligation
Gal	Galactose
GalCer	Galactosylceramide
GalNAc	<i>N</i> -acetylgalactosamine
GalNAcT	<i>N</i> -acetylgalactosaminyltransferase
GalT	Galactosyltransferase
GGLs	Glycoglycerolipids
Glc	Glucose
GlcCer	Glucosylceramide
GlcNAc	<i>N</i> -acetylglucosamine
GM2-AP	GM2-activator protein
GPI	Glycophosphatidylinositol
GSL	Glycosphingolipid
GUV	Giant unilamellar vesicle
HP-TLC	High performance thin layer chromatography
HWE	Horner-Wadsworth-Emmons
Kdn	Keto-deoxyneuraminic acid
Lac	Lactose
LacCer	Lactosyl ceramide
LacNAc	<i>N</i> -acetylglucosamine
LIPID MAPS	Lipid Metabolites and Pathways Strategy
LC-MS	Liquid chromatography and mass spectrometry
Le ^a	Lewis ^a

Le ^x	Lewis ^x
LNT	lacto-N-tetraose
LNnT	lacto-N-neotetraose
MAM	Mitochondria-associated membranes
ManNAc	<i>N</i> -acetylmannosamine
NBD	7-nitrobenz-2-oxa-1,3-diazole
Neu4,5Ac ₂	4- <i>O</i> -acetyl <i>N</i> -acetylneuraminic acid
Neu5Ac	<i>N</i> -acetylneuraminic acid
Neu5Ac8OMe	8- <i>O</i> -methyl <i>N</i> -acetylneuraminic acid
Neu5Gc	<i>N</i> -glycolylneuraminic acid
NHS	<i>N</i> -hydroxysuccinimide
NTP	Nucleotide triphosphate
OPME	One-pot multienzyme
PAL	Periodate oxidation and aniline catalyzed oxime ligation
PDA	10,12-pentacosadiynoic acid
PVDF	Polyvinyl difluoride
Sia	Sialic acid
SiaT	Sialyltransferase
sLe ^x	Sialyl Lewis ^x
Sph	Sphingosine
TBDPS	<i>Tert</i> -butyldiphenylsilyl
TBS	<i>tert</i> -butyldimethylsilyl
TMR	Tetramethylrhodamine
TMSOTf	Trimethylsilyl trifluoromethanesulfonate
UDP	Uridine diphosphate
UV	Ultraviolet

References

- (1) van Meer, G.; Voelker, D. R.; Feigenson, G. W. Membrane Lipids: Where They Are and How They Behave. *Nat. Rev. Mol. Cell Biol.* **2008**, *9*, 112-124.
- (2) Schnaar, R. L.; Kinoshita, T. Glycosphingolipids. In *Essentials of Glycobiology*; 3rd ed.; Varki, A.; Cummings, R. D.; Esko, J. D.; Stanley, P.; Hart, G. W.; Aebi, M.; Darvill, A. G.; Kinoshita, T.; Packer, N. H.; Prestegard, J. H.; et al., Eds.; Cold Spring Harbor Laboratory Press: Cold Spring Harbor (NY), 2017.
- (3) Hannun, Y. A.; Obeid, L. M. Sphingolipids and Their Metabolism in Physiology and Disease. *Nat. Rev. Mol. Cell Biol.* **2018**, *19*, 175-191.
- (4) Schnaar, R. L. Gangliosides of the Vertebrate Nervous System. *J. Mol. Biol.* **2016**, *428*, 3325-3336.
- (5) Merrill Jr, A. H.; Vu, M. N. Glycolipids. In *Encyclopedia of Cell Biology*; Academic Press: Waltham, 2016.
- (6) D'Angelo, G.; Capasso, S.; Sticco, L.; Russo, D. Glycosphingolipids: Synthesis and Functions. *FEBS J.* **2013**, *280*, 6338-6353.
- (7) Futerman, A. H. Chapter 10 - Sphingolipids. In *Biochemistry of Lipids, Lipoproteins and Membranes*; 6th ed.; McLeod, R. S., Ed.; Elsevier: Boston, 2016.
- (8) Kopitz, J. Lipid Glycosylation: A Primer for Histochemists and Cell Biologists. *Histochem. Cell Biol.* **2017**, *147*, 175–198.
- (9) Groux-Degroote, S.; Guérardel, Y.; Delannoy, P. Gangliosides: Structures, Biosynthesis, Analysis, and Roles in Cancer. *ChemBioChem* **2017**, *18*, 1146–1154.
- (10) McNaught, A. D. Nomenclature of Carbohydrates. *Carbohydr. Res.* **1997**, *297*, 1-92.
- (11) Fahy, E.; Subramaniam, S.; Brown, H. A.; Glass, C. K.; Merrill, A. H.; Murphy, R. C.; Raetz, C. R. H.; Russell, D. W.; Seyama, Y.; Shaw, W. et al. A Comprehensive Classification System for Lipids. *J. Lipid Res.* **2005**, *46*, 839-862.
- (12) Fahy, E.; Subramaniam, S.; Murphy, R. C.; Nishijima, M.; Raetz, C. R.; Shimizu, T.; Spener, F.; van Meer, G.; Wakelam, M. J.; Dennis, E. A. Update of the Lipid Maps Comprehensive Classification System for Lipids. *J. Lipid Res.* **2009**, *50*, S9-S14.
- (13) Chester, M. IUPAC-IUB Joint Commission on Biochemical Nomenclature (JCBN). Nomenclature of Glycolipids--Recommendations 1997. *Eur. J. Biochem.* **1998**, *257*, 293–298.
- (14) *Essentials of Glycobiology*; 3rd ed.; Varki, A.; Cummings, R. D.; Esko, J. D.; Stanley, P.; Hart, G. W.; Aebi, M.; Darvill, A. G.; Kinoshita, T.; Packer, N. H.; Prestegard, J. H. et al., Eds.; Cold Spring Harbor Laboratory Press: Cold Spring Harbor, New York, 2017.

- (15) Fahy, E.; Cotter, D.; Sud, M.; Subramaniam, S. Lipid Classification, Structures and Tools. *Biochim. Biophys. Acta, Mol. Cell Biol. Lipids* **2011**, *1811*, 637-647.
- (16) Fahy, E.; Sud, M.; Cotter, D.; Subramaniam, S. Lipid Maps Online Tools for Lipid Research. *Nucleic Acids Res.* **2007**, *35*, W606-W612.
- (17) Hartler, J. Lipid Maps: Tools and Databases. **2015**.
- (18) The Lipid Maps Lipidomics Gateway. <http://www.lipidmaps.org/> (accessed 8/15/2017).
- (19) Sud, M.; Fahy, E.; Cotter, D.; Brown, A.; Dennis, E. A.; Glass, C. K.; Merrill, J. A. H.; Murphy, R. C.; Raetz, C. R. H.; Russell, D. W. et al. LMSD: Lipid Maps Structure Database. *Nucleic Acids Res.* **2007**, *35*, D527-D532.
- (20) Varki, A.; Cummings, R. D.; Aebi, M.; Packer, N. H.; Seeberger, P. H.; Esko, J. D.; Stanley, P.; Hart, G.; Darvill, A.; Kinoshita, T. Symbol Nomenclature for Graphical Representations of Glycans. *Glycobiology* **2015**, *25*, 1323–1324.
- (21) Thieker, D. F.; Hadden, J. A.; Schulten, K.; Woods, R. J. 3d Implementation of the Symbol Nomenclature for Graphical Representation of Glycans. *Glycobiology* **2016**, *26*, 786–787.
- (22) Tsuchiya, S.; Aoki, N. P.; Shinmachi, D.; Matsubara, M.; Yamada, I.; Aoki-Kinoshita, K. F.; Narimatsu, H. Implementation of Glycanbuilder to Draw a Wide Variety of Ambiguous Glycans. *Carbohydr. Res.* **2017**, *445*, 104–116.
- (23) Svennerholm, L. Chromatographic Separation of Human Brain Gangliosides. *J. Neurochem.* **1963**, *10*, 613–623.
- (24) Svennerholm, L. Designation and Schematic Structure of Gangliosides and Allied Glycosphingolipids. *Prog. Brain Res.* **1994**, *101*, xi–xiv.
- (25) Varki, A.; Schnaar, R. L.; Schauer, R. Sialic Acids and Other Nonulosonic Acids. In *Essentials of Glycobiology*; 3rd ed.; Varki, A.; Cummings, R. D.; Esko, J. D.; Stanley, P.; Hart, G. W.; Aebi, M.; Darvill, A. G.; Kinoshita, T.; Packer, N. H.; Prestegard, J. H.; et al., Eds.; Cold Spring Harbor Laboratory Press: Cold Spring Harbor (NY), 2017.
- (26) Kiso, M.; Ishida, H.; Ando, H.; Imamura, A. Gangliosides Synthesis. In *Glycoscience: Biology and Medicine*; Springer, 2015.
- (27) Hirai, G.; Watanabe, T.; Yamaguchi, K.; Miyagi, T.; Sodeoka, M. Stereocontrolled and Convergent Entry to CF 2-Sialosides: Synthesis of CF 2-Linked Ganglioside GM4. *J. Am. Chem. Soc.* **2007**, *129*, 15420-15421.
- (28) Sakamoto, H.; Nakamura, S.; Tsuda, T.; Hashimoto, S. Chemoselective Glycosidation Strategy Based on Glycosyl Donors and Acceptors Carrying Phosphorus-Containing Leaving Groups: A Convergent Synthesis of Ganglioside GM3. *Tetrahedron Lett.* **2000**, *41*, 7691-7695.
- (29) Duclos, R. I. The Total Synthesis of Ganglioside GM3. *Carbohydr. Res.* **2000**, *328*, 489-507.

- (30) Kurosu, M.; Kitagawa, I. Ganglioside GM3 Derivatives with Truncated Ceramide Moiety: Facial Synthesis and Inhibitory Activity against Kb Cell Growth. *J. Carbohydr. Chem.* **2006**, *25*, 427-439.
- (31) Liu, Y.; Ruan, X.; Li, X.; Li, Y. Efficient Synthesis of a Sialic Acid α (2 \rightarrow 3) Galactose Building Block and Its Application to the Synthesis of Ganglioside GM3. *J. Org. Chem.* **2008**, *73*, 4287-4290.
- (32) Fujikawa, K.; Nohara, T.; Imamura, A.; Ando, H.; Ishida, H.; Kiso, M. A Cyclic Glucosyl Ceramide Acceptor as a Versatile Building Block for Complex Ganglioside Synthesis. *Tetrahedron Lett.* **2010**, *51*, 1126-1130.
- (33) Liu, Y. P.; Wen, L. Q.; Li, L.; Gadi, M. R.; Guan, W. Y.; Huang, K.; Xiao, Z. Y.; Wei, M. H.; Ma, C.; Zhang, Q. et al. A General Chemoenzymatic Strategy for the Synthesis of Glycosphingolipids. *Eur. J. Org. Chem.* **2016**, *2016*, 4315-4320.
- (34) Vaughan, M. D.; Johnson, K.; DeFrees, S.; Tang, X.; Warren, R. A. J.; Withers, S. G. Glycosynthase-Mediated Synthesis of Glycosphingolipids. *J. Am. Chem. Soc.* **2006**, *128*, 6300-6301.
- (35) Ito, Y.; Paulson, J. C. A Novel Strategy for Synthesis of Ganglioside GM3 Using an Enzymically Produced Sialoside Glycosyl Donor. *J. Am. Chem. Soc.* **1993**, *115*, 1603-1605.
- (36) Liu, K. K. C.; Danishefsky, S. J. A Striking Example of the Interfacing of Glycal Chemistry with Enzymatically Mediated Sialylation: A Concise Synthesis of Ganglioside GM3. *J. Am. Chem. Soc.* **1993**, *115*, 4933-4934.
- (37) Kulkarni, S. S. Synthesis of Glycosphingolipids. In *Glycochemical Synthesis: Strategies and Applications*; John Wiley & Sons, Inc.: Hoboken, New Jersey, 2016.
- (38) Ando, H.; Komura, N.; Imamura, A.; Kiso, M.; Ishida, H. A Synthetic Challenge to the Diversity of Gangliosides for Unveiling Their Biological Significance. *J. Synth. Org. Chem., Jpn.* **2017**, *75*, 1162-1170.
- (39) Fuse, T.; Ando, H.; Imamura, A.; Sawada, N.; Ishida, H.; Kiso, M.; Ando, T.; Li, S.-C.; Li, Y.-T. Synthesis and Enzymatic Susceptibility of a Series of Novel GM2 Analogs. *Glycoconjugate J.* **2006**, *23*, 329-343.
- (40) Komori, T.; Ando, T.; Imamura, A.; Li, Y.-T.; Ishida, H.; Kiso, M. Design and Efficient Synthesis of Novel GM2 Analogues with Respect to the Elucidation of the Function of GM2 Activator. *Glycoconjugate J.* **2008**, *25*, 647-661.
- (41) Bhattacharya, S. K.; Danishefsky, S. J. A Total Synthesis of the Methyl Glycoside of Ganglioside GM1. *J. Org. Chem.* **2000**, *65*, 144-151.
- (42) Komori, T.; Imamura, A.; Ando, H.; Ishida, H.; Kiso, M. Study on Systematizing the Synthesis of the α -Series Ganglioside Glycans GT1a, GD1a, and GM1 Using the Newly Developed N-Troc-Protected GM3 and GalN Intermediates. *Carbohydr. Res.* **2009**, *344*, 1453-1463.

- (43) Sun, B.; Yang, B.; Huang, X. Total Synthesis of the Aminopropyl Functionalized Ganglioside GM1. *Sci. China: Chem.* **2012**, *55*, 31-35.
- (44) Castro-Palomino, J. C.; Simon, B.; Speer, O.; Leist, M.; Schmidt, R. R. Synthesis of Ganglioside GD3 and Its Comparison with Bovine GD3 with Regard to Oligodendrocyte Apoptosis Mitochondrial Damage. *Chem. - Eur. J.* **2001**, *7*, 2178-2184.
- (45) Meijer, A.; Ellervik, U. Interhalogens (Icl/Ibr) and AgOTf in Thioglycoside Activation; Synthesis of Bislactam Analogues of Ganglioside GD3. *J. Org. Chem.* **2004**, *69*, 6249-6256.
- (46) De Meo, C.; Demchenko, A. V.; Boons, G.-J. A Stereoselective Approach for the Synthesis of α -Sialosides. *J. Org. Chem.* **2001**, *66*, 5490-5497.
- (47) Tsvetkov, Y. E.; Nifantiev, N. E. Enhanced Sialylating Activity of O-Chloroacetylated 2-Thioethyl Sialosides. *Synlett* **2005**, *2005*, 1375-1380.
- (48) Imamura, A.; Ando, H.; Ishida, H.; Kiso, M. Ganglioside GQ1b: Efficient Total Synthesis and the Expansion to Synthetic Derivatives to Elucidate Its Biological Roles. *J. Org. Chem.* **2009**, *74*, 3009-3023.
- (49) Tanaka, H.; Nishiura, Y.; Takahashi, T. An Efficient Convergent Synthesis of GP1c Ganglioside Epitope. *J. Am. Chem. Soc.* **2008**, *130*, 17244-17245.
- (50) Varki, N. M.; Varki, A. Diversity in Cell Surface Sialic Acid Presentations: Implications for Biology and Disease. *Lab. Invest.* **2007**, *87*, 851-857.
- (51) Tangvoranuntakul, P.; Gagneux, P.; Diaz, S.; Bardor, M.; Varki, N.; Varki, A.; Muchmore, E. Human Uptake and Incorporation of an Immunogenic Nonhuman Dietary Sialic Acid. *Proc. Natl. Acad. Sci. U. S. A.* **2003**, *100*, 12045-12050.
- (52) Alisson-Silva, F.; Kawanishi, K.; Varki, A. Human Risk of Diseases Associated with Red Meat Intake: Analysis of Current Theories and Proposed Role for Metabolic Incorporation of a Non-Human Sialic Acid. *Mol. Aspects Med.* **2016**, *51*, 16-30.
- (53) Davies, L. R. L.; Varki, A. Why Is N-Glycolylneuraminic Acid Rare in the Vertebrate Brain? In *Sialoglyco Chemistry and Biology I: Biosynthesis, Structural Diversity and Sialoglycopathologies*; Gerardy-Schahn, R.; Delannoy, P.; von Itzstein, M., Eds.; Springer Berlin Heidelberg: Berlin, Heidelberg, 2015.
- (54) Fong, B. Y.; Ma, L.; Khor, G. L.; van der Does, Y.; Rowan, A.; McJarrow, P.; MacGibbon, A. K. H. Ganglioside Composition in Beef, Chicken, Pork, and Fish Determined Using Liquid Chromatography–High-Resolution Mass Spectrometry. *J. Agric. Food Chem.* **2016**, *64*, 6295-6305.
- (55) Jennemann, R.; Wiegandt, H. A Rapid Method for the Preparation of Ganglioside Glac2 (GD3). *Lipids* **1994**, *29*, 365-368.

- (56) Takamizawa, K.; Iwamori, M.; Mutai, M.; Nagai, Y. Gangliosides of Bovine Buttermilk. Isolation and Characterization of a Novel Monosialoganglioside with a New Branching Structure. *J. Biol. Chem.* **1986**, *261*, 5625-5630.
- (57) Lacomba, R.; Salcedo, J.; Alegría, A.; Barberá, R.; Hueso, P.; Matencio, E.; Lagarda, M. J. Sialic Acid (N-Acetyl and N-Glycolylneuraminic Acid) and Ganglioside in Whey Protein Concentrates and Infant Formulae. *Int. Dairy J.* **2011**, *21*, 887-895.
- (58) Wenger, D.; Wardell, S. Action of Neuraminidase (EC 3.2. 1.18) from *Clostridium Perfringens* on Brain Gangliosides in the Presence of Bile Salts. *J. Neurochem.* **1973**, *20*, 607-612.
- (59) Konishi, M.; Imamura, A.; Fujikawa, K.; Ando, H.; Ishida, H.; Kiso, M. Extending the Glucosyl Ceramide Cassette Approach: Application in the Total Synthesis of Ganglioside GalNAc-GM1b. *Molecules* **2013**, *18*, 15153-15181.
- (60) Fujikawa, K.; Nakashima, S.; Konishi, M.; Fuse, T.; Komura, N.; Ando, T.; Ando, H.; Yuki, N.; Ishida, H.; Kiso, M. The First Total Synthesis of Ganglioside GalNAc-GD1a, a Target Molecule for Autoantibodies in Guillain–Barré Syndrome. *Chem. - Eur. J.* **2011**, *17*, 5641-5651.
- (61) Nakashima, S.; Ando, H.; Imamura, A.; Yuki, N.; Ishida, H.; Kiso, M. A First Total Synthesis of a Hybrid-Type Ganglioside Associated with Amyotrophic Lateral Sclerosis-Like Disorder. *Chem. - Eur. J.* **2011**, *17*, 588-597.
- (62) Nakashima, S.; Ando, H.; Saito, R.; Tamai, H.; Ishida, H.; Kiso, M. Efficiently Synthesizing Lacto-Ganglio-Series Gangliosides by Using a Glucosyl Ceramide Cassette Approach: The Total Synthesis of Ganglioside X2. *Chem. - Asian J.* **2012**, *7*, 1041-1051.
- (63) Yu, H.; Li, Y. H.; Zeng, J.; Thon, V.; Nguyen, D. M.; Ly, T.; Kuang, H. Y.; Ngo, A.; Chen, X. Sequential One-Pot Multienzyme Chemoenzymatic Synthesis of Glycosphingolipid Glycans. *J. Org. Chem.* **2016**, *81*, 10809-10824.
- (64) Tsai, T.-I.; Lee, H.-Y.; Chang, S.-H.; Wang, C.-H.; Tu, Y.-C.; Lin, Y.-C.; Hwang, D.-R.; Wu, C.-Y.; Wong, C.-H. Effective Sugar Nucleotide Regeneration for the Large-Scale Enzymatic Synthesis of Globo H and Ssea4. *J. Am. Chem. Soc.* **2013**, *135*, 14831-14839.
- (65) Tsering, D.; Chen, C. C.; Ye, J. F.; Han, Z. P.; Jing, B. Q.; Liu, X. W.; Chen, X.; Wang, F. S.; Ling, P. X.; Cao, H. Z. Enzymatic Synthesis of Human Blood Group P1 Pentasaccharide Antigen. *Carbohydr. Res.* **2017**, *438*, 39-43.
- (66) Danishefsky, S. J.; Shue, Y.-K.; Chang, M. N.; Wong, C.-H. Development of Globo-H Cancer Vaccine. *Acc. Chem. Res.* **2015**, *48*, 643-652.
- (67) Koizumi, S.; Endo, T.; Tabata, K.; Ozaki, A. Large-Scale Production of UDP-Galactose and Globotriose by Coupling Metabolically Engineered Bacteria. *Nat. Biotech.* **1998**, *16*, 847-850.
- (68) Zhang, J.; Kowal, P.; Chen, X.; Wang, P. G. Large-Scale Synthesis of Globotriose Derivatives through Recombinant *E. coli*. *Org. Biomol. Chem.* **2003**, *1*, 3048-3053.

- (69) Antoine, T.; Bosso, C.; Heyraud, A.; Samain, E. Large Scale in Vivo Synthesis of Globotriose and Globotetraose by High Cell Density Culture of Metabolically Engineered *Escherichia coli*. *Biochimie* **2005**, *87*, 197-203.
- (70) Yao, Q.; Song, J.; Xia, C.; Zhang, W.; Wang, P. G. Chemoenzymatic Syntheses of iGb3 and Gb3. *Org. Lett.* **2006**, *8*, 911-914.
- (71) Zhang, J.; Kowal, P.; Fang, J.; Andreana, P.; Wang, P. G. Efficient Chemoenzymatic Synthesis of Globotriose and Its Derivatives with a Recombinant α -(1 \rightarrow 4)-Galactosyltransferase. *Carbohydr. Res.* **2002**, *337*, 969-976.
- (72) Zhou, G.; Liu, X.; Su, D.; Li, L.; Xiao, M.; Wang, P. G. Large Scale Enzymatic Synthesis of Oligosaccharides and a Novel Purification Process. *Bioorg. Med. Chem. Lett.* **2011**, *21*, 311-314.
- (73) Xia, C.; Yao, Q.; Schümann, J.; Rossy, E.; Chen, W.; Zhu, L.; Zhang, W.; De Libero, G.; Wang, P. G. Synthesis and Biological Evaluation of α -Galactosylceramide (KRN7000) and Isoglobotrihexosylceramide (iGb3). *Bioorg. Med. Chem. Lett.* **2006**, *16*, 2195-2199.
- (74) Randriantsoa, M.; Drouillard, S.; Breton, C.; Samain, E. Synthesis of Globopentaose Using a Novel β 1,3-Galactosyltransferase Activity of the *Haemophilus Influenzae* β 1,3-N-Acetylgalactosaminyltransferase LgtD. *FEBS Lett.* **2007**, *581*, 2652-2656.
- (75) Wang, Z.; Gilbert, M.; Eguchi, H.; Yu, H.; Cheng, J.; Muthana, S.; Zhou, L.; Wang, P. G.; Chen, X.; Huang, X. Chemoenzymatic Syntheses of Tumor-Associated Carbohydrate Antigen Globo-H and Stage-Specific Embryonic Antigen 4. *Adv. Synth. Catal.* **2008**, *350*, 1717-1728.
- (76) Baumgärtner, F.; Conrad, J.; Sprenger, G. A.; Albermann, C. Synthesis of the Human Milk Oligosaccharide Lacto-N-Tetraose in Metabolically Engineered, Plasmid-Free *E. coli*. *ChemBioChem* **2014**, *15*, 1896-1900.
- (77) Liu, X.-w.; Xia, C.; Li, L.; Guan, W.-y.; Pettit, N.; Zhang, H.-c.; Chen, M.; Wang, P. G. Characterization and Synthetic Application of a Novel B1, 3-Galactosyltransferase from *Escherichia coli* O55: H7. *Bioorg. Med. Chem.* **2009**, *17*, 4910-4915.
- (78) Chen, C.; Zhang, Y.; Xue, M.; Liu, X.-w.; Li, Y.; Chen, X.; Wang, P. G.; Wang, F.; Cao, H. Sequential One-Pot Multienzyme (OPME) Synthesis of Lacto-N-Neotetraose and Its Sialyl and Fucosyl Derivatives. *Chem. Comm.* **2015**, *51*, 7689-7692.
- (79) Rich, J. R.; Cunningham, A. M.; Gilbert, M.; Withers, S. G. Glycosphingolipid Synthesis Employing a Combination of Recombinant Glycosyltransferases and an Endoglycoceramidase Glycosynthase. *Chem. Comm.* **2011**, *47*, 10806-10808.
- (80) Priem, B.; Gilbert, M.; Wakarchuk, W. W.; Heyraud, A.; Samain, E. A New Fermentation Process Allows Large-Scale Production of Human Milk Oligosaccharides by Metabolically Engineered Bacteria. *Glycobiology* **2002**, *12*, 235-240.
- (81) Sakurama, H.; Fushinobu, S.; Hidaka, M.; Yoshida, E.; Honda, Y.; Ashida, H.; Kitaoka, M.; Kumagai, H.; Yamamoto, K.; Katayama, T. 1,3-1,4- α -L-Fucosynthase That

- Specifically Introduces Lewis a/X Antigens into Type-1/2 Chains. *J. Biol. Chem.* **2012**, *287*, 16709-16719.
- (82) Yu, H.; Lau, K.; Li, Y.; Sugiarto, G.; Chen, X. One-Pot Multienzyme Synthesis of Lewis X and Sialyl Lewis X Antigens. *Curr. Protoc. Chem. Biol.* **2012**, *4*, 233-247.
- (83) Wang, W.; Hu, T.; Frantom, P. A.; Zheng, T.; Gerwe, B.; del Amo, D. S.; Garret, S.; Seidel, R. D.; Wu, P. Chemoenzymatic Synthesis of GDP-L-Fucose and the Lewis X Glycan Derivatives. *Proc. Natl. Acad. Sci. U. S. A.* **2009**, *106*, 16096-16101.
- (84) Dumon, C.; Priem, B.; Martin, S. L.; Heyraud, A.; Bosso, C.; Samain, E. In Vivo Fucosylation of Lacto-N-Neotetraose and Lacto-N-Neohexaose by Heterologous Expression of Helicobacter Pylori α -1,3 Fucosyltransferase in Engineered Escherichia coli. *Glycoconjugate J.* **2001**, *18*, 465-474.
- (85) Otsubo, N.; Ishida, H.; Kannagi, R.; Kiso, M. Design and Synthesis of a Novel Neo-Glycolipid Containing Sialyl Lewis X Determinant Carried on the Mucin GlcNAc β 1-6GalNAc α Core Structure. *Tetrahedron: Asymmetry* **2005**, *16*, 1321-1327.
- (86) Gege, C.; Vogel, J.; Bendas, G.; Rothe, U.; Schmidt, R. R. Synthesis of the Sialyl Lewis X Epitope Attached to Glycolipids with Different Core Structures and Their Selectin-Binding Characteristics in a Dynamic Test System. *Chem. - Eur. J.* **2000**, *6*, 111-122.
- (87) Santra, A.; Yu, H.; Tasnima, N.; Muthana, M. M.; Li, Y.; Zeng, J.; Kenyon, N. J.; Louie, A. Y.; Chen, X. Systematic Chemoenzymatic Synthesis of O-Sulfated Sialyl Lewis X Antigens. *Chem. Sci.* **2016**, *7*, 2827-2831.
- (88) Liu, Y. C.; Li, H.; Otter, A.; Kamath, V. P.; Streiff, M. B.; Palcic, M. M. Chemo-Enzymatic Synthesis of Trimeric Sialyl Lewisx Pentadecasaccharide. *Can. J. Chem.* **2002**, *80*, 540-545.
- (89) Ye, J. F.; Liu, X. W.; Peng, P.; Yi, W.; Chen, X.; Wang, F. S.; Cao, H. Z. Diversity-Oriented Enzymatic Modular Assembly of ABO Histo-Blood Group Antigens. *ACS Catal.* **2016**, *6*, 8140-8144.
- (90) Kwan, D. H.; Ernst, S.; Kötzer, M. P.; Withers, S. G. Chemoenzymatic Synthesis of a Type 2 Blood Group a Tetrasaccharide and Development of High-Throughput Assays Enables a Platform for Screening Blood Group Antigen-Cleaving Enzymes. *Glycobiology* **2015**, *25*, 806-811.
- (91) Drouillard, S.; Driguez, H.; Samain, E. Large-Scale Synthesis of H-Antigen Oligosaccharides by Expressing Helicobacter Pylori A1,2-Fucosyltransferase in Metabolically Engineered Escherichia coli Cells. *Angew. Chem.* **2006**, *118*, 1810-1812.
- (92) Clausen, H.; Hakomori, S.-i. ABH and Related Histo-Blood Group Antigens; Immunochemical Differences in Carrier Isotypes and Their Distribution1. *Vox Sang.* **1989**, *56*, 1-20.

- (93) Cantù, L.; Corti, M.; Del Favero, E.; Raudino, A. Physical Aspects of Non-Ideal Mixing of Amphiphilic Molecules in Solution: The Interesting Case of Gangliosides. *J. Phys.: Condens. Matter* **1997**, *9*, 5033-5055.
- (94) Lichtenberg, D.; Robson, R. J.; Dennis, E. A. Solubilization of Phospholipids by Detergents Structural and Kinetic Aspects. *Biochim. Biophys. Acta, Rev. Biomembr.* **1983**, *737*, 285-304.
- (95) Ulrich-Bott, B.; Wiegandt, H. Micellar Properties of Glycosphingolipids in Aqueous Media. *J. Lipid Res.* **1984**, *25*, 1233-1245.
- (96) Cantù, L.; Del Favero, E.; Sonnino, S.; Prinetti, A. Gangliosides and the Multiscale Modulation of Membrane Structure. *Chem. Phys. Lipids* **2011**, *164*, 796-810.
- (97) Rondelli, V.; Fragneto, G.; Motta, S.; Del Favero, E.; Brocca, P.; Sonnino, S.; Cantù, L. Ganglioside GM1 Forces the Redistribution of Cholesterol in a Biomimetic Membrane. *Biochim. Biophys. Acta, Biomembr.* **2012**, *1818*, 2860-2867.
- (98) Tillack, T. W.; Wong, M.; Allietta, M.; Thompson, T. E. Organization of the Glycosphingolipid Asialo-GM1 in Phosphatidylcholine Bilayers. *Biochim. Biophys. Acta, Biomembr.* **1982**, *691*, 261-273.
- (99) Schwarzmann, G. Uptake and Metabolism of Exogenous Glycosphingolipids by Cultured Cells. *Semin. Cell. Dev. Biol.* **2001**, *12*, 163-171.
- (100) Laine, R. A.; Hakomori, S.-i. Incorporation of Exogenous Glycosphingolipids in Plasma Membranes of Cultured Hamster Cells and Concurrent Change of Growth Behavior. *Biochem. Biophys. Res. Commun.* **1973**, *54*, 1039-1045.
- (101) Brown, R. E.; Thompson, T. E. Spontaneous Transfer of Ganglioside GM1 between Phospholipid Vesicles. *Biochemistry* **1987**, *26*, 5454-5460.
- (102) Palestini, P.; Pitto, M.; Sonnino, S.; Omodeo-Salè, M. F.; Masserini, M. Spontaneous Transfer of GM3 Ganglioside between Vesicles. *Chem. Phys. Lipids* **1995**, *77*, 253-260.
- (103) Sonderfeld, S.; Conzelmann, E.; Schwarzmann, G.; Burg, J.; Hinrichs, U.; Sandhoff, K. Incorporation and Metabolism of Ganglioside GM2 in Skin Fibroblasts from Normal and GM2 Gangliosidosis Subjects. *Eur. J. Biochem.* **1985**, *149*, 247-255.
- (104) Lauc, G.; Heffer-Lauc, M. Shedding and Uptake of Gangliosides and Glycosylphosphatidylinositol-Anchored Proteins. *Biochim. Biophys. Acta, Gen. Subj.* **2006**, *1760*, 584-602.
- (105) Torretta, E.; Vasso, M.; Fania, C.; Capitano, D.; Bergante, S.; Piccoli, M.; Tettamanti, G.; Anastasia, L.; Gelfi, C. Application of Direct HPTLC-MALDI for the Qualitative and Quantitative Profiling of Neutral and Acidic Glycosphingolipids: The Case of NEU3 Overexpressing C2C12 Murine Myoblasts. *Electrophoresis* **2014**, *35*, 1319-1328.
- (106) Kundu, S. K. Thin-Layer Chromatography of Neutral Glycosphingolipids and Gangliosides. *Methods Enzymol.* **1981**, *72*, 185-204.

- (107) Müthing, J. High-Resolution Thin-Layer Chromatography of Gangliosides. *J. Chromatogr. A* **1996**, *720*, 3-25.
- (108) Neville, D. C. A.; Coquard, V.; Priestman, D. A.; te Vruchte, D. J. M.; Sillence, D. J.; Dwek, R. A.; Platt, F. M.; Butters, T. D. Analysis of Fluorescently Labeled Glycosphingolipid-Derived Oligosaccharides Following Ceramide Glycanase Digestion and Anthranilic Acid Labeling. *Anal. Biochem.* **2004**, *331*, 275-282.
- (109) Cremer, P. S.; Boxer, S. G. Formation and Spreading of Lipid Bilayers on Planar Glass Supports. *J. Phys. Chem. B.* **1999**, *103*, 2554-2559.
- (110) Mimms, L. T.; Zampighi, G.; Nozaki, Y.; Tanford, C.; Reynolds, J. A. Phospholipid Vesicle Formation and Transmembrane Protein Incorporation Using Octyl Glucoside. *Biochemistry* **1981**, *20*, 833-840.
- (111) Dustin, M. L.; Sanders, M. E.; Shaw, S.; Springer, T. A. Purified Lymphocyte Function-Associated Antigen-3 Binds to CD2 and Mediates Lymphocyte-T Adhesion. *J. Exp. Med.* **1987**, *165*, 677-692.
- (112) Groves, J. T.; Dustin, M. L. Supported Planar Bilayers in Studies on Immune Cell Adhesion and Communication. *J. Immunol. Methods* **2003**, *278*, 19-32.
- (113) Groves, J. T.; Boxer, S. G. Micropattern Formation in Supported Lipid Membranes. *Acc. Chem. Res.* **2002**, *35*, 149-157.
- (114) Kahya, N.; Scherfeld, D.; Bacia, K.; Poolman, B.; Schwille, P. Probing Lipid Mobility of Raft-Exhibiting Model Membranes by Fluorescence Correlation Spectroscopy. *J. Biol. Chem.* **2003**, *278*, 28109-28115.
- (115) Forstner, M. B.; Yee, C. K.; Parikh, A. N.; Groves, J. T. Lipid Lateral Mobility and Membrane Phase Structure Modulation by Protein Binding. *J. Am. Chem. Soc.* **2006**, *128*, 15221-15227.
- (116) Dietrich, C.; Bagatolli, L. A.; Volovyk, Z. N.; Thompson, N. L.; Levi, M.; Jacobson, K.; Gratton, E. Lipid Rafts Reconstituted in Model Membranes. *Biophys. J.* **2001**, *80*, 1417-1428.
- (117) Perez, J. B.; Martinez, K. L.; Segura, J. M.; Vogel, H. Supported Cell-Membrane Sheets for Functional Fluorescence Imaging of Membrane Proteins. *Adv. Funct. Mater.* **2006**, *16*, 306-312.
- (118) Perez, J. B.; Segura, J. M.; Abankwa, D.; Piguet, J.; Martinez, K. L.; Vogel, H. Monitoring the Diffusion of Single Heterotrimeric G Proteins in Supported Cell-Membrane Sheets Reveals Their Partitioning into Microdomains. *J. Mol. Biol.* **2006**, *363*, 918-930.
- (119) Wilson, B. S.; Pfeiffer, J. R.; Raymond-Stintz, M. A.; Lidke, D.; Andrews, N.; Zhang, J.; Yin, W.; Steinberg, S.; Oliver, J. M. Exploring Membrane Domains Using Native Membrane Sheets and Transmission Electron Microscopy. In *Lipid Rafts*; McIntosh, T. J., Ed.; Humana Press: Totowa, NJ, 2007.

- (120) Frankel, D. J.; Pfeiffer, J. R.; Surviladze, Z.; Johnson, A. E.; Oliver, J. M.; Wilson, B. S.; Burns, A. R. Revealing the Topography of Cellular Membrane Domains by Combined Atomic Force Microscopy/Fluorescence Imaging. *Biophys. J.* **2006**, *90*, 2404-2413.
- (121) Wilson, B. S.; Steinberg, S. L.; Liederman, K.; Pfeiffer, J. R.; Surviladze, Z.; Zhang, J.; Samelson, L. E.; Yang, L.-h.; Kotula, P. G.; Oliver, J. M. Markers for Detergent-Resistant Lipid Rafts Occupy Distinct and Dynamic Domains in Native Membranes. *Mol. Biol. Cell* **2004**, *15*, 2580-2592.
- (122) Staneva, G.; Seigneuret, M.; Conjeaud, H.; Puff, N.; Angelova, M. I. Making a Tool of an Artifact: The Application of Photoinduced Lo Domains in Giant Unilamellar Vesicles to the Study of Lo/Ld Phase Spinodal Decomposition and Its Modulation by the Ganglioside GM1. *Langmuir* **2011**, *27*, 15074-15082.
- (123) Veatch, S. L.; Keller, S. L. Seeing Spots: Complex Phase Behavior in Simple Membranes. *Biochimica et Biophysica Acta (BBA) - Molecular Cell Research* **2005**, *1746*, 172-185.
- (124) Zhang, Y.; Liu, L.; Daneshfar, R.; Kitova, E. N.; Li, C.; Jia, F.; Cairo, C. W.; Klassen, J. S. Protein–Glycosphingolipid Interactions Revealed Using Catch-and-Release Mass Spectrometry. *Anal. Chem.* **2012**, *84*, 7618-7621.
- (125) Denisov, I. G.; Sligar, S. G. Nanodiscs in Membrane Biochemistry and Biophysics. *Chem. Rev.* **2017**, *117*, 4669-4713.
- (126) Popovic, K.; Holyoake, J.; Pomès, R.; Privé, G. G. Structure of Saposin a Lipoprotein Discs. *Proc. Natl. Acad. Sci. U. S. A.* **2012**, *109*, 2908–2912.
- (127) Li, J.; Richards, M. R.; Bagal, D.; Campuzano, I. D. G.; Kitova, E. N.; Xiong, Z. J.; Privé, G. G.; Klassen, J. S. Characterizing the Size and Composition of Saposin a Lipoprotein Picodiscs. *Anal. Chem.* **2016**, *88*, 9524–9531.
- (128) Li, J.; Fan, X.; Kitova, E. N.; Zou, C.; Cairo, C. W.; Eugenio, L.; Ng, K. K. S.; Xiong, Z. J.; Privé, G. G.; Klassen, J. S. Screening Glycolipids against Proteins in Vitro Using Picodiscs and Catch-and-Release Electrospray Ionization-Mass Spectrometry. *Anal. Chem.* **2016**, *88*, 4742–4750.
- (129) Han, L.; Morales, L. C.; Richards, M. R.; Kitova, E. N.; Sipione, S.; Klassen, J. S. Investigating the Influence of Membrane Composition on Protein–Glycolipid Binding Using Nanodiscs and Proxy Ligand Electrospray Ionization Mass Spectrometry. *Anal. Chem.* **2017**, *89*, 9330-9338.
- (130) Han, L.; Kitova, E. N.; Li, J.; Nikjah, S.; Lin, H.; Pluvinae, B.; Boraston, A. B.; Klassen, J. S. Protein–Glycolipid Interactions Studied in Vitro Using ESI-MS and Nanodiscs: Insights into the Mechanisms and Energetics of Binding. *Anal. Chem.* **2015**, *87*, 4888-4896.
- (131) Esmann, M.; Marsh, D.; Schwarzmann, G.; Sandhoff, K. Ganglioside-Protein Interactions: Spin-Label Electron Spin Resonance Studies with Sodium-Potassium ATPase Membranes. *Biochemistry* **1988**, *27*, 2398-2403.

- (132) Aubin, Y.; Ito, Y.; Paulson, J. C.; Prestegard, J. H. Structure and Dynamics of the Sialic Acid Moiety of GM3-Ganglioside at the Surface of a Magnetically Oriented Membrane. *Biochemistry* **1993**, *32*, 13405-13413.
- (133) Singh, D. M.; Shan, X.; Davis, J. H.; Jones, D.; Grant, C. W. M. Oligosaccharide Behavior of Complex Natural Glycosphingolipids in Multicomponent Model Membranes. *Biochemistry* **1995**, *34*, 451-463.
- (134) Rondelli, V.; Brocca, P.; Tranquilli, N.; Fragneto, G.; Del Favero, E.; Cantù, L. Building a Biomimetic Membrane for Neutron Reflectivity Investigation: Complexity, Asymmetry and Contrast. *Biophys. Chem.* **2017**, *229*, 135-141.
- (135) Rondelli, V.; Brocca, P.; Fragneto, G.; Daillant, J.; Tringali, C.; Cantu, L.; Del Favero, E. Membrane Restructuring Following in Situ Sialidase Digestion of Gangliosides: Complex Model Bilayers by Synchrotron Radiation Reflectivity. *Biochim. Biophys. Acta, Biomembr.* **2017**, *1859*, 845-851.
- (136) Terzaghi, A.; Tettamanti, G.; Masserini, M. Interaction of Glycosphingolipids and Glycoproteins: Thermotropic Properties of Model Membranes Containing GM1 Ganglioside and Glycophorin. *Biochemistry* **1993**, *32*, 9722-9725.
- (137) Blixt, O.; Head, S.; Mondala, T.; Scanlan, C.; Huflejt, M. E.; Alvarez, R.; Bryan, M. C.; Fazio, F.; Calarese, D.; Stevens, J. et al. Printed Covalent Glycan Array for Ligand Profiling of Diverse Glycan Binding Proteins. *Proc. Natl. Acad. Sci. U. S. A.* **2004**, *101*, 17033-17038.
- (138) DeMarco, M. L.; Woods, R. J. Atomic-Resolution Conformational Analysis of the GM3 Ganglioside in a Lipid Bilayer and Its Implications for Ganglioside-Protein Recognition at Membrane Surfaces. *Glycobiology* **2009**, *19*, 344-355.
- (139) DeMarco, M. L.; Woods, R. J.; Prestegard, J. H.; Tian, F. Presentation of Membrane-Anchored Glycosphingolipids Determined from Molecular Dynamics Simulations and NMR Paramagnetic Relaxation Rate Enhancement. *J. Am. Chem. Soc.* **2010**, *132*, 1334-1338.
- (140) DeMarco, M. L. Molecular Dynamics Simulations of Membrane- and Protein-Bound Glycolipids Using Glycam. In *Glycoinformatics*; Lütteke, T.; Frank, M., Eds.; Springer New York: New York, NY, 2015.
- (141) Patel, Dhilon S.; Park, S.; Wu, Emilia L.; Yeom, Min S.; Widmalm, G.; Kluda, Jeffery B.; Im, W. Influence of Ganglioside GM1 Concentration on Lipid Clustering and Membrane Properties and Curvature. *Biophys. J.* **2016**, *111*, 1987-1999.
- (142) Rissanen, S.; Grzybek, M.; Orłowski, A.; Róg, T.; Cramariuc, O.; Levental, I.; Eggeling, C.; Sezgin, E.; Vattulainen, I. Phase Partitioning of GM1 and Its Bodipy-Labeled Analog Determine Their Different Binding to Cholera Toxin. *Front. Physiol.* **2017**, *8*, doi: 10.3389/fphys.2017.00252.
- (143) Lopez, P. H. H.; Schnaar, R. L. Gangliosides in Cell Recognition and Membrane Protein Regulation. *Curr. Opin. Struct. Biol.* **2009**, *19*, 549-557.

- (144) Sheikh, K. A.; Sun, J.; Liu, Y.; Kawai, H.; Crawford, T. O.; Proia, R. L.; Griffin, J. W.; Schnaar, R. L. Mice Lacking Complex Gangliosides Develop Wallerian Degeneration and Myelination Defects. *Proc. Natl. Acad. Sci. U. S. A.* **1999**, *96*, 7532-7537.
- (145) Takamiya, K.; Yamamoto, A.; Furukawa, K.; Yamashiro, S.; Shin, M.; Okada, M.; Fukumoto, S.; Haraguchi, M.; Takeda, N.; Fujimura, K. et al. Mice with Disrupted GM2/GD2 Synthase Gene Lack Complex Gangliosides but Exhibit Only Subtle Defects in Their Nervous System. *Proc. Natl. Acad. Sci. U. S. A.* **1996**, *93*, 10662-10667.
- (146) Yamashita, T.; Wu, Y.-P.; Sandhoff, R.; Werth, N.; Mizukami, H.; Ellis, J. M.; Dupree, J. L.; Geyer, R.; Sandhoff, K.; Proia, R. L. Interruption of Ganglioside Synthesis Produces Central Nervous System Degeneration and Altered Axon–Glial Interactions. *Proc. Natl. Acad. Sci. U. S. A.* **2005**, *102*, 2725-2730.
- (147) Schengrund, C.-L. Gangliosides: Glycosphingolipids Essential for Normal Neural Development and Function. *Trends Biochem. Sci.* **2015**, *40*, 397-406.
- (148) Kushi, Y.; Shimizu, M.; Watanabe, K.; Kasama, T.; Watarai, S.; Ariga, T.; Handa, S. Characterization of Blood Group ABO(H)-Active Gangliosides in Type Ab Erythrocytes and Structural Analysis of Type a-Active Ganglioside Variants in Type a Human Erythrocytes. *Biochim. Biophys. Acta, Gen. Subj.* **2001**, *1525*, 58-69.
- (149) Cohen, M.; Hurtado-Ziola, N.; Varki, A. ABO Blood Group Glycans Modulate Sialic Acid Recognition on Erythrocytes. *Blood* **2009**, *114*, 3668-3676.
- (150) Müthing, J.; Spanbroek, R.; Peter-Katalinić, J.; Hanisch, F.-G.; Hanski, C.; Hasegawa, A.; Unland, F.; Lehmann, J.; Tschesche, H.; Egge, H. Isolation and Structural Characterization of Fucosylated Gangliosides with Linear Poly-N-Acetyllactosaminyl Chains from Human Granulocytes. *Glycobiology* **1996**, *6*, 147-156.
- (151) Nimrichter, L.; Burdick, M. M.; Aoki, K.; Laroy, W.; Fierro, M. A.; Hudson, S. A.; Von Seggern, C. E.; Cotter, R. J.; Bochner, B. S.; Tiemeyer, M. et al. E-Selectin Receptors on Human Leukocytes. *Blood* **2008**, *112*, 3744-3752.
- (152) Rinaldi, S.; Brennan, K. M.; Goodyear, C. S.; O’Leary, C.; Schiavo, G.; Crocker, P. R.; Willison, H. J. Analysis of Lectin Binding to Glycolipid Complexes Using Combinatorial Glycoarrays. *Glycobiology* **2009**, *19*, 789-796.
- (153) Miljan, E. A.; Meillet, E. J.; Mania-Farnell, B.; George, D.; Yamamoto, H.; Simon, H.-G.; Bremer, E. G. Interaction of the Extracellular Domain of the Epidermal Growth Factor Receptor with Gangliosides. *J. Biol. Chem.* **2002**, *277*, 10108-10113.
- (154) Groux-Degroote, S.; Rodríguez-Walker, M.; Dewald, J. H.; Daniotti, J. L.; Delannoy, P. Gangliosides in Cancer Cell Signaling. In *Progress in Molecular Biology and Translational Science*; Schnaar, R. L.; Lopez, P. H. H., Eds.; Academic Press, 2018.
- (155) Thompson, L. K.; Horowitz, P.; Bentley, K.; Thomas, D.; Alderete, J.; Klebe, R. Localization of the Ganglioside-Binding Site of Fibronectin. *J. Biol. Chem.* **1986**, *261*, 5209-5214.

- (156) Taïeb, N.; Maresca, M.; Guo, X.-J.; Garmy, N.; Fantini, J.; Yah, N. The First Extracellular Domain of the Tumour Stem Cell Marker Cd133 Contains an Antigenic Ganglioside-Binding Motif. *Cancer Lett.* **2009**, *278*, 164-173.
- (157) Kabayama, K.; Sato, T.; Saito, K.; Loberto, N.; Prinetti, A.; Sonnino, S.; Kinjo, M.; Igarashi, Y.; Inokuchi, J.-i. Dissociation of the Insulin Receptor and Caveolin-1 Complex by Ganglioside GM3 in the State of Insulin Resistance. *Proc. Natl. Acad. Sci. U. S. A.* **2007**, *104*, 13678-13683.
- (158) Parton, R. G.; Hanzal-Bayer, M.; Hancock, J. F. Biogenesis of Caveolae: A Structural Model for Caveolin-Induced Domain Formation. *J. Cell Sci.* **2006**, *119*, 787-796.
- (159) Parton, R. G. Ultrastructural Localization of Gangliosides; GM1 Is Concentrated in Caveolae. *J. Histochem. Cytochem.* **1994**, *42*, 155-166.
- (160) Fra, A. M.; Masserini, M.; Palestini, P.; Sonnino, S.; Simons, K. A Photo-Reactive Derivative of Ganglioside GM1 Specifically Cross-Links VIP21-Caveolin on the Cell Surface. *FEBS Lett.* **1995**, *375*, 11-14.
- (161) Chinnapen, D. J.-F.; Hsieh, W.-T.; te Welscher, Y. M.; Saslowsky, D. E.; Kaoutzani, L.; Brandsma, E.; D'Auria, L.; Park, H.; Wagner, J. S.; Drake, K. R. Lipid Sorting by Ceramide Structure from Plasma Membrane to ER for the Cholera Toxin Receptor Ganglioside GM1. *Dev. Cell* **2012**, *23*, 573-586.
- (162) Haberkant, P.; Raijmakers, R.; Wildwater, M.; Sachsenheimer, T.; Brügger, B.; Maeda, K.; Houweling, M.; Gavin, A. C.; Schultz, C.; van Meer, G. In Vivo Profiling and Visualization of Cellular Protein-Lipid Interactions Using Bifunctional Fatty Acids. *Angew. Chem., Int. Ed.* **2013**, *52*, 4033-4038.
- (163) Fishman, P. H. Role of Membrane Gangliosides in the Binding and Action of Bacterial Toxins. *J. Membr. Biol.* **1982**, *69*, 85-97.
- (164) Turton, K.; Chaddock, J. A.; Acharya, K. R. Botulinum and Tetanus Neurotoxins: Structure, Function and Therapeutic Utility. *Trends Biochem. Sci.* **2002**, *27*, 552-558.
- (165) Mizuno, H.; Abe, M.; Dedecker, P.; Makino, A.; Rocha, S.; Ohno-Iwashita, Y.; Hofkens, J.; Kobayashi, T.; Miyawaki, A. Fluorescent Probes for Superresolution Imaging of Lipid Domains on the Plasma Membrane. *Chem. Sci.* **2011**, *2*, 1548-1553.
- (166) Wands, A. M.; Fujita, A.; McCombs, J. E.; Cervin, J.; Dedic, B.; Rodriguez, A. C.; Nischan, N.; Bond, M. R.; Mettlen, M.; Trudgian, D. C. et al. Fucosylation and Protein Glycosylation Create Functional Receptors for Cholera Toxin. *eLife* **2015**, *4*, e09545.
- (167) Matsubara, T.; Ishikawa, D.; Taki, T.; Okahata, Y.; Sato, T. Selection of Ganglioside GM1-Binding Peptides by Using a Phage Library. *FEBS Lett.* **1999**, *456*, 253-256.
- (168) Steinert, S.; Lee, E.; Tresset, G.; Zhang, D.; Hortsch, R.; Wetzel, R.; Hebbar, S.; Sundram, J. R.; Kesavapany, S.; Boschke, E. et al. A Fluorescent Glycolipid-Binding Peptide Probe Traces Cholesterol Dependent Microdomain-Derived Trafficking Pathways. *PLoS One* **2008**, *3*, e2933.

- (169) Matsubara, T.; Otani, R.; Yamashita, M.; Maeno, H.; Nodono, H.; Sato, T. Selective Intracellular Delivery of Ganglioside GM3-Binding Peptide through Caveolae/Raft-Mediated Endocytosis. *Biomacromolecules* **2017**, *18*, 355-362.
- (170) Edidin, M. The State of Lipid Rafts: From Model Membranes to Cells. *Annu. Rev. Biophys. Biomol. Struct.* **2003**, *32*, 257-283.
- (171) Owen, D. M.; Magenau, A.; Williamson, D.; Gaus, K. The Lipid Raft Hypothesis Revisited – New Insights on Raft Composition and Function from Super-Resolution Fluorescence Microscopy. *BioEssays* **2012**, *34*, 739-747.
- (172) Simons, K.; Ikonen, E. Functional Rafts in Cell Membranes. *Nature* **1997**, *387*, 569-572.
- (173) Lingwood, D.; Simons, K. Lipid Rafts as a Membrane-Organizing Principle. *Science* **2010**, *327*, 46-50.
- (174) Lichtenberg, D.; Goñi, F. M.; Heerklotz, H. Detergent-Resistant Membranes Should Not Be Identified with Membrane Rafts. *Trends Biochem. Sci.* **2005**, *30*, 430-436.
- (175) Hoekstra, D.; Maier, O.; van der Wouden, J. M.; Slimane, T. A.; van Ijzendoorn, S. C. D. Membrane Dynamics and Cell Polarity: The Role of Sphingolipids. *J. Lipid Res.* **2003**, *44*, 869-877.
- (176) Ekyalongo, R. C.; Nakayama, H.; Kina, K.; Kaga, N.; Iwabuchi, K. Organization and Functions of Glycolipid-Enriched Microdomains in Phagocytes. *Biochim. Biophys. Acta, Mol. Cell Biol. Lipids* **2015**, *1851*, 90-97.
- (177) Mattei, V.; Garofalo, T.; Misasi, R.; Gizzi, C.; Mascellino, M. T.; Dolo, V.; Pontieri, G. M.; Sorice, M.; Pavan, A. Association of Cellular Prion Protein with Gangliosides in Plasma Membrane Microdomains of Neural and Lymphocytic Cells. *Neurochem. Res.* **2002**, *27*, 743-749.
- (178) Togayachi, A.; Kozono, Y.; Ikehara, Y.; Ito, H.; Suzuki, N.; Tsunoda, Y.; Abe, S.; Sato, T.; Nakamura, K.; Suzuki, M. et al. Lack of Lacto/Neolacto-Glycolipids Enhances the Formation of Glycolipid-Enriched Microdomains, Facilitating B Cell Activation. *Proc. Natl. Acad. Sci. U. S. A.* **2010**, *107*, 11900-11905.
- (179) Pizzo, P.; Viola, A. Lymphocyte Lipid Rafts: Structure and Function. *Current Opinion in Immunology* **2003**, *15*, 255-260.
- (180) Cremesti, A. E.; Goni, F. M.; Kolesnick, R. Role of Sphingomyelinase and Ceramide in Modulating Rafts: Do Biophysical Properties Determine Biologic Outcome? *FEBS Lett.* **2002**, *531*, 47-53.
- (181) Panasiewicz, M.; Domek, H.; Hoser, G.; Kawalec, M.; Pacuszka, T. Structure of the Ceramide Moiety of GM1 Ganglioside Determines Its Occurrence in Different Detergent-Resistant Membrane Domains in HL-60 Cells. *Biochemistry* **2003**, *42*, 6608-6619.
- (182) London, E. Insights into Lipid Raft Structure and Formation from Experiments in Model Membranes. *Curr. Opin. Struct. Biol.* **2002**, *12*, 480-486.

- (183) Rietveld, A.; Simons, K. The Differential Miscibility of Lipids as the Basis for the Formation of Functional Membrane Rafts. *Biochim. Biophys. Acta, Rev. Biomembr.* **1998**, *1376*, 467-479.
- (184) Sonnino, S.; Prinetti, A.; Mauri, L.; Chigorno, V.; Tettamanti, G. Dynamic and Structural Properties of Sphingolipids as Driving Forces for the Formation of Membrane Domains. *Chem. Rev.* **2006**, *106*, 2111-2125.
- (185) Sonnino, S.; Mauri, L.; Chigorno, V.; Prinetti, A. Gangliosides as Components of Lipid Membrane Domains. *Glycobiology* **2007**, *17*, 1R-13R.
- (186) Brown, D.; London, E. Functions of Lipid Rafts in Biological Membranes. *Annu. Rev. Cell Dev. Biol.* **1998**, *14*, 111-136.
- (187) Hakomori, S.-i. The Glycosynapse. *Proc. Natl. Acad. Sci. U. S. A.* **2002**, *99*, 225-232.
- (188) Regina Todeschini, A.; Hakomori, S.-i. Functional Role of Glycosphingolipids and Gangliosides in Control of Cell Adhesion, Motility, and Growth, through Glycosynaptic Microdomains. *Biochim. Biophys. Acta, Gen. Subj.* **2008**, *1780*, 421-433.
- (189) Bucior, I.; Burger, M. M. Carbohydrate–Carbohydrate Interactions in Cell Recognition. *Curr. Opin. Struct. Biol.* **2004**, *14*, 631-637.
- (190) Parker, R. B.; Kohler, J. J. Regulation of Intracellular Signaling by Extracellular Glycan Remodeling. *ACS Chem. Biol.* **2010**, *5*, 35-46.
- (191) Sonnino, S.; Aureli, M.; Loberto, N.; Chigorno, V.; Prinetti, A. Fine Tuning of Cell Functions through Remodeling of Glycosphingolipids by Plasma Membrane-Associated Glycohydrolases. *FEBS Lett.* **2010**, *584*, 1914-1922.
- (192) Wolf, A. A.; Fujinaga, Y.; Lencer, W. I. Uncoupling of the Cholera Toxin-GM1 Ganglioside Receptor Complex from Endocytosis, Retrograde Golgi Trafficking, and Downstream Signal Transduction by Depletion of Membrane Cholesterol. *J. Biol. Chem.* **2002**, *277*, 16249-16256.
- (193) Ravindran, M. S.; Tanner, L. B.; Wenk, M. R. Sialic Acid Linkage in Glycosphingolipids Is a Molecular Correlate for Trafficking and Delivery of Extracellular Cargo. *Traffic* **2013**, *14*, 1182-1191.
- (194) Sano, R.; Annunziata, I.; Patterson, A.; Moshiach, S.; Gomero, E.; Opferman, J.; Forte, M.; d'Azzo, A. GM1-Ganglioside Accumulation at the Mitochondria-Associated ER Membranes Links ER Stress to Ca(2+)-Dependent Mitochondrial Apoptosis. *Mol. Cell* **2009**, *36*, 500-511.
- (195) Saslowsky, D. E.; te Welscher, Y. M.; Chinnapen, D. J.; Wagner, J. S.; Wan, J.; Kern, E.; Lencer, W. I. Ganglioside GM1-Mediated Transcytosis of Cholera Toxin Bypasses the Retrograde Pathway and Depends on the Structure of the Ceramide Domain. *J. Biol. Chem.* **2013**, *288*, 25804-25809.

- (196) Février, B.; Raposo, G. Exosomes: Endosomal-Derived Vesicles Shipping Extracellular Messages. *Curr. Opin. Cell Biol.* **2004**, *16*, 415-421.
- (197) Yuyama, K.; Yamamoto, N.; Yanagisawa, K. Accelerated Release of Exosome-Associated GM1 Ganglioside (GM1) by Endocytic Pathway Abnormality: Another Putative Pathway for GM1-Induced Amyloid Fibril Formation. *J. Neurochem.* **2008**, *105*, 217-224.
- (198) Skotland, T.; Sandvig, K.; Llorente, A. Lipids in Exosomes: Current Knowledge and the Way Forward. *Prog. Lipid Res.* **2017**, *66*, 30-41.
- (199) Llorente, A.; Skotland, T.; Sylvänne, T.; Kauhanen, D.; Róg, T.; Orłowski, A.; Vattulainen, I.; Ekroos, K.; Sandvig, K. Molecular Lipidomics of Exosomes Released by Pc-3 Prostate Cancer Cells. *Biochim. Biophys. Acta, Mol. Cell Biol. Lipids* **2013**, *1831*, 1302-1309.
- (200) Phuyal, S.; Hessvik, N. P.; Skotland, T.; Sandvig, K.; Llorente, A. Regulation of Exosome Release by Glycosphingolipids and Flotillins. *FEBS J.* **2014**, *281*, 2214-2227.
- (201) Ng, B. G.; Freeze, H. H. Human Genetic Disorders Involving Glycosylphosphatidylinositol (GPI) Anchors and Glycosphingolipids (GSL). *J. Inherited Metab. Dis.* **2015**, *38*, 171-178.
- (202) Xu, Y. H.; Barnes, S.; Sun, Y.; Grabowski, G. A. Multi-System Disorders of Glycosphingolipid and Ganglioside Metabolism. *J. Lipid Res.* **2010**, *51*, 1643-1675.
- (203) Dube, D. H.; Bertozzi, C. R. Glycans in Cancer and Inflammation. Potential for Therapeutics and Diagnostics. *Nat. Rev. Drug Discovery* **2005**, *4*, 477-488.
- (204) Bitton, R. J.; Guthmann, M. D.; Gabri, M. R.; Carnero, A. J.; Alonso, D. F.; Fainboim, L.; Gomez, D. E. Cancer Vaccines: An Update with Special Focus on Ganglioside Antigens. *Oncol. Rep.* **2002**, *9*, 267-276.
- (205) Ahmed, M.; Cheung, N.-K. V. Engineering Anti-GD2 Monoclonal Antibodies for Cancer Immunotherapy. *FEBS Lett.* **2014**, *588*, 288-297.
- (206) Veillon, L.; Go, S.; Matsuyama, W.; Suzuki, A.; Nagasaki, M.; Yatomi, Y.; Inokuchi, J.-i. Identification of Ganglioside GM3 Molecular Species in Human Serum Associated with Risk Factors of Metabolic Syndrome. *PLoS One* **2015**, *10*, e0129645.
- (207) Prinetti, A.; Loberto, N.; Chigorno, V.; Sonnino, S. Glycosphingolipid Behaviour in Complex Membranes. *Biochim. Biophys. Acta, Biomembr.* **2009**, *1788*, 184-193.
- (208) Brunetti-Pierri, N.; Scaglia, F. GM1 Gangliosidosis: Review of Clinical, Molecular, and Therapeutic Aspects. *Mol. Genet. Metab.* **2008**, *94*, 391-396.
- (209) Seyrantepe, V.; Poupetova, H.; Froissart, R.; Zabet, M.-T.; Maire, I.; Pshezhetsky, A. V. Molecular Pathology of Neu1 Gene in Sialidosis. *Human Mutation* **2003**, *22*, 343-352.
- (210) Miyagi, T.; Takahashi, K.; Yamamoto, K.; Shiozaki, K.; Yamaguchi, K. Biological and Pathological Roles of Ganglioside Sialidases. In *Progress in Molecular Biology and Translational Science*; Academic Press, 2018.

- (211) Beck, M. New Therapeutic Options for Lysosomal Storage Disorders: Enzyme Replacement, Small Molecules and Gene Therapy. *Hum. Genet.* **2007**, *121*, 1-22.
- (212) Benito, J. M.; García Fernández, J. M.; Mellet, C. O. Pharmacological Chaperone Therapy for Gaucher Disease: A Patent Review. *Expert Opin. Ther. Pat.* **2011**, *21*, 885-903.
- (213) Boyd, R. E.; Lee, G.; Rybczynski, P.; Benjamin, E. R.; Khanna, R.; Wustman, B. A.; Valenzano, K. J. Pharmacological Chaperones as Therapeutics for Lysosomal Storage Diseases. *J. Med. Chem.* **2013**, *56*, 2705-2725.
- (214) Parenti, G.; Andria, G.; Valenzano, K. J. Pharmacological Chaperone Therapy: Preclinical Development, Clinical Translation, and Prospects for the Treatment of Lysosomal Storage Disorders. *Mol. Ther.* **2015**, *23*, 1138-1148.
- (215) Butters, T. D. Pharmacotherapeutic Strategies Using Small Molecules for the Treatment of Glycolipid Lysosomal Storage Disorders. *Expert Opin. Pharmacother.* **2007**, *8*, 427-435.
- (216) Yuyama, K.; Sun, H.; Mitsutake, S.; Igarashi, Y. Sphingolipid-Modulated Exosome Secretion Promotes Clearance of Amyloid- β by Microglia. *J. Biol. Chem.* **2012**, *287*, 10977-10989.
- (217) Ando, H.; Ishida, H.; Kiso, M. Renewed Synthetic Approach to Gangliosides Exploiting Versatile and Powerful Synthetic Units. *Methods Enzymol.* **2010**, *478*, 521-540.
- (218) Paulick, M. G.; Bertozzi, C. R. The Glycosylphosphatidylinositol Anchor: A Complex Membrane-Anchoring Structure for Proteins. *Biochemistry* **2008**, *47*, 6991-7000.
- (219) Yu, S.; Guo, Z.; Johnson, C.; Gu, G.; Wu, Q. Recent Progress in Synthetic and Biological Studies of GPI Anchors and GPI-Anchored Proteins. *Curr. Opin. Chem. Biol.* **2013**, *17*, 1006-1013.
- (220) Johnson, C.; Guo, Z. Synthesis of Glycosylphosphatidylinositol Anchors. In *Glycochemical Synthesis: Strategies and Applications*, 2016.
- (221) Thomas, M. P.; Mills, S. J.; Potter, B. V. L. The "Other" Inositols and Their Phosphates: Synthesis, Biology, and Medicine (with Recent Advances in Myo-Inositol Chemistry). *Angew. Chem., Int. Ed.* **2016**, *55*, 1614-1650.
- (222) Vankar, Y. D.; Schmidt, R. R. Chemistry of Glycosphingolipids-Carbohydrate Molecules of Biological Significance. *Chem. Soc. Rev.* **2000**, *29*, 201-216.
- (223) Ndakala, A. J.; Hashemzadeh, M.; So, R. C.; Howell, A. R. Synthesis of D-E Rythro-Dihydrospingosine and D-X Ylo-Phytosphingosine from a Serine-Derived 1, 5-Dioxaspiro [3.2] Hexane Template. *Org. Lett.* **2002**, *4*, 1719-1722.
- (224) So, R. C.; Ndonge, R.; Izmirian, D. P.; Richardson, S. K.; Guerrero, R. L.; Howell, A. R. Straightforward Synthesis of Sphingamines Via a Serine-Derived Weinreb Amide. *J. Org. Chem.* **2004**, *69*, 3233-3235.

- (225) Cook, G. R.; Pararajasingham, K. Stereoselective Synthesis of D-Erythro-and L-Threo-Sphinganine Via Palladium-Catalyzed Equilibration and Suzuki Coupling. *Tetrahedron Lett.* **2002**, *43*, 9027-9029.
- (226) Siciliano, C.; Barattucci, A.; Bonaccorsi, P.; Di Gioia, M. L.; Leggio, A.; Minuti, L.; Romio, E.; Temperini, A. Synthesis of D-Erythro-Sphinganine through Serine-Derived α -Amino Epoxides. *J. Org. Chem.* **2014**, *79*, 5320-5326.
- (227) Azuma, H.; Tamagaki, S.; Ogino, K. Stereospecific Total Syntheses of Sphingosine and Its Analogues from L-Serine. *J. Org. Chem.* **2000**, *65*, 3538-3541.
- (228) Chun, J.; Byun, H.-S.; Bittman, R. First Asymmetric Synthesis of 6-Hydroxy-4-Sphingenine-Containing Ceramides. Use of Chiral Propargylic Alcohols to Prepare a Lipid Found in Human Skin. *J. Org. Chem.* **2003**, *68*, 348-354.
- (229) Mori, K.; Masuda, Y. Synthesis and Stereochemistry of Ceramide B,(2S, 3R, 4E, 6R)-N-(30-Hydroxytriacontanoyl)-6-Hydroxy-4-Sphingenine, a New Ceramide in Human Epidermis. *Tetrahedron Lett.* **2003**, *44*, 9197-9200.
- (230) Masuda, Y.; Mori, K. Synthesis and Absolute Configuration of 6-Hydroxylated New Ceramides in Human Skin, Ceramides B, 4, 7 and 8. *Eur. J. Org. Chem.* **2005**, *2005*, 4789-4800.
- (231) Yadav, J. S.; Geetha, V.; Krishnam Raju, A.; Gnaneshwar, D.; Chandrasekhar, S. The First Total Synthesis of the 6-Hydroxy-4E-Sphingenes. *Tetrahedron Lett.* **2003**, *44*, 2983-2985.
- (232) Chun, J.; Byun, H.-S.; Arthur, G.; Bittman, R. Synthesis and Growth Inhibitory Activity of Chiral 5-Hydroxy-2-N-Acyl-(3 E)-Sphingenes: Ceramides with an Unusual Sphingoid Backbone. *J. Org. Chem.* **2003**, *68*, 355-359.
- (233) Lombardo, M.; Capdevila, M. G.; Pasi, F.; Trombini, C. An Efficient High-Yield Synthesis of D-R Ibo-Phytosphingosine. *Org. Lett.* **2006**, *8*, 3303-3305.
- (234) Kokatla, H. P.; Sagar, R.; Vankar, Y. D. Stereoselective Synthesis of Safingol and Its Natural Stereoisomer from D-Glycals. *Tetrahedron Lett.* **2008**, *49*, 4728-4730.
- (235) Das, P.; Kundooru, S.; Shaw, A. K. 'Chiron' approach to Stereoselective Synthesis of Sphinganine and Unnatural Safingol, an Antineoplastic and Antipsoriatic Agent. *RSC Advances* **2016**, *6*, 14505-14511.
- (236) Plettenburg, O.; Bodmer-Narkevitch, V.; Wong, C.-H. Synthesis of α -Galactosyl Ceramide, a Potent Immunostimulatory Agent. *J. Org. Chem.* **2002**, *67*, 4559-4564.
- (237) Luo, S.-Y.; Thopate, S. R.; Hsu, C.-Y.; Hung, S.-C. Synthesis of D-Ribo-C 18-Phytosphingosine from D-Glucosamine Via the D-Allosamine Derivatives as Key Intermediates. *Tetrahedron Lett.* **2002**, *43*, 4889-4892.

- (238) Luo, S.-Y.; Kulkarni, S. S.; Chou, C.-H.; Liao, W.-M.; Hung, S.-C. A Concise Synthesis of Tetrahydroxy-Lcb, α -Galactosyl Ceramide, and 1, 4-Dideoxy-1, 4-Imino-L-Ribitol Via D-Allosamines as Key Building Blocks. *J. Org. Chem.* **2006**, *71*, 1226-1229.
- (239) Ko, J.; Molinski, T. F. D-Glucosamine-Derived Synthons for Assembly of L-Threo-Sphingoid Bases. Total Synthesis of Rhizochalinin C. *J. Org. Chem.* **2013**, *78*, 498-505.
- (240) Pilgrim, W.; Murphy, P. V. α -Glycosphingolipids Via Chelation-Induced Anomerization of O-and S-Glucuronic and Galacturonic Acid Derivatives. *Org. Lett.* **2009**, *11*, 939-942.
- (241) Lin, C.-C.; Fan, G.-T.; Fang, J.-M. A Concise Route to Phytosphingosine from Lyxose. *Tetrahedron Lett.* **2003**, *44*, 5281-5283.
- (242) Chun, J. S.; Hong, S. M.; Jeon, T. H.; Park, S. J.; Son, H. P.; Jung, J. M.; Choi, Y. J.; Kim, I. S.; Jung, Y. H. Divergent Total Synthesis of D-Ribo-Phytosphingosine and L-Ribo-Phytosphingosine from D-Ribose. *Tetrahedron* **2016**, *72*, 8550-8556.
- (243) Cai, Y.; Ling, C.-C.; Bundle, D. R. Efficient Synthesis of D-Xylo and D-Ribo-Phytosphingosines from Methyl 2-Amino-2-Deoxy- β -D-Hexopyranosides. *Carbohydr. Res.* **2009**, *344*, 2120-2126.
- (244) Sharma, A.; Gamre, S.; Chattopadhyay, S. An Asymmetric Synthesis of (2S, 3S)-Safingol. *Tetrahedron Lett.* **2007**, *48*, 633-634.
- (245) Ait-Youcef, R.; Moreau, X.; Greck, C. Asymmetric Synthesis of Sphinganine and Clavaminol H. *J. Org. Chem.* **2010**, *75*, 5312-5315.
- (246) Calder, E. D.; Zaed, A. M.; Sutherland, A. Preparation of Anti-Vicinal Amino Alcohols: Asymmetric Synthesis of D-Erythro-Sphinganine,(+)-Spisulosine, and D-Ribo-Phytosphingosine. *J. Org. Chem.* **2013**, *78*, 7223-7233.
- (247) Vo-Hoang, Y.; Micouin, L.; Ronet, C.; Gachelin, G.; Bonin, M. Total Enantioselective Synthesis and in Vivo Biological Evaluation of a Novel Fluorescent BODIPY α -Galactosylceramide. *ChemBioChem* **2003**, *4*, 27-33.
- (248) Nakamura, T.; Shiozaki, M. Stereoselective Synthesis of D-Erythro-Sphingosine and L-Lyxo-Phytosphingosine. *Tetrahedron* **2001**, *57*, 9087-9092.
- (249) Lee, H. K.; Kim, E.-K.; Pak, C. S. Facile Transformation of 2-Azetidinones to Unsaturated Ketones: Application to the Formal Synthesis of Sphingosine and Phytosphingosine. *Tetrahedron Lett.* **2002**, *43*, 9641-9644.
- (250) Séguin, C.; Ferreira, F.; Botuha, C.; Chemla, F.; Pérez-Luna, A. High-Yielding Synthesis of Sphingoid-Type Bases. *J. Org. Chem.* **2009**, *74*, 6986-6992.
- (251) Karjalainen, O. K.; Koskinen, A. M. Diastereoselective Synthesis of Vicinal Amino Alcohols. *Org. Biomol. Chem.* **2012**, *10*, 4311-4326.
- (252) Rao, M. V.; Rao, B. V. An Efficient Synthesis of N-Boc-(2S, 3S)-3-Hydroxy-2-Phenyl Piperidine and N-Boc-Safingol. *Tetrahedron Lett.* **2012**, *53*, 5993-5995.

- (253) Mukherjee, M.; Zhou, Y.; Gupta, A. K.; Guan, Y.; Wulff, W. D. A General Synthesis of Sphinganines through Multicomponent Catalytic Asymmetric Aziridination. *Eur. J. Org. Chem.* **2014**, *2014*, 1386-1390.
- (254) Zhou, Y.; Mukherjee, M.; Gupta, A. K.; Wulff, W. D. Multicomponent Cis-and Trans-Aziridinaton in the Syntheses of All Four Stereoisomers of Sphinganine. *Org. Lett.* **2017**, *19*, 2230-2233.
- (255) Olofsson, B.; Somfai, P. Divergent Synthesis of D-Erythro-Sphingosine, L-Threo-Sphingosine, and Their Regioisomers. *J. Org. Chem.* **2003**, *68*, 2514-2517.
- (256) Torssell, S.; Somfai, P. A Practical Synthesis of D-Erythro-Sphingosine Using a Cross-Metathesis Approach. *Org. Biomol. Chem.* **2004**, *2*, 1643-1646.
- (257) Gao, Y.; He, X.; Ding, F.; Zhang, Y. Recent Progress in Chemical Syntheses of Sphingosines and Phytosphingosines. *Synthesis* **2016**, *48*, 4017-4037.
- (258) Liao, J.; Tao, J.; Lin, G.; Liu, D. Chemistry and Biology of Sphingolipids. *Tetrahedron* **2005**, *61*, 4715-4733.
- (259) Howell, A. R.; So, R. C.; Richardson, S. K. Approaches to the Preparation of Sphinganines. *Tetrahedron* **2004**, *60*, 11327-11347.
- (260) Koskinen, P. M.; Koskinen, A. M. Sphingosine, an Enigmatic Lipid: A Review of Recent Literature Syntheses. *Synthesis* **1998**, *1998*, 1075-1091.
- (261) Ha, H.-J.; Hong, M. C.; Ko, S. W.; Kim, Y. W.; Lee, W. K.; Park, J. Synthesis of Constrained Ceramide Analogs and Their Potent Antileukemic Activities. *Bioorg. Med. Chem. Lett.* **2006**, *16*, 1880-1883.
- (262) Hillaert, U.; Van Calenbergh, S. Synthesis of a Versatile (S)-3-(Hydroxymethyl) Butane-1, 2, 4-Triol Building Block and Its Application for the Stereoselective Synthesis of N-Homoceramides. *Org. Lett.* **2005**, *7*, 5769-5772.
- (263) Opálka, L.; Kováčik, A.; Sochorova, M.; Roh, J.; Kuneš, J.; Lenčo, J.; Vávrová, K. Scalable Synthesis of Human Ultralong Chain Ceramides. *Org. Lett.* **2015**, *17*, 5456-5459.
- (264) Wisse, P.; de Geus, M. A.; Cross, G.; van den Nieuwendijk, A. M.; van Rooden, E. J.; van den Berg, R. J.; Aerts, J. M.; van der Marel, G. A.; Codée, J. D.; Overkleeft, H. S. Synthesis of 6-Hydroxysphingosine and α -Hydroxy Ceramide Using a Cross-Metathesis Strategy. *J. Org. Chem.* **2015**, *80*, 7258-7265.
- (265) Yamamoto, T.; Hasegawa, H.; Hakogi, T.; Katsumura, S. Versatile Synthetic Method for Sphingolipids and Functionalized Sphingosine Derivatives Via Olefin Cross Metathesis. *Org. Lett.* **2006**, *8*, 5569-5572.
- (266) Rai, A. N.; Basu, A. Sphingolipid Synthesis Via Olefin Cross Metathesis: Preparation of a Differentially Protected Building Block and Application to the Synthesis of D-Erythro-Ceramide. *Org. Lett.* **2004**, *6*, 2861-2863.

- (267) Kovacik, A.; Opálka, L.; Silarova, M.; Roh, J.; Vavrova, K. Synthesis of 6-Hydroxyceramide Using Ruthenium-Catalyzed Hydrosilylation-Protodesilylation. Unexpected Formation of a Long Periodicity Lamellar Phase in Skin Lipid Membranes. *RSC Advances* **2016**, *6*, 73343-73350.
- (268) Iga, S.; Iga, D. P.; Nicolescu, A.; Florentina, D.; Gitman, S.; Cîmpeanu, G. Preparation of Ceramide and Sphingosine by Chemical and Biochemical Methods—an Instrument for the Evaluation of Compatibility between Sphinganine and Fatty Acids. *Rom. Biotechnol. Lett.* **2011**, *16*, 6611-6617.
- (269) Tan, R. X.; Chen, J. H. The Cerebrosides. *Nat. Prod. Rep.* **2003**, *20*, 509-534.
- (270) Compostella, F.; Panza, L.; Ronchetti, F. The Mammalian Sulfated Glycolipid Sulfatide: Synthesis and Biological Implications. *C. R. Chim.* **2012**, *15*, 37-45.
- (271) Xing, G.-W.; Wu, D.; Poles, M. A.; Horowitz, A.; Tsuji, M.; Ho, D. D.; Wong, C.-H. Synthesis and Human NKT Cell Stimulating Properties of 3-O-Sulfo- α/β -Galactosylceramides. *Bioorg. Med. Chem.* **2005**, *13*, 2907-2916.
- (272) Modica, E.; Compostella, F.; Colombo, D.; Franchini, L.; Cavallari, M.; Mori, L.; De Libero, G.; Panza, L.; Ronchetti, F. Stereoselective Synthesis and Immunogenic Activity of the C-Analogue of Sulfatide. *Org. Lett.* **2006**, *8*, 3255-3258.
- (273) Morales-Serna, J. A.; Boutureira, O.; Diaz, Y.; Matheu, M. I.; Castellón, S. Highly Efficient and Stereoselective Synthesis of β -Glycolipids. *Org. Biomol. Chem.* **2008**, *6*, 443-446.
- (274) Morales-Serna, J. A.; Díaz, Y.; Matheu, M. I.; Castellón, S. Stannyl Ceramides as Efficient Acceptors for Synthesising β -Galactosyl Ceramides. *Org. Biomol. Chem.* **2008**, *6*, 3831-3836.
- (275) Gorantla, J. N.; Lankalapalli, R. S. Synthesis of β -C-Galactosyl Ceramide and Its New Aza Variant Via the Horner–Wadsworth–Emmons Reaction. *J. Org. Chem.* **2014**, *79*, 5193-5200.
- (276) Chaulagain, M. R.; Postema, M. H.; Valeriote, F.; Pietraszkewicz, H. Synthesis and Anti-Tumor Activity of β -C-Glycoside Analogs of the Immunostimulant KRN7000. *Tetrahedron Lett.* **2004**, *45*, 7791-7794.
- (277) D'Angelo, K. A.; Taylor, M. S. Borinic Acid-Catalyzed Stereo- and Site-Selective Synthesis of β -Glycosylceramides. *Chem. Comm.* **2017**, *53*, 5978-5980.
- (278) Thota, V. N.; Brahmaiah, M.; Kulkarni, S. S. Synthesis of a C-Glycoside Analogue of β -Galactosyl Ceramide, a Potential HIV-1 Entry Inhibitor. *J. Org. Chem.* **2013**, *78*, 12082-12089.
- (279) LaBell, R. Y.; Jacobsen, N. E.; Gervay-Hague, J.; O'Brien, D. F. Synthesis of Novel Glycolipids That Bind HIV-1 Gp120. *Bioconjugate Chem.* **2002**, *13*, 143-149.
- (280) Natori, T.; Koezuka, Y.; Higa, T. Agelasphins, Novel α -Galactosylceramides from the Marine Sponge *Agelas Mauritanus*. *Tetrahedron Lett.* **1993**, *34*, 5591-5592.

- (281) Natori, T.; Morita, M.; Akimoto, K.; Koezuka, Y. Agelasphins, Novel Antitumor and Immunostimulatory Cerebrosides from the Marine Sponge *Agelas Mauritanus*. *Tetrahedron* **1994**, *50*, 2771-2784.
- (282) Akimoto, K.; Natori, T.; Morita, M. Synthesis and Stereochemistry of Agelasphin-9b. *Tetrahedron Lett.* **1993**, *34*, 5593-5596.
- (283) Banchet-Cadeddu, A.; Hénon, E.; Dauchez, M.; Renault, J.-H.; Monneaux, F.; Haudrechy, A. The Stimulating Adventure of KRN 7000. *Org. Biomol. Chem.* **2011**, *9*, 3080-3104.
- (284) Tashiro, T. Structure-Activity Relationship Studies of Novel Glycosphingolipids That Stimulate Natural Killer T-Cells. *Biosci., Biotechnol., Biochem.* **2012**, *76*, 1055-1067.
- (285) Kim, S.; Song, S.; Lee, T.; Jung, S.; Kim, D. Practical Synthesis of KRN7000 from Phytosphingosine. *Synthesis* **2004**, *2004*, 847-850.
- (286) Khaja, S. D.; Kumar, V.; Ahmad, M.; Xue, J.; Matta, K. L. Novel Galactosyl Donor with 2-Naphthylmethyl (NAP) as the Non-Participating Group at C-2 Position: Efficient Synthesis of α -Galactosyl Ceramide. *Tetrahedron Lett.* **2010**, *51*, 4411-4414.
- (287) Boutureira, O.; Morales-Serna, J. A.; Díaz, Y.; Matheu, M. I.; Castellón, S. Direct and Efficient Glycosylation Protocol for Synthesizing α -Glycolipids: Application to the Synthesis of KRN7000. *Eur. J. Org. Chem.* **2008**, *2008*, 1851-1854.
- (288) Schombs, M.; Park, F. E.; Du, W.; Kulkarni, S. S.; Gervay-Hague, J. One-Pot Syntheses of Immunostimulatory Glycolipids. *J. Org. Chem.* **2010**, *75*, 4891-4898.
- (289) Du, W.; Kulkarni, S. S.; Gervay-Hague, J. Efficient, One-Pot Syntheses of Biologically Active [Small Alpha]-Linked Glycolipids. *Chem. Comm.* **2007**, *2007*, 2336-2338.
- (290) Lee, A.; Farrand, K. J.; Dickgreber, N.; Hayman, C. M.; Jürs, S.; Hermans, I. F.; Painter, G. F. Novel Synthesis of α -Galactosyl-Ceramides and Confirmation of Their Powerful NKT Cell Agonist Activity. *Carbohydr. Res.* **2006**, *341*, 2785-2798.
- (291) Veerapen, N.; Brigl, M.; Garg, S.; Cerundolo, V.; Cox, L. R.; Brenner, M. B.; Besra, G. S. Synthesis and Biological Activity of α -Galactosyl Ceramide KRN7000 and Galactosyl (A1 \rightarrow 2) Galactosyl Ceramide. *Bioorg. Med. Chem. Lett.* **2009**, *19*, 4288-4291.
- (292) Fan, G.-T.; Pan, Y.-s.; Lu, K.-C.; Cheng, Y.-P.; Lin, W.-C.; Lin, S.; Lin, C.-H.; Wong, C.-H.; Fang, J.-M.; Lin, C.-C. Synthesis of α -Galactosyl Ceramide and the Related Glycolipids for Evaluation of Their Activities on Mouse Splenocytes. *Tetrahedron* **2005**, *61*, 1855-1862.
- (293) Du, W.; Gervay-Hague, J. Efficient Synthesis of α -Galactosyl Ceramide Analogues Using Glycosyl Iodide Donors. *Org. Lett.* **2005**, *7*, 2063-2065.
- (294) Enders, D.; Terteryan, V.; Paleček, J. Asymmetric Synthesis of the α -D-Galactosyl Ceramide KRN7000 Via an Organocatalytic Aldol Reaction as Key Step. *Synthesis* **2010**, *2010*, 2979-2984.

- (295) Tsujimoto, T.; Ito, Y. Concise Syntheses of Immunostimulating Glycolipids, α -Galactosyl Ceramides. *Tetrahedron Lett.* **2007**, *48*, 5513-5516.
- (296) Graziani, A.; Passacantilli, P.; Piancatelli, G.; Tani, S. 2-Deoxy-Disaccharide Approach to Natural and Unnatural Glycosphingolipids Synthesis. *Tetrahedron: Asymmetry* **2000**, *11*, 3921-3937.
- (297) Yen, Y.-F.; Sawant, R.; Luo, S.-Y. Concise Syntheses of α -Galactosyl Ceramide, D-Ribo-Phytosphingosine, and Ceramide. *Synthesis* **2013**, *45*, 511-517.
- (298) Yen, Y.-F.; Kulkarni, S. S.; Chang, C.-W.; Luo, S.-Y. Concise Synthesis of α -Galactosyl Ceramide from D-Galactosyl Iodide and D-Lyxose. *Carbohydr. Res.* **2013**, *368*, 35-39.
- (299) Michieletti, M.; Bracci, A.; Compostella, F.; De Libero, G.; Mori, L.; Fallarini, S.; Lombardi, G.; Panza, L. Synthesis of α -Galactosyl Ceramide (KRN7000) and Analogues Thereof Via a Common Precursor and Their Preliminary Biological Assessment. *J. Org. Chem.* **2008**, *73*, 9192-9195.
- (300) Gervay-Hague, J.; Du, W.; Kulkarni, S. S.; Schombs, M. One-Pot Synthesis of Alpha/Beta-O-Glycolipids. US9586984 B2, Mar 7, 2017.
- (301) Zheng, M.; Ye, X.-S. Synthesis of N-Modified Ganglioside GM3 Derivatives. *Tetrahedron* **2012**, *68*, 1475-1482.
- (302) Fujikawa, K.; Imamura, A.; Ishida, H.; Kiso, M. Synthesis of a GM3 Ganglioside Analogue Carrying a Phytoceramide Moiety by Intramolecular Glycosylation as a Key Step. *Carbohydr. Res.* **2008**, *343*, 2729-2734.
- (303) Tietze, L. F.; Keim, H.; Janßen, C. O.; Tappertzhofen, C.; Olschimke, J. Synthesis of a Novel Ether-Bridged GM3-Lactone Analogue as a Target for an Antibody-Based Cancer Therapy. *Chem. - Eur. J.* **2000**, *6*, 2801-2808.
- (304) Rich, J. R.; Bundle, D. R. S-Linked Ganglioside Analogues for Use in Conjugate Vaccines. *Org. Lett.* **2004**, *6*, 897-900.
- (305) Rich, J. R.; Wakarchuk, W. W.; Bundle, D. R. Chemical and Chemoenzymatic Synthesis of S-Linked Ganglioside Analogues and Their Protein Conjugates for Use as Immunogens. *Chem. - Eur. J.* **2006**, *12*, 845-858.
- (306) Hossain, N.; Zapata, A.; Wilstermann, M.; Nilsson, U. J.; Magnusson, G. Synthesis of GD3-Lactam: A Potential Ligand for the Development of an Anti-Melanoma Vaccine. *Carbohydr. Res.* **2002**, *337*, 569-580.
- (307) Cumpstey, I. Intramolecular Aglycon Delivery. *Carbohydr. Res.* **2008**, *343*, 1553-1573.
- (308) Rico-Lattes, I.; Gouzy, M. F.; Andre-Barres, C.; Guidetti, B.; Lattes, A. Synthetic Neoglycolipids for Biological Applications: Correlation between Their Structures and Their Interactions with Membrane Proteins. *Biochimie* **1998**, *80*, 483-487.

- (309) Stoll, M. S.; Feizi, T. Preparation of Neoglycolipids for Structure and Function Assignments of Oligosaccharides. In *A Laboratory Guide to Glycoconjugate Analysis*; Jackson, P.; Gallagher, J. T., Eds.; Birkhäuser Basel: Basel, 1995.
- (310) Palma, A. S.; Feizi, T.; Childs, R. A.; Chai, W. G.; Liu, Y. The Neoglycolipid (NGL)-Based Oligosaccharide Microarray System Poised to Decipher the Meta-Glycome. *Curr. Opin. Chem. Biol.* **2014**, *18*, 87-94.
- (311) Otsubo, N.; Yamaguchi, M.; Ishida, H.; Kiso, M. The First, Efficient Synthesis of Novel Slex Neoglycolipids Containing N-Deacetylated and Lactamized Sialic Acid: Key Ligand Structures for Selectin Binding. *J. Carbohydr. Chem.* **2001**, *20*, 329-334.
- (312) Gege, C.; Geyer, A.; Schmidt, R. R. Synthesis and Molecular Tumbling Properties of Sialyl Lewis X and Derived Neoglycolipids. *Chem. - Eur. J.* **2002**, *8*, 2454-2463.
- (313) Chantaravong, C.; Ueki, A.; Ohyama, R.; Unga, J.; Nakamura, S.; Nakanishi, I.; Higuchi, Y.; Kawakami, S.; Ando, H.; Imamura, A. et al. Synthesis and Functional Characterization of Novel Sialyl Lewisx Mimic-Decorated Liposomes for E-Selectin-Mediated Targeting to Inflamed Endothelial Cells. *Molecular Pharmaceutics* **2017**, *14*, 1528-1537.
- (314) Harada, Y.; Murata, T.; Totani, K.; Kajimoto, T.; Masum, S. M.; Tamba, Y.; Yamazaki, M.; Usui, T. Design and Facile Synthesis of Neoglycolipids as Lactosylceramide Mimetics and Their Transformation into Glycoliposomes. *Biosci., Biotechnol., Biochem.* **2005**, *69*, 166-178.
- (315) Gur'eva, L. Y.; Budanova, U.; Sebyakin, Y. L. Synthesis of Neoglycolipids Based on D-Lactose. *Russ. J. Org. Chem.* **2009**, *45*, 173-177.
- (316) Gur'eva, L. Y.; Bol'sheborodova, A.; Sebyakin, Y. L. Design, Synthesis, and Properties of Neoglycolipids Based on Ethylene Glycoles Conjugated with Lactose as Components of Targeted Delivery Systems of Biologically Active Compounds. *Russ. J. Org. Chem.* **2012**, *48*, 1047-1054.
- (317) Faivre, V.; Rosilio, V.; Boullanger, P.; Almeida, L. M.; Baszkin, A. Fucosylated Neoglycolipids: Synthesis and Interaction with a Phospholipid. *Chem. Phys. Lipids* **2001**, *109*, 91-101.
- (318) Chen, N.; Xie, J. Synthesis of N-Oxyamide-Linked Neoglycolipids. *J. Org. Chem.* **2014**, *79*, 10716-10721.
- (319) Kalia, J.; Raines, R. T. Hydrolytic Stability of Hydrazones and Oximes. *Angew. Chem.* **2008**, *120*, 7633-7636.
- (320) Liu, Y.; Feizi, T.; Campanero-Rhodes, M. A.; Childs, R. A.; Zhang, Y.; Mulloy, B.; Evans, P. G.; Osborn, H. M.; Otto, D.; Crocker, P. R. Neoglycolipid Probes Prepared Via Oxime Ligation for Microarray Analysis of Oligosaccharide-Protein Interactions. *Chem. Biol.* **2007**, *14*, 847-859.

- (321) Chen, W.; Xia, C.; Cai, L.; Wang, P. G. Efficient Synthesis of Galactosylceramide Analogues for iNKT Cell Stimulation. *Bioorg. Med. Chem. Lett.* **2010**, *20*, 3859-3862.
- (322) Cheng, S.; Wu, P.; Han, J.; Wang, Y.; Cui, Y.; Zhang, Z.; Yamagata, T.; Li, X. Synthesis and Biological Evaluation of Neoglycosphingolipids. *Eur. J. Med. Chem.* **2017**, *134*, 43-51.
- (323) Miyashita, H.; Ikeda, T.; Nohara, T. Synthesis of Neosaponins and Neoglycolipids Containing a Chacotriosyl Moiety. *Carbohydr. Res.* **2007**, *342*, 2182-2191.
- (324) Maslov, M.; Morozova, N.; Serebrennikova, G. Synthesis of Neoglycolipids for the Development of Non-Viral Gene Delivery Systems. *Russ. Chem. Bull.* **2010**, *59*, 2281-2289.
- (325) Pérez-Labrada, K.; Brouard, I.; Méndez, I.; Rivera, D. G. Multicomponent Synthesis of Ugi-Type Ceramide Analogues and Neoglycolipids from Lipidic Isocyanides. *J. Org. Chem.* **2012**, *77*, 4660-4670.
- (326) Manhas, S.; Taylor, M. S. Boronic Acids as Phase-Transfer Reagents for Fischer Glycosidations in Low-Polarity Solvents. *J. Org. Chem.* **2017**, *82*, 11406-11417.
- (327) TAKETOMI, T.; YAMAKAWA, T. Immunochemical Studies of Lipids. *J. Biochem.* **1963**, *54*, 444-451.
- (328) Taketomi, T.; KAWAMURA, N. Preparation of Lysohematoside (Neuraminyl-Galactosyl-Glucosylsphingosine) from Hematoside of Equine Erythrocyte and Its Chemical and Hemolytic Properties. *J. Biochem.* **1970**, *68*, 475-485.
- (329) Neuenhofer, S.; Schwarzmann, G.; Egge, H.; Sandhoff, K. Synthesis of Lysogangliosides. *Biochemistry* **1985**, *24*, 525-532.
- (330) Koshy, K.; Boggs, J. A High-Yield Saponification of Galactosylceramide I 3-Sulfate. *Lipids* **1982**, *17*, 998-1000.
- (331) Basta, M.; Karmali, M.; Lingwood, C. Sensitive Receptor-Specified Enzyme-Linked Immunosorbent Assay for Escherichia coli Verocytotoxin. *J. Clin. Microbiol.* **1989**, *27*, 1617-1622.
- (332) Sonnino, S.; Kirschner, G.; Ghidoni, R.; Acquotti, D.; Tettamanti, G. Preparation of GM1 Ganglioside Molecular Species Having Homogeneous Fatty Acid and Long Chain Base Moieties. *J. Lipid Res.* **1985**, *26*, 248-257.
- (333) Valiente, O.; Mauri, L.; Casellato, R.; Fernandez, L. E.; Sonnino, S. Preparation of Deacetyl-, Lyso-, and Deacetyl-Lyso-GM3 by Selective Alkaline Hydrolysis of GM3 Ganglioside. *J. Lipid Res.* **2001**, *42*, 1318-1324.
- (334) Wiegandt, H.; Baschang, G. Die Gewinnung Des Zuckeranteiles Der Glykosphingolipide Durch Ozonolyse Und Fragmentierung. *Z. Naturforsch. B* **1965**, *20*, 164-166.

- (335) Wiegandt, H.; Bücking, H. W. Carbohydrate Components of Extraneuronal Gangliosides from Bovine and Human Spleen, and Bovine Kidney. *FEBS J.* **1970**, *15*, 287-292.
- (336) Song, X.; Smith, D. F.; Cummings, R. D. Nonenzymatic Release of Free Reducing Glycans from Glycosphingolipids. *Anal. Biochem.* **2012**, *429*, 82-87.
- (337) Laine, R. A.; Yogeeswaran, G.; Hakomori, S.-I. Glycosphingolipids Covalently Linked to Agarose Gel or Glass Beads: Use of the Compounds for Purification of Antibodies Directed against Globoside and Hematoside. *J. Biol. Chem.* **1974**, *249*, 4460-4466.
- (338) Song, X.; Lasanajak, Y.; Xia, B.; Heimbürg-Molinari, J.; Rhea, J. M.; Ju, H.; Zhao, C.; Molinari, R. J.; Cummings, R. D.; Smith, D. F. Shotgun Glycomics: A Microarray Strategy for Functional Glycomics. *Nat. Mater.* **2011**, *8*, 85-90.
- (339) Helling, F.; Shang, A.; Calves, M.; Zhang, S.; Ren, S.; Robert, K. Y.; Oettgen, H. F.; Livingston, P. O. GD3 Vaccines for Melanoma: Superior Immunogenicity of Keyhole Limpet Hemocyanin Conjugate Vaccines. *Cancer Res.* **1994**, *54*, 197-203.
- (340) Nagahori, N.; Abe, M.; Nishimura, S.-I. Structural and Functional Glycosphingolipidomics by Glycoblotting with an Aminooxy-Functionalized Gold Nanoparticle. *Biochemistry* **2008**, *48*, 583-594.
- (341) Uemura, K.; Hara, A.; Taketomi, T. Chemical and Hemolytic Properties of Sphingolipids Modified by Ozonolysis and Reduction. *J. Biochem.* **1976**, *79*, 1253-1261.
- (342) Hakomori, S.-I. Release of Carbohydrates from Sphingoglycolipid by Osmium-Catalyzed Periodate Oxidation Followed by Treatment with Mild Alkali. *J. Lipid Res.* **1966**, *7*, 789-792.
- (343) MacDonald, D.; Patt, L.; Hakomori, S. Notes on Improved Procedures for the Chemical Modification and Degradation of Glycosphingolipids. *J. Lipid Res.* **1980**, *21*, 642-645.
- (344) Young, W. W.; Laine, R. A.; Hakomori, S.-i. [9] Covalent Attachment of Glycolipids to Solid Supports and Macromolecules. *Methods Enzymol.* **1978**, *50*, 137-140.
- (345) Mylvaganam, M.; Lingwood, C. A. A Convenient Oxidation of Natural Glycosphingolipids to Their "Ceramide Acids" for Neoglycoconjugation: Bovine Serum Albumin-Glycosylceramide Acid Conjugates as Investigative Probes for HIV gp120 Coat Protein-Glycosphingolipid Interactions. *J. Biol. Chem.* **1999**, *274*, 20725-20732.
- (346) Mylvaganam, M.; Meng, L.-J.; Lingwood, C. Oxidation of Glycosphingolipids under Basic Conditions: Synthesis of Glycosyl "Serine Acids" as Opposed to "Ceramide Acids". Precursors for Neoglycoconjugates with Increased Ligand Binding Affinity. *Biochemistry* **1999**, *38*, 10885-10897.
- (347) Kishimoto, Y.; Mitry, M. T. A New Procedure for Synthesis of 3-Keto Derivatives of Sphingolipids and Its Application for Study of Fatty Acid Composition of Brain Ceramides and Cerebrosides Containing Dihydrospingosine or Sphingosine. *Arch. Biochem. Biophys.* **1974**, *161*, 426-434.

- (348) Masao, I.; Moser, H. W.; McCluer, R. H.; Yasuo, K. 3-Ketosphingolipids: Application to the Determination of Sphingolipids Which Contain 4-Sphinganine. *Biochim. Biophys. Acta, Lipids Lipid Metab.* **1975**, *380*, 308-319.
- (349) Ghidoni, R.; Sonnino, S.; Masserini, M.; Orlando, P.; Tettamanti, G. Specific Tritium Labeling of Gangliosides at the 3-Position of Sphingosines. *J. Lipid Res.* **1981**, *22*, 1286-1295.
- (350) Miljkovic, M.; Schengrund, C.-L. Oxidative Degradation of Glycosphingolipids Revisited: A Simple Preparation of Oligosaccharides from Glycosphingolipids. *Carbohydr. Res.* **1986**, *155*, 175-181.
- (351) Yowler, B. C.; Stoehr, S. A.; Schengrund, C.-L. Oxidation and Base-Catalyzed Elimination of the Saccharide Portion of GSLs Having Very Different Polarities. *J. Lipid Res.* **2001**, *42*, 659-662.
- (352) Song, X.; Ju, H.; Lasanajak, Y.; Kudelka, M. R.; Smith, D. F.; Cummings, R. D. Oxidative Release of Natural Glycans for Functional Glycomics. *Nat. Mater.* **2016**, *13*, 528-534.
- (353) Sonnino, S.; Acquotti, D.; Fronza, G.; Cantu, L.; Chigorno, V.; Pitto, M.; Kirschner, G.; Tettamanti, G. Semisynthetic Preparation of N-Glycolylneuraminic Acid Containing GM1 Ganglioside: Chemical Characterization, Physico-Chemical Properties and Some Biochemical Features. *Chem. Phys. Lipids* **1988**, *46*, 181-191.
- (354) Higashi, H.; Basu, S. Specific ¹⁴C Labeling of Sialic Acid and N-Acetylhexosamine Residues of Glycosphingolipids after Hydrazinolysis. *Anal. Biochem.* **1982**, *120*, 159-164.
- (355) Karkas, J. D.; Chargaff, E. Studies on the Stability of Simple Derivatives of Sialic Acid. *J. Biol. Chem.* **1964**, *239*, 949-957.
- (356) Yu, R. K.; Ledeen, R. Configuration of the Ketosidic Bond of Sialic Acid. *J. Biol. Chem.* **1969**, *244*, 1306-1313.
- (357) Van Lenten, L.; Ashwell, G. Studies on the Chemical and Enzymatic Modification of Glycoproteins a General Method for the Tritiation of Sialic Acid-Containing Glycoproteins. *J. Biol. Chem.* **1971**, *246*, 1889-1894.
- (358) Spiegel, S.; Ravid, A.; Wilchek, M. Involvement of Gangliosides in Lymphocyte Stimulation. *Proc. Natl. Acad. Sci. U. S. A.* **1979**, *76*, 5277-5281.
- (359) Spiegel, S.; Kassis, S.; Wilchek, M.; Fishman, P. H. Direct Visualization of Redistribution and Capping of Fluorescent Gangliosides on Lymphocytes. *J. Cell Biol.* **1984**, *99*, 1575-1581.
- (360) Polyakova, S. M.; Belov, V. N.; Yan, S. F.; Eggeling, C.; Ringemann, C.; Schwarzmann, G.; de Meijere, A.; Hell, S. W. New GM1 Ganglioside Derivatives for Selective Single and Double Labelling of the Natural Glycosphingolipid Skeleton. *Eur. J. Org. Chem.* **2009**, *2009*, 5162-5177.

- (361) Brenner, C.; Kniep, B.; Maillier, E.; Martel, C.; Franke, C.; Röber, N.; Bachmann, M.; Rieber, E. P.; Sandhoff, R. GD3–7-Aldehyde Is an Apoptosis Inducer and Interacts with Adenine Nucleotide Translocase. *Biochem. Biophys. Res. Commun.* **2010**, *391*, 248-253.
- (362) De Bank, P.; Kellam, B.; Kendall, D.; Shakesheff, K. Surface Engineering of Living Myoblasts Via Selective Periodate Oxidation. *Biotechnol. Bioeng.* **2003**, *81*, 800-808.
- (363) Zeng, Y.; Ramya, T. N. C.; Dirksen, A.; Dawson, P. E.; Paulson, J. C. High-Efficiency Labeling of Sialylated Glycoproteins on Living Cells. *Nat. Mater.* **2009**, *6*, 207-209.
- (364) Key, J. A.; Li, C.; Cairo, C. W. Detection of Cellular Sialic Acid Content Using Nitrobenzoxadiazole Carbonyl-Reactive Chromophores. *Bioconjugate Chem.* **2012**, *23*, 363-371.
- (365) Zhang, Y.; Yuan, J.; Song, J.; Wang, Z.; Huang, L. An Efficient Method for Selectively Imaging and Quantifying in Situ the Expression of Sialylated Glycoproteins on Living Cells. *Glycobiology* **2013**, *23*, 643-653.
- (366) Nilsson, K. G. I. Enzymatic Synthesis of Oligosaccharides. *Trends Biotechnol.* **1988**, *6*, 256-264.
- (367) Ichikawa, Y.; Look, G. C.; Wong, C. H. Enzyme-Catalyzed Oligosaccharide Synthesis. *Anal. Biochem.* **1992**, *202*, 215-238.
- (368) Merrill, A. H. Sphingolipid and Glycosphingolipid Metabolic Pathways in the Era of Sphingolipidomics. *Chem. Rev.* **2011**, *111*, 6387-6422.
- (369) Wennekes, T.; van den Berg, R. J. B. H. N.; Boot, R. G.; van der Marel, G. A.; Overkleeft, H. S.; Aerts, J. M. F. G. Glycosphingolipids—Nature, Function, and Pharmacological Modulation. *Angew. Chem., Int. Ed.* **2009**, *48*, 8848-8869.
- (370) Wang, L.-X.; Huang, W. Enzymatic Transglycosylation for Glycoconjugate Synthesis. *Curr. Opin. Chem. Biol.* **2009**, *13*, 592-600.
- (371) Cobucci-Ponzano, B.; Strazzulli, A.; Rossi, M.; Moracci, M. Glycosynthases in Biocatalysis. *Adv. Synth. Catal.* **2011**, *353*, 2284-2300.
- (372) Danby, P. M.; Withers, S. G. Advances in Enzymatic Glycoside Synthesis. *ACS Chem. Biol.* **2016**, *11*, 1784-1794.
- (373) Li, C.; Wang, L. X. Endoglycosidases for the Synthesis of Polysaccharides and Glycoconjugates. In *Adv. Carbohydr. Chem. Biochem.*; Baker, D. C., Ed., 2016; Vol. 73.
- (374) McArthur, J. B.; Chen, X. Glycosyltransferase Engineering for Carbohydrate Synthesis. *Biochem. Soc. Trans.* **2016**, *44*, 129-142.
- (375) Yu, H.; Chen, X. One-Pot Multienzyme (OPME) Systems for Chemoenzymatic Synthesis of Carbohydrates. *Org. Biomol. Chem.* **2016**, *14*, 2809-2818.
- (376) Schmaltz, R. M.; Hanson, S. R.; Wong, C.-H. Enzymes in the Synthesis of Glycoconjugates. *Chem. Rev.* **2011**, *111*, 4259-4307.

- (377) Koeller, K. M.; Wong, C. H. Complex Carbohydrate Synthesis Tools for Glycobiologists: Enzyme-Based Approach and Programmable One-Pot Strategies. *Glycobiology* **2000**, *10*, 1157-1169.
- (378) Johnson, K. F. Synthesis of Oligosaccharides by Bacterial Enzymes. *Glycoconjugate J.* **1999**, *16*, 141-146.
- (379) Brockhausen, I. Crossroads between Bacterial and Mammalian Glycosyltransferases. *Front. Immunol.* **2014**, *5*, doi: 10.3389/fimmu.2014.00492.
- (380) Guilbert, B.; Flitsch, S. L. A Short Chemo-Enzymic Route to Glycosphingolipids Using Soluble Glycosyl Transferases. *J. Chem. Soc., Perkin Trans. 1* **1994**, *1994*, 1181-1186.
- (381) Guilbert, B.; Khan, T. H.; Flitsch, S. L. Chemoenzymatic Synthesis of a Glycosphingolipid. *J. Chem. Soc., Chem. Commun.* **1992**, *1992*, 1526-1527.
- (382) Gaudino, J. J.; Paulson, J. C. A Novel and Efficient Synthesis of Neolacto Series Gangliosides 3'-nLM1 and 6'-nLM1. *J. Am. Chem. Soc.* **1994**, *116*, 1149-1150.
- (383) Santra, A.; Li, Y.; Yu, H.; Slack, T. J.; Wang, P. G.; Chen, X. Highly Efficient Chemoenzymatic Synthesis and Facile Purification of α -Gal Pentasaccharyl Ceramide Gal- α -3nLc4- β -Cer. *Chem. Comm.* **2017**, *53*, 8280-8283.
- (384) Kolter, T.; Proia, R. L.; Sandhoff, K. Combinatorial Ganglioside Biosynthesis. *J. Biol. Chem.* **2002**, *277*, 25859-25862.
- (385) Schwardt, O.; Visekruna, T.; Rabbani, S.; Ernst, B. Minireview: Bacterial Sialyltransferases for Carbohydrate Synthesis. *Chimia* **2006**, *60*, 234-240.
- (386) Yu, H.; Chokhawala, H. A.; Huang, S.; Chen, X. One-Pot Three-Enzyme Chemoenzymatic Approach to the Synthesis of Sialosides Containing Natural and Non-Natural Functionalities. *Nat. Protoc.* **2006**, *1*, 2485-2492.
- (387) Koeller, K. M.; Wong, C.-H. Synthesis of Complex Carbohydrates and Glycoconjugates: Enzyme-Based and Programmable One-Pot Strategies. *Chem. Rev.* **2000**, *100*, 4465-4494.
- (388) Chen, X.; Fang, J.; Zhang, J.; Liu, Z.; Shao, J.; Kowal, P.; Andreana, P.; Wang, P. G. Sugar Nucleotide Regeneration Beads (Superbeads): A Versatile Tool for the Practical Synthesis of Oligosaccharides. *J. Am. Chem. Soc.* **2001**, *123*, 2081-2082.
- (389) Nahalka, J.; Liu, Z.; Chen, X.; Wang, P. G. Superbeads: Immobilization in "Sweet" Chemistry. *Chem. - Eur. J.* **2003**, *9*, 372-377.
- (390) Vireak, T.; Lau, K.; Yu, H.; Tran, B. K.; Chen, X. Pmst2: A Novel *Pasteurella Multocida* Glycolipid Alpha 2-3-Sialyltransferase. *Glycobiology* **2011**, *21*, 1206-1216.
- (391) Thon, V.; Li, Y.; Yu, H.; Lau, K.; Chen, X. Pmst3 from *Pasteurella Multocida* Encoded by Pm1174 Gene Is a Monofunctional Alpha 2-3-Sialyltransferase. *Appl. Microbiol. Biotechnol.* **2012**, *94*, 977-985.

- (392) Sugiarto, G.; Lau, K.; Qu, J.; Li, Y.; Lim, S.; Mu, S.; Ames, J. B.; Fisher, A. J.; Chen, X. A Sialyltransferase Mutant with Decreased Donor Hydrolysis and Reduced Sialidase Activities for Directly Sialylating Lewis(X). *ACS Chem. Biol.* **2012**, *7*, 1232-1240.
- (393) Gilbert, M.; Karwaski, M.-F.; Bernatchez, S.; Young, N. M.; Taboada, E.; Michniewicz, J.; Cunningham, A.-M.; Wakarchuk, W. W. The Genetic Bases for the Variation in the Lipo-Oligosaccharide of the Mucosal Pathogen, *Campylobacter jejuni*: Biosynthesis of Sialylated Ganglioside Mimics in the Core Oligosaccharide. *J. Biol. Chem.* **2002**, *277*, 327-337.
- (394) Yang, G.-Y.; Li, C.; Fischer, M.; Cairo, C. W.; Feng, Y.; Withers, S. G. A FRET Probe for Cell-Based Imaging of Ganglioside-Processing Enzyme Activity and High-Throughput Screening. *Angew. Chem., Int. Ed.* **2015**, *54*, 5389-5393.
- (395) Kuan, T. C.; Wu, H. R.; Adak, A. K.; Li, B. Y.; Liang, C. F.; Hung, J. T.; Chiou, S. P.; Yu, A. L.; Hwu, J. R.; Lin, C. C. Synthesis of an S-Linked $\alpha(2\rightarrow8)$ GD3 Antigen and Evaluation of the Immunogenicity of Its Glycoconjugate. *Chem. - Eur. J.* **2017**, *23*, 6876-6887.
- (396) Blixt, O.; Vasiliu, D.; Allin, K.; Jacobsen, N.; Warnock, D.; Razi, N.; Paulson, J. C.; Bernatchez, S.; Gilbert, M.; Wakarchuk, W. Chemoenzymatic Synthesis of 2-Azidoethyl-Ganglio-Oligosaccharides GD3, Gt3, GM2, GD2, Gt2, GM1, and GD1a. *Carbohydr. Res.* **2005**, *340*, 1963-1972.
- (397) Yu, H.; Cheng, J.; Ding, L.; Khedri, Z.; Chen, Y.; Chin, S.; Lau, K.; Tiwari, V. K.; Chen, X. Chemoenzymatic Synthesis of GD3 Oligosaccharides and Other Disialyl Glycans Containing Natural and Non-Natural Sialic Acids. *J. Am. Chem. Soc.* **2009**, *131*, 18467-18477.
- (398) Yu, H.; Zeng, J.; Li, Y.; Thon, V.; Shi, B.; Chen, X. Effective One-Pot Multienzyme (OPME) Synthesis of Monotreme Milk Oligosaccharides and Other Sialosides Containing 4-O-Acetyl Sialic Acid. *Org. Biomol. Chem.* **2016**, *14*, 8586-8597.
- (399) Jacques, S.; Rich, J. R.; Ling, C.-C.; Bundle, D. R. Chemoenzymatic Synthesis of GM3 and GM2 Gangliosides Containing a Truncated Ceramide Functionalized for Glycoconjugate Synthesis and Solid Phase Applications. *Org. Biomol. Chem.* **2006**, *4*, 142-154.
- (400) Hunter, C. D.; Khanna, N.; Richards, M. R.; Rezaei Darestani, R.; Zou, C.; Klassen, J. S.; Cairo, C. W. Human Neuraminidase Isoenzymes Show Variable Activities for 9-O-Acetyl-Sialoside Substrates. *ACS Chem. Biol.* **2018**, *13*, 922-932.
- (401) Sandbhor, M. S.; Soya, N.; Albohy, A.; Zheng, R. B.; Cartmell, J.; Bundle, D. R.; Klassen, J. S.; Cairo, C. W. Substrate Recognition of the Membrane-Associated Sialidase NEU3 Requires a Hydrophobic Aglycone. *Biochemistry* **2011**, *50*, 6753-6762.
- (402) Craven, F.; Silva, J.; Segarra-Maset, M.; Huang, K.; Both, P.; Gough, J.; Flitsch, S. L.; Webb, S. 'One-Pot' sequential Enzymatic Modification of Synthetic Glycolipids in Vesicle Membranes. *Chem. Comm.* **2018**, *54*, 1347-1350.

- (403) Gilbert, M.; Brisson, J.-R.; Karwaski, M.-F.; Michniewicz, J.; Cunningham, A.-M.; Wu, Y.; Young, N. M.; Wakarchuk, W. W. Biosynthesis of Ganglioside Mimics in *Campylobacter jejuni* OH4384: Identification of the Glycosyltransferase Genes, Enzymatic Synthesis of Model Compounds, and Characterization of Nanomole Amounts by 600-MHz ¹H and ¹³C NMR Analysis. *J. Biol. Chem.* **2000**, *275*, 3896-3906.
- (404) Lee, Y. C.; Kojima, N.; Wada, E.; Kurosawa, N.; Nakaoka, T.; Hamamoto, T.; Tsuji, S. Cloning and Expression of cDNA for a New Type of Gal Beta 1,3GalNAc Alpha 2,3-Sialyltransferase. *J. Biol. Chem.* **1994**, *269*, 10028-10033.
- (405) Meng, X.; Yao, W.; Cheng, J.; Zhang, X.; Jin, L.; Yu, H.; Chen, X.; Wang, F.; Cao, H. Regioselective Chemoenzymatic Synthesis of Ganglioside Disialyl Tetrasaccharide Epitopes. *J. Am. Chem. Soc.* **2014**, *136*, 5205-5208.
- (406) Takakura, Y.; Tsukamoto, H.; Yamamoto, T. Molecular Cloning, Expression and Properties of an α/β -Galactoside A2, 3-Sialyltransferase from *Vibrio* Sp. Jt-Faj-16. *J. Biochem.* **2007**, *142*, 403-412.
- (407) Shao, J.; Li, M.; Jia, Q.; Lu, Y.; Wang, P. G. Sequence of *Escherichia coli* O128 Antigen Biosynthesis Cluster and Functional Identification of an α -1,2-Fucosyltransferase. *FEBS Lett.* **2003**, *553*, 99-103.
- (408) Stein, D. B.; Lin, Y.-N.; Lin, C.-H. Characterization of *Helicobacter Pylori* A1,2-Fucosyltransferase for Enzymatic Synthesis of Tumor-Associated Antigens. *Adv. Synth. Catal.* **2008**, *350*, 2313-2321.
- (409) Yu, H.; Lau, K.; Thon, V.; Autran, C. A.; Jantscher-Krenn, E.; Xue, M.; Li, Y.; Sugiarto, G.; Qu, J.; Mu, S. et al. Synthetic Disialyl Hexasaccharides Protect Neonatal Rats from Necrotizing Enterocolitis. *Angew. Chem., Int. Ed.* **2014**, *53*, 6687-6691.
- (410) McArthur, J. B.; Yu, H.; Zeng, J.; Chen, X. Converting *Pasteurella Multocida* Alpha 2-3-Sialyltransferase 1 (PmST1) to a Regioselective Alpha 2-6-Sialyltransferase by Saturation Mutagenesis and Regioselective Screening. *Org. Biomol. Chem.* **2017**, *15*, 1700-1709.
- (411) Yu, H.; Yan, X.; Autran, C. A.; Li, Y.; Etzold, S.; Latasiewicz, J.; Robertson, B. M.; Li, J.; Bode, L.; Chen, X. Enzymatic and Chemoenzymatic Syntheses of Disialyl Glycans and Their Necrotizing Enterocolitis Preventing Effects. *J. Org. Chem.* **2017**, *82*, 13152-13160.
- (412) Pamela Stanley, R. D. C. In *Structures Common to Different Glycans*; 3 rd ed.; Ajit Varki, R. D. C., Jeffrey D Esko, Hudson H Freeze, Pamela Stanley, Carolyn R Bertozzi, Gerald W Hart, and Marilyn E Etzler, Ed.; Cold Spring Harbor Laboratory Press: Cold Spring Harbor (NY), 2017.
- (413) Grunwald, P. *Carbohydrate-Modifying Biocatalysts*; CRC Press, 2011.
- (414) Ruffing, A.; Chen, R. R. Metabolic Engineering of Microbes for Oligosaccharide and Polysaccharide Synthesis. *Microb. Cell Fact.* **2006**, *5*, doi: 10.1186/1475-2859-5-25.

- (415) Chen, X.; Liu, Z.; Zhang, J.; Zhang, W.; Kowal, P.; Wang, P. G. Reassembled Biosynthetic Pathway for Large-Scale Carbohydrate Synthesis: α -Gal Epitope Producing “Superbug”. *ChemBioChem* **2002**, *3*, 47-53.
- (416) Samain, E.; Chazalet, V.; Geremia, R. A. Production of O-Acetylated and Sulfated Chitooligosaccharides by Recombinant *Escherichia coli* Strains Harboring Different Combinations of Nod Genes. *J. Biotechnol.* **1999**, *72*, 33-47.
- (417) Yavuz, E.; Drouillard, S.; Samain, E.; Roberts, I.; Priem, B. Glucuronylation in *Escherichia coli* for the Bacterial Synthesis of the Carbohydrate Moiety of Nonsulfated Hnk-1. *Glycobiology* **2008**, *18*, 152-157.
- (418) Bettler, E.; Samain, E.; Chazalet, V.; Bosso, C.; Heyraud, A.; Joziassse, D. H.; Wakarchuk, W. W.; Imberty, A.; Geremia, R. A. The Living Factory: In Vivo Production of N-Acetyllactosamine Containing Carbohydrates in *E. coli*. *Glycoconjugate J.* **1999**, *16*, 205-212.
- (419) Endo, T.; Koizumi, S.; Tabata, K.; Kakita, S.; Ozaki, A. Large-Scale Production of N-Acetyllactosamine through Bacterial Coupling. *Carbohydr. Res.* **1999**, *316*, 179-183.
- (420) Endo, T.; Koizumi, S.; Tabata, K.; Ozaki, A. Large-Scale Production of CMP-Neu5Ac and Sialylated Oligosaccharides through Bacterial Coupling. *Appl. Microbiol. Biotechnol.* **2000**, *53*, 257-261.
- (421) Chen, R. The Sweet Branch of Metabolic Engineering: Cherry-Picking the Low-Hanging Sugary Fruits. *Microb. Cell Fact.* **2015**, *14*, doi: 10.1186/s12934-12015-10389-z.
- (422) Antoine, T.; Heyraud, A.; Bosso, C.; Samain, E. Highly Efficient Biosynthesis of the Oligosaccharide Moiety of the GD3 Ganglioside by Using Metabolically Engineered *Escherichia coli*. *Angew. Chem.* **2005**, *117*, 1374-1376.
- (423) Antoine, T.; Priem, B.; Heyraud, A.; Greffe, L.; Gilbert, M.; Wakarchuk, W. W.; Lam, J. S.; Samain, E. Large-Scale in Vivo Synthesis of the Carbohydrate Moieties of Gangliosides GM1 and GM2 by Metabolically Engineered *Escherichia coli*. *ChemBioChem* **2003**, *4*, 406-412.
- (424) Birikaki, L.; Pradeau, S.; Armand, S.; Priem, B.; Marquez-Dominguez, L.; Reyes-Leyva, J.; Santos-Lopez, G.; Samain, E.; Driguez, H.; Fort, S. Chemoenzymatic Syntheses of Sialylated Oligosaccharides Containing C5-Modified Neuraminic Acids for Dual Inhibition of Hemagglutinins and Neuraminidases. *Chem. - Eur. J.* **2015**, *21*, 10903-10912.
- (425) Fort, S.; Birikaki, L.; Dubois, M.-P.; Antoine, T.; Samain, E.; Driguez, H. Biosynthesis of Conjugatable Saccharidic Moieties of GM2 and GM3 Gangliosides by Engineered *E. coli*. *Chem. Comm.* **2005**, *2005*, 2558-2560.
- (426) Fierfort, N.; Samain, E. Genetic Engineering of *Escherichia coli* for the Economical Production of Sialylated Oligosaccharides. *J. Biotechnol.* **2008**, *134*, 261-265.
- (427) Drouillard, S.; Mine, T.; Kajiwara, H.; Yamamoto, T.; Samain, E. Efficient Synthesis of 6'-Sialyllactose, 6,6'-Disialyllactose, and 6'-KDO-Lactose by Metabolically Engineered *E.*

- coli Expressing a Multifunctional Sialyltransferase from the Photobacterium Sp Jt-Ish-224. *Carbohydr. Res.* **2010**, *345*, 1394-1399.
- (428) Richard, E.; Buon, L.; Drouillard, S.; Fort, S.; Priem, B. Bacterial Synthesis of Polysialic Acid Lactosides in Recombinant Escherichia coli K-12. *Glycobiology* **2016**, *26*, 723-731.
- (429) Lombard, V.; Golaconda Ramulu, H.; Drula, E.; Coutinho, P. M.; Henrissat, B. The Carbohydrate-Active Enzymes Database (CAZy) in 2013. *Nucleic Acids Res.* **2014**, *42*, D490-D495.
- (430) Vocadlo, D. J.; Davies, G. J. Mechanistic Insights into Glycosidase Chemistry. *Curr. Opin. Chem. Biol.* **2008**, *12*, 539-555.
- (431) Stick, R.; Williams, S. *Enzymatic Cleavage of Glycosides: Mechanism, Inhibition and Synthetic Applications*, 2009.
- (432) Zechel, D. L.; Withers, S. G. Glycosidase Mechanisms: Anatomy of a Finely Tuned Catalyt. *Acc. Chem. Res.* **2000**, *33*, 11-18.
- (433) Bissaro, B.; Monsan, P.; Fauré, R.; O'Donohue, Michael J. Glycosynthesis in a Waterworld: New Insight into the Molecular Basis of Transglycosylation in Retaining Glycoside Hydrolases. *Biochem. J.* **2015**, *467*, 17-35.
- (434) Mark, B. L.; Vocadlo, D. J.; Knapp, S.; Triggs-Raine, B. L.; Withers, S. G.; James, M. N. G. Crystallographic Evidence for Substrate-Assisted Catalysis in a Bacterial β -Hexosaminidase. *J. Biol. Chem.* **2001**, *276*, 10330-10337.
- (435) Yip, V. L. Y.; Withers, S. G. Breakdown of Oligosaccharides by the Process of Elimination. *Curr. Opin. Chem. Biol.* **2006**, *10*, 147-155.
- (436) Malet, C.; Planas, A. From β -Glucanase to β -Glucansynthase: Glycosyl Transfer to α -Glycosyl Fluorides Catalyzed by a Mutant Endoglucanase Lacking Its Catalytic Nucleophile. *FEBS Lett.* **1998**, *440*, 208-212.
- (437) Vic, G.; Crout, D. H. G. Synthesis of Glucosidic Derivatives with a Spacer Arm by Reverse Hydrolysis Using Almond β -D-Glucosidase. *Tetrahedron: Asymmetry* **1994**, *5*, 2513-2516.
- (438) Williams, S. J.; Withers, S. G. Glycosyl Fluorides in Enzymatic Reactions. *Carbohydr. Res.* **2000**, *327*, 27-46.
- (439) Viladot, J.-L.; Moreau, V.; Planas, A.; Driguez, H. Transglycosylation Activity of Bacillus 1,3-1,4-[Small Beta]-D-Glucan 4-Glucanohydrolases. Enzymic Synthesis of Alternate 1,3,-1,4-[Small Beta]-D-Glucooligosaccharides. *J. Chem. Soc., Perkin Trans. 1* **1997**, *1997*, 2383-2388.
- (440) Murata, T.; Kosugi, M.; Nakamura, T.; Urashima, T.; Usui, T. Enzymatic Synthesis of Sulfated Disaccharides Using β -D-Galactosidase-Catalyzed Transglycosylation. *Biosci., Biotechnol., Biochem.* **2001**, *65*, 2456-2464.

- (441) Ajisaka, K.; Shirakabe, M. Regioselective Synthesis of α -L-Fucosyl-Containing Disaccharides by Use of α -L-Fucosidases of Various Origins. *Carbohydr. Res.* **1992**, *224*, 291-299.
- (442) Murata, T.; Morimoto, S.; Zeng, X.; Watanabe, S.; Usui, T. Enzymatic Synthesis of α -L-Fucosyl-N-Acetylglucosamines and 3'-O- α -L-Fucosyllactose Utilizing α -L-Fucosidases. *Carbohydr. Res.* **1999**, *320*, 192-199.
- (443) Zeng, X.; Murata, T.; Usui, T. Glycosidase-Catalyzed Synthesis of Fucosyl Di- and Trisaccharide Derivatives Using α -L-Fucosidase From *Alcaligenes* Sp. *J. Carbohydr. Chem.* **2003**, *22*, 309-316.
- (444) Ajisaka, K.; Fujimoto, H.; Miyasato, M. An α -L-Fucosidase from *Penicillium Multicolor* as a Candidate Enzyme for the Synthesis of α (1 \rightarrow 3)-Linked Fucosyl Oligosaccharides by Transglycosylation. *Carbohydr. Res.* **1998**, *309*, 125-129.
- (445) Farkas, E.; Thiem, J.; Ajisaka, K. Enzymatic Synthesis of Fucose-Containing Disaccharides Employing the Partially Purified α -L-Fucosidase from *Penicilliummulticolor*. *Carbohydr. Res.* **2000**, *328*, 293-299.
- (446) Uzawa, H.; Zeng, X.; Minoura, N. Synthesis of 6[Prime or Minute]-Sulfodisaccharides by [Small Beta]-N-Acetylhexosaminidase-Catalyzed Transglycosylation. *Chem. Comm.* **2003**, *2003*, 100-101.
- (447) Yasutake, N.; Totani, K.; Harada, Y.; Haraguchi, S.; Murata, T.; Usui, T. Synthesis of Glyceroyl β -N-Acetylglucosaminide and Its Derivatives through a Condensation Reaction by Cellulase. *Biosci., Biotechnol., Biochem.* **2003**, *67*, 1530-1536.
- (448) Hayes, M. R.; Pietruszka, J. Synthesis of Glycosides by Glycosynthases. *Molecules* **2017**, *22*, doi: 10.3390/molecules22091434.
- (449) Williams, S. J.; Withers, S. G. Glycosynthases: Mutant Glycosidases for Glycoside Synthesis. *Aus. J. Chem.* **2002**, *55*, 3-12.
- (450) Mackenzie, L. F.; Wang, Q.; Warren, R. A. J.; Withers, S. G. Glycosynthases: Mutant Glycosidases for Oligosaccharide Synthesis. *J. Am. Chem. Soc.* **1998**, *120*, 5583-5584.
- (451) Mayer, C.; Jakeman, D. L.; Mah, M.; Karjala, G.; Gal, L.; Warren, R. A. J.; Withers, S. G. Directed Evolution of New Glycosynthases from *Agrobacterium* β -Glucosidase: A General Screen to Detect Enzymes for Oligosaccharide Synthesis. *Chem. Biol.* **2001**, *8*, 437-443.
- (452) Cobucci-Ponzano, B.; Zorzetti, C.; Strazzulli, A.; Carillo, S.; Bedini, E.; Corsaro, M. M.; Comfort, D. A.; Kelly, R. M.; Rossi, M.; Moracci, M. A Novel α -D-Galactosynthase from *Thermotoga Maritima* Converts β -D-Galactopyranosyl Azide to α -Galacto-Oligosaccharides. *Glycobiology* **2011**, *21*, 448-456.
- (453) Okuyama, M.; Mori, H.; Watanabe, K.; Kimura, A.; Chiba, S. α -Glucosidase Mutant Catalyzes " α -Glycosynthase"-Type Reaction. *Biosci., Biotechnol., Biochem.* **2002**, *66*, 928-933.

- (454) Cobucci-Ponzano, B.; Conte, F.; Bedini, E.; Corsaro, M. M.; Parrilli, M.; Sulzenbacher, G.; Lipski, A.; Dal Piaz, F.; Lepore, L.; Rossi, M. et al. β -Glycosyl Azides as Substrates for α -Glycosynthases: Preparation of Efficient α -L-Fucosynthases. *Chem. Biol.* **2009**, *16*, 1097-1108.
- (455) Honda, Y.; Kitaoka, M. The First Glycosynthase Derived from an Inverting Glycoside Hydrolase. *J. Biol. Chem.* **2006**, *281*, 1426-1431.
- (456) Wada, J.; Honda, Y.; Nagae, M.; Kato, R.; Wakatsuki, S.; Katayama, T.; Taniguchi, H.; Kumagai, H.; Kitaoka, M.; Yamamoto, K. 1,2- α -L-Fucosynthase: A Glycosynthase Derived from an Inverting α -Glycosidase with an Unusual Reaction Mechanism. *FEBS Lett.* **2008**, *582*, 3739-3743.
- (457) Roy, B.; Ferdjani, S.; Tellier, C.; Rabiller, C. Novel and Convergent Synthesis of Modified Glycosphingolipids, Galactosyl-5-Aza-Sphinganine, by a Diversity-Oriented Method. *Tetrahedron* **2011**, *67*, 5176-5183.
- (458) Li, C.; Kim, Y.-W. Characterization of a Galactosynthase Derived from *Bacillus Circulans* β -Galactosidase: Facile Synthesis of D-Lacto- and D-Galacto-N-Bioside. *ChemBioChem* **2014**, *15*, 522-526.
- (459) Henze, M.; You, D.-J.; Kamerke, C.; Hoffmann, N.; Angkawidjaja, C.; Ernst, S.; Pietruszka, J.; Kanaya, S.; Elling, L. Rational Design of a Glycosynthase by the Crystal Structure of β -Galactosidase from *Bacillus Circulans* (Bgac) and Its Use for the Synthesis of N-Acetylglucosamine Type 1 Glycan Structures. *J. Biotechnol.* **2014**, *191*, 78-85.
- (460) Henze, M.; Schmidtke, S.; Hoffmann, N.; Steffens, H.; Pietruszka, J.; Elling, L. Combination of Glycosyltransferases and a Glycosynthase in Sequential and One-Pot Reactions for the Synthesis of Type 1 and Type 2 N-Acetylglucosamine Oligomers. *ChemCatChem* **2015**, *7*, 3131-3139.
- (461) Hancock, S. M.; Rich, J. R.; Caines, M. E. C.; Strynadka, N. C. J.; Withers, S. G. Designer Enzymes for Glycosphingolipid Synthesis by Directed Evolution. *Nat. Chem. Biol.* **2009**, *5*, 508-514.
- (462) Hehre, E. J.; Brewer, C. F.; Genghof, D. S. Scope and Mechanism of Carbohydrase Action. Hydrolytic and Nonhydrolytic Actions of Beta-Amylase on Alpha- and Beta-Maltosyl Fluoride. *J. Biol. Chem.* **1979**, *254*, 5942-5950.
- (463) Sugiyama, Y.; Gotoh, A.; Katoh, T.; Honda, Y.; Yoshida, E.; Kurihara, S.; Ashida, H.; Kumagai, H.; Yamamoto, K.; Kitaoka, M. et al. Introduction of H-Antigens into Oligosaccharides and Sugar Chains of Glycoproteins Using Highly Efficient 1,2- α -L-Fucosynthase. *Glycobiology* **2016**, *26*, 1235-1247.
- (464) Sugiyama, Y.; Katoh, T.; Honda, Y.; Gotoh, A.; Ashida, H.; Kurihara, S.; Yamamoto, K.; Katayama, T. Application Study of 1,2- α -L-Fucosynthase: Introduction of Fuca1-2gal Disaccharide Structures on N-Glycan, Ganglioside, and Xyloglucan Oligosaccharide. *Biosci., Biotechnol., Biochem.* **2017**, *81*, 283-291.

- (465) Jahn, M.; Marles, J.; Warren, R. A. J.; Withers, S. G. Thioglycoligases: Mutant Glycosidases for Thioglycoside Synthesis. *Angew. Chem., Int. Ed.* **2003**, *42*, 352-354.
- (466) Kim, Y.-W.; Zhang, R.; Chen, H.; Withers, S. G. O-Glycoligases, a New Category of Glycoside Bond-Forming Mutant Glycosidases, Catalyze Facile Syntheses of Isoprimeverosides. *Chem. Comm.* **2010**, *46*, 8725-8727.
- (467) Li, Y.-T.; Li, S.-C. Enzymatic Hydrolysis of Glycosphingolipids. *Anal. Biochem.* **1999**, *273*, 1-11.
- (468) Ito, M.; Yamagata, T. A Novel Glycosphingolipid-Degrading Enzyme Cleaves the Linkage between the Oligosaccharide and Ceramide of Neutral and Acidic Glycosphingolipids. *J. Biol. Chem.* **1986**, *261*, 14278-14282.
- (469) Li, S.-C.; Degasperi, R.; Muldrey, J. E.; Li, Y.-T. A Unique Glycosphingolipid-Splitting Enzyme (Ceramide-Glycanase from Leech) Cleaves the Linkage between the Oligosaccharide and the Ceramide. *Biochem. Biophys. Res. Commun.* **1986**, *141*, 346-352.
- (470) Horibata, Y.; Sakaguchi, K.; Okino, N.; Iida, H.; Inagaki, M.; Fujisawa, T.; Hama, Y.; Ito, M. Unique Catabolic Pathway of Glycosphingolipids in a Hydrozoan, Hydra Magnipapillata, Involving Endoglycoceramidase. *J. Biol. Chem.* **2004**, *279*, 33379-33389.
- (471) Ashida, H.; Yamamoto, K.; Kumagai, H.; Tochikura, T. Purification and Characterization of Membrane-Bound Endoglycoceramidase from *Corynebacterium* Sp. *FEBS J.* **1992**, *205*, 729-735.
- (472) Basu, S. S.; Dastgheibhosseini, S.; Hoover, G.; Li, Z.; Basu, S. Analysis of Glycosphingolipids by Fluorophore-Assisted Carbohydrate Electrophoresis Using Ceramide Glycanase from *Mercenaria Mercenaria*. *Anal. Biochem.* **1994**, *222*, 270-274.
- (473) Li, Y.-T.; Ishikawa, Y.; Li, S.-C. Occurrence of Ceramide-Glycanase in the Earthworm, *Lumbricus terrestris*. *Biochem. Biophys. Res. Commun.* **1987**, *149*, 167-172.
- (474) Ito, M.; Yamagata, T. Purification and Characterization of Glycosphingolipid-Specific Endoglycosidases (Endoglycoceramidas) from a Mutant Strain of *Rhodococcus* Sp. Evidence for Three Molecular Species of Endoglycoceramidase with Different Specificities. *J. Biol. Chem.* **1989**, *264*, 9510-9519.
- (475) Ishibashi, Y.; Kobayashi, U.; Hijikata, A.; Sakaguchi, K.; Goda, H. M.; Tamura, T.; Okino, N.; Ito, M. Preparation and Characterization of EGCCase I, Applicable to the Comprehensive Analysis of GSLs, Using a Rhodococcal Expression System. *J. Lipid Res.* **2012**, *53*, 2242-2251.
- (476) Izu, H.; Izumi, Y.; Kurome, Y.; Sano, M.; Kondo, A.; Kato, I.; Ito, M. Molecular Cloning, Expression, and Sequence Analysis of the Endoglycoceramidase Ii Gene from *Rhodococcus* Species Strain M-777. *J. Biol. Chem.* **1997**, *272*, 19846-19850.
- (477) Ishibashi, Y.; Nakasone, T.; Kiyohara, M.; Horibata, Y.; Sakaguchi, K.; Hijikata, A.; Ichinose, S.; Omori, A.; Yasui, Y.; Imamura, A. A Novel Endoglycoceramidase

- Hydrolyzes Oligogalactosylceramides to Produce Galactooligosaccharides and Ceramides. *J. Biol. Chem.* **2007**, 282, 11386-11396.
- (478) Han, Y.-B.; Chen, L.-Q.; Li, Z.; Tan, Y.-M.; Feng, Y.; Yang, G.-Y. Structural Insights into the Broad Substrate Specificity of a Novel Endoglycoceramidase I Belonging to a New Subfamily of Gh5 Glycosidases. *J. Biol. Chem.* **2017**, 292, 4789-4800.
- (479) Caines, M. E.; Vaughan, M. D.; Tarling, C. A.; Hancock, S. M.; Warren, R. A. J.; Withers, S. G.; Strynadka, N. C. Structural and Mechanistic Analyses of Endo-Glycoceramidase II, a Membrane-Associated Family 5 Glycosidase in the Apo and GM3 Ganglioside-Bound Forms. *J. Biol. Chem.* **2007**, 282, 14300-14308.
- (480) Levery, S. B. Glycosphingolipid Structural Analysis and Glycosphingolipidomics. *Methods Enzymol.* **2005**, 405, 300-369.
- (481) Ishibashi, Y.; Nagamatsu, Y.; Meyer, S.; Imamura, A.; Ishida, H.; Kiso, M.; Okino, N.; Geyer, R.; Ito, M. Transglycosylation-Based Fluorescent Labeling of 6-Gala Series Glycolipids by Endogalactosylceramidase. *Glycobiology* **2009**, 19, 797-807.
- (482) Ishibashi, Y.; Kiyohara, M.; Okino, N.; Ito, M. Synthesis of Fluorescent Glycosphingolipids and Neoglycoconjugates Which Contain 6-Gala Oligosaccharides Using the Transglycosylation Reaction of a Novel Endoglycoceramidase (Egalc). *J. Biochem.* **2007**, 142, 239-246.
- (483) Miura, Y.; Arai, T.; Ohtake, A.; Ito, M.; Yamamoto, K.; Yamagata, T. Requirement for a Different Hydrophobic Moiety and Reliable Chromogenic Substrate for Endo-Type Glycosylceramidases. *Glycobiology* **1999**, 9, 957-960.
- (484) Horibata, Y.; Okino, N.; Ichinose, S.; Omori, A.; Ito, M. Purification, Characterization, and cDNA Cloning of a Novel Acidic Endoglycoceramidase from the Jellyfish, *Cyanea Nozakii*. *J. Biol. Chem.* **2000**, 275, 31297-31304.
- (485) Horibata, Y.; Higashi, H.; Ito, M. Transglycosylation and Reverse Hydrolysis Reactions of Endoglycoceramidase from the Jellyfish, *Cyanea Nozakii*. *J. Biochem.* **2001**, 130, 263-268.
- (486) Li, Y.; Carter, B. Z.; Rao, B.; Schweingruber, H.; Li, S.-C. Synthesis of Neoglycoconjugates Using Oligosaccharide Transferring Activity of Ceramide Glycanase. *J. Biol. Chem.* **1991**, 266, 10723-10726.
- (487) Nishimura, S.-I.; Yamada, K. Transfer of Ganglioside GM3 Oligosaccharide from a Water Soluble Polymer to Ceramide by Ceramide Glycanase. A Novel Approach for the Chemical-Enzymatic Synthesis of Glycosphingolipids. *J. Am. Chem. Soc.* **1997**, 119, 10555-10556.
- (488) Yamada, K.; Matsumoto, S.; Nishimura, S.-I. Efficient Synthesis of Non-Natural Ganglioside (Pseudo-GM3) and Fluorescent Labelled Lysogm3 on the Basis of Polymer-Assisted Enzymatic Strategy. *Chem. Comm.* **1999**, 1999, 507-508.

- (489) Ashida, H.; Tsuji, Y.; Yamamoto, K.; Kumagai, H.; Tochikura, T. Transglycosylation Activity of Endoglycoceramidase from *Corynebacterium* Sp. *Arch. Biochem. Biophys.* **1993**, *305*, 559-562.
- (490) Hirabayashi, Y.; Kimura, M.; Matsumoto, M.; Yamamoto, K.; Kadowaki, S.; Tochikura, T. A Novel Glycosphingolipid Hydrolyzing Enzyme, Glycosphingolipid Ceramide Deacylase, Which Cleaves the Linkage between the Fatty Acid and Sphingosine Base in Glycosphingolipids. *J. Biochem.* **1988**, *103*, 1-4.
- (491) Mitsutake, S.; Kita, K.; Nakagawa, T.; Ito, M. Enzymatic Synthesis of ¹⁴C-Glycosphingolipids by Reverse Hydrolysis Reaction of Sphingolipid Ceramide N-Deacylase: Detection of Endoglycoceramidase Activity in a Seaflower. *J. Biochem.* **1998**, *123*, 859-863.
- (492) Kita, K.; Okino, N.; Ito, M. Reverse Hydrolysis Reaction of a Recombinant Alkaline Ceramidase of *Pseudomonas Aeruginosa*. *Biochim. Biophys. Acta, Mol. Cell Biol. Lipids* **2000**, *1485*, 111-120.
- (493) Kita, K.; Kurita, T.; Ito, M. Characterization of the Reversible Nature of the Reaction Catalyzed by Sphingolipid Ceramide N-Deacylase. *Eur. J. Biochem.* **2001**, *268*, 592-602.
- (494) Ito, M.; Kurita, T.; Kita, K. A Novel Enzyme That Cleaves the N-Acyl Linkage of Ceramides in Various Glycosphingolipids as Well as Sphingomyelin to Produce Their Lyso Forms. *J. Biol. Chem.* **1995**, *270*, 24370-24374.
- (495) Kurita, T.; Izu, H.; Sano, M.; Ito, M.; Kato, I. Enhancement of Hydrolytic Activity of Sphingolipid Ceramide N-Deacylase in the Aqueous–Organic Biphasic System. *J. Lipid Res.* **2000**, *41*, 846-851.
- (496) Nakagawa, T.; Morotomi, A.; Tani, M.; Sueyoshi, N.; Komori, H.; Ito, M. C18: 3-Gm1a Induces Apoptosis in Neuro2a Cells: Enzymatic Remodeling of Fatty Acyl Chains of Glycosphingolipids. *J. Lipid Res.* **2005**, *46*, 1103-1112.
- (497) Tani, M.; Kita, K.; Komori, H.; Nakagawa, T.; Ito, M. Enzymatic Synthesis of Ω -Amino-Ceramide: Preparation of a Sensitive Fluorescent Substrate for Ceramidase. *Anal. Biochem.* **1998**, *263*, 183-188.
- (498) Hashimoto, M.; Hatanaka, Y.; Nabeta, K. Versatile Synthesis of Phenoxydiazirine-Based Fatty Acid Analogues and Photoreactive Galactosylceramide. *Bioorg. Med. Chem. Lett.* **2002**, *12*, 89-91.
- (499) Nakagawa, T.; Tani, M.; Kita, K.; Ito, M. Preparation of Fluorescence-Labeled GM1 and Sphingomyelin by the Reverse Hydrolysis Reaction of Sphingolipid Ceramide N-Deacylase as Substrates for Assay of Sphingolipid-Degrading Enzymes and for Detection of Sphingolipid-Binding Proteins. *J. Biochem.* **1999**, *126*, 604-611.
- (500) Kuchař, L.; Rotkova, J.; Asfaw, B.; Lenfeld, J.; Horak, D.; Korecka, L.; Bilkova, Z.; Ledvinova, J. Semisynthesis of C17: 0 Isoforms of Sulphatide and Glucosylceramide Using Immobilised Sphingolipid Ceramide N-Deacylase for Application in Analytical Mass Spectrometry. *Rapid Commun. Mass Spectrom.* **2010**, *24*, 2393-2399.

- (501) Furusato, M.; Sueyoshi, N.; Mitsutake, S.; Sakaguchi, K.; Kita, K.; Okino, N.; Ichinose, S.; Omori, A.; Ito, M. Molecular Cloning and Characterization of Sphingolipid Ceramide N-Deacylase from a Marine Bacterium, *Shewanella Alga G8*. *J. Biol. Chem.* **2002**, *277*, 17300-17307.
- (502) Han, Y.-B.; Wu, L.; Rich, J. R.; Huang, F.-T.; Withers, S. G.; Feng, Y.; Yang, G.-Y. Comprehensive Characterization of Sphingolipid Ceramide N-Deacylase for the Synthesis and Fatty Acid Remodeling of Glycosphingolipids. *Appl. Microbiol. Biotechnol.* **2015**, *99*, 6715-6726.
- (503) Huang, F.-T.; Han, Y.-B.; Feng, Y.; Yang, G.-Y. A Facile Method for Controlling the Reaction Equilibrium of Sphingolipid Ceramide N-Deacylase for Lyso-Glycosphingolipid Production. *J. Lipid Res.* **2015**, *56*, 1836-1842.
- (504) Gahmberg, C. G.; Hakomori, S.-i. External Labeling of Cell Surface Galactose and Galactosamine in Glycolipid and Glycoprotein of Human Erythrocytes. *J. Biol. Chem.* **1973**, *248*, 4311-4317.
- (505) McCombs, J. E.; Kohler, J. J. Chemoselective Reactions for Glycan Labeling. In *Chemoselective and Bioorthogonal Ligation Reactions: Concepts and Applications*, 2017.
- (506) Avigad, G.; Amaral, D.; Asensio, C.; Horecker, B. L. The D-Galactose Oxidase of *Polyporus Circinatus*. *J. Biol. Chem.* **1962**, *237*, 2736-2743.
- (507) Avigad, G.; Asensio, C.; Amaral, D.; Horecker, B. Galacto-Dialdose Production with an Enzyme from the Mold *Polyporus circinatus*. *Biochem. Biophys. Res. Commun.* **1961**, *4*, 474-477.
- (508) Ögel, Z. B.; Brayford, D.; McPherson, M. J. Cellulose-Triggered Sporulation in the Galactose Oxidase-Producing Fungus *Cladobotryum (Dactylium) dendroides* Nrrl 2903 and Its Re-Identification as a Species of *Fusarium*. *Mycol. Res.* **1994**, *98*, 474-480.
- (509) Niessen, M. L.; Vogel, R. F. Specific Identification of *Fusarium Graminearum* by Pcr with Gaoa Targeted Primers. *Syst. Appl. Microbiol.* **1997**, *20*, 111-123.
- (510) Agranoff, B. W.; Radin, N. S.; Suomi, W. Enzymic Oxidation of Cerebrosides: Studies on Gaucher's Disease. *Biochim. Biophys. Acta* **1962**, *57*, 194-196.
- (511) Whittaker, J. W. Free Radical Catalysis by Galactose Oxidase. *Chem. Rev.* **2003**, *103*, 2347-2364.
- (512) Hajra, A. K.; Bowen, D. M.; Kishimoto, Y.; Radin, N. S. Cerebroside Galactosidase of Brain. *J. Lipid Res.* **1966**, *7*, 379-386.
- (513) Kamlekar, R. K.; Simanshu, D. K.; Gao, Y.-g.; Kenoth, R.; Pike, H. M.; Prendergast, F. G.; Malinina, L.; Molotkovsky, J. G.; Venyaminov, S. Y.; Patel, D. J. The Glycolipid Transfer Protein (GLTP) Domain of Phosphoinositol 4-Phosphate Adaptor Protein-2 (FAPP2): Structure Drives Preference for Simple Neutral Glycosphingolipids. *Biochim. Biophys. Acta, Mol. Cell Biol. Lipids* **2013**, *1831*, 417-427.

- (514) Bradley, R. M.; Kanfer, J. N. The Action of Galactose Oxidase on Several Sphingoglycolipids. *Biochim. Biophys. Acta, Spec. Sect. Lipids Relat. Subj.* **1964**, *84*, 210-212.
- (515) Schlegel, R. A.; Gerbeck, C. M.; Montgomery, R. Substrate Specificity of D-Galactose Oxidase. *Carbohydr. Res.* **1968**, *7*, 193-199.
- (516) Steck, T. L.; Dawson, G. Topographical Distribution of Complex Carbohydrates in the Erythrocyte Membrane. *J. Biol. Chem.* **1974**, *249*, 2135-2142.
- (517) Masserini, M.; Sonnino, S.; Ghidoni, R.; Chigorno, V.; Tettamanti, G. Galactose Oxidase Action on GM1 Ganglioside in Micellar and Vesicular Dispersions. *Biochim. Biophys. Acta, Biomembr.* **1982**, *688*, 333-340.
- (518) Suzuki, Y.; Suzuki, K. Specific Radioactive Labeling of Terminal N-Acetylgalactosamine of Glycosphingolipids by the Galactose Oxidase–Sodium Borohydride Method. *J. Lipid Res.* **1972**, *13*, 687-690.
- (519) Parikka, K.; Master, E.; Tenkanen, M. Oxidation with Galactose Oxidase: Multifunctional Enzymatic Catalysis. *J. Mol. Catal. B: Enzym.* **2015**, *120*, 47-59.
- (520) Rannes, J. B.; Ioannou, A.; Willies, S. C.; Grogan, G.; Behrens, C.; Flitsch, S. L.; Turner, N. J. Glycoprotein Labeling Using Engineered Variants of Galactose Oxidase Obtained by Directed Evolution. *J. Am. Chem. Soc.* **2011**, *133*, 8436-8439.
- (521) Kobata, A. Exo-and Endoglycosidases Revisited. *Proc. Jpn. Acad., Ser. B* **2013**, *89*, 97-117.
- (522) Saito, M.; Sugano, K.; Nagai, Y. Action of *Arthrobacter Ureafaciens* Sialidase on Sialoglycolipid Substrates. Mode of Action and Highly Specific Recognition of the Oligosaccharide Moiety of Ganglioside GM1. *J. Biol. Chem.* **1979**, *254*, 7845-7854.
- (523) Seyrantepe, V.; Landry, K.; Trudel, S.; Hassan, J. A.; Morales, C. R.; Pshezhetsky, A. V. Neu4, a Novel Human Lysosomal Lumen Sialidase, Confers Normal Phenotype to Sialidosis and Galactosialidosis Cells. *J. Biol. Chem.* **2004**, *279*, 37021-37029.
- (524) Kolodny, E. H.; Brady, R. O.; Volk, B. W. Demonstration of an Alteration of Ganglioside Metabolism in Tay-Sachs Disease. *Biochem. Biophys. Res. Commun.* **1969**, *37*, 526-531.
- (525) Kolodny, E. H.; Brady, R.; Quirk, J.; Kanfer, J. Preparation of Radioactive Tay-Sachs Ganglioside Labeled in the Sialic Acid Moiety. *J. Lipid Res.* **1970**, *11*, 144-149.
- (526) Turnbull, W. B.; Precious, B. L.; Homans, S. W. Dissecting the Cholera Toxin–Ganglioside Gm1 Interaction by Isothermal Titration Calorimetry. *J. Am. Chem. Soc.* **2004**, *126*, 1047-1054.
- (527) Cumar, F. A.; Tallman, J. F.; Brady, R. O. The Biosynthesis of a Disialylganglioside by Galactosyltransferase from Rat Brain Tissue. *J. Biol. Chem.* **1972**, *247*, 2322-2327.

- (528) Klenk, E.; Hof, L. On the Knowledge of Cerebral Gangliosides. Transformation of Ganglioside C-1 into Ganglioside a-1. *Acta Biol. Med. Ger.* **1967**, *19*, 763-766.
- (529) Meier, E.; Schwarzmann, G.; Fürst, W.; Sandhoff, K. The Human GM2 Activator Protein. A Substrate Specific Cofactor of Beta-Hexosaminidase A. *J. Biol. Chem.* **1991**, *266*, 1879-1887.
- (530) Fang, J.; Li, J.; Chen, X.; Zhang, Y.; Wang, J.; Guo, Z.; Zhang, W.; Yu, L.; Brew, K.; Wang, P. G. Highly Efficient Chemoenzymatic Synthesis of α -Galactosyl Epitopes with a Recombinant $\alpha(1\rightarrow3)$ -Galactosyltransferase. *J. Am. Chem. Soc.* **1998**, *120*, 6635-6638.
- (531) Sauerzapfe, B.; Křenek, K.; Schmiedel, J.; Wakarchuk, W. W.; Pelantová, H.; Křen, V.; Elling, L. Chemo-Enzymatic Synthesis of Poly-N-Acetyllactosamine (Poly-Lacnac) Structures and Their Characterization for Cgl2-Galectin-Mediated Binding of Ecm Glycoproteins to Biomaterial Surfaces. *Glycoconjugate J.* **2009**, *26*, 141-159.
- (532) Lau, K.; Thon, V.; Yu, H.; Ding, L.; Chen, Y.; Muthana, M. M.; Wong, D.; Huang, R.; Chen, X. Highly Efficient Chemoenzymatic Synthesis of Beta 1-4-Linked Galactosides with Promiscuous Bacterial Beta 1-4-Galactosyltransferases. *Chem. Comm.* **2010**, *46*, 6066-6068.
- (533) Sujino, K.; Uchiyama, T.; Hindsgaul, O.; Seto, N. O. L.; Wakarchuk, W. W.; Palcic, M. M. Enzymatic Synthesis of Oligosaccharide Analogues: Evaluation of UDP-Gal Analogues as Donors for Three Retaining α -Galactosyltransferases. *J. Am. Chem. Soc.* **2000**, *122*, 1261-1269.
- (534) Yi, W.; Shen, J.; Zhou, G.; Li, J.; Wang, P. G. Bacterial Homologue of Human Blood Group a Transferase. *J. Am. Chem. Soc.* **2008**, *130*, 14420-14421.
- (535) Yao, W.; Yan, J.; Chen, X.; Wang, F.; Cao, H. Chemoenzymatic Synthesis of Lacto-N-Tetrasaccharide and Sialyl Lacto-N-Tetrasaccharides. *Carbohydr. Res.* **2015**, *401*, 5-10.
- (536) Wang, T.; Wei, J.; Wang, N.; Ma, J.-L.; Hui, P.-P. The Glucosylceramide Synthase Inhibitor PDMP Sensitizes Pancreatic Cancer Cells to MEK/ERK Inhibitor AZD-6244. *Biochem. Biophys. Res. Commun.* **2015**, *456*, 821-826.
- (537) Hoetzl, S.; Sprong, H.; Van Meer, G. The Way We View Cellular (Glyco)Sphingolipids. *J. Neurochem.* **2007**, *103*, 3-13.
- (538) Schwarzmann, G.; Arenz, C.; Sandhoff, K. Labeled Chemical Biology Tools for Investigating Sphingolipid Metabolism, Trafficking and Interaction with Lipids and Proteins. *Biochim. Biophys. Acta, Mol. Cell Biol. Lipids* **2014**, *1841*, 1161-1173.
- (539) Stocker, B. L.; Timmer, M. S. M. Chemical Tools for Studying the Biological Function of Glycolipids. *Chembiochem* **2013**, *14*, 1164-1184.
- (540) Yan, H. B.; Yalagala, R. S.; Yan, F. Y. Fluorescently Labelled Glycans and Their Applications. *Glycoconjugate J.* **2015**, *32*, 559-574.

- (541) Kishimoto, Y.; Radin, N. S. Metabolism of Brain Glycolipid Fatty Acids. *Lipids* **1966**, *1*, 47-61.
- (542) Dube, D. H.; Bertozzi, C. R. Metabolic Oligosaccharide Engineering as a Tool for Glycobiology. *Curr. Opin. Chem. Biol.* **2003**, *7*, 616-625.
- (543) Sminia, T. J.; Zuilhof, H.; Wennekes, T. Getting a Grip on Glycans: A Current Overview of the Metabolic Oligosaccharide Engineering Toolbox. *Carbohydr. Res.* **2016**, *435*, 121-141.
- (544) Nischan, N.; Kohler, J. J. Advances in Cell Surface Glycoengineering Reveal Biological Function. *Glycobiology* **2016**, *26*, 789-796.
- (545) Goon, S.; Bertozzi, C. R. Metabolic Substrate Engineering as a Tool for Glycobiology. *J. Carbohydr. Chem.* **2002**, *21*, 943-977.
- (546) Du, J.; Meledeo, M. A.; Wang, Z.; Khanna, H. S.; Paruchuri, V. D.; Yarema, K. J. Metabolic Glycoengineering: Sialic Acid and Beyond. *Glycobiology* **2009**, *19*, 1382-1401.
- (547) Wang, Z.; Du, J.; Che, P.-L.; Meledeo, M. A.; Yarema, K. J. Hexosamine Analogs: From Metabolic Glycoengineering to Drug Discovery. *Curr. Opin. Chem. Biol.* **2009**, *13*, 565-572.
- (548) Wang, Q.; Zhang, J.; Guo, Z. Efficient Glycoengineering of GM3 on Melanoma Cell and Monoclonal Antibody-Mediated Selective Killing of the Glycoengineered Cancer Cell. *Bioorg. Med. Chem.* **2007**, *15*, 7561-7567.
- (549) Zou, W.; Borrelli, S.; Gilbert, M.; Liu, T.; Pon, R. A.; Jennings, H. J. Bioengineering of Surface GD3 Ganglioside for Immunotargeting Human Melanoma Cells. *J. Biol. Chem.* **2004**, *279*, 25390-25399.
- (550) Cairo, C. W.; Key, J. A.; Sadek, C. M. Fluorescent Small-Molecule Probes of Biochemistry at the Plasma Membrane. *Curr. Opin. Chem. Biol.* **2010**, *14*, 57-63.
- (551) Klymchenko, Andrey S.; Kreder, R. Fluorescent Probes for Lipid Rafts: From Model Membranes to Living Cells. *Chem. Biol.* **2014**, *21*, 97-113.
- (552) Kishimoto, T.; Ishitsuka, R.; Kobayashi, T. Detectors for Evaluating the Cellular Landscape of Sphingomyelin- and Cholesterol-Rich Membrane Domains. *Biochim. Biophys. Acta, Mol. Cell Biol. Lipids* **2016**, *1861*, 812-829.
- (553) Vishwakarma, R. A.; Menon, A. K. Flip-Flop of Glycosylphosphatidylinositols (GPI's) across the ER. *Chem. Comm.* **2005**, *2005*, 453-455.
- (554) Yadav, M.; Raghupathy, R.; Saikam, V.; Dara, S.; Singh, P. P.; Sawant, S. D.; Mayor, S.; Vishwakarma, R. A. Synthesis of Non-Hydrolysable Mimics of Glycosylphosphatidylinositol (GPI) Anchors. *Org. Biomol. Chem.* **2014**, *12*, 1163-1172.

- (555) Mayer, T. G.; Weingart, R.; Muenstermann, F.; Kawada, T.; Kurzchalia, T.; Schmidt, R. R. Synthesis of Labeled Glycosyl Phosphatidyl Inositol (GPI) Anchors. *Eur. J. Org. Chem.* **1999**, *1999*, 2563-2571.
- (556) Saikam, V.; Raghupathy, R.; Yadav, M.; Gannedi, V.; Singh, P. P.; Qazi, N. A.; Sawant, S. D.; Vishwakarma, R. A. Synthesis of New Fluorescently Labeled Glycosylphosphatidylinositol (GPI) Anchors. *Tetrahedron Lett.* **2011**, *52*, 4277-4279.
- (557) Paulick, M. G.; Wise, A. R.; Forstner, M. B.; Groves, J. T.; Bertozzi, C. R. Synthetic Analogues of Glycosylphosphatidylinositol-Anchored Proteins and Their Behavior in Supported Lipid Bilayers. *J. Am. Chem. Soc.* **2007**, *129*, 11543-11550.
- (558) Rosenfelder, G.; Eijk, R. V. W.; Mühlradt, P. F. Metabolic Carbohydrate-Labeling of Glycolipids from Mouse Splenocytes. *FEBS J.* **1979**, *97*, 229-237.
- (559) Rosenfelder, G.; Eijk, R. V. W.; Monner, D. A.; Mühlradt, P. F. Glycolipids in Mouse Thymocytes Stimulated by Concanavalin A. *FEBS J.* **1978**, *83*, 571-580.
- (560) Eijk, R.; Mühlradt, P. Carbohydrate Incorporation in Plasma Membranes of Mouse Thymocytes Stimulated by Concanavalin A. *FEBS J.* **1977**, *78*, 41-54.
- (561) Diaz, S.; Varki, A. Metabolic Radiolabeling of Animal Cell Glycoconjugates. In *Current Protocols in Molecular Biology*; John Wiley & Sons, Inc., 2001.
- (562) Liu, Y.; Su, Y.; Wiznitzer, M.; Epifano, O.; Ladisch, S. Ganglioside Depletion and Egf Responses of Human GM3 Synthase-Deficient Fibroblasts. *Glycobiology* **2008**, *18*, 593-601.
- (563) Liu, Y.; Yan, S.; Assefa Wondimu, D. B.; Weiss, M.; Sliwinski, K.; Villar, J.; Notario, V.; Sutherland, M.; Colberg-Poley, A. M.; Ladisch, S. Ganglioside Synthase Knockout in Oncogene-Transformed Fibroblasts Depletes Gangliosides and Impairs Tumor Growth. *Oncogene* **2010**, *29*, 3297-3306.
- (564) Dolo, V.; Li, R.; Dillinger, M.; Flati, S.; Manela, J.; Taylor, B. J.; Pavan, A.; Ladisch, S. Enrichment and Localization of Ganglioside GD3 and Caveolin-1 in Shed Tumor Cell Membrane Vesicles. *Biochim. Biophys. Acta, Mol. Cell Biol. Lipids* **2000**, *1486*, 265-274.
- (565) Li, R.; Manela, J.; Kong, Y.; Ladisch, S. Cellular Gangliosides Promote Growth Factor-Induced Proliferation of Fibroblasts. *J. Biol. Chem.* **2000**, *275*, 34213-34223.
- (566) Jimbo, M.; Yamagishi, K.; Yamaki, T.; Nunomura, K.; Kabayama, K.; Igarashi, Y.; Inokuchi, J.-i. Development of a New Inhibitor of Glucosylceramide Synthase. *J. Biochem.* **2000**, *127*, 485-491.
- (567) D'Angelo, G.; Uemura, T.; Chuang, C.-C.; Polishchuk, E.; Santoro, M.; Ohvo-Rekila, H.; Sato, T.; Di Tullio, G.; Varriale, A.; D'Auria, S. et al. Vesicular and Non-Vesicular Transport Feed Distinct Glycosylation Pathways in the Golgi. *Nature* **2013**, *501*, 116-120.

- (568) Lund, N.; Branch, D. R.; Mylvaganam, M.; Chark, D.; Ma, X.-Z.; Sakac, D.; Binnington, B.; Fantini, J.; Puri, A.; Blumenthal, R. A Novel Soluble Mimic of the Glycolipid, Globotriaosyl Ceramide Inhibits HIV Infection. *AIDS* **2006**, *20*, 333-343.
- (569) Crespo, P. M.; Zurita, A. R.; Giraudo, C. G.; Maccioni, H. J.; Daniotti, J. L. Ganglioside Glycosyltransferases and Newly Synthesized Gangliosides Are Excluded from Detergent-Insoluble Complexes of Golgi Membranes. *Biochem. J.* **2004**, *377*, 561-568.
- (570) Zurita, A. R.; Maccioni, H. J. F.; Daniotti, J. L. Modulation of Epidermal Growth Factor Receptor Phosphorylation by Endogenously Expressed Gangliosides. *Biochem. J.* **2001**, *355*, 465-472.
- (571) Crespo, P. M.; von Muhlinen, N.; Iglesias-Bartolomé, R.; Daniotti, J. L. Complex Gangliosides Are Apically Sorted in Polarized MDCK Cells and Internalized by Clathrin-Independent Endocytosis. *FEBS J.* **2008**, *275*, 6043-6056.
- (572) Ziulkoski, A. L.; Andrade, C. M.; Crespo, P. M.; Sisti, E.; Trindade, V. M.; Daniotti, J. L.; Guma, F. C.; Borojevic, R. Gangliosides of Myelosupportive Stroma Cells Are Transferred to Myeloid Progenitors and Are Required for Their Survival and Proliferation. *Biochem. J.* **2006**, *394*, 1-9.
- (573) Rodriguez-Walker, M.; Vilcaes, A. A.; Garbarino-Pico, E.; Daniotti, J. L. Role of Plasma-Membrane-Bound Sialidase NEU3 in Clathrin-Mediated Endocytosis. *Biochem. J.* **2015**, *470*, 131-144.
- (574) Crespo, P. M.; Silvestre, D. C.; Gil, G. A.; Maccioni, H. J.; Daniotti, J. L.; Caputto, B. L. c-Fos Activates Glucosylceramide Synthase and Glycolipid Synthesis in PC12 Cells. *J. Biol. Chem.* **2008**, *283*, 31163-31171.
- (575) Yamagishi, K.; Mishima, K.; Ohgami, Y.; Iwasaki, K.; Jimbo, M.; Masuda, H.; Igarashi, Y.; Inokuchi, J.-i.; Fujiwara, M. A Synthetic Ceramide Analog Ameliorates Spatial Cognition Deficit and Stimulates Biosynthesis of Brain Gangliosides in Rats with Cerebral Ischemia. *Eur. J. Pharmacol.* **2003**, *462*, 53-60.
- (576) Weiss, M.; Hettmer, S.; Smith, P.; Ladisch, S. Inhibition of Melanoma Tumor Growth by a Novel Inhibitor of Glucosylceramide Synthase. *Cancer Res.* **2003**, *63*, 3654-3658.
- (577) De Rosa, M. F.; Sillence, D.; Ackerley, C.; Lingwood, C. Role of Multiple Drug Resistance Protein 1 in Neutral but Not Acidic Glycosphingolipid Biosynthesis. *J. Biol. Chem.* **2004**, *279*, 7867-7876.
- (578) Eckhardt, M.; Fewou, S. N.; Ackermann, I.; Gieselmann, V. N-Glycosylation Is Required for Full Enzymic Activity of the Murine Galactosylceramide Sulphotransferase. *Biochem. J.* **2002**, *368*, 317-324.
- (579) Sahores, M.; Prinetti, A.; Chiabrando, G.; Blasi, F.; Sonnino, S. Upa Binding Increases Upar Localization to Lipid Rafts and Modifies the Receptor Microdomain Composition. *Biochim. Biophys. Acta, Biomembr.* **2008**, *1778*, 250-259.

- (580) Prioni, S.; Loberto, N.; Prinetti, A.; Chigorno, V.; Guzzi, F.; Maggi, R.; Parenti, M.; Sonnino, S. Sphingolipid Metabolism and Caveolin Expression in Gonadotropin-Releasing Hormone-Expressing Gn11 and Gonadotropin-Releasing Hormone-Secreting Gt1-7 Neuronal Cells. *Neurochem. Res.* **2002**, *27*, 831-840.
- (581) Valaperta, R.; Chigorno, V.; Basso, L.; Prinetti, A.; Bresciani, R.; Preti, A.; Miyagi, T.; Sonnino, S. Plasma Membrane Production of Ceramide from Ganglioside GM3 in Human Fibroblasts. *FASEB J.* **2006**, *20*, 1227-1229.
- (582) Silvestri, I.; Testa, F.; Zappasodi, R.; Cairo, C.; Zhang, Y.; Lupo, B.; Galli, R.; Di Nicola, M.; Venerando, B.; Tringali, C. Sialidase Neu4 Is Involved in Glioblastoma Stem Cell Survival. *Cell Death Dis.* **2014**, *5*, e1381.
- (583) Prinetti, A.; Millimaggi, D.; D'ascenzo, S.; Clarkson, M.; Bettiga, A.; Chigorno, V.; Sonnino, S.; Pavan, A.; Dolo, V. Lack of Ceramide Generation and Altered Sphingolipid Composition Are Associated with Drug Resistance in Human Ovarian Carcinoma Cells. *Biochem. J.* **2006**, *395*, 311-318.
- (584) Bettiga, A.; Aureli, M.; Colciago, G.; Murdica, V.; Moschini, M.; Lucianò, R.; Canals, D.; Hannun, Y.; Hedlund, P.; Lavorgna, G. Bladder Cancer Cell Growth and Motility Implicate Cannabinoid 2 Receptor-Mediated Modifications of Sphingolipids Metabolism. *Sci. Rep.* **2017**, *7*, doi: 10.1038/srep42157.
- (585) Bonardi, D.; Papini, N.; Pasini, M.; Dileo, L.; Orizio, F.; Monti, E.; Caimi, L.; Venerando, B.; Bresciani, R. Sialidase NEU3 Dynamically Associates to Different Membrane Domains Specifically Modifying Their Ganglioside Pattern and Triggering Akt Phosphorylation. *PLoS One* **2014**, *9*, e99405.
- (586) Tringali, C.; Silvestri, I.; Testa, F.; Baldassari, P.; Anastasia, L.; Mortarini, R.; Anichini, A.; López-Requena, A.; Tettamanti, G.; Venerando, B. Molecular Subtyping of Metastatic Melanoma Based on Cell Ganglioside Metabolism Profiles. *BMC Cancer* **2014**, *14*, 560.
- (587) De Silva, A. D.; Park, J.-J.; Matsuki, N.; Stanic, A. K.; Brutkiewicz, R. R.; Medof, M. E.; Joyce, S. Lipid Protein Interactions: The Assembly of CD1d1 with Cellular Phospholipids Occurs in the Endoplasmic Reticulum. *J. Immunol.* **2002**, *168*, 723-733.
- (588) Vainauskas, S.; Cortes, L. K.; Taron, C. H. In Vivo Incorporation of an Azide-Labeled Sugar Analog to Detect Mammalian Glycosylphosphatidylinositol Molecules Isolated from the Cell Surface. *Carbohydr. Res.* **2012**, *362*, 62-69.
- (589) Baumann, N. A.; Vidugiriene, J.; Machamer, C. E.; Menon, A. K. Cell Surface Display and Intracellular Trafficking of Free Glycosylphosphatidylinositols in Mammalian Cells. *J. Biol. Chem.* **2000**, *275*, 7378-7389.
- (590) Quinlan, L.; Kane, M. Nature of Glycosylphosphatidylinositols Produced by Mouse Embryonic Stem Cells. *Reproduction* **2001**, *122*, 785-791.
- (591) Wongkajornsilp, A.; Sevlever, D.; Rosenberry, T. L. Metabolism of Exogenous Sn-1-Alkyl-Sn-2-Lyso-Glucosaminyl-Phosphatidylinositol in HeLa D Cells: Accumulation of

- Glucosaminyl (Acyl) Phosphatidylinositol in a Metabolically Inert Compartment. *Biochem. J.* **2001**, *359*, 305-313.
- (592) HEPWORTH, M. R.; RAIKWAR, N. S.; SEVLEVER, D. Effect of Glycosylphosphatidylinositol (GPI)-Phospholipase D Overexpression on GPI Metabolism. *Biochem. J.* **2004**, *378*, 641-648.
- (593) Bütikofer, P.; Greganova, E.; Liu, Y.-C.; Edwards, I. J.; Lehane, M. J.; Acosta-Serrano, A. Lipid Remodelling of Glycosylphosphatidylinositol (GPI) Glycoconjugates in Procytic-Form Trypanosomes: Biosynthesis and Processing of Gpis Revisited. *Biochem. J.* **2010**, *428*, 409-418.
- (594) Pelosi, L.; Boumediene, M.; Saksouk, N.; Geiselmann, J.; Geremia, R. A. The Glucosyl-1-Phosphate Transferase Wcha (Cap8E) Primes the Capsular Polysaccharide Repeat Unit Biosynthesis of Streptococcus Pneumoniae Serotype 8. *Biochem. Biophys. Res. Commun.* **2005**, *327*, 857-865.
- (595) Smith, T. K.; Crossman, A.; Paterson, M. J.; Borissow, C. N.; Brimacombe, J. S.; Ferguson, M. A. Specificities of Enzymes of Glycosylphosphatidylinositol Biosynthesis in Trypanosoma Brucei and HeLa Cells. *J. Biol. Chem.* **2002**, *277*, 37147-37153.
- (596) Sonnino, S.; Chigorno, V.; Tettamanti, G. [50] Preparation of Radioactive Gangliosides, ³H or ¹⁴C Isotopically Labeled at Oligosaccharide or Ceramide Moieties. *Methods Enzymol.* **2000**, *311*, 639-656.
- (597) Sonnino, S.; Nicolini, M.; Chigorno, V. Preparation of Rediolabeled Gangliosides. *Glycobiology* **1996**, *6*, 479-487.
- (598) Tettamanti, G.; Anastasia, L. Chemistry, Tissue and Cellular Distribution, and Developmental Profiles of Neural Sphingolipids. In *Handbook of Neurochemistry and Molecular Neurobiology: Neural Lipids*; Lajtha, A.; Tettamanti, G.; Goracci, G., Eds.; Springer, 2010.
- (599) Shiozaki, K.; Takahashi, K.; Hosono, M.; Yamaguchi, K.; Hata, K.; Shiozaki, M.; Bassi, R.; Prinetti, A.; Sonnino, S.; Nitta, K. Phosphatidic Acid-Mediated Activation and Translocation to the Cell Surface of Sialidase NEU3, Promoting Signaling for Cell Migration. *FASEB J.* **2015**, *29*, 2099-2111.
- (600) Mandal, C.; Tringali, C.; Mondal, S.; Anastasia, L.; Chandra, S.; Venerando, B.; Mandal, C. Down Regulation of Membrane-Bound Neu3 Constitutes a New Potential Marker for Childhood Acute Lymphoblastic Leukemia and Induces Apoptosis Suppression of Neoplastic Cells. *Int. J. Cancer* **2010**, *126*, 337-349.
- (601) Papini, N.; Anastasia, L.; Tringali, C.; Dileo, L.; Carubelli, I.; Sampaolesi, M.; Monti, E.; Tettamanti, G.; Venerando, B. MmNEU3 Sialidase over-Expression in C2C12 Myoblasts Delays Differentiation and Induces Hypertrophic Myotube Formation. *J. Cell. Biochem.* **2012**, *113*, 2967-2978.

- (602) Tringali, C.; Lupo, B.; Anastasia, L.; Papini, N.; Monti, E.; Bresciani, R.; Tettamanti, G.; Venerando, B. Expression of Sialidase Neu2 in Leukemic K562 Cells Induces Apoptosis by Impairing Bcr-Abl/Src Kinases Signaling. *J. Biol. Chem.* **2007**, *282*, 14364-14372.
- (603) Tringali, C.; Lupo, B.; Cirillo, F.; Papini, N.; Anastasia, L.; Lamorte, G.; Colombi, P.; Bresciani, R.; Monti, E.; Tettamanti, G. Silencing of Membrane-Associated Sialidase Neu3 Diminishes Apoptosis Resistance and Triggers Megakaryocytic Differentiation of Chronic Myeloid Leukemic Cells K562 through the Increase of Ganglioside GM3. *Cell Death Differ.* **2009**, *16*, 164-174.
- (604) Tringali, C.; Anastasia, L.; Papini, N.; Bianchi, A.; Ronzoni, L.; Cappellini, M. D.; Monti, E.; Tettamanti, G.; Venerando, B. Modification of Sialidase Levels and Sialoglycoconjugate Pattern During Erythroid and Erytroleukemic Cell Differentiation. *Glycoconjugate J.* **2007**, *24*, 67-79.
- (605) Aureli, M.; Prioni, S.; Mauri, L.; Loberto, N.; Casellato, R.; Ciampa, M. G.; Chigorno, V.; Prinetti, A.; Sonnino, S. Photoactivable Sphingosine as a Tool to Study Membrane Microenvironments in Cultured Cells. *J. Lipid Res.* **2010**, *51*, 798-808.
- (606) Reis, M. G.; Bibiloni, R.; McJarrow, P.; MacGibbon, A.; Fong, B.; Bassett, S.; Roy, N.; dos Reis, M. M. Isotopic Labeling of Milk Disialogangliosides (GD3). *Chem. Phys. Lipids* **2016**, *200*, 104-112.
- (607) Dolo, V.; D'Ascenzo, S.; Sorice, M.; Pavan, A.; Sciannamblo, M.; Prinetti, A.; Chigorno, V.; Tettamanti, G.; Sonnino, S. New Approaches to the Study of Sphingolipid Enriched Membrane Domains: The Use of Microscopic Autoradiography to Reveal Metabolically Tritium Labeled Sphingolipids in Cell Cultures. *Glycoconjugate J.* **2000**, *17*, 261-268.
- (608) Panasiewicz, M.; Domek, H.; Fedoryszak, N.; Pacuszka, T. Preparation of Alexa Fluor 350-Conjugated Nonradioactive or 3 H-Labeled GM1 Ganglioside Derivatives with Different Ceramides. *Anal. Biochem.* **2009**, *385*, 168-170.
- (609) Kraft, M. L.; Klitzing, H. A. Imaging Lipids with Secondary Ion Mass Spectrometry. *Biochim. Biophys. Acta, Mol. Cell Biol. Lipids* **2014**, *1841*, 1108-1119.
- (610) Sezgin, E.; Levental, I.; Grzybek, M.; Schwarzmann, G.; Mueller, V.; Honigsmann, A.; Belov, V. N.; Eggeling, C.; Coskun, Ü.; Simons, K. Partitioning, Diffusion, and Ligand Binding of Raft Lipid Analogs in Model and Cellular Plasma Membranes. *Biochim. Biophys. Acta, Biomembr.* **2012**, *1818*, 1777-1784.
- (611) Bergelson, L.; Molotkovsky, J. G.; Manevich, Y. Lipid-Specific Fluorescent Probes in Studies of Biological Membranes. *Chem. Phys. Lipids* **1985**, *37*, 165-195.
- (612) Kraut, R.; Bag, N.; Wohland, T. Fluorescence Correlation Methods for Imaging Cellular Behavior of Sphingolipid-Interacting Probes. *Methods Cell Biol.* **2012**, *108*, 395-427.
- (613) Molotkovsky, J. G.; Mikhalyov, I. I.; Imbs, A. B.; Bergelson, L. D. Synthesis and Characterization of New Fluorescent Glycolipid Probes. Molecular Organisation of Glycosphingolipids in Mixed-Composition Lipid Bilayers. *Chem. Phys. Lipids* **1991**, *58*, 199-212.

- (614) Sezgin, E.; Levental, I.; Mayor, S.; Eggeling, C. The Mystery of Membrane Organization: Composition, Regulation and Roles of Lipid Rafts. *Nat. Rev. Mol. Cell Biol.* **2017**, *18*, 361-374.
- (615) Komura, N.; Suzuki, K. G.; Ando, H.; Konishi, M.; Imamura, A.; Ishida, H.; Kusumi, A.; Kiso, M. Syntheses of Fluorescent Gangliosides for the Studies of Raft Domains. *Methods Enzymol.* **2017**, *597*, 239-263.
- (616) Kinoshita, M.; Suzuki, K. G.; Matsumori, N.; Takada, M.; Ano, H.; Morigaki, K.; Abe, M.; Makino, A.; Kobayashi, T.; Hirose, K. M. Raft-Based Sphingomyelin Interactions Revealed by New Fluorescent Sphingomyelin Analogs. *J. Cell Biol.* **2017**, jcb. 201607086.
- (617) Rasmussen, J.-A. M.; Hermetter, A. Chemical Synthesis of Fluorescent Glycerol- and Sphingolipids. *Prog. Lipid Res.* **2008**, *47*, 436-460.
- (618) Kuerschner, L.; Thiele, C. Multiple Bonds for the Lipid Interest. *Biochim. Biophys. Acta, Mol. Cell Biol. Lipids* **2014**, *1841*, 1031-1037.
- (619) Kuerschner, L.; Ejsing, C. S.; Ekroos, K.; Shevchenko, A.; Anderson, K. I.; Thiele, C. Polyene-Lipids: A New Tool to Image Lipids. *Nat. Mater.* **2004**, *2*, 39-45.
- (620) Patalag, L. J.; Sibold, J.; Schütte, O. M.; Steinem, C.; Werz, D. B. Gb3 Glycosphingolipids with Fluorescent Oligoene Fatty Acids: Synthesis and Phase Behavior in Model Membranes. *ChemBioChem* **2017**, *18*, 2171-2178.
- (621) Matshita, Y.; Takahashi, M.; Moriguchi, I. Binding of Fluorescent 7-Amino-4-Nitrobenzoxadiazole Derivatives to Bovine Serum Albumin. *Chem. Pharm. Bull.* **1986**, *34*, 333-339.
- (622) Chattopadhyay, A. Chemistry and Biology of N-(7-Nitrobenz-2-Oxa-1, 3-Diazol-4-Yl)-Labeled Lipids: Fluorescent Probes of Biological and Model Membranes. *Chem. Phys. Lipids* **1990**, *53*, 1-15.
- (623) Chattopadhyay, A.; London, E. Parallax Method for Direct Measurement of Membrane Penetration Depth Utilizing Fluorescence Quenching by Spin-Labeled Phospholipids. *Biochemistry* **1987**, *26*, 39-45.
- (624) Robalo, J. R.; Ramalho, J. P. P.; Loura, L. M. S. NBD-Labeled Cholesterol Analogues in Phospholipid Bilayers: Insights from Molecular Dynamics. *J. Phys. Chem. B.* **2013**, *117*, 13731-13742.
- (625) Marks, D. L.; Bittman, R.; Pagano, R. E. Use of Bodipy-Labeled Sphingolipid and Cholesterol Analogs to Examine Membrane Microdomains in Cells. *Histochem. Cell Biol.* **2008**, *130*, 819-832.
- (626) Lipsky, N. G.; Pagano, R. E. Sphingolipid Metabolism in Cultured Fibroblasts: Microscopic and Biochemical Studies Employing a Fluorescent Ceramide Analogue. *Proc. Natl. Acad. Sci. U. S. A.* **1983**, *80*, 2608-2612.

- (627) Lala, P.; Ito, S.; Lingwood, C. A. Retroviral Transfection of Madin-Darby Canine Kidney Cells with Human Mdr1 Results in a Major Increase in Globotriaosylceramide and 105-to 106-Fold Increased Cell Sensitivity to Verocytotoxin Role of P-Glycoprotein in Glycolipid Synthesis. *J. Biol. Chem.* **2000**, *275*, 6246-6251.
- (628) Li, L.; Ståhlman, M.; Rutberg, M.; Håversen, L.; Fogelstrand, P.; Andersson, L.; Levin, M.; Borén, J. ARF6 Regulates Neuron Differentiation through Glucosylceramide Synthase. *PLoS One* **2013**, *8*, e60118.
- (629) Kim, R.; Lou, K.; Kraft, M. L. A New, Long-Wavelength Borondipyrromethene Sphingosine for Studying Sphingolipid Dynamics in Live Cells. *J. Lipid Res.* **2013**, *54*, 265-275.
- (630) Peters, C.; Billich, A.; Ghobrial, M.; Högenauer, K.; Ullrich, T.; Nussbaumer, P. Synthesis of Borondipyrromethene (BODIPY)-Labeled Sphingosine Derivatives by Cross-Metathesis Reaction. *J. Org. Chem.* **2007**, *72*, 1842-1845.
- (631) Van't Hof, W.; Silvius, J.; Wieland, F.; Van Meer, G. Epithelial Sphingolipid Sorting Allows for Extensive Variation of the Fatty Acyl Chain and the Sphingosine Backbone. *Biochem. J.* **1992**, *283*, 913-917.
- (632) Babia, T.; Ledesma, M. D.; Saffrich, R.; Kok, J. W.; Dotti, C. G.; Egea, G. Endocytosis of NBD-Sphingolipids in Neurons: Exclusion from Degradative Compartments and Transport to the Golgi Complex. *Traffic* **2001**, *2*, 395-405.
- (633) Tomás, M.; Durán, J. M.; Lázaro-Diéguéz, F.; Babià, T.; Renau-Piqueras, J.; Egea, G. Fluorescent Analogues of Plasma Membrane Sphingolipids Are Sorted to Different Intracellular Compartments in Astrocytes. *FEBS Lett.* **2004**, *563*, 59-65.
- (634) Schwarzmann, G.; Sandhoff, K. Lysogangliosides: Synthesis and Use in Preparing Labeled Gangliosides. *Methods Enzymol.* **1987**, *138*, 319-341.
- (635) Tropak, M. B.; Bukovac, S. W.; Rigat, B. A.; Yonekawa, S.; Wakarchuk, W.; Mahuran, D. J. A Sensitive Fluorescence-Based Assay for Monitoring GM2 Ganglioside Hydrolysis in Live Patient Cells and Their Lysates. *Glycobiology* **2009**, *20*, 356-365.
- (636) Sakai, T.; Ehara, H.; Koezuka, Y. Synthesis of NBD- α -Galactosylceramide and Its Immunologic Properties. *Org. Lett.* **1999**, *1*, 359-362.
- (637) Wang, T.-Y.; Silvius, J. R. Different Sphingolipids Show Differential Partitioning into Sphingolipid/Cholesterol-Rich Domains in Lipid Bilayers. *Biophys. J.* **2000**, *79*, 1478-1489.
- (638) Martin, O. C.; Pagano, R. E. Internalization and Sorting of a Fluorescent Analogue of Glucosylceramide to the Golgi Apparatus of Human Skin Fibroblasts: Utilization of Endocytic and Nonendocytic Transport Mechanisms. *J. Cell Biol.* **1994**, *125*, 769-781.
- (639) Singh, R. D.; Puri, V.; Valiyaveetil, J. T.; Marks, D. L.; Bittman, R.; Pagano, R. E. Selective Caveolin-1-Dependent Endocytosis of Glycosphingolipids. *Mol. Biol. Cell* **2003**, *14*, 3254-3265.

- (640) Keithley, R. B.; Rosenthal, A. S.; Essaka, D. C.; Tanaka, H.; Yoshimura, Y.; Palcic, M. M.; Hindsgaul, O.; Dovichi, N. J. Capillary Electrophoresis with Three-Color Fluorescence Detection for the Analysis of Glycosphingolipid Metabolism. *Analyst* **2013**, *138*, 164-170.
- (641) Ohtake, A.; Daikoku, S.; Suzuki, K.; Ito, Y.; Kanie, O. Analysis of the Cellular Dynamics of Fluorescently Tagged Glycosphingolipids by Using a Nanoliquid Chromatography–Tandem Mass Spectrometry Platform. *Anal. Chem.* **2013**, *85*, 8475-8482.
- (642) Larsson, E. A.; Olsson, U.; Whitmore, C. D.; Martins, R.; Tettamanti, G.; Schnaar, R. L.; Dovichi, N. J.; Palcic, M. M.; Hindsgaul, O. Synthesis of Reference Standards to Enable Single Cell Metabolomic Studies of Tetramethylrhodamine-Labeled Ganglioside GM1. *Carbohydr. Res.* **2007**, *342*, 482-489.
- (643) Whitmore, C. D.; Olsson, U.; Larsson, E. A.; Hindsgaul, O.; Palcic, M. M.; Dovichi, N. J. Yoctomole Analysis of Ganglioside Metabolism in PC12 Cellular Homogenates. *Electrophoresis* **2007**, *28*, 3100-3104.
- (644) Essaka, D. C.; White, J.; Rathod, P.; Whitmore, C. D.; Hindsgaul, O.; Palcic, M. M.; Dovichi, N. J. Monitoring the Uptake of Glycosphingolipids in Plasmodium Falciparum-Infected Erythrocytes Using Both Fluorescence Microscopy and Capillary Electrophoresis with Laser-Induced Fluorescence Detection. *Anal. Chem.* **2010**, *82*, 9955-9958.
- (645) Boldyrev, I.; Molotkovsky, J. New 4, 4-Difluoro-3a, 4a-Diaza-S-Indacene (BODIPY)-Labeled Sphingolipids for Membrane Studies. *Russ. J. Bioorg. Chem.* **2010**, *36*, 508-511.
- (646) Mikhalyov, I.; Molotkovsky, J. G. Synthesis and Characteristics of Fluorescent BODIPY-Labeled Gangliosides. *Russ. J. Bioorg. Chem.* **2003**, *29*, 168-174.
- (647) Yoshimura, Y.; Tanaka, H.; Dovichi, N. J.; Hindsgaul, O.; Palcic, M. M. Application of Fluorescently-Labeled Glycosphingolipids to Metabolic Profiling in Single Cells Using Capillary Electrophoresis. *Trends Glycosci. Glycotechnol.* **2012**, *24*, 169-178.
- (648) Sarver, S. A.; Keithley, R. B.; Essaka, D. C.; Tanaka, H.; Yoshimura, Y.; Palcic, M. M.; Hindsgaul, O.; Dovichi, N. J. Preparation and Electrophoretic Separation of Bodipy-Fl-Labeled Glycosphingolipids. *J. Chromatogr. A* **2012**, *1229*, 268-273.
- (649) Essaka, D. C.; Prendergast, J.; Keithley, R. B.; Hindsgaul, O.; Palcic, M. M.; Schnaar, R. L.; Dovichi, N. J. Single Cell Ganglioside Catabolism in Primary Cerebellar Neurons and Glia. *Neurochem. Res.* **2012**, *37*, 1308-1314.
- (650) Whitmore, C. D.; Hindsgaul, O.; Palcic, M. M.; Schnaar, R. L.; Dovichi, N. J. Metabolic Cytometry. Glycosphingolipid Metabolism in Single Cells. *Anal. Chem.* **2007**, *79*, 5139-5142.
- (651) Keithley, R. B.; Weaver, E. M.; Rosado, A. M.; Metzinger, M. P.; Hummon, A. B.; Dovichi, N. J. Single Cell Metabolic Profiling of Tumor Mimics. *Anal. Chem.* **2013**, *85*, 8910-8918.

- (652) Tanaka, H.; Yoshimura, Y.; Dovichi, N. J.; Palcic, M. M.; Hindsgaul, O. A Concise Chemical Synthesis of a Fluorescent Bgal-(1, 4)-S- β -Glc-Cer Derivative and Its Enzymatic Elongation by Glycosyltransferases. *Tetrahedron Lett.* **2012**, *53*, 1812-1815.
- (653) Singh, R. D.; Liu, Y.; Wheatley, C. L.; Holicky, E. L.; Makino, A.; Marks, D. L.; Kobayashi, T.; Subramaniam, G.; Bittman, R.; Pagano, R. E. Caveolar Endocytosis and Microdomain Association of a Glycosphingolipid Analog Is Dependent on Its Sphingosine Stereochemistry. *J. Biol. Chem.* **2006**, *281*, 30660-30668.
- (654) Liu, Y.; Bittman, R. Synthesis of Fluorescent Lactosylceramide Stereoisomers. *Chem. Phys. Lipids* **2006**, *142*, 58-69.
- (655) Gege, C.; Schumacher, G.; Rothe, U.; Schmidt, R. R.; Bendas, G. Visualization of Sialyl Lewis X Glycosphingolipid Microdomains in Model Membranes as Selectin Recognition Motifs Using a Fluorescence Label. *Carbohydr. Res.* **2008**, *343*, 2361-2368.
- (656) Gege, C.; Oscarson, S.; Schmidt, R. R. Synthesis of Fluorescence Labeled Sialyl Lewis X Glycosphingolipids. *Tetrahedron Lett.* **2001**, *42*, 377-380.
- (657) Lombardi, V.; Stock, P.; Singh, A. K.; Kerzerho, J.; Yang, W.; Sullivan, B. A.; Li, X.; Shiratsuchi, T.; Hnatiuk, N. E.; Howell, A. R. A Cd1d-Dependent Antagonist Inhibits the Activation of Invariant NKT Cells and Prevents Development of Allergen-Induced Airway Hyperreactivity. *J. Immunol.* **2010**, *184*, 2107-2115.
- (658) Kamijuku, H.; Nagata, Y.; Jiang, X.; Ichinohe, T.; Tashiro, T.; Mori, K.; Taniguchi, M.; Hase, K.; Ohno, H.; Shimaoka, T. Mechanism of NKT Cell Activation by Intranasal Coadministration of [Alpha]-Galactosylceramide, Which Can Induce Cross-Protection against Influenza Viruses. *Mucosal Immunol.* **2008**, *1*, 208-218.
- (659) Jervis, P. J.; Polzella, P.; Wojno, J.; Jukes, J.-P.; Ghadbane, H.; Garcia Diaz, Y. R.; Besra, G. S.; Cerundolo, V.; Cox, L. R. Design, Synthesis, and Functional Activity of Labeled Cd1d Glycolipid Agonists. *Bioconjugate Chem.* **2013**, *24*, 586-594.
- (660) Zhou, X.-T.; Forestier, C.; Goff, R. D.; Li, C.; Teyton, L.; Bendelac, A.; Savage, P. B. Synthesis and NKT Cell Stimulating Properties of Fluorophore-and Biotin-Appended 6'-Amino-6'-Deoxy-Galactosylceramides. *Org. Lett.* **2002**, *4*, 1267-1270.
- (661) Franchini, L.; Compostella, F.; Donda, A.; Mori, L.; Colombo, D.; De Libero, G.; Matto, P.; Ronchetti, F.; Panza, L. Synthesis of a Fluorescent Sulfatide for the Study of CD1 Antigen Binding Properties. *Eur. J. Org. Chem.* **2004**, *2004*, 4755-4761.
- (662) Cheng, J. M.; Chee, S. H.; Knight, D. A.; Acha-Orbea, H.; Hermans, I. F.; Timmer, M. S.; Stocker, B. L. An Improved Synthesis of Dansylated α -Galactosylceramide and Its Use as a Fluorescent Probe for the Monitoring of Glycolipid Uptake by Cells. *Carbohydr. Res.* **2011**, *346*, 914-926.
- (663) Komura, N.; Suzuki, K. G.; Ando, H.; Konishi, M.; Koikeda, M.; Imamura, A.; Chadda, R.; Fujiwara, T. K.; Tsuboi, H.; Sheng, R. Raft-Based Interactions of Gangliosides with a GPI-Anchored Receptor. *Nat. Chem. Biol.* **2016**, *12*, 402-410.

- (664) Kameta, N.; Masuda, M.; Shimizu, T. Qualitative/Chiral Sensing of Amino Acids by Naked-Eye Fluorescence Change Based on Morphological Transformation and Hierarchizing in Supramolecular Assemblies of Pyrene-Conjugated Glycolipids. *Chem. Comm.* **2015**, *51*, 11104-11107.
- (665) Fyrner, T.; Magnusson, K.; Nilsson, K. P. R.; Hammarström, P.; Aili, D.; Konradsson, P. Derivatization of a Bioorthogonal Protected Trisaccharide Linker - toward Multimodal Tools for Chemical Biology. *Bioconjugate Chem.* **2012**, *23*, 1333-1340.
- (666) Clegg, R. M. Fluorescence Resonance Energy Transfer. *Curr. Opin. Biotechnol.* **1995**, *6*, 103-110.
- (667) Antes, P.; Schwarzmann, G.; Sandhoff, K. Detection of Protein Mediated Glycosphingolipid Clustering by the Use of Resonance Energy Transfer between Fluorescent Labelled Lipids. A Method Established by Applying the System Ganglioside GM1 and Cholera Toxin B Subunit. *Chem. Phys. Lipids* **1992**, *62*, 269-280.
- (668) Mattjus, P.; Molotkovsky, J. G.; Smaby, J. M.; Brown, R. E. A Fluorescence Resonance Energy Transfer Approach for Monitoring Protein-Mediated Glycolipid Transfer between Vesicle Membranes. *Anal. Biochem.* **1999**, *268*, 297-304.
- (669) Rao, C. S.; Chung, T.; Pike, H. M.; Brown, R. E. Glycolipid Transfer Protein Interaction with Bilayer Vesicles: Modulation by Changing Lipid Composition. *Biophys. J.* **2005**, *89*, 4017-4028.
- (670) Rao, C. S.; Lin, X.; Pike, H. M.; Molotkovsky, J. G.; Brown, R. E. Glycolipid Transfer Protein Mediated Transfer of Glycosphingolipids between Membranes: A Model for Action Based on Kinetic and Thermodynamic Analyses. *Biochemistry* **2004**, *43*, 13805-13815.
- (671) Samygina, V. R.; Ochoa-Lizarralde, B.; Popov, A. N.; Cabo-Bilbao, A.; Goni-de-Cerio, F.; Molotkovsky, J. G.; Patel, D. J.; Brown, R. E.; Malinina, L. Structural Insights into Lipid-Dependent Reversible Dimerization of Human GLTP. *Acta Crystallogr., Sect. D: Biol. Crystallogr.* **2013**, *69*, 603-616.
- (672) Mattjus, P.; Kline, A.; Pike, H. M.; Molotkovsky, J. G.; Brown, R. E. Probing for Preferential Interactions among Sphingolipids in Bilayer Vesicles Using the Glycolipid Transfer Protein. *Biochemistry* **2002**, *41*, 266-273.
- (673) Zhai, X.; Gao, Y.-G.; Mishra, S. K.; Simanshu, D. K.; Boldyrev, I. A.; Benson, L. M.; Bergen, H. R.; Malinina, L.; Mundy, J.; Molotkovsky, J. G. Phosphatidylserine Stimulates Ceramide 1-Phosphate (C1p) Intermembrane Transfer by C1p Transfer Proteins. *J. Biol. Chem.* **2017**, *292*, 2531-2541.
- (674) Nylund, M.; Mattjus, P. Protein Mediated Glycolipid Transfer Is Inhibited from Sphingomyelin Membranes but Enhanced to Sphingomyelin Containing Raft Like Membranes. *Biochim. Biophys. Acta, Biomembr.* **2005**, *1669*, 87-94.
- (675) West, G.; Nylund, M.; Slotte, J. P.; Mattjus, P. Membrane Interaction and Activity of the Glycolipid Transfer Protein. *Biochim. Biophys. Acta, Biomembr.* **2006**, *1758*, 1732-1742.

- (676) Nylund, M.; Kjellberg, M. A.; Molotkovsky, J. G.; Byun, H.-S.; Bittman, R.; Mattjus, P. Molecular Features of Phospholipids That Affect Glycolipid Transfer Protein-Mediated Galactosylceramide Transfer between Vesicles. *Biochim. Biophys. Acta, Biomembr.* **2006**, *1758*, 807-812.
- (677) Nylund, M.; Fortelius, C.; Palonen, E. K.; Molotkovsky, J. G.; Mattjus, P. Membrane Curvature Effects on Glycolipid Transfer Protein Activity. *Langmuir* **2007**, *23*, 11726-11733.
- (678) Brown, R. E.; Mattjus, P. Glycolipid Transfer Proteins. *Biochim. Biophys. Acta, Mol. Cell Biol. Lipids* **2007**, *1771*, 746-760.
- (679) Zhai, X.; Momsen, W. E.; Malakhov, D. A.; Boldyrev, I. A.; Momsen, M. M.; Molotkovsky, J. G.; Brockman, H. L.; Brown, R. E. GLTP-Fold Interaction with Planar Phosphatidylcholine Surfaces Is Synergistically Stimulated by Phosphatidic Acid and Phosphatidylethanolamine. *J. Lipid Res.* **2013**, *54*, 1103-1113.
- (680) Schwarzmann, G.; Wendeler, M.; Sandhoff, K. Synthesis of Novel NBD-GM1 and NBD-GM2 for the Transfer Activity of GM2-Activator Protein by a FRET-Based Assay System. *Glycobiology* **2005**, *15*, 1302-1311.
- (681) Song, X.; Nolan, J.; Swanson, B. I. Optical Biosensor Based on Fluorescence Resonance Energy Transfer: Ultrasensitive and Specific Detection of Protein Toxins. *J. Am. Chem. Soc.* **1998**, *120*, 11514-11515.
- (682) Song, X.; Swanson, B. I. Direct, Ultrasensitive, and Selective Optical Detection of Protein Toxins Using Multivalent Interactions. *Anal. Chem.* **1999**, *71*, 2097-2107.
- (683) Song, X.; Shi, J.; Swanson, B. Flow Cytometry-Based Biosensor for Detection of Multivalent Proteins. *Anal. Biochem.* **2000**, *284*, 35-41.
- (684) Song, X.; Swanson, B. I. Rational Design of an Optical Sensing System for Multivalent Proteins. *Langmuir* **1999**, *15*, 4710-4712.
- (685) Ma, G.; Cheng, Q. Manipulating FRET with Polymeric Vesicles: Development of a “Mix-and-Detect” Type Fluorescence Sensor for Bacterial Toxin. *Langmuir* **2006**, *22*, 6743-6745.
- (686) Bergström, F.; Mikhalyov, I.; Hägglöf, P.; Wortmann, R.; Ny, T.; Johansson, L. B.-Å. Dimers of Dipyrrometheneboron Difluoride (BODIPY) with Light Spectroscopic Applications in Chemistry and Biology. *J. Am. Chem. Soc.* **2002**, *124*, 196-204.
- (687) Marushchak, D.; Gretskeya, N.; Mikhalyov, I.; Johansson, L. B.-Å. Self-Aggregation—an Intrinsic Property of GM1 in Lipid Bilayers. *Mol. Membr. Biol.* **2007**, *24*, 102-112.
- (688) Šachl, R.; Amaro, M.; Aydogan, G.; Koukalová, A.; Mikhalyov, I. I.; Boldyrev, I. A.; Humpolíčková, J.; Hof, M. On Multivalent Receptor Activity of GM1 in Cholesterol Containing Membranes. *Biochim. Biophys. Acta, Mol. Cell Res.* **2015**, *1853*, 850-857.

- (689) Washiya, K.; Furuike, T.; Nakajima, F.; Lee, Y. C.; Nishimura, S.-I. Design of Fluorogenic Substrates for Continuous Assay of Sialyltransferase by Resonance Energy Transfer. *Anal. Biochem.* **2000**, *283*, 39-48.
- (690) Maeda, T.; Nishimura, S. I. FRET-Based Direct and Continuous Monitoring of Human Fucosyltransferases Activity: An Efficient Synthesis of Versatile GDP-L-Fucose Derivatives from Abundant D-Galactose. *Chem. - Eur. J.* **2008**, *14*, 478-487.
- (691) Wichmann, O.; Schultz, C. FRET Probes to Monitor Phospholipase A2 Activity. *Chem. Comm.* **2001**, *2001*, 2500-2501.
- (692) Wichmann, O.; Gelb, M. H.; Schultz, C. Probing Phospholipase A2 with Fluorescent Phospholipid Substrates. *ChemBioChem* **2007**, *8*, 1555-1569.
- (693) Wichmann, O.; Wittbrodt, J.; Schultz, C. A Small-Molecule FRET Probe to Monitor Phospholipase A2 Activity in Cells and Organisms. *Angew. Chem., Int. Ed.* **2006**, *45*, 508-512.
- (694) Nieuwenhuizen, W. F.; van Leeuwen, S.; Götz, F.; Egmond, M. R. Synthesis of a Novel Fluorescent Ceramide Analogue and Its Use in the Characterization of Recombinant Ceramidase from *Pseudomonas Aeruginosa* PA01. *Chem. Phys. Lipids* **2002**, *114*, 181-191.
- (695) Yadav, A. K.; Shen, D. L.; Shan, X.; He, X.; Kermode, A. R.; Voadlo, D. J. Fluorescence-Quenched Substrates for Live Cell Imaging of Human Glucocerebrosidase Activity. *J. Am. Chem. Soc.* **2015**, *137*, 1181-1189.
- (696) Ashmus, R. A.; Shen, D. L.; Voadlo, D. J. Fluorescence-Quenched Substrates for Quantitative Live Cell Imaging of Glucocerebrosidase Activity. *Methods Enzymol.* **2017**, *598*, 119-215.
- (697) Cecioni, S.; Voadlo, D. J. Carbohydrate Bis-Acetal-Based Substrates as Tunable Fluorescence-Quenched Probes for Monitoring Exo-Glycosidase Activity. *J. Am. Chem. Soc.* **2017**, *139*, 8392-8395.
- (698) Tiwari, V. K.; Mishra, B. B.; Mishra, K. B.; Mishra, N.; Singh, A. S.; Chen, X. Cu-Catalyzed Click Reaction in Carbohydrate Chemistry. *Chem. Rev.* **2016**, *116*, 3086-3240.
- (699) Liu, S.; Edgar, K. J. Staudinger Reactions for Selective Functionalization of Polysaccharides: A Review. *Biomacromolecules* **2015**, *16*, 2556-2571.
- (700) van Berkel, S. S.; van Eldijk, M. B.; van Hest, J. Staudinger Ligation as a Method for Bioconjugation. *Angew. Chem., Int. Ed.* **2011**, *50*, 8806-8827.
- (701) Sletten, E. M.; Bertozzi, C. R. Bioorthogonal Chemistry: Fishing for Selectivity in a Sea of Functionality. *Angew. Chem., Int. Ed.* **2009**, *48*, 6974-6998.
- (702) Lim, R. K.; Lin, Q. Bioorthogonal Chemistry: Recent Progress and Future Directions. *Chem. Comm.* **2010**, *46*, 1589-1600.

- (703) Patterson, D. M.; Nazarova, L. A.; Prescher, J. A. Finding the Right (Bioorthogonal) Chemistry. *ACS Chem. Biol.* **2014**, *9*, 592-605.
- (704) Ramil, C. P.; Lin, Q. Bioorthogonal Chemistry: Strategies and Recent Developments. *Chem. Comm.* **2013**, *49*, 11007-11022.
- (705) Best, M. D. Click Chemistry and Bioorthogonal Reactions: Unprecedented Selectivity in the Labeling of Biological Molecules. *Biochemistry* **2009**, *48*, 6571-6584.
- (706) Bussink, A. P.; van Swieten, P. F.; Ghauharali, K.; Scheij, S.; van Eijk, M.; Wennekes, T.; van der Marel, G. A.; Boot, R. G.; Aerts, J.; Overkleeft, H. S. N-Azidoacetylmannosamine-Mediated Chemical Tagging of Gangliosides. *J. Lipid Res.* **2007**, *48*, 1417-1421.
- (707) Wratil, P. R.; Horstkorte, R.; Reutter, W. Metabolic Glycoengineering with N-Acyl Side Chain Modified Mannosamines. *Angew. Chem., Int. Ed.* **2016**, *55*, 9482-9512.
- (708) Feng, L.; Hong, S.; Rong, J.; You, Q.; Dai, P.; Huang, R.; Tan, Y.; Hong, W.; Xie, C.; Zhao, J. Bifunctional Unnatural Sialic Acids for Dual Metabolic Labeling of Cell-Surface Sialylated Glycans. *J. Am. Chem. Soc.* **2013**, *135*, 9244-9247.
- (709) Luchansky, S. J.; Goon, S.; Bertozzi, C. R. Expanding the Diversity of Unnatural Cell-Surface Sialic Acids. *ChemBioChem* **2004**, *5*, 371-374.
- (710) Jacobs, C. L.; Goon, S.; Yarema, K. J.; Hinderlich, S.; Hang, H. C.; Chai, D. H.; Bertozzi, C. R. Substrate Specificity of the Sialic Acid Biosynthetic Pathway. *Biochemistry* **2001**, *40*, 12864-12874.
- (711) Xie, R.; Hong, S.; Feng, L.; Rong, J.; Chen, X. Cell-Selective Metabolic Glycan Labeling Based on Ligand-Targeted Liposomes. *J. Am. Chem. Soc.* **2012**, *134*, 9914-9917.
- (712) Lopez Aguilar, A.; Briard, J. G.; Yang, L.; Ovrzyn, B.; Macauley, M. S.; Wu, P. Tools for Studying Glycans: Recent Advances in Chemoenzymatic Glycan Labeling. *ACS Chem. Biol.* **2017**, *12*, 611-621.
- (713) Rouhanifard, S. H.; López-Aguilar, A.; Wu, P. CHoMP: A Chemoenzymatic Histology Method Using Clickable Probes. *ChemBioChem* **2014**, *15*, 2667-2673.
- (714) Wu, Z. L.; Person, A. D.; Anderson, M.; Burroughs, B.; Tatge, T.; Khatri, K.; Zou, Y.; Wang, L.; Geders, T.; Zaia, J. Imaging Specific Cellular Glycan Structures Using Glycosyltransferases Via Click Chemistry. *Glycobiology* **2017**, *28*, 69-79.
- (715) Baskin, J. M.; Prescher, J. A.; Laughlin, S. T.; Agard, N. J.; Chang, P. V.; Miller, I. A.; Lo, A.; Codelli, J. A.; Bertozzi, C. R. Copper-Free Click Chemistry for Dynamic in Vivo Imaging. *Proc. Natl. Acad. Sci. U. S. A.* **2007**, *104*, 16793-16797.
- (716) Chang, P. V.; Chen, X.; Smyrniotis, C.; Xenakis, A.; Hu, T.; Bertozzi, C. R.; Wu, P. Metabolic Labeling of Sialic Acids in Living Animals with Alkynyl Sugars. *Angew. Chem., Int. Ed.* **2009**, *48*, 4030-4033.

- (717) Hsu, T.-L.; Hanson, S. R.; Kishikawa, K.; Wang, S.-K.; Sawa, M.; Wong, C.-H. Alkynyl Sugar Analogs for the Labeling and Visualization of Glycoconjugates in Cells. *Proc. Natl. Acad. Sci. U. S. A.* **2007**, *104*, 2614-2619.
- (718) Vanbeselaere, J.; Vicogne, D.; Matthijs, G.; Biot, C.; Foulquier, F.; Guerardel, Y. Alkynyl Monosaccharide Analogues as a Tool for Evaluating Golgi Glycosylation Efficiency: Application to Congenital Disorders of Glycosylation (CDG). *Chem. Comm.* **2013**, *49*, 11293-11295.
- (719) Kennedy, D. C.; McKay, C. S.; Legault, M. C.; Danielson, D. C.; Blake, J. A.; Pegoraro, A. F.; Stolow, A.; Mester, Z.; Pezacki, J. P. Cellular Consequences of Copper Complexes Used to Catalyze Bioorthogonal Click Reactions. *J. Am. Chem. Soc.* **2011**, *133*, 17993-18001.
- (720) Hong, V.; Steinmetz, N. F.; Manchester, M.; Finn, M. Labeling Live Cells by Copper-Catalyzed Alkyne–Azide Click Chemistry. *Bioconjugate Chem.* **2010**, *21*, 1912-1916.
- (721) Prescher, J. A.; Dube, D. H.; Bertozzi, C. R. Chemical Remodelling of Cell Surfaces in Living Animals. *Nature* **2004**, *430*, 873-877.
- (722) Saxon, E.; Bertozzi, C. R. Cell Surface Engineering by a Modified Staudinger Reaction. *Science* **2000**, *287*, 2007-2010.
- (723) Agard, N. J.; Prescher, J. A.; Bertozzi, C. R. A Strain-Promoted [3+ 2] Azide–Alkyne Cycloaddition for Covalent Modification of Biomolecules in Living Systems. *J. Am. Chem. Soc.* **2004**, *126*, 15046-15047.
- (724) Mbua, N. E.; Guo, J.; Wolfert, M. A.; Steet, R.; Boons, G. J. Strain-Promoted Alkyne–Azide Cycloadditions (SPAAC) Reveal New Features of Glycoconjugate Biosynthesis. *ChemBioChem* **2011**, *12*, 1912-1921.
- (725) Sundhoro, M.; Jeon, S.; Park, J.; Ramström, O.; Yan, M. Perfluoroaryl Azide-Staudinger Reaction: A Fast and Bioorthogonal Reaction. *Angew. Chem., Int. Ed.* **2017**, *56*, 12117-12121.
- (726) Kohler, J. J. Aniline: A Catalyst for Sialic Acid Detection. *ChemBioChem* **2009**, *10*, 2147-2150.
- (727) Ramya, T.; Weerapana, E.; Cravatt, B. F.; Paulson, J. C. Glycoproteomics Enabled by Tagging Sialic Acid-or Galactose-Terminated Glycans. *Glycobiology* **2012**, *23*, 211-221.
- (728) McCombs, J. E.; Kohler, J. J. Pneumococcal Neuraminidase Substrates Identified through Comparative Proteomics Enabled by Chemospecific Labeling. *Bioconjugate Chem.* **2016**, *27*, 1013-1022.
- (729) Dauner, M.; Batroff, E.; Bachmann, V.; Hauck, C. R.; Wittmann, V. Synthetic Glycosphingolipids for Live-Cell Labeling. *Bioconjugate Chem.* **2016**, *27*, 1624-1637.

- (730) Walter, T.; Schlegel, J.; Burgert, A.; Kurz, A.; Seibel, J.; Sauer, M. Incorporation Studies of Clickable Ceramides in Jurkat Cell Plasma Membranes. *Chem. Comm.* **2017**, *53*, 6836-6839
- (731) Zerkowski, J. A.; Nunez, A.; Strahan, G. D.; Solaiman, D. K. Clickable Lipids: Azido and Alkynyl Fatty Acids and Triacylglycerols. *J. Am. Oil Chem. Soc.* **2009**, *86*, 1115-1121.
- (732) Biswas, A.; Sharma, B. K.; Willett, J.; Advaryu, A.; Erhan, S.; Cheng, H. Azide Derivatives of Soybean Oil and Fatty Esters. *J. Agric. Food Chem.* **2008**, *56*, 5611-5616.
- (733) Garrido, M.; Abad, J. L.; Fabriàs, G.; Casas, J.; Delgado, A. Azide-Tagged Sphingolipids: New Tools for Metabolic Flux Analysis. *ChemBioChem* **2015**, *16*, 641-650.
- (734) Thiele, C.; Papan, C.; Hoelper, D.; Kusserow, K.; Gaebler, A.; Schoene, M.; Piotrowitz, K.; Lohmann, D.; Spandl, J.; Stevanovic, A. Tracing Fatty Acid Metabolism by Click Chemistry. *ACS Chem. Biol.* **2012**, *7*, 2004-2011.
- (735) Pedrosa, L. R. C.; van Cappellen, W. A.; Steurer, B.; Ciceri, D.; ten Hagen, T. L.; Eggermont, A. M.; Verheij, M.; Goñi, F. M.; Koning, G. A.; Contreras, F.-X. C 8-Glycosphingolipids Preferentially Insert into Tumor Cell Membranes and Promote Chemotherapeutic Drug Uptake. *Biochim. Biophys. Acta, Biomembr.* **2015**, *1848*, 1656-1670.
- (736) Augustin, K. E.; Schäfer, H. J. Conversion of Oleic Acid to 17- and 18-Substituted Stearic Acid Derivatives by Way of the „Acetylene Zipper” . *Eur. J. Org. Chem.* **1991**, *1991*, 1037-1040.
- (737) Charron, G.; Zhang, M. M.; Yount, J. S.; Wilson, J.; Raghavan, A. S.; Shamir, E.; Hang, H. C. Robust Fluorescent Detection of Protein Fatty-Acylation with Chemical Reporters. *J. Am. Chem. Soc.* **2009**, *131*, 4967-4975.
- (738) Yap, M. C.; Kostiuk, M. A.; Martin, D. D.; Perinpanayagam, M. A.; Hak, P. G.; Siddam, A.; Majjigapu, J. R.; Rajaiiah, G.; Keller, B. O.; Prescher, J. A. Rapid and Selective Detection of Fatty Acylated Proteins Using Ω -Alkynyl-Fatty Acids and Click Chemistry. *J. Lipid Res.* **2010**, *51*, 1566-1580.
- (739) Prinetti, A.; Aureli, M.; Illuzzi, G.; Prioni, S.; Nocco, V.; Scandroglio, F.; Gagliano, N.; Tredici, G.; Rodriguez-Menendez, V.; Chigorno, V. GM3 Synthase Overexpression Results in Reduced Cell Motility and in Caveolin-1 Upregulation in Human Ovarian Carcinoma Cells. *Glycobiology* **2009**, *20*, 62-77.
- (740) Chiricozzi, E.; Ciampa, M. G.; Brasile, G.; Compostella, F.; Prinetti, A.; Nakayama, H.; Ekyalongo, R. C.; Iwabuchi, K.; Sonnino, S.; Mauri, L. Direct Interaction, Instrumental for Signaling Processes, between LacCer and Lyn in the Lipid Rafts of Neutrophil-Like Cells. *J. Lipid Res.* **2015**, *56*, 129-141.
- (741) Tanaka, Y.; Kohler, J. J. Photoactivatable Crosslinking Sugars for Capturing Glycoprotein Interactions. *J. Am. Chem. Soc.* **2008**, *130*, 3278-3279.

- (742) Han, S.; Collins, B. E.; Bengtson, P.; Paulson, J. C. Homomultimeric Complexes of CD22 in B Cells Revealed by Protein-Glycan Cross-Linking. *Nat. Chem. Biol.* **2005**, *1*, 93-97.
- (743) Bond, M. R.; Whitman, C. M.; Kohler, J. J. Metabolically Incorporated Photocrosslinking Sialic Acid Covalently Captures a Ganglioside-Protein Complex. *Mol. BioSyst.* **2010**, *6*, 1796-1799.
- (744) Whitman, C. M.; Yang, F.; Kohler, J. J. Modified GM3 Gangliosides Produced by Metabolic Oligosaccharide Engineering. *Bioorg. Med. Chem. Lett.* **2011**, *21*, 5006-5010.
- (745) Sonnino, S.; Chigorno, V.; Acquotti, D.; Pitto, M.; Kirschner, G.; Tettamanti, G. A Photoreactive Derivative of Radiolabeled GM1 Ganglioside: Preparation and Use to Establish the Involvement of Specific Proteins in GM1 Uptake by Human Fibroblasts in Culture. *Biochemistry* **1989**, *28*, 77-84.
- (746) Mauri, L.; Prioni, S.; Loberto, N.; Chigorno, V.; Prinetti, A.; Sonnino, S. Synthesis of Radioactive and Photoactivable Ganglioside Derivatives for the Study of Ganglioside-Protein Interactions. *Glycoconjugate J.* **2003**, *20*, 11-23.
- (747) Vodovozova, E. Photoaffinity Labeling and Its Application in Structural Biology. *Biochemistry (Moscow)* **2007**, *72*, 1-20.
- (748) Zegers, M. P. M.; Kok, J. W.; Hoekstra, D. Use of Photoactivatable Sphingolipid Analogues to Monitor Lipid Transport in Mammalian Cells. *Biochem. J.* **1997**, *328*, 489-498.
- (749) Pacuszka, T.; Panasiewicz, M. Photochemical Labeling of Human Erythrocyte Membranes with Radioiodinatable Azidosalicylic Acid Derivative of Globoside. *Biochim. Biophys. Acta, Lipids Lipid Metab.* **1995**, *1257*, 265-273.
- (750) Berkhout, T.; Groot, P.; van Belzen, R.; Wirtz, K. Coupling of Photoactivatable Glycolipid Probes to Apolipoproteins Ai and A-II in Human High Density Lipoproteins 2 and 3. *J. Lipid Res.* **1985**, *26*, 964-969.
- (751) Berkhout, T. A.; Amerongen, A.; Wirtz, K. W. A. Labeling of Phospholipids in Vesicles and Human Erythrocytes by Photoactivable Fatty Acid Derivatives. *FEBS J.* **1984**, *142*, 91-97.
- (752) Iwata, K.; Manweiler, C.; Bramhall, J.; Wisnieski, B. Photoreactive Probes for High Resolution Mapping of Membrane Proteins. *Prog. Clin. Biol. Res.* **1978**, *22*, 579-589.
- (753) Haberkant, P.; Schmitt, O.; Contreras, F.-X.; Thiele, C.; Hanada, K.; Sprong, H.; Reinhard, C.; Wieland, F. T.; Brügger, B. Protein-Sphingolipid Interactions within Cellular Membranes. *J. Lipid Res.* **2008**, *49*, 251-262.
- (754) Haberkant, P.; Stein, F.; Höglinger, D.; Gerl, M. J.; Brügger, B.; Van Veldhoven, P. P.; Krijgsveld, J.; Gavin, A.-C.; Schultz, C. Bifunctional Sphingosine for Cell-Based Analysis of Protein-Sphingolipid Interactions. *ACS Chem. Biol.* **2015**, *11*, 222-230.

- (755) Liu, X.; Dong, T.; Zhou, Y.; Huang, N.; Lei, X. Exploring the Binding Proteins of Glycolipids with Bifunctional Chemical Probes. *Angew. Chem., Int. Ed.* **2016**, *55*, 14330-14334.
- (756) Budani, M.; Mylvaganam, M.; Binnington, B.; Lingwood, C. Synthesis of a Novel Photoactivatable Glucosylceramide Cross-Linker. *J. Lipid Res.* **2016**, *57*, 1728-1736.
- (757) Lankalapalli, R. S.; Baksa, A.; Liliom, K.; Bittman, R. Synthesis and Properties of a Photoactivatable Analogue of Psychosine (β -Galactosylsphingosine). *ChemMedChem* **2010**, *5*, 682-686.
- (758) Sakurai, K.; Ozawa, S.; Yamada, R.; Yasui, T.; Mizuno, S. Comparison of the Reactivity of Carbohydrate Photoaffinity Probes with Different Photoreactive Groups. *ChemBioChem* **2014**, *15*, 1399-1403.
- (759) Sakurai, K.; Yamaguchi, T.; Mizuno, S. Design and Synthesis of Fluorescent Glycolipid Photoaffinity Probes and Their Photoreactivity. *Bioorg. Med. Chem. Lett.* **2016**, *26*, 5110-5115.
- (760) Sakurai, K.; Yasui, T.; Mizuno, S. Comparative Analysis of the Reactivity of Diazirine-Based Photoaffinity Probes toward a Carbohydrate-Binding Protein. *Asian J. Org. Chem.* **2015**, *4*, 724-728.
- (761) Höglinger, D.; Nadler, A.; Schultz, C. Caged Lipids as Tools for Investigating Cellular Signaling. *Biochim. Biophys. Acta, Mol. Cell Biol. Lipids* **2014**, *1841*, 1085-1096.
- (762) Zehavi, U.; Herchman, M.; Hakomori, S.-I.; Köpper, S. Enzymic Glycosphingolipid Synthesis on Polymer Supports. *Glycoconjugate J.* **1990**, *7*, 219-228.
- (763) Zehavi, U. Synthesis of Potentially Caged Sphingolipids, Possible Precursors of Cellular Modulators and Second Messengers. *Chem. Phys. Lipids* **1997**, *90*, 55-61.
- (764) Tuchinsky, A.; Zehavi, U. Chemoenzymic Synthesis of Potentially Caged Glycosphingolipids (GSLs): Potentially Caged Lyso-GM3 and Its Analogue. *Chem. Phys. Lipids* **1998**, *92*, 91-97.
- (765) Shigenaga, A.; Hirakawa, H.; Yamamoto, J.; Ogura, K.; Denda, M.; Yamaguchi, K.; Tsuji, D.; Itoh, K.; Otaka, A. Design and Synthesis of Caged Ceramide: UV-Responsive Ceramide Releasing System Based on UV-Induced Amide Bond Cleavage Followed by O-N Acyl Transfer. *Tetrahedron* **2011**, *67*, 3984-3990.
- (766) Watanabe, S.; Sueyoshi, T.; Ichihara, M.; Uehara, C.; Iwamura, M. Reductive Ring Opening of O-Nitrobenzylidene Acetals of Monosaccharides: Synthesis and Photolysis of Some Photolabile Sugars. *Org. Lett.* **2001**, *3*, 255-257.
- (767) Höglinger, D.; Nadler, A.; Haberkant, P.; Kirkpatrick, J.; Schifferer, M.; Stein, F.; Hauke, S.; Porter, F. D.; Schultz, C. Trifunctional Lipid Probes for Comprehensive Studies of Single Lipid Species in Living Cells. *Proc. Natl. Acad. Sci. U. S. A.* **2017**, *114*, 1566-1571.

- (768) Beharry, A. A.; Woolley, G. A. Azobenzene Photoswitches for Biomolecules. *Chem. Soc. Rev.* **2011**, *40*, 4422-4437.
- (769) Russew, M. M.; Hecht, S. Photoswitches: From Molecules to Materials. *Adv. Mater.* **2010**, *22*, 3348-3360.
- (770) Sano, M.; Amaike, M.; Kamino, A.; Shinkai, S. Sugar-Dependent Spectral Responses of Azobenzene Glycopyranoside Monolayers. *Langmuir* **2001**, *17*, 4367-4371.
- (771) Laurent, N.; Lafont, D.; Dumoulin, F.; Boullanger, P.; Mackenzie, G.; Kouwer, P. H.; Goodby, J. W. Synthesis of Amphiphilic Phenylazophenyl Glycosides and a Study of Their Liquid Crystal Properties. *J. Am. Chem. Soc.* **2003**, *125*, 15499-15506.
- (772) Frank, J. A.; Franquelim, H. G.; Schwille, P.; Trauner, D. Optical Control of Lipid Rafts with Photoswitchable Ceramides. *J. Am. Chem. Soc.* **2016**, *138*, 12981-12986.
- (773) Clemente, M. J.; Tejedor, R. M.; Romero, P.; Fitremann, J.; Oriol, L. Maltose-Based Gelators Having Azobenzene as Light-Sensitive Unit. *RSC Advances* **2012**, *2*, 11419-11431.
- (774) Wang, T.-N.; Yang, G.; Wu, L.-B.; Chen, G.-S. Self-Assembly of Supra-Amphiphile of Azobenzene-Galactopyranoside Based on Dynamic Covalent Bond and Its Dual Responses. *Chin. Chem. Lett.* **2016**, *27*, 1740-1744.
- (775) Liu, Y.; Palma, A. S.; Feizi, T. Carbohydrate Microarrays: Key Developments in Glycobiology. *Biol. Chem.* **2009**, *390*, 647-656.
- (776) Liu, Y.; Feizi, T. Microarrays—a Key Technology for Glycobiology. In *Glycoscience*; Springer, 2008.
- (777) Stevens, J.; Blixt, O.; Paulson, J. C.; Wilson, I. A. Glycan Microarray Technologies: Tools to Survey Host Specificity of Influenza Viruses. *Nat. Rev. Microbiol.* **2006**, *4*, 857-864.
- (778) Smith, D. F.; Song, X.; Cummings, R. D. Use of Glycan Microarrays to Explore Specificity of Glycan-Binding Proteins. *Methods Enzymol.* **2010**, *480*, 417-444.
- (779) Collins, B. E.; Yang, L.; Schnaar, R. L. Lectin-Mediated Cell Adhesion to Immobilized Glycosphingolipids. *Methods Enzymol.* **1999**, *312*, 438-446.
- (780) Bryan, M. C.; Plettenburg, O.; Sears, P.; Rabuka, D.; Wacowich-Sgarbi, S.; Wong, C.-H. Saccharide Display on Microtiter Plates. *Chem. Biol.* **2002**, *9*, 713-720.
- (781) Lopez, P. H.; Schnaar, R. L. Determination of Glycolipid-Protein Interaction Specificity. *Methods Enzymol.* **2006**, *417*, 205-220.
- (782) Yu, H.; Gonzalez-Gil, A.; Wei, Y.; Fernandes, S. M.; Porell, R. N.; Vajn, K.; Paulson, J. C.; Nycholat, C. M.; Schnaar, R. L. Siglec-8 and Siglec-9 Binding Specificities and Endogenous Airway Ligand Distributions and Properties. *Glycobiology* **2017**, *27*, 657-668.

- (783) Fukui, S.; Feizi, T.; Galustian, C.; Lawson, A. M.; Chai, W. Oligosaccharide Microarrays for High-Throughput Detection and Specificity Assignments of Carbohydrate-Protein Interactions. *Nat. Biotechnol.* **2002**, *20*, 1011.
- (784) Feizi, T.; Chai, W. Oligosaccharide Microarrays to Decipher the Glyco Code. *Nat. Rev. Mol. Cell Biol.* **2004**, *5*, 582-588.
- (785) Liu, Y.; Childs, R. A.; Palma, A. S.; Campanero-Rhodes, M. A.; Stoll, M. S.; Chai, W.; Feizi, T. Neoglycolipid-Based Oligosaccharide Microarray System: Preparation of Ngls and Their Noncovalent Immobilization on Nitrocellulose-Coated Glass Slides for Microarray Analyses. In *Carbohydrate Microarrays: Methods and Protocols*, 2012.
- (786) Wang, D.; Liu, S.; Trummer, B. J.; Deng, C.; Wang, A. Carbohydrate Microarrays for the Recognition of Cross-Reactive Molecular Markers of Microbes and Host Cells. *Nat. Biotechnol.* **2002**, *20*, 275-281.
- (787) Kiessling, L. L.; Cairo, C. W. Hitting the Sweet Spot. *Nat. Biotechnol.* **2002**, *20*, 234-235.
- (788) Kanter, J. L.; Narayana, S.; Ho, P. P.; Catz, I.; Warren, K. G.; Sobel, R. A.; Steinman, L.; Robinson, W. H. Lipid Microarrays Identify Key Mediators of Autoimmune Brain Inflammation. *Nat. Med.* **2006**, *12*, 138-143.
- (789) Fang, Y.; Frutos, A. G.; Lahiri, J. Membrane Protein Microarrays. *J. Am. Chem. Soc.* **2002**, *124*, 2394-2395.
- (790) Fang, Y.; Frutos, A. G.; Lahiri, J. Ganglioside Microarrays for Toxin Detection. *Langmuir* **2003**, *19*, 1500-1505.
- (791) Zhang, J.; Zhou, X. Novel 3-Dimensional Dendrimer Platform for Glycolipid Microarray. *Biosens. Bioelectron.* **2011**, *28*, 355-361.
- (792) Rinaldi, S.; Brennan, K. M.; Willison, H. J. Combinatorial Glycoarray. In *Carbohydrate Microarrays: Methods and Protocols*, 2012.
- (793) Rinaldi, S.; Brennan, K.; Willison, H. Heteromeric Glycolipid Complexes as Modulators of Autoantibody and Lectin Binding. *Prog. Lipid Res.* **2010**, *49*, 87-95.
- (794) Brennan, K. M.; Galban-Horcajo, F.; Rinaldi, S.; O'Leary, C. P.; Goodyear, C. S.; Kalna, G.; Arthur, A.; Elliot, C.; Barnett, S.; Linington, C. Lipid Arrays Identify Myelin-Derived Lipids and Lipid Complexes as Prominent Targets for Oligoclonal Band Antibodies in Multiple Sclerosis. *J. Neuroimmunol.* **2011**, *238*, 87-95.
- (795) Galban-Horcajo, F.; Fitzpatrick, A.; Hutton, A.; Dunn, S.; Kalna, G.; Brennan, K.; Rinaldi, S.; Yu, R.; Goodyear, C.; Willison, H. Antibodies to Heteromeric Glycolipid Complexes in Multifocal Motor Neuropathy. *Eur. J. Neurol.* **2013**, *20*, 62-70.
- (796) Halstead, S. K.; Kalna, G.; Islam, M. B.; Jahan, I.; Mohammad, Q. D.; Jacobs, B. C.; Endtz, H. P.; Islam, Z.; Willison, H. J. Microarray Screening of Guillain-Barré Syndrome Sera for Antibodies to Glycolipid Complexes. *Neuroimmunol. Neuroinflammation* **2016**, *3*, e284.

- (797) Rinaldi, S.; Brennan, K. M.; Kalna, G.; Walgaard, C.; Van Doorn, P.; Jacobs, B. C.; Robert, K. Y.; Mansson, J.-E.; Goodyear, C. S.; Willison, H. J. Antibodies to Heteromeric Glycolipid Complexes in Guillain-Barré Syndrome. *PLoS One* **2013**, *8*, e82337.
- (798) Kim, C. S.; Seo, J. H.; Cha, H. J. Functional Interaction Analysis of GM1-Related Carbohydrates and Vibrio Cholerae Toxins Using Carbohydrate Microarray. *Anal. Chem.* **2012**, *84*, 6884-6890.
- (799) Park, S.; Shin, I. Fabrication of Carbohydrate Chips for Studying Protein–Carbohydrate Interactions. *Angew. Chem., Int. Ed.* **2002**, *41*, 3180-3182.
- (800) Seo, J. H.; Kim, C. S.; Hwang, B. H.; Cha, H. J. A Functional Carbohydrate Chip Platform for Analysis of Carbohydrate–Protein Interaction. *Nanotechnology* **2010**, *21*, doi:10.1088/0957-4484/1021/1021/215101.
- (801) Ma, Y.; Zhang, H.; Gruzdy, V.; Sun, X.-L. Azide-Reactive Liposome for Chemoselective and Biocompatible Liposomal Surface Functionalization and Glyco-Liposomal Microarray Fabrication. *Langmuir* **2011**, *27*, 13097-13103.
- (802) Ma, Y.; Sobkiv, I.; Gruzdy, V.; Zhang, H.; Sun, X.-L. Liposomal Glyco-Microarray for Studying Glycolipid–Protein Interactions. *Anal. Bioanal. Chem.* **2012**, *404*, 51-58.
- (803) Han, L.; Kitova, E. N.; Klassen, J. S. Detecting Protein–Glycolipid Interactions Using Glycomicelles and CaR-ESI-MS. *J. Am. Soc. Mass Spectrom.* **2016**, *27*, 1878-1886.