

Automatic Levelling of a Prosthetic Wrist

by

Dylan J. A. Brenneis

A thesis submitted in partial fulfillment of the requirements for the degree of

Master of Science

Department of Mechanical Engineering

University of Alberta

© Dylan J. A. Brenneis, 2019

Abstract

Upper limb amputation is a debilitating condition that affects over 41,000 people in the United States alone. Largely because of limitations in wrist prostheses, many people affected by upper limb amputation are compelled to use compensatory movements to perform tasks of daily living, which often result in overuse injuries in the back and shoulder. Some research has shown that adaptable wrists that either passively or actively adapt their angle without direct user input can reduce compensatory movements. The work presented in this thesis represents the first attempt to design and evaluate an active self-adjusting prosthetic wrist that relies only on its internal state to perform automatic levelling. The work follows the arc of the design process, first determining an appropriate user interface, then outlining the design of the prosthesis itself, and finally the evaluation of the effect of the device on the users. The first study provides evidence that an appropriate interface with a self-levelling wrist will keep the terminal device level any time the user is not directly controlling the wrist position. With this information, the design of the prosthesis and explanation of the automatically levelling system is outlined in detail. The system makes use of a single inertial measurement unit mounted in the base of the terminal device to perform all automatic levelling calculations. The second study, focusing on the effect of the device on users, suggests that the automatically levelling wrist may provide reduced compensation in shoulder flexion on a vertically-oriented task, but does not provide any compensatory benefit compared to conventional sequential-switching on a horizontally-oriented task. Further, users indicated that the automatically levelling system was less intuitive and less reliable to use compared to other control mechanisms. This thesis represents three main contributions to the field of wrist prosthesis research: an initial investigation of an appropriate control interface for automatic levelling, the development of a hardware prototype for testing with able-bodied people, and evaluation of effect of the system on users' movement strategies and performance. By these contributions we show that an automatically levelling wrist may provide benefits by reducing compensatory movements in vertically-oriented tasks, but that the current implementation of automatic levelling suffers from

limitations in terms of reliability and intuitiveness. Future research efforts should focus on increasing reliability, and on the evaluation of compensatory movements with prosthesis-users.

Preface

Chapters 1, 2, and 3 contain information from “Initial Investigation of a Self-Adjusting Wrist Control System to Maintain Prosthesis Terminal Device Orientation Relative to the Ground Reference Frame”, originally published in the 7th IEEE RAS/EMBS International Conference on Biomedical Robotics and Biomechatronics (BioRob), August 26-29, 2018. It has been revised and expanded for inclusion in this thesis. The original manuscript was prepared by myself, Dylan J. A. Brenneis, with copy-editing and study design guidance provided by the co-authors: Michael R. Dawson, Glyn Murgatroyd, Jason P. Carey, and Patrick M. Pilarski.

Chapters 2 and 5 contain information from “The Effect of a Self-Adjusting Wrist Control System”, submitted to the 16th IEEE RAS/EMBS International Conference on Rehabilitation Robotics (ICORR), June 24-28, 2019. The original manuscript was prepared by myself, Dylan J. A. Brenneis, with copy-editing and study design guidance provided by the co-authors: Michael R. Dawson, Hiroki Tanikawa, Jacqueline S. Hebert, Jason P. Carey, and Patrick M. Pilarski.

Approval for the studies within the thesis was obtained from the Research Ethics Board of the University of Alberta, Pro00077893. All participants gave informed written consent before participating.

To my parents.

Acknowledgements

I would like first to thank Patrick M. Pilarski and Jason P. Carey for their supervision and guidance throughout this thesis, and for both inspiring and metering many of my sometimes unconventional ideas. Additional thanks to Michael R. Dawson, who provided much informal guidance and supervision, as well as friendship. Thanks to Glyn Murgatroyd for initial conversations which sparked the idea of an automatically levelling wrist, and for his valuable clinical perspective in the preparation of Chapter 3. Clinical perspective proved important again for the preparation of Chapter 5, and here I thank Jacqueline S. Hebert for her guidance and general support. I would also like to thank Mayank Rehani and Ashley N. Dalrymple for their help with the statistical analyses of Chapter 3, and Hiroki Tanikawa, Quinn A. Boser, and Riley Dawson for their help with the kinematic analyses of Chapter 5. Finally, I would like to extend a warm thank-you to all the members of the BLINC Lab, who have made my time there both fun and fulfilling.

Contents

Abstract	ii
Preface	iv
Acknowledgements	vi
1 Introduction	1
1.1 Problem	1
1.2 Objectives	2
1.3 Study Strategy	3
1.4 Summary of Chapter Contents	3
2 Background	5
2.1 Prosthetic Replacement of Upper Limbs	5
2.1.1 Body-Powered Prostheses	5
2.1.2 Electrically-Powered Prostheses	6
2.1.3 Simulated Prostheses	7
2.2 State of the Art in Prosthetic Wrists	8
2.2.1 Biological Wrist Function	8
2.2.2 Commercially Available Prostheses	10
2.2.3 Research Prostheses	10
2.3 Compensatory Movements Following Upper-Limb Amputation	11

2.3.1	The Source of Compensatory Movements	11
2.3.2	The Effect of Compensatory Movements	12
2.3.3	Measuring Compensatory Movements	12
	Motion-Capture Task Descriptions	13
2.4	Previous Work on Automatic Levelling and Related Control Schemes	16
2.5	Proposal: Self-Levelling Functionality in Prosthetic Wrists	18
3	Initial Usability Study: 1 DOF, Desk Mounted	19
3.1	Study Rationale and Purpose	19
3.2	Methods	20
3.2.1	Control Modes	20
3.2.2	Hardware	23
3.2.3	Experiment Design	25
3.3	Results	26
3.4	Discussion	32
3.4.1	Quantitative Measures	32
3.4.2	Qualitative Measures	32
3.4.3	Study Limitations	32
3.4.4	Recommendations and Future Work	33
3.5	Conclusion	35
4	System Design	36
4.1	Automatic Levelling Method	36
4.1.1	Theoretical Automatic Levelling	38
4.1.2	Practical Automatic Levelling	38
	Angle-Finding Method	38
	PID Control	40
	Other Controllers	42

4.1.3	PID in the Autolevelling System	43
	Mitigating Rotation Error at Vertical Positions	44
	Integration to Sequential Switching	45
4.2	Autolevelling Implementation with Wearable Bypass Prosthesis	46
4.2.1	Hardware	46
	Prosthesis Location	48
	Joint Limits	48
	Control and Usability	48
	Data Specifications	50
4.2.2	Wiring	50
4.2.3	Device Limitations	51
4.3	Conclusion	52
5	The Effect of an Automatically Levelling Prosthesis	53
5.1	Study Rationale and Purpose	53
5.2	Methods	54
5.2.1	Simulated Prosthesis	54
5.2.2	Automatic Levelling Method	55
5.2.3	Experiment Design	56
5.2.4	Data Analysis	59
5.3	Results	59
5.4	Discussion	68
5.4.1	Kinematic Analysis	68
	Cup Transfer Task	68
	Pasta-Box Task	69
5.4.2	Performance Metrics	70
5.4.3	Qualitative Measures	70

	x
5.4.4 Study Limitations	71
5.5 Conclusion	72
6 Conclusion	74
6.1 Summary	74
6.2 Unification of Results	75
6.3 Outcomes	76
6.4 Future Directions	77
6.5 Final Thoughts	77
Bibliography	79
A Detailed Participant Performance Charts	86

List of Tables

3.1	p-values for comparisons across control modes in quantitative results	28
3.2	Corrected p-values for comparisons across control modes in qualitative results . . .	30
3.3	User responses to the question “What about your #1 choice made it your favourite?”	31
3.4	User responses to the question “What about your #5 choice made it your least favourite?”	31
5.1	Population demographics of all participants in the study	56
5.2	User responses to the question “What about your #1 choice made it your favourite?”.	65
5.3	User responses to the question “What about your #3 choice made it your least favourite?”.	66
5.4	p-values for all comparisons. Paired two-sample t-tests were conducted on all continuous data, with Bonferroni correction for three comparisons leading to $\alpha = 0.0167$. For ordinal data (rankings), Mann-Whitney U-tests were conducted with $\alpha = 0.05$.	67

List of Figures

1.1	Lack of wrist dexterity forces users to compensate using shoulder, elbow, and trunk movements in order to keep objects level during lifting.	2
2.1	The degrees of freedom provided by the biological wrist.	8
2.2	The three main functions of the wrist are: (1) holding the hand fixed relative to the forearm, (2) re-orienting the hand, and (3) holding the hand fixed relative to the ground reference frame while the forearm moves. The images depicted here provide examples of tasks wherein each particular function is used.	9
2.3	A demonstration of the sequence of the cup transfer task. The participant moves through each position in order from 1 to 11, looking at the neutral marker at positions 1, 6, and 11.	14
2.4	A demonstration of the sequence of the pasta task. The participant moves through each position in order from 1 to 10, looking at the neutral marker at positions 1, 4, 7, and 10.	15
3.1	The three main functions of the wrist, depicted on the Bento Arm in a manner similar to that used in this study. (1) Holding the hand fixed relative to the forearm, (2) Re-orienting the hand, and (3) Holding the hand fixed relative to the ground reference frame while the forearm moves.	20

3.2	Each mode can be categorized by the two functions it switches between (either fixed to ground-reference-frame and direct control, or fixed to ground-reference-frame and fixed to forearm-reference-frame) and the method of switching (alternate channel, momentary button-press, or held button-press). The subscripts (g) and (f) indicate the default function of the mode when the button is not held, i.e. ground-fixed reference frame or forearm-fixed reference frame, respectively. The accompanying video [45] further clarifies these modes.	21
3.3	Diagram of the control mapping used for the experiment. Figure adapted from [46]	22
3.4	Schematic diagram of Bento Arm indicating joint angle definitions used in (1). . . .	24
3.5	Bento Arm and a custom cart built to facilitate the tasks, with low and high platforms (highlighted here in yellow) and a central sink. The participant would stand behind the arm, and control it using the video game controller.	24
3.6	Average trial performance across all participants, showing time of trial completion, number of spills and number of control switches. Lower bars indicate better performance in all measures. Error bars indicate one SD. Mode E required no switching, and therefore shows zero with no variance in the control switches plot, and no significance is indicated between it and the other modes.	27
3.7	Detailed performance of Participant 3, representative of the group, showing time of trial completion, number of spills, and number of button presses. Control modes are shown in the order they were presented to the participant. Note the overall learning curve and mis-presses of joystick button in control modes A, B and Control, which are not represented in the aggregate data. Other participants' results are provided in Appendix A	28

3.8	Scores and ranks for each control mode, averaged across participants. Error bars indicate one SD. For all scores, 5 indicates best performance, 0 indicates worst performance (Scores for reliability and preference were inverted for easy visual comparison with other scores). Note that preference was ranked on a scale from 1 to 5. Statistical differences were calculated using post-hoc analysis of the Kruskal-Wallis test with $\alpha = 0.05$, with the Bonferroni correction for multiple tests.	30
4.1	Definition of the axes of the Bento Arm terminal device. The axes are defined such that they coincide with the axes of the IMU in the base of the gripper.	36
4.2	The flexion levelling method maintains the angle between the terminal device and the ground that existed when flexion levelling was enabled, in order to maintain the level of a held object no matter the initial grasp angle.	38
4.3	The angles ϕ and θ are defined as shown in this diagram, and can be calculated using the projections of the gravity vector GV on the x-y and y-z planes, respectively.	39
4.4	The PID loops of the rotation and flexion levelling systems are identical to the basic PID loop, with the exception of the addition of the ramping function $f(\theta)$ in the rotation levelling PID loop.	41
4.5	When the flexion angle θ deviates from 180° , the z axis of the IMU and hand no longer lines up with the rotation servo's axis. The rotation servo can still influence the x and y components of the gravity vector up until $\theta = 90^\circ$ or $\theta = 270^\circ$, but not as directly.	44
4.6	A switching signal toggles between hand and wrist flexion control. When using hand control, the wrist flexion autolevels.	46
4.7	The bypass prosthesis consists of the distal portion of the Bento Arm attached to a wrist splint.	47

4.8	Schematic showing the wiring for the entire system, broken down into the three system components: the hip enclosure which serves as power switch; the bicep hub which houses the Arduino Uno and U2D2; and the bypass prosthesis itself instrumented with sensors, controls, and feedback LEDs.	49
5.1	The simulated prosthesis included all joints of the Bento Arm distal to the elbow, and was attached to a wrist splint by a 3D printed handle. A Myo Armband allowed myoelectric control, and a button at the thumb allowed switching. Computation and power were provided externally.	54
5.2	The IMU provided the Gravity Vector (GV), from which the angles ϕ and θ were calculated, using the projections of GV on the x-y and z-y planes. Flexion Levelling kept the angle θ constant; Rotation levelling kept the angle $\phi = 180^\circ$	56
5.3	CUP TRANSFER TASK, TRUNK KINEMATICS: Mean maximum angles (deg) for each participant, for fixed-wrist (FW), sequential-switching (SS), and automatically levelling (AL) conditions. Normative (N) and prosthetic (P) data was collected separately [29], [32]. Significance was determined based on the average of the group using pairwise two-sample t-tests, $\alpha = 0.0167$ for Bonferroni correction.	60
5.4	CUP TRANSFER TASK, SHOULDER KINEMATICS: Mean maximum angles (deg) for each participant, for fixed-wrist (FW), sequential-switching (SS), and automatically levelling (AL) conditions. Normative (N) and prosthetic (P) data was collected separately [29], [32]. Significance was determined based on the average of the group using pairwise two-sample t-tests, $\alpha = 0.0167$ for Bonferroni correction.	61
5.5	PASTA-BOX TASK, TRUNK KINEMATICS: Mean maximum angles (deg) for each participant, for fixed-wrist (FW), sequential-switching (SS), and automatically levelling (AL) conditions. Normative (N) and prosthetic (P) data was collected separately [29], [32]. Significance was determined based on the average of the group using pairwise two-sample t-tests, $\alpha = 0.0167$ for Bonferroni correction.	62

5.6	PASTA-BOX TASK, SHOULDER KINEMATICS: Mean maximum angles (deg) for each participant, for fixed-wrist (FW), sequential-switching (SS), and automatically levelling (AL) conditions. Normative (N) and prosthetic (P) data was collected separately [29], [32]. Significance was determined based on the average of the group using pairwise two-sample t-tests, $\alpha = 0.0167$ for Bonferroni correction.	63
5.7	Performance metrics for each of the control conditions. Columns represent the average across all participants. Error bars indicate one standard deviation. Significance determined using paired two-sample t-tests with $\alpha = 0.0167$ for Bonferroni correction. FW = fixed wrist; SS = sequential switching; AL = autolevelling.	64
5.8	Qualitative user feedback about various performance aspects of the prosthesis control modes. Columns represent the average across all participants. Error bars indicate one standard deviation. For all measures, a higher score indicates better performance. Significance determined using paired two-sample t-tests ($\alpha = 0.0167$ for Bonferroni) for the continuous scores, and a Mann-Whitney U-test for the ordinal rankings ($\alpha = 0.05$). FW = fixed wrist; SS = sequential switching; AL = autolevelling.	68
A.1	Task performance across the entire testing session for Participant 1.	87
A.2	Task performance across the entire testing session for Participant 2.	87
A.3	Task performance across the entire testing session for Participant 3.	87
A.4	Task performance across the entire testing session for Participant 4.	88
A.5	Task performance across the entire testing session for Participant 5.	88
A.6	Task performance across the entire testing session for Participant 6.	88

List of Symbols

GV_{projxy}	projection of the gravity vector on the x-y plane	m/s^2
GV_{projyz}	projection of the gravity vector on the y-z plane	m/s^2
g_x	x-component of gravity vector	m/s^2
g_y	y-component of gravity vector	m/s^2
g_z	z-component of gravity vector	m/s^2
θ	flexion angle	deg
ϕ	rotation angle	deg

List of Abbreviations

AL	Automatically Levelling
DOF	Degrees Of Freedom
EMG	Electromyography
FW	Fixed Wrist
GV	Ground Vector
IMU	Inertial Measurement Unit
LSB	Least Significant Bit
LVDT	Linear Variable Differential Transformer
PID	Proportional-Integral-Derivative
RFID	Radio-Frequency Identification
SHAP	Southampton Hand Assessment Procedure
SS	Sequential Switching
U2D2	USB to Dynamixel, version 2

In order to strike a balance between accuracy and clarity, throughout this thesis I use the term “Automatically Levelling” (abbreviated as “Autolevelling” or “AL”) to refer to what is more properly called “maintaining terminal device orientation relative to the ground reference frame, with respect to horizontal axis rotations only”. The term “Autolevelling” may seem to imply that the terminal device is maintaining some “level” with its axes relative to the ground. The actual behaviour of the wrist is somewhat more complex than that, and is described in Section 4.1. For most intents and purposes, the imagined behaviour conjured by the phrase “Automatically Levelling” is sufficiently accurate to reality.

Chapter 1

Introduction

1.1 Problem

There were approximately 41,000 people affected by major upper limb loss in the United States in 2005, and that number is expected to increase 131% by 2050 [1]. Improved wrist function, simultaneous two-joint movement, and less need for visual attention were among the top reported research priorities of people affected by upper-limb amputation in 1996 [2]. This was true for both transhumeral and transradial amputation alike, and across both body-powered and myoelectric prosthesis users. More recent reviews also indicate a need for better wrist control [3]. A 2015 review of the state of the art in wrist prostheses found that powered wrist movement is still rare in commercial systems, and all of those that are powered have only one degree of freedom (DOF), most often rotation [4]. Many researchers have shown that limitations in ease of wrist movement force people to use compensatory movements [5]–[8], as seen in Fig. 1.1. Some researchers have also shown that despite recent focus on multi-articulating hands, evidence suggests that wrist dexterity may be more important than finger dexterity to avoiding compensatory movements [9].

Populations with upper limb amputation report a higher prevalence of self-reported musculoskeletal pain in the neck, upper back, shoulder, and remaining arm than the able-bodied population, and the use of prostheses does not change this prevalence [10]. Self-reported pain in the

non-amputated arm of people who suffered unilateral amputation was greater than arm pain reported in the control group, indicating that overuse of the non-amputated arm may cause injuries as well. In fact, rotator cuff syndrome on the non-amputated side was the most frequent case diagnosis. Whether a person uses a prosthesis or not, the tendency is to compensate using the non-amputated limb for whatever task is at hand. For bimanual tasks, or other situations which require the use of the amputated limb (as in [5]–[8]), the lack of wrist function is compensated for in trunk, shoulder, and elbow movements where possible. This indicates that current prostheses do not reduce overuse injuries caused by compensatory movements for two reasons: first, the lack of functionality encourages the overuse of the more functional non-amputated limb, and second for tasks that require the use of the amputated limb the prosthesis does not adequately replace the lost wrist function. We suggest that a prosthetic wrist that can automatically adjust its position to maintain the hand's orientation as the rest of the arm moves may reduce instances of injuries by reducing the need for compensatory movements of this nature.

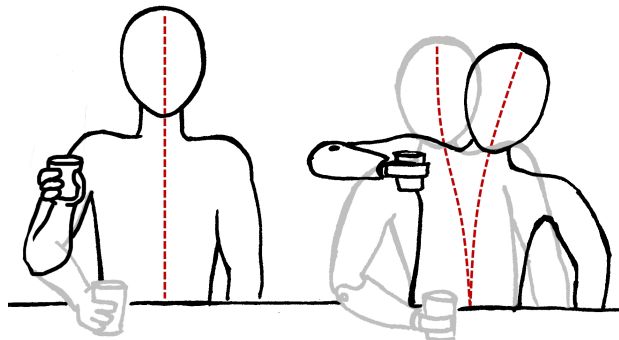

FIGURE 1.1: Lack of wrist dexterity forces users to compensate using shoulder, elbow, and trunk movements in order to keep objects level during lifting.

1.2 Objectives

The objectives within the scope of this thesis are threefold:

1. to design and prototype an active automatically levelling wrist that is easily adaptable to various tasks,

2. to determine the most effective way of integrating it into existing prosthesis control schemes, and
3. to determine the effect of the wrist system on users' interactions with the prosthesis, highlighting compensatory movements, task performance, and user satisfaction.

1.3 Study Strategy

In planning this thesis, I have attempted to adhere to the methods governing good, human-centred design. A properly designed device fills a real need in its user's life; to ensure this, the design process hinges on rapid iterations, keeping the future user of the device in the loop providing feedback where necessary. To that end, this thesis first identifies a need of prosthesis users, and attempts to fill that need. Rather than designing the complete finished product at once, an initial usability study was conducted to ensure that the user interface wouldn't increase the complexity of the prosthesis as a whole. Following that study, and after designing a control system based on those results, I worked to evaluate the actual effect of the device on compensatory movements, task performance, and user satisfaction.

1.4 Summary of Chapter Contents

- Ch. 2: Gives the relevant background information essential to understanding the contents of the following chapters. It includes reviews of the current state of the art in prosthetic wrist control, compensatory movement caused by upper-limb amputation and their physiological effects, and previous work on automatically levelling control schemes. This chapter also propels the motivation of the rest of the thesis, providing arguments supporting the further investigation of self-adjusting wrists.
- Ch. 3: Outlines the initial usability study of the self-adjusting wrist. This study involves a 1-DOF wrist on a desktop-mounted robot arm, six able-bodied participants, and joystick control.

The chapter provides a full analysis of that study and its results, as well as the implications of the results for moving forward with further investigations.

- Ch. 4: Provides a detailed description of the technical development of an automatically-levelling bypass prosthesis with 2 DOF at the wrist.
- Ch. 5: Outlines a second experiment focused on evaluating the effect of the device on compensatory movements. This study uses motion-capture with standardized evaluation tasks to evaluate compensatory movements, task performance, and satisfaction of able-bodied participants using the bypass prosthesis device described in Chapter 4.
- Ch. 6: Summarizes the key findings of the thesis, and provides insights about next steps.

Chapter 2

Background

2.1 Prosthetic Replacement of Upper Limbs

Most readers will be familiar with the idea of prosthetic limb replacement, as this concept has been around for quite a while. In fact, a Roman general as far back as 218-210 B.C.E. had an iron prosthetic hand fashioned for him so that he could carry his shield and return to battle [11]. This section briefly describes the key differences between the two main types of upper-limb prostheses: body-powered and electrically-powered.

2.1.1 Body-Powered Prostheses

Body-powered prostheses typically operate by the use of cables and harnesses which translate shoulder and back movements of the user into hand or elbow motion. Usually, active shoulder movement will open the terminal device, and relaxation allows the device to close by the passive use of springs or elastic bands. This arrangement can be reversed to allow for active closing and passive opening. Body-powered control of the elbow is typically activated by a mechanical switch, which transfers the active shoulder motion to the elbow rather than the hand. This means it is not possible to simultaneously control the various DOF on the prosthesis. When wrist control is provided in a body-powered prosthesis, it is almost always wrist rotation, and usually passively

operated by re-adjustment with the contralateral limb. While some body-powered wrist devices exist, they are quite rare [4].

2.1.2 Electrically-Powered Prostheses

Electrically-powered prostheses, often referred to as “myoelectrically-powered prostheses” or “myoelectric prostheses” typically operate by making use of surface electromyography (EMG). This technique involves applying electrodes non-invasively to the surface of the skin over the residual muscle bellies. When the muscles are contracted, the electrodes detect the electric potential generated by the muscles. Appropriate amplification and filtration of these potentials provides a signal proportional to the degree of contraction which can be used as an input signal to control the prosthesis. Often, two antagonistic muscle sites (for example the biceps and triceps) will be mapped to a degree of freedom (for example, hand open/close). In this example, when the bicep is flexed the hand opens, and when the tricep is flexed the hand closes. The velocity with which the hand opens or closes is proportional to the strength of the muscle contraction. When the muscles are relaxed below a threshold, the prosthesis is typically programmed to hold its position. Conventional methods for EMG control of prostheses are described in detail in [12].

A co-contraction (when both muscles are contracted simultaneously) is often programmatically mapped to a “switching signal”, and is used by the prosthesis operator to change which degree of freedom on the prosthesis they are controlling. Depending on the level of the person’s amputation, there may be several DOFs that the person might wish to control. Typically, these will appear in an ordered list, and the user will sequentially switch from one to the next until they reach their desired DOF, in a method known as “sequential switching”. For people who have difficulty performing a co-contraction, alternative switching methods are available, including bump switches and linear variable differential transformers (LVDTs). Though sequential switching is the most common control method in use today, it is not without its issues. For instance, by nature it disallows simultaneous multi-DOF movement. Additionally, even just a few items in the switching list

can quickly become unwieldy, leading to body compensation rather than switching. A number of alternatives have been proposed to address its various shortcomings.

Adaptive switching makes for more effective use of the sequential switching method by dynamically reordering the switching list based on predictions of what the person will do next [13]. Further to this idea, autonomous switching aims to remove the need for manual switching by allowing the machine to switch the joint being controlled for the user when appropriate [14].

Pattern recognition methods use trained classifications to decode patterns of muscle contraction into meaningful control signals [15]. Because they are not restricted to simple contraction of antagonistic muscle groups, it is possible to train different patterns to correspond to different degrees of freedom, thus enabling multi-DOF control without requiring switching [16]. For advanced prosthesis-users with sophisticated pattern recognition algorithms, this can even mean the possibility for simultaneous multi-joint movement [17].

2.1.3 Simulated Prostheses

It is sometimes useful to simulate the use of a prosthesis with able-bodied people to facilitate rapid testing and prototyping in advance of testing with people affected by amputation. A simulated prosthesis, sometimes referred to as a “bypass prosthesis”, is worn over a person’s intact arm, restricting and bypassing the function of their biological arm and hand to enable the function of the prosthesis. A number of groups have used simulated prostheses to carry out their research, but no consensus has been reached regarding appropriate design of these devices. Farrell et al. [18] and Bouwsema et al. [19] both make use of a myoelectrically controlled simulated prosthesis that extends distally to the forearm. This design allows good visibility of the terminal device, but the extended length can be fatiguing, especially if the terminal device is heavy. Further, the added limb-length can cause changes in people’s movement strategies. Kuus et al. [20] makes use of a below-hand mounted prosthesis designed for use in sensory-feedback studies. The below-hand design helps to mitigate some of the fatigue and movement related concerns, but the terminal device can become occluded from the viewpoint of the user by their biological hand. Further,

the possibility of collisions with the user's biological hand restricts the range of motion of any prosthetic wrist. Both Bouwsema's and Kuus' designs restrict the motion of the user's biological hand, which can help in creating and maintaining clear myoelectric signals in the forearm. A custom simulated prosthesis is used in this work, with care taken to address each of these concerns as much as is possible. The design is described in detail in Chapter 4.

2.2 State of the Art in Prosthetic Wrists

2.2.1 Biological Wrist Function

Because wrist prostheses are intended to replace the lost function of a biological wrist, it makes some sense to provide a detailed explanation of the function of the wrist prior to delving into the various prostheses that are available. The wrist can be thought of as providing three degrees of freedom: flexion/extension, radial/ulnar deviation, and pronation/supination, as depicted in Fig. 2.1. To be precise, pronation/supination is truly provided by the forearm by the radius and ulna crossing over one another, but for the purposes of prosthesis design this DOF is generally considered to be a part of wrist function. When considered in prosthesis design, pronation/supination is often referred to simply as rotation.

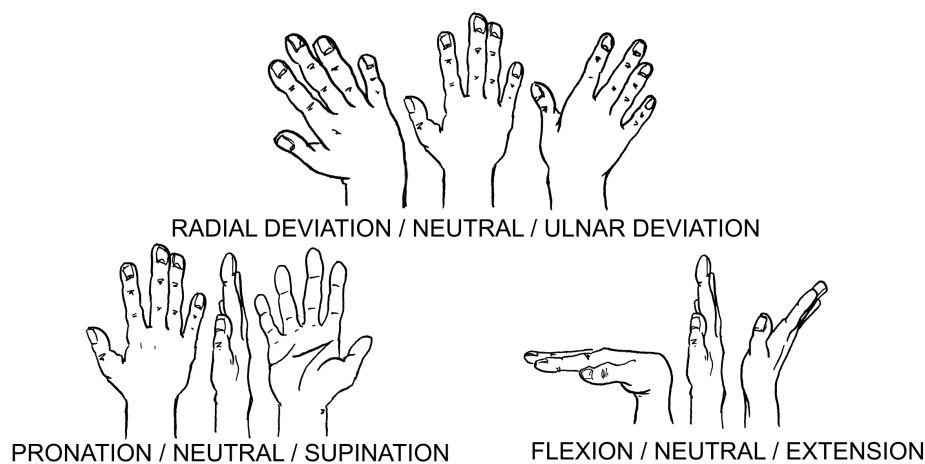

FIGURE 2.1: The degrees of freedom provided by the biological wrist.

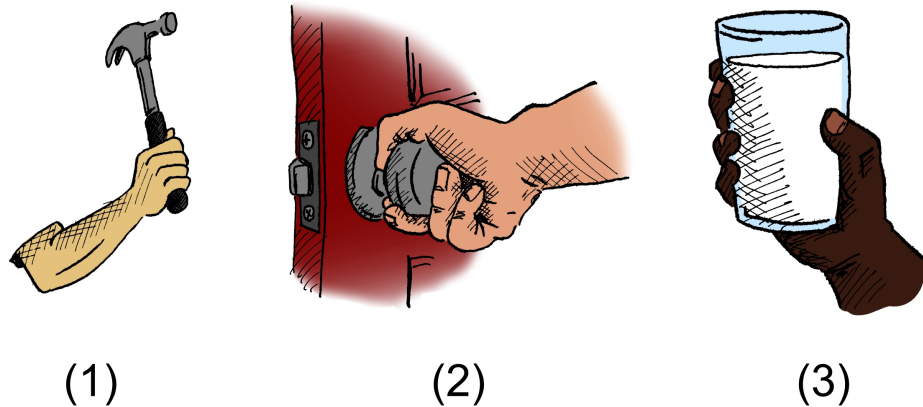

FIGURE 2.2: The three main functions of the wrist are: (1) holding the hand fixed relative to the forearm, (2) re-orienting the hand, and (3) holding the hand fixed relative to the ground reference frame while the forearm moves. The images depicted here provide examples of tasks wherein each particular function is used.

In a 1980 proposal to suggest the idea of an automatically levelling prosthetic wrist, Swain and Nightingale broke down the main functions of the wrist into three categories [21], depicted in Fig. 2.2:

1. holding the hand fixed relative to the forearm reference frame,
2. reorienting the hand, and
3. holding the hand fixed relative to the ground reference frame (i.e., aligned according to the direction of gravity).

The first function requires no DOF at the wrist, and therefore it is relatively easy to replace this functionality with a prosthesis. The second and third functions may require any combination of the three degrees of freedom. In case (2) the DOFs may be controlled sequentially by a prosthesis to achieve the same result as that arrived at by a biological wrist. However, in case (3) these DOFs must be controlled synergistically. Simultaneous multi-DOF control is difficult to achieve with a prosthetic limb, and is the focus of much of the research described in Section 2.2.3.

2.2.2 Commercially Available Prostheses

A comprehensive review of the state-of-the-art in wrist prostheses was conducted in 2015 [4], which showed that very few electrically powered wrists are commercially available. All of those that are available offer only a single powered degree of freedom, most commonly rotation. This means that, in terms of replacing the functions of the wrist, we are able to replace function (1) only, and are able to replace function (2) only in a very limited way, since it truly requires all three degrees of freedom. There are no commercially available prostheses that attempt to fulfill function (3).

2.2.3 Research Prostheses

Generally speaking, the state-of-the-art in research prostheses is ahead of that available commercially to the public, in terms of both form and function. The Modular Prosthetic Limb (MPL) from Johns Hopkins University boasts 3 DOF at the wrist; the RIC Arm (Rehabilitation Institute of Chicago) features flexion/extension and rotation; and the DEKA Arm (developed by DARPA) makes use of rotation and a combination of flexion/extension and radial/ulnar deviation [4]. Wrist flexion units are being developed toward commercial availability [22], [23], but control of these extra degrees of freedom remains challenging [24]. Machine learning methods provide some promise in this area, notably pattern recognition and adaptive switching, both described in Section 2.1.2.

The Bento Arm [25] is an open-source [26] robotic arm with 2 DOF at the wrist which was used extensively throughout the studies in this thesis. The wrist is designed with servos in series, with the rotation servo serving as the most proximal wrist joint. The distal wrist joint can serve as either a flexion/extension unit or radial/ulnar deviation unit depending how the terminal device is physically mounted to the wrist. The arm can be controlled with a variety of methods through its open-source software [27], which makes it ideal for use in research applications. It was chosen as the platform for research in this study because it is lightweight, easily modifiable, and provides position feedback from each of the servos, making control modifications simple.

2.3 Compensatory Movements Following Upper-Limb Amputation

2.3.1 The Source of Compensatory Movements

A study conducted by Adams et al. on the effect of reduced wrist movement in able-bodied people provides insight on the importance of wrist function [5]. People performing tasks of daily living with wrist motion restricted by a brace were found to have longer task completion times, greater compensatory movements, and worse perception of their own performance, compared to their own performance without the brace. The results were significant even if the wrist motion was only partially restricted (30° degrees flexion and 30° extension). Mell et al. looked specifically at compensatory movement of the humerus due to wrist restriction in tasks requiring a person to reach around a barrier, such as picking items from a box [8]. This group also found that restricted wrist motion caused compensation; the humeral elevation angle (corresponding to shoulder flexion) increased significantly when wrist motion was restricted compared to the normal case.

The results of these studies seem to translate from the able-bodied population to the prosthesis-user population as well. Metzger et al. conducted a study with prosthesis users that indicated a significantly greater degree of trunk movement than an able-bodied population performing the same tasks of daily living [6]. Importantly, the sub-group of prosthesis-users with transradial amputation still displayed these trunk compensatory movements despite the use of their intact elbow. Further work investigating compensatory movements specifically for the case of transradial amputation indicates that the methods of compensation differ depending on the task [7]: for box lifting and door opening trunk compensations are apparent, but for drinking from a cup compensations occur mainly in the shoulder and elbow. It is also interesting to note that this study showed that braced able-bodied persons showed similar compensations to the prosthesis-user population, although to a lesser degree.

From these studies it becomes quite clear that the distal degrees of freedom are exceedingly important to the reduction of compensatory movements, but it may not be immediately apparent

whether that is to be solved by more dexterous hand prostheses or by more capable wrist prostheses. 2014 work by Montagnani et al. addresses this problem specifically by testing various bracing configurations that allowed either hand or wrist function to be restricted [9]. The results from this study indicate that a capable wrist even with a rudimentary hand prosthesis might be able to adequately address compensatory movements in people with upper-limb amputation.

2.3.2 The Effect of Compensatory Movements

Populations with upper limb amputation report a higher prevalence of self-reported musculoskeletal pain in the neck, upper back, shoulder, and remaining arm than the able-bodied population, and the use of prostheses does not change this prevalence [10]. The fact that these injuries occur in the upper back and shoulder (where compensatory movements were found to occur) seems to suggest that the compensatory movements cause these injuries. Further, the fact that the prevalence of these injuries doesn't change depending on whether a person does or does not use a prosthesis suggests that current prostheses do not adequately address the compensations of these individuals.

2.3.3 Measuring Compensatory Movements

Many researchers use optical motion-capture techniques to quantitatively measure movement strategies [28]. By capturing the three-dimensional positions of body-mounted markers using an array of cameras, it is possible to track limb positions throughout time, and from that information calculate joint angle kinematics. When comparing results across studies, it is of course of the utmost importance that the testing conditions are comparable. To that end, a team led by Jacqueline S. Hebert has developed standardized tasks and testing conditions to form a baseline of comparison. Two of these tasks are used in this thesis, and are described later in this section.

Valevicius et al. performed these tests with a population of twenty non-disabled participants, providing a normative data set for both hand movements [29] and trunk and shoulder movements [30]. This study was conducted using a 12-camera Vicon Bonita setup. A comparative study was conducted by Boser et al. to validate using a cluster-based marker model against the more conventional anatomical model [31]. This study determined that a cluster-based marker model is adequate to assess trends in movement patterns, but may not allow direct comparison to anatomical models. To provide another baseline for assessment, these tests were also studied with a prosthesis-user population; this assessment was done using the 12-camera Vicon setup [32]. For this study, a range of prosthesis types were tested (transhumeral and transradial, body-powered and myoelectric), but no participant made use of a transradial myoelectric prosthesis. The pasta-task portion of the task was also evaluated with able-bodied persons using a simulated prosthesis [33]; this study showed that simulated prosthesis users took more time to perform the task and had more velocity peaks than were present in the normative trials.

Motion-Capture Task Descriptions

Only the brief description necessary for understanding the study and its results is given here; for a complete and thorough description of the standardized tasks, please see the original work [29]. The study involved two tasks: the Cup Transfer task, and the Pasta-Box task. Each task involved a series of prescribed movements interacting with common objects, ending with the return of the objects to their starting positions. The trials began and ended with the participant placing their hand on a home position and their eyes fixed on a marker in a neutral position. For both of these tasks, mistrials caused by participant error (incorrect execution of the task, spills, dropped items) are recorded and reported as a measure of task performance.

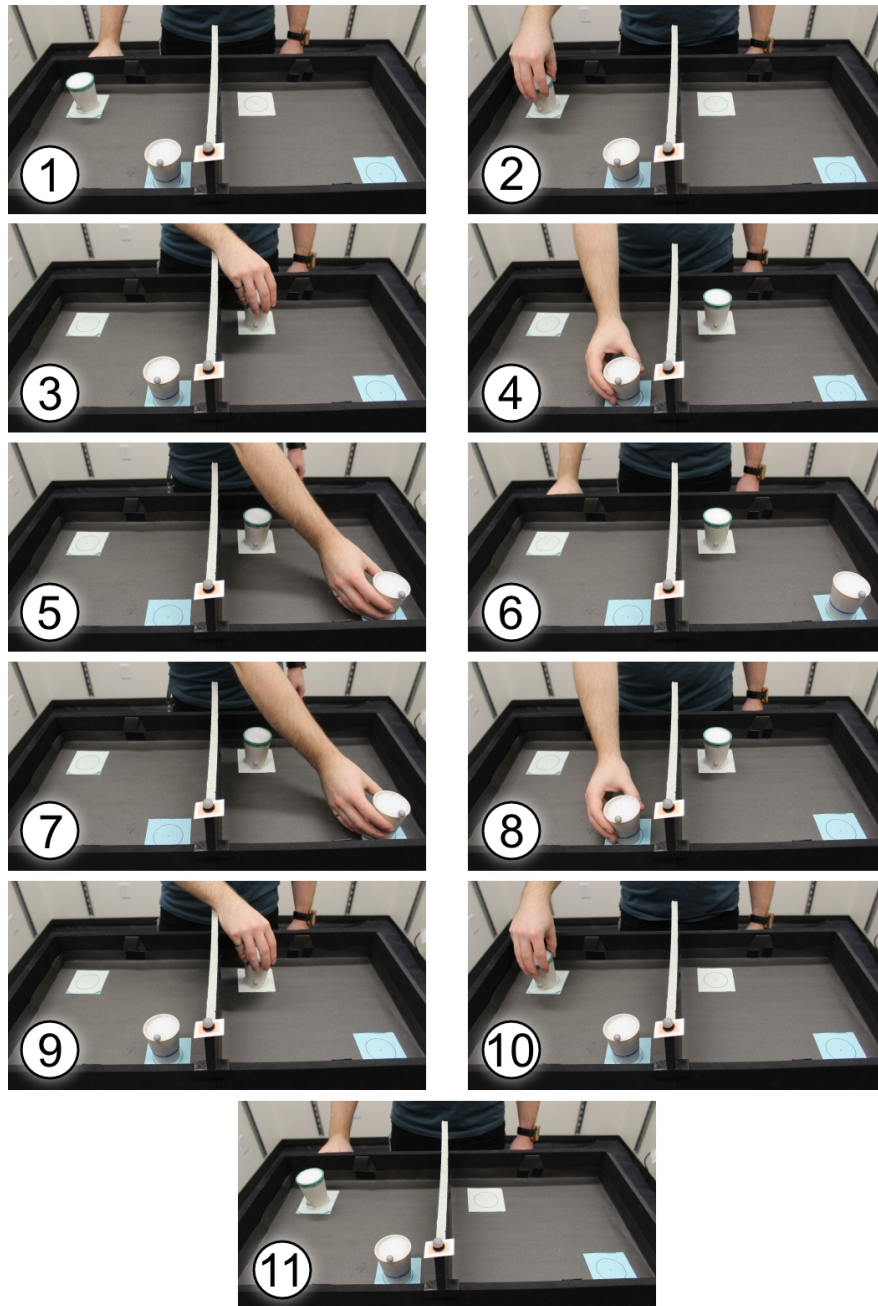

FIGURE 2.3: A demonstration of the sequence of the cup transfer task. The participant moves through each position in order from 1 to 11, looking at the neutral marker at positions 1, 6, and 11.

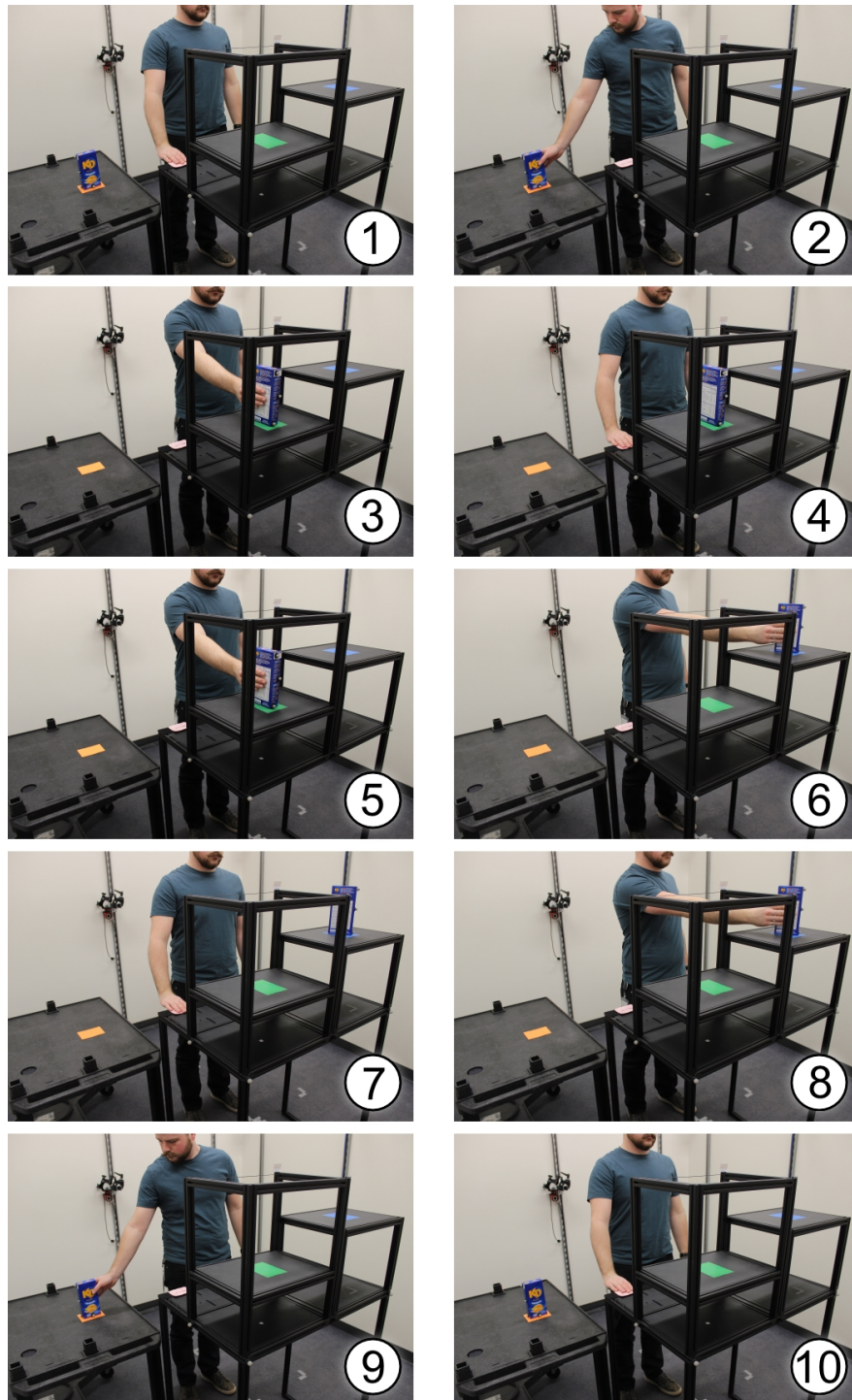

FIGURE 2.4: A demonstration of the sequence of the pasta task. The participant moves through each position in order from 1 to 10, looking at the neutral marker at positions 1, 4, 7, and 10.

The Cup Transfer Task involved two cups full of beads on the right-hand side of a table with a short barrier down the middle. The participant was intended to first grasp the near cup from the top, and transfer it to the other side of the table over the barrier. Next the participant grasped the further cup from the side and also transferred it over the barrier. Following this, the cups were returned to their starting positions in the same manner but in the opposite order: far cup first, and near cup last. This task involved movements predominately in a horizontal plane, and caused the participant to cross their midline with their active hand. The bead-filled cups, made of compliant paper, posed a challenge to avoid spills by either tipping the cup too much or squeezing too hard. A demonstration of the task is shown in Fig. 2.3.

The Pasta-Box task involved transferring a box of pasta from a low side table to a series of higher shelves, and finally returning the pasta box to the side table. This task involved more vertical movement than the Cup Transfer task. The task is represented visually in Fig 2.4.

2.4 Previous Work on Automatic Levelling and Related Control Schemes

Autonomous levelling systems have been widely explored in other robotic applications such as camera stabilization [34]. Recently, levelling has made its way into rehabilitative and medical technologies such as the Liftware Level: a handle that keeps an attachment such as a spoon stable for people suffering from hand and arm tremors [35]. A wrist control system for prostheses that would work on similar principles was suggested in 1980 [21], and again in 1995 [36], but the technology had not been researched until recently.

In 2013, Ohnishi et al. developed a wrist and hand system that dynamically adjusted hand orientation through a specific pick-lift-place task using lookup tables, multimodal sensors, and state machine logic [37]. A wrist capable of reading radio frequency identification (RFID) tags to re-orient the hand to match a platform's orientation (either vertical, horizontal, or at a random angle) was also explored by Shibuya et al. in 2017 [38]. They showed some initial evidence of reduced compensation, but task time tended to increase because of the need to interact with RFID

tags in the environment. The reliance on lookup tables and RFID tags also substantially limits the applicability of the system for real-world daily use, where motions become less predictable and RFID tags may not always be available.

Passive means of adapting the wrist position during use have also been explored. A passive, friction-based compliant wrist was developed by the team of Rosa Jacobs, P.T. in 1993, which had positive reviews from its users. The compliant wrist enabled the interaction with objects such as bike handlebars, piano keys, baseball bats, and other sporting equipment with a “more fluid response” [39]. The limitations of the device or any quantitative evaluation of the device’s performance are unfortunately not included in the paper, and it remains unclear why the device has not seen widespread use in the subsequent years.

Christian Cipriani’s group developed a wrist with switchable stiffness that could be compliant or stiff depending on the needs of the task [40]. They tested its effects using components of the Southampton Hand Assessment Procedure (SHAP), and found that using a compliant wrist during reaching and grasping and a stiff wrist otherwise reduced compensatory movements in the shoulder and back [41]. They measured compensatory movements using linear potentiometers and conducted their study with 10 able-bodied participants using a below-hand mounted bypass prosthesis.

While flexible wrists seem to be beneficial in a laboratory setting, the reviews from actual prosthesis users seem to be more equivocal. Deijs et al. conducted a study with eight persons with transradial amputation using myoelectric prostheses, looking specifically at task performance, shoulder joint-angle compensations, and user satisfaction. They tested two wrists with both static and flexible configurations, and were unable to find statistically significant differences in people’s performance, compensation, or satisfaction between the static and flexible conditions [42]. However, “participants’ satisfaction tended to be in favour of flexible wrists”.

2.5 Proposal: Self-Levelling Functionality in Prosthetic Wrists

From this background, it becomes quite clear that wrist function is essential to the reduction of compensatory movements, and subsequently to the reduction of overuse injury. Further, multiple studies of prosthesis-users' reported research priorities highlight wrist function as highly ranked [2], [3], suggesting that a highly functional wrist is long overdue. Advanced research prostheses are able to accurately provide all three degrees of freedom of the wrist, but the control interface remains challenging. A wrist that is able to perform all of its functions at the appropriate times with minimal or no conscious guidance from the user would be the ideal prosthesis.

Designers of above-the-knee leg prostheses have used the predictability of gait patterns to develop microprocessors for artificial knees that adapt stiffness parameters to provide optimal performance at each stage of walking [43]. Typical upper limb tasks seldom involve such predictable movements, making control design difficult—but the third function of the wrist may be suitably predictable. A scheme that maps multiple wrist DOF in a useful way to a single degree of control could improve function. Therefore, *we propose a self-adjusting wrist control system that would allow automatic repositioning of the wrist in response to arm position to keep the terminal device fixed relative to the ground reference frame.* Essentially, we propose an automatically levelling wrist.

Chapter 3

Initial Usability Study: 1 DOF, Desk Mounted

3.1 Study Rationale and Purpose

When designing something that is going to be intimately tied with the human body, it is exceedingly important that the designer place a heavy emphasis on human-centred design. Many designers advise iterating quickly and often, with usability studies all along the way to ensure that the end product is one that is a joy to use [44]. This study represents an effort to ensure that the control interface of our automatically levelling wrist is considered acceptable by its users. This consideration is important not only for user satisfaction, but also to avoid confounding the usability of an automatically levelling wrist with the usability of its control interface.

What follows is an adapted version of a study that was originally published in the proceedings of the 7th IEEE RAS/EMBS International Conference on Biomedical Robotics and Biomechatronics (BioRob), August 26-29, 2018. [45]

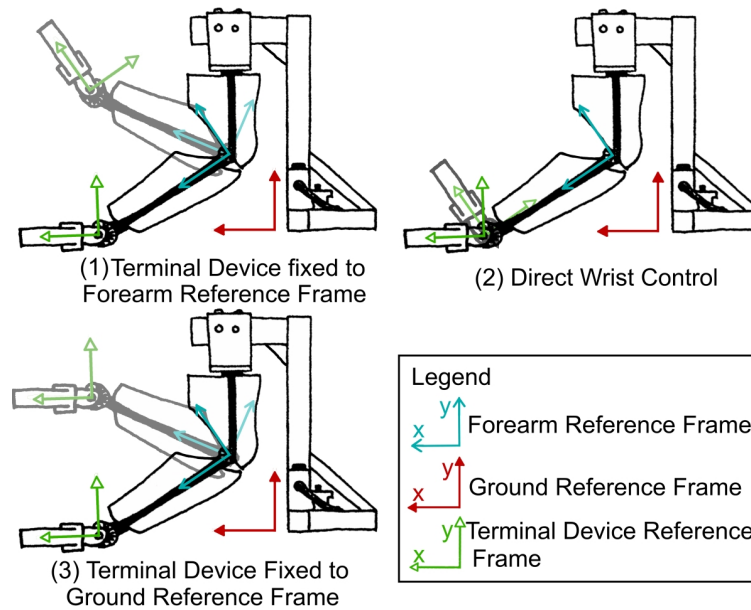

FIGURE 3.1: The three main functions of the wrist, depicted on the Bento Arm in a manner similar to that used in this study. (1) Holding the hand fixed relative to the forearm, (2) Re-orienting the hand, and (3) Holding the hand fixed relative to the ground reference frame while the forearm moves.

3.2 Methods

3.2.1 Control Modes

This study compares five methods of interfacing with the self-adjusting wrist. The objective is to determine which method or which characteristics of each method might make the most intuitive interface. The conclusions from this study will be applied to a more rigorous future study comparing the self-adjusting wrist to conventional myoelectric wrist control. The five modes were denoted A through E, and were composed of the three possible types of wrist function: (1) fixed to forearm, (2) direct control, or (3) fixed to ground reference frame, each of which are depicted in Fig. 2.2, and specifically illustrated for this study's setup in Fig. 3.1.

Each of the control modes switches between two of the above mentioned functions: fixing the terminal device relative to the ground-frame (3), and either function (1) or (2). Depending on the mode, switching is accomplished by either a held button press (the secondary function performed

only while a button is pressed), a momentary button press (toggling between the primary and secondary functions), or by input from a secondary control channel (overriding the primary function with the secondary). A visual categorization of how each control mode functions is given in Fig. 3.2, and examples of the resulting motion are shown in the video accompanying the original publication [45]. The control modes are as follows:

- A. Momentary button press toggles between fixed to forearm frame (1) and ground reference frame (3)
- B. Momentary button press toggles between direct wrist control (2) and ground reference frame (3)
- C. Held button press switches from ground reference frame (3) to fixed to forearm frame (1)
- D. Held button press switches from fixed to forearm frame (1) to ground reference frame (3)
- E. Secondary input channel overrides ground reference frame (3) with direct wrist control (2)
- X. *Control Condition*: Conventional control scheme. Momentary button press switches between fixed to forearm frame (1) and direct wrist control (2).

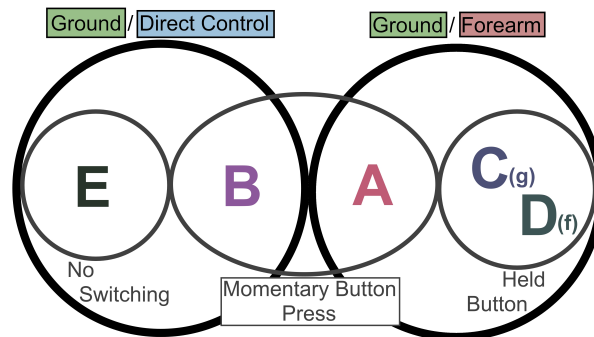

FIGURE 3.2: Each mode can be categorized by the two functions it switches between (either fixed to ground-reference-frame and direct control, or fixed to ground-reference-frame and fixed to forearm-reference-frame) and the method of switching (alternate channel, momentary button-press, or held button-press). The subscripts (g) and (f) indicate the default function of the mode when the button is not held, i.e. ground-fixed reference frame or forearm-fixed reference frame, respectively. The accompanying video [45] further clarifies these modes.

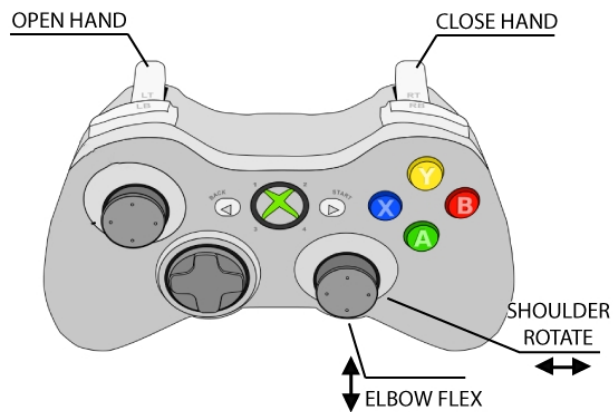

FIGURE 3.3: Diagram of the control mapping used for the experiment. Figure adapted from [46]

An Xbox 360 video-game controller was used to control the arm instead of myoelectric control in order to achieve cleaner, clearer control signals, thereby reducing inadvertent movements which would make the system more difficult to learn. The control mapping is depicted in Fig. 3.3. The “A” button was used for momentary button-presses, held button-presses were accomplished by pressing the joystick button, and the secondary joystick served as the secondary input channel. Rather than using sequential joint control as is typical in myoelectric systems, each joint was mapped to a separate input except wrist control, to facilitate faster learning of the system in general. The right joystick x-axis (side-to-side) controlled shoulder rotation, while the y-axis (up-and-down) controlled elbow movement. The right trigger closed the hand; the left trigger opened the hand. For extension to an electromyography (EMG) system, co-contractions would serve as momentary button-presses, and secondary inputs would require an extra set of EMG channels. The held button-press of modes C and D does not directly translate to EMG control, since a held co-contraction is infeasible. EMG systems can however be paired with other switching systems such as latching buttons or body-powered LVDTs which may be used to provide a sustained signal, so modes C and D were included for completeness.

3.2.2 Hardware

A self-adjusting wrist must be able to perform well in tasks that require hand reorientation as well as in tasks that require dynamic levelling. Standard evaluations such as the box-and-blocks task or Southampton Hand Assessment Procedure do not directly evaluate a user's ability to maintain terminal device orientation relative to the ground reference frame, so a custom evaluation was devised that involved two separate tasks:

1. moving a cup filled to the brim with beads from a low platform to a high platform (requiring use of some adaptive levelling scheme to avoid spilling beads), and
2. moving a cup filled to the brim with beads to a sink, and emptying the cup (requiring reorientation of the hand to pour).

To perform the tasks, each participant controlled a desk-mounted Bento Arm, developed at the University of Alberta [25]. The Bento Arm was chosen as the research platform because it is analogous to commercially available prostheses, while being inexpensive and simple to modify for experimentation. The arm has five degrees of freedom: rotation of the shoulder, elbow flexion/extension, wrist rotation, wrist flexion/extension, and hand open/close. The desk-mounted configuration was chosen to avoid design complications involved in making the device wearable. This configuration also limits the movement of the arm, ensuring that only one DOF at the wrist was necessary for levelling. To simplify the implementation of a self-adjusting wrist for this initial usability study, wrist rotation was restricted.

The arm was controlled using the open-source brachI/Oplexus control software [27], modified so that the amount of wrist deviation was programmed to be kinematically linked to the amount of elbow flexion/extension when performing fixed-to-ground-frame functionality. The equation governing this relationship is

$$\theta_1 = 180^\circ + \theta_3 - \theta_2 \quad (1)$$

The symbols θ_1 , θ_2 , and θ_3 are defined as in Fig. 3.4:

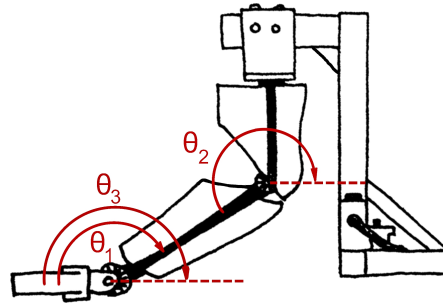

FIGURE 3.4: Schematic diagram of Bento Arm indicating joint angle definitions used in (1).

θ_1 : *Wrist angle*. Clockwise from terminal device to forearm

θ_2 : *Elbow angle*. Clockwise from forearm to ground-frame horizontal axis

θ_3 : *Terminal device offset angle*. Clockwise from terminal device to ground-frame horizontal axis

The angle definitions correspond with the digital encoder positions built into the servos.

A custom cart was built to satisfy the required environment for the tasks, pictured in Fig. 3.5. The height difference between the two columns is sufficient to cause beads to spill from a carried cup if the wrist position is not adjusted to maintain a level terminal device. The central sink is too high to allow pouring beads using only elbow motion; a combination of reorientation of the terminal device and elbow position is necessary to completely empty the cup.

- a) Bento Arm
- b) High Platform
- c) Low Platform
- d) Central Sink
- e) Video-Game Controller
- f) Computer
- g) Cup of Beads

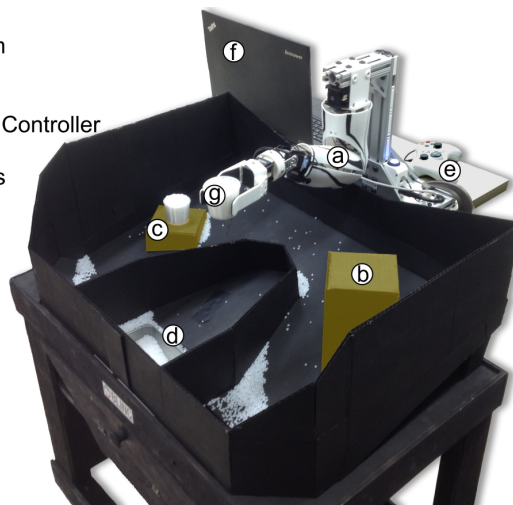

FIGURE 3.5: Bento Arm and a custom cart built to facilitate the tasks, with low and high platforms (highlighted here in yellow) and a central sink. The participant would stand behind the arm, and control it using the video game controller.

3.2.3 Experiment Design

The experiment was approved by the Research Ethics Board of the University of Alberta. It was performed with six able-bodied participants, who gave informed written consent prior to participating.

Each participant was first introduced to the general Bento Arm control scheme, and given approximately five minutes to familiarize themselves with the arm and the controls. During this training period no wrist control was given; the terminal device remained fixed to the forearm frame. Participants were then instructed on the format of the trials: each trial consisted of two tasks, each performed once, beginning with the transfer task followed by the pouring task. For each mode the experimenter explained the controls, and then the participant was allowed approximately one minute to gain familiarity. A block of ten trials was recorded for each control mode before introducing the next. The order that the control modes were presented to the participants was randomized. Due to scheduling constraints, the control condition was presented to each participant on a separate day approximately one month after the initial set of trials.

Time of trial completion, number of spills, and number of control switches were measured, and a survey was completed by each participant. Timing began at the first movement of the Bento Arm, and finished after release of the cup upon returning it to the initial platform at the end of the trial. Spills were tracked manually by experimenter observation during the trials, and checked again afterward using recorded video data. A spill was defined as any number of beads falling from the cup unintentionally. The number of beads per spill was not counted, and varied widely. The number of times the “A” button and joystick button were pressed was tracked using the control software.

The survey included four relative comparison questions, a preference ranking, and a section for specific comments. The comparison scores were given throughout the study after each control mode, and participants were allowed to adjust the scores they gave to each mode as the study progressed. The relative comparison questions addressed intuitiveness (“How easy was each control

mode to learn?”), effectiveness at the transfer task (“How well did each control mode perform the cup transfer task?”), effectiveness at the pouring task (“How well did each control mode perform the cup pouring task?”), and reliability (“How often did you find the arm moved in a different way than you wanted or expected?”). These comparisons were given scores between 0 and 5, where 0 indicated difficult, very poor, or hardly ever, and 5 indicated easy, exceptionally well, or very often. At the end of the study, participants gave a unique rank to the control modes in order of preference from 1 (most preferred) to 5 (least preferred). Participants then commented on what features of their most and least preferred choices made them the best or worst. Since the control condition was tested on a separate day, it was not included in the qualitative survey to avoid biases due to memory effects.

Mean differences in performance were assessed using a repeated-measures analysis of variance (ANOVA). The F-test of significance was used to assess the effects of the different independent variables. If significance was found, pairwise comparisons (paired-sample t-tests) were made to assess where the differences lie. A Bonferonni correction for multiple comparisons would have been very conservative, so Least Significant Difference was used to highlight differences for this pilot study. Normality was assessed using the Kolmogorov-Smirnov Test and sphericity was assessed through a Mauchly’s Test of Sphericity. In cases where the assumption of sphericity was unmet, a Greenhouse-Geisser Correction was applied and reported. This sequence of analyses was followed in all the repeated-measures ANOVA conducted on the datasets in this study. All results were found to follow assumptions of normality with the exception of mode C spill data, and modes A and C control switch data. These deviations from normality were minor, so the data was included in the ANOVA regardless.

3.3 Results

Fig. 3.6 shows the average performance of the participants using each control mode, including time of task completion, number of spills per trial, and number of control switches per trial. This

aggregate data obfuscates a few interesting features visible in each participant's detailed data, most notably: learning curves throughout each control mode and the study in general, mis-pressed buttons, and the order the control modes were presented. Fig. 3.7 shows this detail for one participant (P3), representative of the group. Note the erroneous use of the joystick button in modes A, B and Control. Such mis-presses are not included in the control switches plot of Fig. 3.6. Also note the general learning curve of the participant throughout the progression of the study. Detailed results for all participants are provided in Appendix A.

Significant differences were found in all measures: $F(5,25) = 5.557$, $p = 0.001$ for time of trial completion; $F(5,25) = 18.201$, $p < 0.001$ for spills per trial; $F(5,25) = 30.055$, $p = 0.001$ (Greenhouse-Geisser correction applied) for control switches per trial. Pairwise comparisons indicated a number of significant differences, summarized in Table 3.1.

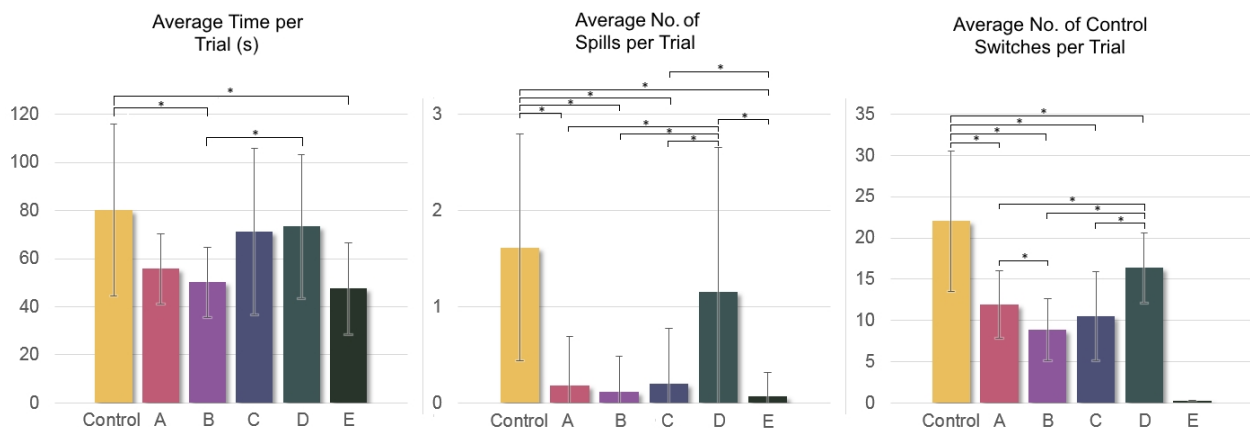

FIGURE 3.6: Average trial performance across all participants, showing time of trial completion, number of spills and number of control switches. Lower bars indicate better performance in all measures. Error bars indicate one SD. Mode E required no switching, and therefore shows zero with no variance in the control switches plot, and no significance is indicated between it and the other modes.

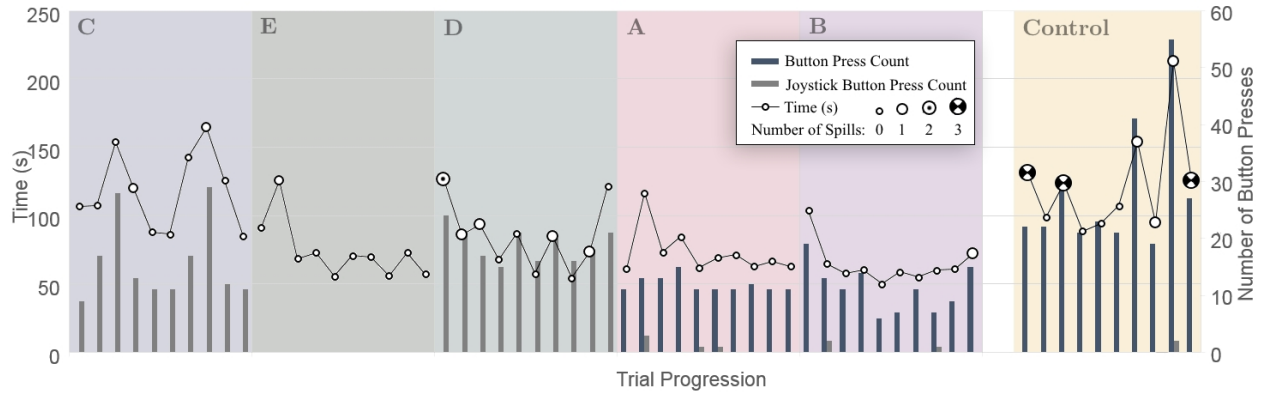

FIGURE 3.7: Detailed performance of Participant 3, representative of the group, showing time of trial completion, number of spills, and number of button presses. Control modes are shown in the order they were presented to the participant. Note the overall learning curve and mis-presses of joystick button in control modes A, B and Control, which are not represented in the aggregate data. Other participants' results are provided in Appendix A

TABLE 3.1: p-values for comparisons across control modes in quantitative results

Comparison	Time	Spills	Switches
A vs B	0.055	0.491	0.005*
A vs C	0.163	0.887	0.396
A vs D	0.075	0.026*	0.013*
A vs E	0.140	0.152	-
A vs X	0.055	0.002*	0.036*
B vs C	0.075	0.297	0.206
B vs D	0.025*	0.016*	0.001*
B vs E	0.654	0.514	-
B vs X	0.021*	0.001	0.008*
C vs D	0.793	0.012*	0.001*
C vs E	0.062	0.025*	-
C vs X	0.093	0.002*	0.006*
D vs E	0.034	0.011*	-
D vs X	0.521	0.259	0.005*
E vs X	0.030*	0.001*	-

Analysis of Fig. 3.6 along with Table 3.1 shows some interesting trends:

- Control modes A and B (the two modes that require a momentary button press to switch functions) perform similarly in all measures. B (direct control) tends to perform better than A where they do differ.
- Mode E (no switching, direct control) showed the fastest trial times and the fewest number of spills. By the nature of the mode, E necessarily has the fewest number of switches.
- The control condition (no self-adjusting wrist) induced the greatest number of switches and the greatest number of spills and the longest trial times.
- Of the self-adjusting modes, the highest number of spills occurs in mode D (fixed wrist by default, held button press for ground-frame self-adjustment).
- Though modes C and D are similar (both require held button presses), C (ground reference frame by default) performs significantly better than D for spills and control switches.
- Toggling modes (A and B) perform as well as or better than held button press modes (C and D) in all measures.

The survey results are summarized in Fig. 3.8. For these charts, the scores given by the participants for reliability and preference were inverted to facilitate ease of comparison across measures (i.e. 5 always indicates better performance, 0 indicates worse). Note that the preference rankings exist on a scale from 1 to 5. A Kruskal-Wallis test revealed a significant effect of mode on effectiveness in the transfer task ($H(4) = 11.746$, $p = 0.019$), intuitiveness ($H(4) = 13.352$, $p = 0.010$), and user preference rank ($H(4) = 13.372$, $p = 0.010$). A paired t-test post-hoc analysis with Bonferroni correction showed where the significant differences lie, as outlined in Table 3.2.

User comments from the survey are all given in a randomized order in Table 3.3 and Table 3.4. These statements were made in response to the question “What about your #1 choice made it your favourite?” and “What about your #5 choice made it your least favourite?”, respectively.

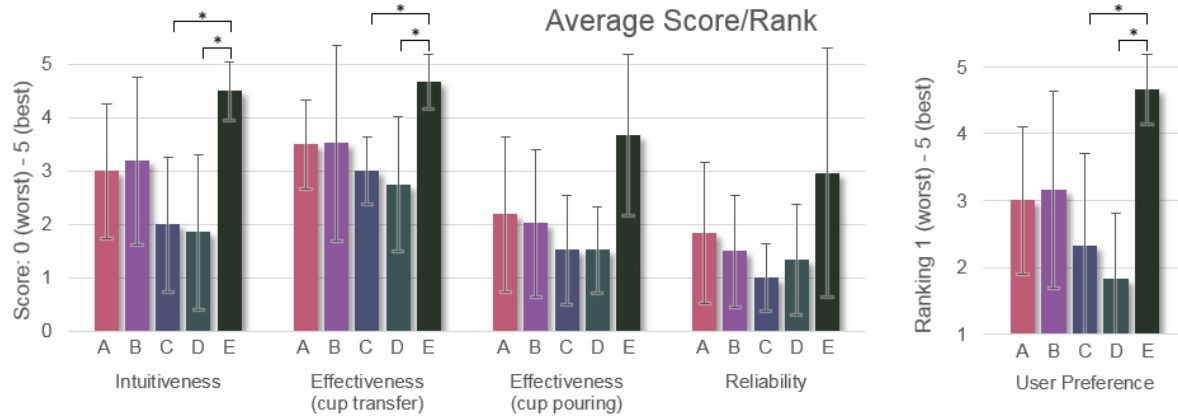

FIGURE 3.8: Scores and ranks for each control mode, averaged across participants. Error bars indicate one SD. For all scores, 5 indicates best performance, 0 indicates worst performance (Scores for reliability and preference were inverted for easy visual comparison with other scores). Note that preference was ranked on a scale from 1 to 5. Statistical differences were calculated using post-hoc analysis of the Kruskal-Wallis test with $\alpha = 0.05$, with the Bonferroni correction for multiple tests.

TABLE 3.2: Corrected p-values for comparisons across control modes in qualitative results

Comparison	Effectiveness (Transfer)	Intuitiveness	Preference
A vs B	1.000	1.000	1.000
A vs C	1.000	1.000	1.000
A vs D	1.000	1.000	1.000
A vs E	0.490	0.479	0.448
B vs C	1.000	1.000	1.000
B vs D	1.000	1.000	1.000
B vs E	1.000	0.850	0.709
C vs D	1.000	1.000	1.000
C vs E	0.033*	0.021*	0.050*
D vs E	0.035*	0.013*	0.006*

TABLE 3.3: User responses to the question “What about your #1 choice made it your favourite?”

Most Preferred Control Modes	
E	I could make dynamic movements.
E	Easiest to learn. Didn't get confused, steps easy to plan.
E	Being able to control both without switching and having separate controls.
B	Very fluid with having auto level by default, and having the ability for precision when needed.
C	Tactile way of telling me which mode I'm in.
E	Had all control. No extra thinking about switching.

TABLE 3.4: User responses to the question “What about your #5 choice made it your least favourite?”

Least Preferred Control Modes	
D	Clunky to have fixed by default given having auto level simplifies majority of task, very awkward to push in joystick while moving in two directions (up/down and left/right).
A	Too easy to forget which mode I'm in.
B	Took a lot of effort to learn. Often mis-pressed. Mapping between stick and buttons.
D	Memorization. Not adaptable to other tasks or distraction.
D	Pouring is difficult, non-intuitive, hard to hold button at same time as moving.
C	Holding the button while performing the action is non-intuitive.

Mode E scores and ranks the highest for each qualitative measure. Modes A and B never show significant difference from mode E. Among self-adjusting modes there is no significant difference, but trends indicate modes A and B score somewhat higher than modes C and D.

In the user responses regarding their most preferred mode, common themes involved users having more control, enjoying the lack of switching, being able to make fluid, dynamic movements. One user, who favoured mode C, enjoyed having the held button press as a tactile indicator of which function the mode was controlling. Regarding their least preferred mode, three of six participants cited disliking holding the button down. Another common theme was that these modes were non-intuitive or hard to learn. One user, who disliked mode A, cited not being able to tell which function was being controlled as the cause for distaste.

3.4 Discussion

In this study we aim to determine an appropriate method of interfacing with a prosthetic arm that employs a self-adjusting wrist. A further goal of the study is to provide initial evidence regarding self-adjusting wrist performance compared to conventional control to motivate further investigations. Comparison of both quantitative and qualitative measures will elucidate what sort of control interface may be most effective to move forward with for future development.

3.4.1 Quantitative Measures

These observations suggest that, for these participants in this test setup, any of the self-adjusting modes perform as well as or better than the conventional control scheme. This preliminary comparison provides evidence that further investigation comparing a self-adjusting wrist to conventional control will be a worthwhile endeavour. Of the self-adjusting modes, mode E performs the best overall. Modes A and B perform the next best, with a slight edge in favour of mode B; modes C and D perform the least well. The quantitative performance trends suggest that, among the self-adjusting modes, *performance improves with ease of switching*: mode E required no switching, modes A and B required a momentary button press, and modes C and D required a held button press. This observation aligns well with prior findings in adaptive and autonomous switching [13], [14].

3.4.2 Qualitative Measures

These qualitative measures strongly favour mode E over the other schemes, and in general show a preference for more readily available control (i.e. favouring no switching to switching, and momentary button presses to held buttons).

3.4.3 Study Limitations

Employing a desk-mounted arm with 1 DOF at the wrist limits generalization of these results to a wearable system, which will need at least 2 DOF at the wrist. Use of the video-game controller

for this study rather than EMG creates some complications for application of these results to an EMG system. Notably mode E, which required use of two separate joystick inputs, will require more EMG input channels than may be available in a typical myoelectric control setup. A control method similar to mode E may become feasible with a pattern-recognition setup. Modes C and D would require the introduction of an alternate switching signal to facilitate held button-presses.

While restricting rotation greatly simplifies the implementation of the self-adjusting wrist, it does limit the movement of the wrist to 1 DOF, and forces the participant to use a somewhat unnatural strategy to pour the beads from the cup using ulnar deviation (the more natural strategy being to use wrist rotation). This limitation however, is common to all control modes and so will not bias the results in favour of any particular mode, though it may limit generalization of the results to tasks involving rotation.

Since the control condition was tested a month after the initial experiment, care must be taken in drawing conclusions comparing the control condition to the other modes. This study provides evidence that a future study comparing conventional control to a self-adjusting wrist should produce interesting results, but makes no specific claims at this time.

3.4.4 Recommendations and Future Work

For application of these results to a wearable system with EMG control, two constraints must be held in mind:

1. a wearable system will have more range of movement than the desktop-mounted system, and so will require at least two DOF to successfully implement a self-adjusting wrist, and
2. use of an EMG system, in order to not occupy otherwise useful muscle sites, will likely be restricted to two channels of input only.

Constraint (1) will make direct control of the wrist more difficult, likely involving sequential control of each individual degree of freedom, making modes B and E less feasible. Constraint (2) will prohibit the use of mode E entirely. *We therefore recommend use of modes B or A for the implementation*

of a self-adjusting wrist into a wearable, EMG controlled prosthetic system. Due to the limitations of the present study, re-visitation of a usability study to evaluate possible control schemes in the wearable system is also recommended, particularly comparing direct control and fixed wrist functions as the secondary function. Further, we recommend including some means of giving feedback to the user (e.g. LED indicator) regarding what function the controller is currently performing (i.e. fixed-wrist or self-adjusting wrist).

Future work will involve the development of a wearable 2-DOF self-adjusting wrist for use with able-bodied participants via a bypass prosthesis simulator. Since elbow angle will no longer be a reliable indicator of hand position relative to ground, an inertial measurement unit must be implemented in the terminal device, and PID control will be used to maintain the hand's orientation. A rigorous study to compare the self-adjusting wrist to conventional control will be performed using motion-capture technology to evaluate effects of the control system on users' compensatory movements. More broadly, this work could be extended to allow fixing the terminal device to reference frames other than the forearm or ground reference frames, given appropriate sensors either on the arm or in the environment, as demonstrated by Shibuya et al. [38]. By selectively attaching to the reference frames of target objects, slanted surfaces, or other useful frames, a self-adjusting wrist could provide even greater benefits for task performance and reduction of compensatory movements. To generalize the system to environments not prepared with appropriate RFID tags, the control system would likely require implementation of machine learning approaches to determine which reference frame might be most appropriate for a particular context. Machine learning could also be used to allow the system to determine an appropriate time to switch between self-adjusting and other functionality (i.e. direct control or fixed-to-forearm). Such adaptive and autonomous switching schemes have been explored for application to conventional myoelectric control [13], [14], and could be applied to a self-adjusting scheme as well.

3.5 Conclusion

We contribute the first control interface evaluation for an automatically and continually adjusting wrist that aligns to a frame of reference other than that of the forearm. This work provides evidence that a self-adjusting wrist control system capable of maintaining the terminal device orientation relative to the ground reference frame may perform better than conventional control methods. It further shows that the control interface may have significant implications on the system's success. Future investigation with self-adjusting wrists should include a rigorous comparison of self-adjusting wrist control to conventional control, with measures that show effects on compensatory movements. Our results suggest that a control scheme that employs a momentary switch to toggle wrist function between a fixed-to-ground reference frame and either a fixed-to-forearm reference frame or direct wrist control would be a good first candidate for this future study. Extension of this self-adjusting concept to reference frames other than the ground reference frame may also be useful and warrants future investigation. This study represents a step toward prostheses capable of intelligently adapting themselves to their environment in a natural, intuitive way in order to provide a user with a safer and more easily usable robotic arm.

Chapter 4

System Design

A wrist capable of maintaining terminal device orientation relative to the ground during practical tasks requires two degrees of freedom: rotation and flexion. In this chapter, I describe the technical details of the automatically levelling wrist. The first section illustrates the autolevelling method as could be applied to any prosthetic system; the second section characterizes the particular implementation with the Bento Arm [25] mounted as a bypass prosthesis on able-bodied persons.

4.1 Automatic Levelling Method

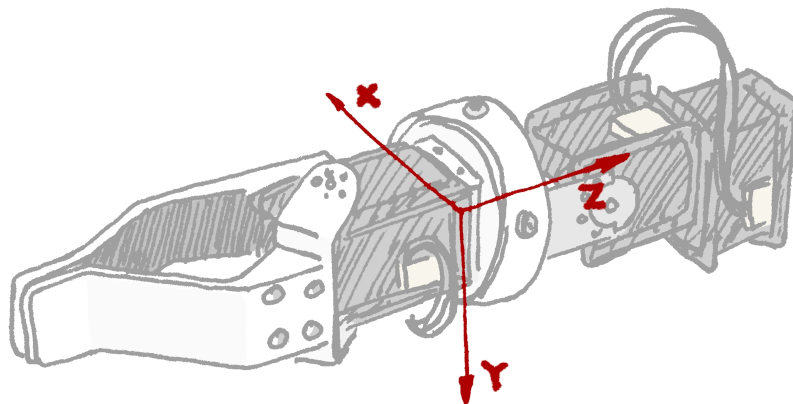

FIGURE 4.1: Definition of the axes of the Bento Arm terminal device. The axes are defined such that they coincide with the axes of the IMU in the base of the gripper.

A number of definitions are required at the outset to ensure proper understanding of this description of the autolevelling method.

Axes - The axes of the terminal device are defined so that when held horizontally, the y-axis points downward, the x-axis points to the right, and the z-axis extends toward the body in line with the forearm, as shown in Fig. 4.1. This definition is based on the way that the inertial measurement unit (IMU) is mounted in the base of the hand. Further, it allows rotation and flexion to be defined based on a single axis each: flexion around the x-axis, and rotation about the z-axis.

Gravity Vector (GV) - The vector returned by the IMU in terms of (x,y,z) components, that always points toward the centre of the earth. The vector is returned in units of m/s^2 .

Automatic Levelling - The term “automatic levelling” (often abbreviated throughout as “autolevelling”) implies the ability to keep an object stable relative to the ground reference frame, as would be necessary to manipulate an open cup full of liquid to avoid spilling. Automatic Levelling can be thought of as two distinct sub-functions: rotation levelling and flexion levelling.

Rotation Levelling - The function of rotation levelling is to ensure that the x-axis of the terminal device remains parallel to the floor (i.e. the x-y plane of the ground-reference frame).

Flexion Levelling - Flexion levelling is not a true levelling function in the sense that would make the z-axis parallel to the ground; rather, it determines the angle between the z-axis and the ground and maintains that value. This is so that true levelling of the held object may be accomplished regardless of the angle it is originally grasped, as shown in Fig. 4.2. The term “flexion levelling” will be used to refer to the process of keeping this angle constant.

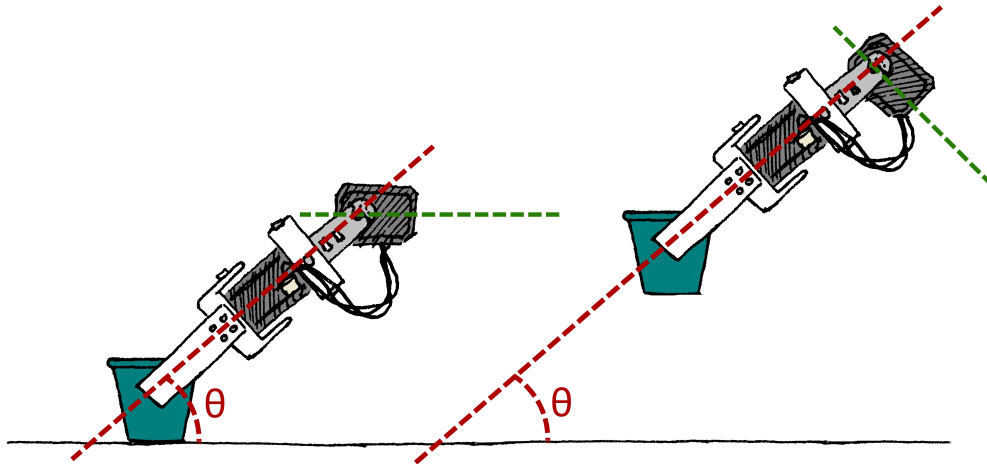

FIGURE 4.2: The flexion levelling method maintains the angle between the terminal device and the ground that existed when flexion levelling was enabled, in order to maintain the level of a held object no matter the initial grasp angle.

4.1.1 Theoretical Automatic Levelling

To accomplish automatic levelling, only two DOF are required at the wrist, to manage rotations of the terminal device about the x and z axes. Rotations about the y axis are inconsequential to levelling; spills won't occur if a cup turns only about its vertical axis. For most tasks of daily living, especially those commonly evaluated as outcome metrics, the ground-frame is the most useful plane to consider for an automatically levelling scheme, and is the reference frame explored here.

4.1.2 Practical Automatic Levelling

Angle-Finding Method

The IMU returns the gravity vector in terms of m/s^2 in each of the x , y , and z directions. For example, if the terminal device is held perfectly horizontal, the returned vector would read (x,y,z) : $(0,9.8,0)$. The IMU filters out the gravitational acceleration from movement accelerations of the IMU using the Adafruit Unified Sensor System driver, so the magnitude of the gravity vector will

always be approximately 9.8 m/s^2 . In practice, it was found that the average magnitude of the gravity vector was 9.8004 m/s^2 with a standard deviation of 0.0033 m/s^2 .

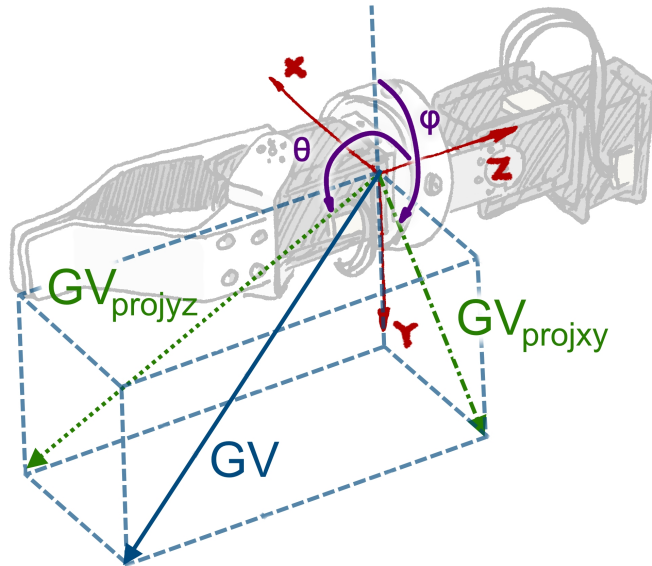

FIGURE 4.3: The angles ϕ and θ are defined as shown in this diagram, and can be calculated using the projections of the gravity vector GV on the x - y and y - z planes, respectively.

The current rotation of the terminal device can be determined by finding the angle between GV_{projxy} and the negative y -axis. The formula governing this definition, and used to determine rotation angles is:

$$\phi = \begin{cases} \arctan\left(\frac{g_x}{g_y}\right) & g_y < 0, g_x \leq 0 \\ \arctan\left(\frac{g_x}{g_y}\right) + 360 & g_y < 0, g_x > 0 \\ 90 & g_y = 0, g_x < 0 \\ 270 & g_y = 0, g_x > 0 \\ \arctan\left(\frac{g_x}{g_y}\right) + 180 & g_y > 0 \end{cases} \quad (4.1)$$

Similarly, the current amount of wrist flexion can be found using the projection of GV on the z-y plane. The equation for flexion angle theta is:

$$\theta = \begin{cases} \arctan\left(\frac{g_y}{g_z}\right) + 90 & g_z < 0, \\ 0 & g_y = 0, g_y < 0 \\ 180 & g_y = 0, g_y > 0 \\ \arctan\left(\frac{g_y}{g_z}\right) + 270 & g_y > 0 \end{cases} \quad (4.2)$$

The angles ϕ and θ are defined in Fig. 4.3. ϕ is measured from the positive y-axis counter-clockwise around the positive z-axis; θ is measured from the positive z-axis, clockwise around the positive x-axis. Angles are defined in this way so that the angle definition will reach the $0^\circ/360^\circ$ flipping point when the terminal device is completely upside down—a configuration that should only occur rarely if ever during normal use of the prosthesis.

PID Control

Proportional-Integral-Derivative (PID) control was chosen for this application since it is a well understood and commonly used feedback control method, which is easy to implement [47]. A cursory explanation of PID theory is given here to allow a basic understanding for those unfamiliar with the method, and as a quick refresher for those who have already studied it.

PID control is a simple feedback loop that continuously measures the difference between a measured value and its desired setpoint. This difference is called the error $e(t)$, and is fed back through the loop to apply a correction using the proportional (P), integral (I), and derivative (D) terms. The PID loops for both the flexion levelling and rotation levelling are depicted in the flowcharts of Fig. 4.4. The output correction of the system is governed by Eq. 4.3.

$$u(t) = K_p e(t) + K_i \int_0^t e(t') dt' + K_d \frac{de(t)}{dt} \quad (4.3)$$

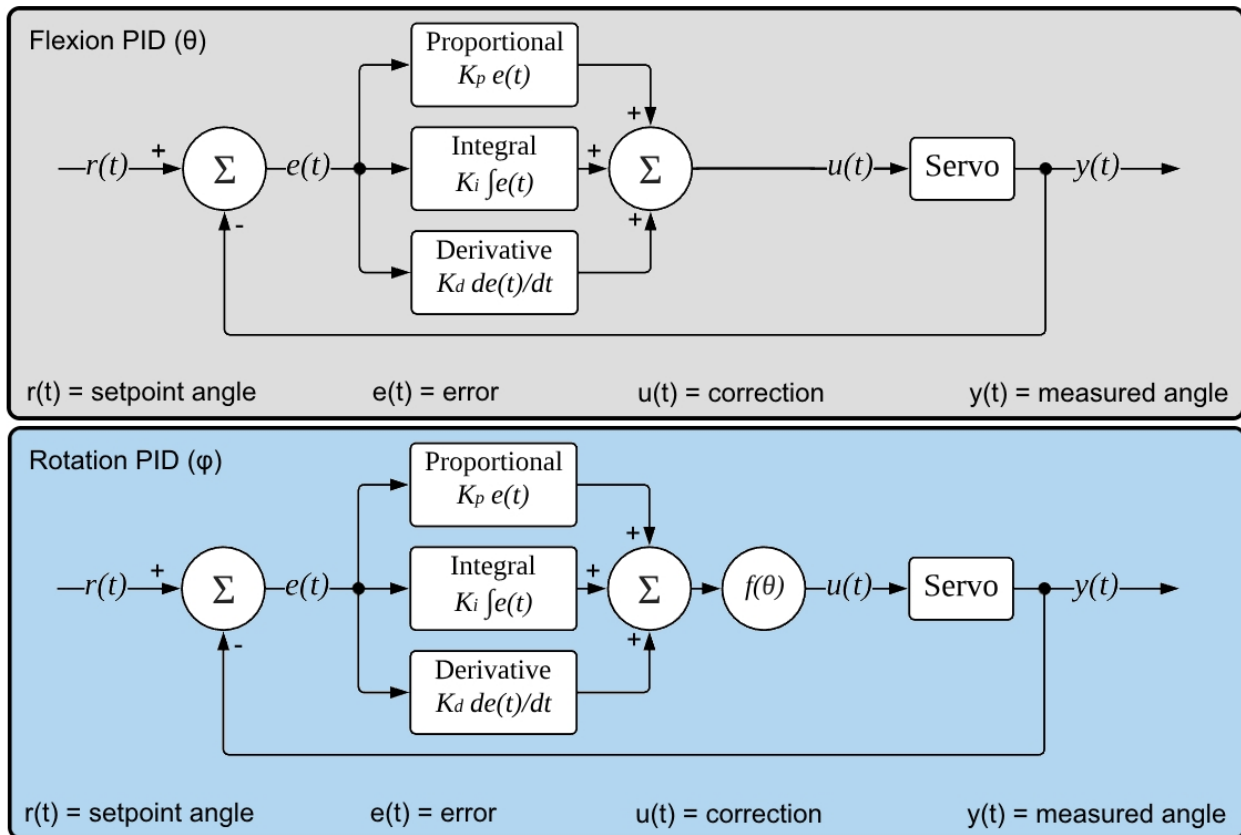

FIGURE 4.4: The PID loops of the rotation and flexion levelling systems are identical to the basic PID loop, with the exception of the addition of the ramping function $f(\theta)$ in the rotation levelling PID loop.

The proportional term applies a correction that is proportional to the error; the larger the difference between the measured value and the desired setpoint, the greater the correction will be. The integral term looks at the error over time, and applies a correction to eliminate accumulating error over time. In this way, it brings the steady-state error to zero. The derivative term is an estimate of the future error based on the current rate of change. It applies a correction to reduce future errors.

A PID controller must be tuned to provide appropriate behaviour for the situation. Increasing K_p provides benefits in terms of response time, but has the downside of introducing overshoots and oscillation. A P controller, without I or D terms, will also have a non-zero steady-state error. Introducing and increasing K_i reduces steady-state error, but can also cause overshoot and oscillation. Increasing K_d reduces oscillation and overshoot, but also reduces response time.

Other Controllers

It would be possible to use control algorithms other than PID to automatically level a prosthetic wrist, some of which are listed below. These were mainly rejected for this first-pass proof-of-concept due to the additional complexity in implementation, with limited benefit for our particular study. However, these methods may be able to provide more robust and smooth control, and should be considered for future developments:

- **Adaptive Control** is similar to PID control, but allows for automatic control of the parameters as the dynamics of the process change [48]. This may be useful for a wrist in a clinical or take-home setting, where the arm will be required to interact with many different kinds of objects, after undergoing much wear and use, and in different environmental conditions. These adaptations are less necessary in a controlled laboratory setting.
- **Model Predictive Control** requires an explicit model of the process being controlled, but allows prediction of the process output in the future [49]. Reliable predictions can provide robustness to the controller, ensuring the output of the system is stable. However, the strength

of the predictions for a Model Predictive Control system is in long-term, slow systems such as chemical processes. For an automatically levelling wrist fast, dynamic control is necessary.

- **Intelligent Control** approaches such as fuzzy logic, artificial neural networks, and reinforcement learning allow good performance under significant uncertainty in the system, and can perform well under a variety of conditions [50]. This ability to provide control in a wide array of situations is ideal for control of prostheses since use cases are rarely well-defined. However, these control systems are not ideal for a proof-of-concept study as intended here because of their complexity in implementation.

4.1.3 PID in the Autolevelling System

Both rotation levelling and flexion levelling are controlled by PID loops, each separate with their own parameters (see Fig. 4.4). For each PID loop, the measured value is the angle of interest (theta or phi), and the setpoint is the desired angle. Theta and phi are measured in degrees, and calculated as defined in 4.1.2. For this application, a manual tuning method was used. The rotation PID parameters were determined first while holding the flexion servo fixed. Once these parameters were tuned, the flexion PID parameters were tuned while rotation levelling was enabled. For both PID loops the parameters were tuned on a trial-and-error basis to achieve reasonable speed with little overshoot and oscillation. These parameters have not been optimized, but perform well enough to provide reasonable function. For rotation, the (k_p, k_i, k_d) values were $(0.32, 0.06 \mu\text{s}^{-1}, 8.79 \text{ ms})$; for flexion they were $(0.29, 0.42 \mu\text{s}^{-1}, 8.00 \text{ ms})$.

Mitigating Rotation Error at Vertical Positions

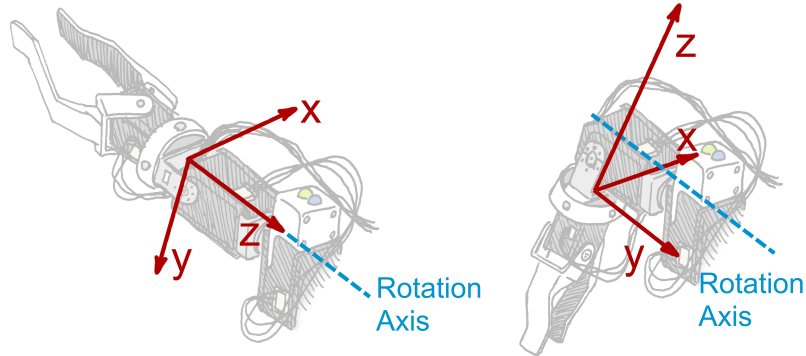

FIGURE 4.5: When the flexion angle θ deviates from 180° , the z axis of the IMU and hand no longer lines up with the rotation servo's axis. The rotation servo can still influence the x and y components of the gravity vector up until $\theta = 90^\circ$ or $\theta = 270^\circ$, but not as directly.

Because the IMU is mounted distal to the flexion servo, and the flexion servo is distal to the rotation servo, flexion movements bring the z-axis of the IMU out of coincidence with the rotation axis of the rotation servo, as shown in Fig. 4.5. This problem is most evident at full flexion, when the axes are at 90 degrees to each other. The rotation levelling still works to some degree up to this point since rotations do still affect the x and y components of the gravity vector as intended, though to a lesser degree as flexion angle increases. This can lead to unintended movements since the PID is tuned for a more central position. To mitigate this problem, the rotation PID constants are multiplied by the ramping function in Eq. 4.4.

$$f(\theta) = \frac{90 - |180 - \theta|}{90} \quad (4.4)$$

The rotation PID equation then becomes that of 4.5.

$$u(t) = f(\theta) \left(K_p e(t) + K_i \int_0^t e(t') dt' + K_d \frac{de(t)}{dt} \right) \quad (4.5)$$

In the horizontal position, the PID constants are the same as originally tuned; at the vertical position the constants are zero. Past vertical, the constants are also zero. The flexion PID remains unaltered, as in Eq. 4.3. A more sophisticated method for decoupling the PID loops should be implemented in a future design to improve the robustness of the algorithm. The solution implemented here is a quick, practical fix, and works well enough to avoid most unintended movements in practice.

Integration to Sequential Switching

The previous work (Chapter 3) suggested that the most intuitive means of enabling automatic levelling would be through the use of a momentary switch, such as a co-contracting EMG signal. Implementation of autolevelling to existing sequential systems is then a natural objective, since these use momentary switching signals and are common in commercial systems. To reduce the number of switches necessary for control, rotation levelling is always enabled. Flexion levelling is enabled whenever the user is not directly controlling the flexion angle. In this way, the autolevelling wrist functions with exactly the same number of items in the switching list as conventional systems, and does not add any control complexity.

Since in the transradial case there is only wrist and hand function to control, the sequential switching method essentially devolves to toggling between hand and wrist flexion functions. When controlling the hand, the wrist automatically levels. A flowchart depicting the sequential switching is given in Fig. 4.6.

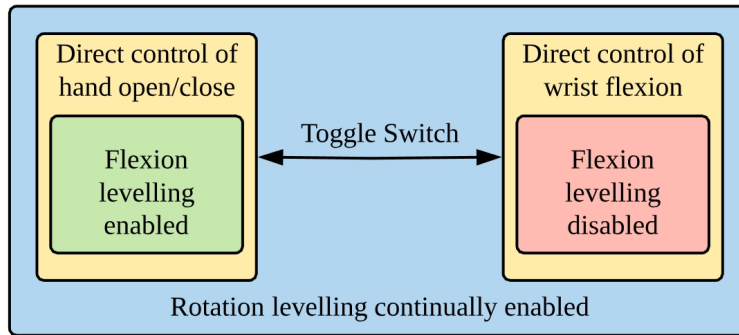

FIGURE 4.6: A switching signal toggles between hand and wrist flexion control. When using hand control, the wrist flexion autolevels.

The user has access to the wrist angle θ by means of either direct control (via myoelectric control) or fixed wrist (altering the angle using the biological elbow and shoulder while in wrist control mode). This amounts to essentially the combination of modes A and B in the previous study, which performed equally well. The user may choose to use direct control or fixed wrist depending on their preference or the demands of the situation.

4.2 Autolevelling Implementation with Wearable Bypass Prosthesis

Recruiting able-bodied participants prior to trials with participants affected by amputation is desirable to achieve high statistical power in a time-efficient way. To test with able-bodied participants, the autolevelling wrist must be attached to the user's body in a manner analogous to the way it would be mounted to the residual portion of an amputated arm. In addition, the user's biological hand and wrist motion must be restricted where possible.

4.2.1 Hardware

The bypass prosthesis itself consists of two main components: a wrist splint, and the Bento Arm, as shown in Fig. 4.7. The wrist splint covers only the distal portion of the user's forearm, leaving the large muscle bellies of the proximal portion free for use with EMG. The Bento Arm is fixed to the wrist splint by means of a 3-D printed bracket that conforms to and supplements the function

of the metal braces within the fabric of the splint. The bracket is shaped like a shovel handle, and a cylinder provides a gripping location for the user's hand. The user's fingers and thumb are free; the thumb can be used to control a joystick mounted in the grip cylinder. Mounted to the rotation servo of the arm are two LED indicators, blue and green, used for control feedback to the user indicating what function they are currently controlling. The bypass prosthesis makes use of the distal portion of the Bento Arm, including the wrist rotation and flexion servos as well as the chopsticks gripper. The servos are mounted such that flexion occurs more distally than rotation.

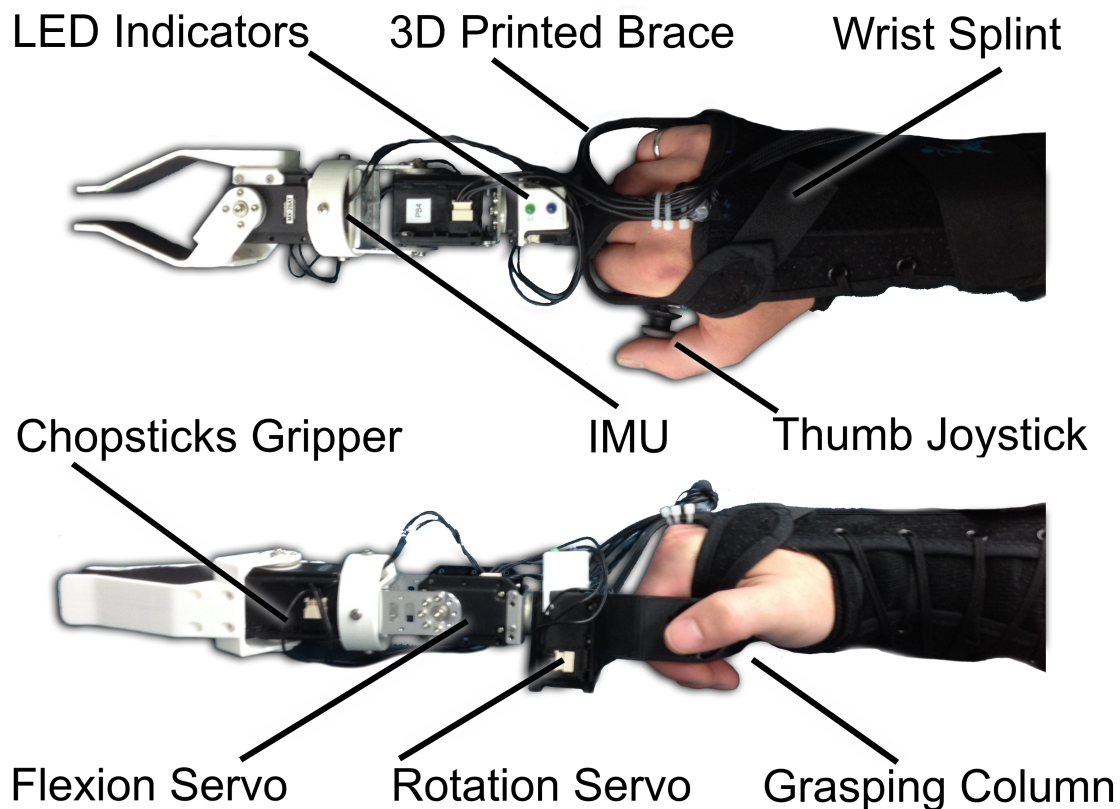

FIGURE 4.7: The bypass prosthesis consists of the distal portion of the Bento Arm attached to a wrist splint.

Prosthesis Location

The Bento Arm is located in line with the forearm, distal to the user's biological hand. It is important that the arm be distal to the user's biological arm to ensure that the wrist does not contact the user's arm. This helps to ensure user safety, and is also necessary for autolevelling function at the full extent of the reach.

Joint Limits

To prevent entanglement of the wires, and to prevent the TD from colliding with itself, software limits are placed on the position of each joint. The maximum angles are set such that the prosthesis is able to maintain a terminal device orientation of $\theta = 270^\circ$ and $\phi = 180^\circ$ (neutral position) even at the extreme ranges of motion (maximum pronation/supination, maximum arm raise and drop).

The servos stop upon reaching these limits. Outside the joint limits, the integral portion of the PID is not incremented to avoid windup. These joint limits match the maximum natural range of motion of a user's arm with the bypass prosthesis, allowing autolevelling at full pronation and supination, as well as at full reach in vertical and downward positions.

Control and Usability

The bypass prosthesis can be controlled by either a thumb joystick [51] built into the cylinder grip or by myoelectric control. EMG signals from a Myo Armband (Thalmic Labs) were converted to mean absolute values with a window size of 40 steps (approximately 200 ms), in accordance with standard myoelectric control paradigms [12].

The prosthesis was designed such that it should be comfortable to use by both the 1st percentile adult female and the 99th percentile adult male [52], to allow a large, unbiased sample group. These sizing provisions included the length of the wiring from the belt to the arm and from the bicep to the prosthesis, the allowable circumference of all strapping, the size of the handle grip, and an interchangeable joystick length.

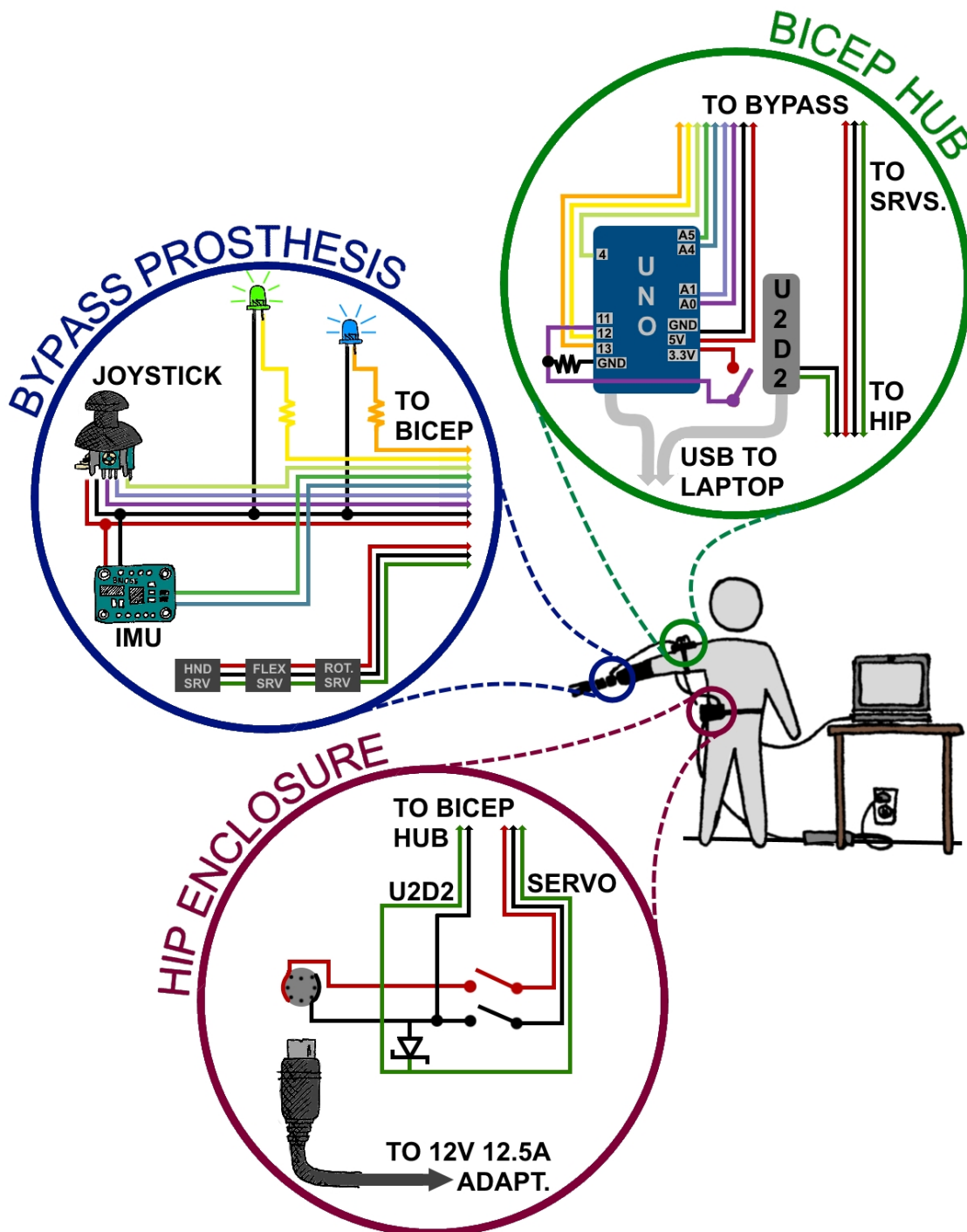

FIGURE 4.8: Schematic showing the wiring for the entire system, broken down into the three system components: the hip enclosure which serves as power switch; the bicep hub which houses the Arduino Uno and U2D2; and the bypass prosthesis itself instrumented with sensors, controls, and feedback LEDs.

Data Specifications

IMU - The IMU used in this setup is the BNO055 from Adafruit [53]. This 32 bit sensor outputs the gravity vector at a rate of 100 Hz with a rated sensitivity of 0.0098 m/s^2 per LSB.

Arduino - An Arduino (Uno, Rev3) prints IMU and joystick data to serial at a baud rate of 9600. The brachI/Oplexus software running the Bento Arm reads in this data once per cycle; the typical cycle time during operation is between 2 and 4 ms.

PID - The PID loop measures the error and updates the servo control position once per cycle (again between 2 and 4 ms).

Myo Armband - The EMG data is sampled from the Myo Armband at a rate of 200 Hz.

4.2.2 Wiring

The complete wiring schematic is shown in Figure 4.8, with a detailed breakdown of the three main system components.

Hip Enclosure - The hip enclosure serves as the main power switch for the prosthesis. It is mounted on the hip rather than the bicep for two reasons: the excessive weight of the power cable would quickly introduce fatigue if mounted on the arm, and the hip-mounted switch is more accessible to the user in case emergency shut-off is required. When switched off, power and ground lines are disconnected from both the U2D2 (Robotis, 902-0132-000) and the servos, meaning that the servos lose power and the U2D2 can no longer communicate with the computer. A diode is included between the ground line and U2D2 signal line to prevent voltage spikes from damaging the U2D2.

Bicep Hub - The Arduino and U2D2 are mounted on the user's bicep to reduce the length of wires from the bypass prosthesis while minimizing the weight on distal portions of the arm. The Arduino connects to and coordinates the signals from the IMU and the thumb joystick, and to the feedback LEDs. A button mounted on the bicep enclosure can be used to flip which LED is illuminated in order to synchronize the lighting sequence with the actual joint being controlled in the

sequential switching list of brachI/Oplexus. Power, ground, and signal wires from the hip enclosure pass directly on to the servos after routing through the bicep enclosure for cable management purposes.

Bypass Prosthesis - The Dynamixel servos are daisy-chained together in the same fashion as the typical Bento Arm setup. Ground connections for all components are soldered together as distally as possible to reduce the overall wire-weight necessary in the system. Power wires for the joystick and IMU are similarly soldered together.

The proximal mounting of the hip enclosure and bicep hub eliminates approximately 300 g from the bypass prosthesis.

4.2.3 Device Limitations

PID - The PID controller used in this bypass prosthesis works well enough to provide reasonable function, but is by no means the optimal controller. The PID gains have not been optimized, and have only been tuned for the level case. The ramping function 4.4 represents a patch fix on a more fundamental problem: the rotation servo's influence on the z-axis rotation depends on the flexion angle θ . More sophisticated techniques may be able to address this problem more satisfactorily, including addition of a secondary IMU mounted on the forearm to provide a comparative reference frame. Future studies may wish to re-evaluate the method of autolevelling; this study simply aims to provide evidence of its utility.

Wrist Rotations - The bypass does not restrict wrist rotations, since wrist rotation in a biological arm is accomplished by the crossing-over of the radius and ulna of the forearm. This means that users can rotate their wrist while using this device without affecting the object orientation since the rotation servo is autolevelling. This will have implications in the interpretation of motion-capture data.

Device Length Since the arm must be mounted distally to the user's hand, the overall arm length is approximately 26 cm longer than the person's natural arm. The user's movements must

compensate for the extra length. Having the device weight more distally also induces higher torques at the person's shoulder, inducing fatigue sooner than a shorter arm would do.

Handedness - Currently, the device is only designed for use with right-handed persons. Modification for left-handed use would require a different wrist splint, and re-printing of a mirrored bracket, but the rest of the assembly would be identical.

4.3 Conclusion

In summary of the above work, a functioning simulated prosthesis capable of autolevelling was constructed from an existing myoelectric arm, wrist splint, and absolute orientation sensor. Control of the device is accomplished with simple PID control which is a method that is thoroughly understood and widely used in control engineering. Further, a single absolute orientation sensor is the only additional sensor required for the device; these sensors are also relatively inexpensive and ubiquitous. The simplicity of the design ensures that integrating such a control scheme into a commercial prosthesis design should be relatively easy and cost effective.

Chapter 5

The Effect of an Automatically Levelling Prosthesis

5.1 Study Rationale and Purpose

As stated in Chapter 2, a main motivation for the development of an automatically levelling wrist is the idea that it may help to reduce compensatory movements. The purpose of this study is to further evaluate the effect of the automatically levelling wrist developed in Chapter 4 on a person's movements and control strategies, while performing tasks of daily living. This experiment was intended to elucidate differences between the use of a fixed wrist, a sequential switching method, and the auto-levelling method proposed. Further, comparisons between each of these and the normative and affected populations are also made. Three areas of evaluation are explored: kinematic analysis, performance metrics, and qualitative perception of performance.

What follows is an adapted version of a study that will have been submitted to the 16th IEEE RAS/EMBS International Conference on Rehabilitation Robotics (ICORR 2019), June 24–28, 2019 [54].

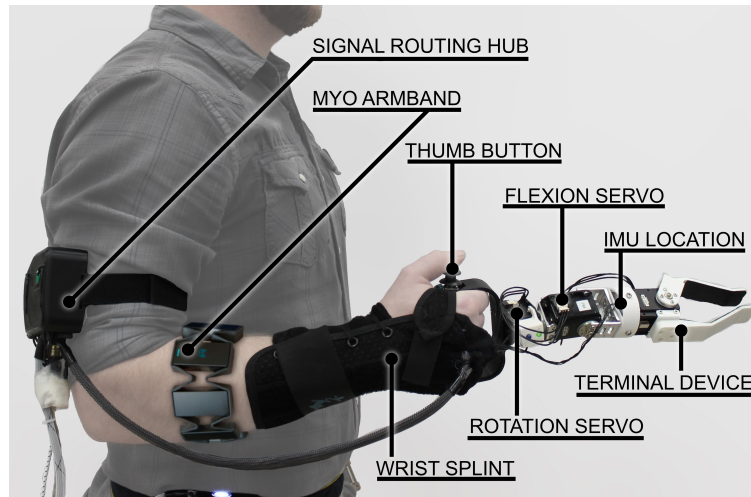

FIGURE 5.1: The simulated prosthesis included all joints of the Bento Arm distal to the elbow, and was attached to a wrist splint by a 3D printed handle. A Myo Armband allowed myoelectric control, and a button at the thumb allowed switching. Computation and power were provided externally.

5.2 Methods

5.2.1 Simulated Prosthesis

In this work, we made use of a simulated prosthesis with able-bodied subjects. The simulated prosthesis designed for use in this study consisted of a modified Bento Arm [25] attached to a wrist splint with 3D printed handle as depicted in Fig. 5.1. The arm was modified to include only wrist rotation, wrist flexion, and the terminal device, which was further altered to include a BNO055 (Adafruit Ind., New York City, NY) inertial measurement unit (IMU) in its base. Altogether the device weighed 550 g. The open-source files for the simulated prosthesis can be found online [27]. The prosthesis extended distally from the user's intact hand, resulting in an increased effective limb length of 26 cm, which was necessary to ensure unimpeded prosthesis wrist motion. The wrist splint restricted biological wrist flexion/extension and radial/ulnar (R/U) deviation of the participant, but allowed wrist rotation. The prosthesis was controlled using a Myo Armband (Thalmic Labs, Kitchener, ON) on the user's forearm. EMG signals from contraction of the user's forearm muscles corresponding to wrist flexion/extension were mapped to open/close of the hand

or radial/ulnar deviation of the wrist (up/down in this configuration) depending which joint was being controlled. EMG signals were converted to mean absolute values with a window size of 40 steps (approximately 200 ms), in accordance with standard myoelectric control paradigms [12]. A button activated by the user's thumb was used to give the switching signal. A button was used rather than myoelectric co-contraction to achieve cleaner, clearer control signals, thereby reducing inadvertent switches which would make the system more difficult to learn. Electrical power and computation of the control software were provided externally; cables were managed to be as unobtrusive as possible in terms of weight and restricted motion. The prosthesis functioned in three distinct modes: Fixed Wrist (FW), Sequential Switching (SS), and Automatically Levelling (AL). In FW mode, the prosthesis allowed hand control only; both wrist rotation and R/U deviation were fixed in a neutral position. For the sequential switching mode, the user could switch between directly controlling the terminal device or R/U deviation of the wrist; wrist rotation was fixed in a neutral position. The automatically levelling mode also allowed the user to switch between wrist R/U deviation and hand control, but the wrist also worked autonomously to maintain the hand orientation in the method described in the next section.

5.2.2 Automatic Levelling Method

The integrated IMU in the base of the terminal device enabled the AL functionality. It provided a "Gravity Vector" (GV), which consisted of the x , y , and z components of the acceleration due to gravity experienced by the IMU, filtered away from other accelerations. The gravity vector and relevant angles are depicted in Fig. 5.2. "Automatic Levelling" consisted of two separate sub-functions: "Flexion Levelling" and "Rotation Levelling". Flexion Levelling aimed to keep the angle θ constant (set to whatever angle it was when Flexion Levelling was engaged), and was active whenever AL was engaged *and* the user was *not* controlling the wrist. Rotation levelling aimed to keep the angle ϕ at a constant 180° , and was active whenever AL was engaged. Both Flexion Levelling and Rotation Levelling operated on separate PID loops, each of which updated at a minimum rate of approximately 200 Hz. The PID loops were tuned by hand to give reasonable

settling times; rotation settled to within $\pm 5^\circ$ error from an 80° disturbance within about 600 ms; flexion settled to within $\pm 5^\circ$ error from a 50° disturbance within about 580 ms. For rotation, the (k_p, k_i, k_d) values were (0.32, 0.06, 8.79); for flexion they were (0.29, 0.42, 8.00).

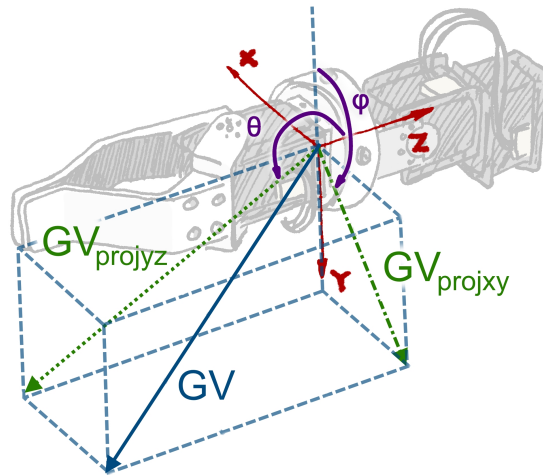

FIGURE 5.2: The IMU provided the Gravity Vector (GV), from which the angles ϕ and θ were calculated, using the projections of GV on the x-y and z-y planes. Flexion Levelling kept the angle θ constant; Rotation levelling kept the angle $\phi = 180^\circ$.

5.2.3 Experiment Design

Twelve able-bodied people participated in the study, each providing written informed consent prior to participating. The demographics of the population studied are given in Table 5.1. All participants were right-handed, with normal or corrected-to-normal vision, and performed the task using their right hand.

TABLE 5.1: Population demographics of all participants in the study

	Age (yrs)	Weight (kg)	Height (cm)	Sex
Average	25.3	73.2	170.7	3F, 9M
Standard Dev.	7.5	7.4	10.0	

Our outcome measures were based on the study conducted by Valevicius et al. [29], which involved two tasks: the Cup Transfer task, and the Pasta-Box task. The Cup Transfer Task involved moving two cups full of beads across the mid-line, using the prosthesis in first a top-grasp and then a side-grasp, and returning the cups to the starting position using the same method. The Pasta-Box task involved transferring a box of pasta from a low side table to a series of higher shelves, and finally returning the pasta box to the side table. Both of these tasks used a Vicon Bonita 12-camera motion-capture setup to record upper body joint angular kinematics in 20 non-disabled participants. Ten data sets from prosthesis users using a range of prosthesis types (transradial and transumeral, body-powered and myoelectric) were also recorded and are used as comparators in this study. For a full description of the experiment setup and task descriptions, refer to Valevicius et al. [29]. For this experiment, the setup was modified from this original work in two ways:

1. The side table was moved 26 cm to the right and 26 cm back, to accommodate for the additional length of the simulated prosthesis. Participants were instructed to stand at a comfortable distance to the task table while performing the task with the simulated prosthesis.
2. The cups used were made of stiff plastic rather than compliant paper, since the emphasis in this study was on wrist control conditions rather than force modulation control.

Marker positioning was consistent with the cluster-based marker model used in Boser et al. [31]; markers for the right hand and forearm were mounted on the simulated prosthesis in analogous locations.

Participants were first familiarized with the prosthesis by allowing approximately five minutes of unstructured play, wherein they could stack cups, balls, and various other small objects. For the first few minutes of this time, or until the participant felt comfortable with the system, the prosthesis was operated in the SS mode. For the last few minutes of the training session, the participant was familiarized with the AL mode. Only once the participant agreed that they felt sufficiently capable did the experiment trials begin.

Each participant performed three blocks of trials (one block each for FW, SS, and AL) for each task. The order that the interventions were tested by the participant was randomized, but each of the six possible orders was tested twice over the twelve-participant population. Everyone began with the Cup Transfer task, and after completing all Cup Transfer trials took a ten-minute break before conducting the Pasta-Box trials. For each task type, the experimenter explained and demonstrated the format of the task, and the participant performed one or more practice trials until they felt comfortable with the task. A practice trial was also allowed at the beginning of each block of trials to familiarize the user with that particular control mode. A block consisted of enough trials to represent ten usable trials, with a maximum of fifteen attempts. All participants had at least nine usable trials for each block. Reasons for mistrials were recorded, and only mistrials caused by participant error (incorrect task execution, spilled or dropped items) are reported.

Data collected included x , y , z marker position, EMG signals, IMU gravity vector components (x,y,z), switching signals, and position, velocity, and load data from the prosthesis servomotors. Motion-capture data (8-camera OptiTrack) were collected at a rate of 120 Hz, while all other data were collected at approximately 200 Hz. No time-series analyses were conducted in this work, so the data rate disparity is inconsequential. Participants also filled out a qualitative survey at the end of the session. The survey prompted participants to score each of the control modes in four categories (intuitiveness, effectiveness at the Cup Transfer task, effectiveness at the Pasta-Box task, and reliability) using a visual analogue scale (VAS) from 0 to 5. Intuitiveness was probed by asking “How easy was each control mode to learn?”; effectiveness was determined by the question “How well did each control mode perform the cup transfer task?”, or “pasta task” as appropriate; and reliability was discerned through asking “How often did you find the arm moved in a different way than you wanted or expected?”. The participants also indicated an ordinal rank of their preference to use each control mode for each task.

5.2.4 Data Analysis

Mean maximum angles for trunk flexion/extension, trunk ipsi/contra-lateral bend, trunk axial rotation, shoulder flexion/extension, shoulder internal/external rotation, and shoulder ad/abduction were explored in this study. Shoulder and trunk angle metrics were drawn from the motion-capture data. The pelvis, thorax, and right-upper-arm motion tracking data was manually cleaned to ensure trunk and shoulder angle metrics would not be affected by occluded or mislabelled markers. Hand data, while not included in this analysis, was also cleaned since hand velocity was used as an indicator for trial beginnings and endings. The maximum angle for each degree of freedom was averaged across trials for each participant. Performance metrics included the time of task completion, the number of switching signals given by the participant, and the number of participant-caused mistrials. Mean differences for all continuous data (mean maximum angles, time of trial completion, switch counts, mistrial counts, and VAS scores) were calculated using paired two-sample t-tests with $\alpha = 0.05$. A Bonferroni correction was made for three comparisons, making $\alpha = 0.0167$. For the ordinal preference ranking, a Mann-Whitney U-test was conducted, with $\alpha = 0.05$.

5.3 Results

The mean maximum angle for each trunk and shoulder movement is plotted on a per-participant basis for the Cup Transfer task in Figs. 5.3 and 5.4, and for the Pasta-Box task in Figs. 5.5 and 5.6. The total range of motion can be inferred by considering both pairs of angles for a degree of freedom (i.e. max flexion + max extension = range of motion). The data for the normative (N) and prosthesis-user (P) populations of studies [29], [32] are plotted as well. While not directly comparable to our results with a simulated prosthesis, the data from these studies are provided alongside our results to indicate that the tests show differences between normative and prosthesis-user populations, and that our results are within reasonable expectations. The points for individual participants are connected by lines to show trends across the interventions tested in this study.

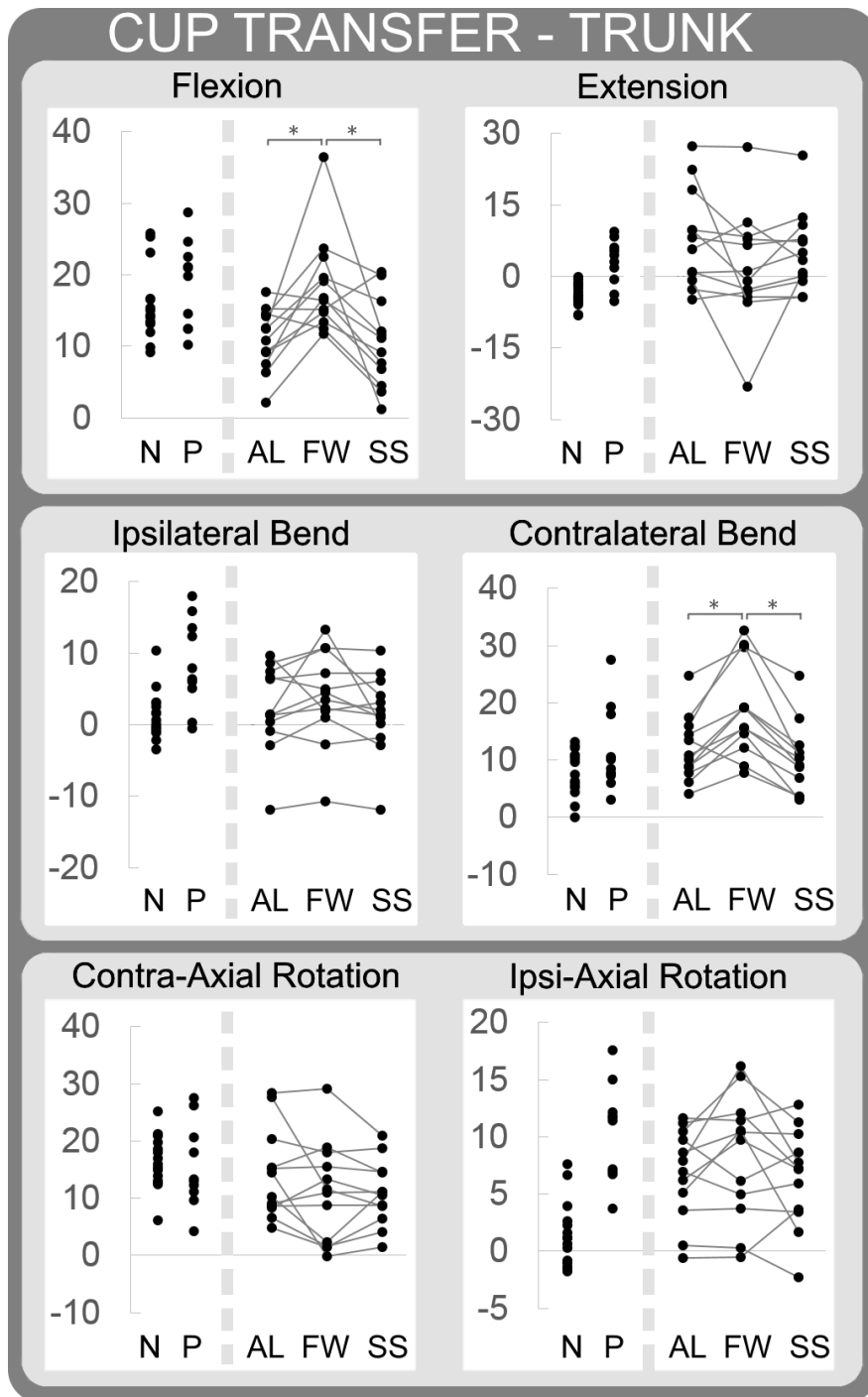

FIGURE 5.3: CUP TRANSFER TASK, TRUNK KINEMATICS: Mean maximum angles (deg) for each participant, for fixed-wrist (FW), sequential-switching (SS), and automatically levelling (AL) conditions. Normative (N) and prosthetic (P) data was collected separately [29], [32]. Significance was determined based on the average of the group using pairwise two-sample t-tests, $\alpha = 0.0167$ for Bonferroni correction.

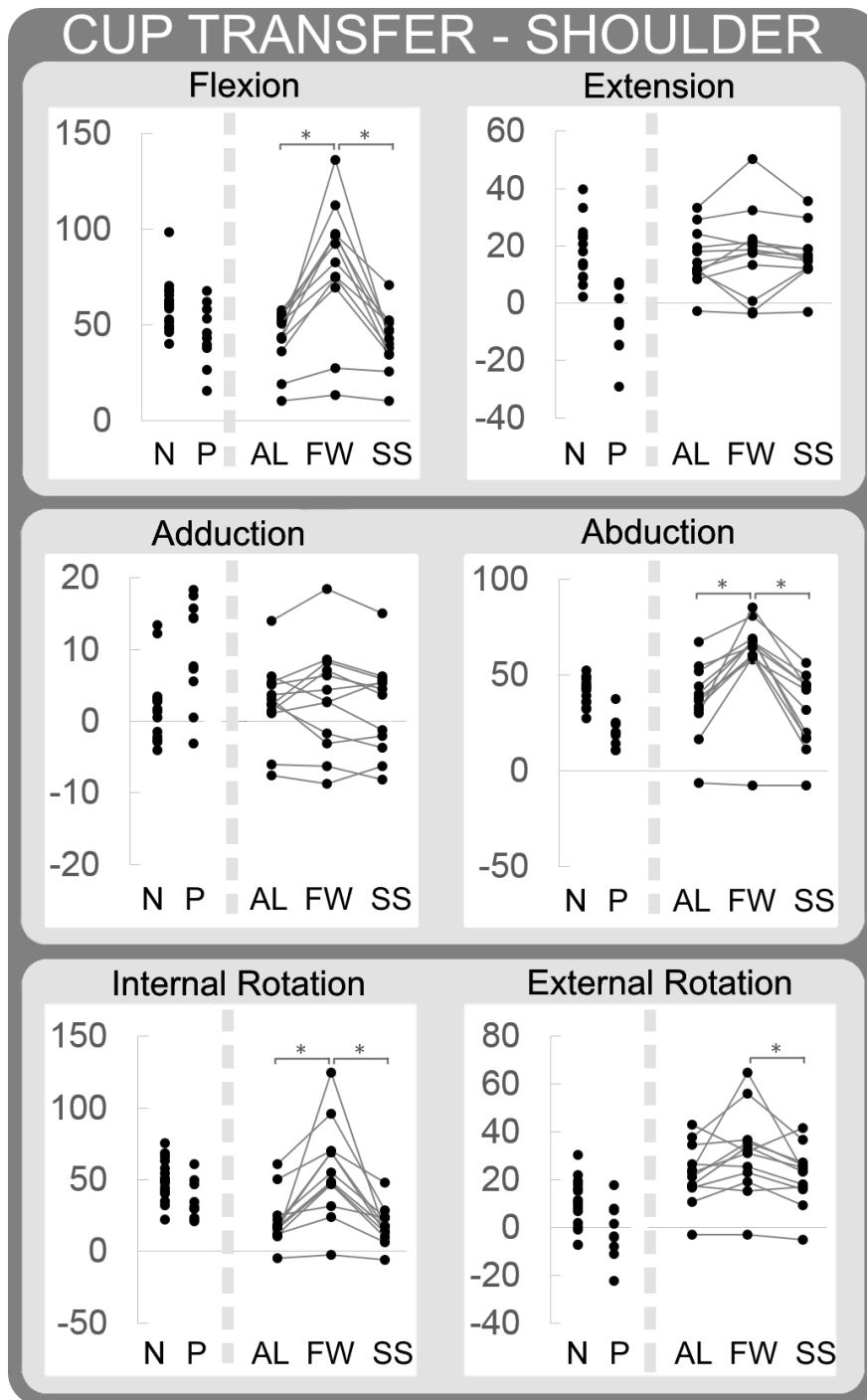

FIGURE 5.4: CUP TRANSFER TASK, SHOULDER KINEMATICS: Mean maximum angles (deg) for each participant, for fixed-wrist (FW), sequential-switching (SS), and automatically levelling (AL) conditions. Normative (N) and prosthetic (P) data was collected separately [29], [32]. Significance was determined based on the average of the group using pairwise two-sample t-tests, $\alpha = 0.0167$ for Bonferroni correction.

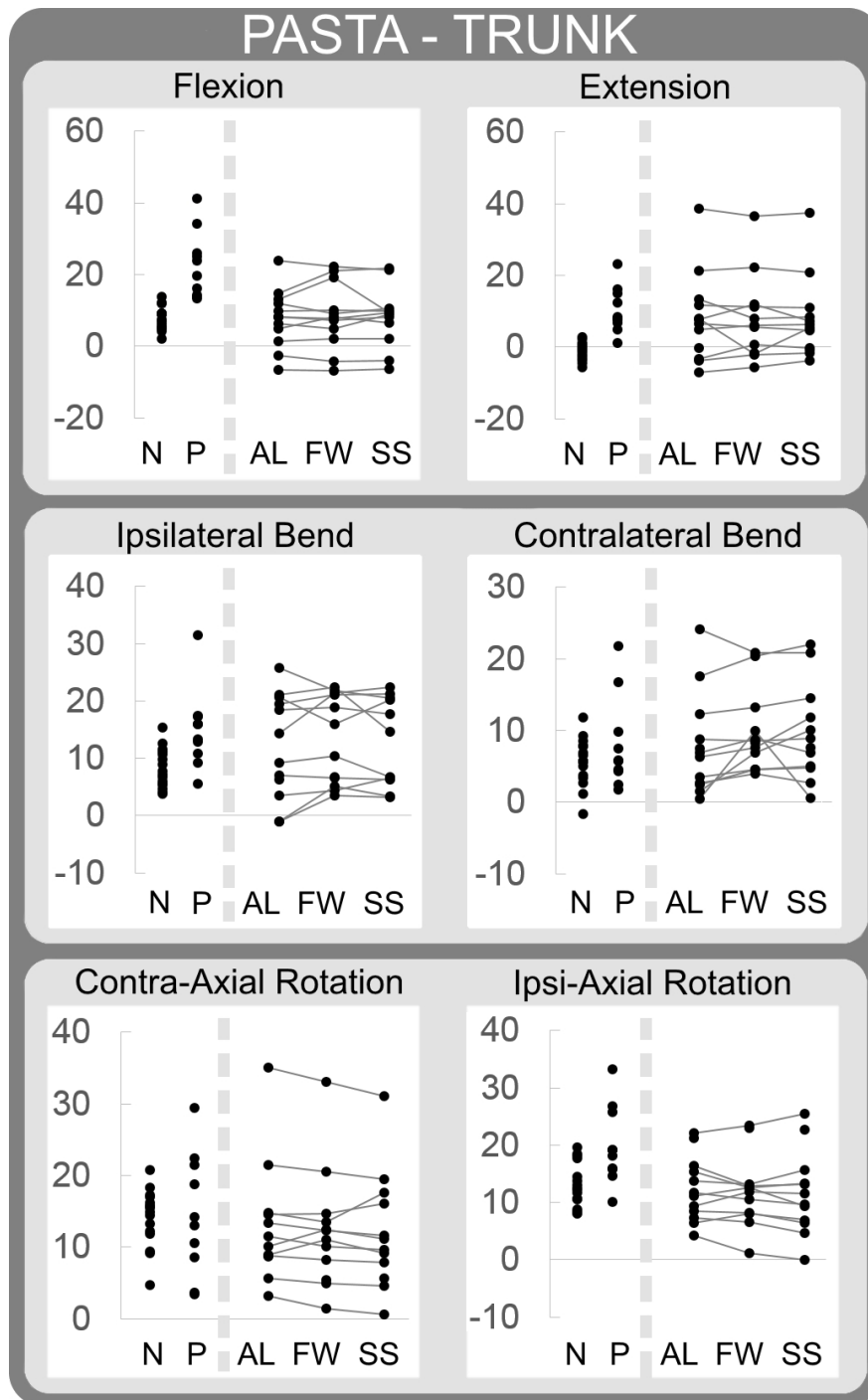

FIGURE 5.5: PASTA-BOX TASK, TRUNK KINEMATICS: Mean maximum angles (deg) for each participant, for fixed-wrist (FW), sequential-switching (SS), and automatically levelling (AL) conditions. Normative (N) and prosthetic (P) data was collected separately [29], [32]. Significance was determined based on the average of the group using pairwise two-sample t-tests, $\alpha = 0.0167$ for Bonferroni correction.

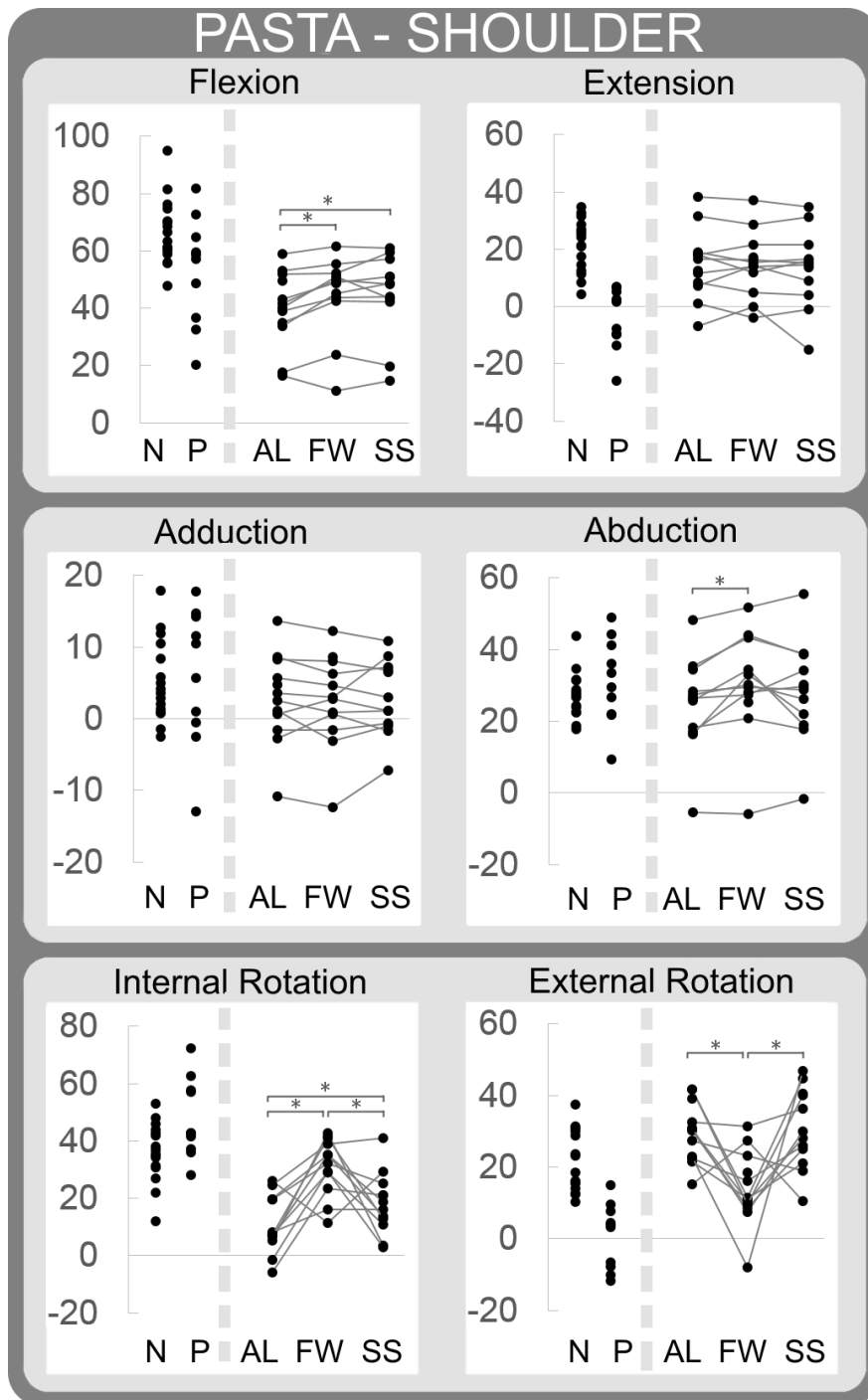

FIGURE 5.6: PASTA-BOX TASK, SHOULDER KINEMATICS: Mean maximum angles (deg) for each participant, for fixed-wrist (FW), sequential-switching (SS), and automatically levelling (AL) conditions. Normative (N) and prosthetic (P) data was collected separately [29], [32]. Significance was determined based on the average of the group using pairwise two-sample t-tests, $\alpha = 0.0167$ for Bonferroni correction.

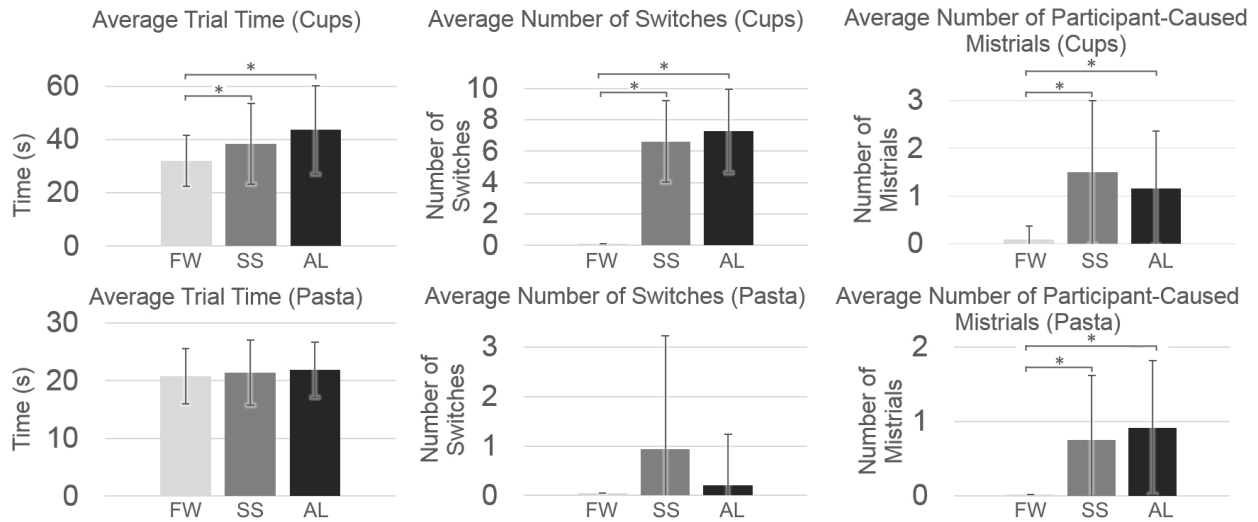

FIGURE 5.7: Performance metrics for each of the control conditions. Columns represent the average across all participants. Error bars indicate one standard deviation. Significance determined using paired two-sample t-tests with $\alpha = 0.0167$ for Bonferroni correction. FW = fixed wrist; SS = sequential switching; AL = autolevelling.

The various performance metrics are plotted in Fig. 5.7, including average trial time, number of control switches, and number of participant-caused mistrials. Time of trial start was defined as the first time the hand velocity rose above 5% of its peak velocity, and time of trial end was defined as the last time the hand velocity fell below 5% of peak velocity, based on the marker position data. The results of the qualitative survey presented at the end of the session are summarized in Fig. 5.8. For all measures in Fig. 5.8, higher scores indicate better performance. Error bars in all figures represent \pm one standard deviation. The results of the statistical analyses for all comparisons are provided in Table 5.4. Tables 5.2 and 5.3 provide the user responses to questions about what made them choose their particular rankings. One participant neglected to complete this portion of the survey, so only eleven responses recorded. The order the responses are presented is randomized but consistent across the tables to facilitate comparisons within an individual participant's preferences.

TABLE 5.2: User responses to the question “What about your #1 choice made it your favourite?”.

Favourite (Cups)	Favourite (Pasta)	Comment
AL	FW	Cups: AL greatly reduced worry of spilling. Made angle of grip on cup less important. Pasta: FW worked sufficiently.
AL	FW	AL does a lot for user and prevents spilling. Especially of the cups.
SS	AL	Cups: AL made it difficult to rotate wrist, SS was good for that and minute adjustments. Pasta: SS was too much back and forth to change wrist angle
FW	AL	Cups: It always moved in a way that I would expect so I could control not spilling easier. Pasta: It would automatically adjust so I wouldn't have to bend my knees to put the pasta on the side table
SS	AL	In the cups experiment, sequential switching made it easier to grab the cup from the top.
FW	FW	Easiest to use; behaved as expected.
SS	AL	AL kept the pasta even over long moves. SS helped to change direction best
AL	AL	Less thinking. Could think one step ahead without having to focus too hard about the task at hand.
SS	FW	Cups: Felt like had more control over moving cup from over head or side. Pasta: Since I didn't need to adjust wrist it was the fastest
FW	AL	It was straightforward to operate, minimal chance of mix-ups and had the least failures
SS	FW	Cups: SS easy to control and less strain on shoulder. Pasta: FW much faster and more efficient. (At least it felt like it)

TABLE 5.3: User responses to the question “What about your #3 choice made it your least favourite?”.

Disliked (Cups)	Disliked (Pasta)	Comment
FW	SS	Cups: FW made the decision of how to grab abundantly important/uncomfortable. Pasta: AL and SS made no contributable difference; angle of grab less important.
FW	SS	FW is very helpful but also the least versatile.
FW	FW	Cups/Pasta: too much bodily movement involved, difficult to pick things up at times.
AL	SS	Cups: It would level itself in a way that felt unexpected. Pasta: I felt like while switching with the pasta in hand, I would risk dropping the pasta.
AL	SS	In the cups experiment, the autolevelling wasn't needed, as we weren't grabbing from different heights, and it mostly got in the way.
SS	SS	Mentally taxing, difficult to position consistently.
FW	FW	Often didn't perform accurately. No ability to perform fine movements.
FW	FW	Cups: I'm too short, had to use tip toes and awkward shoulder position. Pasta: wrist option useless. Had to set down specific way to ensure level and won't fall.
AL	SS	Cups: Toughest experience moving wrist (also bias since learning round). I think after learning fixed wrist wouldn't be not practical so I would rather auto level if I needed limbs. Pasta: didn't need to adjust wrist so not needed.
SS	SS	It required more focus to remember modes.
AL	AL	Cups/Pasta: I think it would take me more time to adapt to the autolevelling—I had a hard time predicting how it would move.

TABLE 5.4: p-values for all comparisons. Paired two-sample t-tests were conducted on all continuous data, with Bonferroni correction for three comparisons leading to $\alpha = 0.0167$. For ordinal data (rankings), Mann-Whitney U-tests were conducted with $\alpha = 0.05$.

Metric	FW vs AL	FW vs SS	AL vs SS
Cups Trunk Flex.	0.0022*	0.0022*	0.3347
Cups Trunk Ext.	0.0312	0.0832	0.1562
Cups Trunk Cont. Bend	0.0005*	<<0.0167*	0.0567
Cups Trunk Ipsi. Bend	0.1249	0.0394	0.1526
Cups Trunk Cont. Rotn	0.0674	0.4872	0.0631
Cups Trunk Ipsi. Rotn	0.0658	0.0696	0.3275
Cups Shldr Flex.	<<0.0167*	0.0001*	0.2432
Cups Shldr Ext.	0.2721	0.3843	0.1499
Cups Shldr Add.	0.2947	0.0611	0.3244
Cups Shldr Abd.	<<0.0167*	<<0.0167*	0.0842
Cups Shldr Int. Rotn	0.0008*	0.0004*	0.0851
Cups Shldr Ext. Rotn	0.0259	0.0122*	0.2618
Cups Trial Time	0.0006*	0.0120*	0.0711
Cups No. of Switches	<<0.0167*	<<0.0167*	0.0993
Cups No. of Mistrials	0.0058*	0.0058*	0.2583
Pasta Trunk Flex.	0.2383	0.3968	0.3253
Pasta Trunk Ext.	0.3203	0.3387	0.3846
Pasta Trunk Cont. Bend	0.0247	0.4324	0.0359
Pasta Trunk Ipsi. Bend	0.1319	0.2024	0.3586
Pasta Trunk Cont. Rotn	0.0856	0.2986	0.0663
Pasta Trunk Ipsi. Rotn	0.3279	0.1887	0.2165
Pasta Shldr Flex.	0.0049*	0.2898	0.0009*
Pasta Shldr Ext.	0.4587	0.1603	0.1071
Pasta Shldr Add.	0.3353	0.3097	0.4440
Pasta Shldr Abd.	0.0032*	0.1781	0.0185
Pasta Shldr Int. Rotn	0.0002*	0.0069*	0.0073*
Pasta Shldr Ext. Rotn	0.0011*	0.0047	0.3358
Pasta Trial Time	0.0593	0.2696	0.2888
Pasta No. of Switches	0.0533	0.0934	0.1537
Pasta No. of Mistrials	0.0024*	0.0060*	0.3190
Intuitiveness	0.0084*	0.0005*	0.1490
Effectiveness (Cups)	0.3977	0.0494	0.1698
Effectiveness (Pasta)	0.0640	0.4215	0.0521
Reliability	0.0043*	0.0360	0.0173
Rank (Cups)	0.8181	0.2501	0.3421
Rank (Pasta)	0.5353	0.0385*	0.0035*

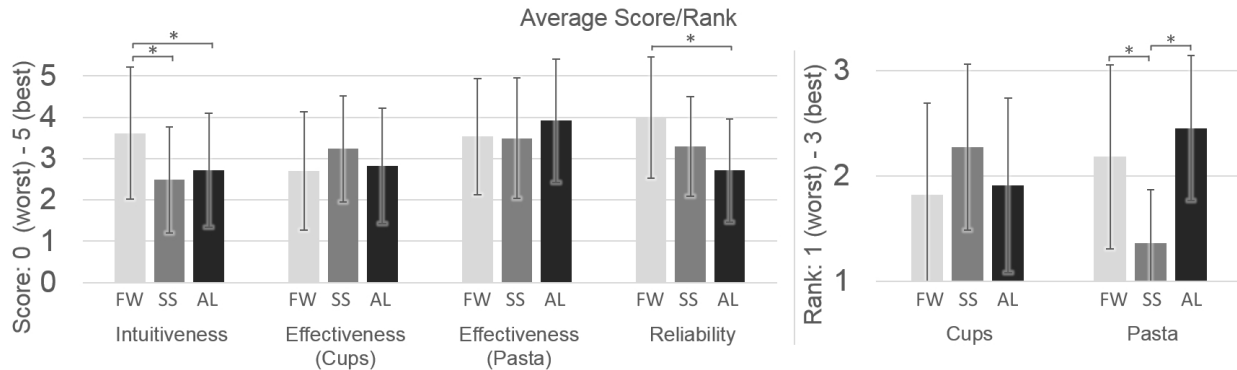

FIGURE 5.8: Qualitative user feedback about various performance aspects of the prosthesis control modes. Columns represent the average across all participants. Error bars indicate one standard deviation. For all measures, a higher score indicates better performance. Significance determined using paired two-sample t-tests ($\alpha = 0.0167$ for Bonferroni) for the continuous scores, and a Mann-Whitney U-test for the ordinal rankings ($\alpha = 0.05$). FW = fixed wrist; SS = sequential switching; AL = autolevelling.

5.4 Discussion

5.4.1 Kinematic Analysis

Cup Transfer Task

The kinematic results from the AL and SS conditions never significantly differed from one another in this task. In the instances where FW differs from AL and SS (trunk flexion, trunk contralateral bend, shoulder flexion, shoulder abduction, and shoulder internal and external rotation), FW always displays a greater mean peak angle. This is indicative of compensatory movements involved in performing the top-grasp of the cup. The normative population makes use of flexion and ulnar deviation of the wrist to perform the top-grasp [29]; without R/U deviation, the participant had to raise their elbow in order to bring the prosthesis down vertically on the cup and ensure the terminal device did not interfere with the barriers of the cart. This compensation was exacerbated by the length of the simulated prosthesis; since the height of the table was not altered from the original study, participants needed to raise their arm 26 cm higher than they otherwise would have in order to perform the top-grasp of the cup. For the Cup Transfer task, there is evidence supporting

the use of a directly controllable wrist allowing R/U deviation, but no evidence to support the use of a continuously adapting wrist as opposed to a conventional sequential switching system.

Pasta-Box Task

For the Pasta-Box task, the only significant differences between the tested control modes existed in shoulder flexion and abduction, and internal/external rotation. In shoulder flexion, the average maximum flexion angle for the AL condition was less than that of both the FW and SS conditions, and for abduction it was less than the FW condition. Less shoulder flexion and abduction in the AL case indicates that the participants didn't need to raise their arm as high in order to place the pasta box onto the shelf, suggesting less compensatory movement. The fact that the maximum flexion angle for all control modes was lower than that for the normative data set was likely due to the increased length of the simulated prosthesis, which enabled the participants to place the box on the shelf without raising their arm as much as they otherwise would have. That the mean maximum flexion angle was significantly different between the AL and SS cases suggests that this difference stems from the adaptive wrist angle. The FW condition induced more internal rotation and less external rotation than AL and SS most probably because users were unable to set the wrist ulnar/radial deviation angle to a suitable position (which was possible in the AL/SS cases). AL induced less internal rotation than SS, indicating that while setting an initial deviation angle helped, adaptation of that angle throughout the task may have had some benefit as well.

Overall, it appears that for the Pasta-Box task that there was little difference between all conditions in terms of movement strategies at the trunk and shoulder level. Differences in internal and external rotation support the advance setting of an appropriate deviation angle, and the reduced shoulder flexion suggests that an adaptive wrist angle may reduce some compensatory movements for vertically-oriented tasks.

5.4.2 Performance Metrics

Each of the measures presented in Fig. 5.7 represents an indication of the performance of the prosthesis with a particular control mode. Of course, these are only a few of the many possible ways of examining prosthesis performance, and each has its limitations in what it is able to show. From the trial time plots, we can see that there was no difference between the modes in completion of the Pasta-Box task, and a slight trend in favour of FW and against AL for the Cup Transfer task. In terms of switching, the FW control condition by nature of its definition had the least number of switches. Those control modes that do involve switching seemed to perform equally well on the Cup Transfer task, but AL trended toward outperforming SS on the Pasta-Box task. Only one participant used the direct wrist control afforded by SS during the movement portions of the Pasta-Box task, requiring many switching signals. All other participants used it in the same manner as the FW, which gave rise to the large variance seen here. The number of participant-caused mistrials was much less for the FW condition than for the other two conditions. This may suggest that cognitive effort normally spent on the task must be put into wrist control, or that erroneous wrist movements may have caused errors. All of these measures suggest that the most rudimentary control system is the simplest to use. Both control schemes that allowed direct wrist control required more conscious thought, though AL did require less switching than SS on the Pasta-Box task while still allowing a change in R/U deviation angle.

5.4.3 Qualitative Measures

Equally important to how well a person uses a prosthesis is how a person feels about using their prosthesis. To this end, the qualitative survey was given to discern people's intuitions about the device (see Fig. 5.8). From these results we see that people felt that all control conditions were equally effective at the tasks, but differences existed in terms of perceived intuitiveness and reliability. The FW control scheme was felt to be the most intuitive, and involved the least complexity of control, compared to AL and SS. AL and SS performed equally well in this category. The FW

control scheme was scored as significantly more reliable than AL. The control mode preferred by the participants differed depending on the task at hand. Though not significant, for the Cup Transfer task SS tended to be preferred, likely because AL was too unreliable and FW forced compensation to perform the top grasp. For the Pasta-Box task however, SS was least preferred, likely because of the perception that having direct wrist control was “useless”, as one participant put it, for this particular task. This sentiment seems to generalize to the other participants as well, since all but one used the SS control in the same manner as FW. This has important implications, since it demonstrates that people will tend to use compensatory movements for simple tasks even when wrist control is available, if control of the wrist requires a switching signal.

Altogether, these results indicate that people feel that the FW control condition was the simplest to use and the most reliable, but lack of R/U deviation made it less preferred for the Cup Transfer task. People felt that the AL scheme was at times unreliable, and was the most difficult to learn, but in the structure of the Pasta-Box task it proved helpful. SS was viewed as the most reliable scheme that allowed R/U deviation for the Cup-Transfer task, but as an unnecessarily complicated control scheme when it came to the Pasta-Box task.

5.4.4 Study Limitations

A significant limitation of this study was the use of a simulated prosthesis with able-bodied people: particularly, one that positioned the prosthesis distally to the user’s hand, increasing the overall limb length by 26 cm. While this was necessary to allow unimpeded prosthesis wrist motion, the extra length introduced additional body compensations in the Cup Transfer task, and may have made some compensations unnecessary even for the FW condition in the Pasta-Box task since it extended the participant’s reach. Another limitation was the short duration in which the participants interacted with the system. The intuitiveness scores, time of trials, and other performance metrics indicate that AL may take more time to learn to use than the FW system. It is possible that with further learning performance may change. Additionally, the imprecise method of error mitigation discussed in Section 4.1.3 may have been a source of some of the AL unreliability. The PID loop in

this tested system, while capable of keeping the hand reasonably level, did still have perceptible lag and overshoot. A more sophisticated control system, perhaps by means of cascading PIDs or neural network tuning might be able to bring the reliability of the system up to a more reasonable level, which should be done prior to further study. The design of the PID control algorithm should be modified to properly correct for coupling effects, and greater effort be made to optimize the tuning parameters. Future studies should involve participants who are actually affected by upper-limb amputation to reduce ambiguities introduced by the simulated prosthesis, and allow sufficient training time to ensure learning effects are reduced. Finally, the use of a button rather than myoelectric co-contractions for the switching signal limits generalization of these results to a fully myoelectric system. It is possible that future machine learning techniques may be able to predict a prosthesis-user's next move and automatically switch to the appropriate control scheme [14], but meanwhile, perhaps the most expedient thing to do is allow a longer training period.

While the performance of the AL system is promising, there are still some limitations including lack of reliability and ease of use. For a person to accept a prosthesis that is making some decisions and movements on its own, the prosthesis must be especially robust and predictable.

5.5 Conclusion

In this study, we aimed to evaluate the effect an automatically levelling wrist system might have on a person's interaction with their prosthesis, measuring that effect in a number of different ways. In terms of the movement strategies used by the participants, it seemed that for the Cup Transfer task AL and SS perform equally well, while the FW condition involved more compensation. For the Pasta-Box task, FW and SS were used in a similar manner, but differences in shoulder flexion indicate AL may have contributed to the reduction of compensatory movements. The performance metrics indicated that the FW system was simplest to use and easiest to learn. AL and SS were approximately equally difficult to use, with a trend in trial length and intuitiveness scores indicating AL may take more time to learn. Participants preferred to use the sequential-switching method on

the Cup Transfer task, as it was less awkward than FW, and more reliable than AL. For the Pasta-Box task, participants equally preferred AL and FW. The kinematic analysis especially indicates that the use of an automatically levelling wrist may not provide much benefit for tasks involving a predominately horizontal plane. The true usefulness of an automatically levelling wrist in reducing compensatory movements exists in tasks involving large vertical motions, such as in placing or reaching for objects on high shelves. In order to provide people with artificial limbs that give meaningful benefit to their lives, care must be taken to ensure that the prostheses are easy to use and don't force compensatory movements; an automatically levelling wrist, if designed robustly and intuitively, may provide one part of the control scheme for such a limb.

Chapter 6

Conclusion

6.1 Summary

Current attempts to fill the gap left by a missing upper limb fall short in many ways. The loss of distal degrees of freedom such as the wrist and hand leads to compensatory movement in the more proximal degrees of freedom: the trunk and shoulder. These compensatory movements, if left unchecked, can result in overuse injuries in the upper back and shoulder which can be debilitating to individuals who have undergone amputation. Wrist prostheses in particular, which may have the best chance of reducing compensatory movements, are generally inadequate. Commercially available prostheses rarely have a powered wrist, and even in those instances where it exists the wrist will only have one degree of freedom (most often rotation). Control of these wrist systems is difficult, and often requires switching sequentially from control of one joint to the next. Some advanced pattern recognition algorithms are beginning to allow limited simultaneous multi-DOF movement, but this still requires heavy concentration on the part of the user. In order to bridge this gap, and allow simultaneous multi-DOF movement without user input in situations where doing so would be appropriate, the concept of a self-adjusting wrist is conceived. Researchers have explored this idea in a number of forms, using either passive wrists that self-adjusted based on built-in compliance, or active wrists that automatically adjusted based on look-up tables or environmental RFID tags.

In this work, we follow a rigorous design methodology centered on human usability. The first study presented focused on the control interface of the automatically levelling system, and determined the most intuitive means of switching in and out of autolevelling. The result from that work suggested using a switching signal as a toggle between automatically levelling and direct control of the wrist, which was the control scheme used in continuing development.

An automatically levelling wrist was subsequently designed for use as a simulated prosthesis on able-bodied people. This system made use of an IMU mounted in the base of the terminal device, which provided the gravitational accelerations necessary to determine and maintain the terminal device orientation. The use of a single, inexpensive sensor and rudimentary PID control algorithms ensures that a similar wrist levelling algorithm could be easily implemented in a commercial system with minimal added cost.

Our second study aimed to elucidate the effect of the automatically levelling system on various metrics. Joint-angle kinematic analysis using motion-capture suggested that the automatically levelling system did not provide any significant benefit compared to a sequential-switching method on tasks occurring mainly in a horizontal plane, but did reduce shoulder flexion significantly for tasks with a large vertical component. Performance metrics determined that a rudimentary fixed-wrist system may be the simplest to use and easiest to learn, while the autolevelling system was the most complex and took longer to learn. User feedback indicated that people felt the automatically levelling system was more unreliable and less intuitive than the fixed-wrist and sequential-switching conditions.

6.2 Unification of Results

Some interesting inferences can be drawn when considering the two studies together. For the study conducted in Chapter 3, which made use of the desk-mounted arm, the AL system significantly outperformed the conventional sequential-switching control scheme on all performance metrics (time, switches, number of spills). However, in the study of Chapter 5, which made use of a

wearable arm, trends indicated that the sequential-switching control scheme performed better on time and mistrial metrics. This is possibly because with a wearable system, the user has greater control of the end-effector by use of their biological limb (indeed, in the desk-mounted system, all control must pass through the digital interface). This biological control allows natural, intuitive compensation which can make trial completion faster and more accurate. Considering this effect in terms of use-cases for the autolevelling system, it may be true that AL will be more useful for persons with a lesser degree of biological function. That is, persons with transradial amputation may be able to compensate effectively to accomplish levelling on their own, but an AL system may be more beneficial for persons with higher level amputation such as transhumeral amputation or shoulder disarticulation. Further study directly addressing this hypothesis is necessary before any claims can be made.

6.3 Outcomes

This work represents the first attempt to design and evaluate an active automatically levelling prosthetic wrist that relies only on its internal state to perform the levelling. Removing reliance on look-up tables and environmental RFID tags greatly enhances the versatility of the system, and represents a more clinically-translatable control-scheme.

The results from our first study provide an indication of how best to integrate an automatically levelling system into the existing sequential-switching framework; that method is to use the switching signal exactly as would normally be the case, and to autolevel any time the wrist is *not* being directly controlled. The results from the subsequent study suggests that while an automatically levelling wrist may provide important physiological benefits on tasks requiring a vertical component, there is still work to be done in making the system reliable and intuitive.

6.4 Future Directions

The continuation of this line of study should involve testing the system with participants affected by upper-limb amputation, with varying levels of amputation, again looking at a wide range of metrics including compensatory movements, task performance, and user satisfaction. Conducting this study will eliminate any confounding factors introduced by using able-bodied participants with a distally-mounted simulated prosthesis, and thus make the effect of the system on compensatory movements much more clear. Prior to conducting this follow-up study however, efforts should be made to improve the autolevelling algorithm to increase reliability. This could possibly be attempted by means of cascading PID loops, or by training the PID parameters on a neural network.

6.5 Final Thoughts

With the advent of any new technology, it is exceedingly important that the designers consider whether what they are creating actually serves the needs of the users. In the case of prostheses, this consideration is even more important, as the proposed device is intended to become an integral part of the person's body. Throughout this work I have intended to provide not only the description of a novel device, but also to evaluate in a comprehensive way the interactions its users have with it. Only through careful adherence to human-centered design principles can we provide people with prostheses that bring meaningful function to their lives.

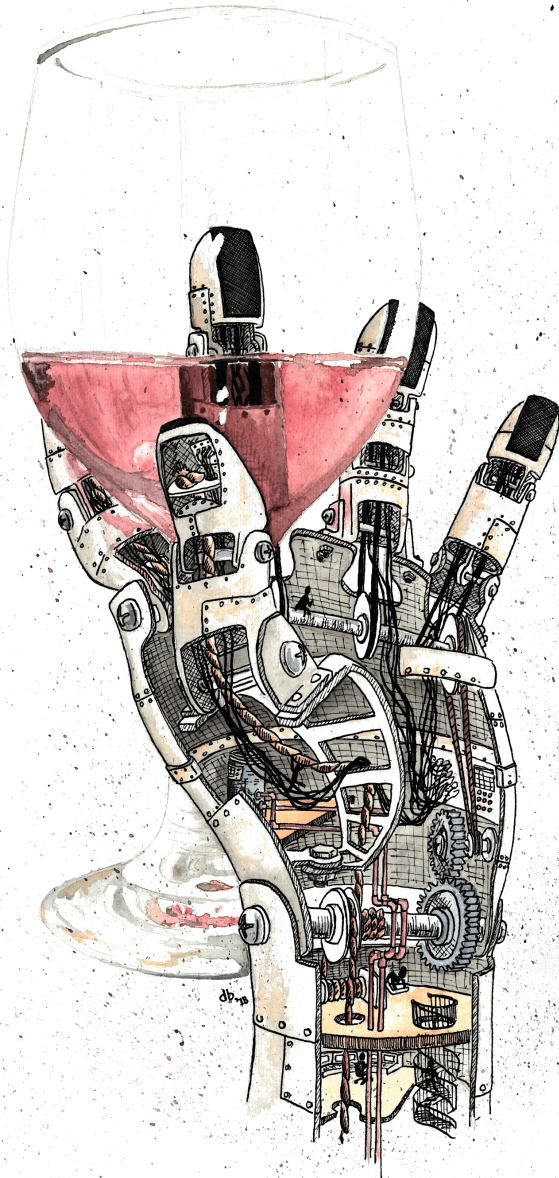

Bibliography

- [1] K. Ziegler-Graham, E. J. MacKenzie, P. L. Ephraim, T. G. Travison, and R. Brookmeyer, "Estimating the prevalence of limb loss in the united states: 2005 to 2050", *Archives of Physical Medicine and Rehabilitation*, vol. 89, no. 3, pp. 422–429, 2008.
- [2] D. J. Atkins, D. C. Y. Heard, and W. H. Donovan, "Epidemiologic overview of individuals with upper-limb loss and their reported research priorities", *Journal of Prosthetics and Orthotics*, vol. 8, no. 1, pp. 2–11, 1996.
- [3] F. Cordella, A. L. Ciancio, R. Sacchetti, A. Davalli, A. G. Cutti, E. Guglielmelli, and L. Zollo, "Literature review on needs of upper limb prosthesis users", *Frontiers in Neuroscience*, vol. 10, p. 209, 2016.
- [4] N. M. Bajaj, A. J. Spiers, and A. M. Dollar, "State of the art in prosthetic wrists: Commercial and research devices", in *2015 IEEE International Conference on Rehabilitation Robotics (ICORR)*, Aug. 2015, pp. 331–338.
- [5] B. D. Adams, N. M. Grosland, D. M. Murphy, and M. McCullough, "Impact of impaired wrist motion on hand and upper-extremity performance", *The Journal of Hand Surgery*, vol. 28, no. 6, pp. 898–903, 2003.
- [6] A. J. Metzger, A. W. Dromerick, R. J. Holley, and P. S. Lum, "Characterization of compensatory trunk movements during prosthetic upper limb reaching tasks", *Archives of Physical Medicine and Rehabilitation*, vol. 93, no. 11, pp. 2029–2034, 2012.

-
- [7] S. L. Carey, M. J. Highsmith, M. E. Maitland, and R. V. Dubey, "Compensatory movements of transradial prosthesis users during common tasks", *Clinical Biomechanics*, vol. 23, no. 9, pp. 1128–1135, 2008.
- [8] A. G. Mell, B. L. Childress, and R. E. Hughes, "The effect of wearing a wrist splint on shoulder kinematics during object manipulation", *Archives of Physical Medicine and Rehabilitation*, vol. 86, no. 8, pp. 1661–1664, 2005.
- [9] F. Montagnani, M. Controzzi, and C. Cipriani, "Is it finger or wrist dexterity that is missing in current hand prostheses?", *IEEE Transactions on Neural Systems and Rehabilitation Engineering*, vol. 23, no. 4, pp. 600–609, Jul. 2015.
- [10] K. Østlie, R. J. Franklin, O. H. Skjeldal, A. Skrondal, and P. Magnus, "Musculoskeletal pain and overuse syndromes in adult acquired major upper-limb amputees", *Archives of Physical Medicine and Rehabilitation*, vol. 92, no. 12, pp. 1967–1973, 2011.
- [11] K. M. Norton, "A brief history of prosthetics", *Amputee Coalition*, vol. 17, no. 7, Dec. 2007.
- [12] P. Parker, K. Englehart, and B. Hudgins, "Myoelectric signal processing for control of powered limb prostheses", *Journal of Electromyography and Kinesiology*, vol. 16, no. 6, pp. 541–548, 2006, Special Section (pp. 541–610): 2006 ISEK Congress.
- [13] A. L. Edwards, M. R. Dawson, J. S. Hebert, C. Sherstan, R. S. Sutton, K. M. Chan, and P. M. Pilarski, "Application of real-time machine learning to myoelectric prosthesis control: A case series in adaptive switching", *Prosthetics and Orthotics International*, vol. 40, no. 5, pp. 573–581, 2016.
- [14] A. L. Edwards, J. S. Hebert, and P. M. Pilarski, "Machine learning and unlearning to autonomously switch between the functions of a myoelectric arm", in *2016 6th IEEE International Conference on Biomedical Robotics and Biomechatronics (BioRob)*, Jun. 2016, pp. 514–521.

-
- [15] A. J. Young, L. H. Smith, E. J. Rouse, and L. J. Hargrove, "Classification of simultaneous movements using surface EMG pattern recognition", *IEEE Transactions on Biomedical Engineering*, vol. 60, no. 5, pp. 1250–1258, May 2013.
- [16] N. Jarrassé, E. de Montalivet, F. Richer, C. Nicol, A. Touillet, N. Martinet, J. Paysant, and J. B. de Graaf, "Phantom-mobility-based prosthesis control in transhumeral amputees without surgical reinnervation: A preliminary study", *Frontiers in Bioengineering and Biotechnology*, vol. 6, p. 164, 2018.
- [17] C. W. Antuvan, S. C. Yen, and L. Masia, "Simultaneous classification of hand and wrist motions using myoelectric interface: Beyond subject specificity", in *2016 6th IEEE International Conference on Biomedical Robotics and Biomechanics (BioRob)*, Jun. 2016, pp. 1129–1134.
- [18] T. R. Farrell and R. F. Weir, "The optimal controller delay for myoelectric prostheses", *IEEE Transactions on Neural Systems and Rehabilitation Engineering*, vol. 15, no. 1, pp. 111–118, Mar. 2007.
- [19] H. Bouwsema, C. K. van der Sluis, and R. M. Bongers, "Changes in performance over time while learning to use a myoelectric prosthesis.", *Journal of NeuroEngineering & Rehabilitation (JNER)*, vol. 11, no. 1, pp. 1–30, 2014.
- [20] T. G. Kuus, M. R. Dawson, K. Schoepp, J. P. Carey, and J. S. Hebert, "Development of a simulated sensory motor prosthesis: A device to research prosthetic sensory feedback using able-bodied individuals", in *Proc. 2017 Myoelectric Controls Symposium (MEC'17)*, Aug. 2017.
- [21] I. D. Swain and J. M. Nightingale, "An adaptive control system for a complete hand/arm prosthesis", *Journal of Biomedical Engineering*, vol. 2, no. 3, pp. 163–166, 1980.
- [22] H. H. Sears, E. Iversen, J. Christenson, and T. Jacobs, "Integrated system of new electric TD and wrist components - Stage 1 developments", in *Proc. 2014 Myoelectric Controls Symposium (MEC'14)*, Fredericton, New Brunswick, 2014.

-
- [23] E. Iversen, J. Christenson, H. H. Sears, G. Jacobs, S. Hosie, and T. Jacobs, "Powered flexion wrist with electric terminal device - development and preliminary clinical trials", in *Proc. 2017 Myoelectric Controls Symposium (MEC'17)*, Fredericton, New Brunswick, 2017.
- [24] L. Resnik, J. Cancio, C. Fantini, A. Ikeda, and N. Sasson, "Pattern recognition control of the DEKA arm in two transhumeral amputees with targeted muscle reinnervation", in *Proc. 2017 Myoelectric Controls Symposium (MEC'17)*, Fredericton, New Brunswick, 2017.
- [25] M. R. Dawson, C. Sherstan, J. P. Carey, J. S. Hebert, and P. M. Pilarski, "Development of the Bento Arm : An improved robotic arm for myoelectric training and research", in *Proc. 2014 Myoelectric Controls Symposium (MEC'14)*, Fredericton, New Brunswick, 2014.
- [26] BLINCdev. (2018). Blincdev - Bento Arm overview, [Online]. Available: <https://blincdev.ca/the-bento-arm/overview/> (visited on 10/12/2018).
- [27] —, (2018). Github - blincdev, [Online]. Available: <https://github.com/blincdev> (visited on 11/12/2018).
- [28] A. M. Valevicius, P. Y. Jun, J. S. Hebert, and A. H. Vette, "Use of optical motion capture for the analysis of normative upper body kinematics during functional upper limb tasks: A systematic review", *Journal of Electromyography and Kinesiology*, 2018.
- [29] A. M. Valevicius, Q. A. Boser, E. B. Lavoie, G. S. Murgatroyd, P. M. Pilarski, C. S. Chapman, A. H. Vette, and J. S. Hebert, "Characterization of normative hand movements during two functional upper limb tasks", *PLoS ONE*, vol. 13, no. 6, Jun. 2018.
- [30] A. M. Valevicius, Q. A. Boser, E. B. Lavoie, C. S. Chapman, P. M. Pilarski, J. S. Hebert, and A. H. Vette, "Characterization of normative angular joint kinematics during two functional upper limb tasks", *Gait and Posture*, vol. 69, pp. 176–186, 2019.
- [31] Q. A. Boser, A. M. Valevicius, E. B. Lavoie, C. S. Chapman, P. M. Pilarski, J. S. Hebert, and A. H. Vette, "Cluster-based upper body marker models for three-dimensional kinematic

- analysis: Comparison with an anatomical model and reliability analysis", *Journal of Biomechanics*, vol. 72, pp. 228–234, 2018.
- [32] J. S. Hebert, C. S. Chapman, A. H. Vette, P. M. Pilarski, Q. A. Boser, A. M. Valevicius, and E. B. Lavoie, "A quantitative gaze and movement assessment for advanced upper limb prostheses", in *2nd International Symposium on Innovations in Amputation Surgery and Prosthetic Technologies; IASPT Book of Abstracts*, May 2018, p. 19.
- [33] H. E. Williams, Q. A. Boser, P. M. Pilarski, C. S. Chapman, A. H. Vette, and J. S. Hebert, "Hand function kinematics when using a simulated myoelectric prosthesis", in *2019 16th IEEE International Conference on Rehabilitation Robotics (ICORR)*, Submitted February 2019.
- [34] A. A. Kokush, V. V. Fateev, L. N. Evstratov, and V. V. Kozlov, *Triaxial gyroscopic stabilizer for movie or television camera*, U.S. Grant US5868031A, Feb. 1999. [Online]. Available: <https://patents.google.com/patent/US5868031A/en>.
- [35] A. Pathak, *System and method for stabilizing unintentional muscle movements*, U.S. Patent US20140052275A1, Feb. 2014. [Online]. Available: <https://patents.google.com/patent/US20140052275A1/en>.
- [36] S. S. Dillon, "Automatic control of wrist rotation in artificial arm", in *Proc. 1995 Myoelectric Controls Symposium (MEC'95)*, Fredericton, New Brunswick, 1995.
- [37] K. Ohnishi, T. Morio, T. Takagi, and I. Kajitani, "Multimodal sensor controlled three degree of freedom transradial prosthesis", in *2013 IEEE 13th International Conference on Rehabilitation Robotics (ICORR)*, Jun. 2013, pp. 1–6.
- [38] M. Shibuya, K. Ohnishi, and I. Kajitani, "Networked multimodal sensor control of powered 2-dof wrist and hand", *Hindawi Journal of Robotics*, p. 12, 2017.
- [39] R. Jacobs, "The addition of a flexible wrist unit to enhance prosthetic function", in *Proc. 1993 Myoelectric Controls/Powered Prosthetics Symposium (MEC'93)*, Fredericton, New Brunswick, 1993.

- [40] F. Montagnani, M. Controzzi, and C. Cipriani, "Preliminary design and development of a two degrees of freedom passive compliant prosthetic wrist with switchable stiffness", in *2013 IEEE International Conference on Robotics and Biomimetics (ROBIO)*, Dec. 2013, pp. 310–315.
- [41] G. Kanitz, F. Montagnani, M. Controzzi, and C. Cipriani, "Compliant prosthetic wrists entail more natural use than stiff wrists during reaching, not (necessarily) during manipulation", *IEEE Transactions on Neural Systems and Rehabilitation Engineering*, vol. 26, no. 7, pp. 1407–1413, Jul. 2018.
- [42] M. Deijs, R. M. Bongers, N. D. M. Ringeling van Leusen, and C. K. van der Sluis, "Flexible and static wrist units in upper limb prosthesis users: Functionality scores, user satisfaction and compensatory movements", *Journal of NeuroEngineering and Rehabilitation*, vol. 13, no. 1, p. 26, Mar. 2016.
- [43] K. B. James, *System for controlling artificial knee joint action in an above knee prosthesis*, U.S. Patent 5383939A, Nov. 1996. [Online]. Available: <https://patents.google.com/patent/US5383939A/en>.
- [44] D. A. Norman, *The design of everyday things*. The Purseus Books Group, 1988, Reprinted 2013.
- [45] D. J. A. Brenneis, M. R. Dawson, G. Murgatroyd, J. P. Carey, and P. M. Pilarski, "Initial investigation of a self-adjusting wrist control system to maintain prosthesis terminal device orientation relative to the ground reference frame", in *2018 7th IEEE International Conference on Biomedical Robotics and Biomechatronics (BioRob)*, Aug. 2018, pp. 756–763.
- [46] W. Commons. (2019). File:xbox controller.svg, [Online]. Available: https://commons.wikimedia.org/wiki/File:Xbox_Controller.svg.
- [47] V. Vandoren. (Sep. 2017). To PID or not to PID, The venerable proportional-integral-derivative (PID) algorithm can solve a variety of feedback control problems, but not all., [Online]. Available: <https://www.controleng.com/articles/to-pid-or-not-to-pid/> (visited on 12/12/2018).

-
- [48] K. Astrom, *Adaptive control*. New York, N.Y.: Dover Publications, Inc., 2008, pp. 25–26, ISBN: 978-0-486-46278-3.
- [49] E. F. Camacho and C. Bordons, “Nonlinear model predictive control: An introductory review”, in *Assessment and Future Directions of Nonlinear Model Predictive Control*, Berlin, Germany: Springer-Verlag, 2006, pp. 1–16, ISBN: 978-3-540-72699-9.
- [50] P. J. Antsaklis and K. M. Passino, “Chapter 1: Introduction to intelligent control systems with high degrees of autonomy”, in *An Introduction to Intelligent and Autonomous Control*, Berlin, Germany: Kluwer Academic Publishers, 1993, pp. 1–26, ISBN: 0-7923-9267-1.
- [51] Sparkfun. (2019). Thumb joystick, [Online]. Available: <https://www.sparkfun.com/products/9032> (visited on 11/02/2019).
- [52] A. R. Tilley, *The measure of man and woman*. BPI Communications, Inc., 1515 Broadway, New York, N.Y. 10036: Henry Dreyfuss Associates, 2002, ISBN: 0-471-09955-4.
- [53] K. Townsend. (Apr. 2018). Adafruit bno055 absolute orientation sensor, [Online]. Available: <https://cdn-learn.adafruit.com/downloads/pdf/adafruit-bno055-absolute-orientation-sensor.pdf>.
- [54] D. J. A. Brenneis, M. R. Dawson, H. Tanikawa, J. S. Hebert, J. P. Carey, and P. M. Pilarski, “The effect of a self-adjusting wrist”, in *2019 16th IEEE International Conference on Rehabilitation Robotics (ICORR)*, Submitted February 2019.

Appendix A

Detailed Participant Performance Charts

Since the aggregate data presented in Chapter 3 hides some interesting features of the participant performance, all individual performance charts are provided here. The key features available in these charts that are not available in the aggregate data are the order of intervention presentation, instances of erroneous button-presses, and learning curve trends. Considering these charts provides an insight to each user's experience of the test.

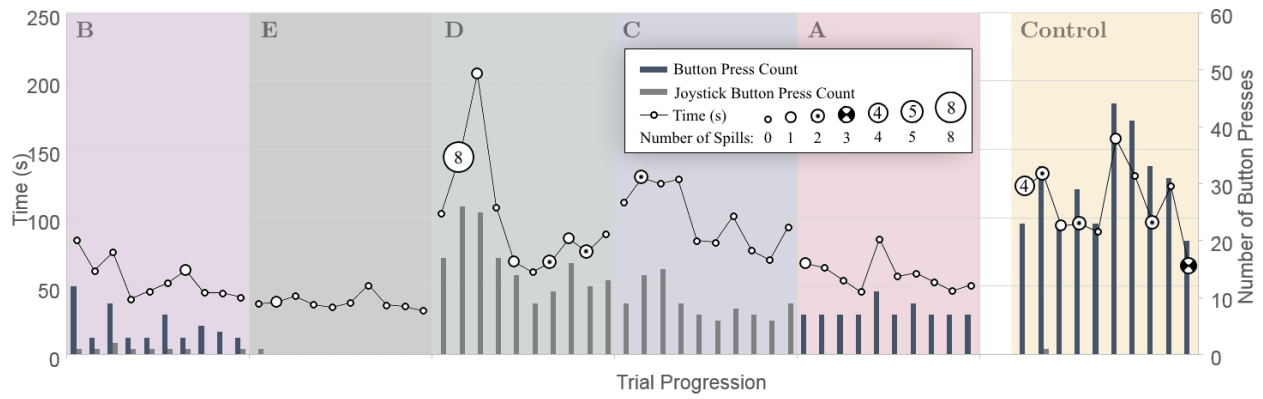

FIGURE A.1: Task performance across the entire testing session for Participant 1.

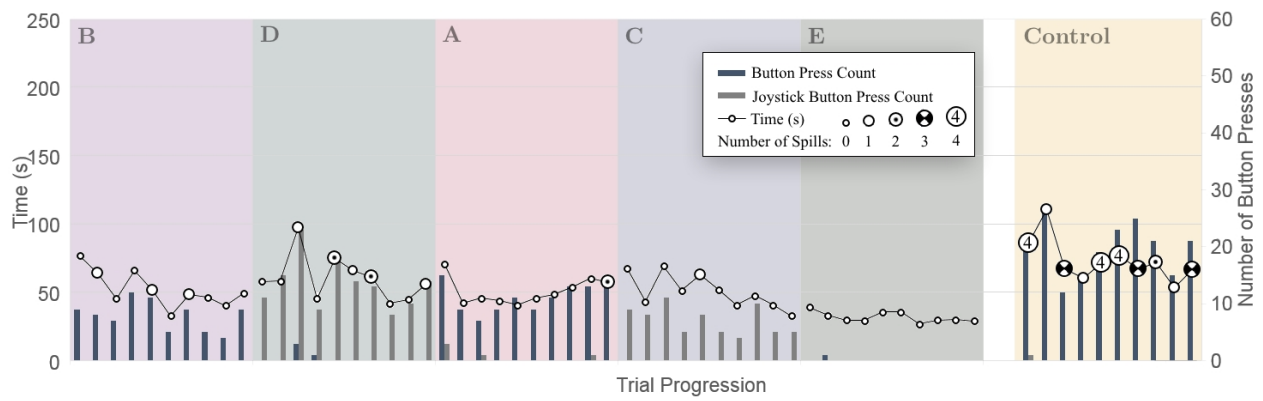

FIGURE A.2: Task performance across the entire testing session for Participant 2.

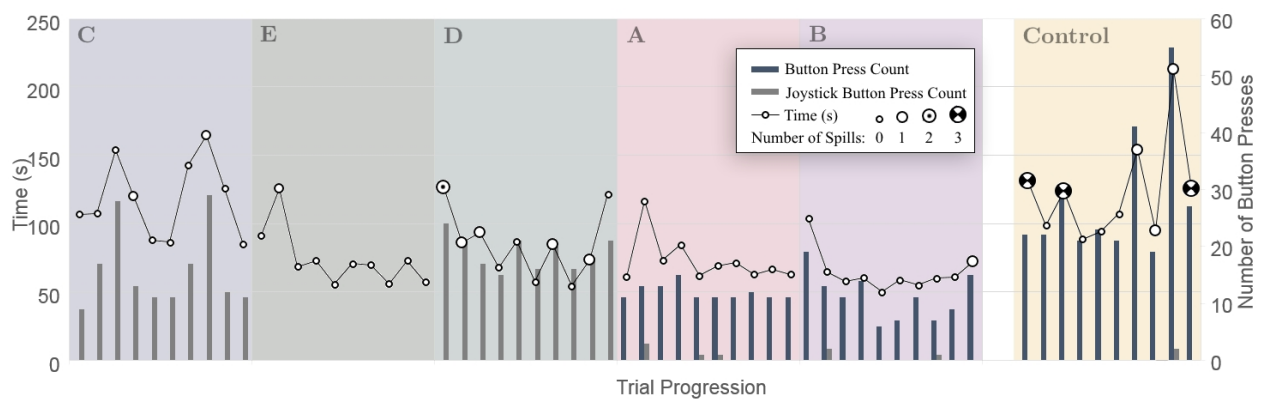

FIGURE A.3: Task performance across the entire testing session for Participant 3.

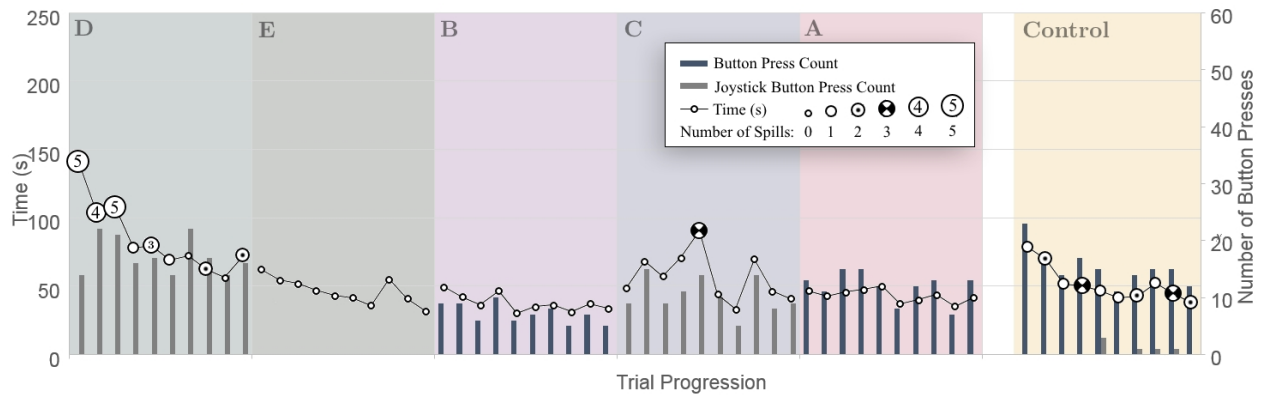

FIGURE A.4: Task performance across the entire testing session for Participant 4.

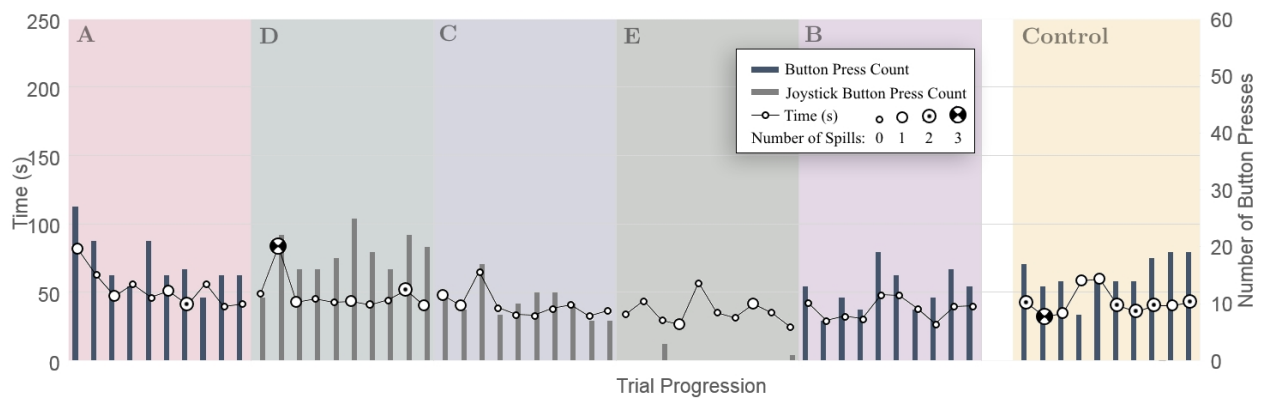

FIGURE A.5: Task performance across the entire testing session for Participant 5.

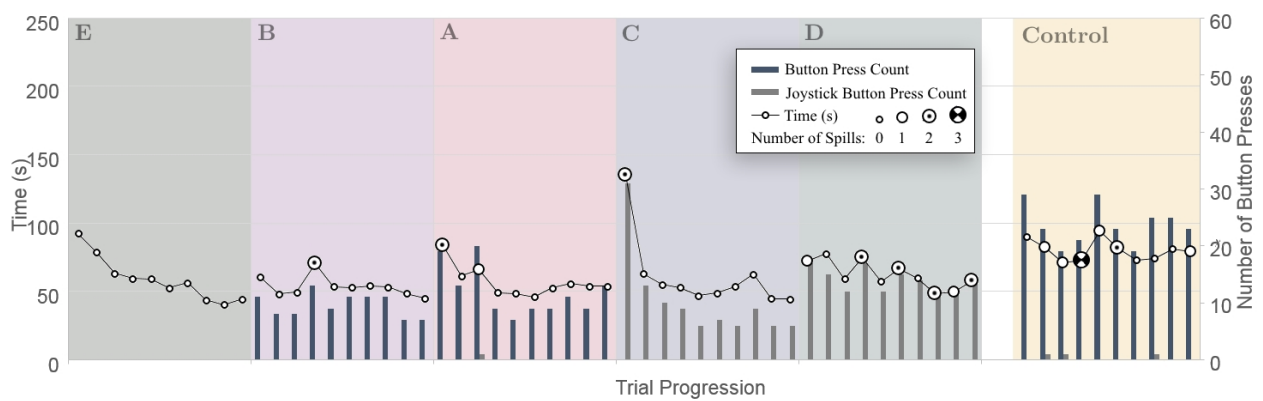

FIGURE A.6: Task performance across the entire testing session for Participant 6.