

CANADIAN THESES ON MICROFICHE

THÈSES CANADIENNES SUR MICROFICHE



National Library of Canada
Collections Development Branch

Canadian Theses on
Microfiche Service

Ottawa, Canada
K1A 0N4

Bibliothèque nationale du Canada
Direction du développement des collections

Service des thèses canadiennes
sur microfiche

NOTICE

The quality of this microfiche is heavily dependent upon the quality of the original thesis submitted for microfilming. Every effort has been made to ensure the highest quality of reproduction possible.

If pages are missing, contact the university which granted the degree.

Some pages may have indistinct print especially if the original pages were typed with a poor typewriter ribbon or if the university sent us an inferior photocopy.

Previously copyrighted materials (journal articles, published tests, etc.) are not filmed.

Reproduction in full or in part of this film is governed by the Canadian Copyright Act, R.S.C. 1970, c. C-30. Please read the authorization forms which accompany this thesis.

**THIS DISSERTATION
HAS BEEN MICROFILMED
EXACTLY AS RECEIVED**

AVIS

La qualité de cette microfiche dépend grandement de la qualité de la thèse soumise au microfilmage. Nous avons tout fait pour assurer une qualité supérieure de reproduction.

S'il manque des pages, veuillez communiquer avec l'université qui a conféré le grade.

La qualité d'impression de certaines pages peut laisser à désirer, surtout si les pages originales ont été dactylographiées à l'aide d'un ruban usé ou si l'université nous a fait parvenir une photocopie de qualité inférieure.

Les documents qui font déjà l'objet d'un droit d'auteur (articles de revue, examens publiés, etc.) ne sont pas microfilmés.

La reproduction, même partielle, de ce microfilm est soumise à la Loi canadienne sur le droit d'auteur, SRC 1970, c. C-30. Veuillez prendre connaissance des formules d'autorisation qui accompagnent cette thèse.

**LA THÈSE A ÉTÉ
MICROFILMÉE TELLE QUE
NOUS L'AVONS REÇUE**

Canada

8

D-315-21004-7



National Library of Canada

Bibliothèque nationale du Canada

Canadian Theses Division

Division des thèses canadiennes

Ottawa, Canada
K1A 0N4

PERMISSION TO MICROFILM — AUTORISATION DE MICROFILMER

• Please print or type — Écrire en lettres moulées ou dactylographier

Full Name of Author — Nom complet de l'auteur

Charles Mc Gregor Molnar

Date of Birth — Date de naissance

June 29 1956

Country of Birth — Lieu de naissance

U.S.A.

Permanent Address — Résidence fixe

7216-114a St. Edmonton Alberta T6G 1N2

Title of Thesis — Titre de la thèse

Transformation of Drosophila: Incorporation of a Foreign +RNA Gene.

University — Université

University of Alberta

Degree for which thesis was presented — Grade pour lequel cette thèse fut présentée

Master of Science

Year this degree conferred — Année d'obtention de ce grade

1985

Name of Supervisor — Nom du directeur de thèse

Dr. J.B. Bell

Permission is hereby granted to the NATIONAL LIBRARY OF CANADA to microfilm this thesis and to lend or sell copies of the film.

L'autorisation est, par la présente, accordée à la BIBLIOTHÈQUE NATIONALE DU CANADA de microfilmer cette thèse et de prêter ou de vendre des exemplaires du film.

The author reserves other publication rights, and neither the thesis nor extensive extracts from it may be printed or otherwise reproduced without the author's written permission.

L'auteur se réserve les autres droits de publication; ni la thèse ni de longs extraits de celle-ci ne doivent être imprimés ou autrement reproduits sans l'autorisation écrite de l'auteur.

Date

Nov. 28, 1985

Signature

Charles M. Molnar

THE UNIVERSITY OF ALBERTA
TRANSFORMATION OF *Drosophila* : INCORPORATION OF A FOREIGN GENE

by

CHARLES MCGREGOR MOLNAR



A THESIS

SUBMITTED TO THE FACULTY OF GRADUATE STUDIES AND RESEARCH
IN PARTIAL FULFILMENT OF THE REQUIREMENTS FOR THE DEGREE
OF MASTER OF SCIENCE

DEPARTMENT OF GENETICS

EDMONTON, ALBERTA

SPRING 1985

THE UNIVERSITY OF ALBERTA

RELEASE FORM

NAME OF AUTHOR CHARLES MCGREGOR MOLNAR
TITLE OF THESIS TRANSFORMATION OF *Drosophila* : INCORPORATION OF
A FOREIGN tRNA GENE
DEGREE FOR WHICH THESIS WAS PRESENTED MASTER OF SCIENCE
YEAR THIS DEGREE GRANTED SPRING 1985

Permission is hereby granted to THE UNIVERSITY OF ALBERTA LIBRARY to reproduce single copies of this thesis and to lend or sell copies for private, scholarly or scientific research purposes only.

The author reserves other publication rights, and neither the thesis nor extensive extracts from it may be printed or otherwise reproduced without the author's written permission.

(SIGNED) *Charles Molnar*

PERMANENT ADDRESS:

7216-114a Street

Edmonton, Alberta

T6G 1N2

DATED *Nov. 28, 1984*

THE UNIVERSITY OF ALBERTA
FACULTY OF GRADUATE STUDIES AND RESEARCH

The undersigned certify that they have read, and recommend to the Faculty of Graduate Studies and Research, for acceptance, a thesis entitled TRANSFORMATION OF DROSOPHILA: INCORPORATION OF A FOREIGN tRNA GENE submitted by CHARLES MCGREGOR MOLNAR in partial fulfilment of the requirements for the degree of MASTER OF SCIENCE.

John B. Bell
.....

J. B. Bell (Supervisor)

Kenneth L. Roy
.....

K. L. Roy

Frank Nargang
.....

F. E. Nargang

M. A. Russell
.....

M. A. Russell

Date *Nov. 2, 1984*

For Rev. Dr. E. F. Molnar, L. Harris
and Gwennie and George.

ABSTRACT

The research in this thesis is comprised of three parts. The first was the testing of the Rubin and Spradling P-element mediated *Drosophila* transformation technique using their vectors pRy1 and p π 25.1. The second portion was an attempt, using P-element mediated transformation, to introduce cloned suppressor transfer RNA (tRNA) genes from *Saccharomyces cerevisiae* and *Schizosaccharomyces pombe* into *Drosophila* carrying putative *rosy* nonsense mutants. The third was the introduction of DNA sequences containing a nonsense suppressor transfer RNA gene (tRNA^{Ser}_{UGA} gene) from *S. pombe* and a wild type *rosy* gene into *Drosophila* via P-element mediated transformation.

A reconstruction of the Rubin and Spradling transformation experiments with *rosy* proved successful, generating four independent transformed (*rosy*⁺) lines. These were examined to determine the level of xanthine dehydrogenase (XDH) activity and the chromosomal location of the insertions.

The unselected introduction of suppressor tRNA genes from yeasts into *Drosophila* failed to produce any phenotypically transformed (*rosy*⁺) flies.

The co-transformation experiments using a tRNA suppressor gene and a wild type *rosy* (XDH) structural gene were successful. In total, 18 independent transformed lines were isolated and Southern analysis of two lines confirmed the introduction of suppressor tRNA gene sequences. Further experiments are planned to detect transcription and activity of the suppressor tRNA.

Acknowledgements

I would like to thank my advisor John Bell for his support, guidance, and patience. For their advise and proofreading, I would like to thank Ross Hodgetts, Jonathan Tyler, Michael Russell, Frank Nargang, Dan Gietz, Pliny Hayes, David Nash, and R. C. vonBorstel. Very special thanks to Mary Holmes, Debbie Smith, and Maureen Topping for help in manuscript preparation.

TABLE OF CONTENTS

	Page
I. INTRODUCTION	1
II. MATERIALS AND METHODS	13
A. <i>Drosophila</i> Culturing	13
B. <i>Drosophila melanogaster</i> Stock List	13
C. Cytotype Determination	14
D. Linkage Analysis	14
E. Growth Media	21
F. Transformation of <i>Drosophila</i>	21
I Preparation of DNA for Injection	21
II Preparation of Needles for Microinjection.....	22
III Collection and Preparation of Embryos for Injection.....	22
IV Injection of Embryos	23
G. Transformation of <i>E. coli</i> HB101 with Plasmid DNA	24
H. Preparation of Plasmid DNA.....	24
I. Rapid Extraction of Plasmid DNA	25
J. Genomic DNA Extraction from <i>Drosophila</i>	26
K. DNA Restriction	26
L. DNA Agarose Gel Electrophoresis	27
M. Purification of Restriction Fragments from Agarose Gels ...	27
N. Ligations of DNA with T4 Ligase	28
O. Southern Hybridization	28
P. Nick Translation	28
Q. <i>In Situ</i> Hybridization	29
R. Autoradiography	30
S. Xanthine Dehydrogenase (XDH) Assays	30
T. Alcohol Dehydrogenase (ADH) Assays	31

	Page
III. RESULTS	33
A. Cytotype Determination	33
B. Injections with p α 25.1	33
C. Transformation Experiments using p α 25.1 and pRy1	34
I Levels of XDH Activity in Transformed Lines	35
II Linkage Group Determination of Integrated <i>Rosy</i> ⁺ Genes	35
D. Soaking Embryos in pRy1 and p α 25.1	47
E. Injections of pRy1 and p α 25.1 into <i>Drosophila</i> <i>mercatorum</i>	48
F. Plasmid Construction	48
G. Transformation of <i>Drosophila</i> with tRNA Suppressor Genes from Yeast	61
H. Co-transformation Experiment	63
I First Injection Series with Plasmids PRyeST and p α 25.1	64
II Second Injection Series with Plasmids PRyeST and p α 25.1	65
I. Southern Analysis	65
IV. DISCUSSION	72
A. <i>Rosy</i> Transformation Experiments	72
B. Experiments with the Unselected Introduction of Suppressor Genes	77
C. Co-transformation of <i>Drosophila</i> with the <i>Rosy</i> Gene and a Suppressor tRNA Gene	79
BIBLIOGRAPHY	85

LIST OF TABLES

	Page
1. Injection Series with pRy1 and p α 25.1	36
2. Transformants from Injection Series with pRy1 and p α 25.1 in ry ^{a1}	37
3. Transformants from Injection Series with pRy1 and p α 25.1 in ry ⁸	38
4. Linkage Group Analysis Data: Second Chromosome	41
5. Linkage Group Analysis Data: Third Chromosome	42
6. Injection Series with p6.1Sup4-o, p6.1UGA, SupRL	62
7. Injection Series with pRyeST and p α 25.1	66
8. Injection Series with pRyeST and p α 25.1	67

LIST OF FIGURES

	Page
1. Linkage Group Analysis: X-Chromosome	16
2. Linkage Group Analysis: Second Chromosome	18
3. Linkage Group Analysis: Third Chromosome	20
4. Histogram: XDH Enzyme Activity Levels	40
5. <i>In Situ</i> Hybridization: <i>Roby</i> ⁺ Transformed T3	44
6. <i>In Situ</i> Hybridization: <i>Roby</i> ⁺ Transformed T4	46
7. Plasmid Construction: p6.1UGA; p6.1RyUGA.....	50
8. Plasmid Construction: p6.1Sup4-o.....	52
9. Plasmid Construction: pC-1ADH	54
10. Plasmid Construction: pRyeST	56
11. Restriction Analysis of pRyeST	60
12. Southern Analysis of Transformed Strains P32 and P47	69

Thou blind man's mark, thou fool's self-chosen snare,
Fond fancy's scum, and dregs of scattered thought,
Band of all evils; cradle of causeless care;
Thou web of will, whose end is never wrought:
Desire! Desire! I have too dearly bought
With price of mangled mind, thy worthless ware.

SIR PHILIP SIDNEY

I. INTRODUCTION

Of the different classes of conditional mutations that are known, that of transfer RNA (tRNA) mediated suppression of nonsense mutations was predicted and discovered (reviewed in Hartman and Roth, 1973) relatively early in the development of molecular genetics. The process involves the alteration of a tRNA gene, usually in the region that becomes the anticodon, such that termination signals or nonsense codons can be recognized by the mutant tRNA molecules and an amino acid added to the elongating polypeptide. Usually nonsense suppressors are tentatively identified when a second site mutation rescues a strain where a nonsense mutation has interrupted a vital gene. In bacteria and yeast, sequence analysis has shown the change in the tRNA to be an alteration so that termination signals can now be read (Goodman et al., 1977) (Korner et al., 1978) (Steege and Soll, 1979). In the elaboration of the current understanding of translation and tRNA transcription, modification and function, suppressor tRNA's have been valuable tools (Sherman, 1982).

It has long been one of the goals of our laboratory to recognize nonsense suppression in *Drosophila melanogaster*. While it has been documented in bacteria (Engelhart et al, 1965) yeast (Hawthorne and Leupold, 1974; Gestland et al., 1976; Cappecci et al., 1975) *Neurospora* (Seale et al., 1976) nematodes (Waterston and Brenner, 1978) and bovine liver cells (Diamond et. al., 1981), no nonsense suppressor has been discovered in *Drosophila*, which is one of the most intensely studied multicellular eukaryotes.

For a number of years the suppressor of sable locus *su(s)* seemed the most likely candidate for a nonsense suppressor in *Drosophila*.

The idea that the *su(s)* locus in *Drosophila* might be involved in tRNA mediated (presumably nonsense) suppression came originally from the observation that specific alleles of certain pigment mutants were suppressed when the *su(s)* locus was homozygous. Apparent confirmation of this hypothesis came from the study of chromatographic forms of tRNA in *su(s)* homozygotes. In particular, it was found that *su(s)/su(s)* flies were missing one of the three chromatographic forms of tyrosine tRNA. Analysis showed that the second peak could not be resolved in reverse phase chromatography (RPC) columns. The first peak was increased in size to the extent that wild type and *su(s)/su(s)* flies had the same amount of tyrosine tRNA. Three other tRNA species (from *su(s)* homozygotes) examined by Twardzik et al. (1971) showed no change in their RPC column profiles.

The pigment mutants that *su(s)* homozygotes were found to suppress include specific alleles of sable, speck, purple and vermilion. Twardzik et al. (1971) concentrated on vermilion where the defective enzyme was known to be tryptophan pyrrolase. The vermilion mutation (*v*) produces a bright scarlet eye color due to lack of brown ommochrome. Rizki (1963) showed the defect was due to the absence of tryptophan pyrrolase activity in *v/v* flies. It was also reported by Green (1949) that non-protein tryptophan accumulated in vermilion flies. Suppression of vermilion by *su(s)* was first noted by Schultz and Bridges (1932).

Twardzik et al. (1971) noted that non-protein tryptophan levels were reduced in *v/v; su(s)/su(s)* flies. In addition, most of the vermilion alleles discovered after the original were found not to be suppressible by *su(s)*. This suggested that the *su(s)* locus might

indeed be some sort of tRNA suppressor as you would expect few vermilion mutants to contain codons changed in such a manner as to be recognized by the altered tyrosine tRNA. That is, by analogy to classical nonsense suppressors in bacteria, putative suppressors in *Drosophila* might also be expected to be allele specific, but gene non-specific (Garen, 1968).

However, it was correctly noted that the *su(s)* mutation could not be a standard suppressor like those characterized in *E. coli*. The *su(s)* mutation affects one-half of the tyrosine tRNA; if one-half of these tRNA's now regularly recognized nonsense (or missense) codons this undoubtedly would be lethal. Also the mutation is recessive and, therefore, probably not in a gene for tyrosine tRNA. It was thought likely to be a gene coding for a particular tRNA modification enzyme.

Based on this assumption the authors proposed that as a result of tRNA undermodification, tyrosine tRNA₂ (that peak missing in *su(s)/su(s)* flies) chromatographs to the tyrosine tRNA₁ location. Further they postulated that this undermodification (possibly methylation) results in ambiguous codon response and inserts tyrosine in response to nonsense (or missense) codons.

So it seemed, in 1971, that a mutation which led to changes in the chromatographic pattern of tyrosine tRNA (a tRNA species likely to give rise to suppressor tRNA) suppressed several pigment mutations. It became widely accepted that a suppressor tRNA would generally be derived by mutation in a tRNA gene most probably coding for a minor species, of any particular tRNA. Consistent with this idea, if a unique tRNA gene was mutated to a suppressor form this could be a haplolethal as is seen for SupRL1, an amber suppressor, in yeast

(Olson et al., 1981).

The controversy about *su(s)* was resolved by White et al. (1973), based partially on the findings of Jacobson (1971). White et al. (1973) showed that the *su(s)* locus indeed is involved in nucleotide modification; in particular, the postranscriptional modification of Guanosine to Queuosine. They proposed that the chromatographic changes noted can be accounted for by this modification. This nucleotide modification leads to the loss of tyrosine tRNA₂ from *su(s)/su(s)* flies and that its absence is related to suppression of vermilion. Jacobson (1971) reported that tyrosine tRNA₂ inhibited tryptophan pyrrolase. In the wild type *su(s)⁺* the presence of tyrosine tRNA₂ would block the expression of tryptophan pyrrolase in this vermilion mutant. The absence of tyrosine tRNA₂ in *su(s)* homozygotes allows the production of tryptophan pyrrolase restoring wild type eye color. Thus, the "suppression" of vermilion in *su(s)/su(s)* flies is apparently due to lack of allosteric inhibition of tryptophan pyrrolase and not the misinterpretation of the genetic code by a suppressor tRNA as was originally supposed.

The search for nonsense suppressors in *Drosophila* continued in our laboratory with the ethyl methane sulfonate (EMS) induced production of putative nonsense mutants (Girton et al., 1979) in the xanthine dehydrogenase (XDH) structural gene, which is often referred to as the *rosy* locus. Of the many *rosy* mutants generated, those which showed no XDH activity, interallelic complementation, or immunologically cross reacting material (CRM) to XDH antibodies were designated putative nonsense mutants. These were subsequently used in a screen to detect second site mutations restoring XDH activity.

Rosy would seem an ideal system for the detection of nonsense suppressors for two reasons. It is a nonautonomous gene which means that it need not be expressed in all tissues to produce phenotypic changes. Also, only 1% of wild type activity will restore wild type eye color (Girton et al, 1979). Although, this screen produced revertants it failed to produce any candidates for suppressors as did a similar screen in this laboratory (L. Harris pers. com.) using the first *bona fide* nonsense mutant characterized in *Drosophila* (Kubli et al., 1982). This latter study showed by sequence analysis that an alcohol dehydrogenase (ADH) null mutant allele, null B(nB) carried on the Curly of Oster balancer chromosome (hereafter called CyOn^B), contained an altered codon so that the tryptophan codon in position 234 was changed to a UGA nonsense codon. Further, it has been shown that the ADH protein was foreshortened and that *in vitro* only an opal (not amber or ochre) nonsense suppressor tRNA from yeast would allow completion of the protein (Kubli et al., 1982).

The failure of our screen to detect nonsense suppressors *in vivo* that could restore partial ADH activity to a strain carrying the CyOn^B allele suggested either that such a nonsense suppressor might be lethal or that our screen was not sensitive enough to detect a functional nonsense suppressor when one was present. Because a series of putative *rosy* nonsense alleles were available and later a *bona fide* ADH nonsense mutant too, the demonstrable creation or introduction of a nonsense suppressor became the focus of the suppressor hunt in the laboratory. With the development of the P-element mediated transformation system in *Drosophila* (Rubin and Spradling, 1982; Spradling and Rubin, 1982) a means for the introduction of suppressor

tRNA genes directly into *Drosophila* became available.

Genetic transformation, defined here as the uptake and expression of exogenous DNA by an organism or cell, has proven to be a very useful genetic tool in those organisms in which such a technique is possible. It was demonstrated first in bacteria (Avery et al., 1944), then in mouse cells by McBride and Ozer (1973) where purified metaphase chromosomes from Chinese hamster cells conferred Chinese hamster hypoxanthine phosphoribosyl transferase (HPRT) activity to some mouse clones. Treatment with exogenous DNA has also produced heritable changes in *Drosophila* (Fox and Yoon, 1966 and 1970), *Ephesia* (Nawa and Yamada, 1968), *Petunia* (Hess, 1972) *Neurospora* (Mishra and Tatum, 1973) and yeast (Hinnen et al., 1978). When a technique is demonstrated for the reliable and efficient introduction of defined DNA sequences into a species a myriad of possibilities becomes apparent and that species becomes a more useful tool for science (Hinnen et al., 1978) (Rubin and Spradling, 1982) (Spradling and Rubin, 1982).

Attempts to transform *Drosophila* first by soaking embryos and then by injecting various mutant embryos with wild type DNA by Fox and Yoon (1966, 1970) and Germeraad (1975, 1976) respectively proved to be successful to the extent that at a very low frequency stable alterations at a few loci were demonstrated. The fundamental problem remained the efficient introduction of defined sequences. The solution came from an abstruse branch of *Drosophila* research, that of hybrid dysgenesis.

Hybrid dysgenesis is a condition found in certain interstrain hybrids of *Drosophila melanogaster*. The features of hybrid dysgenesis

include: (i) germ line abnormalities; (ii) high mutation rate; (iii) high rate of male recombination; and (iv) chromosomal instability (Engels and Preston 1980) (Rubin et al., 1983). In P-M hybrid dysgenesis these appear in progeny from a P male with an M female cross, but do not appear in any other matings involving P and M strains. Strains designated as P were found to contain mappable genetic elements (P factors) on all major chromosomes (Engels and Preston, 1980). M strains lack these genetic elements. It was found that these elements determine the cytotype (Bingham et al., 1982) of a strain where cytotype is defined as a property of the cytoplasm or nucleoplasm and is passed through the female line. A P cytotype is broadly defined as immunity from the action of P elements and the M cytotype as the susceptibility to their action.

It is now understood that P-M hybrid dysgenesis arises from the action of P-elements, which are a family of repeated mobile factors ranging in size from .5 to 2.9 kilobases (Spradling and Rubin, 1982). Like bacterial and other eukaryotic transposable elements, P-elements can change chromosomal location and increase in copy number within a strain. They also share the features of other transposable elements in that P-elements have perfect 31 base pair repeats at their termini and generate 8 base pair duplications at the insertion target site (O'Hare and Rubin, 1983). It has also been shown by sequence analysis of reverted P-element induced mutations that P-elements can be precisely excised, thereby restoring the interrupted gene function (O'Hare and Rubin, 1983).

The P-element family members differ from one another in the extent of internal deletions where the parent element is considered to

be the 2.9 kilobase 'P-factor'. The P-factor is thought to encode both a transposase and a repressor function (Spradling and Rubin, 1982). Sequence data show that the P-factor has four open reading frames (Spradling and Rubin, 1982). A simple model to explain hybrid dysgenesis is that in stabilized P strains the repressor function predominates and blocks the action or expression of the transposase so that the P-elements are quiescent. It is when DNA, containing P-factors, is introduced into an M cytotype (sperm from a P male fertilizes an M egg) that the transposase function predominates until a critical number of P-elements is reached and increased repressor activity restores P-element stability (Rubin and Spradling, 1982). It is the activity of the unstable P-elements that gives rise to the characteristic features of hybrid dysgenesis.

It was the transposing ability of the P-factor in an M cytotype that led to the idea that P-elements might provide a system for the transformation of *Drosophila*. If exogenous DNA (P-elements cloned into plasmids) could move into germ tissue then perhaps these plasmids could also be used to carry additional defined DNA, that was cloned within the limits of the P-element, into *Drosophila*.

Spradling and Rubin (1982) first assayed the activity of the P-factor by microinjection of a plasmid bearing a 2.9 kilobase P-element into a strain which contained a defective P-element within the singed locus. This was the singed weak (*sn^w*) strain and it contained no other P-sequences. A high percentage of the injected embryos produced progeny with the (*sn⁺*) normal bristles or (*sn^e*) singed extreme phenotypes. These strains were also shown to have new P-element sequences corresponding to the injected P-element. The explanation proposed was

that the addition of P-factor DNA into a functionally M strain mimics hybrid dysgenesis to the extent that the usually stable defective P-elements within the *sn^w* locus were mobilized by the transposase. function of the introduced P-factor producing the alterations in sing-
ed expression in the progeny of flies where P-factor DNA was effect-
ively introduced. Further, it was found that P-factor DNA entered the
genome by transposition rather than recombination as the bacterial
sequences of the plasmid were not found associated with new genomic
P-factors (Spradling and Rubin, 1982).

The next stage in the development of an efficient *Drosophila* transformation system was the use of the cloned P-factor (pr25.1), the so called helper P-element. This was used to mobilize coinjected defective P-elements which contained within the bounds of the termini a segment of DNA encoding the structural gene for xanthine dehydrogenase (*rosy* locus) inside the P-element.

So, this P-mediated transformation system depends primarily on the introduction of the carrier P vector (an internally deleted P-element with intact termini so that it does not code for but may be acted on by transposase from a helper, intact, P-factor), and the helper P to get into germ tissue primordia. The carrier P vector contains the gene or sequence of interest in the transformation protocol. In *Drosophila melanogaster* there are approximately 90 minutes following fertilization until the formation of the pole cells which are the germ tissue primordia (Bownes, 1975). Prior to pole cell formation injection of a DNA solution into the posterior of an embryo presents the best opportunity for that DNA to be included during pole cell formation and be incorporated into germ cell

chromosomes. Utilizing the protocol described above, Rubin and Spradling (1982) did injections into M cytotype *roby* (XDH-) embryos with the result being the successful transformation of upwards of 30% of the fertile survivors, as measured by the appearance of some *roby*⁺ progeny from injected flies (Rubin and Spradling, 1982). Thirty-six independent transformed lines were created and found to contain one or more *roby*⁺ insertions by *in situ* analysis. Insertions were found on all major chromosome arms as well as in heterochromatin on the 4th chromosome. Histochemical staining and XDH assays of various adult tissues showed, without exception, the normal temporal expression and tissue specificity of XDH expression. Insertions on the X chromosome showed partial dosage compensation and overall the level of XDH production varied from 30 to 130% compared to wild type. No evidence was found for silent *roby*⁺ insertions (Spradling and Rubin, 1983).

Transformation experiments by Scholnick et al. (1983) produced analogous results with the structural gene for dopa decarboxylase (DDC). Transformed lines showed wild type tissue specificity and temporal production of the enzyme. In addition, mRNA from a reintroduced gene co-migrated with wild type DDC mRNA.

Other successful transformations using this system include the structural gene for alcohol dehydrogenase (Goldberg et al., 1983), the chorion gene (Rubin and Spradling, 1982) and DNA from the white locus (Hazelrigg et al., 1984).

The P-element directed transformation of *Drosophila* is obviously efficient and has the advantage that the transformed lines are generally stable and differ from the strain they were made from only

in the position of the inserted gene.

An offshoot of increased interest from studies on hybrid dysgenesis and the cloning of P-elements has been the use of dysgenesis induced mutagenesis (Rubin et al., 1983) in the cloning of structural genes interrupted by insertion of P-elements. Bingham et al. (1981) used a cloned P-element probe to recover clones from a library made from a strain bearing a dysgenesis induced mutation in the white locus. These sequences were subsequently used to identify white gene clones from a wild type *Drosophila* library. Thus, genes can be tentatively identified and cloned via P-element mutagenesis and then be positively identified and delineated by P-element mediated transformation.

The goal of the present research was the introduction of yeast tRNA suppressor genes into *Drosophila*. Initial experiments involved the cloning of the Sup9e (opal) (Hottinger et al., 1982) gene from *S. pombe* and the Sup4-o (ochre) (Goodman et al., 1977) gene from *S. cerevisiae* into a defective P-element vector and their introduction into *rosy* putative nonsense mutants. When a *Drosophila* strain carrying a verified nonsense ADH allele became available it was decided to alter the project to take advantage of this defined mutant. My contribution to this continuing work was the demonstrable introduction, via P-element directed transformation, of an appropriate suppressor tRNA gene from yeast into *Drosophila* so that eventually questions about the transcription and function of this gene could be addressed.

This research evolved through three sections or stages. First, the demonstration that the Rubin and Spradling procedure for P-element

mediated transformation works in our hands by a repetition of their *rosy* transformation experiment. Next, an attempt to demonstrate the *in vivo* suppressor function of yeast suppressors Sup9e and Sup4-o by their introduction into *Drosophila* embryos containing putative *rosy* nonsense mutants. The final step was the verified introduction of a serine inserting UGA tRNA suppressor gene from *S. pombe* (Hottinger et al., 1982) along with a wild type *rosy* gene so that further work could be done on heterologous tRNA suppressor gene expression *in vivo*, in *Drosophila*.

MATERIALS AND METHODS

A. *Drosophila* Culturing

All fly stocks were maintained on a synthetic medium (Nash and Bell, 1968) at 22°C or as indicated below.

B. *Drosophila melanogaster* Stock List

<u>Strain</u>	<u>Description</u>	<u>Source</u>
<i>y sn^w;bw;st('M')</i>	yellow, signed weak, brown scarlet, M cytotype, (hereafter <i>sn^w</i>)	W. Engels
<i>b cn; ry^{a1} e</i>	black, cinnabar, rosy, ebony (referred to in text as <i>ry^{a1}</i>)	J. B. Bell
<i>b cn; ry⁸</i>	(referred to in text as <i>ry⁸</i>)	J. B. Bell
<i>b cn; ry²⁶ e</i>		J. B. Bell
<i>b cn; ry⁶⁰³ e</i>		J. B. Bell
<i>ry^{77j}</i>		M. Green
<i>Adh fn⁵ pr cn/CyOnB pr cn</i>	Alcohol Dehydrogenase fast null 5, purple, cinnabar Curly derivative of Oster In(2LR)0, <i>dpl^vIvy pr cn²</i> , carries <i>Adh null B (nB)</i> designated as <i>CyOnB</i> in text.	W. Sofer
<i>π2p (P)</i>	P cytotype	W. Engels
<i>C(1)DX; ry</i>	Compound 1 Double X; <i>ry</i>	J. B. Bell
<i>SM5 /Sp; ry</i>	In (2LR)SM5, <i>a1² Cy 1t^v cn² Sp²; ry</i>	J. B. Bell
	Sternopleuro1	
<i>MKRS</i>	<i>M(3) s(34) kar ry² Sb/kar² Df(3)ry⁷⁵</i>	J. B. Bell

Genotype designations and original references are given as in Lindsley and Grell 1967.

C. Cytotype Determination

To determine the cytotype of a *Drosophila* strain we used the following procedure (Engels and Preston, 1980). Five parents from the strains to be tested and a known tester were placed together in vials and kept at 29°C for 7 days and then discarded. Progeny that emerged during the 4 following days were transferred to vials at 25°C to allow matings to occur. After 4 days the females were removed, placed individually in separate vials and subsequently scored for gonadal sterility based on egg production.

Strains *b cn; ry^{al} e (ry^{al})* and *b cn; ry⁸ (ry⁸)* were crossed reciprocally to $\pi 2p$, a P cytotype strain and *y sn^w; bw; et (sn^w)*, an M cytotype strain under the conditions described above. Both of the *ry* strains tested were designated M as sterility was not seen when males were crossed to $\pi 2p$ females, whereas sterility did result from the reciprocal cross. Crosses of *ry^{al}* and *ry⁸* to the *sn^w* strain did not produce sterile females, as would be expected when M strains are crossed to each other.

D. Linkage Analysis

To determine genetically into which chromosome the P-elements carrying *rosy⁺* had integrated, the crosses outlined in Figures 1, 2, and 3 were performed. All strains were *rosy⁻* at the resident XDH locus, so that assignment of the introduced *rosy⁺* gene could be made on the basis of segregation of the *ry⁺* phenotype from the dominant markers *Cy* and *Sb* for Chromosome 2 or 3 respectively, or from markers on an attached X-chromosome.

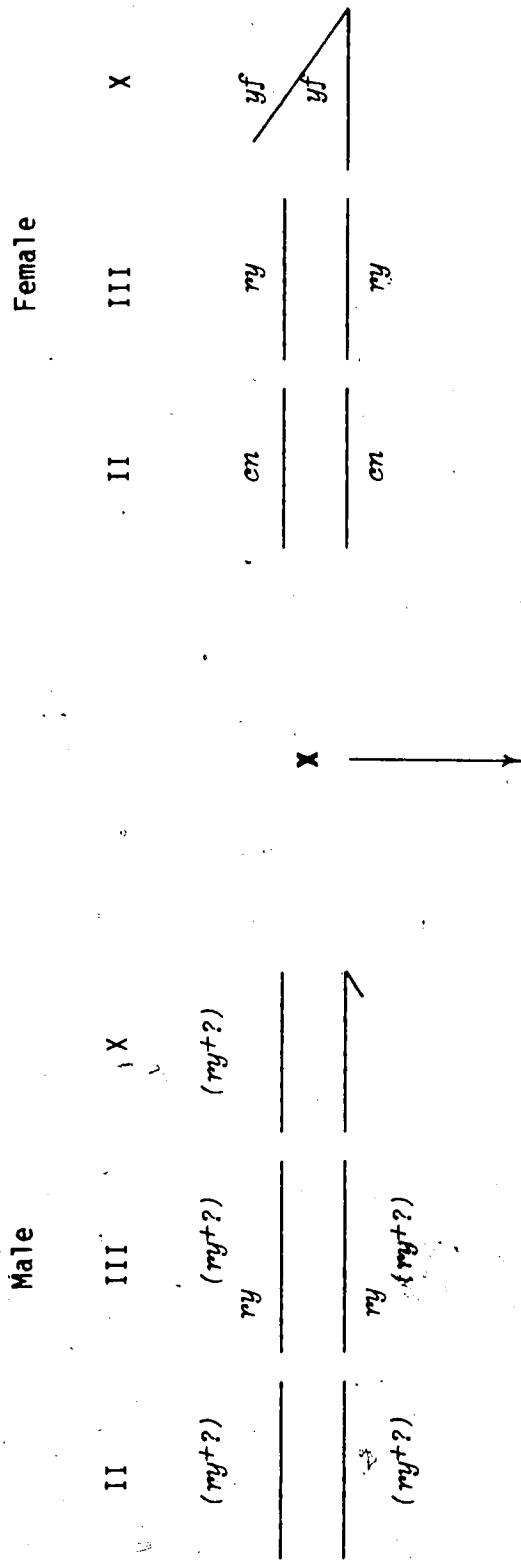

Figure 1: X Chromosome Linkage Analysis of *Roby* Transformants. Males from each of the transformed lines were crossed to virgin females of the XX; *cn;ry* stock. If the transposon is on the X chromosome, then only male progeny will be *ry+*.

CROSS #1



If *myt* resides on the X-chromosome, then the F1 males will all be *myt*.

If *myt* is on chromosome II or III, then expect both males and females F1's to show the *myt* phenotype.

Figure 2: Second Chromosome Linkage Analysis of *Roby* Transformants.

Virgin females from each of the transformed lines were crossed to SM5 *Cy/Sp; my* males. SM5 is a second chromosome balancer strain, with the dominant markers *Sp* and *Cy*, and homozygous for *my* so that the *my⁺* can be detected. From the above cross *Cy my⁺* virgin females were selected and crossed to *b^{cn}; my^{a1} e* males. If the *my⁺* transposon resides on the second chromosome then the *my⁺* progeny should not appear with the *Cy* phenotype.

CROSS #2

Male

II III X

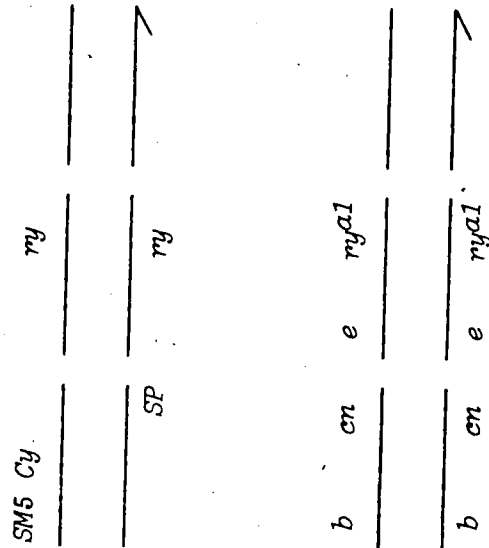

X →

X →

Female

II III X

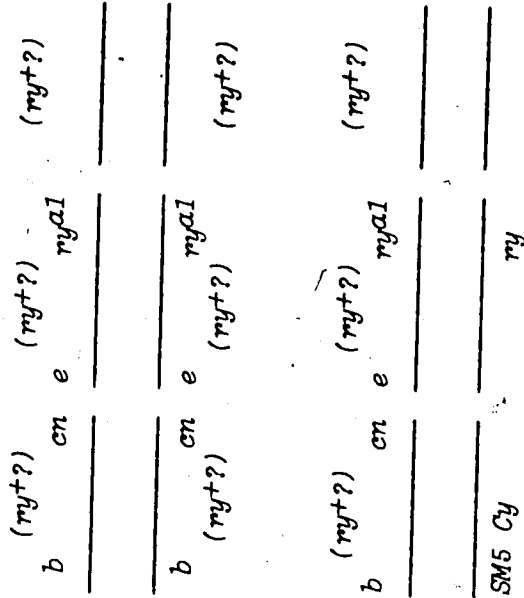

If the *ry^t* transposon resides elsewhere, expect *ry^t* to appear with both the *Cy* and *Cy^t* phenotypes.

If *ry^t* transposon resides on the second chromosome, expect the *ry^t* phenotype not to appear with the *Cy* phenotype.

Figure 3: Third Chromosome Linkage Analysis of *Rosy* Transformants.

Virgin females from each of the transformed lines were crossed to males of the MKRS strain. MKRS is a third chromosome balancer and carries the dominant *Sb* marker on the third chromosome, and is homozygous for *ry*. F₁ *Sb ry*⁺ males were crossed to *b cn; ry^{al} e* virgin females. If the *ry*⁺ transposon resides on the third chromosome then *ry*⁺ progeny should not carry the *Sb* marker.

CROSS #3

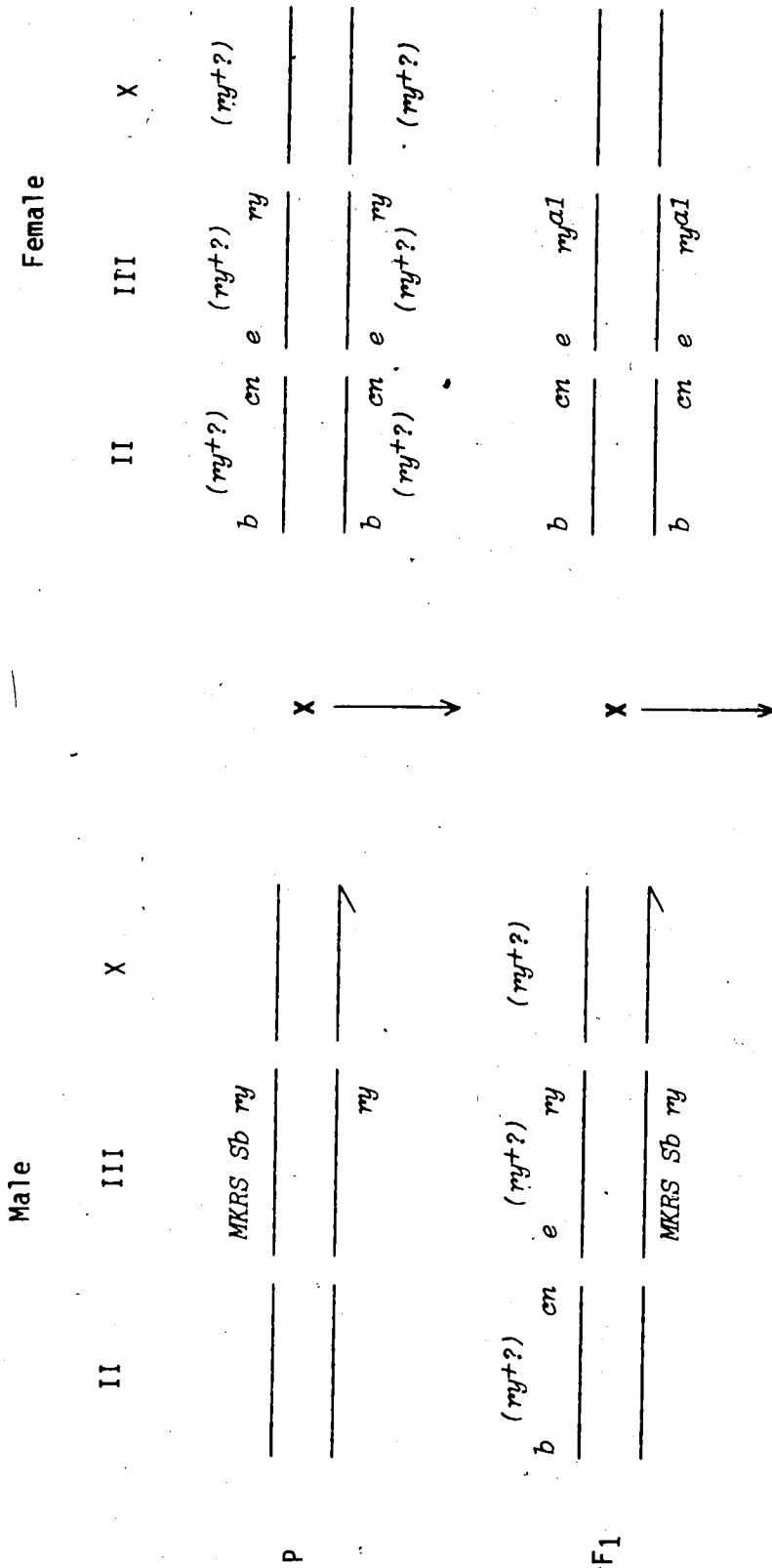

If the *ryt*⁺ transposon resides on the third chromosome, then one expects that progeny with the *ryt*⁺ phenotype will not also have the *Sb* phenotype.

If the *ryt*⁺ transposon is elsewhere, then one expects progeny that are *ryt*⁺*Sb* and also *ryt*⁺*Sb*^t.

Briefly, if the insertion is on the X chromosome, then all XY progeny will be *roby*⁺ (as outlined in cross 1). If the insertion is on the second chromosome, *roby*⁺ *Curly* flies would not be expected in the progeny of cross 2. If on the third chromosome, flies with a *roby*⁺ *Stubble* phenotype would not be expected. Assignment to chromosome 4 would be implicated by elimination of clear linkage data to the other three chromosomes.

E. Growth Media

The media used for growing all bacterial strains was Luria broth (LB). Liquid media consists of 10 g/l Bacto-tryptone, 10 g/l NaCl, and 5 g/l Bacto-yeast extract. Plates were made of LB plus 15 g/l Bacto-agar. For selection of ampicillin resistance, 50 mg/l ampicillin was added after autoclaving.

F. Transformation of *Drosophila*

I Preparation of DNA for Injection

The DNA for injection was precipitated in 2.5 volumes of ethanol for 1 hour at -70°C and, after centrifugation at 10,000 RPM for 10 minutes the DNA was resuspended in approximately 10 μ l of sterile injection buffer (5mM KCl and 0.1mM Na phosphate, pH 6.8). The concentration of the DNA was determined spectrophotometrically (A_{260}) and adjusted to the desired concentration, usually 300 μ g/ml for plasmids bearing a defective P-element and cloned genes of interest and 100 μ g/ml for plasmid p π 25.1, the helper P.

II Preparation of Needles for Microinjection

Needles were prepared by pulling *Kimax* 25 μ l glass capillary tubes which were heated over a bunsen burner. The elongated capillary tubes were then fitted onto a microforge (Aloe Scientific) and further drawn out to approximately 5 microns. To fill the needle, approximately 1 to 2 μ l of the DNA injection mixture was delivered into the needle through a drawn capillary and the needle fitted onto the oil filled injection system (Leitz). The needle was brought into focus and the DNA solution forced down through the needle by increasing the pressure of the oil filled injection system with the syringe. The tip of the needle was often too fine and needed to be broken back by forcing it into a piece of double stick tape (under oil).

III Collection and Preparation of Embryos for Injection

Embryos were collected from healthy young flies that had been fed on yeast for at least 3 days prior to collection. Stocks for collection were changed frequently and kept uncrowded to minimize egg retention. Flies were allowed to lay eggs for up to 1 hour on 1.5% agar plates that were lightly yeasted. Embryos were collected by rinsing them off the plates onto a fine nylon (Nitex) mesh filter. Excess water was removed and the embryos transferred to doublestick tape on a microscope slide. The embryos were dechorionated by rolling them on the tape and moved so that the posterior end protruded over the edge of the tape. The embryos were then dried over a desiccating silica gel for 6-15 min., and then covered with halocarbon oil (Halocarbon).

IV Injection of Embryos

The slides were placed on the microscope stage and the needle brought into alignment. The needle mounted on a Leitz micromanipulator is introduced into the embryo's posterior, often piercing halfway through, and then quickly moved to the very posterior. By increasing the pressure of the oil filling injection system the DNA solution (8-10 picolitres) can be seen flowing in. The injection was stopped when the desiccation-induced dimples in the embryo filled out due to the injected liquid.

Completed slides were placed in a slide storage box at 18°C. with damp paper towels to ensure high humidity. After 36 hours, the slides were examined every 6 - 12 hours and newly emerged first instar larvae were transferred to standard media vials at 25°C.

Emerging flies, from injected embryos, (hereinafter called G₀'s) were checked for evidence of injected gene expression and were individually crossed to uninjected flies of the same genotype. Crosses were kept at 25°C and the parents transferred to new vials every four days to maximize fecundity. Offspring (G₁'s) were examined for evidence of transformation and records were kept of the number of transformed and untransformed flies each cross produced.

Transformed flies (G₁'s) were crossed with transformed siblings and pairs of their transformed progeny (15-20 pairs) were

examined for two generations so that stocks could be made, from progeny of pair matings, that showed stability of the transformed character. Further testing was done on lines established from pair matings that were the most stable for the transformed character.

G. Transformation of *E. coli* HB101 with Plasmid DNA

Introduction of plasmid DNA into *E. coli* strain HB101 was accomplished following the calcium chloride procedure of Maniatis et al. (1982). A 1/30 dilution of an overnight 5 ml culture of HB101 was made into LB, grown at 37°C with shaking for 2 to 4 hours, then chilled on ice for 10 minutes.

The cells were harvested and resuspended in 1/2 of the original volume in ice cold, sterile 50mM CaCl₂, 10mM Tris-Cl (pH 8.0), put on ice for 15 minutes, resedimented, and brought up in 1/15 volume of 50mM CaCl₂, 10mM Tris-Cl (pH 8.0).

Cells were kept at 4°C for 12 to 24 hours before 1 to 20 ul of the DNA solution was added to 0.2 ml of the treated cells. This mixture was kept on ice for 30 minutes and heat shocked at 42°C for 2 minutes. After the addition of 1 ml of LB the culture was kept at 37°C for 1 hour. Dilutions were plated on LB + Amp plates that were incubated at 37°C for 12 to 24 hours.

H. Preparation of Plasmid DNA

The following procedure for plasmid DNA extraction is from Maniatis et al. (1982).

To 25 ml LB + ampicillin 0.1 ml of a saturated 5 ml overnight

culture was added and grown at 37°C until the optical density at 600 nanometers was approximately 0.6. This was used to inoculate 500 ml LB + ampicillin which was grown with shaking for 2.5 hours at 37°C, at which time 2.5 ml of a 34 mg/ml chloramphenicol solution (in 95% ethanol) was added; incubation with vigorous shaking was continued for another 12 to 16 hours.

The cells were harvested by centrifugation and washed in 100 ml of ice cold STE, 100mM NaCl, 10mM Tris-Cl (pH 8.0), and 1mM EDTA. The cells were reharvested and suspended in 10 ml ice cold STE and transferred to a 50-ml Erlenmeyer flask. After the addition of 1.0 ml of a lysozyme solution (20 mg/ml in 10mM Tris-Cl pH 8.0), the solution was slowly brought to boiling and then immersed in a 2-litre beaker of boiling water for 40 seconds. The now viscous lysate was transferred to a SS-34 centrifuge tube, kept on ice for 5 minutes, then centrifuged at 19,000 rpm for 1 hour. For each ml of cleared lysate, 1 gram of CsCl₂ was added. Ethidium bromide was added to a concentration of 0.8^o ug/ml and the solution centrifuged at 54,000 rpm in a VTi65 rotor for 8 to 10 hours. The plasmid band was collected from 2 or 3 tubes and after the addition of a quantity of 1 gm/ml CsCl₂ the solution was centrifuged again at 54,000 rpm for 6 to 8 hours. The ethidium bromide was removed by extraction with CsCl₂ and water saturated n-butanol, and the CsCl₂ was removed by dialysis against 3 changes of TE (10 mM Tris-Cl pH 8.0, 1 mM EDTA). The DNA was stored in TE at 4°C.

I. Rapid Extraction of Plasmid DNA

Rapid small scale isolation of plasmid DNA for size or restriction

analysis was done according to Maniatis et al. (1982). A 1.5 ml volume of a saturated culture was centrifuged for 1 minute in an Eppendorf microfuge and the pellet resuspended in 0.35 ml of 8% sucrose, 5% Triton X-100, 50mM EDTA (pH 8.0), 10mM Tris-Cl (pH 8.0). After the addition of 25 ul of a lysozyme solution (20 mg/ml in 10mM Tris-Cl, pH 8.0) the tubes were held in a boiling water bath for 40 seconds, then recentrifuged for 10 minutes. The pellet was removed and 40 ul 2.5 M sodium acetate and 420 ul of isopropanol were added to the aqueous portion and put at -70°C for 15 minutes. The solution was centrifuged 15 minutes at 4°C and the dried pellet resuspended in 50 ul TE.

J. Genomic DNA Extraction from *Drosophila*

DNA was extracted according to Ish-Horowicz et al. (1979). Between 80 to 200 mg of adult *Drosophila* were homogenized in 1.5 to 3 ml of 10mM Tris-Cl (pH 7.5), 60mM NaCl, 10mM EDTA, .15mM spermine, .15mM spermidine and .2 mg/ml protease (Pronase E Sigma, preincubated 1 hour at 37°C) in a 5 ml tissue homogenizer. The homogenate was added to 1.5 to 3 ml of .2M Tris-Cl (pH 9.0) 30mM EDTA, 2% SDS and 0.2 mg/ml protease and incubated for 1 hour at 37°C. The homogenate was then extracted twice with an equal volume of phenol and once with chloroform: isoamyl alcohol (24:1 v/v). The aqueous phase was made .2M for NaCl and two volumes of 95% ethanol were layered on. The DNA was spooled out and resuspended in TE buffer.

K. DNA Restriction

Specific DNA fragments were excised from plasmids using sequence

specific restriction enzyme cleavage (Cohen et al., 1973). Reactions were carried out following the restriction enzyme manufacturer's specifications. Restrictions were incubated at 37°C for 2 to 4 hours after which 5 ul of a dye solution (50% (v/v) glycerol, 0.15% (w/v) BPB and 0.15% (w/v) xylene cyanol) was added. The samples were either electrophoresed immediately or frozen at -20°C for later use.

L. DNA Agarose Gel Electrophoresis

Restriction enzyme digests were analyzed by agarose gel electrophoresis (Cohen et al, 1973; Thomas and Davis, 1974). A solution of 1% (w/v) agarose (Sigma type II, medium EEO) in TAE (50mM Tris-acetate pH 8.3, 2mM EDTA (Na)₄) was melted and cast in a horizontal slab gel electrophoresis apparatus (Tyler Research Corp.). Analytical gels were cast with 13 slots; preparative gels with a comb containing 2 large slots and 1 reference slot. Typically, gels were run at 80 volts for 3-6 hours. The DNA was visualized on a long wave UV trans-illuminator after staining the gels with a solution containing 0.5 ug/ml ethidium bromide. Photographs were taken using a Polaroid MP4 camera with Polaroid type 57 film and a Kodak Wratten #9 gelatin filter.

M. Purification of Restriction Fragments from Agarose Gels

Restriction fragment purification was done by extraction from low temperature gelling agarose (Sigma) according to Maniatis et al. (1982). Alternatively, the melted agarose in 20mM Tris-Cl (pH 8.0) was passed over an Elutip-d column (Schleicher and Schuell) following the manufacturer's specifications. Gels of 0.8 to 1.0% were cast and

run at 4°C with ethidium bromide (3 μ l of 10 mg/ml solution per gel) added.

N. Ligations of DNA with T4 Ligase

Purified DNA samples were mixed in a 3-5:1 molar ratio (insert ends to vector ends) in 20-100 μ l of T4 DNA ligase reaction buffer which is 50mM Tris HCl (pH 7.8), 10mM MgCl₂, 2mM dithiothreitol, 1mM adenosine triphosphate, 2mM spermidine, and 50 μ g/ml bovine serum albumin. After addition of 0.1 to 1.0 unit of T4 DNA ligase the mixture was incubated for 12 to 20 hours at 15°C.

O. Southern Hybridization

Southern hybridization was done according to Maniatis et al. (1982) with the following alterations: (i) the prehybridization fluid was made 50% v/v with formamide; (ii) prehybridization temperature was 42°C; (iii) the hybridization fluid was made 50% v/v with formamide; and (iv) the hybridization temperature was 42°C.

P. Radioactive Labelling of DNA Probes by Nick Translation

Radioactivity was incorporated into purified DNA as described by Davis et al. (1980) with some modifications. Reactions of 50 μ l final volume contained 1 μ g DNA, 50mM Tris-HCl (pH 7.2), 10mM MgSO₄, 0.2mM DTT, 50 μ g/ml BSA (nuclease free), 0.02mM dATP, dGTP, dTTP, 10 μ l ³²P-dCTP (3000 Ci/mole, 10mCi/ml in Tricine, New England Nuclear), or ³H-TTP, 10 units of *E. coli* polymerase I, and 0.25 ng activated calf thymus DNase I. The reaction was carried out at 14°C for 1 hour, then stopped by the addition of 1 volume of stop solution (20mM EDTA, 2 mg/ml sonicated calf thymus DNA, and 0.2% (w/v) SDS. This was

loaded onto a 2 ml Sephadex G-50 pasteur pipette column equilibrated with TE. The initial peak of radioactivity was collected in a volume of 1.2 to 1.5 ml. The specific activity of the labelled DNA was determined by counting a 10 μ l aliquot in 5 ml of fluor or distilled water in a Beckman LS7500 liquid scintillation counter.

Q. *In Situ* Hybridization to Salivary Gland Chromosomes

The dissection of salivary glands was done in 45% acetic acid, then they were transferred to a gelatin treated slide and squashed under a siliconized cover glass (Corning #2). After freezing in liquid nitrogen the cover glass was removed and the slide washed once for 1 minute in 3:1 ethanol:acetic acid, and 5 minutes in 95% ethanol (two washes). After the slides had dried they were placed in 2xSSC for 30 minutes at 65°C, twice rinsed in 70% ethanol for 5 minutes at room temperature, followed by a 5 minute rinse in 95% ethanol. After drying the slides were incubated in .1 mg/ml ribonuclease (Sigma Ribonuclease A) in 0.3M sodium chloride, 0.03M sodium nitrate (pH 7.0) at 37°C for 1 hour, then rinsed in 2xSSC three times for 5 minutes (each) at room temperature and air dried. To denature the DNA the slides are put in 0.07 N sodium hydroxide for 3 minutes at room temperature, rinsed three times in 70% ethanol and twice in 95% ethanol (5 minutes each at room temperature). The hybridization buffer (5 ml) was made from 0.5 ml 20x Denhart's solution, 1.0 ml 50% dextran sulphate, 0.66 ml 5M sodium chloride, 0.1 ml $MgCl_2$, 1.0 ml sodium phosphate buffer (pH 7.0) and 1.74 ml water. Nick translated probe DNA (approximately 3×10^4 cpm/microlitre) was mixed with sonicated salmon sperm DNA (final concentration of carrier/probe is 0.2 μ g/

ul) and heated to 95°C for 5 minutes, then put on ice. An equal volume of hybridization mixture was added to the chilled probe/carrier and 20 ul spotted over the tissue on the prepared slides and covered with a cover glass. The slides were placed in a moist sealed chamber and submerged in a 65°C waterbath for 4 hours. After this the cover glass was removed and the slides rinsed three times in 2xSSC at room temperature (15 minutes each with gentle agitation), then twice for 15 minutes in 2xSSC at room temperature, once in 70% ethanol (5 minutes at room temperature) and twice in 95% ethanol (for 5 minutes each at room temperature). Finally, the slides were dipped in autoradiographic emulsion (Kodak NTB2), stored for one week in a sealed slide box at 4°C, then developed and visualized.

R. Autoradiography

Images of hybridizations from Southern blots were obtained using Kodak XAR-5 film in Picker X-ray cassettes. After exposure the film was developed using Kodak X-ray developer and Kodak Rapid Fixer according to manufacturers instructions.

S. Xanthine Dehydrogenase Assays

This fluorometric assay (Glassman, 1962) is based on the difference in fluorescence of isoxanthopterin (IXP) and 2-amino-4-hydroxypterine (AHP) and the fact that XDH catalyzes the conversion of AHP to IXP.

Strains to be tested were homogenized in 1.0M Tris-Cl pH 8.0, 2.5mM EDTA, and 1.0mM dithiothreitol (DTT) in a ratio of 100 mg flies/ml buffer. To the extract 1.0 mg of untreated activated

charcoal (Norite) was added for every 4.0 mg of flies. The mixture was stirred then centrifuged in an Eppendorf microcentrifuge for 10 minutes. The supernatant was filtered through glass wool and recentrifuged.

Assays were carried out in an Aminco-Bowman spectrofluorometer with an activation wavelength of 338 nm and a fluorescent wavelength of 405 nm. AHP shows minimal fluorescence at these wavelengths, while IXP has its peak fluorescence at 338 nm.

For crude extracts 0.5 ml of the fly homogenate and 0.48 ml of the Tris-Cl buffer were warmed for 5 minutes at 30°C in a temp-block heater (Scientific Products). After warming, 10 µl of NAD (1.0 mg/0.5 ml in the Tris-Cl buffer) and 10-30 µl AHP (0.33mM in 1N NaOH) were added to the reaction mixture. After mixing the cuvette was placed in the fluorometer and the change in percent transmission recorded on a Beckman chart recorder for 3-5 minutes.

T. Alcohol Dehydrogenase (ADH) Assays

Single flies were crushed on to squares of Whatman filter paper wetted with 100 µl Tris-phosphate (pH 8.6) in a large multi-welled micro titre dish. Samples were incubated 30 minutes at 25°C in the dark after the addition of 250 µl of the staining mixture. The staining mixture described by Grell et al. (1968) consists of 90 ml 0.05M Tris-phosphate (pH 8.6), 4 ml NAD (10 mg/ml), 4 ml phenazine methosulfate (0.2 mg/ml), 2 ml nitro blue tetrazolium (NBT) (10 mg/ml), and 0.75 ml 2-butanol. A deep blue color indicates ADH activity.

Alternatively, ADH activity was measured spectrophotometrically (Hubby, 1963) by monitoring the rate of increase in the amount of reduced nicotinamide adenine dinucleotide (NADH) at 340 nm after the

addition of 2-Butanol and NAD (Sigma). The assay mixture consisted of 0.1 to 0.5 ml crude fly extract, 0.6 ml of 0.15M $\text{Na}_2\text{HPO}_4/\text{KH}_2\text{PO}_4$ buffer (pH 8.3), 0.1 ml NAD solution (10 mg/ml), and 0.05 ml 2-Butanol. Assays were carried out at 22°C in a Perkin Model 559A recording spectrophotometer, altering the ordinate maximum for greater sensitivity when low levels of ADH activity were expected.

RESULTS

A. Cytotype Determination

As a prelude to transformation, the cytotype of the *rosy* strains had to be ascertained, so as to determine whether co-injection of the P-factor (p π 25.1) would be required. Rubin and Spradling (1982) outlined procedures for the transformation of both P and M strains. Briefly, P strain host embryos must be produced from a dysgenic cross so that introduced P-elements can be transposed by endogenous P-factor transposase. Injections into an M cytotype strain require the cloned helper P-element, p π 25.1, to provide the transposase activity since the gene of interest is introduced via a defective (carrier) P-element. Crosses of strain *b cn; roya1 e* were made reciprocally to P and M strains under conditions (see Materials and Methods) to test gonadal dysgenesis. This experiment showed that when *ry β* and *roya1* were crossed as females to known P strain males the females progeny were sterile; whereas the reciprocal cross produced fertile females. These results suggested that *roya1* and *ry β* had an M cytotype and so, presumably, did all the strains carrying putative nonsense *ry* alleles derived from a common Oregon-R stock although the other *rosy* mutants were not tested. *In situ* and Southern hybridization analysis later confirmed, by the absence of P sequences anywhere in the *ry β* genome, that this strain was indeed M.

B. Injections with p π 25.1

The first series of injections was done using the embryos from the *y sn ω ;bw;st* M strain obtained from Engels. This *sn ω* mutation was

the *y sn^w;bw;st* *M* strain obtained from Engels. This *sn^w* mutation was caused by the insertion of a defective P-element within the singed locus, and Spradling and Rubin (1982) had shown that by injecting the intact or helper P-element (p 25.1) into this strain, some of the injected (*G*₀) flies' progeny (*G*₁'s) showed new singed phenotypes; normal bristles (*sn⁺*) and singed extreme (*sn^e*).

The rationale to repeat these experiments was to show that: first, the preparation of p π 25.1 displayed this activity; and, second, to become familiar with the technical difficulties of the procedure. The injection protocol is basically as described in the Materials and Methods section. The concentration of the injected p π 25.1 solution was 150 ug/ml.

Of 285 prepared embryos of the *y sn^w;bw;st* genotype, approximately eighty-five survived injection. The remainder were either past pole cell formation or burst or leaked when injected. Of these eighty-five, fifteen hatched as first instar larvae and three became fertile adults. These were mated to uninjected *y sn^w;bw;st* cytotype flies and their progeny scored with regard to bristle phenotype. Of the three fertile adults, one gave one *sn⁺* progeny, the rest of the progeny were all *sn^w*.

C. Transformation Experiments using p π 25.1 and pRy1

The next major experiment involved repeating the Rubin and Spradling transformation experiments using their plasmids p π 25.1 and pRy1. The plasmid p π 25.1 carries the intact P factor and pRy1 holds the defective P-element into which the XDH structural gene has been cloned. These were injected, as described in the Materials and

Methods, at concentrations of 100 and 300 ug/ml respectively into embryos from five different *rosy* putative nonsense strains.

Of the five different host strains that were injected, four gave some G_0 *rosy*⁺ flies; although only two strains, *b cn; roya1* and *b cn; roy^β* gave stable G_1 transformants.

Table 1 gives the data on this series of experiments, and Tables 2 and 3 provide more extensive data on the successful transformation of *roya1* and *roy^β*.

I Levels of XDH Activity in Transformed Lines

An equal number (100) of five-day-old flies from each transformed line were prepared and assayed for XDH activity as described in the Materials and Methods. Compared with Oregon R, the strain from which the *roya1* and *roy^β* mutants were derived, the transformed lines showed XDH activity ranging from about one-half (53%) to almost wild type (92%) levels (Figure 4).

II Linkage Group Determination of Integrated *Rosy*⁺ Genes

Mapping crosses were carried out as described in the Materials and Methods (Figures 1, 2 and 3), and the data are given in Tables 4 and 5.

Transformed lines T8 and Q7 apparently have *rosy*⁺ inserts on the second chromosome based on genetic analysis. Line T3 initially gave inconclusive mapping data, however, after backcrosses to *roya1* the *rosy* insert mapped clearly to the third chromosome. *In situ* hybridization with a *rosy* gene probe (pdm2837; described later) showed that this line originally had two *rosy* inserts (Figure 5), at position 3A on the X and 82 on the third chromosome. Line T4 gave results which did not clearly implicate

TABLE 1. Transformation Experiments with Helper Vector p α 25.1 and pRy1

Recipient Strain	# Embryos Injected	# 1st Instars	# Adults	# G ₀ ry ⁺	# G ₁ ry ⁺
<i>b cn; ry^{a1} e</i>	256	53	16	*	*
<i>b cn; ry⁶⁰³ e</i>	114	21	5	0	0
<i>b cn; ry²⁶ e</i>	40	9	4	2	0
<i>b cn; ry⁸</i>	170	63	20	**	**
<i>ry^{77j}</i>	84	24	4	2	0

*see Table 2

**see Table 3

TABLE 2. Injection Series of *b cn; ry^{al} e*
300 ug/ml pRy1; 100 ug/ml pπ25.1

G ₀ Adult	Sex	Fertile	G ₀ Transformed	# G ₁ Offspring	# <i>ry</i>	# <i>ry</i> ⁺
T1	F	+	no	36	36	0
T3	F	+	no	49	32	17
T4	F	+	yes	170	167	3
T5	M	+	no	163	163	0
T6	F	+	no	137	137	0
T7	F	+	no	69	69	0
T8	M	+	no	266	194	72
T9	M	+	no	175	175	0
T10	M	+	no	275	275	0
T11	F	+	yes	190	190	0
T14	F	+	no	49	49	0
T15	F	+	no	11	11	0
T16	F	+	no	159	159	0

TABLE 3. Injection Series of *ben;ry⁸*
 300 ug/ml pRy1; 100 ug/ml p π 25.1

G ₀ Adult	Sex	Fertile	G ₀ Transformed	# G ₁ Offspring	# <i>ry</i>	# <i>ry</i> ⁺
Q1	M	+	no	60	60	0
Q2	F	-	no			
Q3	M	+	yes	125	125	0
Q4	F	+	no	108	108	0
Q5	F	+	no	81	81	0
Q6	M	+	no	97	97	0
Q7	M	+	no	219	216	3
Q8	M	+	no	129	129	0
Q9	M	-	no			
Q10	F	+	no	87	87	0
Q11	F	+	no	47	47	0
Q12	F	+	no	33	33	0
Q13	F	+	no	59	59	0
Q14	M	+	no	139	139	0
Q15	M	-	yes			
Q16	F	+	no	94	94	0
Q17	F	+	yes	59	59	0
Q18	F	+	yes	24	24	0
Q19	M	-	no			
Q20	M	+	no	27	27	0

Figure 4: XDH Activity of P-Mediated Transformants with the *Rosy⁺* Gene. All strains were assayed as five-day-old adults with Oregon R as the control. The extracts were prepared and assayed as given in Materials and Methods. Each line was tested twice and the average used in calculating the activity as a percent of wild type.

HISTOGRAM
XDH ACTIVITY IN TRANSFORMED LINES

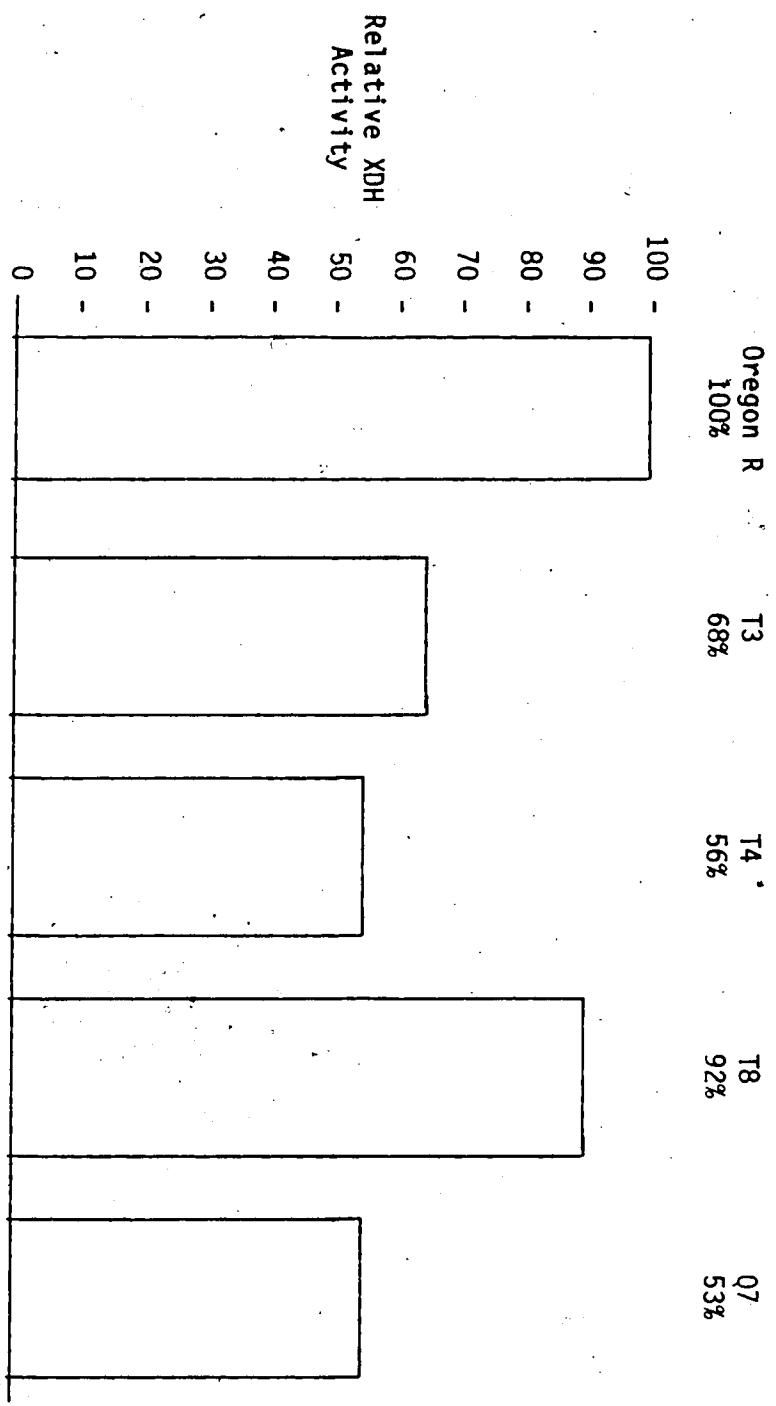

TABLE 4. Linkage Group Determination of XDH Activity* in Transformed Lines

2nd Chromosome Analysis

Transformed Line	Phenotypes			
	<i>ry Cy</i>	<i>ry Cy⁺</i>	<i>ry⁺ Cy</i>	<i>ry⁺ Cy⁺</i>
T3	354	261	293	222
Q7	676	40	12	753
T8	134	0	0	137
T4	294	166	208	276

*as ascertained by *rosy⁺* eye phenotype

TABLE 5. Linkage Group Determination of XDH Activity* in Transformed Lines

3rd Chromosome Analysis

Transformed Lines	Phenotypes			
	<i>ry Sb</i>	<i>ry Sb⁺</i>	<i>ry⁺ Sb</i>	<i>ry⁺ Sb⁺</i>
T3	535	10	6	392
Q7	160	132	116	119
T8	296	200	179	173
T4	503	58	242	434
T4 Sublines from Pair Matings				
T4.1	130	0	0	83
T4.2	82	60	47	45
T4.3	7	16	6	8
T4.4	62	26	2	63
T4.5	85	0	0	60

*as ascertained by *nosy⁺* eye phenotype

Figure 5: *In situ* analysis of T3. *In situ* hybridization, autoradiography and photography were performed as given in the Materials and Methods. Preparations were probed with nick translated pDM2837. Arrowheads indicate areas of hybridization:

1. Hybridization over band 82 on chromosome 3R.
2. Hybridization over band 87, the *rosy* locus on chromosome 3R.
3. Hybridization over band 3 on the X chromosome.

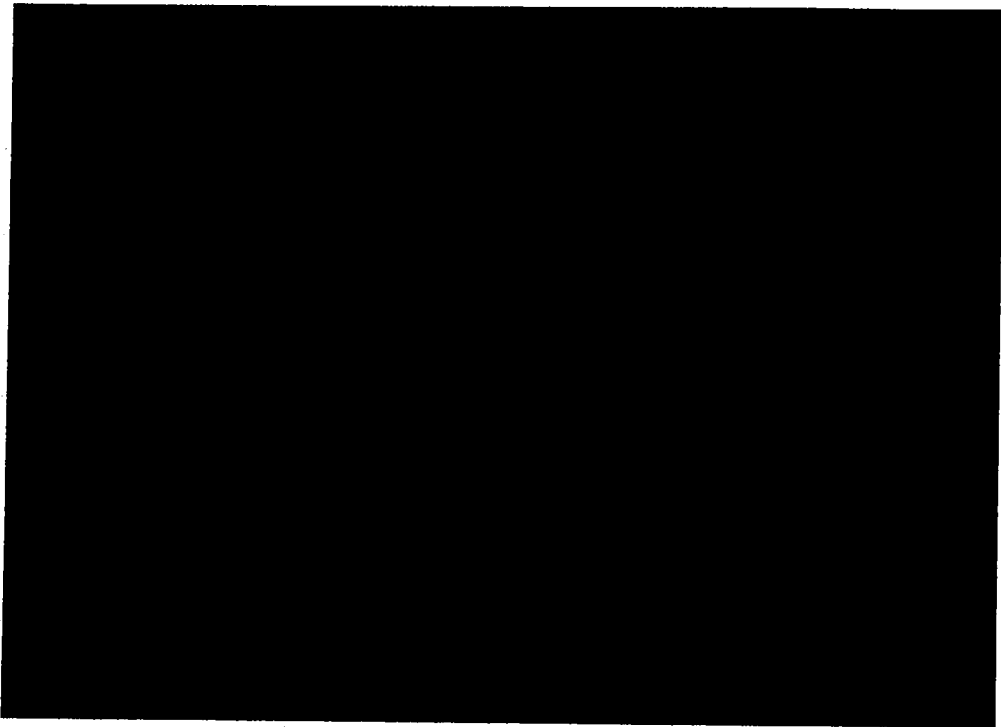

Figure 6A: *In situ* analysis of T4. *In situ* hybridization, autoradiography and photography were performed as given in the Materials and Methods. The preparation was probed with nick translated pDM2837, which contains the *ry⁺* gene cloned in pBR322. Arrowheads indicate areas of hybridization:

1. Hybridization in the centromeric region; Figure 6C shows enlargement from a different nucleus.
2. Hybridization over band 87, the *rosy* locus.
3. Weak hybridization near the tip of 3R, Figure 6B shows an enlargement from a different nucleus.

Figure 6B: *In situ* analysis of T4. Details as above; shows heterozygous *ry⁺* insert near the tip of chromosome 3R.

Figure 6C: *In situ* analysis of T4. Details as above; shows *ry⁺* insert on the fourth chromosome.

A

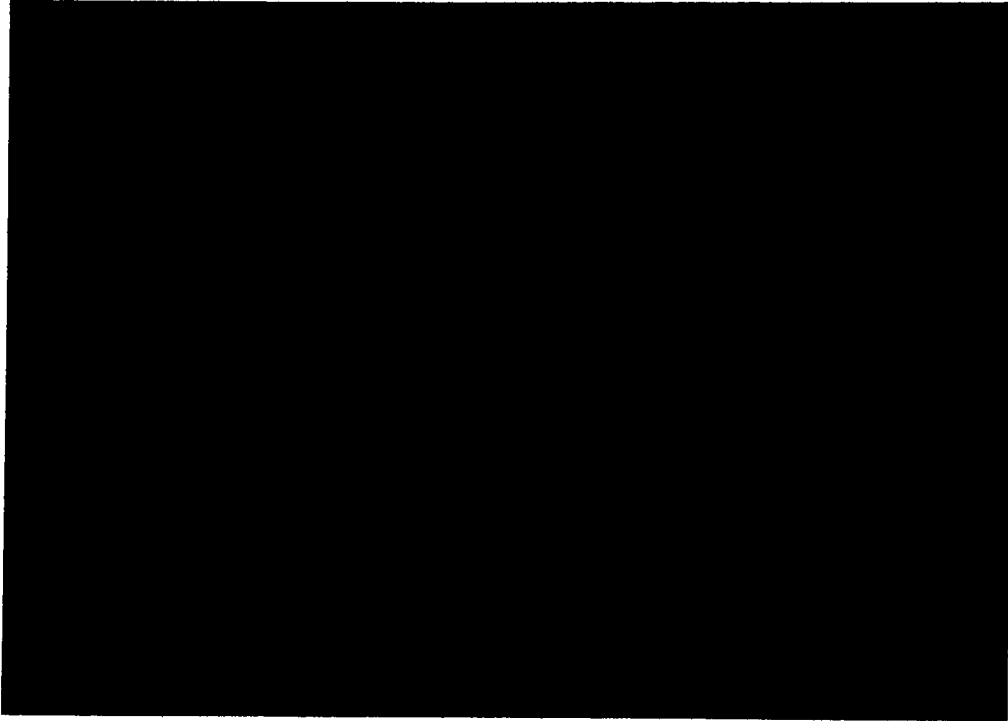

B

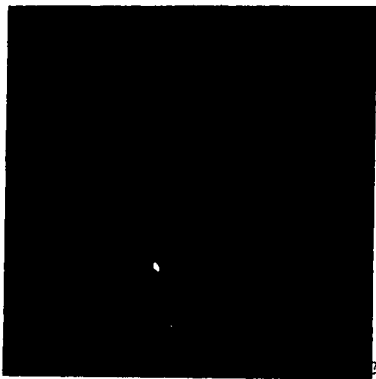

C

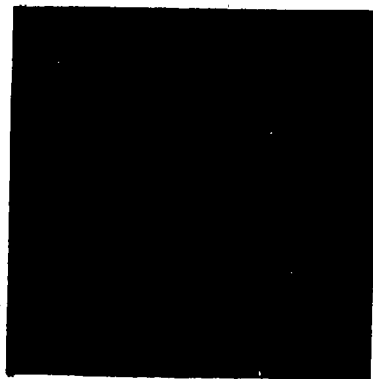

the position of the insert on any chromosome, so the position of its *rosy*⁺ insert(s) was determined by *in situ* hybridization. *In situ* hybridization of transformant strain T4 showing heterogeneity of the *rosy* insert sites, is displayed in Figure 6. This figure shows hybridization of the *rosy* gene probe in the centromeric region, possibly chromosome 4, at the *rosy* locus band 87, and another weak hybridization signal that is a heterozygous insert over band 92 close to the tip of chromosome 3R. This latter signal is better seen in Figure 6B. Figure 6C shows hybridization over what appears to be chromosome four. Table 5 also includes mapping data from single pair matings of line T4 to indicate there is heterogeneity in the position of the insert(s) in this line.

D. Soaking Embryos in pRy1 and p π 25.1

Fox and Yoon (1966) reported that 2-3% of dechorionated *Drosophila* embryos when soaked in radiolabelled DNA, showed uptake of DNA as measured by incorporation of radioactivity. In an effort to find a more convenient way to transform *Drosophila* an attempt was made to introduce DNA, specifically the plasmids pRy1 and p π 25.1, into *Drosophila* in a manner similar to the procedure of Fox and Yoon. One hour old embryos (genotype *b cn; ryal e*) were collected and dechorionated by soaking in 2.5% sodium hypochlorite for 30 seconds, then dried briefly by blowing dry nitrogen over them. The embryos were then transferred to an Eppendorf tube containing the DNA solution and centrifuged for about one second in an Eppendorf centrifuge. After soaking for 30 minutes the embryos were transferred to standard food.

Surviving G₀'s were examined for altered eye colour, then mass mated. Their progeny were also checked for XDH activity.

In two experiments approximately 500 embryos were soaked in 300 ug/ml pRy1 and 100 ug/ml p π 25.1 in 5mM KCl, 0.1mM Na₂PO₄ pH 6.9. In other trials (sample size approximately 150) the solution was made 50mM for CaCl₂ and contained 1% or 5% DMSO.

Although some 70% of soaked embryos survived no G₀ or G₁ flies were obtained with altered eye colour in any of these experiments involving the soaking of embryos in DNA solutions. Indeed, no experiments were performed to confirm whether or not any DNA actually entered the embryos.

E. Injections of pRy1 and p π 25.1 into *Drosophila mercatorum*

In an attempt to test the activity of P-elements in a different *Drosophila* species, the *rosy* transformation experiment was repeated using *D. mercatorum* embryos. Some 500 embryos were prepared and injected, however, the survivorship of *D. mercatorum* embryos under these conditions was extremely low as only one surviving first instar larva was obtained and it failed to pupate.

F. Plasmid Construction

To test the activity of a yeast tRNA suppressor gene in *Drosophila melanogaster* the following plasmids (Figures 7 - 10) were constructed. The plasmid constructs were all verified by restriction analysis, and one such analysis is shown in Figure 11 to verify the correct construction of pRyeST diagrammed in Figure 10 although a brief outline of each construction is given below. DNA fragment isolation,

Figure 7: Description of the construction of recombinant plasmid p6.1UGA and p6.1RyUGA. Cross-hatched boxed regions indicate P-element DNA sequences, open boxes and flanking material to the restriction sites are from yeast or *Drosophila* as noted below. The other sequences are bacterial plasmid material and this includes the gene for ampicillin resistance. Plasmid p6.1 was linearized with restriction endonuclease Xho cutting at the unique Xho site and put into a ligation reaction mixture with the 2.9 kb Xho/SalI yeast DNA fragment, isolated from a low gelling temperature .8% agarose gel, from restricted pDP9e. An aliquot of the ligation mixture was used to transform *E. coli* HB101, and colonies with ampicillin resistance were analysed as described in text, to confirm the structure of the plasmid with the insert designated p6.1UGA. Plasmid p6.1UGA was then linearized with restriction endonuclease Xho cutting at the unique Xho site and put into a ligation reaction mixture with the 8.1 kb SalI *Drosophila* DNA fragment, isolated from a low gelling temperature .8% agarose gel, from pDM2837. An aliquot of the ligation mixture was used to transform *E. coli* HB101, colonies with ampicillin resistance were analysed as above to confirm the structure of the plasmid with the insert designated p6.1RyUGA.

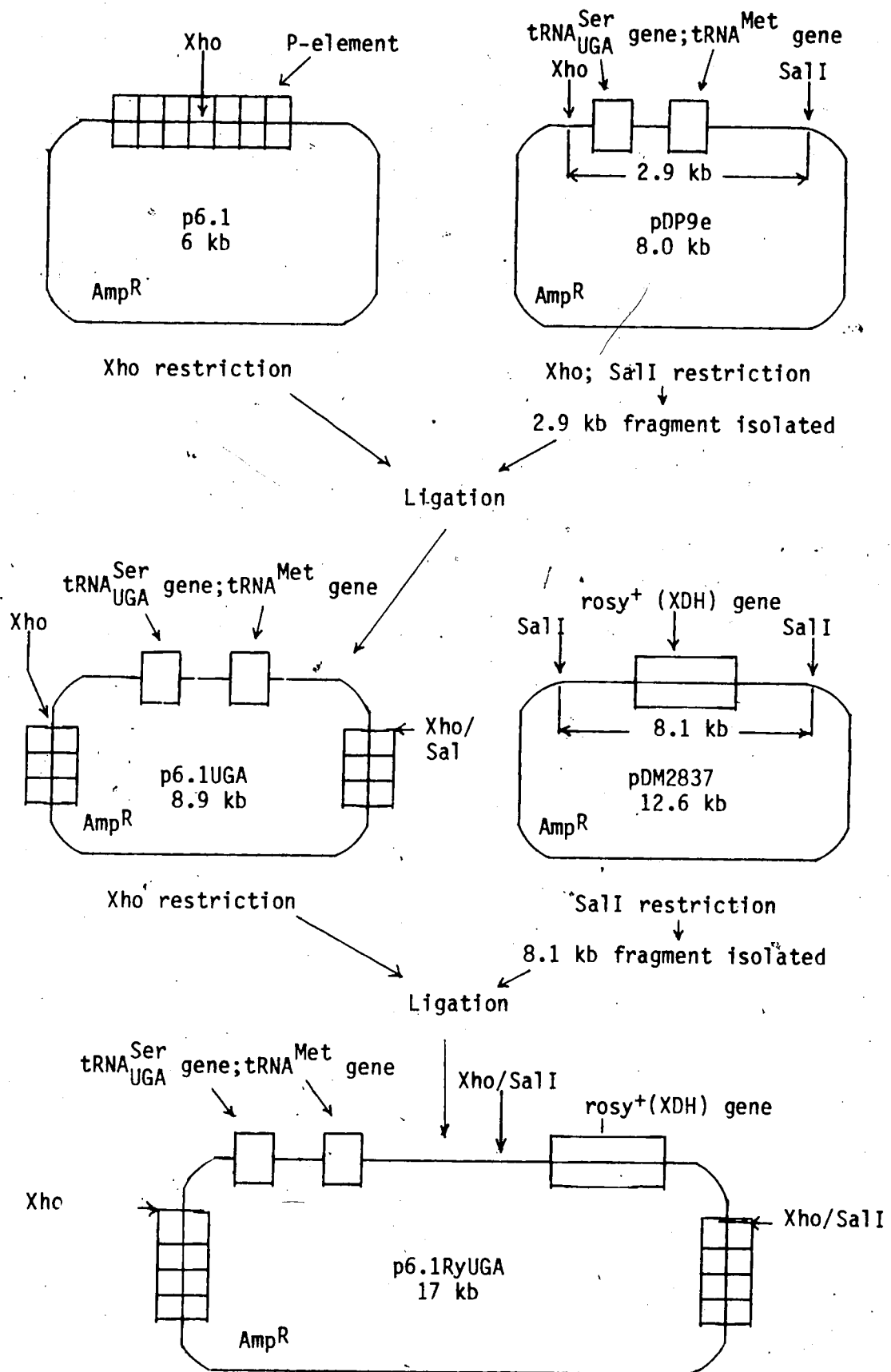

Figure 8: Description of the construction of recombinant plasmid p6.1Sup4-o. Cross-hatched boxed regions indicate P-element DNA sequences, open boxes and flanking material to the restriction sites are from yeast or *Drosophila* as noted below. The other sequences are bacterial plasmid material and this includes the gene for ampicillin resistance. Plasmid p6.1 was linearized with restriction endonuclease XhoI and put into a ligation reaction mixture with the 1.8 kb Sall yeast DNA fragment, isolated from a low gelling temperature .8% agarose gel, from pxSup4-o. An aliquot of the ligation mixture was used to transform *E. coli* HB101, and colonies with ampicillin resistance were analysed as described in Figure 7, to confirm the structure of the plasmid p6.1Sup4-0.

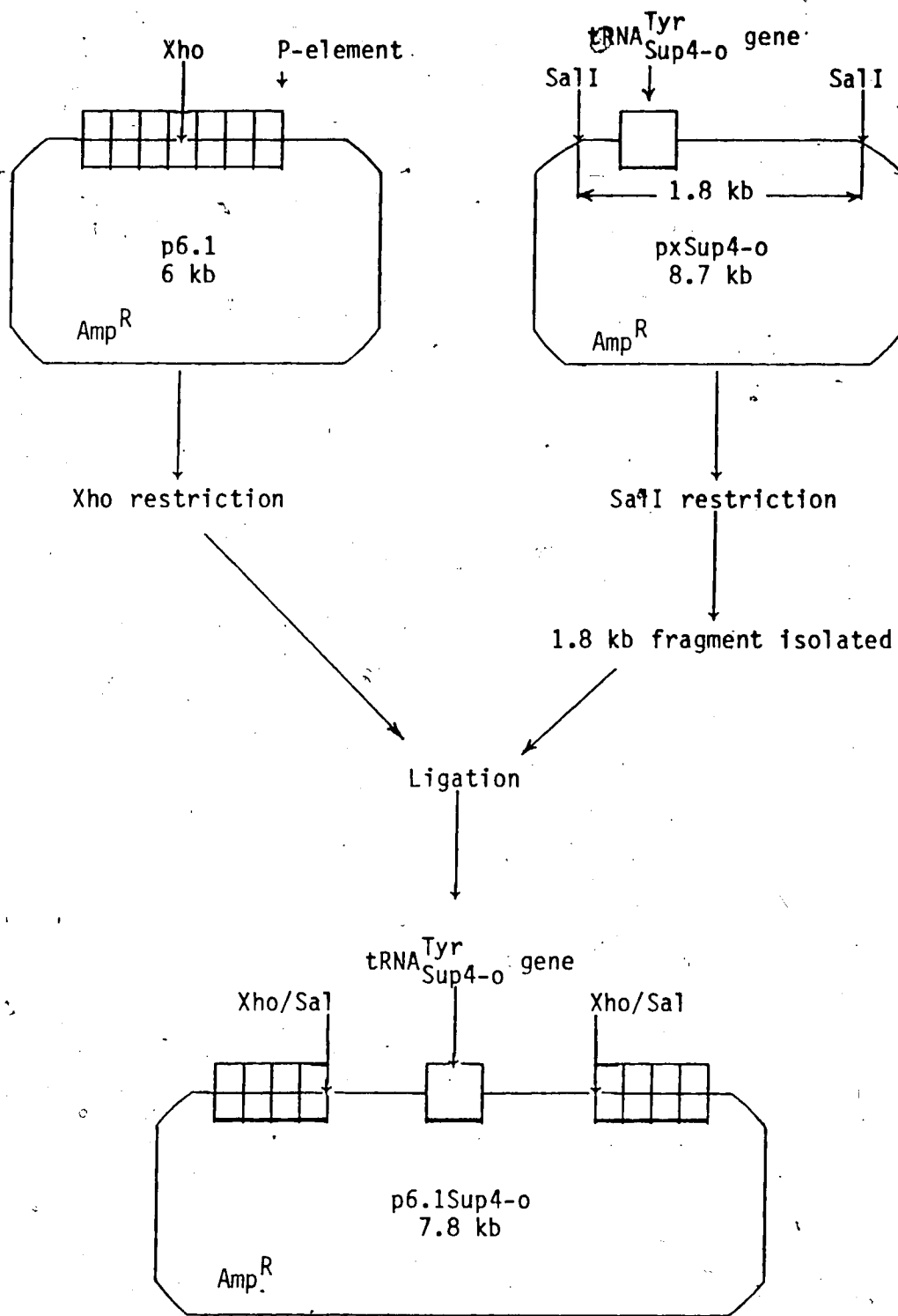

Figure 9: Description of the construction of recombinant plasmid pC-1ADH. Cross-hatched boxed regions indicate P-element DNA sequences, open boxes and flanking material to the restriction sites are from *Drosophila*. The other sequences are bacterial plasmid material and this includes the gene for ampicillin resistance. Plasmid Carnegie 1 was linearized with restriction endonuclease EcoRI and put into a ligation reaction mixture with the 4.65 kb EcoRI *Drosophila* DNA fragment, isolated from a low gelling temperature .8% agarose gel, from pTA2. An aliquot of the ligation mixture was used to transform *E. coli* HB101, colonies with ampicillin resistance were analysed as described in Figure 7, to confirm the structure of the plasmid pc-1ADH.

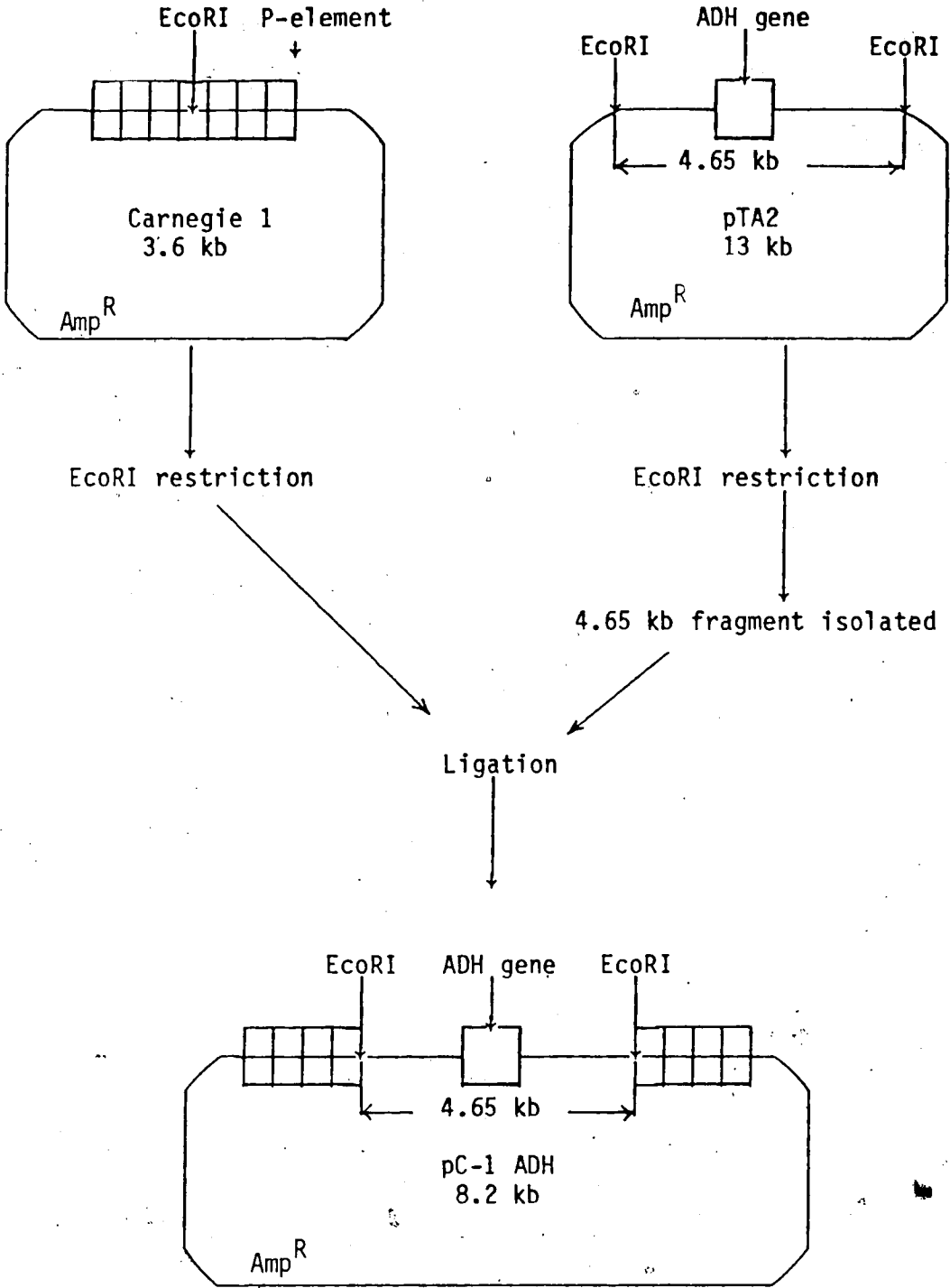
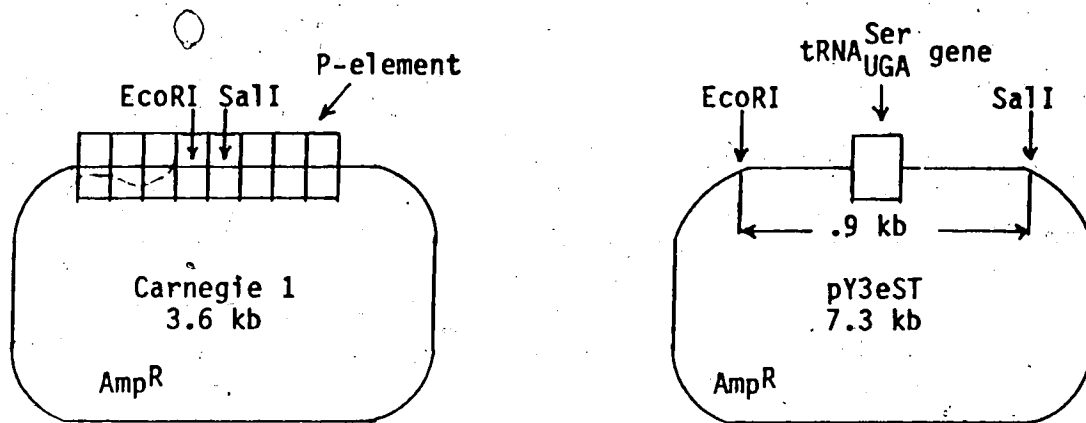

Figure 10: Description of the construction of recombinant plasmid pRyeST. Cross-hatched boxed regions indicate P-element DNA sequences, open boxes and flanking material to the restriction sites are from yeast or *Drosophila* as noted below. Heavy arrowheads denote EcoRI sites within the 8.1 kb *rosy* (XDH) gene. The other sequences are bacterial plasmid material and this includes the gene for ampicillin resistance. Plasmid Carnegie 1 was linearized with restriction endonuclease EcoRI and Sall and put into a ligation reaction mixture with the .9 kb EcoRI, Sall yeast DNA fragment, isolated from a low gelling temperature .8% agarose gel, from pY3eST. An aliquot of the ligation mixture was used to transform *E. coli* HB101, and colonies with ampicillin resistance were analysed, as described in Figure 7, to confirm the structure of the plasmid with the insert designated pQ9. Plasmid pQ9 was then linearized with restriction endonuclease Sall and put into a ligation reaction mixture with the 8.1 kb *Drosophila* DNA fragment, isolated from a low gelling temperature .8% agarose gel, from pDM2837. An aliquot of the ligation mixture was used to transform *E. coli* HB101, and colonies with ampicillin resistance were analysed, as described in Figure 7, to confirm the structure of the plasmid with the insert designated pRyeST.



EcoRI, SalI restriction

EcoRI, SalI restriction

.9 kb fragment isolated

Ligation

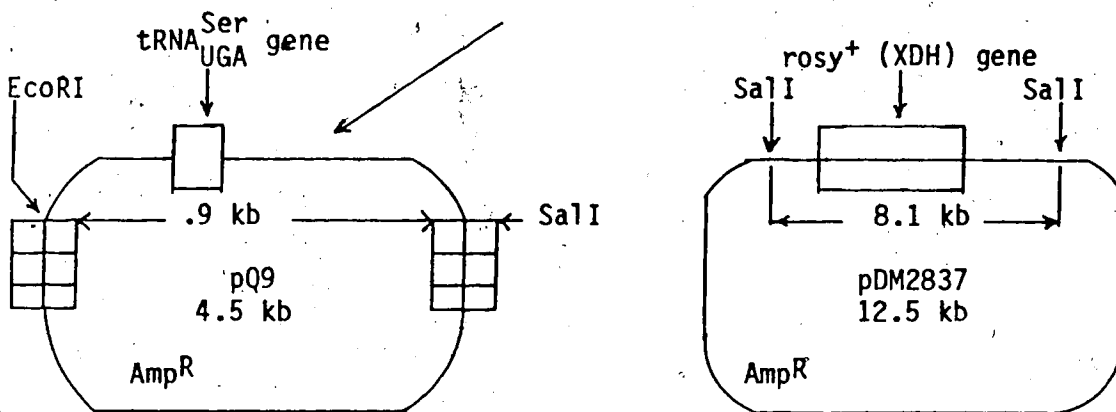

SalI restriction

SalI restriction

8.1 kb fragment isolated

Ligation

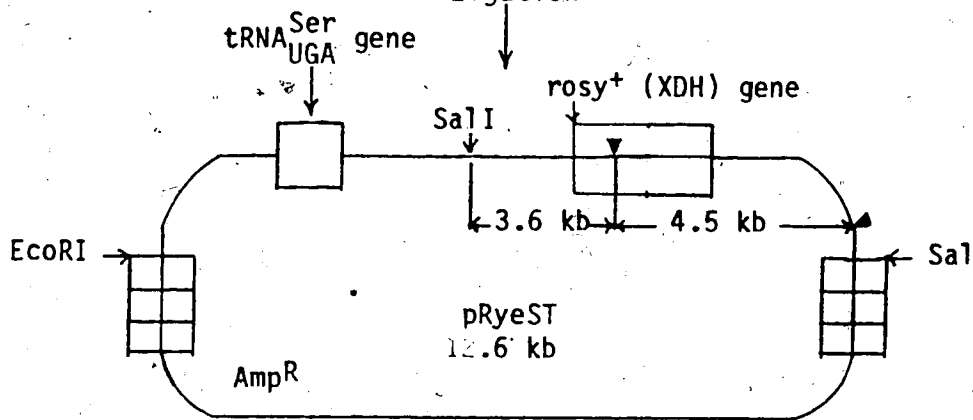

restriction, ligation, transformation into *E. coli*, rapid analysis of transformants and plasmid preparation were all done as described in the Materials and Methods. Figure 7 outlines the construction of plasmid p6.1RyUGA. This plasmid, like those described in Figures 8-10 contains DNA cloned within a defective p-element. Rubin and Spradling (1982) have shown that transformation of *Drosophila* depends on the genetic material being inside the terminal repeats of p-elements as they found no evidence of vector sequence integration. The defective p-element used in the construction of p6.1RyUGA is p6.1 (Rubin and Spradling 1982) and consists of a defective p-element cloned into pBR322. The first stage of construction involves the addition of a 2.9 kb fragment from plasmid pDP9e (pers. com. David Pearson). The plasmid pDP9e contains a dimeric tRNA gene from *S. pombe* cloned into plasmid pBR322. The construct p6.1UGA was then modified by the addition of an 8.1 kb fragment from plasmid pDM2837 (a gift from W. Bender which contains the XDH structural gene, and its flanking 5' and 3' sequences, cloned into pBR322). The addition of this fragment to the plasmid p6.1RyUGA produced a suitable transformation vector, p6.1RyUGA. Figure 8 outlines the construction of plasmid p6.1Sup4-0. In this case a 1.8 kb Sal I fragment was recovered from the yeast portion of pxSup4-0 (a gift from D. Allison which consists of a Xho-EcoRI fragment from *S. cerevisiae*, which contains the sequence for a tyrosine inserting tRNA gene, cloned into pBR322) was cloned into p6.1 to create p6.1Sup4-0. Figure 9 outlines the construction of plasmid pC-1ADH. In this case the p-element vector used was Carnegie 1, (Rubin and Spradling 1983) to which Rubin and

defective p-element. The construction of pC-1ADH involved the addition of a 4.65 kb fragment from pTA2 (a gift from D. Goldberg which contains the structural gene for ADH and its 5' and 3' flanking sequences cloned into pBR322) into Carnegie 1 to create pC-1ADH. In Figure 10 the Carnegie 1 (Rubin and Spradling, 1983) plasmid containing the defective P-element with an internal polylinker (Carnegie 1 was obtained from G. Rubin) was linearized with restriction endonucleases EcoRI and SalI. The 0.9 kb EcoRI, SalI fragment, extracted from a low gelling temperature agarose gel, containing a reconstructed serine inserting tRNA suppressor from *S. pombe* (from the plasmid PY3 *eST* from D. Soll) was ligated into the linearized car 1 vector creating pQ9.

Following large scale plasmid preparation of pQ9 and restriction analysis to confirm the structure, this plasmid was linearized with SalI (which is a unique site in this construct). An 8.1 kb fragment containing the wild type gene for XDH was purified by extraction from a low temperature agarose gel preparation of pDM2837 cut with SalI (pDM2837 obtained from W. Bender). From a ligation mixture containing pQ9 (linearized with SalI) and the 8.1 kb XDH containing fragment, transformants were analysed by agarose gel electrophoresis of rapid plasmid extractions. Preparation number 44 showed the proper size, and restriction analysis (Figure 11) confirmed the construct pRyeST to be suitable for the proposed transformation experiments. In Figure 11A, lane one contains λ C1857 digested with EcoRI and HindIII for size markers. Lane two contains EcoRI, SalI digestion of pRyeST which released fragments of the following sizes: 4.7 kb, two fragments of 3.6 kb (one fragment is the vector carried by 1, the other part of the

Figure 11A: Restriction analysis of pRyeST. Slot 1 contains λ C1857 restricted with EcoRI and HindIII for size markers. Slot 2 contains EcoRI and SalI restricted pRyeST; Slot 3 contains EcoRI and SalI restricted pY3eST and Slot 4 contains EcoRI and SalI restricted pDM2837.

Figure 11B: Restriction analysis of pRyeST. Slots 1, 2 and 3 show the same restriction samples that Slots 2, 3 and 4 do above with approximately twice as much DNA per Slot.

A

B

5.05

2.05

.95

.55

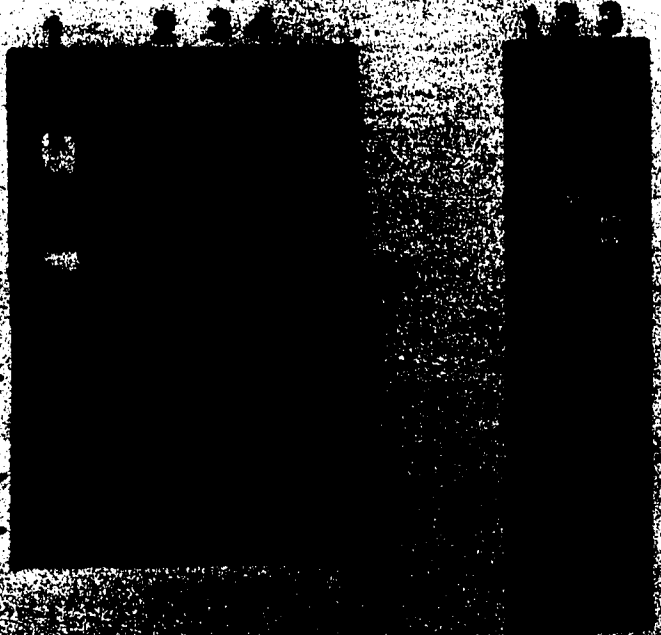

Spradling have added polylinker cloning sites from pUC8 within a defective p-element. The construction of pC-1ADH involved the addition of a 4.65 kb fragment from pTA2 (a gift from D. Goldberg which contains the structural gene for ADH and its 5' and 3' flanking sequences cloned into pBR322) into Carnegie 1 to create pC-1ADH. In Figure 10 the Carnegie 1 (Rubin and Spradling, 1983) plasmid containing the defective P-element with an internal polylinker (Carnegie 1 was obtained from G. Rubin) was linearized with restriction endonucleases EcoRI and Sall. The 0.9 kb EcoRI, Sall fragment, extracted from a low gelling temperature agarose gel, containing a reconstructed serine inserting tRNA suppressor from *S. pombe* (from the plasmid PY3 *eST* from D. Soll) was ligated into the linearized car 1 vector creating pQ9.

Following large scale plasmid preparation of pQ9 and restriction analysis to confirm the structure, this plasmid was linearized with Sall (which is a unique site in this construct). An 8.1 kb fragment containing the wild type gene for XDH was purified by extraction from a low temperature agarose gel preparation of pDM2837 cut with Sall (pDM2837 obtained from W. Bender). From a ligation mixture containing pQ9 (linearized with Sall) and the 8.1 kb XDH containing fragment, transformants were analysed by agarose gel electrophoresis of rapid plasmid extractions. Preparation number 44 showed the proper size, and restriction analysis (Figure 11) confirmed the construct pRyeST to be suitable for the proposed transformation experiments. In Figure 11A, lane one contains λ C1857 digested with EcoRI and HindIII for size markers. Lane two contains EcoRI, Sall digestion of pRyeST which released fragments of the following sizes: 4.7 kb; two fragments of

3.6 kb (one fragment is the vector carnegie 1, the other part of the 8.1 kb Sall fragment); a .9 kb fragment; and a fragment less than .1 kb (which was not visualized). Lane three contains EcoRI and Sall digested pY3eST which produced two fragments, one 6 Kb and one .9Kb. Lane four contains EcoRI and Sall digested pDM2837 which produced four visible bands of 4.5, 3.8, 3.6, and 0.5 Kb. Figure 11B lanes one, two, and three show the same DNA restricted with the same enzymes as lanes two, three, and four in figure 11A, but the gel was loaded with approximately twice as much DNA for each sample. This is because the small bands cannot be seen in Figure 11A but are easily seen in Figure 11B.

G. Transformation of *Drosophila* with tRNA Suppressor Genes from Yeast

This experiment had as its goal the identification of which of the putative *rosy* nonsense mutants (Girton et al., 1979) might be suppressible by yeast tRNA suppressor genes and thereby positively identify one or more of them as *bona fide* nonsense alleles. To do this, cloned DNA fragments carrying the tyrosine inserting ochre suppressor gene Sup4-o (Goodman et al., 1977) and a Serine inserting opal suppressor gene pDP9e (Hottinger et al., 1982) were separately cloned into the defective P-element vector, p6.1 (Rubin and Spradling, 1982) as described above. The construction of plasmid p6.1UGA is outlined in Figure 7 and p6.1Sup4-o in Figure 8. These two constructs, along with an amber suppressor gene, supRL (Olson et al., 1981), (which was not cloned into a P-element vector due to lack of appropriate restriction sites), were used in a transformation experiment described in Table 6. Plasmids containing the tRNA suppressor

TABLE 6. Co-injections with p6.1Sup4-o (150 ug/ml), p6.1UGA (150 ug/ml), supRL (150 ug/ml) and p α 25.1 (50 ug/ml)

Strain	# Injected	# Adults	# G ₀ ry ⁺	# G ₁ ry ⁺
<i>b cn; ry²⁶ e</i>	200	18	0	0
<i>b cn; ry^{a11} e</i>	220	31	0	0
<i>b cn; ry^{a1} e</i>	160	19	0	0
<i>b cn; ry⁶⁰⁴ e</i>	160	14	0	0
<i>b cn; ry⁸</i>	240	53	0	0

genes and the helper P-element p π 25.1 were co-injected into five putative *rosy* nonsense mutant strains at concentrations of 150 ug/ml (each) and 50 ug/ml respectively.

The hope here was that perhaps tRNA genes would be transcribed from the plasmids so that suppression of *rosy* putative nonsense mutants might be seen even if transformation was unsuccessful. In other words, if the tRNA genes were efficiently transcribed from the plasmid, properly processed and were used to produce active XDH, then the strain that showed evidence of XDH activity (*rosy*⁺) in G₀ flies would be injected with each kind of suppressor separately to determine which class of nonsense mutant was implicated.

The results (Table 6) show that this experiment failed to produce any G₀ or G₁ transformants.

H. Co-transformation Experiment

The next approach that was taken was the addition of a selectable gene marker along with the suppressor tRNA gene. This has the advantage that transformants can be readily identified on the basis of the selectable marker and then analyzed carefully for evidence of suppressor activity.

At the time this approach was taken the series of putative *rosy* nonsense mutants continued to present the best chance for recognition of suppressor activity in *Drosophila*. Since this ruled out the use of the *rosy*⁺ gene as a selectable marker, the ADH gene was picked to be the selectable gene. The construct pC-1 ADH was made as described in Figure 9. This plasmid was not used, however, as the documentation and availability of a nonsense mutant in the ADH gene (*CyOn^B* allele)

made the use of the *rosy+* gene as a selectable marker preferable.

The first P-element construct carrying a suppressor tRNA gene and the *rosy+* gene (p6.1RyUGA) was made as described in Figure 7.

A series of injections using this plasmid (p6.1RyUGA) at 300 ug/ml and p25.1 at 100 ug/ml produced 20 fertile adults and one G_0 *ry+* fly, but no stable *rosy+* transformed lines. Because no transformant was obtained using the relatively large plasmid construct p6.1RyUGA, it was decided to make a smaller co-transformation vector making use of the smaller P-element polylinker plasmid Carnegie 1 (Car-1), and a serine inserting opal suppressor where the adjoining methionine tRNA gene had been removed. The construction of this vector, pRyeST, is shown in Figure 10. Confirmation of the structure of this plasmid was done by restriction analysis and the results are shown in Figure 11. It can be seen that the expected .9 kb fragment (subcloned from pY3eST) is released by EcoRI, Sall digestion. The construction of all other plasmids described above was similarly confirmed (results not shown).

First Injection Series with Plasmids pRyeST and p 25.1

This series of injections, the first with the plasmid pRyeST, was done using *Adhfn⁷ pr cn/CyOn^B pr cn;ry/ry* as the host strain for the obvious reason that it was a *ry-*, *ADH null* strain that contained a nonsense mutation for *Adh*, the *CyOn^B* allele. Thus a transformant could be directly tested for the activity of the yeast suppressor by measuring the activity of ADH. The difficulty with this experiment was the particularly poor survivorship of this strain under the injection regime. This is due largely, but not completely, to the fact that this is a balancer strain, so half the embryos die due to

lethal chromosome combinations. Control experiments showed that only 1 in 7 treated but uninjected embryos survived. Of 800 injected embryos, only 43 first instar larvae and 16 adults were obtained. The 12 fertile adults gave no G_1 ry^+ progeny. These results are given in Table 7.

Second Injection Series with Plasmids pRyeST and p α 25.1

This series of injections, like the previously mentioned experiments, used the helper P (p α 25.1) at 100 ug/ml and the defective P with the gene(s) of interest at 300 ug/ml.

After the failure to produce ry^+ suppressor transformants directly into a strain carrying the ADH allele of interest, the *b an;e ry^{a1}* strain was used, as previous experiments had shown it to be the most "transformable" strain. The data are shown in Table 7.

The transformed line obtained was subsequently used to cross the ry^+ suppressor insert into an ADH null strain (*adhfn⁷/CYOnB*).

Unfortunately, only preliminary testing of restoration of ADH activity was done before this line was lost.

Repetition of the injection series using *ry^{a1}* and *ry⁸* as hosts was more successful (Table 8). Seventeen independent transformed lines were obtained. Those lines designated P are transformants from injected *ry⁸* embryos and Q lines are from *ry^{a1}* embryos. Two of these lines were used as a source of DNA for Southern analysis (Figure 12).

I. Southern Analysis

Southern analysis was performed on two transformed lines, P32 and P47. Figure 12A shows an autoradiogram of a filter probed with nick translated p α 25.1 and Figure 12B is an autoradiogram of a filter

TABLE 7. Injection with pRyeST (300 ug/ml) and p α 25.1 (100 ug/ml)

Injected Strain	# Injected	1st Instars	Adults	Fertile Adults		
				G ₀ ry ⁺	G ₁ ry ⁺	
$\frac{Adh\ fn^5\ pr\ cn}{CyOn^B\ pr\ cn} \frac{ry}{ry}$	800	43	16	12	0	0
$b\ cn; ry^a1\ e$	350	54	20	9	2	1

Controls: prepared for injection, but not injected.

$\frac{Adh\ fn^5\ pr\ cn}{CyOn^B\ pr\ cn} \frac{ry}{ry}$ 72 treated/ 10 1st instars

TABLE 8. Injections with pRyeST (300 ug/ml) and p~~α~~25.1 (100 ug/ml)

Injected Strain	# Injected	1st Instars	Adults	Fertile Adults	G ₀ <i>ry</i> ⁺	G ₁ <i>ry</i> ⁺
<i>b cn; ry^{a1} e</i>	420	64	32	11	21	3*
<i>b cn; ry^B</i>	1071	143	86	52	62	14*

*independent lines transformed

Figure 12A: Southern analysis of *myB* and transformed line P32.

Genomic DNA was restricted with EcoRI and run on an agarose gel (1%), blotted onto nitrocellulose and probed with nick translated p_n25.1. Slot 1 contains 8 ug *myB* DNA, Slot 2, 6 ug P32 DNA.

Figure 12B: Southern analysis of genomic DNA from transformed lines P32 and P47. Slot 1 contains EcoRI digested DNA from *myB* (12 ug); Slot 2 contains P32 DNA (10 ug); Slot 3 contains P47 DNA (6 ug); and Slot 4 contains EcoRI, SalI digested P47 DNA (8 ug); Slot 5 contains undigested pRyeST and Slot 6 contains undigested pY3eST. The gel, 1% agarose was then blotted onto nitrocellulose and probed with a nick translated .9 kb fragment from pY3eST. Slot 5 contains undigested pRyeST and slot 6 undigested pY3eST.

A

1 2



B

1 2 3 4 5 6



6.0

2.7

probed with nick translated pY3eST. In Figure 12A lane 1 contains 8ug of genomic DNA from *my⁸* and shows one hybridization signal in the 7 Kb range. This signal is due to the fact that the nick translated plasmid contains *Drosophila* DNA from polytene chromosome band 17C. This sequence was cloned along with the intact helper P-element. The absence of other bands in this slot confirm that the *my⁸* strain does not contain sequences homologous to p-element DNA. Lane 2 contains 6 ug of genomic DNA from transformed line p32. Lane 2 contains two strong hybridization signals; one at 7 Kb (which is explained above) and another in the 5 Kb range, which is due to the presence of p-element DNA in the transformed line. In Figure 12B, lane one contains 12 ug of *my⁸* genomic DNA. No strong hybridization is seen in this lane indicating that *my⁸* contains no sequences homologous to the plasmid or the tRNA gene insert that comprise pY3est. Lane 2 (which contains 10 ug of p32 genomic DNA digested with EcoRI) shows one strong hybridization signal about 4.5 Kb in length. This is the fragment size (which contains the tRNA gene) expected from an EcoRI digestion according to the construction diagram given in Figure 10. Lane 3, which contains 6 ug of p47 genomic DNA digested with EcoRI, also shows a fragment which gives a signal in the 4.5 Kb range. The apparent size difference in the hybridization signal seen between slots 2 and 3 can be explained by: a) the amount of DNA loaded in the slot was greater for lane 2, b) the blotting of the DNA to nitrocellulose may have been skewed or c) the amount of RNA in slot 2, as judged by the amount of fluorescence seen in the ethidium bromide stained gel photographed prior to blotting, shows it to contain 3 to 4 times the amount of RNA present in slot 3. Any of these reasons,

could account for the size difference seen. Slot 4, which contains p47 genomic DNA (8 ug) digested with EcoRI and Sall, shows one strong hybridization signal in the 1.Kb range which is in the size range expected for the tRNA gene based on the construction diagram (Figure 10). The differences in the amount of DNA added in each lane can also account for the different hybridization signal strengths seen. All genomic DNA was digested with EcoRI except lane 4 where P47 DNA was cut with EcoRI and Sall. This double digestion released the expected .9 kb fragment (Figures 10 and 11). The EcoRI digestion of P32 and P47 (Figure 12B, lanes 2 and 3) gave a signal in the 4 kb range, the size of these fragments was expected to be the same as EcoRI cuts twice within the flanking P-element DNA in the construct pRyeST.

The band seen in lane 1 Figure 12A is due to homologous genomic DNA (from 17C) that is included on the plasmid p25.1. The lack of P-element DNA in *ry⁸* confirms the results from the dysgenic crosses and the *in situ* hybridizations (results not shown). Lane 2 shows that transformed line P32 clearly has P-element sequences.

DISCUSSION

I. *Rosy* Transformation Experiments

The first transformation experiment attempted was a repetition of the *sn^w* experiment of Rubin and Spradling (1982). Although this injection series failed to demonstrate convincingly activity of the injected P-factor (p π 25.1), it was useful as a technical exercise. Because of the poor survivorship of the *sn^w* strain and, in hindsight, poor technique, it was decided that a better way to test this procedure was to repeat the Rubin and Spradling *rosy* transformation experiment using their cloned *rosy* gene (pRy1) and helper P-element (p π 25.1).

This experiment was successful and four transformed lines were produced (Table 4). The levels of XDH expression in the transformed lines (using pRy1) varied from 53% to 92% (Figure 4) as compared to XDH expression in a wild type strain. These results agree with those of Rubin and Spradling (1982) where XDH levels from 30% to 130% of wild type were reported. Evidence of multiple inserts was found amongst the transformed lines T3 and T4 based on *in situ* data. Hybridization patterns of the *in situ*s performed on line T4 show two inserts at 3L and in centromeric DNA, likely on the fourth chromosome (Figure 6C). T3 show inserts at band 82 on 3R and at 3A on the X chromosome. It is difficult to assess the level of XDH activity seen in lines T3 and T4 as at the time of this analysis they probably contained a mixture of the two inserts in each line. Thus, they appeared essentially stable, producing few *rosy* progeny (these few we attributed to the activity of introduced helper P-factors), but in fact, probably reflected heterozygosity of the inserts. The fact that

the genetic mapping performed could not resolve the location of an insert confirms the more detailed work of Rubin and Spradling in that there is no evidence to date for non-expressed or silent transformation events. That is, they never found strains that showed two or more inserts by *in situ* analysis that produced genetic mapping results indicating only one insert. This led them to propose that the DNA encoded information required for proper temporal and quantitative expression resides wholly or nearly wholly within the 8.1 kilobase fragment containing the *roby* structural gene, ruling out the consistent use of any P-element directed transcription regulation. The transformant lines T8 and Q7 were mapped to locations (Tables 4 and 5), on the second chromosome, whereas T3 appears to map to the third chromosome. The exceptional flies in T3 could be explained by the presence of an insert on the X chromosome. Line Q7 did not give clearcut results from the mapping crosses. The few exceptional flies could be explained by the activity of introduced helper P-elements occasionally mobilizing the insert on the second chromosome. Whether or not this is indeed the case here, the availability of a cloned helper P-element that cannot itself transpose (Hodgetts, personal communication) makes its use advisable for future transformation experiments. Although not tested directly, I find no reason to assume that the insertional process is any different than as described by Rubin and Spradling (1982).

In my hands the frequency of transformation for the *roby* gene was initially about 1 in 200 injected embryos and in the final transformation experiment the frequency was approximately 1 in 100, which

close to the frequency obtained by Rubin and Spradling (1982). Since 100 or more embryos can be single-handedly prepared and injected in a day, this frequency of transformation is adequate for selectable gene markers.

Initially the fate of each mounted embryo was followed through emergence as a first instar larva. This I found to be unnecessary and time consuming. The recording of this information broke the injecting and provided no useful information save for the proportion of properly staged embryos and the steadiness of the hands. These can vary widely from hour to hour over the course of an injection series. To obtain an accurate count of properly staged, properly injected embryos, a count was made of intact embryos the following day. This means that all embryos that are past pole cell formation or mishandled must be eliminated or marked. I found it most efficient to simply stab and burst the improper embryos while injecting with the needle, so that the number of intact embryos the following day represents the set of potential transformants.

It should be noted that, as in yeast, (Hinnen et al. 1978) different strains of *Drosophila* appeared to transform at different frequencies. These experiments were not designed to test this directly, but it is my impression that different *rosby* mutants derived from a common stock showed significant differences in G_0 and G_1 transformability, as well as differences in vitelline membrane toughness (although the less transformable strains were not tested to confirm they had an M-cytotype). This suggests that subtle genetic background differences may greatly affect the frequency of transformation. In practice this may mean obtaining a line of proven

transformability or starting with a few strains from different genetic backgrounds and then concentrating on the strain that gives a high frequency of G_0 transformants and shows high survivorship.

To avoid the problem of egg retention some care of the stocks from which the eggs are collected is required. At least four uncrowded stock bottles of young flies were prepared for egg collection. Preparation included daily transfers to fresh media, lightly spread with yeast paste, for three days prior to collection. These conditions reduce the frequency of egg retention. A great deal of variance was found in egg production during the day. This, of course, can be manipulated by photoperiod adjustment, but it was found that collecting from four bottles insured an adequate and usually abundant supply of eggs.

) It was found that the Nomarsky optical system is preferable to conventional optical systems. With it, structures within the embryos are more easily seen and this makes the identification of correctly and incorrectly staged embryos quick and reliable. Since embryos that are past pole cell formation cannot be transformed it is important not to save any embryos whose developmental stage is in doubt. Further, it is necessary to remove all unmounted embryos from the slide prior to covering the prepared embryos with halocarbon oil.

The timing of desiccation, in the changing conditions of the Biological Sciences Building, could vary significantly and needed to be determined empirically each day. The range was from from 6 to 15 minutes.

With regard to filling the needle with the DNA mixture, it was more efficient to load the needle using a drawn-out capillary. Two to

three μ l. of DNA solution loaded this way is a huge excess, but much quicker and more reliable than drawing the DNA solution from a drop on the slide. This also allows for the use of a needle for up to 48 hours; G_0 and G_1 *rosy*⁺ transformants were obtained from DNA which had been stored overnight in the needle. Between slides or injection series the needle must always be kept under halocarbon oil (Halocarbon) to prevent crystallization of the DNA solution.

The rationale for the soaking of embryos in solutions containing plasmids pRy1 and p α 25.1 was as described below. Fox and Yoon (1966) had demonstrated the uptake of DNA by embryos and their transformation with genomic DNA (1970). The *rosy* system seemed ideal for these experiments for the following reasons: (i) the *rosy* gene is nonautonomous; (ii) only low levels of XDH are required to alter the eye color; (iii) the availability of the *rosy*⁺ gene clone; and (iv) the demonstration (Rubin and Spradling, 1982) that XDH expression did not require integration of the plasmid. It was felt that even a very low transformation frequency would make this technique preferable to injection. However, no evidence of XDH expression was detected in G_0 's or G_1 's from the approximately 1,500 treated embryos.

While the DNA 'soaking' experiments were in progress, transformation of a different *Drosophila* species, (*D. mercatorum*) was also attempted. The object of the repetition of *rosy* transformation experiments was simply to see if element mediated transformation would work in species other than *D. melanogaster*. However, this question could not be answered because the embryos failed to survive. This was due, in the main, to the fragility of the *D. mercatorum*

vitelline membrane. Recently, Brennan et al. (1984) have been successful in using the P-element transformation system to introduce an ADH gene into *D. hawaiiensis*.

B. Experiments with the Unselected Introduction of Suppressor Genes

At the time these experiments were started there were no verified nonsense mutants in *Drosophila*. The object of this series of injections was to attempt to recognize a nonsense mutant from a number of *rosy* putative nonsense mutants by the injection of yeast tRNA informational suppressor genes cloned into a carrier P-element (p6.1). It was hoped that the injected cloned suppressors (either singly or in combination) might be transcribed, processed and function to an extent that would allow the completion of enough functional XDH to alter the eye colour of the strain, if indeed, any of the *ry* strains had premature termination codons in the XDH structural gene. Fundamentally, this was an exercise to try to find out which of these nine putative *rosy* nonsense mutants might be a real nonsense mutant.

It is known that genes transcribed by RNA Polymerase II, when re-introduced in *Drosophila*, behave essentially as normal regardless of chromosomal locale (Spradling and Rubin, 1983) (Goldberg et al., 1983) (Scholnick et al., 1983). It is also possible that genes transcribed by RNA Polymerase III, even from a different species, would behave like the reintroduced structural genes (ADH, XDH etc.); that is, near normal expression in a different chromosomal position. Evidence of yeast tRNA gene function in other eukaryotes includes documentation of their transcription and processing in *Xenopus* oocytes (Melton et al 1980) and in monkey tissue culture cells (cited in, 1982).

The choice of yeast suppressor tRNA genes was made because they

were the only cloned eukaryotic suppressors readily available. The rationalization that yeast suppressors might function in *Drosophila in vivo* was based on the high degree of conserved structure and function of tRNA in all eukaryotes (Kubli, 1981).

Throughout the eukaryotes tRNA genes show a great deal of sequence conservation (Sprinzl et al., 1980) (Kubli, 1980) and many of the same specific post-transcriptional modifications (Sherman, 1982). In eukaryotes some tRNA genes have introns located 3' to the anticodon and, though they vary in length, the position of the beginning of the intron is always the same (Kubli, 1981). The internal and external sequences that regulate the transcription of tRNA genes seems largely conserved among eukaryotes (Kressman et al., 1979) (DeFranco et al., 1980). The enzymatic attachment of the appropriate amino acid to a particular mature tRNA is a highly conserved function; in our laboratory we have routinely used crude *Drosophila melanogaster* extracts to aminoacylate yeast tRNA.

The results of these experiments (Table 6) failed to provide a more likely candidate for a nonsense mutant among the 5 strains examined. The unselected addition of suppressor tRNA genes and the low frequency of successful transformation made it unreasonable to identify transformants by *in situ* hybridization. At this time it was decided that the introduction of a suppressor tRNA gene along with a selectable marker gene would be better than the unselected addition of suppressor tRNA genes. As a verified nonsense mutant was still not available, the plan was to make the putative *rosy* nonsense strains homozygous for ADH null alleles and use the ADH structural gene as the selectable marker for the introduction of suppressors in these

strains. However, the construct pC-1ADH (Figure 9) was never used as shortly after its construction the documentation and availability of a *bona fide* ADH nonsense allele (Kubli et al. 1982) made a different approach seem more practical.

C. Co-transformation of *Drosophila* with the *Rosy* Gene and a Suppressor tRNA Gene

When a characterized nonsense mutant was obtained, the objective became the introduction of an appropriate suppressor tRNA gene along with the *rosy*⁺ gene for easy identification of transformants. The CyOn^B ADH allele was found to produce a foreshortened polypeptide and the addition of opal tRNA nonsense suppressors to an *in vitro* translation system led to the production of a full sized ADH product (Kubli et al, 1982). A suitable opal suppressor tRNA gene clone was obtained from Dieter Soll's laboratory. This clone (pDP9e) contained a dimeric tRNA gene from *S. pombe* including a serine inserting UGA suppressor tRNA gene and a methionine tRNA gene. This suppressor was known to function in *S. cerevisiae* (Hottinger et al., 1982) and *in vitro* in *Drosophila* extracts (D. Pearson, personal communication). Since this suppressor has the desired anticodon, and some evidence of function with *Drosophila* enzymes *in vitro*, it was utilized for *in vivo* transformation assays despite the fact that it is not known whether dimeric tRNA genes exist in *Drosophila*, and, therefore, if it would be used correctly.

A construct suitable for transformation was obtained by inserting the 8.1 kb fragment from pD^{rosy} (W. Bender, personal communication) containing the *rosy*⁺ gene, into the remaining XhoI site of p6.1 UGA.

This large (>17 kb) plasmid (Figure 7) proved ineffective as a transformation vector; only one *G₀* fly showing XDH activity was obtained and no stable transformants were produced. It was thought likely that the construct's large size might preclude its movement from plasmid to chromosome and a smaller construct was made. In the pRyeST plasmid (Figure 10) the same serine inserting tRNA UGA suppressor from *S. pombe* was used, but it had been modified by D. Pearson (personal communication) to remove the adjacent methionine tRNA gene. This was done by cutting with HphI in the spacer separating the two tRNA genes. A fragment from a 3' end of the *sup12⁺* tRNA gene was placed next to the tRNA^{Ser}_{UGA} gene to provide the required transcription termination sequences. This reduced the fragment size which included the serine tRNA UGA gene to .9 kb and, along with the smaller P-element, polylinker vector Carnegie 1 (Rubin and Spradling, 1983) produced an appropriate *rosy* /suppressor vector (pRyeST) that was 12.1 kb.

The initial transformation experiment using this plasmid proved successful although only one transformed line was obtained. When the *rosy⁺* gene, and presumably the suppressor gene were crossed into an ADH null strain where one of the alleles was the nonsense allele *CyOn^B*, no ADH activity was detected by ADH spot tests or spectrophotometric assay for ADH. The loss of this transformed line and the strain carrying the introduced sequences in the ADH null background curtailed more sensitive ADH assays and attempts to increase the copy number of the insertion via hybrid dysgenesis.

A large scale repetition of the above transformation experiment proved to be the most successful injection series of all of those

attempted. Of 11 fertile *mya1* G₀'s 27% (3/11) gave *rosy+* offspring (G₁'s), and of 52 fertile *my⁸* G₀'s 27% (14/52) gave transformed (G₁) progeny. This experiment also yielded a remarkable number of G₀ *rosy+* flies. Of 32 total G₀'s obtained from 64 surviving *mya1* first instar larvae, 65% (21/32) had the *cn rosy+* phenotype. Of 86 G₀'s obtained from 143 surviving *my⁸* first instars, 74% (62/86) showed evidence of XDH activity as ascertained by the altered eye phenotype. Rubin and Spradling (1982) have explained the phenomenon of G₀ *rosy+* expression as being due to plasmid directed transcription of the XDH gene, since many of the G₀ *rosy+* flies do not give *rosy+* offspring and they have found no evidence of somatic cell transformation. This study also found numerous examples of G₀ *rosy+* flies that did not produce any G₁ *rosy+* offspring (Tables 1, 2, 7 and 8). Since the concentration of plasmids used in the last series of experiments of this study was the same as was used in previous experiments, and indeed the plasmids came from the same plasmid preparation, the explanation for the large increase in G₀ and G₁ transformation frequency is unknown. The only obvious difference between the first and second injection series was the use of a new preparation of DNA injection buffer. The frequency of G₁ transformation obtained in the final injection series compares favourably with the best results of Rubin and Spradling and shows a higher frequency of G₀ *rosy+* expression than their results. This shows that the strains *mya1* and *my⁸* transform well and that further transformation experiments should probably use these strains or perhaps cross the required genetic markers into this background. This suggestion is made in light of difficulties encountered by another

researcher (V. Walker, personal communication) who has had much better success in transforming these lines than with other *rosy* strains.

The Southern hybridization experiments are clearcut in that they demonstrate the presence of both the p-element sequences (Figure 12A) and the inserted suppressor gene (Figure 12B) in two of the transformed lines. There is no reason to believe that any of the other lines would be different, except, perhaps, in the number of P-elements. Because the number of inserts and the homozygosity of the inserts was not certain prior to the DNA extraction, conclusions as to the copy number cannot be made at this time. Confirmation of the presence of suppressor gene sequences now presents an opportunity for further investigation of these transformed lines. This, we believe is the first account of foreign DNA stably integrated in *Drosophila*.

Obviously the first question to resolve is that of transcription of the tRNA gene. Northern analysis should give an indication of the level of stable transcript produced, if any, and the size of the transcript would provide a clue as to the degree of processing of the transcript. Failure to detect a transcript would probably represent a failure of *Drosophila* RNA Polymerase III to recognize yeast tRNA transcription start signals, or the failure of RNA Polymerase III to reach the gene due to non-standard local DNA topography. If the former is the case, perhaps a mutagenic screen could be devised to detect activity of the of the suppressor (by detection of completed ADH product from the CyOn^B mutation), where either the tRNA suppressor gene or the RNA Polymerase III has been altered so as to now produce functional suppressor. On the other hand, it may be easier, and ultimately necessary, to create

genuine *Drosophila* suppressor tRNA genes by *in vitro* mutagenesis of cloned *Drosophila* genes. In this way one could ensure that all transcription and processing signals should be recognized since it would then be a completely homologous system.

If a transcript is detected in the standard tRNA size range, then the introduction of this insert into a strain carrying the ADH nonsense allele is the next logical step. An analysis of a strain carrying the Adh nonsense allele and the serine inserting tRNA gene would include assays of alcohol dehydrogenase activity and the use of antibodies against the ADH protein. Kubli et al (1982) used ADH specific antibodies to stain SDS PAGE acrylamide gels to detect full sized ADH protein from *in vitro* translation of mRNA from *Drosophila* strains carrying the *CyOn^B* allele. Such an antibody assay is required because the insertion of a serine residue at what would normally be a tryptophan site may lead to an inactive product. Since many different transformed lines are available, it should be possible to create lines with different numbers of the suppressor and *roby^r* genes (this might be selected for using a purine resistance screen). This increase in copy number would enhance the probability of detecting low levels of suppressor activity.

Intermediate results, where a transcript is found, but is non-functional or incompletely processed, would still provide interesting clues as to the different key sequences involved in processing and/or modification of tRNA in *Drosophila*. If found to be functional, the small size of the fragment carrying the suppressor tRNA would make it useful as a selectable second gene marker in other co-transformation experiments (in a strain with a nonsense mutant), and the transformed

lines provide a means for the analysis of other uncharacterized mutants in *Drosophila melanogaster*.

BIBLIOGRAPHY

- Avery, O. T., C. M. McLeod, and M. McCarty, 1944. Studies on the chemical nature of the substances inducing transformation of pneumococcal types. Induction of transformation by a deoxyribonucleic acid fraction isolated from pneumococcus Type III. *J. Exp. Med.* 79: 137-158.
- Bingham, P. M., R. Levis, and G. M. Rubin, 1981. Cloning of DNA sequences from the white locus of *D. melanogaster* by a novel and general method. *Cell* 25: 693-704.
- Bingham, P. M., M. G. Kidwell, and G. M. Rubin, 1982. The molecular basis of P-M hybrid dysgenesis: the role of the P-element, a P-strain-specific transposon family. *Cell* 29: 995-1004.
- Bownes, M., 1975. A photographic study of development in the living embryo of *Drosophila melanogaster*. *J. Embryol. Exp. Morph.* 33: 789-801.
- Brennan, M. D., R. G. Rowan, and W. J. Dickinson, 1984. Introduction of a Functional P-Element into the germ-line of *Drosophila hamaxiensis*. *Cell* 38: 147-151.
- Capecchi, M. R., S. H. Hughes, and G. M. Wahl, 1975. Yeast suppressors are altered tRNA's capable of translating a nonsense codon *in vitro*. *Cell* 6: 269-277.
- Cohen, S. N., A. C. Y. Chang, H. W. Boyer, and R. B. Helling, 1973. Construction of biologically functional plasmids *in vitro*. *Proc. natl. Acad. Sci. USA* 70: 3240-3244.
- Davis, R. W., D. Botstein, and J. R. Roth, 1980. *Advanced bacterial genetics.*, Cold Spring Harbor Laboratory.
- DeFranco, D., O. Schmidt, and D. Soll, 1980. Two control regions for eukaryotic tRNA gene transcription. *Proc. natl. Acad. Sci. USA* 77: 3365-3368.
- Diamond, A., B. Dudock, and D. Hatfield, 1981. Structure and properties of a bovine liver UGA suppressor Serine tRNA with a tryptophan anticodon. *Cell* 25: 497-506.
- Engelhart, D.L., R.E. Webster, R.C. Wilhelm, and N.D. Zinder, 1965. *In vitro* studies on the mechanism of suppression of a nonsense mutation. *Proc. natl. Acad. Sci. USA* 54: 1791-1797.
- Engels, W. R., and C. R. Preston, 1980. Components of hybrid dysgenesis in a wild population of *Drosophila melanogaster*. *Genetics* 95: 111-128.

- Fox, A. S., and S. B. Yoon, 1966. Specific genetic effect of DNA in *Drosophila melanogaster*. *Genetics* 53: 897-911.
- Fox, A. S., and S. B. Yoon, 1970. DNA-induced transformation in *Drosophila*: Locus-specificity and the establishment of transformed stocks. *Proc. Natl. Acad. Sci. USA* 67: 1608-1615.
- Garen, A., 1968. Sense and nonsense in the genetic code. *Science* 106: 149.
- Germeraad, S. E., 1975. Induction of genetic alterations in *Drosophila* by injection of DNA into embryos. *Genetics* 80: s34-s35.
- Germeraad, S. E., 1976. Genetic transformation in *Drosophila* by microinjection of DNA into embryos. *Nature* 262: 229-231.
- Gesteland, R. F., M. Wolfner, P. Grisafi, G. Fink, D. Botstein, and J. R. Roth, 1976. Yeast suppressors of UAA and UAG nonsense codons work efficiently *in vitro* via tRNA. *Cell* 7: 381-390.
- Girton, L. E., R. Y. C. Lo, and J. B. Bell, 1979. An analysis of xanthine dehydrogenase negative mutants of the *rosy* locus in *Drosophila melanogaster*. *Can. J. Genet. Cytol.* 21: 379-389.
- Glassman, Edward, 1962. Convenient assay of xanthine dehydrogenase in single *Drosophila melanogaster*. *Science* 137: 990.
- Goldberg, D. A., J. W. Posakony, and T. Maniatis, 1983. Correct developmental expression of a cloned Alcohol dehydrogenase gene transduced into the *Drosophila* germ line. *Cell* 34: 59-73.
- Goodman, H. M., M. V. Olson, and B. D. Hall, 1977. Nucleotide sequence of a mutant eukaryotic gene: The yeast tryosine-inserting ochre suppressor SUP4-o. *Proc. natl. Acad. Sci. USA* 74: 5453-5457.
- Green, M. M., 1949. A study of tryptophane in eye color mutants of *Drosophila*. *Genetics* 34: 564-572.
- Green, M. M., 1969. Controlling element mediated transposition of the white gene in *Drosophila melanogaster*. *Genetics* 61: 429-441.
- Grell, E. H., K. B. Jacobson, and J. B. Murphy, 1968. Alterations of genetic material for analysis of alcohol dehydrogenase isozymes of *Drosophila melanogaster*. *Ann. N.Y. Academy of Sciences* 151: 441-455.
- Hartman, P. E., and J. R. Roth, 1973. Mechanism of suppression. *Adv. Genet.* 17: 1.
- Hawthorne, D.C. and U. Leupold, 1974. Suppressor mutations in yeast. *Curr. Top. Microbiol. Immunol.* 64: 1-47.

- Hazelrigg, T., R. Lewis, and G. M. Rubin, 1984. Transformation of white locus DNA in *Drosophila*: Dosage compensation, zeste interaction and position effects. *Cell* 36: 469-481.
- Hess, D., 1972. Transformationen an hoheren organismen. *Naturwissenschaften* 59: 348-358.
- Hinnen, A., J. B. Hicks, and G. R. Fink, 1978. Transformation of yeast. *Proc. natl. Acad. Sci. USA* 75: 1929-1933.
- Hottinger, H., D. Pearson, F. Yamao, V. Gamulin, L. Cooley, T. Cooper, and D. Soll, 1982. Nonsense Suppression in *Schizosaccharomyces pombe*: The *S. pombe* Sup3-e tRNA^{UGA} gene is active in *S. cerevisiae*. *Mol. Gen. Genet.* 188: 219-224.
- Hubby, J. L., 1963. Protein differences in *Drosophila*. I. *Drosophila melanogaster*. *Genetics* 48: 871-879.
- Ish-Horowicz, D., S. M. Pinchin, P. Schedl, S. Artavanis-Tsakonas, and M. Mirault, 1979. Genetic and molecular analysis of the 87A7 and 87C1 heat-inducible loci of *D. melanogaster*. *Cell* 18: 1351-1358.
- Jacobson, K.B., 1971. Role of an isoacceptor tRNA as an enzyme inhibitor: Effect on tryptophan pyrrolase of *Drosophila*. *Nature New Biology* 231: 17-18.
- Korner, A. M., S. I. Feinstein, and S. Altman, 1978. In "*Transfer RNA*", (S. Altman, ed.), M.I.T. Press, Cambridge, pp. 105-135.
- Kressmann, A., H. Hofstetter, E. Di Capua, R. Grosschedl, and M. L. Birnstiel, 1979. A tRNA gene of *Xenopus laevis* contains at least two sites promoting transcription. *Nucl. Acids Res.* 7: 1749-1763.
- Kubli, E., 1980. Modification of transfer RNA in eukaryotes: an evolutionary interpretation. *Trends Biochem. Sci.* 5: 90-91.
- Kubli, E., 1981. The structure and function of tRNA genes of higher eukaryotes. *Experientia*. 37: 1-9.
- Kubli, E., T. Schmidt, P. F. Martin, and W. Sofer, 1982. *In vitro* suppression of a nonsense mutant of *Drosophila melanogaster*. *Nucl. Acids Res.* 10: 7145-7152.
- Lindsley, D. and E. H. Grell, 1967. Genetic Variations of *Drosophila melanogaster*. Carnegie Institution of Washington Publication.
- Maniatis, T., E. F. Fritsch, and J. Sambrook, 1982. *Molecular Cloning: A Laboratory Manual*. (Cold Spring Harbor Laboratory).
- McBride, O. W., and H. L. Ozer, 1973. Transfer of genetic information by purified metaphase chromosomes. *Proc. natl. Acad. Sci. USA* 70: 1258-1262.

- Melton, D. A., E. M. DeRobertis, and R. Cortese, 1980. Order and intracellular location of the events involved in the maturation of a spliced tRNA. *Nature* 284: 143-148.
- Mishra, N. C., and E. L. Tatum, 1973. Non-Mendelian inheritance of DNA-induced inositol independence in *Neurospora*. *Proc. natl. Acad. Sci. USA* 70: 3875-3879.
- Nash, D., and J. B. Bell, 1968. Larvae age and the pattern of DNA synthesis in polytene chromosomes. *Can. J. Genet. Cytol.* 10: 82-92.
- Nawa, S., and M. A. Yamada, 1968. Hereditary change in *Ephesia* after treatment with DNA. *Genetics* 58: 573-584.
- O'Hare, K., and G. M. Rubin, 1983. Structures of P transposable elements and their sites of Insertion and Excision in the *Drosophila melanogaster* genome. *Cell* 34: 25-35.
- Olson, M. V., G. S. Page, A. Sentenac, P. W. Piper, M. Worthington, R. B. Weiss, and B. C. Hall, 1981. Only one of two closely related yeast suppressor tRNA genes contains an intervening sequence. *Nature* 291: 464-469.
- Rizki, T.M., and R.M. Rizki, 1963. An inducible enzyme system in the larval cells of *Drosophila melanogaster*. *J. Cell Biol.* 17: 87-92.
- Rubin, G. M., and A. C. Spradling, 1982. Genetic transformation of *Drosophila* with transposable element vectors. *Science* 218: 348-353.
- Rubin, G. M., and A. C. Spradling, 1983. Vectors for P-element mediated gene transfer in *Drosophila*. *Nucl. Acids Res.* 11: 6341-6351.
- Rubin, G. M., M. G. Kidwell, and P. M. Bingham, 1983. The molecular basis of P-M hybrid dysgenesis: the nature of induced mutations. *Cell* 29: 987-994.
- Sayles, C. D., L. W. Browder, and J. H. Williamson, 1973. Expression of xanthine dehydrogenase activity during embryonic development of *Drosophila melanogaster*. *Dev. Biol.* 33: 213-217.
- Scholnick, S.B., B.A. Morgan, and J. Hirsh, 1983. The cloned dopa decarboxylase gene is developmentally regulated when reintegrated into the *Drosophila* genome. *Cell* 34: 37-45.
- Schultz, J., and C.B. Bridges, 1932. Methods for distinguishing between duplications and specific suppressors. *Am. Natur.* 66: 323-334.
- Seale, T. W., M. Brett, A. J. Baron, and J. R. S. Fincham, 1976. Amino acid replacements resulting from suppression and missense reversion of a chain-terminator mutation in *Neurospora*. *Genetics* 86: 261-274.

- Seybold, W. D., 1974. Purification and partial characterization of xanthine dehydrogenase from *Drosophila melanogaster*. *Biochem. Biophys. Acta* 334: 266-271.
- Sherman, F., 1982. In "*The Molecular Biology of the Yeast Saccharomyces: Metabolism and Gene Expression*", (J. N. Strathern et al., eds.), Cold Spring Harbor Laboratory, Cold Spring Harbor, pp. 483-486.
- Spradling, A. C., and G. M. Rubin, 1982. Transposition of cloned P-elements into *Drosophila* germ line chromosomes. *Science* 218: 341-347.
- Spradling, A. C., and G. M. Rubin, 1983. The effect of chromosomal position on the expression of the *Drosophila* xanthine dehydrogenase gene. *Cell* 34: 47-57.
- Sprinzl, M., F. Grueter, A. Speer, and D. H. Sauss, 1980. Compilation of tRNA sequences. *Nucl. Acids Res.* 8: r1-r22.
- Steege, D. A., and D. Soll, 1979. In "*Biologic Regulation and Development*", (R. F. Goldberger, ed.), Plenum, N.Y., pp. 433-485.
- Strobel, E., P. Dunsmuir, and G.M. Rubin, 1979. Polymorphisms in the chromosomal locations of elements of the 412, copy and 297 dispersed repeated gene families of *Drosophila*. *Cell* 17: 429-439.
- Thomas, M., and R. W. Davis, 1974. Studies on the cleavage of bacteriophage lambda DNA with EcoRI restriction endonuclease. *J. Mol. Biol.* 91: 315-328.
- Twardzik, D. R., E. H. Grell, and K. B. Jacobson, 1971. Mechanism of suppression in *Drosophila*: A change in tyrosine transfer RNA. *J. Mol. Biol.* 57: 231-245.
- Waterston, R. H., and S. Brenner, 1978. A suppressor mutation in the nematode acting on specific alleles of many genes. *Nature* 275: 715-719.
- White, B.N., G.M. Tener, J. Holden, and D.T. Suzuki, 1973. Activity of a tRNA modifying enzyme during the development of *Drosophila* and its relationship to the su(s) locus. *J. Mol. Biol.* 74: 635-660.