



National Library
of Canada

Bibliothèque nationale
du Canada

Canadian Theses Service

Services des thèses canadiennes

Ottawa, Canada
K1A 0N4

CANADIAN THESES

THÈSES CANADIENNES

NOTICE

The quality of this microfiche is heavily dependent upon the quality of the original thesis submitted for microfilming. Every effort has been made to ensure the highest quality of reproduction possible.

If pages are missing, contact the university which granted the degree.

Some pages may have indistinct print especially if the original pages were typed with a poor typewriter ribbon or if the university sent us an inferior photocopy.

Previously copyrighted materials (journal articles, published tests, etc.) are not filmed.

Reproduction in full or in part of this film is governed by the Canadian Copyright Act, R.S.C. 1970, c. C-30. Please read the authorization forms which accompany this thesis.

**THIS DISSERTATION
HAS BEEN MICROFILMED
EXACTLY AS RECEIVED**

AVIS

La qualité de cette microfiche dépend grandement de la qualité de la thèse soumise au microfilmage. Nous avons tout fait pour assurer une qualité supérieure de reproduction.

S'il manque des pages, veuillez communiquer avec l'université qui a conféré le grade.

La qualité d'impression de certaines pages peut laisser à désirer, surtout si les pages originales ont été dactylographiées à l'aide d'un ruban usé ou si l'université nous a fait parvenir une photocopie de qualité inférieure.

Les documents qui font déjà l'objet d'un droit d'auteur (articles de revue, examens publiés, etc.) ne sont pas microfilmés.

La reproduction, même partielle, de ce microfilm est soumise à la Loi canadienne sur le droit d'auteur, SRC 1970, c. C-30. Veuillez prendre connaissance des formules d'autorisation qui accompagnent cette thèse.

**LA THÈSE A ÉTÉ
MICROFILMÉE TELLE QUE
NOUS L'AVONS REÇUE**

National Library
of CanadaBibliothèque nationale
du Canada

Canadian Theses Division Division des thèses canadiennes

Ottawa, Canada
K1A 0N4**PERMISSION TO MICROFILM — AUTORISATION DE MICROFILMER**

- Please print or type — Écrire en lettres majuscules ou dactylographier

Full Name of Author — Nom complet de l'auteur

MARK YEREX, ACKERMAN

Date of Birth — Date de naissance

SEPT 1, 1956

Country of Birth — Lieu de naissance

CANADA

Permanent Address — Résidence fixe

8530 80 AVE
EDMONTON.

Title of Thesis — Titre de la thèse

A. STUDY OF RESIDENTIAL HOUSING, ENVELOPE
HEAT LOSSES.

University — Université

U of A.

Degree for which thesis was presented — Grade pour lequel cette thèse fut présentée

Msc Engineering

Year this degree conferred — Année d'obtention de ce grade

1983.

Name of Supervisor — Nom du directeur de thèse

DR. Doug Dale

Permission is hereby granted to the NATIONAL LIBRARY OF CANADA to microfilm this thesis and to lend or sell copies of the film.

The author reserves other publication rights, and neither the thesis nor extensive extracts from it may be printed or otherwise reproduced without the author's written permission.

L'autorisation est, par la présente, accordée à la BIBLIOTHÈQUE NATIONALE DU CANADA de microfilmer cette thèse et de prêter ou de vendre des exemplaires du film.

L'auteur se réserve les autres droits de publication; ni la thèse ni de longs extraits de celle-ci ne doivent être imprimés ou autrement reproduits sans l'autorisation écrite de l'auteur.

Date

April 20/83

Signature

Mark Ackerman

THE UNIVERSITY OF ALBERTA

A Study of Residential Housing Envelope Heat Losses

by

Mark Y. Ackerman



A THESIS

SUBMITTED TO THE FACULTY OF GRADUATE STUDIES AND RESEARCH
IN PARTIAL FULFILMENT OF THE REQUIREMENTS FOR THE DEGREE
OF Master of Science

Department of Mechanical Engineering

EDMONTON, ALBERTA

Fall 1983

THE UNIVERSITY OF ALBERTA

RELEASE FORM

NAME OF AUTHOR Mark Y. Ackerman
TITLE OF THESIS A Study of Residential Housing Envelope
Heat Losses
DEGREE FOR WHICH THESIS WAS PRESENTED Master of Science
YEAR THIS DEGREE GRANTED Fall 1983

Permission is hereby granted to THE UNIVERSITY OF ALBERTA LIBRARY to reproduce single copies of this thesis and to lend or sell such copies for private, scholarly or scientific research purposes only.

The author reserves other publication rights, and neither the thesis nor extensive extracts from it may be printed or otherwise reproduced without the author's written permission.

(SIGNED) *Mark Ackerman*

PERMANENT ADDRESS:

8530 80 AVENUE
EDMONTON, ALBERTA
CANADA

DATED *OCTOBER 14* 1983

THE UNIVERSITY OF ALBERTA
FACULTY OF GRADUATE STUDIES AND RESEARCH

The undersigned certify that they have read, and recommend to the Faculty of Graduate Studies and Research, for acceptance, a thesis entitled A Study of Residential Housing Envelope Heat Losses submitted by Mark Y. Ackerman in partial fulfilment of the requirements for the degree of Master of Science.

.....

Supervisor

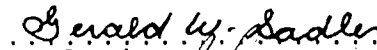
.....

.....

Date... APRIL 19, 1983

Abstract

An attempt was made to evaluate the methods proposed by the American Society of Heating Refrigeration and Air Conditioning Engineers with regard to their suitability for the prediction of seasonal energy requirements in residential structures. It was found that the steady state method proposed was acceptable for the prediction of losses for the majority of the above grade components tested as long as the structure was not built to utilize passive solar gains.

The study allowed the determination of several areas in which the methods proposed were extremely difficult to use or were highly dependent on material properties which are not well known or may vary under in situ conditions.

The first problem area identified was the estimation of infiltration rates under in situ conditions. Infiltration rates determined using Sulphur Hexafluoride gas concentration decay methods were found to be 0.25 to 0.75 air changes per hour under typical winter conditions. Leakage rates predicted using ASHRAE methods, based on the number of breaches in the building envelope, were in the range of 0.5 to 1.5 air changes per hour.

The area in which most discrepancies occurred were those structures below grade. The magnitude of the deviation from predicted values was found to increase with depth below grade. It was felt that the primary reasons for the

differences between measurements and predictions were due to variations in soil moisture content from the assumed values and the time lag of ground temperature variations with respect to the ambient seasonal variation.

Acknowledgements

This work is dedicated to the memory of Dr. R.R. Gilpin, the initiator of The Alberta Home Heating Research Facility, who passed away prior to the completion of the study, but will always be remembered.

I also wish to express my thanks and appreciation to Dr. J.D. Dale for his support and for our many discussions during the course of the study.

I further wish to thank the technicians, Terry Nord and Wayne Pittman, for their patience and help with the electronics used throughout the project.

Financial support for this project through the Alberta/Canada Energy Resources Research Fund, a joint program of the Federal and Alberta governments and administered by Alberta Energy and Natural Resources, is gratefully acknowledged.

Table of Contents

Chapter	Page
1. Introduction	1
2. Facility Description	4
3. Data Logging System	17
3.1 Temperature Measurement	20
3.2 Electrical Power Input Measurement	22
3.3 Solar Radiation Measurement	25
3.4 Heat Flow Measurements	27
3.5 Wind Speed and Direction	28
3.6 Air Infiltration Measurements	29
4. General Analysis of Data	31
5. Measurement of Component Heat Transfer	53
6. Conclusions and Recommendations	72
Bibliography	75
Appendix A1	77
Appendix A2	80
Appendix A3	88
Appendix A4	132

List of Tables

Table	page
1 Specifications - Module 1	10
2 Specifications - Module 2	11
3 Specifications - Module 3	12
4 Specifications - Module 4	13
5 Specifications - Module 5	14
6 Specifications - Module 6	15
7 Nominal Insulation Levels	16
8 Calculated Transmission Coefficients	32
9 Transmission Coefficients with one Half Air Change Per Hour	33
10 Measured Transmission Coefficients - Hourly Basis	35
11 Measured Cumulative Transmission Coefficients	45
12 Summary of Infiltration Measurements 1980	46
13 Measured Thermal Resistance - Above Grade Walls	62
14 Measured Thermal Resistance - Ceilings	63
15 Measured Thermal Resistance - Basement Walls	64
16 Measured Thermal Resistance - Basement Floors	65
17 Measured Average Heat Losses for Building Components over the 1981-1982 Heating Season	70

List of Figures

Figure	page
1 Testing Facility Site Plan	7
2 Typical Module Elevation	8
3 Data Logging System Schematic	19
4 Temperature Sensor Locations	21
5 Ground Temperature Measurement Locations	23
6 Radiation Measurement Locations	26
7 Cumulative Transmission Coefficient - Module	
1	36
8 Cumulative Transmission Coefficient - Module	
2	37
9 Cumulative Transmission Coefficient - Module	
3	38
10 Cumulative Transmission Coefficient -	
Module 4	39
11 Cumulative Transmission Coefficient -	
Module 5	40
12 Cumulative Transmission Coefficient -	
Module 6	41
13 Temperature Dependence of Air Infiltration	50
14 Wind Speed Dependence of Air Infiltration	51
15 Derivation of an Empirical Relationship	
for Prediction of Infiltration	52
16 Measured Heat Flux as a Function of Indoor	
- Outdoor Temperature Difference - Module	
2 Ceiling	55

17 Measured Heat Flux as a Function of Indoor - Outdoor Temperature Difference - Module 2 Above Grade Walls	56
18 Measured Heat Flux as a Function of Indoor - Outdoor Temperature Difference - Module 2 Above Grade Basement Walls	57
19 Measured Heat Flux as a Function of Indoor - Outdoor Temperature Difference - Module 2 Below Grade Basement Walls	58
20 Measured Heat Flux as a Function of Indoor - Outdoor Temperature Difference - Module 2 Basement Floor	59
21 Ambient Dry Bulb September 1 - March 30 1981	67
22 Ground Temperature at Three Depths September 1 - March 30, 1981	68
A1.1 Watt Meter Interface Schematic 1	78
A1.2 Watt Meter Interface Schematic 2	79
A2.1 Heat Flux Plate Construction	81
A2.2 Heat Flux Plate Locations - Module 1	82
A2.3 Heat Flux Plate Locations - Module 2	83
A2.4 Heat Flux Plate Locations - Module 3	84
A2.5 Heat Flux Plate Locations - Module 4	85
A2.6 Heat Flux Plate Locations - Module 5	86
A2.7 Heat Flux Plate Locations - Module 6	87
A3.1 Heat Flow Paths - Basement Module 1	96
A3.2 Heat Flow Paths - Ceiling Module 3	112

A3.3 Heat Flow Paths - Wall Module 3	113
A3.4 Heat Flow Paths - Basement Module 3	114
A3.5 Heat Flow Paths - Ceiling Module 4	123
A3.6 Heat Flow Paths - Wall Module 4	124
A3.7 Heat Flow Paths - Basement Module 4	125
A4.1 Calculation of Average Soil Path Length	136
A4.2 Heat Flow Paths for a Typical Basement Floor	137

1. Introduction

Prior to 1970 the field of energy conservation was largely unexplored because of the availability of inexpensive energy. As the economies of both the United States and Canada grew it became apparent that if the growth of energy consumption continued at the then present level supplies of non-renewable fossil fuels could be exhausted in the foreseeable future. Shortages in liquid and gaseous fuels, whether real or artificially created, coupled with inflationary economies forced people to become increasingly aware of the potential for hardship that existed if the trends continued. The result was that a large number of people began exploring methods by which the dependence on fossil fuels could be lessened. Technologies such as the collection of solar energy or the tapping of geothermal energy which were known but largely unexplored to that time immediately became areas of intensive research. When it was realized that the solution to the problem of declining reserves did not only lie in the development of new sources of energy, people began to look for ways of reducing consumption .

A significant area of potential energy savings was the overall reduction in the amount of energy consumed in the heating of residential structures. For years the designers of single family houses and small apartment buildings had paid little or no attention to the calculation of building

envelope losses for reasons other than the sizing of heating or cooling systems. Presently however, designers have undertaken to reduce the quantity of energy necessary to adequately heat a structure and maintain comfort conditions. In order to design a structure for the minimization of input energy it is necessary to have confidence that the methods of analysis used are sufficiently accurate so that all components can be sized for maximum efficiency.

The most accepted method of analysis of building energy requirements utilizes a set of guidelines published by the American Society of Heating Refrigeration and Air Conditioning Engineers or ASHRAE. Some doubt exists as to whether or not the methods outlined in the 1977 Handbook of Fundamentals are sufficiently accurate to be used for the evaluation of conservation strategies.

At the outset of a comparison of the performance of a structure with accepted prediction methods several areas of concern become immediately apparent. Because the presence of occupants can have an extreme effect on the overall performance of a building, the ideal test structure should be unoccupied. The thermal properties of building materials, if known, are normally determined using methods such as the guarded hot box under steady state conditions. Materials used under in situ transient conditions may not perform identically with those in the laboratory environment. Predictions of basement heat losses assume average soil properties as well as an established ground temperature

regime. Some doubt exists as to whether or not the methods for the prediction of losses from below grade portions of buildings are applicable to newly completed structures or must one wait several years for the establishment of quasi steady state conditions.

This investigation is primarily concerned with the identification of the areas of the thermal envelope which cannot be well defined using the one dimensional steady state analysis proposed by ASHRAE. Although areas such as the measurement and prediction of air infiltration rates were explored the purpose of the study was not to develop new methods of predicting building performance, but to identify those areas for which the presently accepted methods are inadequate.

2. Facility Description

The testing or evaluation of any type of accepted method for the prediction of building behavior under in situ conditions must take place with several factors in mind. Firstly, the test setup should be such that the number of randomly varying parameters is minimized. Secondly, one must be sure that the results obtained are general enough that they may be applied outside the bounds of an experimental environment. Finally, the results must be sufficiently detailed so as to be repeatable and to ensure that the final conclusions are correct and not a misinterpretation of the available data.

The Alberta Home Heating Research Facility was constructed in the summer of 1979 to be used as an aid in the research and development of optimum insulation - heating strategies for a northern climate. In order to evaluate a number of varied insulation levels a series of six scaled down house replicas were constructed. Each of the modules has incorporated into the structure one or more unique features, such as south facing windows or upgraded insulation. It was felt that the individual contribution of each component could be determined with the aid of a computer controlled data acquisition system over a period of several heating seasons.

The basic research strategy with the facility was to gather data from each module on a continuous basis and from

the data gathered to refine several existing simulation programs as well as determine the the most cost effective energy conservation strategy for the Edmonton area climate.

The site plan of the facility is shown in Fig.1. Each of the six modules is roughly 49 square meters in area and has a standard height concrete basement. All of the buildings were framed using conventional 2 inch by 4 inch (50mm by 100mm) studs 16 inches (406mm) on center and the only unusual framing aspect is a stepped roof truss which can accommodate up to 0.85 meters of insulation. A typical module elevation is shown in Fig.2. Tables 1 through 6 list the general specifications of each module as constructed in 1979. Nominal insulation levels, Table 7, indicate that the modules give a good representation of the wide assortment of insulation levels found in existing housing stock.

Module 1, the "Short Term" module was constructed with large removable panels in each wall to allow the insitu testing of alternative wall or window configurations. Prior to 1982 the module although monitored was used primarily as an instrument shelter and a control for the remaining five modules.

Module 2, the "Standard" module was built to pre-1970 construction standards in that the walls and ceiling contain minimal insulation. The windows and door were chosen to reflect the characteristics of pre-1970 standard components, namely low insulating value and ineffective weather stripping. No insulation of any form was applied to the

below grade portion of the structure nor was any attempt made to ensure the continuity of the air-moisture barrier.

The third module, the "Conservation" module was constructed with insulation levels consistent with houses built during the late 1970's under the name, "Superinsulated" houses. As shown in table 3, insulation was applied to the exterior of both above and below grade portions of the structure, and while the method of application differs somewhat from that used in "Superinsulated" houses the results should be representative. The windows and door for the module were chosen so as to minimize conduction losses as well as reduce infiltration rates. One should note that the module does not have an installed furnace flue. This factor is consistent with the philosophy that the majority of the heating load can be met with the waste heat given off by appliances, fixtures, and occupants and any difference could be supplied with a small electric heater.

Module 4, the "Passive" module, was constructed with moderate insulation levels and a large area of south facing glazing. It was envisioned that the results obtained from the unit would add to the information available for use in the design of passively heated structures and at the same time identify some of the problems associated with passive homes, such as excessive overheating in the summer months.

Modules 5 and 6, referred to as the "Active Liquid" and "Active Air" modules respectively, were constructed firstly

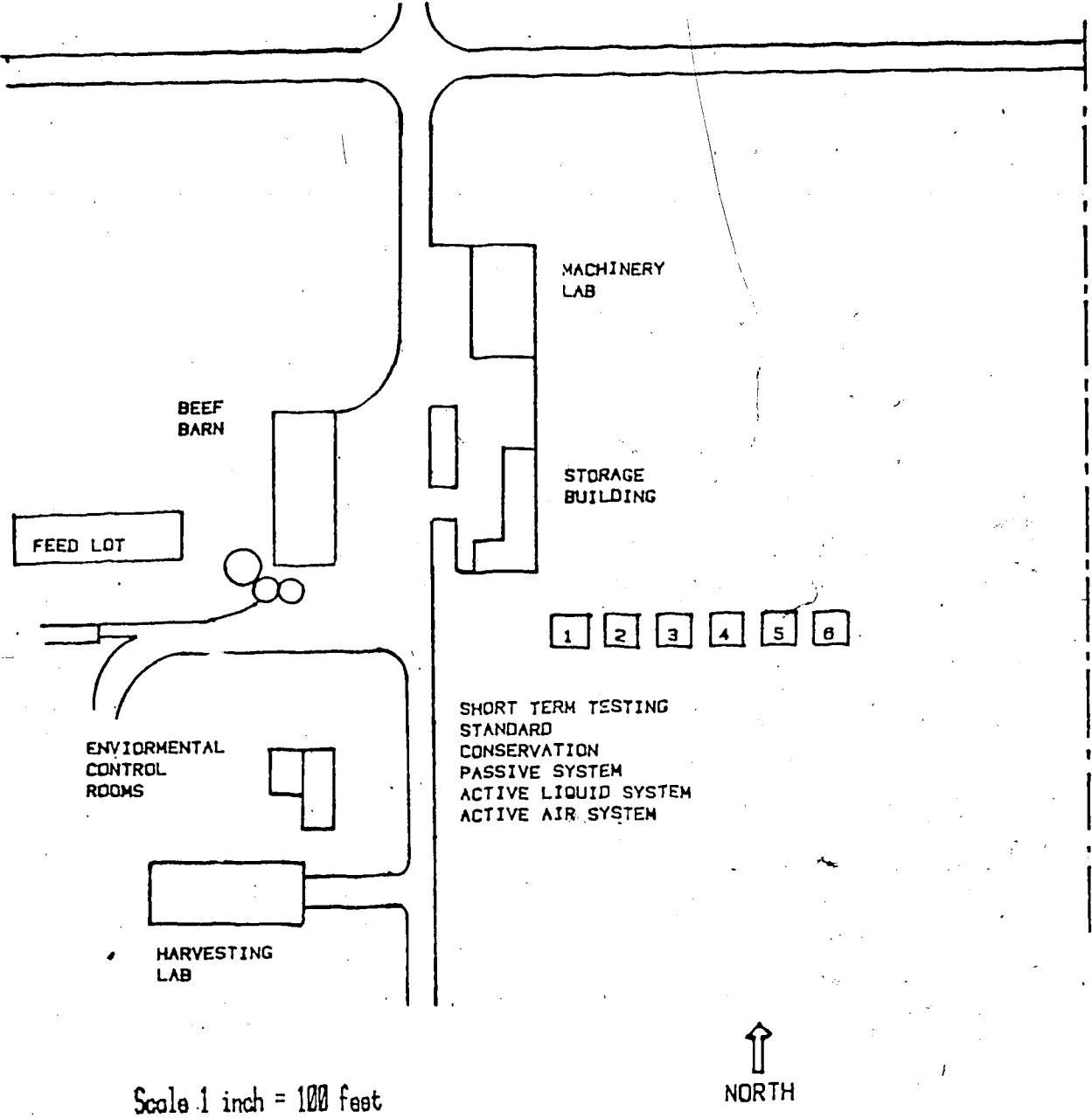

Scale 1 inch = 100 feet

↑
NORTH

Figure 1 Testing Facility Site Plan

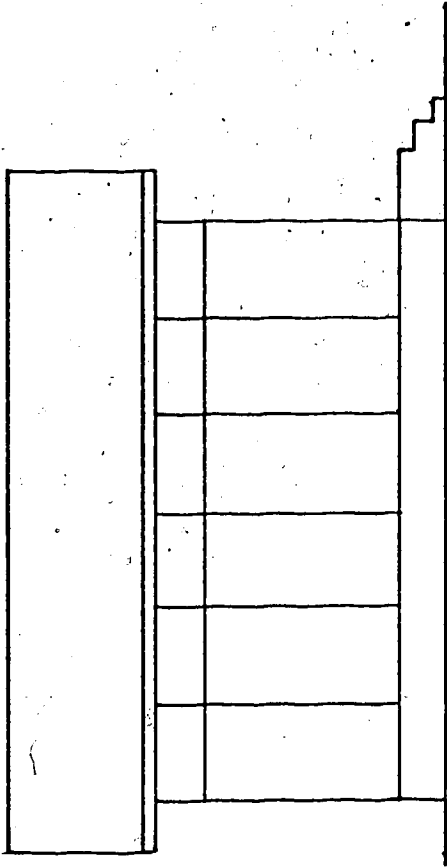

South Elevation

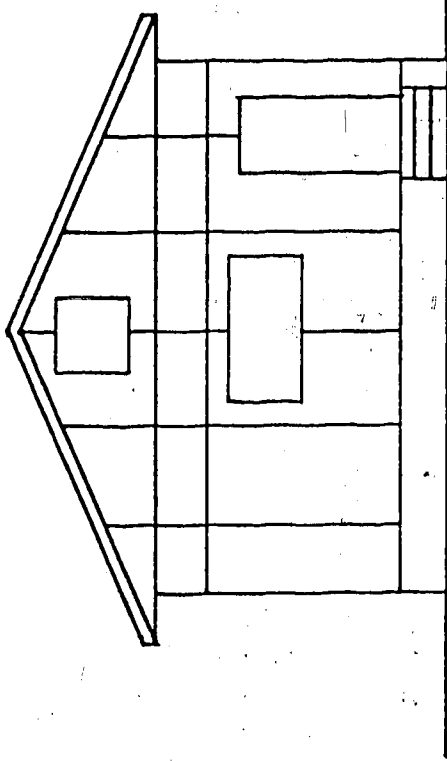

East Elevation

Figure 2 Typical Module Elevation

to compare the performance of two identical structures under in situ conditions, and secondly to assess the operating characteristics of two active solar systems with different working fluids operating under identical conditions. It should be noted that when constructed, the two modules had identical insulation levels. At the outset of the project it was intended that an active liquid solar system be installed in module 5 and an active air system in module 6 but because of budgetary constraints only the active air system was installed. It should also be noted that although Table 6 shows the ceiling insulation level in Unit 6 to be R 12 (RSI 2.1) it was upgraded to R 32 (RSI 5.63) in February 1980.

Table 1

Specifications - Module 1

Exterior Dimensions	22.0x24.0 feet
Interior Dimensions	21' 4"x23' 4"
Main Floor Wall Height	8 feet
Basement - wall height	8 feet
- wall thickness	8 inches
- floor thickness	4 inches

Ceiling Construction

- standard truss with 2 foot bobtail
- rafters 24 inch on center
- fiberglass insulation R-12 (RSI-2.11)
- 4 mil polythene vapour barrier

Wall Construction

- 2x4 inch framing, 16 inch on center
- fiberglass insulation R-10 (RSI-1.76)
- 4 mil polythene vapour barrier
- 3/8 inch prestained plywood exterior finish

Windows

- North Wall - 40in.x76in. sealed unit (double glazed)
- South Wall - none
- East Wall - 40in.x76in. horizontal slider,
aluminum frame
- West Wall - 40in.x76in. horizontal slider,
aluminum frame

Door - 3'0"x6'8" solid core fir (1.5" thick)

Basement Insulation

- 2 inch (R-5 per inch) polystyrene
to two feet below grade
- 0.5 inch pressure treated plywood
insulation cover

Auxilliary Heat - 10 kW electric duct heater

Interior Finish - painted 1/2 inch gypsum board

Table 2

Specifications - Module 2

Exterior Dimensions	22.0x24.0 feet
Interior Dimensions	21' 4" x 23' 4"
Main Floor Wall Height	8 feet
Basement - wall height	8 feet
- wall thickness	8 inches
- floor thickness	4 inches

Ceiling Construction

- standard truss with 2 foot bobtail
- rafters 24 inch on center
- fiberglass insulation R-12 (RSI-2.11)
- 4 mil polythene vapour barrier

Wall Construction

- 2x4 inch framing, 16 inch on center
- fiberglass insulation R-8 (RSI-1.41)
- 4 mil polythene vapour barrier
- 3/8 inch prestained plywood exterior finish

Windows

- North Wall - 40in.x76in. sealed unit (double glazed)
- South Wall - none
- East Wall - 40in.x76in. horizontal slider,
aluminum frame
- West Wall - 40in.x76in. horizontal slider,
aluminum frame

Door - 3' 0" x 6' 8" solid core fir (1.5" thick)

Basement Insulation

- none

Auxilliary Heat - 12 kW electric duct heater

Interior Finish - painted 1/2 inch gypsum board

Table 3

Specifications - Module 3

Exterior Dimensions	23' 4" x 25' 4"
Interior Dimensions	21' 4" x 23' 4"
Main Floor Wall Height	8 feet
Basement - wall height	8 feet
- wall thickness	8 inches
- floor thickness	4 inches

Ceiling Construction

- standard truss with 2 foot bobtail
- rafters 24 inch on center
- fiberglass insulation R-80 (RSI-14.08)
- 6 mil polythene vapour barrier

Wall Construction

- 2x4 inch framing, 16 inch on center
- 8 inches polystyrene, R-40 (RSI-7.04)
- 6 mil polythene vapour barrier
- 3/8 inch prestained plywood exterior finish

Windows

- North Wall - none
- South Wall - 113in.x76in. sealed unit,
double glazed
- East Wall - 40in.x40in. sealed unit,
double glazed
- West Wall - none

Door - 3' 0" x 6' 8" urethane foam core

Basement Insulation

- 4 inch (R-5 per in.) to foundation
- 0.5 inch pressure treated plywood insulation cover

Auxilliary Heat - 7.5 kW electric duct heater

Interior Finish - painted 1/2 inch gypsum board

Table 4

Specifications - Module 4

Exterior Dimensions	22' 4" x 24' 4"
Interior Dimensions	21' 4" x 23' 4"
Main Floor Wall Height	8 feet
Basement - wall height	8 feet
- wall thickness	8 inches
- floor thickness	4 inches
Ceiling Construction	
- standard truss with 2 foot bobtail	
- rafters 24 inch on center	
- fiberglass insulation R-40 (RSI-7.04)	
- 6 mil polythene vapour barrier	
Wall Construction	
- 2x4 inch framing, 16 inch on center	
- fiberglass insulation R-10 (RSI-1.76)	
- 2 inch polystyrene on exterior	
- 6 mil polythene vapour barrier	
- 3/8 inch prestained plywood exterior finish	
Windows	
North Wall - none	
South Wall - 2-113in.x76in. sealed unit, double glazed	
East Wall - 40in.x40in. sealed unit, double glazed, opening	
West Wall - none	
Door - 3' 0" x 6' 8" urethane foam core	
Basement Insulation	
- 2 inch (R-5 per inch) polystyrene to foundation	
- 0.5 inch pressure treated plywood insulation cover	
Auxilliary Heat - 7.5 kW electric duct heater	
Interior Finish - painted 1/2 inch gypsum board	

Table 5

Specifications - Module 5

Exterior Dimensions	22.0x24.0 feet
Interior Dimensions	21' 4"x23' 4"
Main Floor Wall Height	8 feet
Basement - wall height	8 feet
- wall thickness	8 inches
- floor thickness	4 inches

Ceiling Construction

- standard truss with 2 foot bobtail
- rafters 24 inch on center
- fiberglass insulation R-12 (RSI-2.11)
- 4 mil polythene vapour barrier

Wall Construction

- 2x4 inch framing, 16 inch on center
- fiberglass insulation R-10 (RSI-1.76)
- 4 mil polythene vapour barrier
- 3/8 inch prestained plywood exterior finish

Windows

- North Wall - 40in.x76in. sealed unit,
double glazed
- South Wall - none
- East Wall - 40in.x76in. horizontal slider,
vinyl frame
- West Wall - 40in.x76in. horizontal slider,
vinyl frame

Door - 3' 0"x6' 8" urethane foam core

Basement Insulation

- 2 inch (R-5 per inch) polystyrene
to two feet below grade
- 0.5 inch pressure treated plywood
insulation cover

Auxilliary Heat - 7.5 KW electric duct heater

Interior Finish - painted 1/2 inch gypsum board

Table 6

Specifications - Module 6

Exterior Dimensions	22.0x24.0 feet
Interior Dimensions	21' 4" x 23' 4"
Main Floor Wall Height	8 Feet
Basement - wall height	8 feet
- wall thickness	8 inches
- floor thickness	4 inches

Ceiling Construction

- standard truss with 2 foot bobtail
- rafters 24 inch on center
- fiberglass insulation R-12 (RSI-2.11)
- 4 mil polythene vapour barrier

Wall Construction

- 2x4 inch framing, 16 inch on center
- fiberglass insulation R-10 (RSI-1.76)
- 4 mil polythene vapour barrier
- 3/8 inch prestained plywood exterior finish

Windows

- North Wall - 40in.x76in. sealed unit, double glazed
- South Wall - none
- East Wall - 40in.x76in. horizontal slider, vinyl frame
- West Wall - 40in.x76in. horizontal slider, vinyl frame

Door - 3' 0" x 6' 8" urethane foam core

Basement Insulation

- 2 inch (R-5 per inch) polystyrene to two feet below grade
- 0.5 inch pressure treated plywood insulation cover

Auxilliary Heat - 7.5 kW electric duct heater

Interior Finish - painted 1/2 inch gypsum board

Table 7 Nominal Insulation Levels

Module	Ceiling	Wall	Basement
1) Short term	12(2.11)	10(1.76)	10(1.76)*
2) Standard	12(2.11)	8(1.41)	-
3) Conservation	80(14.08)	40(7.04)	20(3.52) **
4) Passive	40(7.04)	20(3.52)	10(1.76) **
5) Active Liquid	12(2.11)	10(1.76)	10(1.76)*
6) Active Air	32(5.64)	10(1.76)	10(1.76)*

* From floor level to two feet below grade
 ** Full height

3. Data Logging System

The accurate prediction of the contribution of any building component to the overall heating or cooling load requires the determination of a number of parameters. The simplest form of analysis relies on the following three measurements.

- 1) energy input to the structure
- 2) room air temperature
- 3) ambient air temperature

From these three measurements it is possible to calculate an overall transmission coefficient of the following form.

$$Q_{loss} = UxArea \times \text{Temperature difference}$$

$$UxArea = \text{Transmission coefficient}$$

Although this type of calculation gives one a benchmark against which one can gauge the overall performance of the structure it helps little in the determination of the contribution of each component to the heating load. Consequently one must resort to other methods of determining component losses and in turn the most cost effective insulation schemes. Thus in order to create a model of suitable accuracy at least the following parameters must be determined or refinement of the model cannot take place.

- 1) Room air temperature
- 2) Basement air temperature

- 3) Attic air temperature
- 4) Energy input to the structure
- 5) Available solar radiation
- 6) Thermal properties of individual components
- 7) Ground temperature on a seasonal basis
- 8) Wind speed and direction
- 9) Air infiltration rate

The nature of the measurements taken precluded manual logging of data so it was necessary to purchase a microprocessor-based system to monitor multiple inputs on a continuous basis. The system decided upon was an Analog Devices Macsym II data logger. The unit has the capability of accepting both analog and digital information and as well has cold junction compensation for use with thermocouples. The system used a twelve bit analog to digital converter which implies a resolution of one part in 4096 of the full scale analog measurement. During 1980 the basic logger was used as supplied from the manufacturer but as the number of desired measurements increased the system was modified with the addition of an external multiplexer. A schematic of the overall system is shown in Fig. 3. The system during 1981 had the capability of monitoring in excess of 100 analog inputs as well as limited digital input-output.

The system was used during 1981 to monitor temperatures at more than 30 locations, radiation at five locations, wind speed and direction from two 10 meter towers, energy input to each module and heat flux at more than 40 locations.

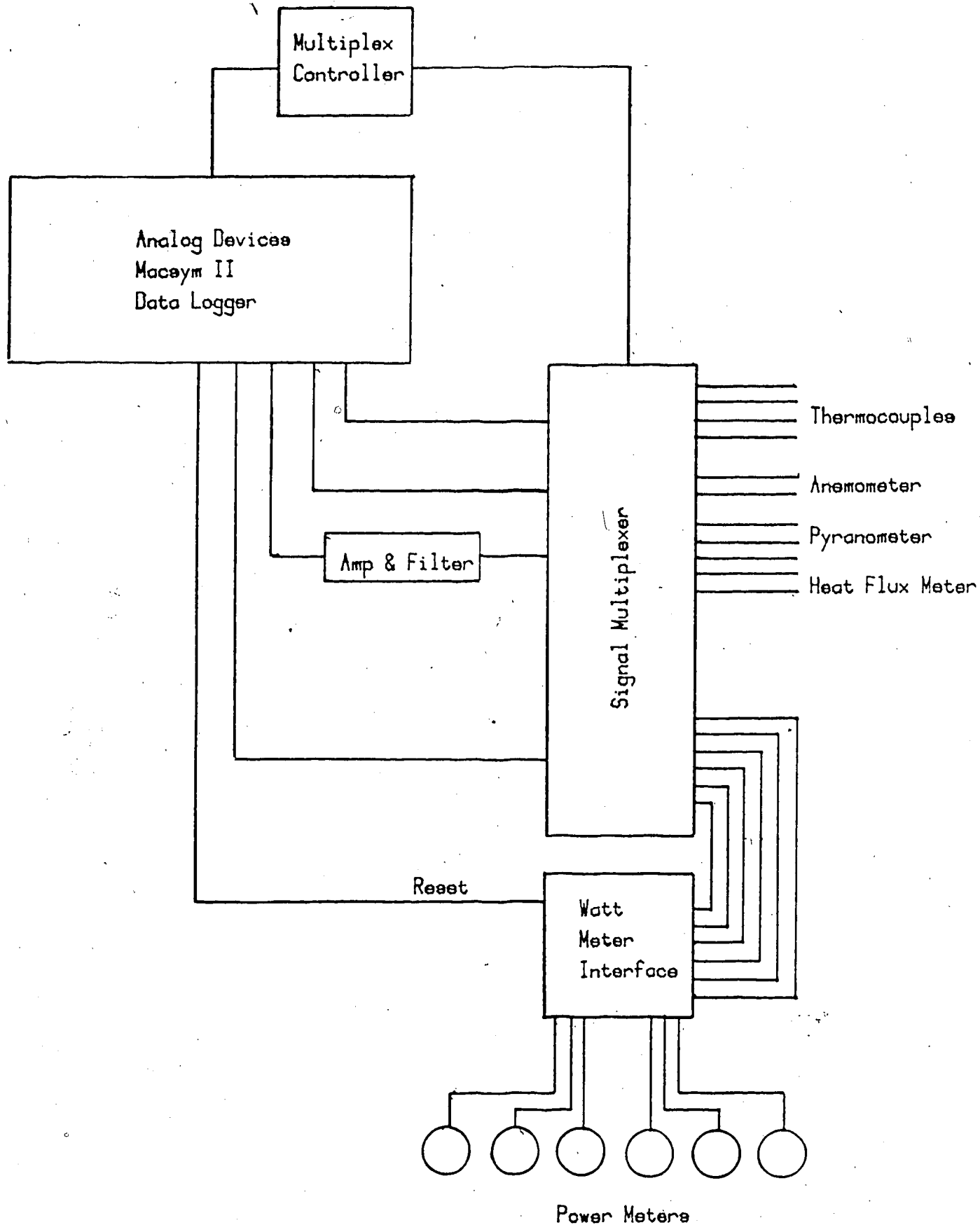

Figure 3 Data Logging System Schematic

The following description of the measurement methodology is necessary to assure the reader that the results later used for comparison with ASHRAE predictions are valid and accurate.

3.1 Temperature Measurement

Temperatures were measured using Copper-Constantan thermocouples and cold junction compensation provided by the data logger. Measurements were taken at two minute intervals and an average was calculated and recorded at the end of each hour. The general location of each temperature sensor is shown in Fig. 4. It was found to be necessary to calibrate each thermocouple at ice point because of errors in measurement found during the initial testing. The errors were later found to be due to excessive thermocouple lead length coupled with the microcomputer's thermocouple break detection system. It was also necessary to install capacitors across the input leads in order to reduce an imbalance in common mode signal on the input lines at approximately 1MHz.

Each of the measurement locations was chosen to serve a specific purpose. Attic temperature measurement allowed the determination of the true temperature difference across each ceiling rather than having to rely on the assumption of equal attic and ambient temperatures. The room and basement

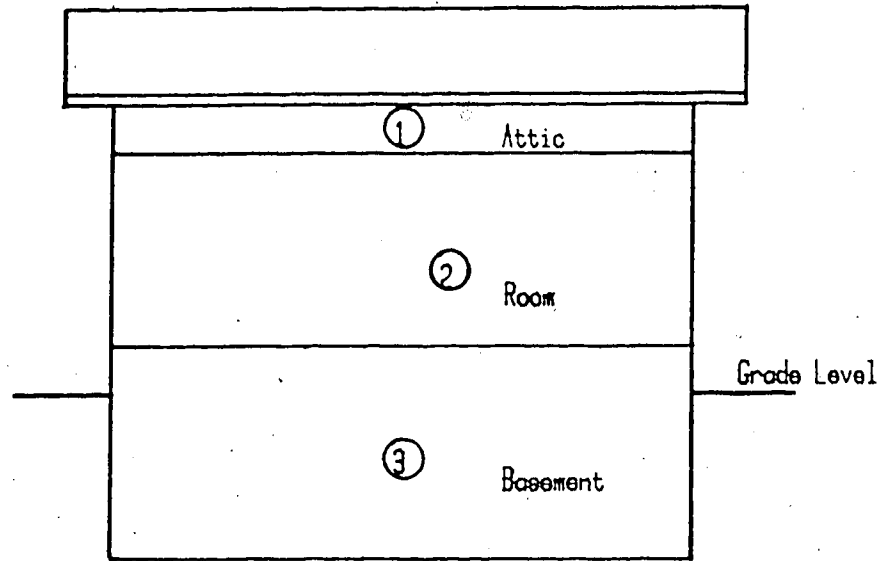

South Elevation

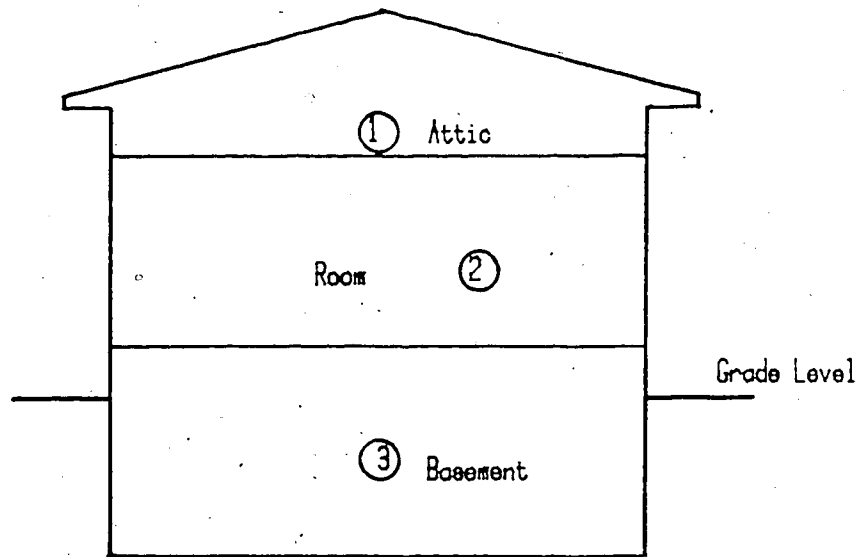

East Elevation

Figure 4 Temperature Sensor Locations

air temperature measurements were used to check whether stratification was present in the structure and allowed the calculation of an accurate Heating Degree Day figure for use in the estimation of steady state heat losses.

The ambient air temperature measurement was used in the calculation of steady state heat losses and could be used to establish a meteorological data base for the Edmonton area.

Ground temperature measurement stations, indicated in Fig. 5 were added in 1981 to try to evaluate the methods suggested for the calculation of heat loss from below grade structure as well as determine the time necessary for the establishment of a quasi-steady state ground temperature profile.

Resolution of the data logger - thermocouple combination was approximately 0.13 degrees Celsius using Copper-Constantan thermocouples, but with inaccuracies in gain and cold junction compensation the overall system accuracy was limited to 0.5 degrees Celsius.

3.2 Electrical Power Input Measurement

At the outset of the project it was decided that the modules should be electrically heated so that an accurate measurement of input energy could be obtained without errors introduced through the calculation of the conversion efficiency of natural gas fired furnaces and without having

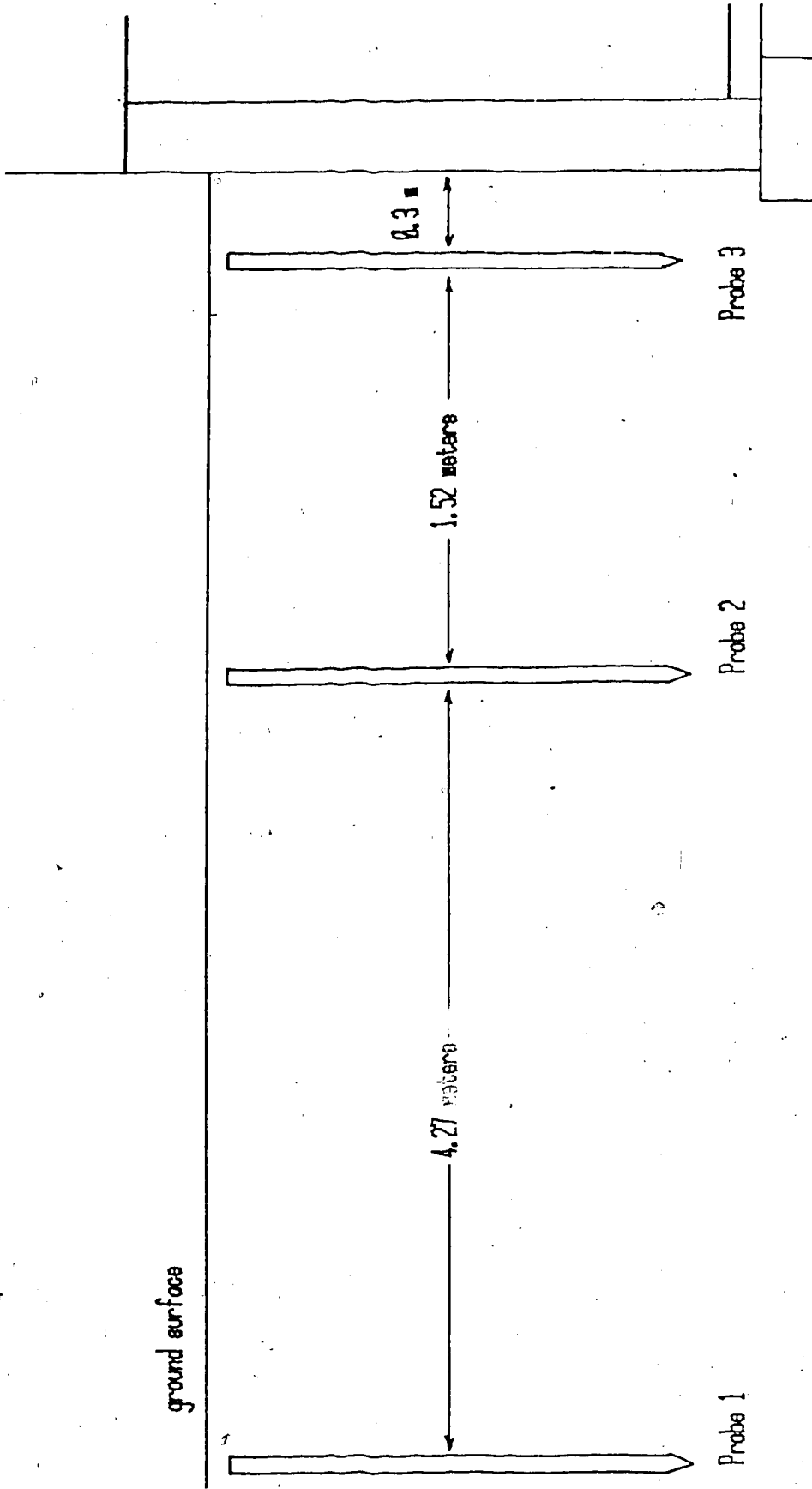

Figure 5 Ground Temperature Measurement Locations

to keep track of the varying heating values of fuel supplied to residential districts. It was also felt that since the modules have electric lights and fan motors the energy contributed by these two sources would have to be determined in any case.

Measurement of power input to each module was accomplished using a standard Sangamo residential watt meter modified so that it could be read remotely and calibrated by the local utility company.

The modifications to the meter were relatively simple and were done as follows. The meter has an internal metal disk which is used for calibration procedures and which revolves once for each 12 watt-hours of power through the meter. The disk was modified by drilling twelve holes in the perimeter at equal intervals and positioning a light activated slot switch so that an electrical pulse was generated each time a hole passed through the switch. The output of the slot switch, a series of pulses, was fed to a counter which was capable of accumulating a count of 1024 pulses. The output of the counter was in turn connected to a digital to analog converter which was set to output ten millivolts per count. The data logger was programmed to look at the output from the D/A every two minutes and if the count was equal to or greater than a predetermined level, store the value and reset the counter. Resolution of the meter - logger combination was one watt-hour but the basic meter accuracy was determined to be 1%. A schematic of the

watt-meter interface is included in Appendix A1.

3.3 Solar Radiation Measurement

Radiation measurements were taken at the facility at the five locations shown in Fig. 6. The measurements were taken at two minute intervals and at the end of each hour were averaged and stored. The measurements that were taken are as follows.

- 1) Total horizontal radiation
- 2) Total vertical radiation
- 3) Diffuse radiation
- 4) Total vertical transmitted through a window
- 5) Total radiation falling on the active air collector surface

Three of the instruments, above numbers 2, 3, and 4 were Eppley model 8-48 black and white pyranometers while the remaining two were Eppley Model PSP precision pyranometers.

The output of the pyranometers was in the low milli-volt region so in order to ensure accuracy the signals were filtered and amplified using a low drift instrumentation amplifier (gain=100) before being fed to the data logger. The filtering eliminated most of the 1MHz noise that was found on all lines at the facility and the gain of 100 ensured that the signal was well above the data loggers

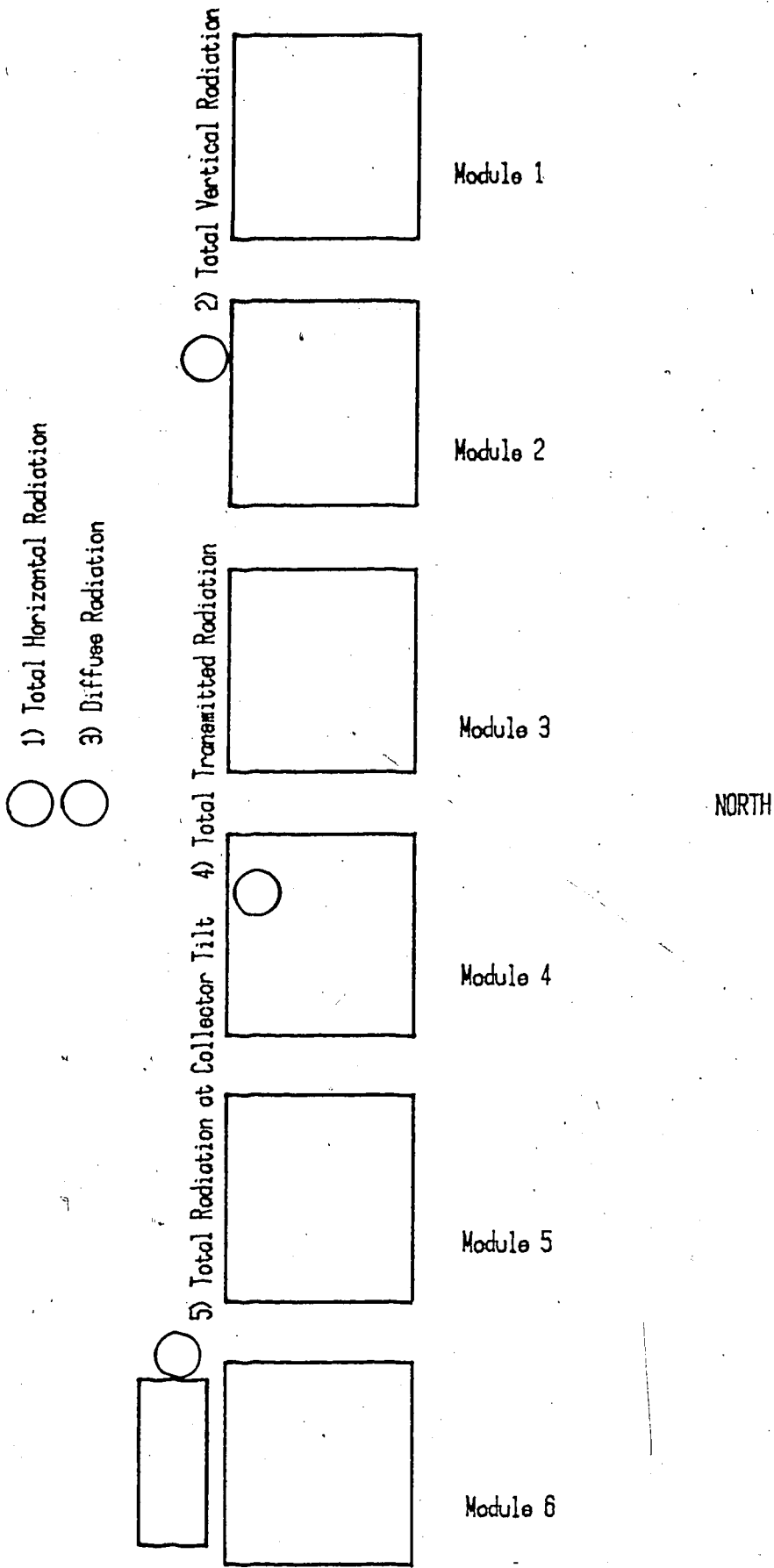

Figure 6 Radiation Measurement Locations

resolution.

3.4 Heat Flow Measurements

Heat flow through various building components was measured at the the facility using a heat flux gauge designed and built at the University of Alberta. The transducer consists of a series of thermocouples on each side of a quarter inch layer of cork which is sandwiched between two eighth inch plexiglass sheets. The thermocouples effectively measured the temperature difference across the cork insert and could therefore be calibrated at various heat flux rates.

The output of the transducer was low, approximately 1 millivolt per 4.6 Btu/hour-sq.ft. (14.6 Watt/sq.m), and therefore had to be filtered and amplified before being fed to the data logger.

The plates were physically quite large, 6 inches by 16 inches (15.2 cm by 40.6 cm) and therefore gave an average heat flux reading over a typical section of composite wall. Given that the air temperatures were known on both sides of a wall it was possible to determine the steady state thermal resistance of an as-installed composite wall section. The plates as installed did present problems when measurements of low thermal resistance wall sections were attempted. The most notable location for this type of problem to occur was

an above grade concrete wall. ASHRAE lists the thermal conductivity of concrete as $k = 12 \text{ Btu-in.}/(\text{hr. sq. ft. F})$ ($1.73 \text{ Watt}/\text{sq. m K}$). Thus an eight inch concrete wall would have an overall thermal resistance of the order of $1.5 \text{ hr. sq. ft. deg. F/Btu}$ ($\text{RSI } 0.026$) including air films. The heat flux transducer has a thermal resistance of approximately $1 \text{ hr. sq. ft. deg. F/Btu}$ and therefore the combined resistance that the transducer sees is about $2.5 \text{ hr. sq. ft. deg. F/Btu}$. This loading of the wall section could lead to an error in excess of 40 percent if one is not aware of the problem. The errors were much reduced as one would expect when the plates are applied to sections which had a thermal resistance on the order of ten or more times that of the plates.

Placement of the heat flux transducers are as shown in Figures A2.2 through A2.7.

3.5 Wind Speed and Direction

Wind speed and direction were measured at two locations at the facility. The meteorological towers were located approximately 33 meters north and south of the east-west midline of the buildings and approximately at the east-west midpoint.

The sensing heads, Athabaska Research Model - 540 were mounted at a 10 meter height and were located so that measurements of the free stream velocities were possible in

all directions with the exception of north-west where existing buildings disturb the flow.

The output from each sensing head was measured every two minutes by the data logger and the readings temporarily stored. At the end of each hour, the accumulated readings were used to calculate mean direction, mean speed, peak speed and the standard deviation of speed and direction. The measurements were primarily of use for the determination of the parameters affecting infiltration rates.

3.6 Air Infiltration Measurements

To ensure a complete energy audit, the contribution to the overall energy usage attributed to air infiltration must be determined. The method chosen for use at the facility was the measurement of the concentration decay of sulphur hexafluoride (SF6) tracer gas with time (4). A quantity of SF6 was injected into the return air duct of the heating system with the fan continuously operating and the concentration was monitored using a Wilkes Miran IA infrared analyzer. From the data obtained, the air exchange rate was determined using the following relationship, as suggested by ASHRAE(4).

$$C = C_0 \times \exp(-(t/Vol))$$

where C_0 = initial gas concentration

C = concentration at time t

t = time in hours

Vol = the air exchange rate in house volumes per hour

The data taken during the 1979-80 heating season was used only to try to establish an order of magnitude figure for each of the modules

During the 1980-81 heating season the measurement system was modified so that the logging of concentration was semi-automatic. The system software was written such that the concentration of tracer gas was allowed to decay until it reached approximately 1 ppm. At that point gas was reinjected to bring the concentration back to the original level of about 10 ppm and the decay was allowed to proceed again. The method allowed the measurement of the air exchange rate on a continuous basis which could then be used along with local weather data to try to determine the dependence of air infiltration on parameters such as temperature difference across the envelope or wind speed.

4. General Analysis of Data

During the 1979-80 heating season the modules were monitored to determine the energy usage of each under a measured set of ambient conditions. The information gathered allowed the establishment of a set of baseline consumption figures against which each of the modules could be compared to the standard module. Data taken during 1979-80 was also used as a benchmark against which the effects of later modifications to the modules could be evaluated.

In the following section the observed module performance is compared with predictions based on standard ASHRAE calculation methods. The complete calculations are included in Appendix A3. Table 8 is a summary of the calculations and lists the expected contribution of each building component to the total heating load. The data was derived using the assumption of steady state heat flow, accepted thermal properties for standard building materials and excludes the effects of air infiltration and solar gains.

For comparison purposes it is slightly more convenient to compare overall transmission coefficients rather than energy consumption figures. Table 9 gives the predicted energy usage for each module expressed as a percentage of the standard module. Thus for any given set of ambient conditions the method predicts that the Conservation module would consume 41% of the energy used by the standard

Table 8 - Calculated Component Transmission Coefficients

Module	UA - Btu/hour.-deg.F (W/K)						Total	
	Ceiling	Above Grade Walls	Above Grade Basement Walls	Below Grade Basement Walls	Basement Floor	Window		Door
1	41.0 (21.63)	62.4 (32.91)	14.7 (7.75)	59.8 (31.54)	15.3 (8.07)	37.4 (19.73)	9.8 (5.17)	240.4 (126.8)
2	42.9 (22.63)	72.2 (38.08)	94.8 (50.00)	104.8 (55.28)	15.3 (8.07)	37.4 (19.73)	9.8 (5.17)	377.2 (198.96)
3	6.4 (3.38)	15.1 (7.96)	4.4 (2.32)	22.4 (11.81)	15.3 (8.07)	34.7 (18.30)	3.8 (2.00)	102.1 (53.84)
4	12.3 (6.49)	28.0 (14.77)	14.6 (7.70)	35.4 (18.67)	15.3 (8.07)	59.0 (21.99)	3.8 (2.00)	168.4 (88.82)
5	42.9 (22.63)	62.4 (32.91)	14.7 (7.75)	59.8 (31.54)	15.3 (8.07)	29.8 (15.72)	3.8 (2.00)	228.7 (120.60)
6	16.1 (8.49)	62.4 (32.91)	14.7 (7.75)	59.8 (31.54)	15.3 (8.07)	29.8 (15.72)	3.8 (2.00)	201.3 (106.49)

Table 9 - Calculated Transmission Coefficient
With One Half Air Change per Hour

Module	UA	Infiltration	Total	
1	240.4 (126.8)	74.0 (39.0)	314.4 (165.8)	70%
2	377.2 (199.0)	74.0 (39.0)	451.2 (238.0)	100%
3	102.1 (53.8)	74.0 (39.0)	176.1 (92.9)	41%
4	168.4 (88.8)	74.0 (39.0)	242.4 (127.8)	54%
5	228.7 (120.6)	74.0 (39.0)	302.7 (159.6)	67%
6	201.9 (106.5)	74.0 (39.0)	275.9 (145.5)	61%

Units - R - Btu/hour-deg.F
- (RSI) - (W/K)

module, the Passive module 54% etc.. The measured values of transmission coefficient were derived using two different time intervals, hourly and cumulative. The hourly value was found by dividing the measured amount of energy used in any one hour by the average indoor - outdoor temperature difference for the same hour. As would be expected and as is indicated in Table 10, the thermal time constant of the structure makes it difficult if not impossible to conclude anything about the long term performance of the structure from the hourly calculation. The cumulative method utilizes a running sum of power consumption divided by a running sum of indoor - outdoor temperature differences. The expected result was that the cumulative nature of the calculation would damp diurnal climactic variations and the results would converge to a value unique for the module. As shown in figures 7 through 12 the result was more or less as expected for modules 2, 5 and 6 but the remaining modules show trends that cannot be accounted for using steady state prediction methods and the available data. The data was taken between November 27, 1979 and March 31, 1980. Comparison of the local meteorological data with historical data (2) indicated a mild heating season but since all of the modules were subjected to the same conditions the results should be valid for any set of conditions. It should be noted that the weather data used for analysis during the 1979-80 heating season was taken at the Edmonton International Airport (3) because the in-house data logging facilities were not installed until

Table 10 - Transmission Coefficients - Hourly Basis

Data - November 1, 1980, Module 1

Time	Power (W)	Room Temperature (C)	Ambient Temperature (C)	Transmission Coefficient (W/K)
1	3061	21.2	-1.2	136.7
2	3933	21.2	-2.4	166.7
3	3004	21.2	-1.6	131.8
4	2979	21.2	-1.7	130.1
5	4140	21.3	-2.0	177.7
6	3035	21.2	-2.3	129.2
7	2914	21.2	-2.7	122.4
8	4003	21.3	-2.1	171.1
9	3032	21.2	-0.2	141.7
10	2903	21.1	1.5	148.1
11	2858	21.1	2.5	153.7
12	2624	21.1	4.5	158.1
13	2492	20.1	6.3	168.4
14	1419	21.8	6.8	101.4
15	472	21.0	6.1	31.7
16	1406	21.0	4.9	87.3
17	1549	21.2	3.6	88.0
18	2286	21.2	1.2	114.3
19	2500	21.2	0.8	122.6
20	2563	21.2	0.6	126.4
21	2617	21.1	1.2	131.5
22	2586	21.2	0.8	126.7
23	2646	21.2	0.0	124.8
24	2681	21.2	-0.8	121.9

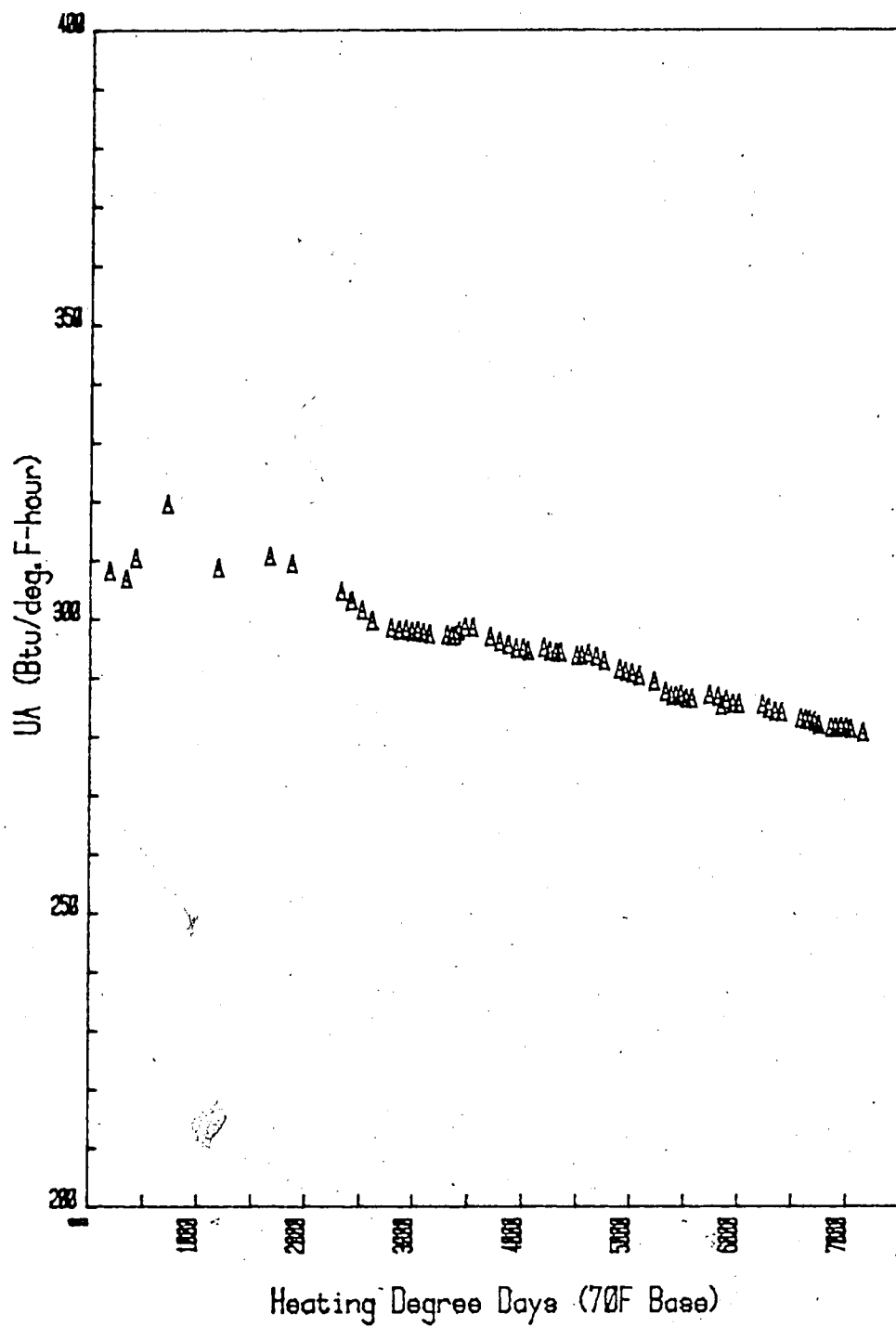

Figure 7 Cumulative Transmission Coefficient - Module 1

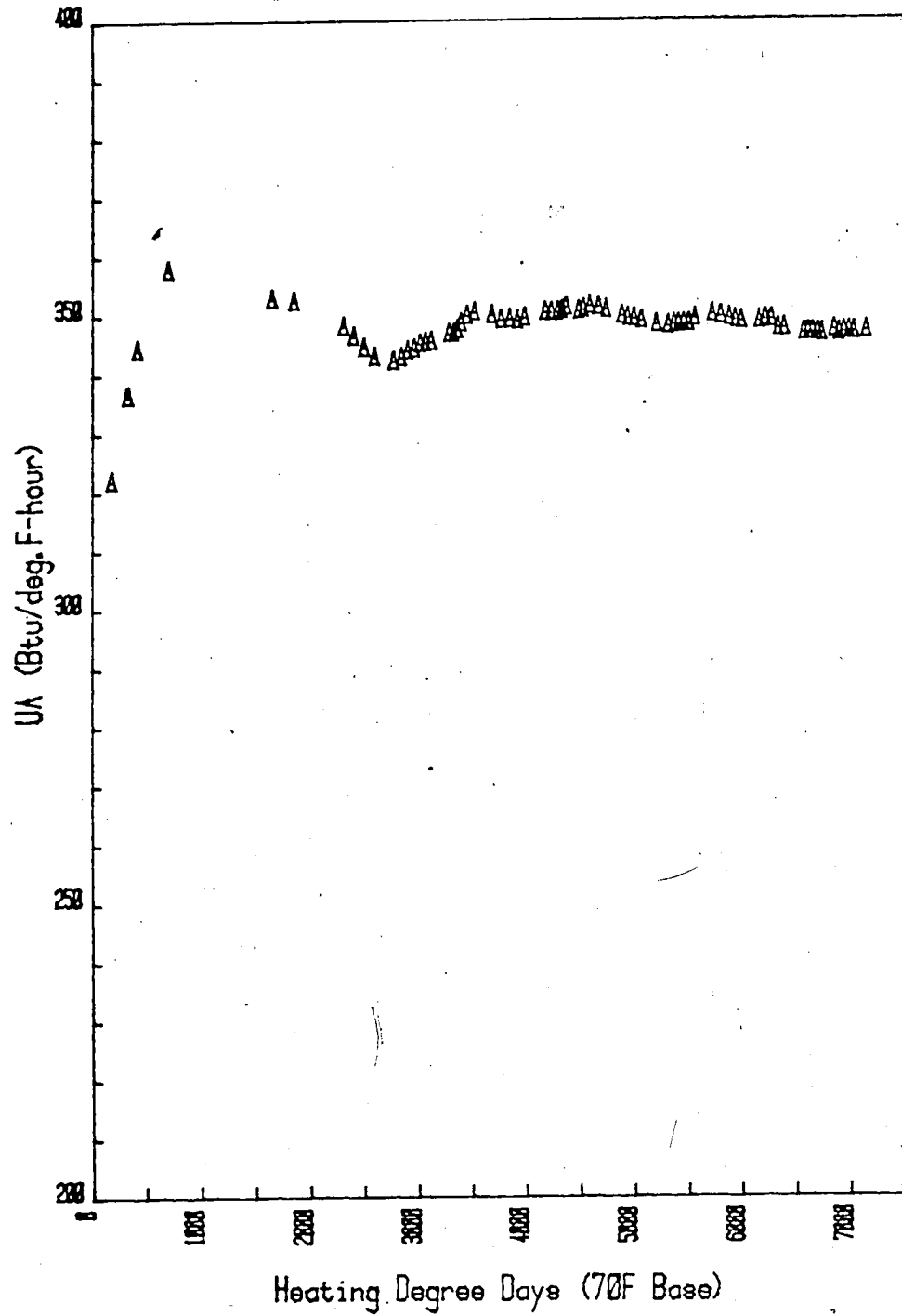

Figure 8 Cumulative Transmission Coefficient - Module 2

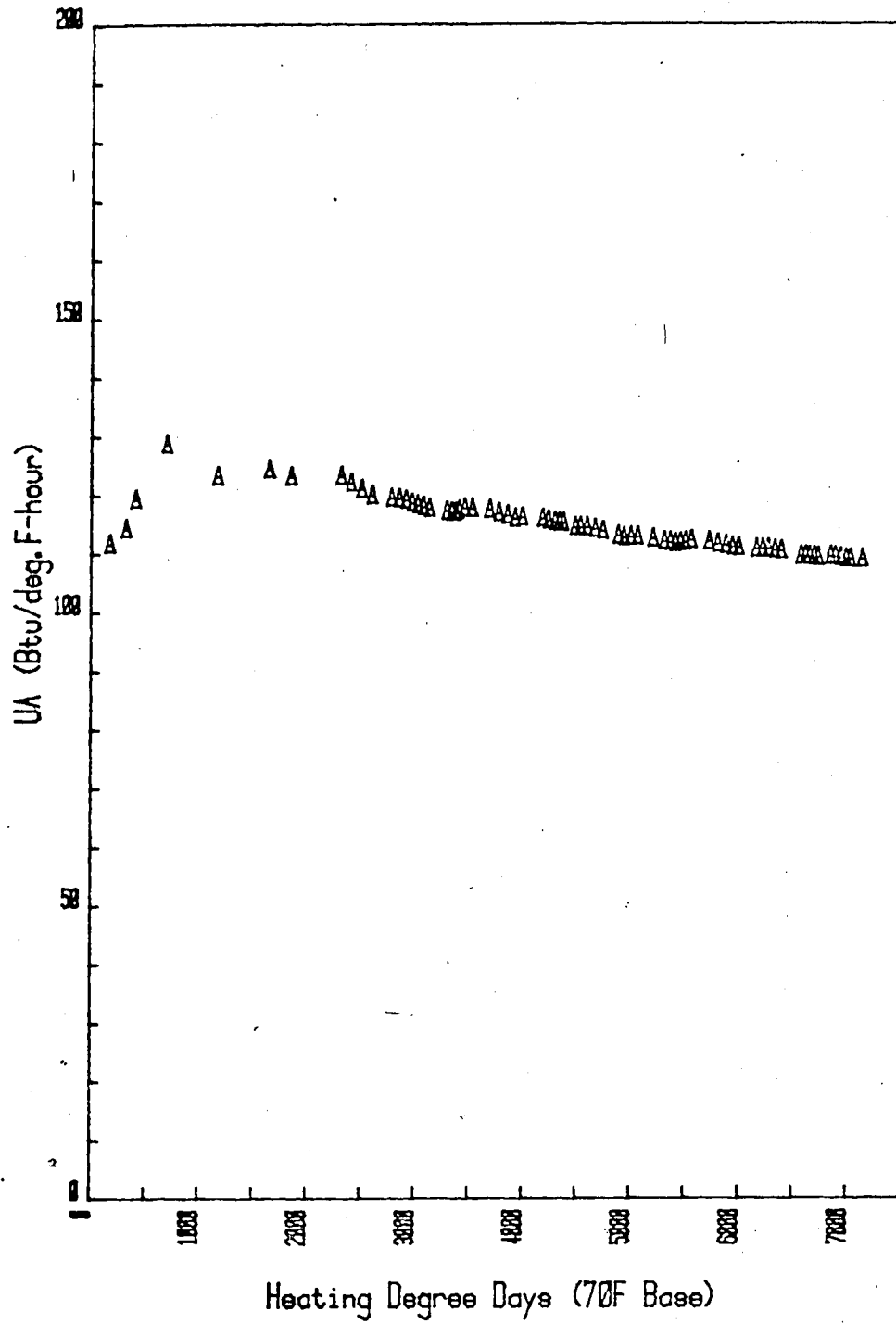

Figure 9 Cumulative Transmission Coefficient - Module 3

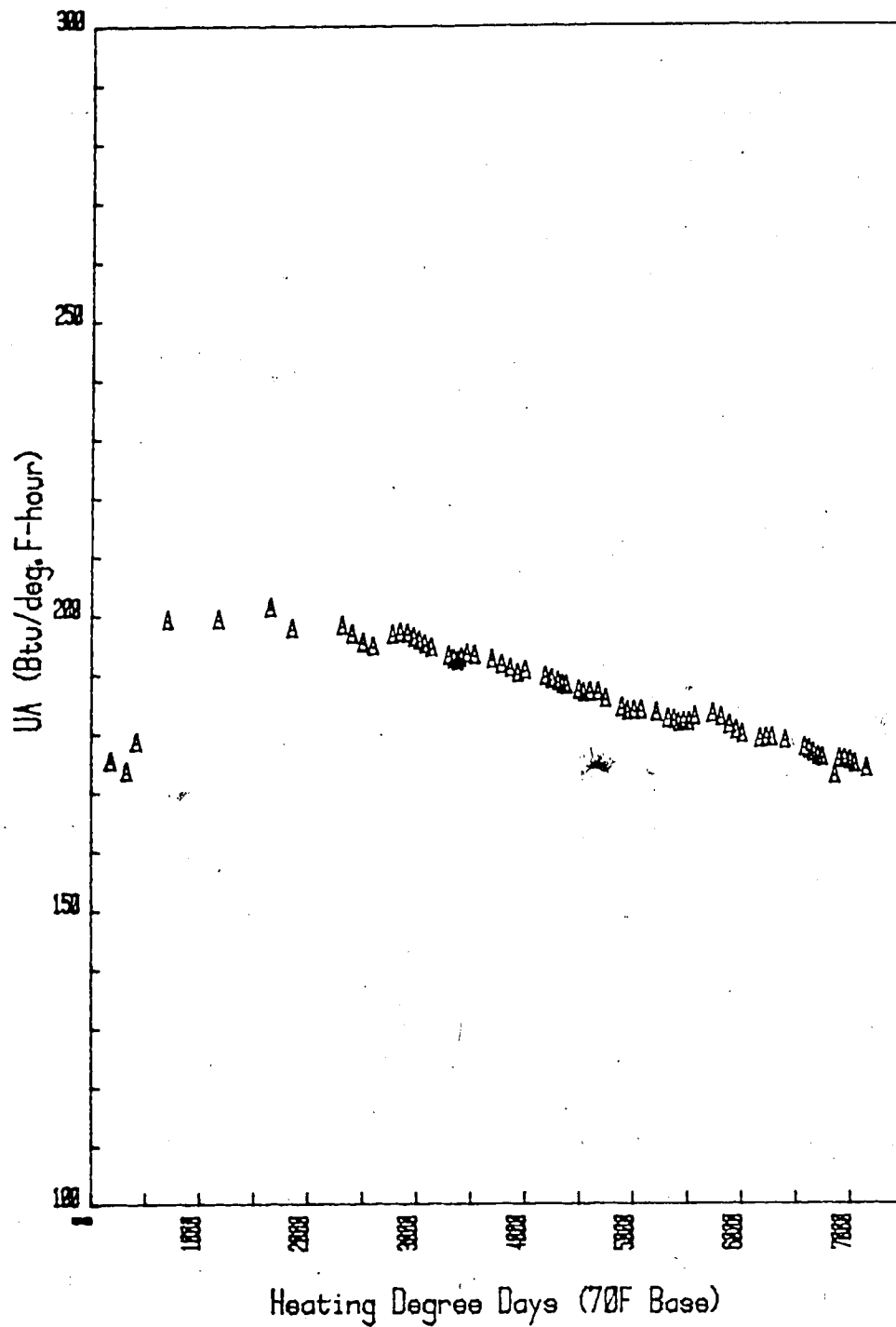

Figure 10 Cumulative Transmission Coefficient - Module 4

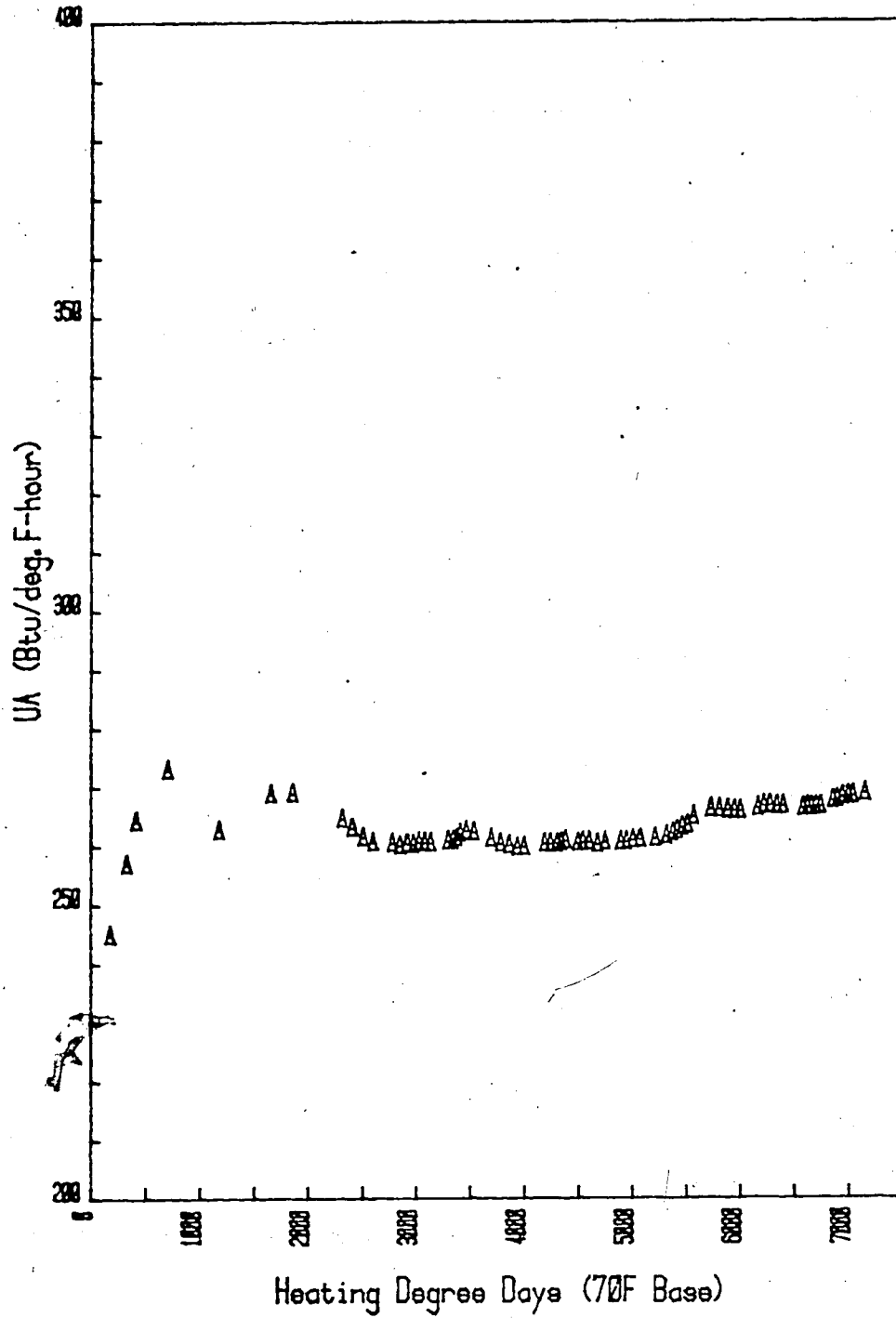

Figure 11 Cumulative Transmission Coefficient - Module 5

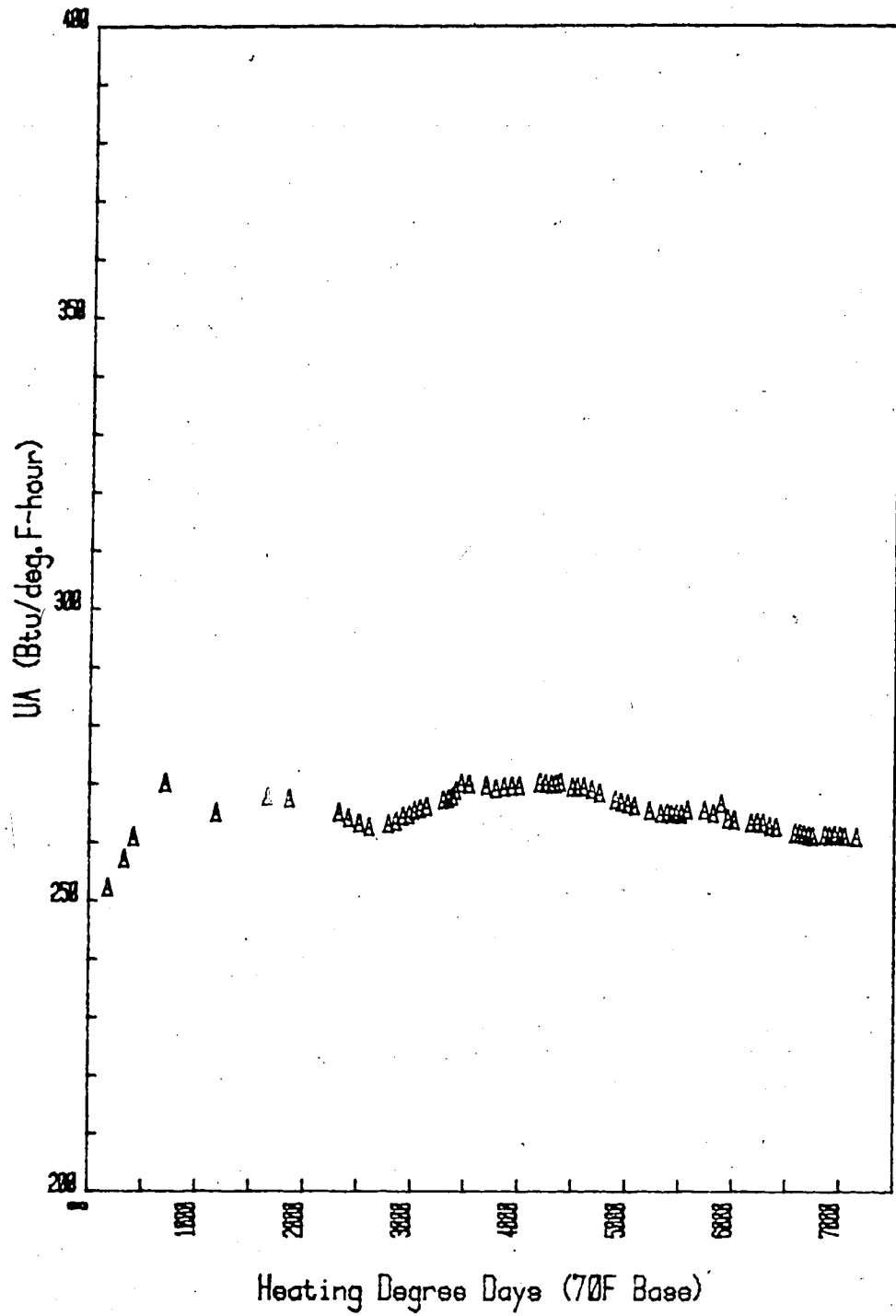

Figure 12 Cumulative Transmission Coefficient - Module 6

the following heating season. It should also be noted at this time that the overall transmission coefficient was based on a 21 degree Celsius room temperature rather than the usual 18 deg.C since the structures were void of occupants and the room thermostats were set at 21 deg.C.

A comparison of the experimental results summarized in Table 11, with predictions, Table 9, indicates that as a first approximation the ASHRAE methods work very well when the structure has a relatively low thermal envelope resistance and limited solar gains are present. One must realize that the calculated loss coefficient used for the comparison did not include air infiltration effects or solar gains.

Two methods of estimating the contribution to the heating load due to infiltration are given in the ASHRAE fundamentals, the crack length method and the air change method. The crack length method is difficult to use and leads to errors for a number of reasons. Since the method is based on the pressure difference across a building wall a primary concern is the determination of an average pressure difference on a seasonal basis. The parameter is difficult to estimate unless the area has a very constant prevailing wind and the structure is outside the zone of influence of surrounding structures. A secondary problem is the estimation of a flow exponent for each of the breaches in the building envelope as the exponent is dependent on the size and shape of the breach which is in turn a function of

the care with which the structure was built. The contribution to the infiltration rate due to temperature differential is also difficult to quantify as the neutral pressure level is not easily estimated and the method makes no allowance for breaches in the walls and ceiling of the structure by electrical fittings, flue pipes, or plumbing stand pipes. Since one is faced with the estimation of a number of parameters it is better, perhaps, to simply estimate the number of air changes the house will undergo based on testing of similar structures under similar conditions.

The authors of the ASHRAE fundamentals suggest that depending on the number of breaches in the exterior skin by doors and windows, the number of air changes per hour should be estimated at between 0.33 and 1.33 per hour under average conditions. Several problems arise with this method apart from the fact that average ambient conditions are not the same at various locations. Housing stock in Canada because of the northern climate has traditionally been built with some insulation in the walls and ceiling and some form of double glazing. Thus it would be expected that infiltration rates would be somewhat lower than that predicted using ASHRAE methods, typically 0.25 to 0.75 air changes per hour.

By using the ASHRAE air exchange method of estimating infiltration rates one can derive a factor functionally equivalent to component transmission coefficient which can be added directly to the calculated overall loss coefficient.

The method assumes average properties for air and no mixing of the entering and leaving air mass.

$Q(\text{lost}) = \text{mass flow rate} \times \text{specific heat} \times \text{temperature difference}$

where $\text{mass flow rate} = \text{volume flow rate} \times \text{density}$.

The volume flow rate is expressed as house volumes per hour and the specific heat and density are assumed to be those of air at 20 deg.C. As can be seen the product; mCp is functionally equivalent to the transmission coefficient - area product used in the determination of steady state heat loss. Table 9 shows estimated values of overall transmission coefficient assuming an air exchange rate of one half house volume per hour. A comparison of calculated and measured transmission coefficients, Tables 8, 9, and 11 shows that the arbitrary choice of an air change rate can lead to results that are further in error than would have been obtained had the contribution due to infiltration not been included.

Limited testing at the facility during the 1980-81 heating season using SF6 tracer gas, Table 12, has shown that infiltration rates range between one tenth and three quarters air changes per hour depending on the type of construction, the continuity of the air-moisture barrier and the severity of the ambient conditions. In the light of the results presented in Table 12 and the obvious discrepancy with predicted energy consumption, Table 9, several points should be noted.

Table 11 - Measured Cumulative Transmission Coefficients

Module	UA (measured)		Change (neg.)
	January 31, 1980	March 31, 1980	
1	295 (155.6)	280 (147.7)	(0.5%)
2	349 (184.1)	347 (183.0)	0.6%
3	116 (61.2)	109 (57.5)	(6.0%)
4	190 (100.2)	174 (91.8)	(9.0%)
5	260 (137.1)	269 (141.9)	3.0%
6	269 (141.9)	261 (137.7)	(3.0%)

UA - Btu/hour-deg.F
 - (W/K)

Table 12 - Summary of Infiltration Measurements

January - February 1980

Air Change Rate in House Volumes per Hour

Module	Run1	Run2	Run3	Run4	Average
1	0.91	0.52	0.46	-	0.63
2	0.38	0.38	0.61	0.51	0.47
3	0.10	0.08	0.08	-	0.09
4	0.36	0.53	0.29	0.34	0.38
5	0.35	0.35	0.36	0.42	0.37
6	0.41	0.40	0.42	0.47	0.43

Five of the six modules have installed a six inch (152mm) diameter class B type chimney. The purpose of which was to try to simulate as closely as possible the conditions encountered in a residence equipped with a natural gas fueled furnace. Measurements of air infiltration taken with the flue both open and closed indicate that the passage was a major contributor to air exchange in the modules. This phenomenon, although quite pronounced in a structure the size of the test modules would logically have a much reduced effect on a residence of 1500 square feet floor area and three times the internal volume.

The ambient conditions under which the measurements were taken were such that they could be considered to be typical winter conditions in the Edmonton area. One must be careful, however that it is not assumed that the measured air exchange rates are typical of the yearly average. That figure would be somewhat lower because of less extreme temperature conditions during the balance of the year.

The location the modules occupy was chosen so that they would receive as small an influence from surrounding structures as possible. In most developed urban areas this would not be the case but in fact the interaction between buildings in close proximity to one another presents an extremely complicated problem. Intuition suggests that urban residences, because of the surroundings, would never see the harsh conditions present at the facility. Therefore the average infiltration rate should be correspondingly lower on

a seasonal basis.

The modules were unoccupied during the test period, therefore the added heating load normally contributed to movement into and out of the structures is effectively eliminated.

During the 1980-81 heating season the equipment to monitor infiltration rates was modified, as described previously so that testing could be controlled by the data logger. One should note that the expanded testing only took place in one module, unit 5, and was done to try to establish an empirical relationship between infiltration rate, ambient temperature, room temperature and wind speed.

The data obtained was fitted to a general relationship of the form (4);

$$Q=C\Delta p^n$$

where the quantity Δp is the pressure difference across the building envelope, C is a constant dependent on flow conditions and n is a flow exponent. The actual relationship used to fit the data was functionally equivalent to $C\Delta p$ but since pressure difference was a parameter not measured during the testing the group $(A\Delta T + BV^2)$ was substituted. In the expression $(A\Delta T + BV^2)$, $A\Delta T$ represents the pressure due to density differences inside and outside the structure and BV^2 represents the pressure difference due to wind striking the building. A and B are constants determined empirically from available data.

The methodology for the determination of the constants A and B and the flow exponent n was as follows. The available data was separated into groups of low wind speed or low temperature difference. Figures 13 and 14 show the dependence of infiltration rate on temperature difference and wind speed respectively. The constants A and B were determined using a least squares fit on Figures 13 and 14.

The group, $(A\Delta T + BV^2)$, was plotted against measured infiltration rate and fitted to determine the flow exponent. As can be seen in figure 15 the data shows a fair amount of scatter but the curve fit is quite good. It is felt that the scatter is partially due to the influence of wind direction on the exchange rate but there was insufficient data to establish a correlation.

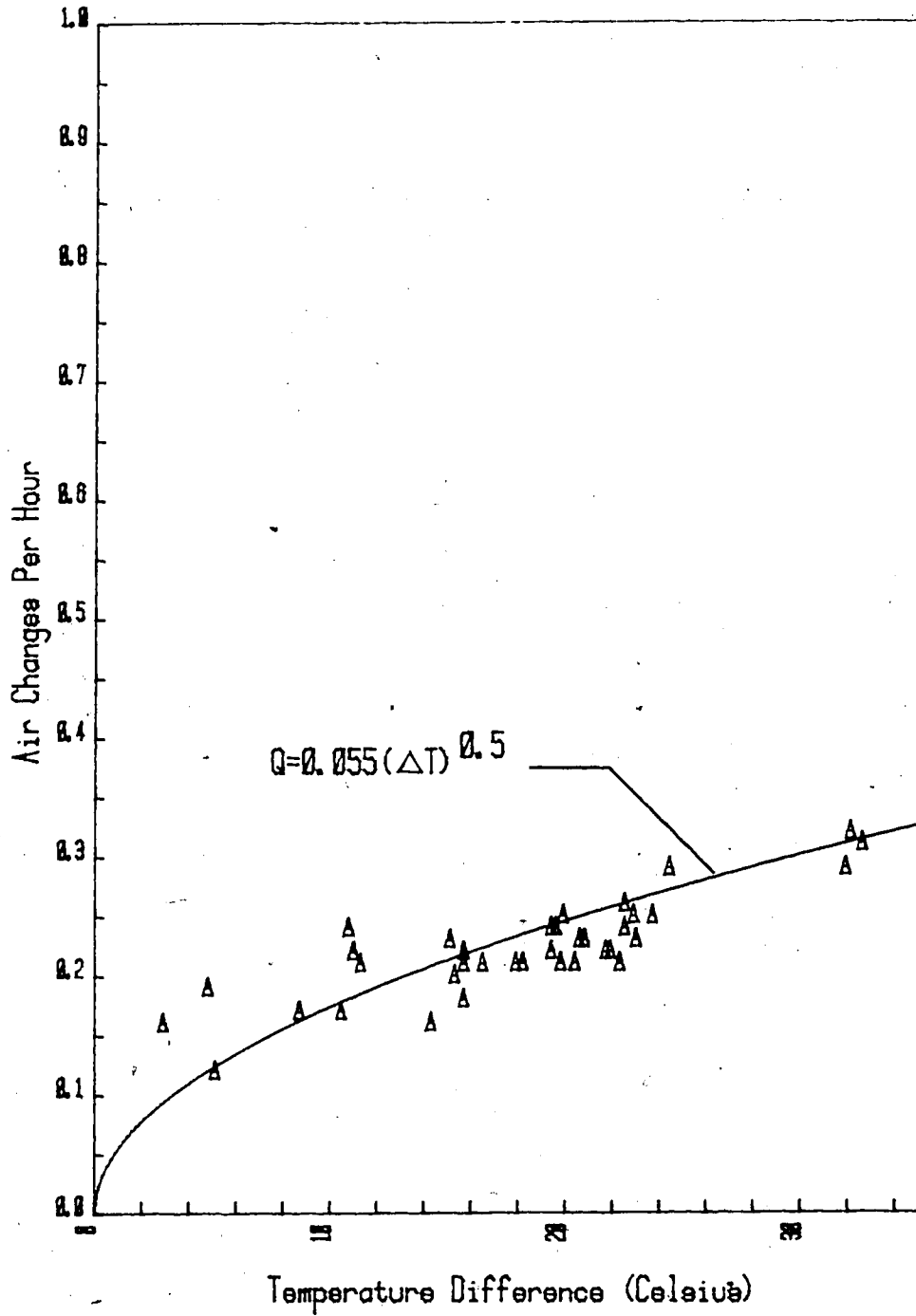

Figure 13 Temperature Dependence of Air Infiltration

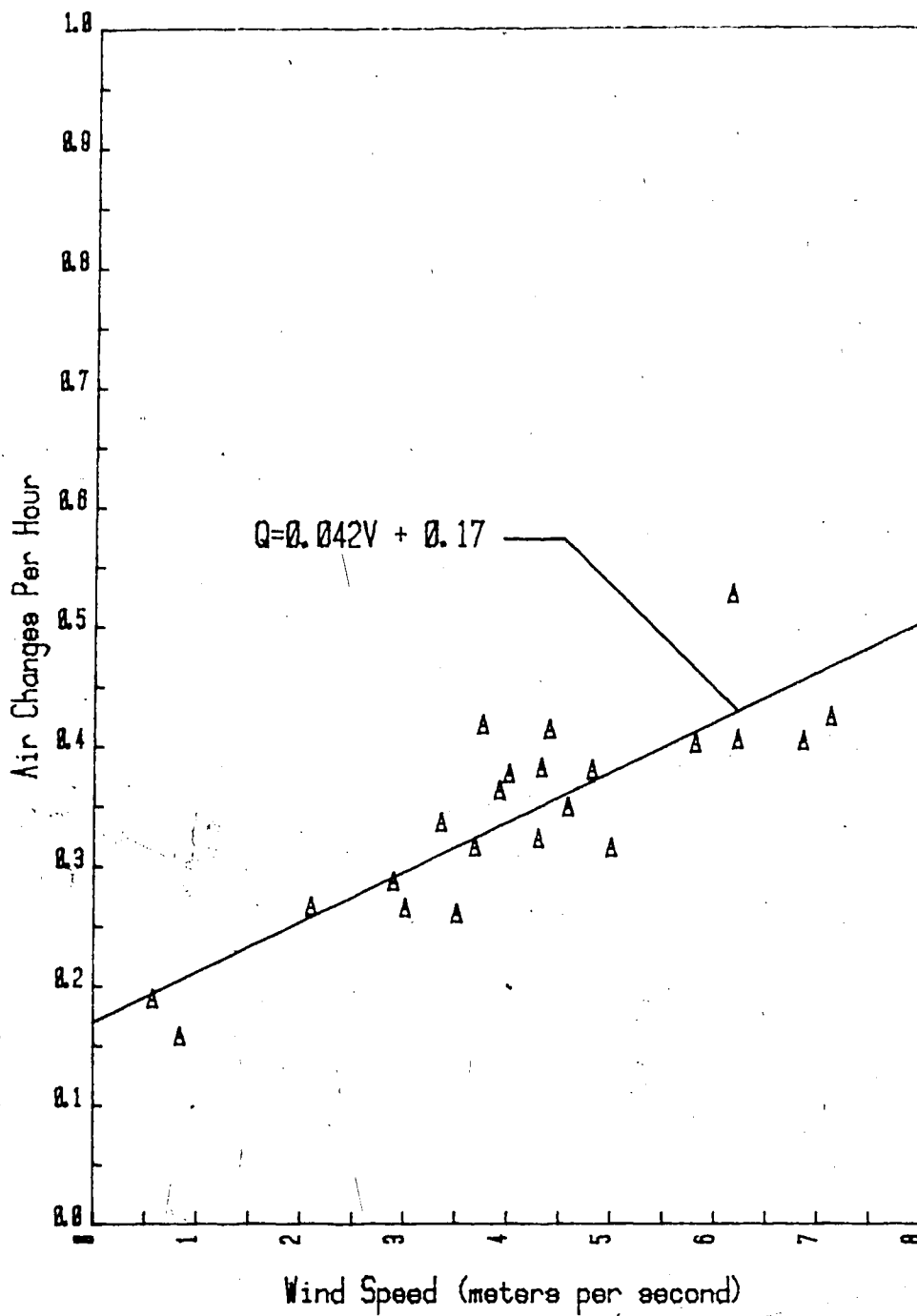

Figure 14 Wind Speed Dependence of Air Infiltration

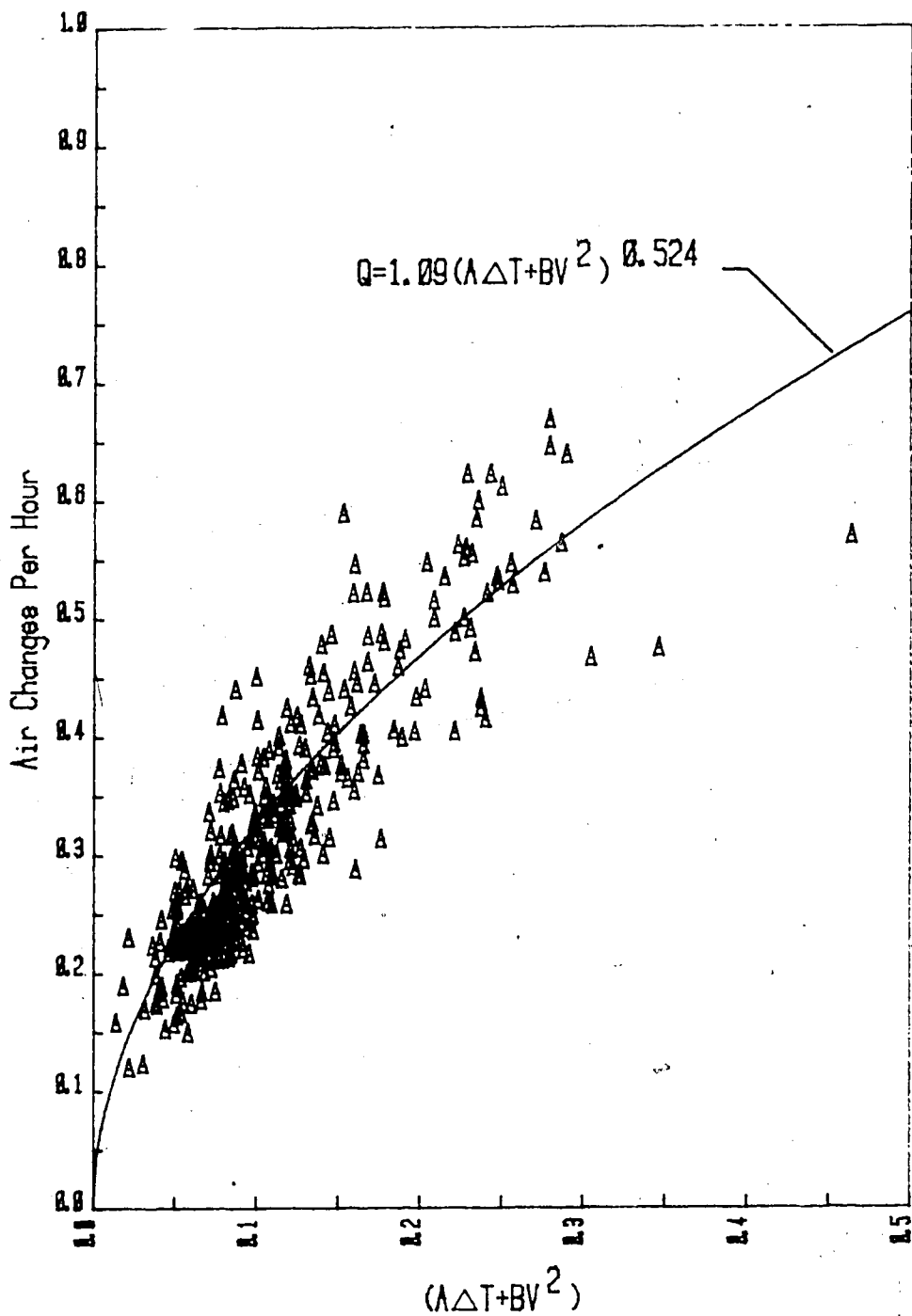

Figure 15 Derivation of an Empirical Relationship for the Prediction of Air Infiltration

5. Measurement of Component Heat Transfer

The measurement of component heat fluxes and in turn thermal properties was attempted to try to better understand the areas in which the recommended ASHRAE methods may or may not be satisfactory for the prediction of energy requirements for the test modules. The primary problem encountered was that the tabulated properties of common building materials are derived under steady state conditions conforming to rigid specifications. The same materials do not appear to perform identically under in situ conditions because of the transient nature of ambient conditions and the resulting capacitive effects.

Tsongas and Carr (5) reported significant variations in the effective resistances measured using heat flux plates due to the effects of incoming radiation during daylight hours. One should note, however, that as indicated in figures A2.2 through A2.7, the majority of heat flux plates were placed on walls with northern exposures so as to minimize the radiation effects.

A point to note with regard to the data obtained using the heat flux plates is that while calibrations were done in the laboratory under steady state conditions no detailed analysis of the transient response of the plates was attempted.

Figures 16 through 20 are typical of the results obtained for most of the heat flux transducers installed

during the test period. Each data point represents a five day average of the hourly data taken between 1800 and 600 hours. It was decided to use only night time data as the daily variation in daytime ambient conditions required extremely long averaging periods to achieve satisfactory results. Even with the lengthy averaging period it is evident that the capacitive component makes the determination of the true thermal resistance difficult. The problem is most pronounced in highly insulated structures utilizing south facing glazing for passive gain, such as the passively heated module. Because of the high insulation levels the temperature difference across the heat flux meters is very small, approximately equal to the temperature difference across the wall divided by the thermal resistance of the wall assuming a resistance for the heat flux plate of $1 \text{ (hr.sq.ft.-deg.F)/Btu}$ (RSI = 0.18 sq.m K/Watt). For the passive module this translates to a temperature difference of approximately one twentieth of the indoor - outdoor temperature difference. Given a typical heating season temperature difference of about 40 degrees Celsius the expected differential across the plate is approximately two degrees Celsius. The room temperature on the other hand may under the same conditions swing in excess of three degrees. Thus the steady state component of heat flux through the building thermal envelope can be effectively masked through short term variations in the room temperature.

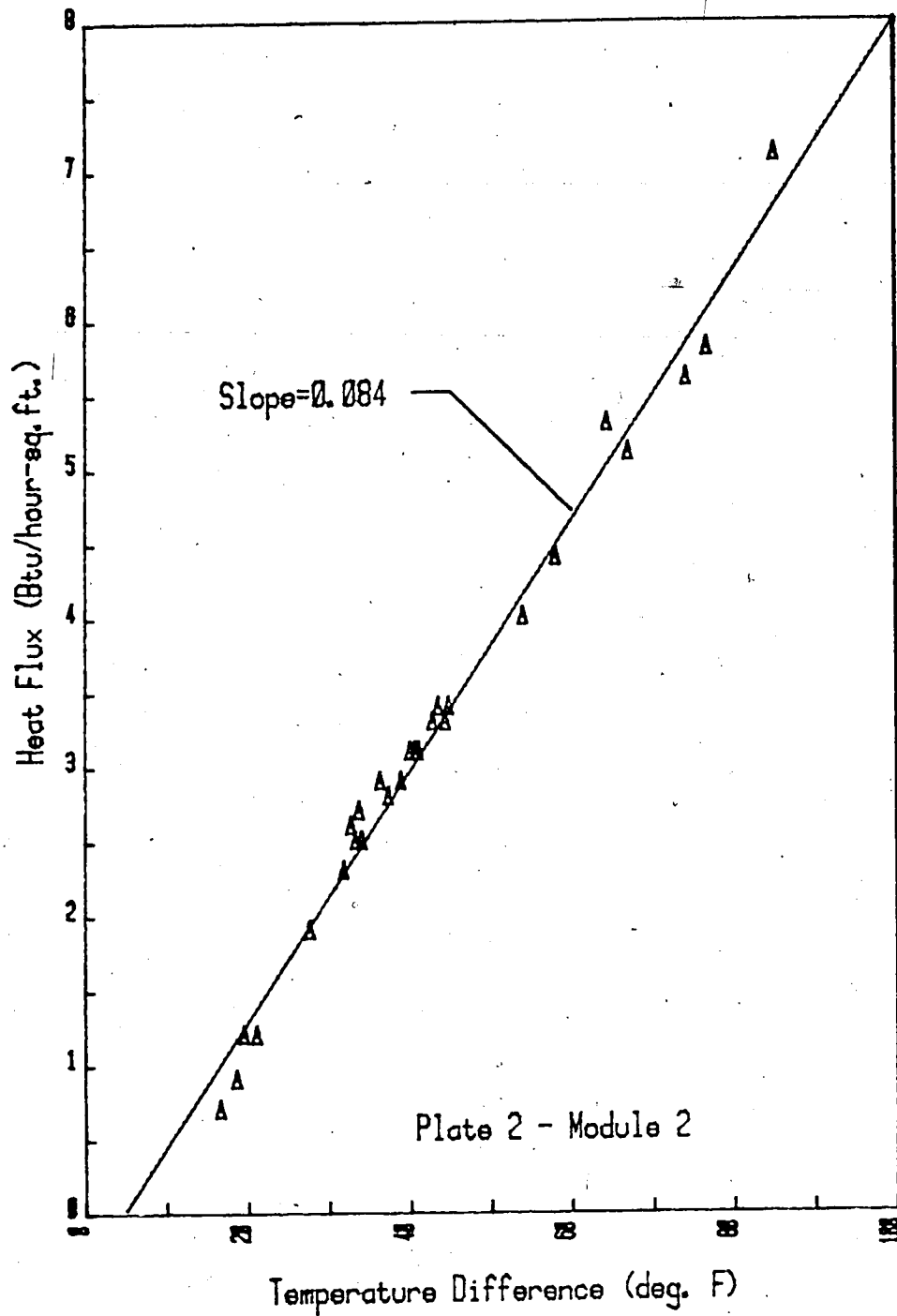

Figure 16

Measured Heat Flux as a Function of Indoor - Outdoor Temperature Difference - Module 2 Ceiling

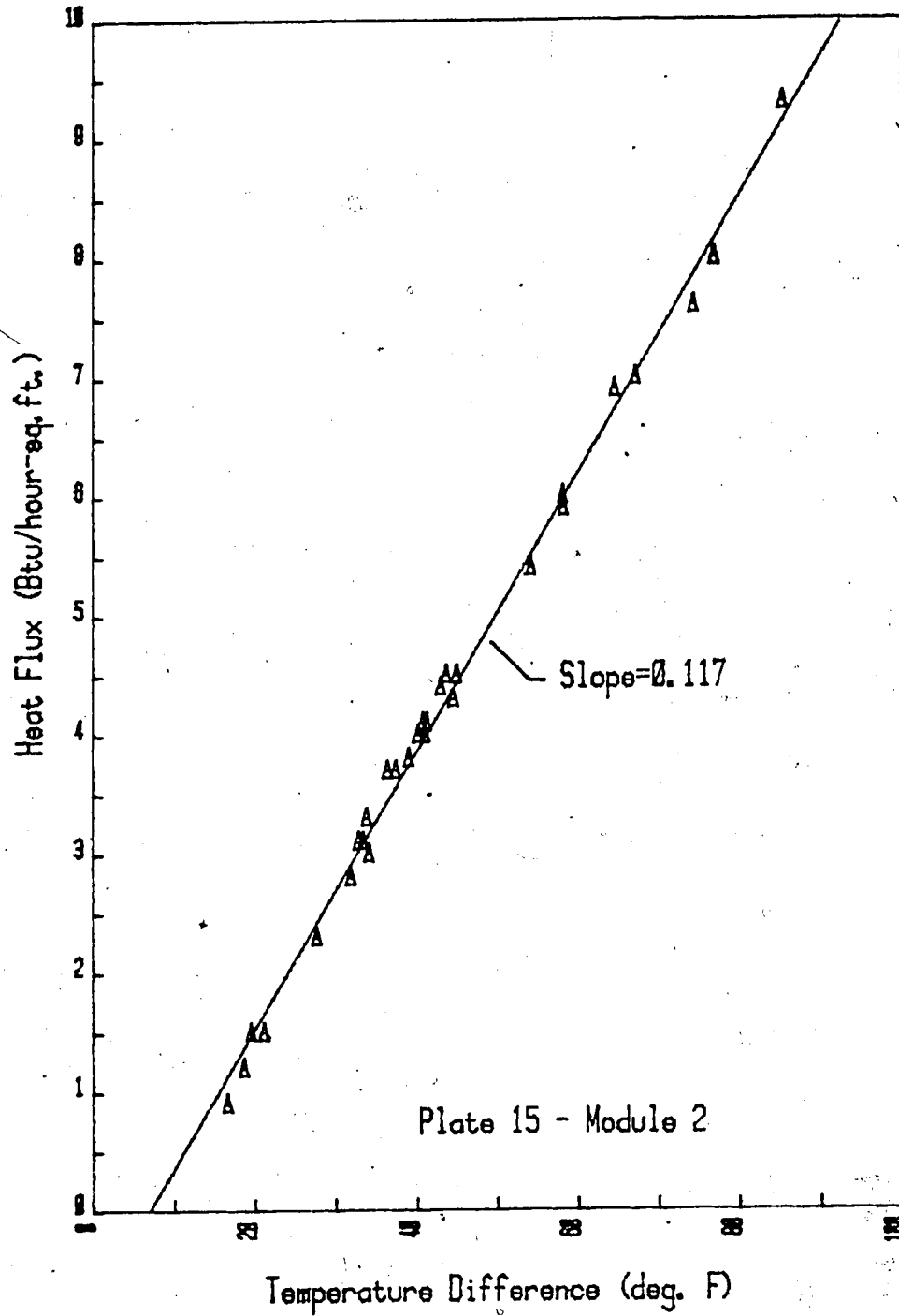

Figure 17

Measured Heat Flux as a Function of Indoor - Outdoor Temperature Difference - Module 2 Above Grade Wall

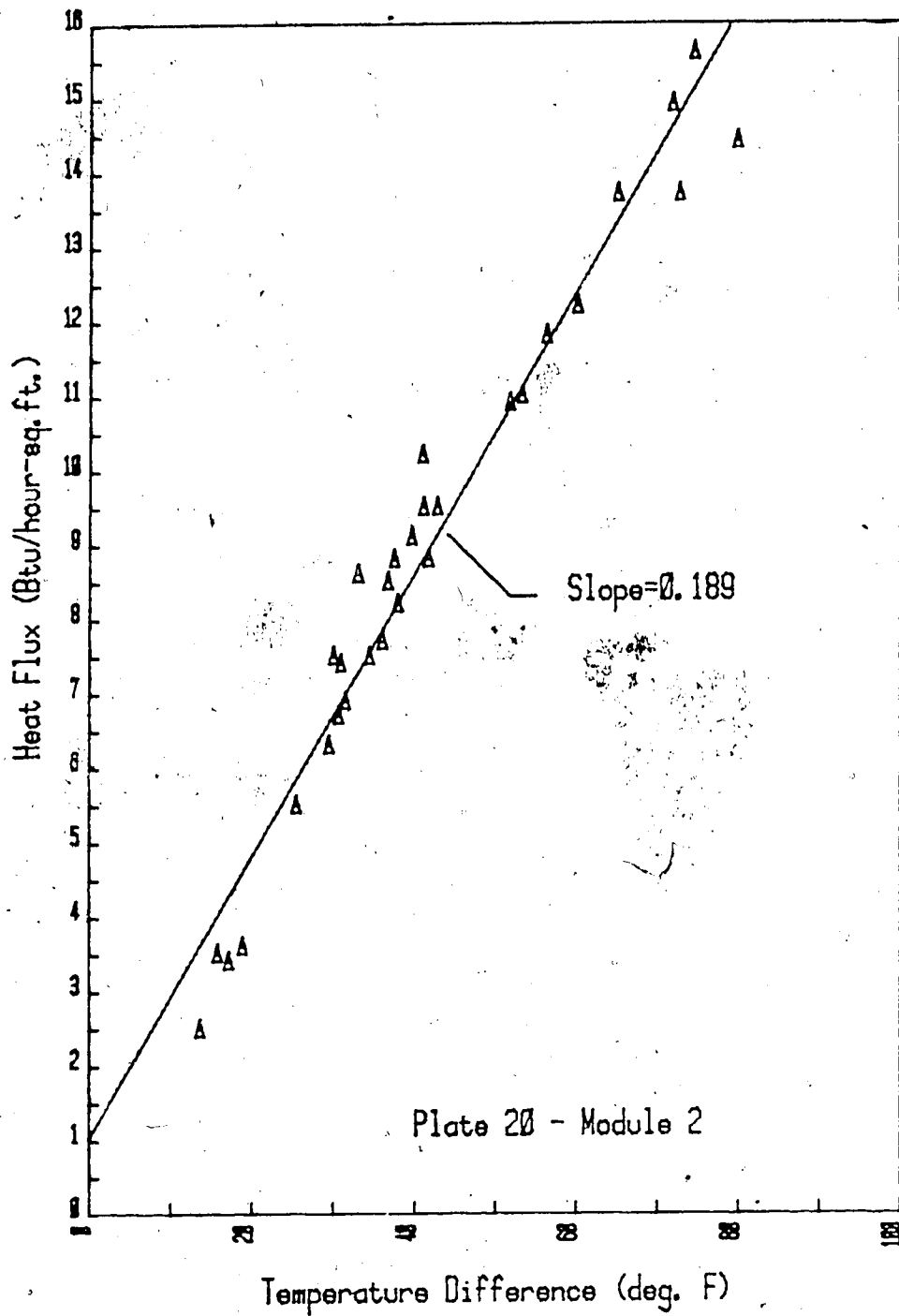

Figure 18

Measured Heat Flux as a Function of Indoor - Outdoor Temperature Difference - Module 2 Above Grade Basement Wall

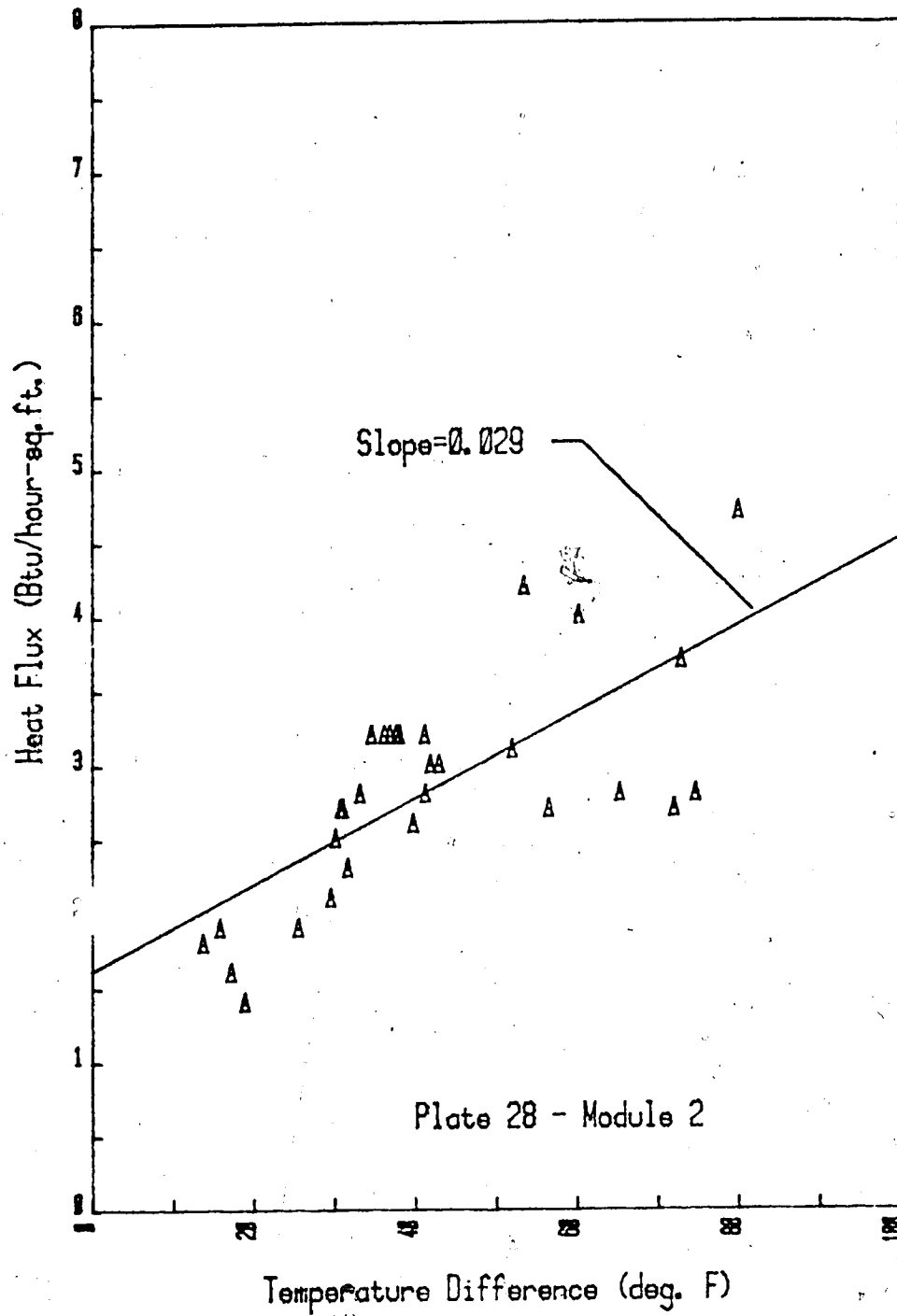

Figure 19

Measured Heat Flux as a Function of Indoor - Outdoor
Temperature Difference - Module 2 Below Grade Basement
Wall

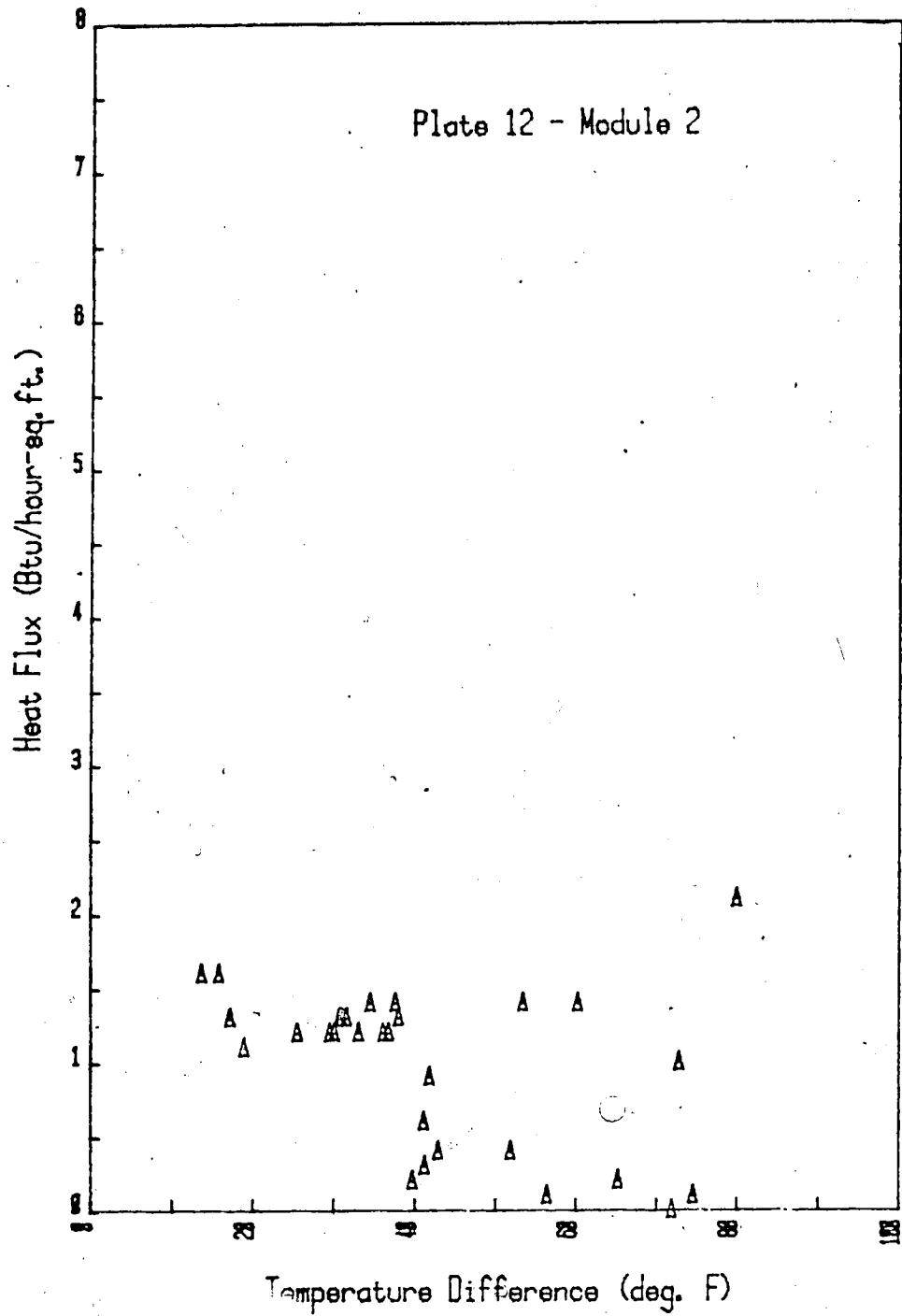

Figure 20

Measured Heat Flux as a Function of Indoor - Outdoor Temperature Difference - Module 2 Basement Floor

The heat flux meters as installed measure the flow of heat through a thermal resistance made up of the building component and the plate itself. One must be aware that the additional resistance added by the plate can in theory lead to substantial errors if the plates are installed in areas of low thermal resistance. The problem is particularly evident in locations such as uninsulated concrete walls above grade, where the readings given by the plate may be in error in excess of 50%. To illustrate the possibility of encountering such an error consider an 8 inch thick above grade concrete wall as would be used in most basements in the Edmonton area. One can assume according to ASHRAE, interior and exterior film resistances of 0.68 (hr.-sq.ft.-deg.F)/Btu (0.12 sq.m.K/Watt) and 0.17 (hr.-sq.ft.-deg.F)/Btu (0.03 sq.m.K/Watt) respectively and a thermal conductivity for concrete of 12 Btu.in./hour-sq.ft.-deg.F (1.73 Watt/m.deg.K). Steady state one dimensional heat flow theory predicts that the wall section would have a thermal resistance of approximately 1.5 (hr.-sq.ft.-deg.F)/Btu (0.26 sq.m.K/Watt). The addition of a heat flux plate however would effectively increase the resistance of the area covered by the plate to 2.5 (hr.-sq.ft.-deg.F)/Btu (0.44 sq.m.K/Watt). with a corresponding error in measured heat flux of 67%. The error is evident in all measurements but becomes less significant as the thermal resistance of the measured component increases.

Table 13 summarizes the results obtained with the heat flux plates affixed to above grade walls. The tabulated values have not been corrected to account for the thermal resistance of the transducers. Results are in good agreement with predicted values in all modules except the passive. It is felt that the 30% difference noted is primarily due to the temperature swings within the module because of the large south glazing area.

Table 14 is a comparison of calculated and measured values of ceiling resistance. The measured and calculated resistance values are again in good agreement with the exception of the passive module which shows a deviation from the calculated value of 53%.

The largest discrepancies occur in areas of high thermal capacity such as below grade basement walls and floors. Deviations from predicted values in excess of 100% are not uncommon as shown in Table 15. Figures 19 and 20 indicate that the behavior of the below grade portions of the structure is affected very little by the recent ambient temperature history and for prediction purposes it may be more reasonable to assume a constant heat loss over the entire season. One must use caution when interpreting the type of results depicted in Figures 19 and 20 as calculated correlation coefficients for the least squares fit of the data showed essentially no relationship between measured heat loss rates and ambient conditions. The correlation coefficients calculated for Figures 19 and 20 were 0.5 and

Table 13 - Measured Thermal Resistance - Above Grade Walls

Units R - (hour-sq.ft.deg.F)/Btu
 (RSI) - (sq.m.-K/W)

Module	Calculated Resistance	Measured Resistance (two locations)
1	10.5 (1.85)	9.3, 10.3 (1.64, 1.81)
2	9.0 (1.59)	11.9, 8.6 (2.10, 1.51)
3	42.7 (7.52)	38.3, 38.2 (6.75, 6.73)
4	21.3 (3.75)	15.5, 16.5 (2.73, 2.91)
5	10.5 (1.85)	11.4, 14.6 (2.01, 2.57)
6	10.5 (1.85)	10.6, 10.6 (1.87, 1.87)

Note: Tabulated values include the resistance due to the heat flux meter

Table 14 - Measured Thermal Resistance - Ceiling

Units R - (hour-sq.ft.-deg.F)/Btu
(RSI) - (sq.m.-K/W)

Module	Calculated Resistance	Measured Resistance
1	12.9 (2.27)	No Plate
2	12.3 (2.17)	12.5 (2.20)
3	82.5 (14.50)	84.4 (14.86)
4	42.9 (7.56)	20.1 (3.54)
5	12.9 (2.27)	11.4 (2.01)
6	32.8 (5.78)	22.7 (4.00)

Table 15 - Measured Thermal Resistance - Basement Walls

R - hour-sq.ft.deg.F/Btu
 (RSI) - sq.m.-K/W

Module 2 - Uninsulated

	Calculated	Measured
Above Grade	1.5 (0.26)	5.3 (0.93)
Below Grade		
0.8-1.8 feet	4.0 (0.70)	17.7 (3.12)
2.5-3.5 feet	7.33 (1.29)	34.4 (6.06)
4.1-5.1 feet	10.5 (1.85)	89.9 (15.83)

Module 4 - Insulated

Above Grade	12.0 (2.11)	21.2 (3.73)
Below Grade		
0.8-1.8 feet	14.0 (2.47)	21.2 (3.73)
2.5-3.5 feet	17.3 (3.05)	55.5, 57.0 (9.77, 10.04)
4.1-5.1 feet	20.5 (3.61)	109.5 (19.28)

Table 16 - Measured Thermal Resistance - Basement Floors

Units - (hour-sq.ft.-deg.F)/BTU

- ((sq.m.-deg.K)/W)

Module 2

	Calculated	Measured
Location 1	57.8	61.1
	(10.18)	(10.76)
Location 2	36.2	84.9
	(6.38)	(14.95)

Note: Location 1 is approximately at the center of the floor while Location 2 is half way between the center and the basement wall

0.15 respectively whereas coefficients for the majority of the above grade fits were 0.9 or better.

Ground temperature measurements from several areas in Canada (6) have shown that the seasonal variation in ground temperature with increasing depth can be out of phase with seasonal ambient variations by several months. This factor coupled with changing soil properties makes the prediction of losses from below grade structures extremely difficult in the short term. An attempt was made to correlate seasonal ground temperature variations at several depths with ambient conditions. It was felt that if a correlation could be established the effective thermal resistance of the soil surrounding the basement could be determined by comparison of heat flux with ambient temperature some time in the past. The particular time difference chosen would be that by which fluctuations in ground temperature lagged behind ambient. Figure 21 represents a forty eight hour average of ambient air temperature for the period September 1, 1981 to March 30, 1982. As can be seen, the data points are scattered even with the lengthy averaging period. Figure 22 shows the variation in soil temperature, approximately six feet north of the standard module, for the same period at depths of 2 feet (0.61m), 4 feet (1.22m), and 5.5 feet (1.68m). As can be seen, the minimum temperature point for the shallowest probe occurred about mid January but that because of the flattening of the curves with increasing depth the time at which the other two minimums occurred is difficult to

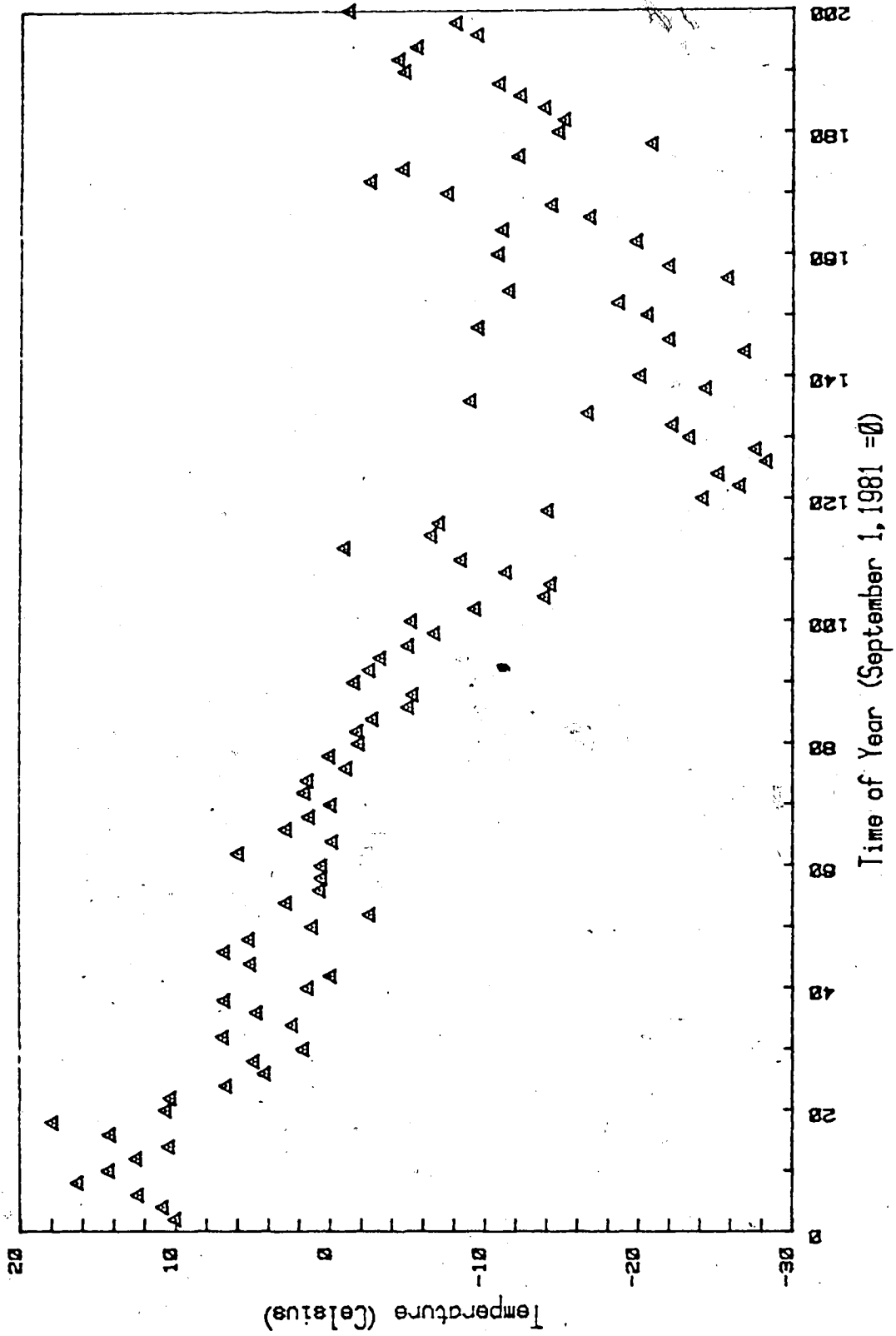

Figure 21 Ambient Dry Bulb September 1 - March 30, 1982

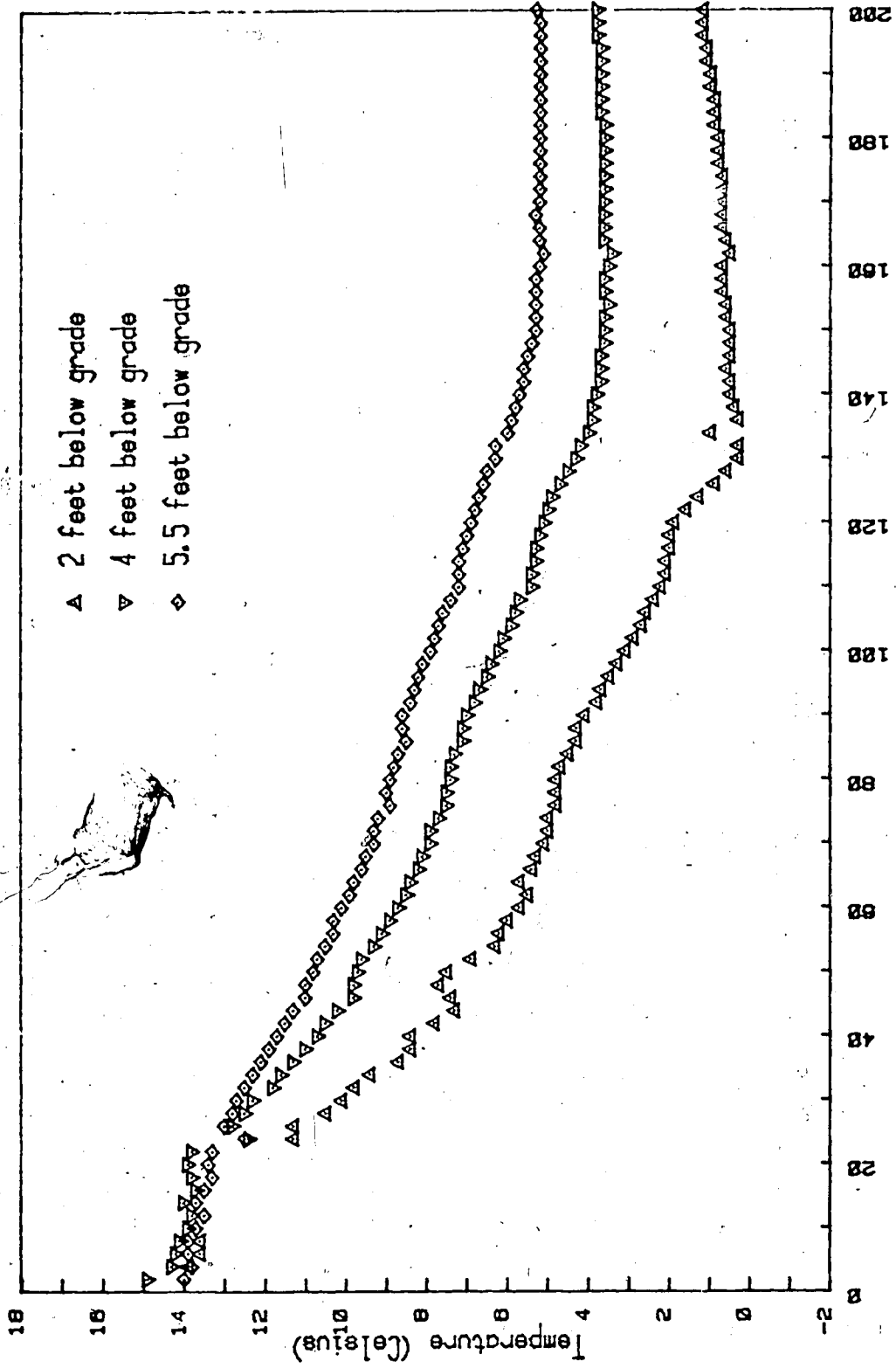

Figure 22 Ground Temperatures at Three Depths
September 1 - March 30, 1982

identify. Although it was not possible to accurately determine the exact relationship between ambient temperature and temperatures at increasing depths, that some lag is present is obvious. The use of the degree day method to predict seasonal energy requirements should therefore lead to an overprediction. The lag of ground temperature behind ambient should have the effect of reducing the energy requirement for a structure because by the time the below grade losses peak the ambient conditions have begun to moderate.

A further attempt was made to determine the effective resistance of soil heat flow paths through comparative analysis of below grade heat flow data with that obtained from the above grade portions of the structures. It was felt that the problem of ground temperature lagging ambient could be overlooked by using instead a summation of the available heat flux data over an entire heating season. Although the procedure does not directly lead to a resistance value for the below grade heat flow paths it gives one a method of comparing predictive techniques with long term in situ measurements. Table 17 summarizes the average heat flows as measured using heat flux sensors over the heating period September 1, 1981 to March 30, 1982. As can be seen in the table, the below grade portions of the structure lost heat at a rate inversely proportional to depth and insulation level and that floor losses measured at two locations were virtually identical. The most notable point is that while

Table 17 - Measured Average Heat Losses for
Building Components Over the
1981-1982 Heating Season

Above Grade Components

Nominal Insulating Value	Heat loss (W/sq.m)
R-8 (RSI-1.41)	13.6
R-10 (RSI-1.76)	13.3
R-20 (RSI-3.52)	6.5
R-40 (RSI-7.04)	2.8
R-80 (RSI-14.09)	1.85
Basement - Uninsulated	
Above Grade	28.5
40cm Below Grade	14.3
80cm Below Grade	8.9
140cm Below Grade	6.6
Basement Floor	3.0
Basement - Insulated	
Above Grade (additional RSI-1.76)	6.5
40cm Below Grade	4.6
80cm Below Grade	4.3
140cm Below Grade	3.8
Basement Floor	3.1

ASHRAE methods suggest that resistance values should vary in the range $R=2.44$ hour-sq.ft.-deg.F/Btu (RSI-0.43) to $R=14.5$ (RSI-2.55) for uninsulated basements (1) the measured values were found to be somewhat higher, most falling between $R=6$ (RSI-1.06) and $R=20$ (RSI-3.52). For the same range of depths ASHRAE suggests the values to be used for an insulated basement (2 inch thick, $k=0.24$ Btuh-in/sq.ft.-deg.F) to be in the range $R=10.8$ (RSI-1.9) to $R=22.7$ (RSI-4.0) for depths below grade from 0 to 6 feet (0-1.5 m). Table 17 indicates that using the available data one would predict values between $R=20$ (RSI-3.52) and $R=35$ (RSI-6.2) for the same range of depths.

An interesting point to note is that the measured heat fluxes through the basement floor of both the insulated and uninsulated basements were within a few percent of one another over the heating season. One would have supposed that the floor of the insulated basement would have lost heat at a rate slightly less than the floor of the uninsulated basement because of a room temperature lower by about three degrees over the majority of the heating season.

6. Conclusions and Recommendations

From the analysis of data gathered over the term of this study several conclusions may be drawn.

1) As demonstrated, the auxiliary energy requirements of a heated residential structure are not a linear function of temperature difference alone, but are influenced by a number of non-linear parameters such as air infiltration. Because the influence of each parameter continually changes the use of linear prediction methods alone leads to inaccuracies. The magnitude of the deviation between predicted and actual performance is dependent on the methods one employs to account for these non-linearities.

2) Measurements of actual air infiltration rates using SF₆ decay methods indicated exchange rates that were consistently lower than predicted using the ASHRAE air change method. Measured rates were typically 0.3 to 0.5 air changes per hour as opposed to predicted rates of the order of 1.0 air change per hour.

3) The development of empirical methods for the prediction of air leakage can be accomplished by assuming that two components, temperature differential and wind speed, are the driving forces. The measurements can be related to air leakage using a general equation of the form $(A + BV^n)$. The constants A and B and the flow exponent n can be determined empirically using in-situ measurements.

4) The direct measurement of the in-situ thermal conductivity of building components could only be done where the components were thermally "light", such as above grade frame walls. The average measured heat loss rates over the entire heating season for most structure components were within 20% of the values that would be predicted using steady state methods. It was felt that capacitance effects were the main reason that no correlation could be obtained between measured heat flux and temperature differential for the below grade, "heavy", portions of the structure.

5) The measurement of average below grade heat loss rates over the heating season indicates that the overall resistance of the heat flux paths through the soil surrounding a basement is much higher than one would predict using ASHRAE methods. The discrepancy would logically be smaller if the summation was not terminated at the end of the heating season but was continued over a full calendar year. Ground temperature lags with respect to ambient temperature and the below grade losses do not fall off rapidly at the end of the heating season. Consequently the resistance of the soil surrounding a basement would appear lower on a yearly basis.

6) Based on the results of the study it has been postulated that the addition of insulation to basement walls alters the soil temperature profile and leads to a corresponding increase in losses from the basement floor.

Albeit, neither the magnitude of the increase, nor the

losses themselves represent a large portion of the total energy requirement of most existing structures.

As was stated in the introduction to the study, several areas in need of further study have been identified.

1) Based on the measurements of air leakage rates during the course of the study, the accepted methods for the prediction of air exchange rates lead to over predictions. The development of empirical equations based on easily measurable parameters such as temperature differential and wind speed should be attempted for common building shapes. It is felt that a sufficiently large data base would allow the effects of wind direction and sheltering to be identified and the empirical constants adjusted accordingly.

2) The use of the accepted methods for the calculation of design loads have lead to, in a large number of cases, heating systems which are greatly oversized. The oversizing was due in part to the assumption that peak losses occurred at the same time of year for all portions of the structure. This study has shown that the above and below grade losses are out of phase with one another. This phenomena should be pursued to the end that heating system calculations can be derated to account for phase differences.

Bibliography

- 1) American Society of Heating, Refrigeration, and Air Conditioning Engineers, "ASHRAE HANDBOOK 1977 FUNDAMENTALS", Chapters 13,22,24,26.
- 2) University of Alberta, Geography Department, "Meteorological Records for Ellersie, Alberta".
- 3) Atmospheric Environment Services, "Edmonton International Airport Surface Weather Record", 1979-1980
- 4) American Society of Heating, Refrigeration, and Air Conditioning Engineers, "ASHRAE HANDBOOK 1977 FUNDAMENTALS", Chapters 2,21.
- 5) Tsongas, G.A., Carr, R.S., "An Experimental Study of Solar Heating Effects on Wall Insulation Performance", Proceeding of the Third National Passive Solar Conference, San Jose, California, 1979.
- 6) Williams, G.P., Gold, L.W., "Ground Temperatures", Canadian Building Digest, Division of Building Research, National Research Council of Canada, July 1976.
- 7) Boileau, G.G., Latta, J.K., "Calculation of Basement Heat Losses", Division of Building Research, Technical Paper No. 292, National Research Council of Canada, December 1968.
- 8) Chapman, A.J., "Heat Transfer", third edition, Macmillian Publishing Company Inc., New York, Chapter 4.8, pp 151-159.
- 9) Tamura, G.T., "The Calculation of House Infiltration Rates", ASHRAE Transactions, No.2513, 1979.
- 10) Harrje, D.T., "Approaches to Evaluation of Air Infiltration, Energy Losses In Buildings", ASHRAE Transactions, PH-79-10, 1979.
- 11) Gilpin, R.R., Dale, J.D., Forest, T.W., Ackerman, M.Y., "Construction of the Alberta Home Heating Research Facility and Results for the 1979-1980 Heating Season", Department of Mechanical Engineering, University of Alberta, Departmental Report No.23, August 1980.

- 12) Gilpin, R.R., Forest, T.W., Ackerman, M.Y., Wilson, D.J., Sadler, G.W., Dale, J.D., Zaheeruddin, M., "Second Annual Report on the Alberta Home Heating Research Facility: Results for the 1 80-1 81 Heating Season", Department of Mechanical Engineering, University of Alberta, Departmental Report No.24, June 1981.

Appendix A1

The two schematics presented, figures A1.1 and A1.2, although not necessary to the understanding of the information previously presented may be of interest to one attempting to duplicate the experiment.

The power meter interface was designed and constructed by technicians in the Mechanical Engineering Department specifically for use in the project.

The operation of the interface is relatively straight forward and requires a minimum of components. A pulse applied to the input of the monostable multivibrator (74C221) causes the output (pin 13) to go high for a period determined by the R-C time constant of the network tied to pins 14 and 15. The pulse causes the output of the binary counter (14040) and the input of the digital to analog converter to be incremented by one. The output of the D/A is subsequently increased by a discrete amount, the amount controlled by the voltage applied to the reference pin (pin 15).

The interface can be read remotely and has a capability of 1024 counts with a resolution of 10 millivolts. The interface is reset to zero with a high pulse applied to the reset pin (pin 11) of the binary counter.

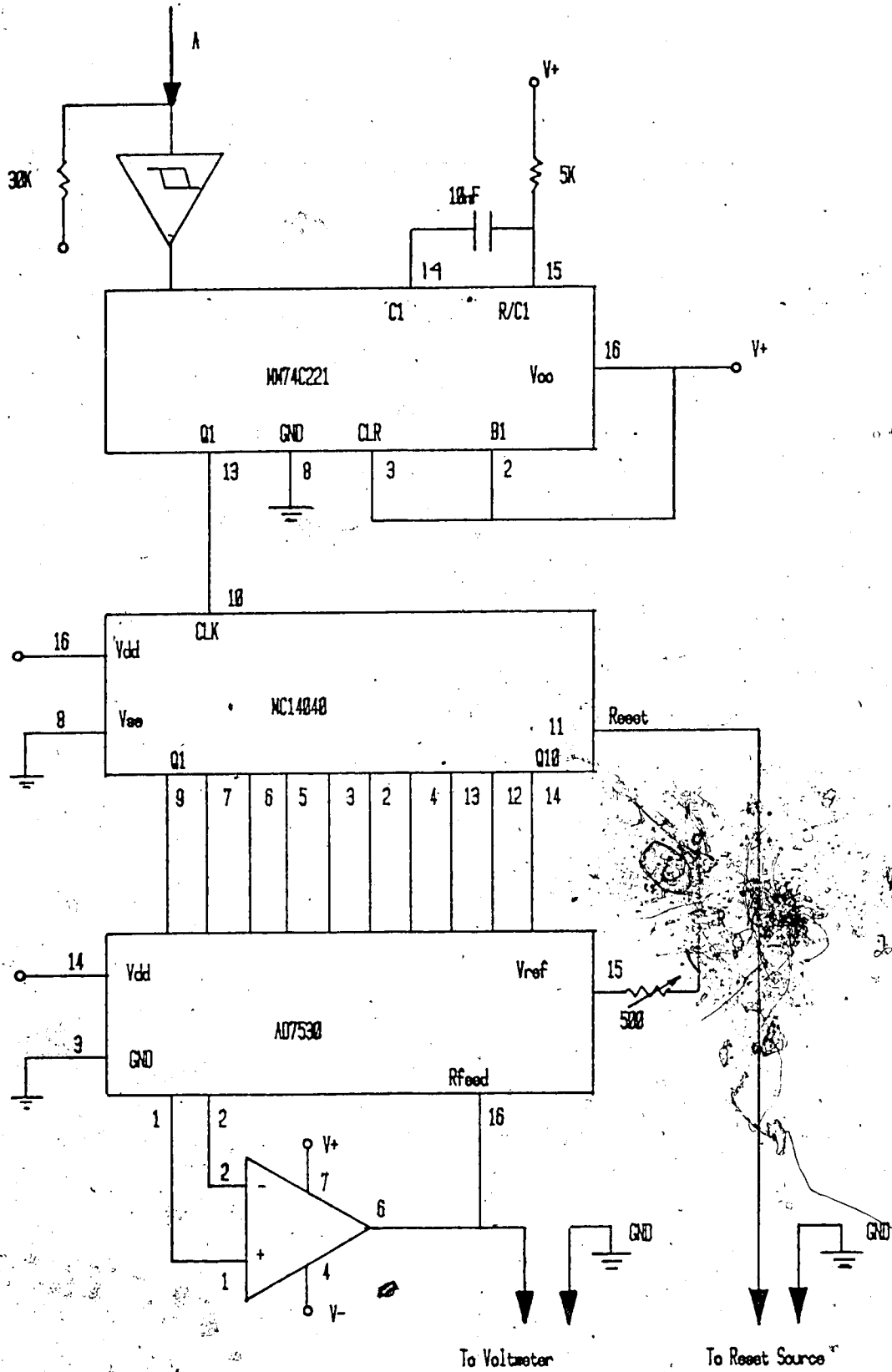

Figure A1.1 Watt Meter Interface Schematic 1

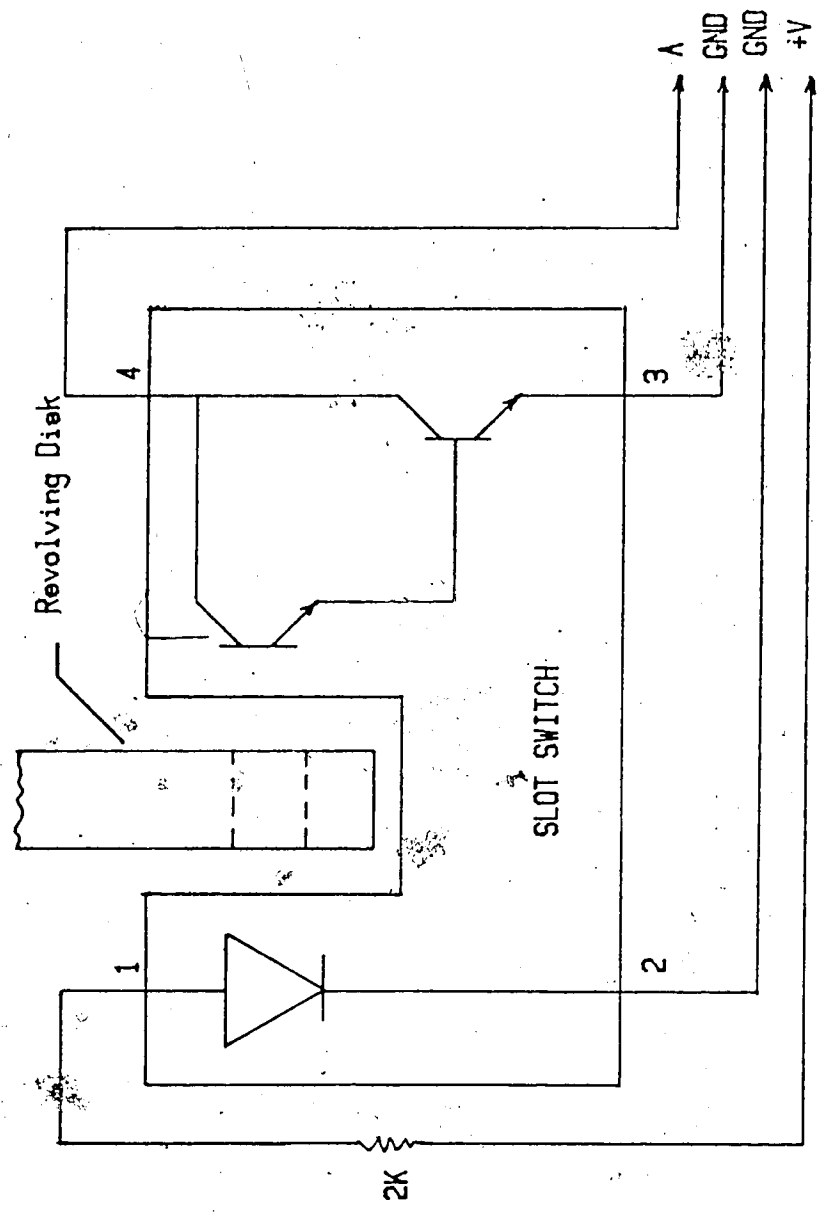

Figure A1.2 Watt Meter Interface Schematic 2

Appendix A2

The heat flux plates used during the course of testing were designed at the university by an undergraduate student group. The plates consist of a 6.35 mm (0.25 inch) layer of cork sandwiched between two 4.8 mm (0.1875 inch) plexiglass sheets.

As shown in figure A 2.1 the overall dimensions of the plates are 15.2 cm by 40.6 cm by 1.5 cm thick. The overall dimensions were chosen so that a typical wall section (framed 16 inches on center) would be covered regardless of where the plate was located.

Each plate has 14 thermocouples imbedded in the plexiglass on both sides of the cork insert, so that the average temperature difference across the cork can be effectively measured. As the temperature differential across the cork insert is a measure of the rate of heat flux through the plate, a measure of the thermal conductivity of the component the plate is attached to can be obtained using the Fourier conduction equation. One need only know the plate constant, the temperature difference across the component and the plate output.

The plates were calibrated using an electric heater (input power known) as well as a commercial produced gauge. The plate constant was found to be 14.6 Watt/sq.m-millivolt and all plates tested were within 5% of this value.

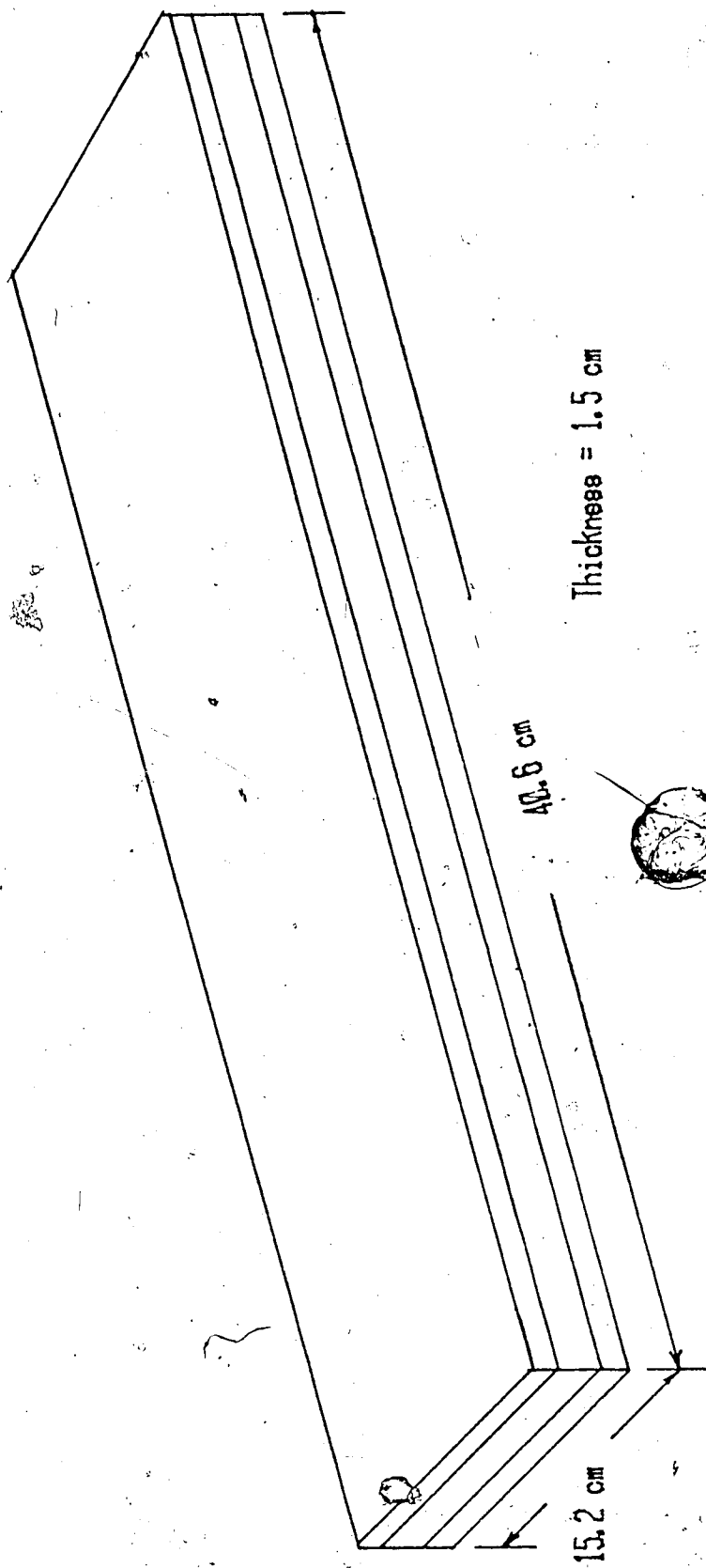

Figure A2.1 Heat Flux Plate Construction

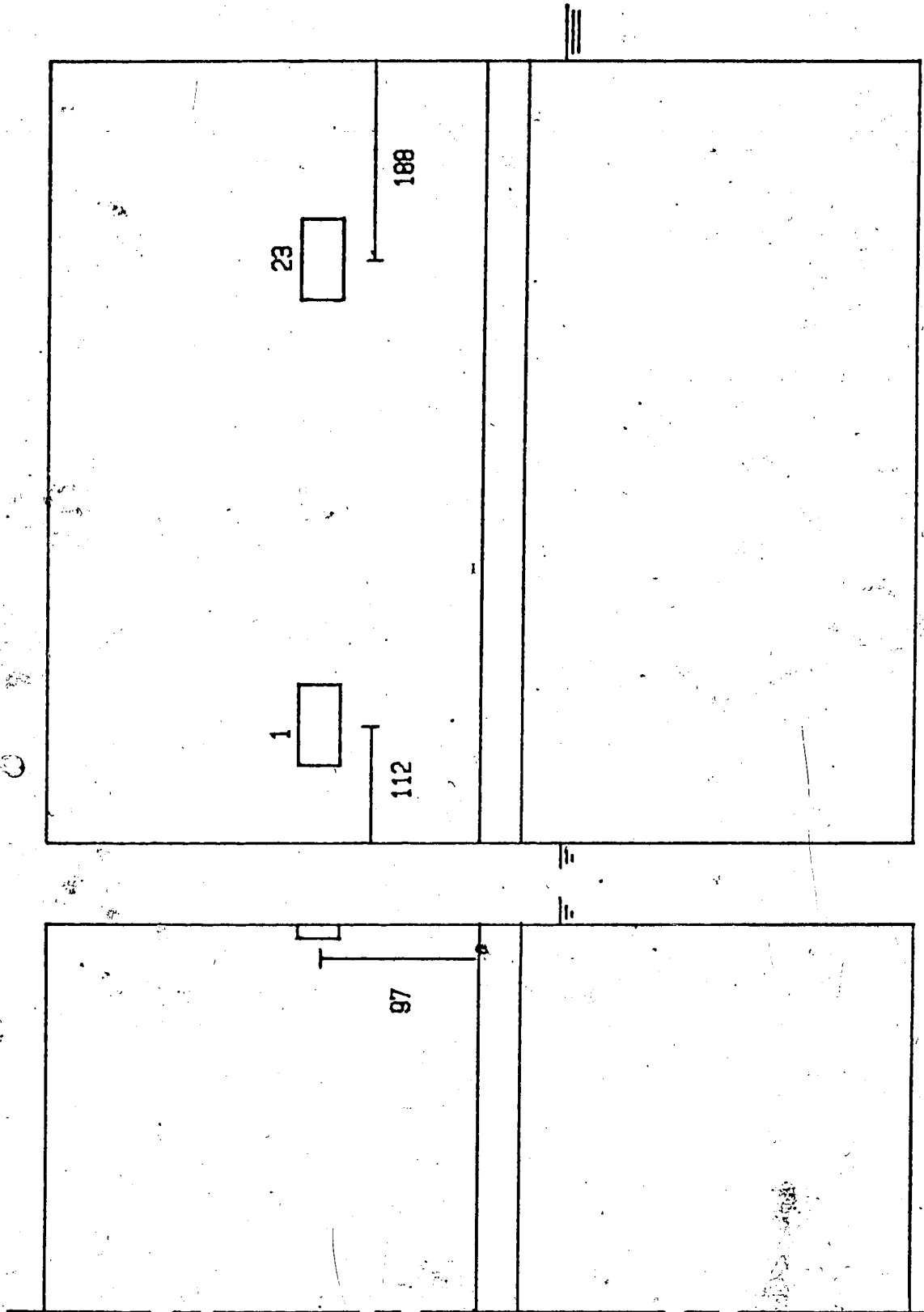

Figure A2.2 Heat Flux Plate Locations - Module 1

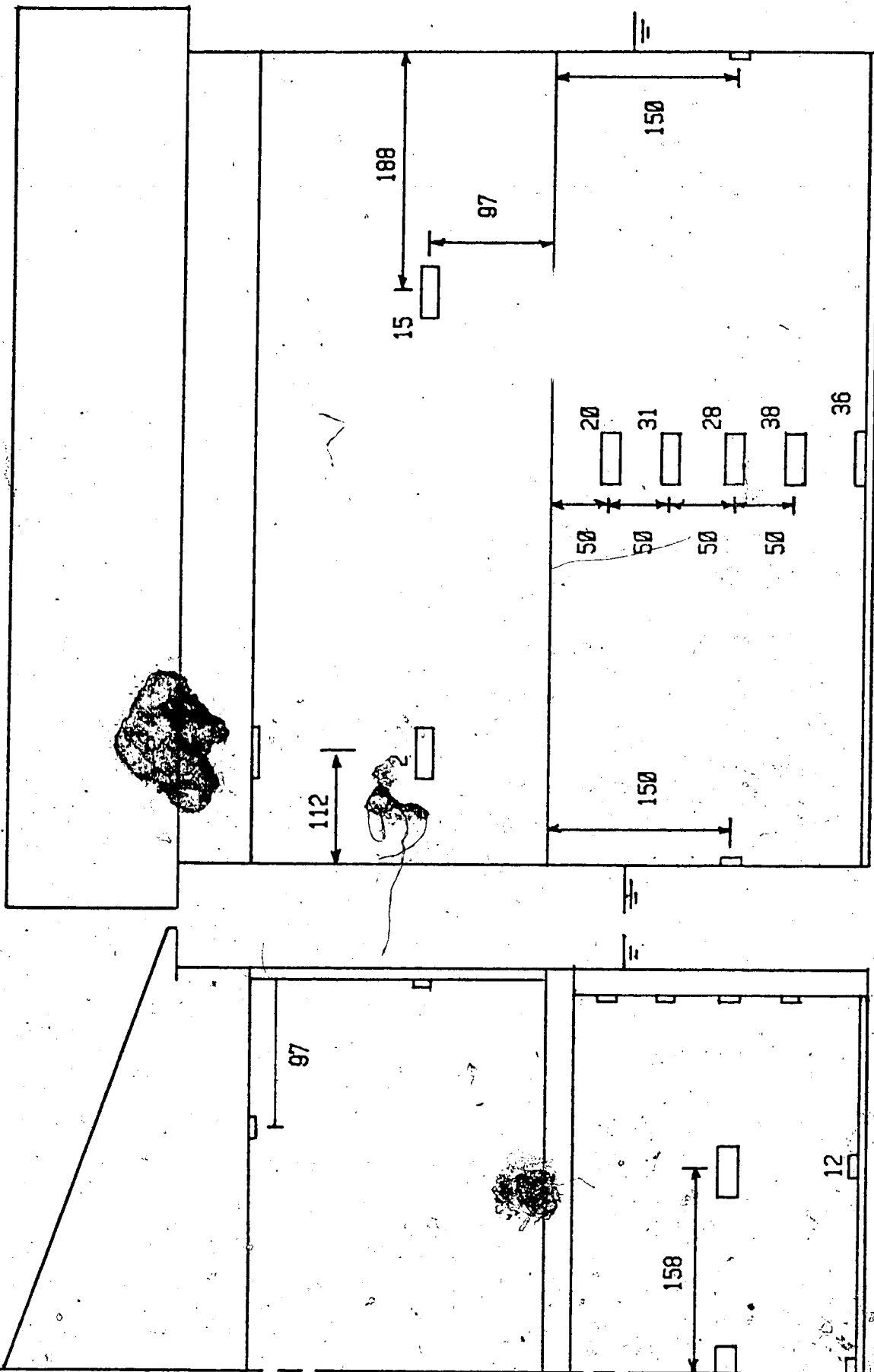

Figure A2.3 Heat Flux Plate Locations - Module 2

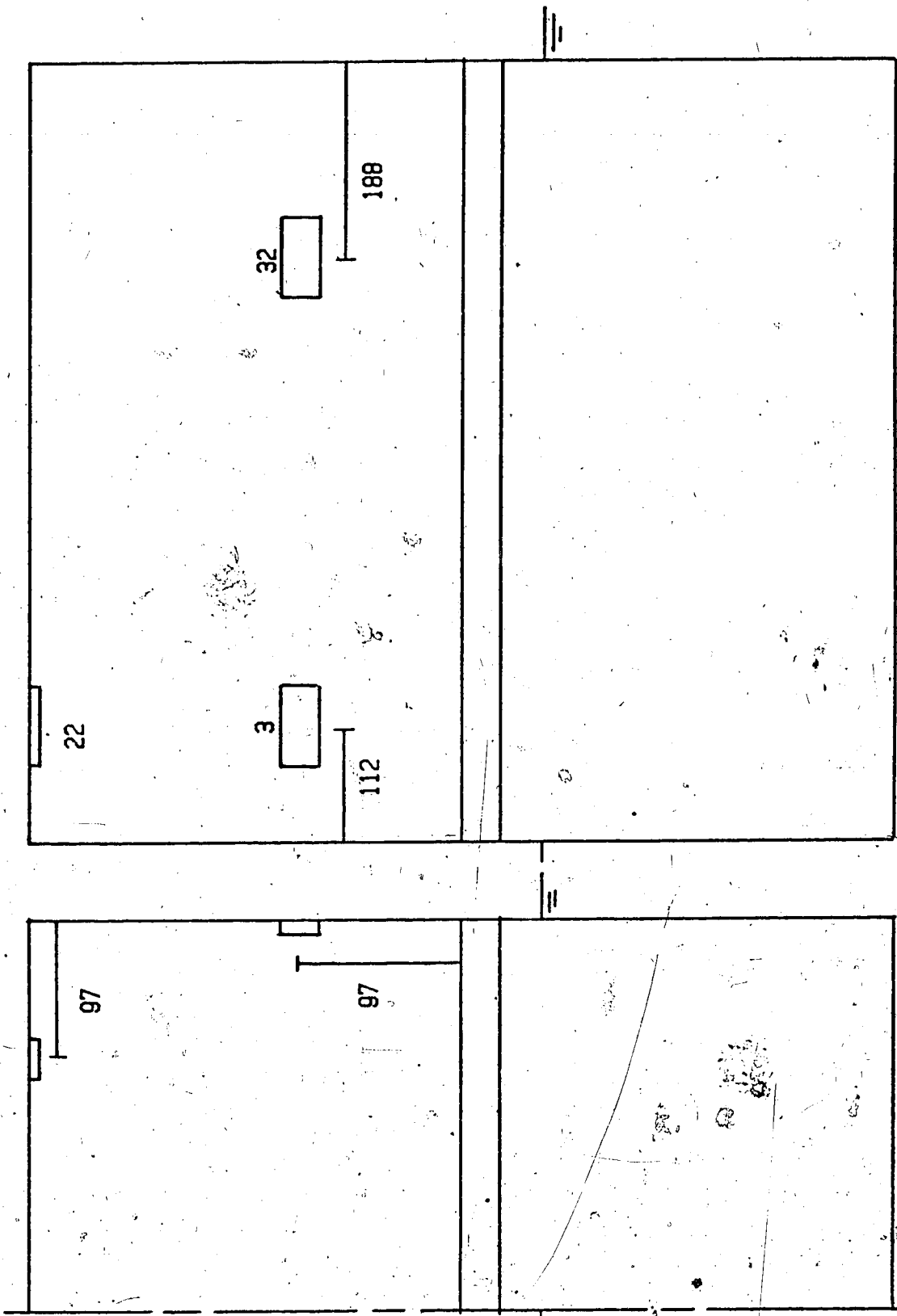

Figure A2.4 Heat Flux Plate Locations - Module 3

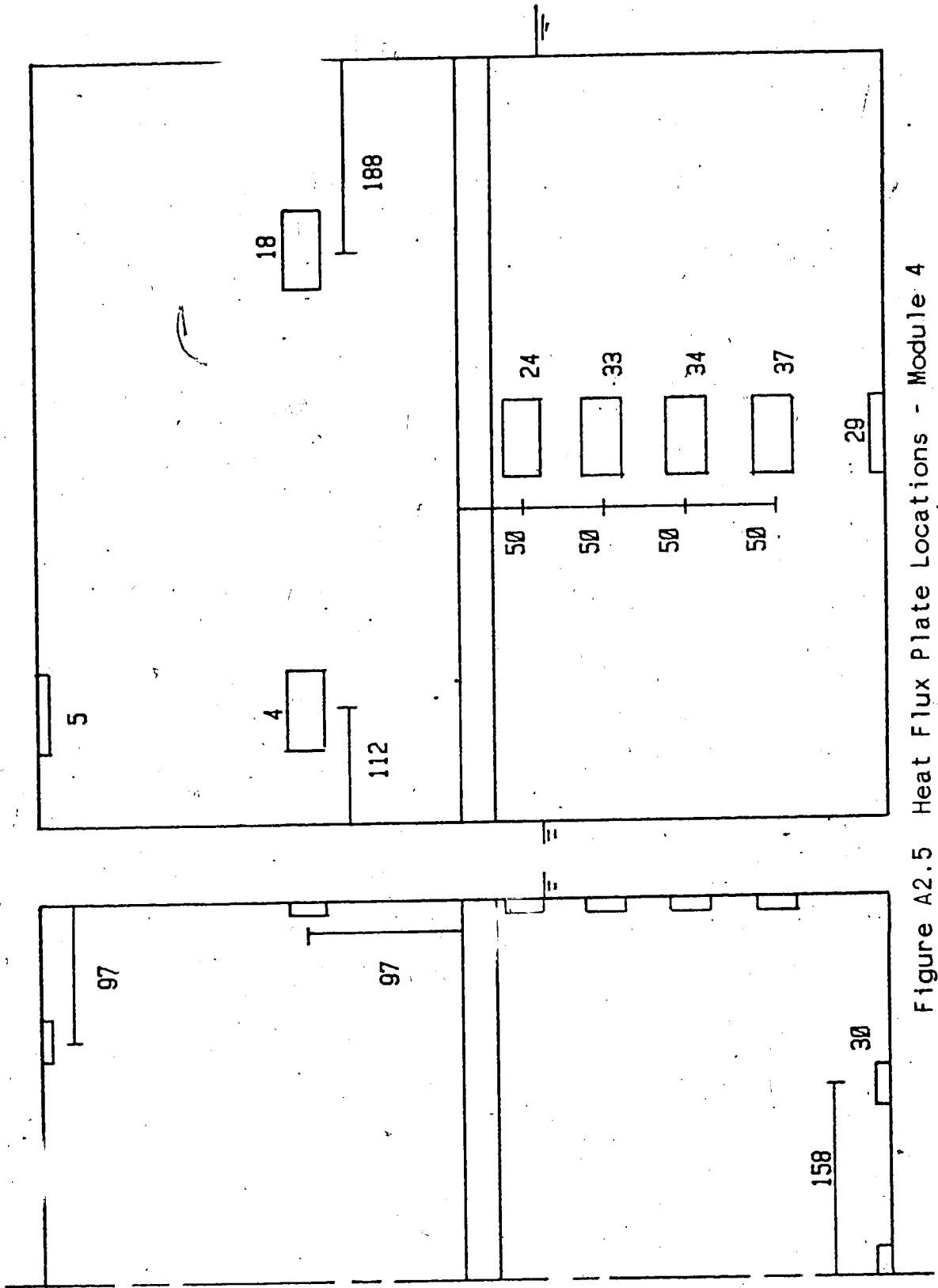

Figure A2.5 Heat Flux Plate Locations - Module 4

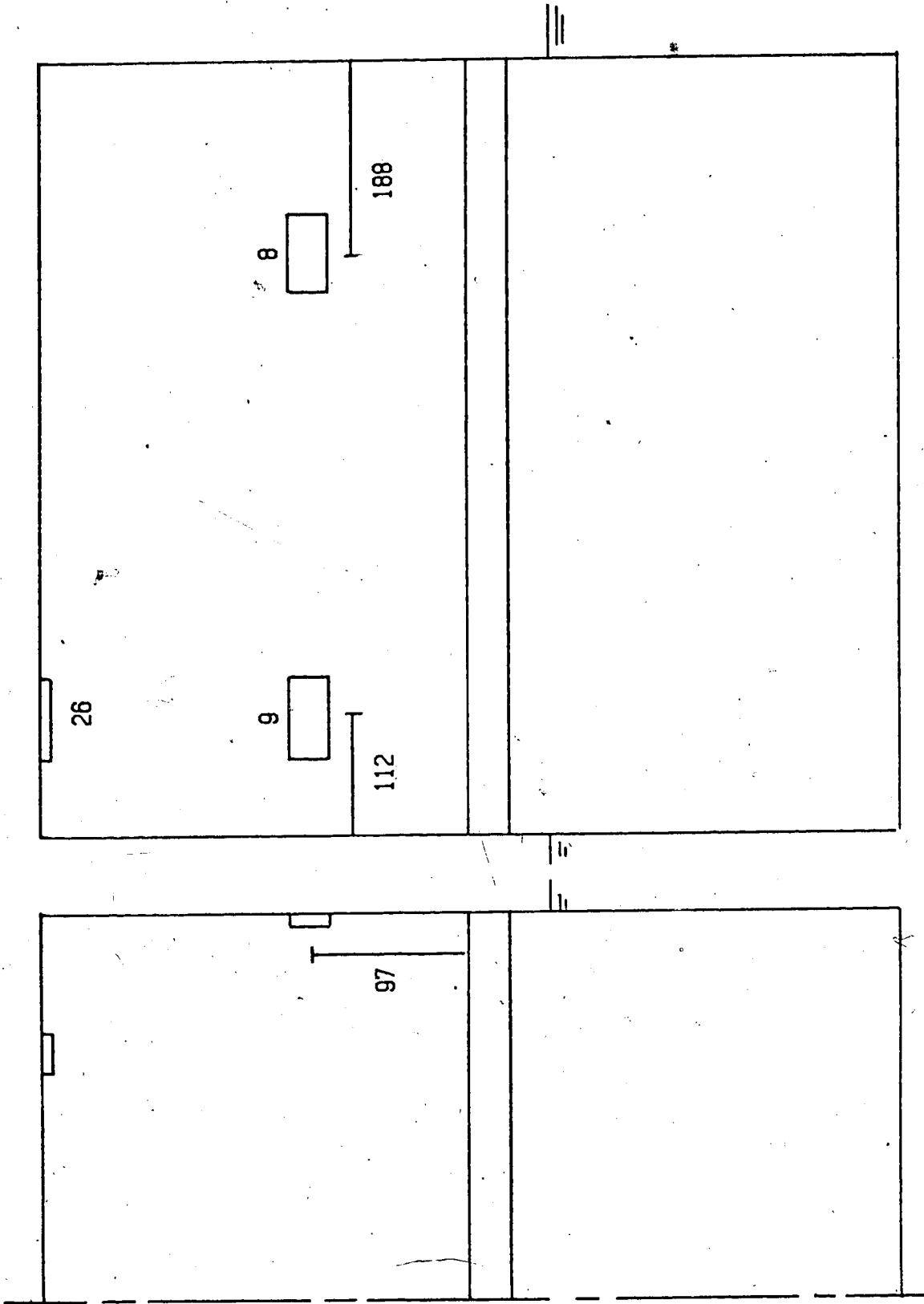

Figure A2.6 Heat Flux Plate Locations - Module 5

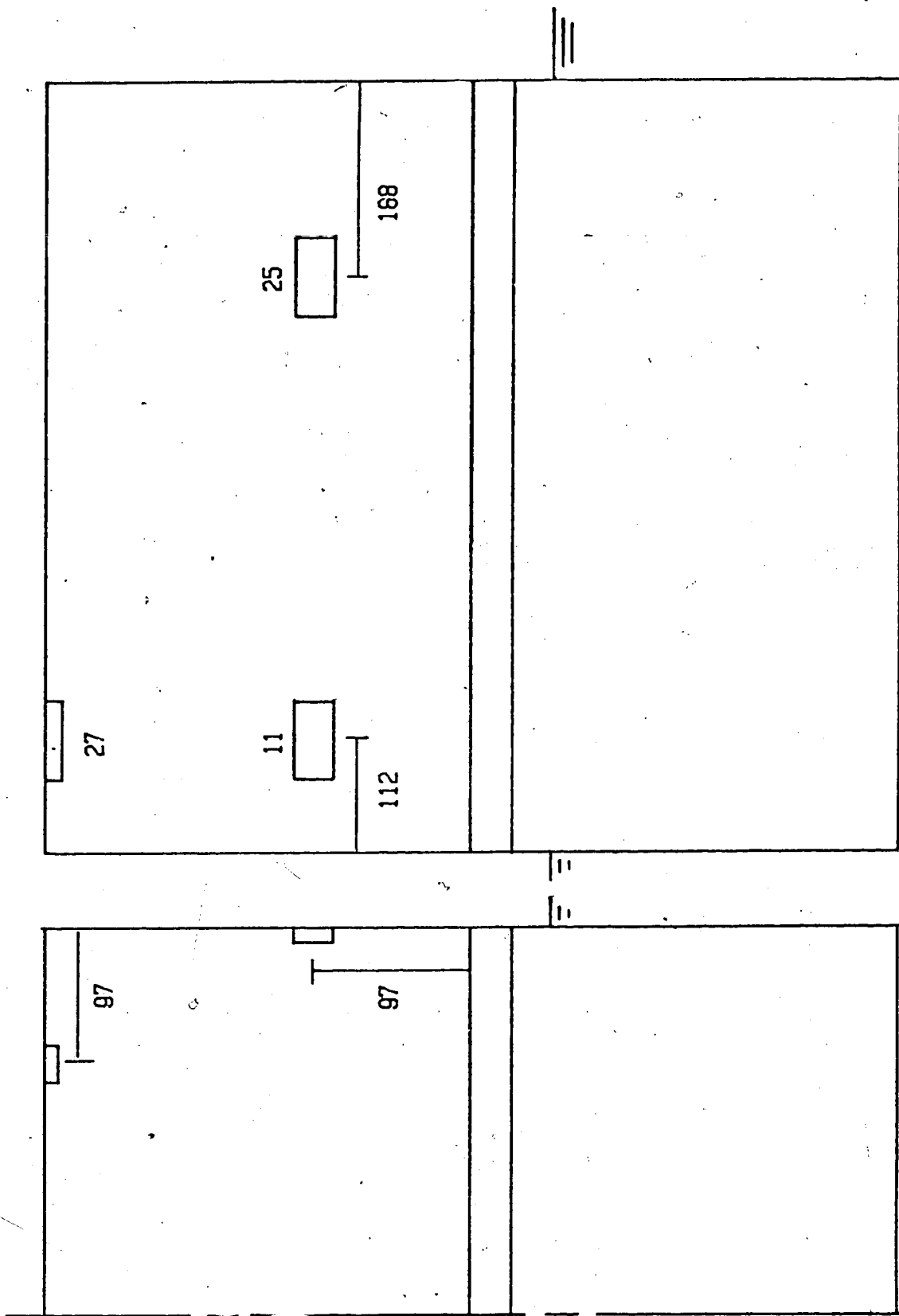

Figure A2.7 Heat Flux Plate Locations - Module 6

Appendix A3

The following section illustrates the method proposed by ASHRAE for the determination of the component heat losses as would be typical of residential building stock in the Edmonton area.

The method used is as follows;

1. determination of each component area
2. determination of the thermal resistance of each component assuming one dimensional steady state heat flow with N parallel heat flow paths and no capacitance effects.
3. summation of all component transmission coefficients to give an overall loss coefficient for each structure.

Following is a list of material properties as used in the calculations and as can be found in the 1977 ASHRAE Fundamentals handbook.

INSULATIONS

1. Glass fiber

- a) 2.5 inch $C=0.143$ Btu/hr.sq.ft.F
- b) 3-3.5 inch $C=0.091$
- c) 5.5-6.5 inch $C=0.053$
- d) 6-7 inch $C=0.045$

2. Expanded Polystyrene (smooth surface)

- a) 1.0 inch $K=0.20$ Btu-in./hr.sq.ft.F

LUMBER

1. Softwoods

- 0.5 inch $C=1.06$ Btu/hr.sq.ft.F
- 1.5 inch $C=0.53$

2.5 inch C=0.32
 3.5 inch C=0.23

2. Plywoods (Douglas Fir)

0.25 inch C=3.20 Btu/hr.sq.ft.F
 0.375 inch C=2.13
 0.50 inch C=1.60
 0.625 inch C=1.29
 0.75 inch C=1.07

MISCELLANEOUS

- 1.) plaster board 0.5 inch
 C=2.22 Btu/hr.sq.ft.F
- 2.) concrete (sand and gravel aggregate)
 K=12.0 Btu-in/hr.sq.ft.F
- 3.) solid wood door 1.5 inch
 U=0.49 Btu/hr.sq.ft.F
- 4.) metal door with urethane core U=.19
- 5.) window (sealed unit 0.5 inch space)
 U=0.49
- 6.) window (horizontal sliding metal sash)
 U=0.59
- 7.) window (horizontal sliding wood sash)
 U=0.47
- 8.) air space (horizontal, 1.5 inch
 mean temperature = 50 F
 Temperature difference=10F, E=.82)
 C=1.12Btu/hr.sq.ft.F
- 9.) air space (vertical, 3.5 inch,
 mean temperature = 50 F,
 Temperature difference=10F, E=.82)
 C=0.99

Module 1 - Short Term Unit

Gross Floor Area = 528 square feet

Gross Wall Area = 736 square feet

Window Area = 63.3 square feet

Door Area = 20.0 square feet

Net Wall Area = 652.7 square feet

Stud spacing = 16 inches on center

Relative wood area (wall) = 13.6%

Relative insulated area (wall) = 86.4%

Roof Truss spacing = 24 inches on center

Relative wood area (ceiling) = 6.25%

Relative insulated area (ceiling) = 93.75%

a) Ceiling

$$\begin{aligned} \text{Relative Wood Area} &= 0.0625 \times 528 \text{ sq.ft.} \\ &= 33 \text{ sq.ft.} \end{aligned}$$

$$\begin{aligned} \text{Relative Insulated Area} &= 0.9375 \times 528 \text{ sq.ft.} \\ &= 495 \text{ sq.ft.} \end{aligned}$$

Path 1 (framing)

$$R1 = 1/h_i + R_a + R_b + R_c + 1/h_o$$

$$R1 = 0.68 + 0.45 + 0.47 + 4.35 + 0.25$$

$$R1 = 6.20 \text{ (hour-sq.ft.-deg.F)/BTU}$$

$$U1 = 1/R1 = 0.161$$

Path 2 (insulation)

$$R2 = 1/h_i + R_a + R_b + R_c + 1/h_o$$

$$R2 = 0.68 + 0.45 + 0.47 + 12.0 + 0.25$$

$$R2 = 13.85 \text{ (hour-sq.ft.-deg.F)/Btu}$$

$$U1 = 1/R1 = 0.072$$

$$UA(\text{total}) = U1 \times A1 + U2 \times A2$$

$$= 0.161 \times 33 + 0.072 \times 495$$

$$= 41.0 \text{ Btu/(hour-deg.F)}$$

$$= 21.62 \text{ Watt/deg.K}$$

B) Main Floor Walls

$$\text{Relative wood area} = 0.136 \times \text{Net wall Area}$$

$$= 0.136 \times 652.7 \text{ sq.ft.}$$

$$= 88.8 \text{ sq.ft.}$$

$$\text{Relative Insulated area} = 0.864 \times 652.7 \text{ sq.ft.}$$

$$= 563.9 \text{ sq.ft.}$$

Path 1 (framing)

$$R1 = 1/h_i + R_a + R_b + R_c + 1/h_o$$

$$R1 = 0.68 + 0.47 + 4.35 + 0.45 + 0.17$$

$$R1 = 6.12 \text{ (hour-sq.ft.-deg.F)/Btu}$$

$$U1 = 1/R1 = 0.163$$

Path 2 (insulation)

$$R2 = 1/h_i + R_a + R_b + R_c + 1/h_o$$

$$R2 = 0.68 + 0.47 + 10.0 + 0.45 + 0.17$$

$$R2 = 11.77 \text{ (hour-sq.ft.-deg.F)/BTU}$$

$$U2 = 1/R2 = 0.085$$

$$UA(\text{total}) = UA1 + UA2$$

$$= 0.163 \times 88.8 + 0.085 \times 563.9$$

$$= 62.4 \text{ BTU/(hour-deg.F)}$$

$$= 32.91 \text{ Watt/deg.K}$$

Figure A3.1 represents the heat flux paths used in the calculation of basement heat losses. The diagram is representative of the construction methods employed in modules 1, 5, and 6.

C) Above Grade Basement Walls

Path 1

$$\begin{aligned} R1 &= 1/h_i + R_a + R_b + R_c + 1/h_o \\ &= 0.68 + 1.89 + 10.0 + 0.63 + 0.17 \\ &= 13.37 \text{ (hour-sq.ft.-deg.F)/Btu} \\ U1 &= 1/R1 = 0.075 \text{ Btu/(hour-sq.ft.deg.F)} \end{aligned}$$

Path 2

$$\begin{aligned} R1 &= 1/h_i + R_a + R_b + R_c + 1/h_o \\ &= 0.68 + 0.64 + 10.0 + 0.63 + 0.17 \\ &= 12.12 \text{ (hour-sq.ft.-deg.F)/Btu} \\ U2 &= 1/R2 = 0.083 \text{ Btu/(hour-sq.ft.-deg.F)} \end{aligned}$$

$$\text{House Perimeter} = 2 \times 22 + 2 \times 24 = 92 \text{ ft.}$$

Area = house perimeter x section height

eg. for a 10 inch vertical section

$$\begin{aligned} \text{Area} &= 92 \times 10/12 \\ &= 76.7 \text{ sq.ft.} \end{aligned}$$

Thus for the above grade portions the transmission coefficient is calculated

as follows:

$$U1 \times A1 + U2 \times A2 = UA(\text{total})$$

$$UA = 0.076 \times 76.7 + 0.084 \times 107.3$$

$$UA = 14.7 \text{ Btu/deg.F-Hour}$$

$$= 7.75 \text{ Watt/deg.K}$$

D) Below Grade Portion of Basement

a) 0-1 foot $R1 = 2.44 + 10.0 + 0.63$

$$U1 = 1/R1 = 0.077 \text{ Btu/(hour-sq.ft.deg.F)}$$

$$UA1 = 0.077 \times 92 = 7.0 \text{ Btu/(hour-deg.F)}$$

$$= 3.69 \text{ Watt/deg.K}$$

b) 1-2 foot $R2 = 10.0 + 0.63 + 4.51$

$$U2 = 1/R2 = 0.066 \text{ Btu/(hour-sq.ft.deg.F)}$$

$$UA2 = 0.066 \times 92 = 6.1 \text{ Btu/(hour-deg.F)}$$

$$= 3.22 \text{ Watt/deg.K}$$

c) 2-3 foot $R3 = 6.45$

$$U3 = 1/R3 = 0.155 \text{ Btu/(hour-sq.ft.deg.F)}$$

$$UA3 = 0.155 \times 92 = 14.3 \text{ Btu/(hour-deg.F)}$$

$$= 7.54 \text{ Watt/deg.K}$$

d) 3-4 foot $R4 = 8.4$

$$U4 = 1/R4 = 0.119 \text{ Btu/(hour-sq.ft.-deg.F)}$$

$$UA4 = 0.119 \times 92 = 11.0 \text{ Btu/(hour-deg.F)}$$

$$= 5.80 \text{ Watt/deg.K}$$

e) 4-5 foot $R5 = 10.42$

$$U5 = 1/R5 = 0.096 \text{ Btu/(hour-sq.ft.-deg.F)}$$

$$\begin{aligned} UA5 &= 0.096 \times 92 = 8.8 \text{ Btu}/(\text{hour-deg.F}) \\ &= 4.64 \text{ Watt}/\text{deg.K} \end{aligned}$$

f) 5-6 foot $R6 = 12.66$

$$U6 = 1/R6 = 0.079 \text{ Btu}/(\text{hour-sq.ft.-deg.F})$$

$$\begin{aligned} UA6 &= 0.079 \times 76.7 = 7.3 \text{ Btu}/(\text{hour-deg.F}) \\ &= 3.85 \text{ Watt}/\text{deg.K} \end{aligned}$$

g) 6-6',10" $R7 = 14.5$

$$U7 = 1/R7 = 0.069 \text{ Btu}/(\text{hour-sq.ft.-deg.F})$$

$$\begin{aligned} UA7 &= 0.069 \times 76.7 = 5.3 \text{ Btu}/(\text{hour-deg.F}) \\ &= 2.80 \text{ Watt}/\text{deg.K} \end{aligned}$$

E Basement Floor

The average loss coefficient for the basement floor was calculated using the ASHRAE tables found in the 1977 fundamentals. Since the exact basement dimensions were not included in the tables a linear interpolation for a basement width of 22 feet and foundation depth of 6 foot 10 inches was necessary

$$U = 0.0325 \text{ Btu per hour-sq.ft.-deg.F}$$

$$\begin{aligned} \text{Area} &= 20.7 \times 22.7 \text{ sq.ft. (interior dimensions)} \\ &= 469.9 \text{ sq.ft.} \end{aligned}$$

$$UA = 15.3 \text{ Btu}/\text{hour-deg.F}$$

$$= 8.07 \text{ Watt}/\text{deg.K}$$

F) Windows (aluminum frame - horizontal slider)

$$U = 0.59 \text{ Btu}/(\text{hour-sq.ft.-deg.F})$$

$$\text{Area} = 63.3 \text{ sq.ft.}$$

$$\begin{aligned}UA &= 37.4 \text{ Btu}/(\text{hour-deg.F}) \\ &= 19.7 \text{ Watt}/\text{deg.K}\end{aligned}$$

G) Door (solid core wood)

$$U = 0.49 \text{ Btu}/(\text{hour-sq.ft.-deg.F})$$

$$\text{Area} = 20.0 \text{ sq.ft}$$

$$\begin{aligned}UA &= 9.8 \text{ Btu}/(\text{hour-deg.F}) \\ &= 5.17 \text{ Watt}/\text{deg.K}\end{aligned}$$

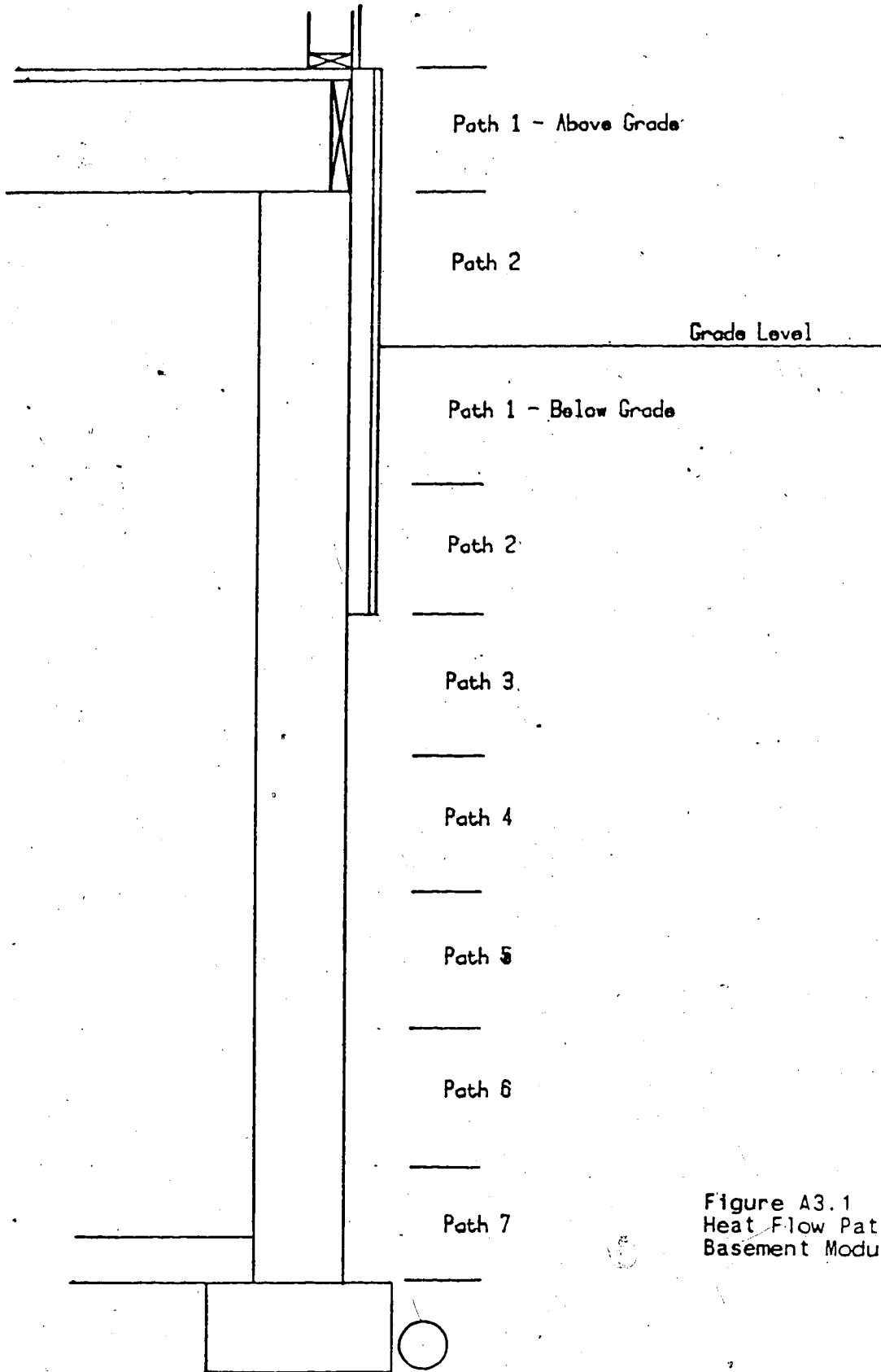

Figure A3.1
Heat Flow Paths-
Basement Module 1

Summary of Calculated Transmission
Coefficients - Short Term Module

Ceiling	41.0 (21.62)
Above Grade Walls	62.4 (32.91)
Above Grade Basement	14.7 (7.75)
Below Grade Basement Walls	59.8 (31.54)
Basement Floor	15.3 (8.07)
Windows	37.4 (19.72)
Door	9.8 (5.17)
Total	240.4 Btu/(deg.F-hour) (126.8 Watt/deg.K)

Module 2 - Standard Unit

Gross Floor Area = 528 square feet

Gross Wall Area = 736 square feet

Window Area = 63.3 square feet

Door Area = 20.0 square feet

Net Wall Area = 652.7 square feet

Stud Spacing = 16 inches on center

Relative Wood Area (wall) = 13.6%

Relative Insulated area (wall) = 86.4%

Roof Truss Spacing = 24 inches on center

Relative Wood Area (ceiling) = 6.25%

Relative Insulation Area (ceiling) = 93.75%

A) Ceiling

$$\begin{aligned} \text{Relative Wood Area} &= 0.0625 \times 528 \\ &= 33.0 \text{ sq.ft.} \end{aligned}$$

$$\begin{aligned} \text{Relative Insulated Area} &= 0.9375 \times 528 \\ &= 495 \text{ sq.ft.} \end{aligned}$$

Path 1 (framing)

$$\begin{aligned} R_1 &= 1/h_i = R_a + R_b + 1/h_o \\ &= 0.68 + 0.45 + 4.35 + 0.25 \\ &= 5.73 \text{ (hour-sq.ft.-deg.F)/Btu} \\ U_1 &= 1/R_1 \\ &= 0.175 \text{ Btu/(hour-sq.ft.deg.F)} \end{aligned}$$

Path 2 (insulation)

$$\begin{aligned}
 R_2 &= 1/h_i + R_a + R_b + 1/h_o \\
 &= 0.68 + 0.45 + 12.0 + 0.25 \\
 &= 13.38 \text{ hour-sq.ft.-deg.F/Btu}
 \end{aligned}$$

$$U_2 = 1/R_2 = 0.075 \text{ Btu/(hour-sq.ft.-deg.F)}$$

$$\begin{aligned}
 U \times \text{Area} &= U_1 \times \text{Area}_1 + U_2 \times \text{Area}_2 \\
 &= 0.175 \times 33.0 + 0.075 \times 495.0 \\
 &= 42.9 \text{ Btu/(hour-deg.F)} \\
 &= 22.63 \text{ Watt/deg.K}
 \end{aligned}$$

B) Main Floor Walls

$$\begin{aligned}
 \text{Relative wood area} &= 13.6\% \times \text{Net wall area} \\
 &= 0.136 \times 652.7 \\
 &= 88.8 \text{ sq.ft.}
 \end{aligned}$$

$$\begin{aligned}
 \text{Relative Insulated Area} &= .864 \times \text{Net wall Area} \\
 &= 0.864 \times 652.7 \\
 &= 563.9 \text{ sq.ft.}
 \end{aligned}$$

Path 1

$$\begin{aligned}
 R_1 &= 1/h_i + R_a + R_b + R_c + 1/h_o \\
 &= 0.68 + 0.45 + 4.35 + 0.47 + 0.17 \\
 &= 6.12 \text{ (hour-sq.ft-deg.F)/Btu}
 \end{aligned}$$

$$\begin{aligned}
 U_1 &= 1/R_1 \\
 &= 0.163 \text{ Btu/(hour-sq.ft.-deg.F)}
 \end{aligned}$$

Path 2

$$\begin{aligned}
 R_2 &= 1/h_i + R_a + R_b + R_c + 1/h_o \\
 &= 0.68 + 0.45 + 8.0 + 0.47 + 0.17 \\
 &= 9.77 \text{ (hour-sq.ft.-deg.F)/Btu}
 \end{aligned}$$

$$\begin{aligned}
 U_2 &= 1/R_2 \\
 &= 0.102 \text{ Btu}/(\text{hour-sq.ft.}-\text{deg.F})
 \end{aligned}$$

$$\begin{aligned}
 UA(\text{total}) &= U_1 \times A_1 + U_2 \times A_2 \\
 &= 72.2 \text{ Btu}/(\text{deg.F}-\text{hour}) \\
 &= 38.08 \text{ Watt}/\text{deg.K}
 \end{aligned}$$

C) Above Grade Basement Walls

The above grade basement portion of module two can be subdivided into three parallel heat flow paths:

- 1) through the joist header
- 2) concrete wall with plywood covering
- 3) uninsulated concrete wall

However, since the area associated with the second path is extremely small that area is included in the area associated with path three.

$$\begin{aligned}
 \text{Path 1 } R_1 &= 1/h_i + R_a + R_b + 1/h_o \\
 &= 0.68 + 1.89 + 0.63 + 0.17 \\
 &= 3.36 \text{ (hour-sq.ft.}-\text{deg.F})/\text{Btu} \\
 U_1 &= 1/R_1 = .30 \text{ Btu}/(\text{hour-sq.ft.}-\text{deg.F})
 \end{aligned}$$

$$\begin{aligned}
 \text{Path 3 } R_2 &= 1/h_i + R_a + 1/h_o \\
 &= 0.68 + 0.64 + 0.17 \\
 &= 1.49 \text{ (hour-sq.ft.}-\text{deg.F})/\text{Btu} \\
 U_2 &= 1/R_2 = 0.67 \text{ Btu}/(\text{hour-sq.ft.}-\text{deg.F})
 \end{aligned}$$

House Perimeter = 92 feet

$$\text{Area 1} = 92 \times 10/12 = 76.7 \text{ sq.ft.}$$

$$\text{Area 3} = 92 \times 14/12 = 107.3 \text{ sq.ft.}$$

Above Grade Basement Transmission Coefficient

$$UA(\text{total}) = U_1 \times A_1 + U_3 \times A_3$$

$$\begin{aligned} &= 0.30 \times 76.7 + 0.67 \times 107.3 \\ &= 94.8 \text{ Btu}/(\text{hour-deg.F}) \\ &= 50.00 \text{ Watt}/\text{deg.K} \end{aligned}$$

D) Below Grade Basement Walls

a) 0-1 foot

$$\begin{aligned} R_1 &= 2.44 \text{ (hour-sq.ft.-deg.F)}/\text{Btu} \\ U_1 &= 1/R_1 = 0.41 \\ U_{x\text{Area}} &= 0.41 \times 92 \\ &= 37.7 \text{ Btu}/(\text{hour-deg.F}) \\ &= 19.88 \text{ Watt}/\text{deg.K} \end{aligned}$$

b) 1-2 foot

$$\begin{aligned} R_2 &= 4.51 \text{ (hour-sq.ft.-deg.F)}/\text{Btu} \\ U_2 &= 1/R_2 = 0.222 \\ U_{x\text{Area}} &= 0.22 \times 92 \\ &= 20.4 \text{ Btu}/(\text{hour-deg.F}) \\ &= 10.76 \text{ Watt}/\text{deg.K} \end{aligned}$$

c) 2-3 foot

$$\begin{aligned} R_3 &= 6.45 \text{ (hour-sq.ft.-deg.F)}/\text{Btu} \\ U_3 &= 1/R_3 = 0.155 \\ U_{x\text{Area}} &= 0.155 \times 92 \\ &= 14.3 \text{ Btu}/(\text{hour-deg.F}) \\ &= 7.54 \text{ Watt}/\text{deg.K} \end{aligned}$$

d) 3-4 foot

$$\begin{aligned} R_4 &= 8.4 \text{ (hour-sq.ft.-deg.F)}/\text{Btu} \\ U_4 &= 1/R_4 = 0.119 \end{aligned}$$

$$\begin{aligned}
 UxArea &= 0.119 \times 92 \\
 &= 11.0 \text{ Btu}/(\text{hour-deg.F}) \\
 &= 5.80 \text{ Watt}/\text{deg.K}
 \end{aligned}$$

e) 4-5 foot

$$\begin{aligned}
 R5 &= 10.4 \text{ (hour-sq.ft.-deg.F)}/\text{Btu} \\
 U5 &= 1/R5 = 0.096 \\
 UxArea &= 0.096 \times 92 \\
 &= 8.8 \text{ Btu}/(\text{hour-deg.F}) \\
 &= 4.64 \text{ Watt}/\text{deg.K}
 \end{aligned}$$

f) 5-6 foot

$$\begin{aligned}
 R6 &= 12.7 \text{ (hour-sq.ft.deg.F)}/\text{Btu} \\
 U6 &= 1/R6 = 0.079 \\
 UxArea &= 0.079 \times 92 \\
 &= 7.3 \text{ Btu}/(\text{hour-deg.F}) \\
 &= 3.85 \text{ Watt}/\text{deg.K}
 \end{aligned}$$

g) 6-6' 10"

$$\begin{aligned}
 R7 &= 14.5 \text{ (hour-sq.ft.-deg.F)}/\text{Btu} \\
 U7 &= 1/R7 = 0.069 \\
 UxArea &= 0.069 \times 76.7 \\
 &= 5.3 \text{ Btu}/(\text{hour-deg.F}) \\
 &= 2.80 \text{ Watt}/\text{deg.K}
 \end{aligned}$$

The total loss coefficient for the below grade basement walls is equal to the sum of the individual section coefficients.

$$UA(\text{below grade}) = 37.7 + 20.4 + 14.3 + 11.0 + 8.8 + 7.3 + 5.3$$

$$= 104.8 \text{ Btu}/(\text{hour-deg.F})$$

$$= 55.27 \text{ Watt}/\text{deg.K}$$

E) Basement Floor

As for the previous module the loss coefficient associated with the basement floor is a linear interpolation of the ASHRAE data.

$$U = 0.0325 \text{ Btu}/(\text{hour-sq.ft.-deg.F})$$

$$\text{Area} = 469.9 \text{ sq.ft.}$$

$$UA = 15.3 \text{ Btu}/(\text{hour-deg.F})$$

$$= 8.07 \text{ Watt}/\text{deg.K}$$

F) Windows (aluminum frame - horizontal slider)

$$U = 0.59 \text{ Btu}/(\text{hour-sq.ft.deg.F})$$

$$\text{Area} = 63.3 \text{ sq.ft.}$$

$$UA = 37.4 \text{ Btu}/(\text{hour-deg.F})$$

$$= 19.72 \text{ Watt}/\text{deg.K}$$

G) Door (solid core - wood)

$$U = 0.49 \text{ Btu}/(\text{hour-sq.ft.-deg.F})$$

$$\text{Area} = 20.0 \text{ sq.ft.}$$

$$UA = 9.8 \text{ Btu}/(\text{hour-deg.F})$$

$$= 5.17 \text{ Watt}/\text{deg.K}$$

Summary of Calculated Transmission
Coefficients - Standard Module

Ceiling	42.9 (22.63)
Above Grade Walls	72.2 (38.08)
Above Grade Basement	94.8 (50.00)
Below Grade Basement Walls	104.8 (55.27)
Basement Floor	15.3 (8.07)
Windows	37.4 (19.72)
Door	9.8 (5.17)
Total	377.2 Btu/(deg.F-hour) (198.9 Watt/deg.K)

Module 3 - Conservation Unit

Gross Floor Area = 528 sq.ft.

Gross Wall Area = 736 sq.ft.

Window Area = 70.8 sq.ft.

Door Area = 20.0 sq.ft.

Net Wall Area = 645.2 sq.ft.

Stud Spacing = 16 inches on center

Roof Truss Spacing = 24 inches on center

Figures A3.2 and A3.3 show the construction techniques employed to achieve the high insulation levels found in the conservation module. As can be seen in the diagrams, the composite structure requires that the thermal analysis be done using several parallel heat flow paths. Although the areas associated with some of the paths are small relative to the others and have negligible effect on the overall thermal performance estimate they are included for completeness.

A) Ceiling

Path 1

$$\begin{aligned} R1 &= 1/h_i + R_a + R_b + R_c + R_d + 1/h_o \\ &= 0.68 + 0.45 + 1.03 + 0.47 + 80.0 + 0.25 \\ &= 82.88 \text{ (hour-sq.ft.-deg.F)} \end{aligned}$$

$$U1 = 1/R1 = 0.012 \text{ Btu/(hour-sq.ft.-deg.F)}$$

Path 2

$$\begin{aligned}
 R_2 &= 1/h_i + R_a + R_b + R_c + R_d + 1/h_o \\
 &= .68 + .45 + 1.89 + .47 + 80.0 + .25 \\
 &= 83.74 \text{ (hour-sq.ft.-deg.F)/Btu}
 \end{aligned}$$

$$U_2 = 1/R_2 = 0.0119 \text{ Btu/(hour-sq.ft.-deg.F)}$$

Path 3

$$\begin{aligned}
 R_3 &= 1/h_i + R_a + R_b + R_c + R_d + 1/h_o \\
 &= .68 + .45 + 1.03 + .47 + 4.35 + 68.0 + .25 \\
 &= 75.23 \text{ (hour-sq.ft.deg.F)/Btu}
 \end{aligned}$$

$$U_3 = 1/R_3 = 0.0133 \text{ Btu/(hour-sq.ft.-deg.F)}$$

Path 4

$$\begin{aligned}
 R_4 &= 1/h_i + R_a + R_b + R_c + R_d + 1/h_o \\
 &= .68 + .45 + 1.89 + .47 + 4.35 + 68.0 + .25 \\
 &= 76.1 \text{ (hour-sq.ft.-deg.F)/Btu}
 \end{aligned}$$

$$U_4 = 1/R_4 = 0.0131 \text{ Btu/(hour-sq.ft.-deg.F)}$$

The corresponding areas for each path are as follows:

Path 1 - 445.1 square feet
 Path 2 - 51.8 square feet
 Path 3 - 29.7 square feet
 Path 4 - 3.5 square feet

As was done previously, the overall UA-factor is equal to the sum of the individual UA products.

$$\begin{aligned}
 UA &= U_1 \times A_1 + U_2 \times A_2 + U_3 \times A_3 + U_4 \times A_4 \\
 &= .012 \times 443.1 + .0119 \times 51.8 + .0133 \times 29.7 + .0131 \times 3.5 \\
 &= 6.4 \text{ Btu/(hour-sq.ft.-deg.F)} \\
 &= 3.38 \text{ Watt/deg.K}
 \end{aligned}$$

B) Main Floor Walls

Path 1

$$\begin{aligned}
 R1 &= 1/h_i + R_a + R_b + R_c + R_d + R_e + R_f + 1/h_o \\
 &= .68 + .45 + 1.03 + .47 + 20.0 + 20.0 + .47 + .17 \\
 &= 43.3 \text{ (hour-sq. ft. deg. F) / Btu}
 \end{aligned}$$

$$U1 = 1/R1 = 0.023 \text{ Btu / (hour-sq. ft. -deg. F)}$$

Path 2

$$\begin{aligned}
 R2 &= 1/h_i + R_a + R_b + R_c + R_d + R_e + R_f + 1/h_o \\
 &= .68 + .45 + 4.35 + .47 + 20.0 + 20.0 + .47 + .17 \\
 &= 46.6 \text{ (hour-sq. ft. -deg. F) / Btu}
 \end{aligned}$$

$$U2 = 1/R2 = 0.022 \text{ Btu / (hour-sq. ft. -deg. F)}$$

Path 3

$$\begin{aligned}
 R3 &= 1/h_i + R_a + R_b + R_c + R_d + R_e + R_f + 1/h_o \\
 &= .68 + .45 + 1.03 + .47 + 30.0 + 1.89 + .47 + .17 \\
 &= 35.2 \text{ (hour-sq. ft. -deg. F) / Btu}
 \end{aligned}$$

$$U3 = 1/R3 = 0.028 \text{ Btu / (hour-sq. ft. -deg. F)}$$

Path 4

$$\begin{aligned}
 R4 &= 1/h_i + R_a + R_b + R_c + R_d + R_e + R_f + 1/h_o \\
 &= .68 + .45 + 4.35 + .47 + 30.0 + 1.89 + .47 + .17 \\
 &= 38.5 \text{ (hour-sq. ft. -deg. F) / Btu}
 \end{aligned}$$

$$U4 = 1/R4 = 0.026 \text{ Btu / (hour-sq. ft. -deg. F)}$$

Corresponding Areas:

Path 1 - 519.4 square feet
 Path 2 - 55.5 square feet
 Path 3 - 48.5 square feet
 Path 4 - 21.8 square feet

$$UA(\text{total}) = U1 \times A1 + U2 \times A2 + U3 \times A3 + U4 \times A4$$

$$= .023 \times 519.2 + .022 \times 55.4 + .028 \times 48.5 + .026 \times 21.9$$

$$= 15.1 \text{ (Btu / hour-deg. F)}$$

$$= 7.96 \text{ Watt/deg.K}$$

C) Above Grade Basement Walls

Figure A3.3 shows the construction detail and placement of insulation on the basement of the conservation module. The most appropriate method of dividing the areas is at the location where the floor joists meet the concrete wall and at six inches above the grade where the above grade wall insulation ends. Division in this manner effectively creates three parallel heat flow paths.

Path 1

$$\begin{aligned} R_1 &= 1/h_i + R_1 + R_2 + R_3 + R_4 + R_5 + R_6 + 1/h_o \\ &= 0.68 + 1.89 + 20.0 + 0.63 + 7.5 + 10.0 + 0.47 + 0.17 \\ &= 41.3 \text{ (hour-sq.ft.-deg.F)/Btu} \end{aligned}$$

$$U_1 = 1/R_1 = 0.024 \text{ Btu/(hour-sq.ft.-deg.F)}$$

Path 2

$$\begin{aligned} R_2 &= 1/h_i + R_1 + R_2 + R_3 + R_4 + R_5 + R_6 + 1/h_o \\ &= 0.68 + 0.64 + 20.0 + 0.63 + 7.5 + 10.0 + 0.47 + 0.17 \\ &= 40.1 \text{ (hour-sq.ft.-deg.F)/Btu} \end{aligned}$$

$$U_2 = 1/R_2 = 0.025 \text{ Btu/(hour-sq.ft.-deg.F)}$$

Path 3

$$\begin{aligned} R_3 &= 1/h_i + R_1 + R_2 + R_3 + 1/h_o \\ &= 0.68 + 0.64 + 20.0 + 0.63 + 0.17 \\ &= 22.1 \text{ (hour-sq.ft.-deg.F)/Btu} \end{aligned}$$

$$U_3 = 1/R_3 = .045 \text{ Btu/(hour-sq.ft.-deg.F)}$$

Corresponding Areas:

Path 1 - 76.6 square feet

Path 2 - 61.3 square feet

Path 3 - 46.0 square feet

$$\begin{aligned}
 UxArea(\text{total}) &= U_1 \times A_1 + U_2 \times A_2 + U_3 \times A_3 \\
 &= .024 \times 76.7 + .025 \times 61.3 \\
 &\quad + .045 \times 22.0 \\
 &= 4.4 \text{ Btu}/(\text{hour-deg.F}) \\
 &= 2.32 \text{ Watt}/\text{deg.K}
 \end{aligned}$$

D) Below Grade Basement Walls

As was done previously, the below grade portion of the basement was divided into horizontal one foot intervals so that the values of heat flux per foot of perimeter determined by ASHRAE could be directly applied. The only variation was the addition of a factor to account for the increased insulation level.

- a) 0-1 foot $R_1 = 2.44 + 0.63 + 20.0$
 $U_1 = 1/R_1 = 1/23.1 = 0.043$
 $UA_1 = 0.043 \times 92 = 4.0 \text{ Btu}/(\text{hr.}-\text{deg.F})$
 $= 2.11 \text{ Watt}/\text{deg.K}$
- b) 1-2 foot $R_2 = 4.5 + 0.63 + 20.0$
 $U_1 = 1/R_1 = 1/25.13 = .040$
 $UA_2 = 0.040 \times 92 = 3.7 \text{ Btu}/(\text{hr.}-\text{deg.F})$
 $= 1.95 \text{ Watt}/\text{deg.K}$
- c) 2-3 foot $R_3 = 6.45 + +20.0$
 $U_3 = 1/R_3 = 1/26.45 = .039$
 $UA_3 = 0.039 \times 92 = 3.5 \text{ Btu}/(\text{hr.}-\text{deg.F})$
 $= 1.85 \text{ Watt}/\text{deg.K}$
- d) 3-4 foot $R_4 = 8.4 + 20.0$
 $U_4 = 1/R_4 = 1/28.4 = 0.035$

$$\begin{aligned}
 UA4 &= 0.035 \times 92 = 3.2 \text{ Btu}/(\text{hr.}-\text{deg. F}) \\
 &= 1.69 \text{ Watt}/\text{deg. K}
 \end{aligned}$$

e) 4-5 foot $R5 = 10.41 + 20.0$

$$U5 = 1/R5 = 1/30.41 = 0.033$$

$$\begin{aligned}
 UA5 &= 0.033 \times 92 = 3.0 \text{ Btu}/(\text{hr.}-\text{deg. F}) \\
 &= 1.58 \text{ Watt}/\text{deg. K}
 \end{aligned}$$

f) 5-6 foot $R6 = 12.7 + 20.0$

$$U6 = 1/R6 = 1/32.7 = 0.031$$

$$\begin{aligned}
 UA6 &= 0.031 \times 92 = 2.8 \text{ Btu}/(\text{hr.}-\text{deg. F}) \\
 &= 1.48 \text{ Watt}/\text{deg. K}
 \end{aligned}$$

g) 6-6 foot 10 inch

$$R7 = 14.5 + 20.0$$

$$U7 = 1/R7 = 1/34.5 = 0.029$$

$$\begin{aligned}
 UA7 &= 0.029 \times 76.7 = 2.2 \text{ Btu}/(\text{hr.}-\text{deg. F}) \\
 &= 1.16 \text{ Watt}/\text{deg. K}
 \end{aligned}$$

$$UA(\text{total}) = U \times A1 + U \times A2 + \dots$$

$$= 22.4 \text{ Btu}/(\text{hour}-\text{deg. F})$$

$$= 11.81 \text{ Watt}/\text{deg. K}$$

E) Basement Floor

Average Loss Coefficient per square foot of floor

$$U = 0.0325 \text{ Btu}/(\text{hour}-\text{sq. ft.}-\text{deg. F})$$

$$\text{Area} = 20.7 \times 22.7 \text{ sq. ft.}$$

$$= 469.9 \text{ sq. ft.}$$

$$U \times \text{Area} = 15.3 \text{ Btu}/(\text{hour}-\text{deg. F})$$

$$= 8.07 \text{ Watt}/\text{deg. K}$$

F) Windows (sealed units)

$$U = 0.49 \text{ Btu}/(\text{hour-sq.ft.deg.F})$$

$$\text{Area} = 70.75 \text{ sq.ft.}$$

$$U \times \text{Area} = 34.7 \text{ Btu}/(\text{hour-deg.F})$$

$$= 18.30 \text{ Watt/deg.K}$$

G) Door (urethane foam core)

$$U = 0.19 \text{ Btu}/(\text{hour-sq.ft.-deg.F})$$

$$\text{Area} = 20.0 \text{ sq.ft.}$$

$$U \times \text{Area} = 3.8 \text{ Btu}/(\text{hour-deg.F})$$

$$= 2.00 \text{ Watt/deg.K}$$

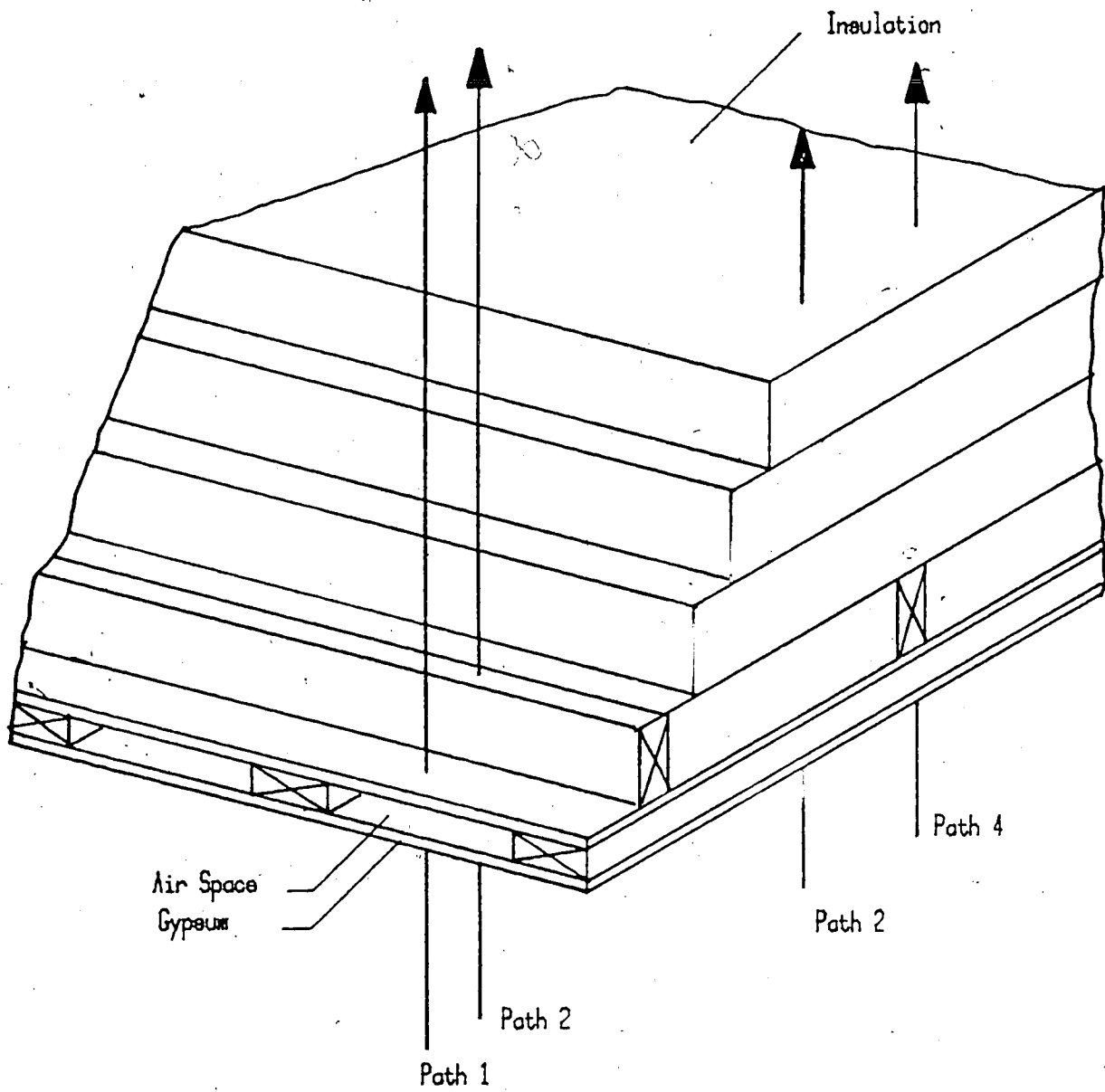

Figure A3.2 Heat Flow Paths - Ceiling Module 3

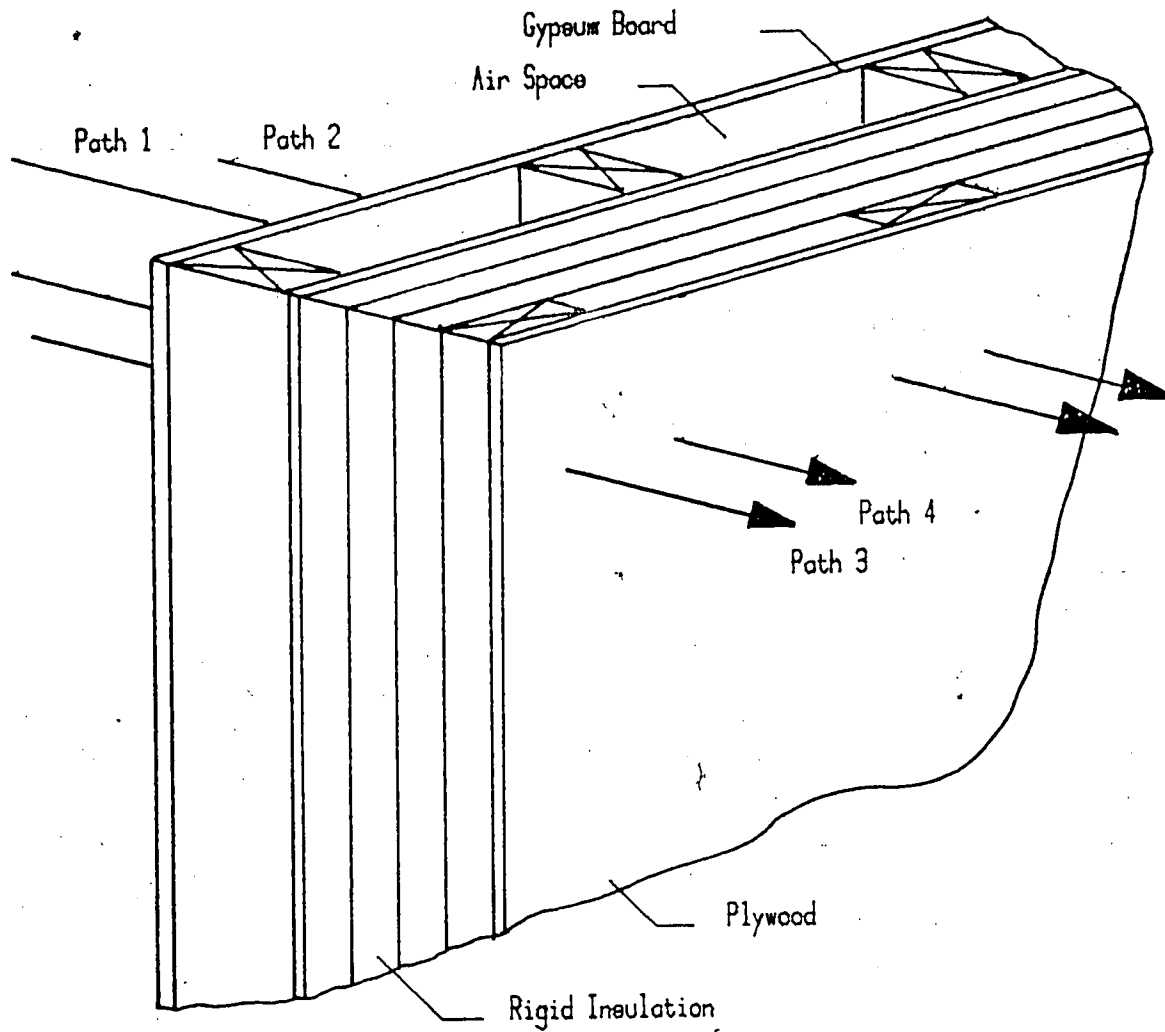

Figure A3.3 Heat Flow Paths - Wall Module 3

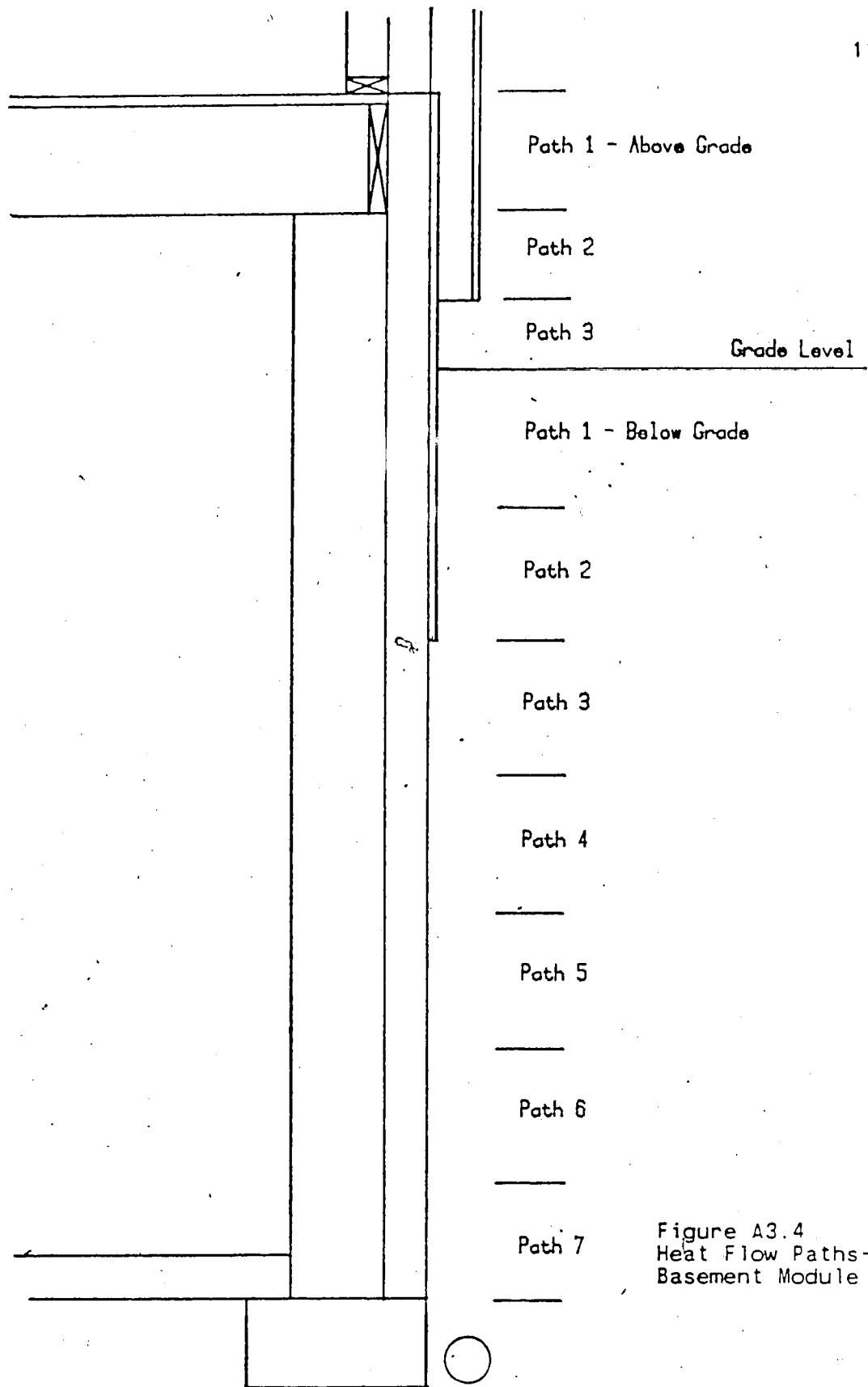

Figure A3.4
Heat Flow Paths-
Basement Module 3

Summary of Calculated Transmission
Coefficients - Conservation Module

Ceiling	6.4 (3.38)
Above Grade Walls	15.1 (7.96)
Above Grade Basement	4.4 (2.32)
Below Grade Basement Walls	22.4 (11.81)
Basement Floor	15.3 (8.07)
Windows	34.7 (8.07)
Door	3.8 (2.00)
Total	102.1 Btu/(deg.F-hour) (53.85 Watt/deg.K)

Module 4 - Passive Solar Unit

The Passive solar module employs construction techniques that were found in both passively heated houses and commercially built energy efficient housing. The main deviation from standard commercially built residences is the use of rigid styrofoam on the exterior of the structure in place of the normal sheathing. The method allows builders to achieve a thermal insulation value of roughly R-20 (RSI-3.5) without adding appreciably to the final cost of the home.

Gross floor Area = 528 square feet

Gross Wall Area = 736 square feet

Window area = 120.4 square feet

Net Wall Area = 595.6 square feet

Stud Spacing = 16 inches on center

Relative Wood Area (wall) = 13.6%

Relative Insulated Area (wall) = 86.4%

Roof Truss Spacing = 24 inches on center

Relative Wood Area (ceiling) = 6.25%

Relative Insulation Area (ceiling) = 93.75%

A) Ceiling

Wood Area = $0.0625 \times 528 = 33.0$ square feet

Insulated Area = $0.9375 \times 528 = 495.0$ square feet

As shown in fig A3.5 the composite nature of the ceiling necessitates the use of four parallel heat flow paths for the assesment of an overall loss coefficient.

Path 1

$$\begin{aligned} R1 &= 1/h_i + R_a + R_b + R_c + R_d + R_e + 1/h_o \\ &= .68 + .45 + 1.03 + .47 + 12.0 + 28.0 + .25 \\ &= 42.88 \text{ (hour-sq.ft.deg.F)/Btu} \end{aligned}$$

$$U1 = 1/R1 = 0.023$$

Path 2

$$\begin{aligned} R2 &= 1/h_i + R_a + R_b + R_c + R_d + R_e + 1/h_o \\ &= .68 + .45 + 1.89 + .47 + 12.0 + 28.0 + .25 \\ &= 43.74 \text{ (hour-sq.ft.-deg.F)/Btu} \end{aligned}$$

$$U2 = 1/R2 = 0.023$$

Path 3

$$\begin{aligned} R3 &= 1/h_i + R_a + R_b + R_c + R_d + R_e + 1/h_o \\ &= .68 + .45 + 1.03 + .47 + 4.35 + 28.0 + .25 \\ &= 35.23 \text{ (hour-sq.ft.-deg.F)/Btu} \end{aligned}$$

$$U3 = 1/R3 = 0.028 \text{ Btu/(hour-sq.ft.-deg.F)}$$

Path 4

$$\begin{aligned} R4 &= 1/h_i + R_a + R_b + R_c + R_d + R_e + 1/h_o \\ &= .68 + .45 + 1.89 + .47 + 4.35 + 28.0 + .25 \\ &= 36.09 \text{ (hour-sq.ft.-deg.F)/Btu} \end{aligned}$$

$$U4 = 1/R4 = 0.028 \text{ Btu/(hour-sq.ft.-deg.F)}$$

The corresponding Areas:

Path 1 -	443.0 square feet
Path 2 -	51.8 square feet
Path 3 -	29.7 square feet
Path 4 -	3.5 square feet

The overall transmission coefficient the sum of the individual transmission - area products.

$$U_x \text{Area} = U1 \times A1 + U2 \times A2 + \dots$$

$$\begin{aligned}
 &= 0.023 \times 433.0 + 0.023 \times 51.8 \\
 &\quad + 0.028 \times 29.74 + 0.028 \times 3.5 \\
 &= 12.3 \text{ Btu}/(\text{hour-deg.F}) \\
 &= 6.49 \text{ Watt}/\text{deg.K}
 \end{aligned}$$

B) Main Floor Walls

Relative Areas

$$\begin{aligned}
 \text{Framing } A1 &= 0.136 \times \text{Net Wall Area} \\
 &= 0.136 \times 595.6 \text{ sq.ft.} \\
 &= 81.0 \text{ sq.ft}
 \end{aligned}$$

$$\begin{aligned}
 \text{Insulation } A2 &= 0.864 \times \text{Net Wall Area} \\
 &= 0.864 \times 595.6 \text{ sq.ft.} \\
 &= 514.6 \text{ sq.ft.}
 \end{aligned}$$

Path 1 (wood framing)

$$\begin{aligned}
 R1 &= 1/h_i + R_a + R_b + R_c + R_d + R_e + 1/h_o \\
 &= .68 + .45 + 4.35 + .47 + 10.0 + .47 + .17 \\
 &= 16.59 \text{ (hour-sq.ft.-deg.F)}/\text{Btu} \\
 U1 &= 1/R1 = 0.060 \text{ Btu}/(\text{hour-deg.F})
 \end{aligned}$$

Path 2 (insulation)

$$\begin{aligned}
 R2 &= 1/h_i + R_a + R_b + R_c + R_d + R_e + 1/h_o \\
 &= .68 + .45 + 10.0 + .47 + 10.0 + .47 + .17 \\
 &= 22.4 \text{ (hour-sq.ft.-deg.F)}/\text{Btu} \\
 U2 &= 1/R2 = 0.045 \text{ Btu}/(\text{hour-deg.F})
 \end{aligned}$$

$$\begin{aligned}
 U_x \text{Area (total)} &= U1 \times A1 + U2 \times A2 \\
 &= 0.060 \times 81.0 + 0.045 \times 514.6 \\
 &= 28.0 \text{ Btu}/\text{hour-deg.F} \\
 &= 14.77 \text{ Watt}/\text{deg.K}
 \end{aligned}$$

C) Above Grade Basement Walls

Figure A3.7 shows a cross section of a basement wall in the Passive Module. The above grade portion of the wall can be broken into two distinct areas as depicted in the figure.

Path 1

$$\begin{aligned} R_1 &= 1/h_i + R_a + R_b + R_c + 1/h_o \\ &= 0.68 + 1.89 + 10.0 + 0.63 + 0.17 \\ &= 13.37 \text{ (hour-sq.ft.-deg.F)}/\text{Btu} \end{aligned}$$

$$U_1 = 1/R_1 = 0.075$$

$$\text{Area 1} = 76.7 \text{ sq.ft.}$$

$$\begin{aligned} U_1 \times \text{Area 1} &= 0.075 \times 76.7 \\ &= 5.7 \text{ Btu}/(\text{hour-deg.F}) \\ &= 3.01 \text{ Watt}/\text{deg.K} \end{aligned}$$

Path 2

$$\begin{aligned} R_2 &= 1/h_i + R_a + R_b + R_c + 1/h_o \\ &= 0.68 + 0.64 + 10.0 + 0.63 + 0.17 \\ &= 12.12 \text{ (hour-sq.ft.-deg.F)}/\text{Btu} \end{aligned}$$

$$U_2 = 1/R_2 = 0.084$$

$$\text{Area 2} = 107.3 \text{ sq.ft.}$$

$$\begin{aligned} U_2 \times \text{Area 2} &= 0.084 \times 107.3 \\ &= 8.9 \text{ Btu}/(\text{hour-deg.F}) \\ &= 4.69 \text{ Watt}/\text{deg.K} \end{aligned}$$

$$\begin{aligned} \text{Above Grade Total} &= 5.7 + 8.9 = 14.6 \text{ Btu}/\text{hour-deg.F} \\ &= 7.70 \text{ Watt}/\text{deg.K} \end{aligned}$$

D) Below Grade Basement Wall

$$\begin{aligned} \text{a) 0-1 foot} \quad R_1 &= 2.44 + 10.0 + 0.63 \\ &= 13.07 \text{ (hour-sq.ft.-deg.F)}/\text{Btu} \end{aligned}$$

$$-U1 = 1/R1 = 0.077$$

$$U1 \times \text{Area} = 0.077 \times 92.0 = 7.0 \text{ Btu/hour-deg.F}$$

$$= 3.69 \text{ Watt/deg.K}$$

b) 1-2 foot $R2 = 4.51 + 10.0 + 0.63$

$$= 15.14 \text{ (hour-sq.ft.-deg.F)/Btu}$$

$$U2 = 1/R2 = 0.066$$

$$U2 \times \text{Area} = 0.066 \times 92.0 = 6.1 \text{ Btu/hour-deg.F}$$

$$= 3.22 \text{ Watt/deg.K}$$

c) 2-3 foot $R3 = 6.45 + 10.0$

$$= 14.98 \text{ (hour-sq.ft.-deg.F)/Btu}$$

$$U3 = 1/R3 = 0.067$$

$$U3 \times \text{Area} = 0.067 \times 92.0 = 5.6 \text{ Btu/(hour-deg.F)}$$

$$= 2.95 \text{ Watt/deg.K}$$

d) 3-4 foot $R4 = 8.40 + 10.0$

$$= 18.40 \text{ (hour-sq.ft.-deg.F)/Btu}$$

$$U4 = 1/R4 = 0.054$$

$$U4 \times \text{Area} = 0.054 \times 92 = 5.0 \text{ Btu/(hour-deg.F)}$$

$$= 2.64 \text{ Watt/deg.K}$$

e) 4-5 foot $R5 = 10.42 + 10.0$

$$= 20.42 \text{ (hour-sq.ft.-deg.F)/Btu}$$

$$U5 = 1/R5 = 0.049$$

$$U5 \times \text{Area} = 0.049 \times 92 = 4.5 \text{ Btu/(hour-deg.F)}$$

$$= 2.37 \text{ Watt/deg.K}$$

f) 5-6 foot $R6 = 12.66 + 10.0$

$$= 22.66 \text{ (hour-sq.ft.-deg.F)/Btu}$$

$$U_6 = 1/R_6 = 0.044$$

$$\begin{aligned} U_6 \times \text{Area} &= 0.044 \times 92 = 4.1 \text{ Btu/(hour-deg.F)} \\ &= 2.16 \text{ Watt/deg.K} \end{aligned}$$

g) 6-6' 10" $R_7 = 14.50 + 10.0$

$$= 24.50 \text{ (hour-sq.ft.-deg.F)/Btu}$$

$$U_7 = 1/R_7 = 0.041$$

$$\begin{aligned} U_7 \times \text{Area} &= 0.041 \times 76.7 = 3.1 \text{ Btu/(hour-deg.F)} \\ &= 1.63 \text{ Watt/deg.K} \end{aligned}$$

The total below grade wall loss coefficient is equal to the sum of the individual UA products.

$$\begin{aligned} \text{UA(total)} &= 7.0 + 6.1 + 5.6 + 5.0 + 4.5 + 4.1 + 3.1 \\ &= 35.4 \text{ Btu/(hour-deg.F)} \\ &= 18.67 \text{ Watt/deg.K} \end{aligned}$$

E) Basement Floor

$$U = 0.0325 \text{ Btu/(hour-sq.ft.-deg.F)}$$

$$\text{Area} = 469.9 \text{ square feet}$$

$$\begin{aligned} U \times \text{Area} &= 15.3 \text{ Btu/(hour-deg.F)} \\ &= 8.07 \text{ Watt/deg.K} \end{aligned}$$

F) Windows (sealed unit - two lites)

$$U = 0.49 \text{ Btu/(hour-sq.ft.-deg.F)}$$

$$\text{Area} = 120.4 \text{ square feet}$$

$$\begin{aligned} U \times \text{Area} &= 59.0 \text{ Btu/(hour-deg.F)} \\ &= 31.12 \text{ Watt/deg.K} \end{aligned}$$

G) Door (urethane core)

$$U = 0.19 \text{ Btu}/(\text{hour-sq. ft. -deg. F})$$

$$\text{Area} = 20.0 \text{ square feet}$$

$$U \times \text{Area} = 3.8 \text{ Btu}/(\text{hour-deg. F})$$

$$= 2.00 \text{ Watt/deg. K}$$

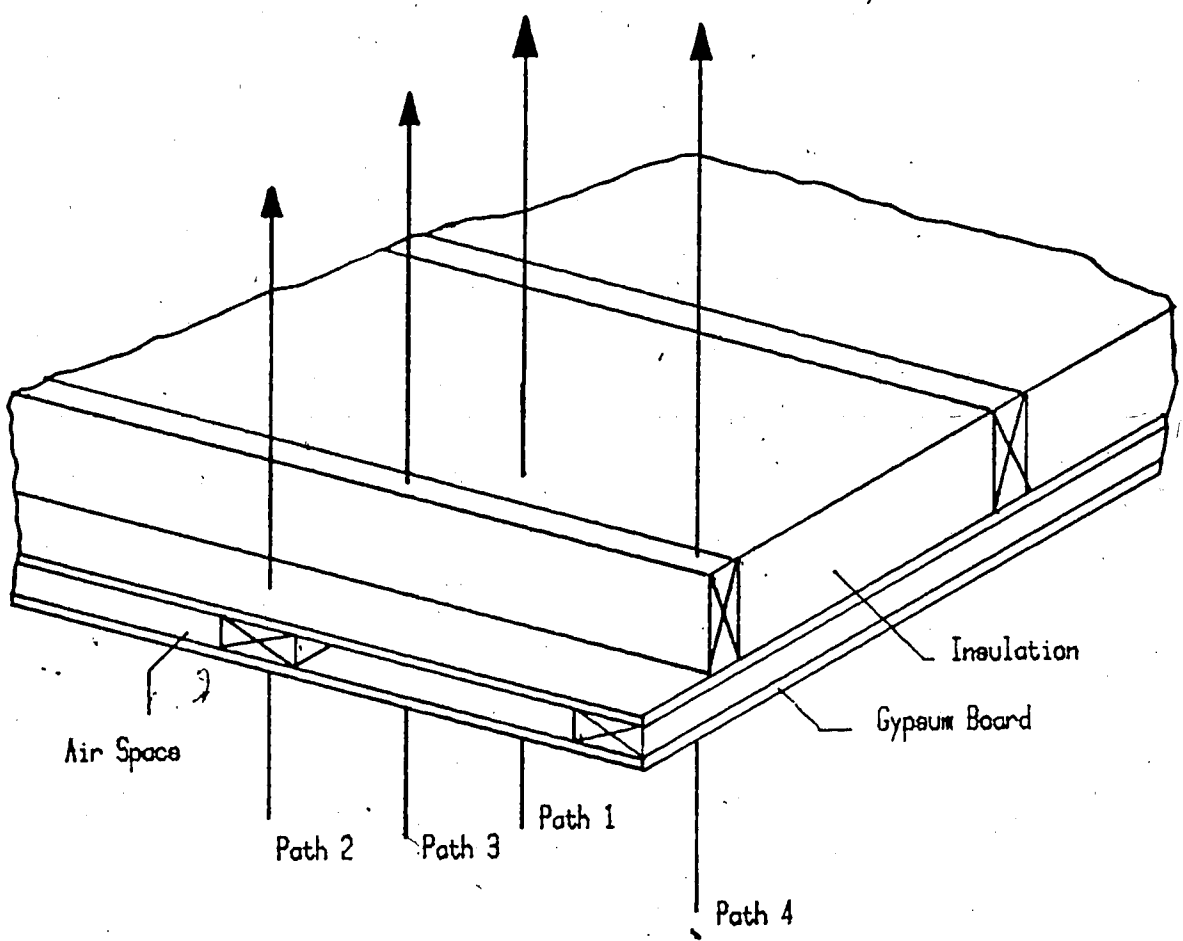

Figure A3.5 Heat Flow Paths - Ceiling Module 4

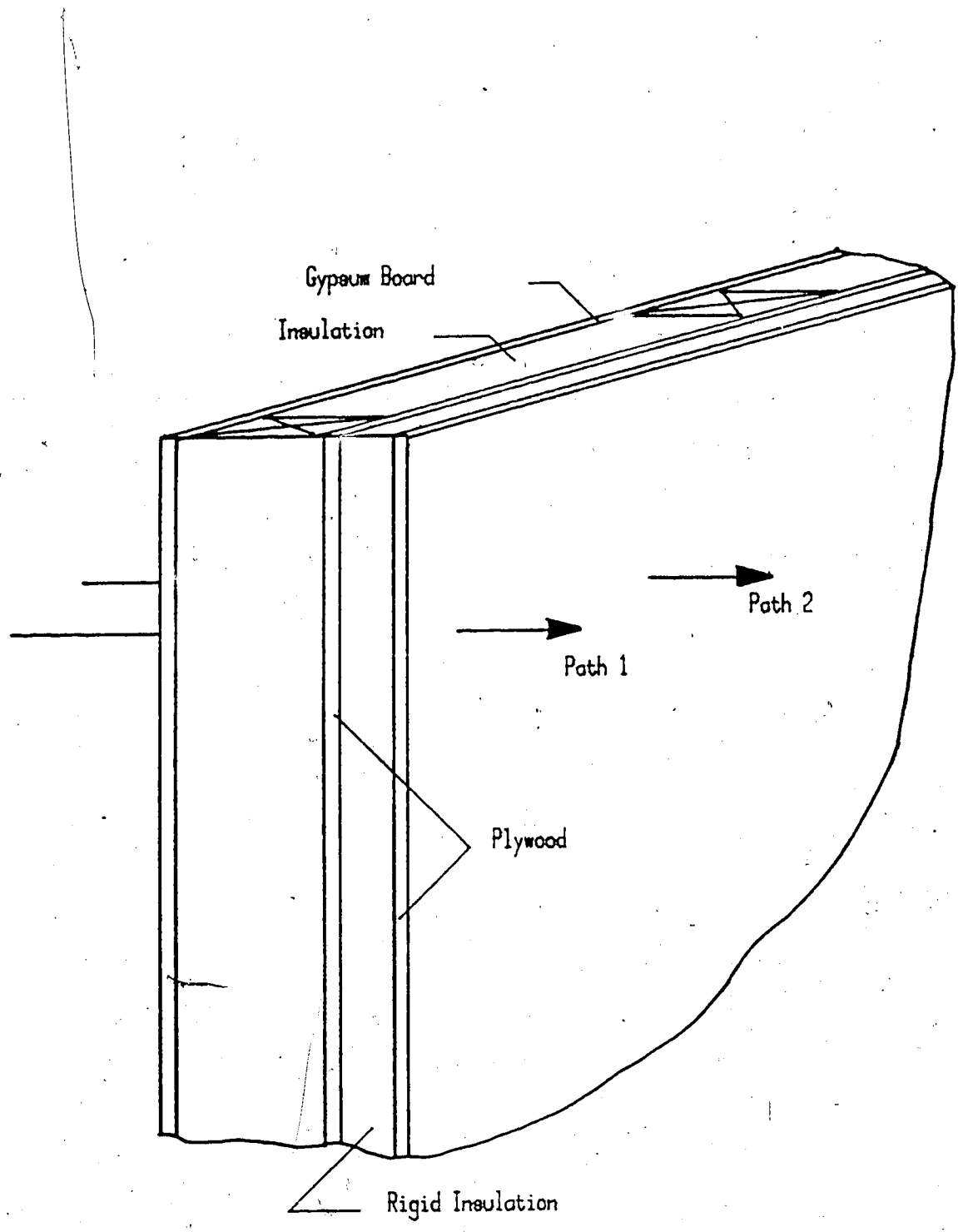

Figure A3.6 Heat Flow Paths - Wall Module 4

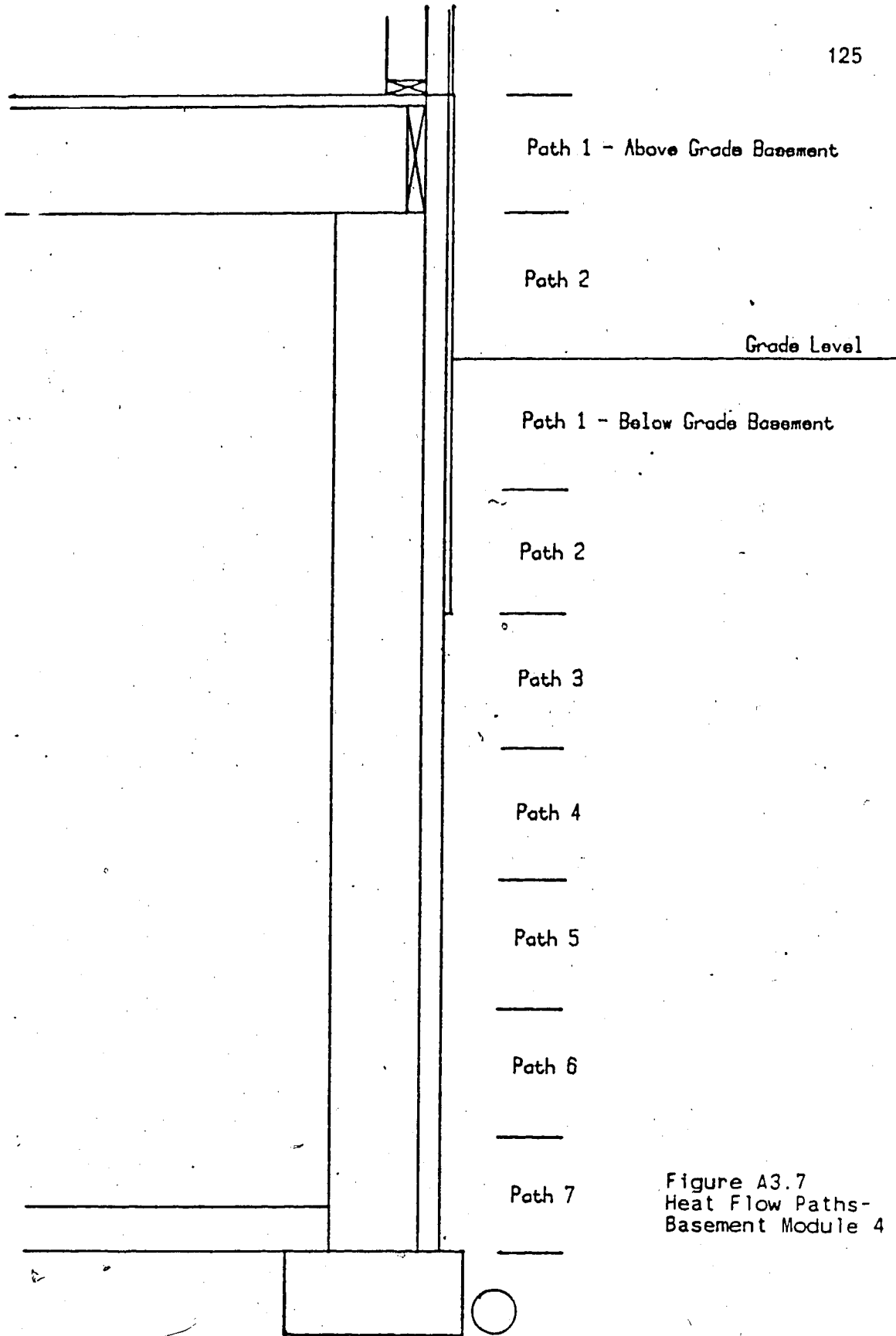

Figure A3.7
Heat Flow Paths-
Basement Module 4

Summary of Calculated Transmission
Coefficients - Passive Module

Ceiling	12.3 (6.49)
Above Grade Walls	28.0 (14.77)
Above Grade Basement Walls	14.6 (7.70)
Below Grade Basement Walls	35.4 (18.67)
Basement Floor	15.3 (8.07)
Windows	59.0 (31.12)
Door	3.8 (2.00)
Total	168.4 Btu/(hour-deg.F) (88.8 Watt/deg.K)



Module 5 Active Liquid Module

The Active Liquid Module is identical to the Short Term Module with a few minor exceptions, thus only the differences are dealt with here.

F) Windows (Horizontal Vinyl Sliding)

$$U = 0.47 \text{ Btu}/(\text{hour-sq.ft.}-\text{deg.F})$$

$$\text{Area} = 63.3 \text{ square feet}$$

$$\begin{aligned} U \times \text{Area} &= 0.47 \times 63.3 = 29.8 \text{ Btu}/(\text{hour-deg.F}) \\ &= 15.72 \text{ Watt}/\text{deg.K} \end{aligned}$$

G) Door (urethane foam core)

$$U = 0.19 \text{ Btu}/(\text{hour-sq.ft.}-\text{deg.F})$$

$$\text{Area} = 20.0 \text{ square feet}$$

$$\begin{aligned} U \times \text{Area} &= 0.19 \times 20.0 = 3.8 \text{ Btu}/(\text{hour-deg.F}) \\ &= 2.00 \text{ Watt}/\text{deg.K} \end{aligned}$$

Summary of Calculated Transmission
Coefficients - Active Liquid Module

Ceiling	41.0 (21.62)
Above Grade Walls	62.4 (32.91)
Above Grade Basement Walls	14.7 (7.75)
Below Grade Basement Walls	59.8 (31.54)
Basement Floor	15.3 (8.07)
Windows	29.8 (15.72)
Door	3.8 (2.00)
Total	226.8 Btu/(hour-deg.F) (119.61 Watt/deg.K)

Module 6 - Active Air Module

The Active Air module is identical to the Active Liquid Module with the exception of ceiling insulation. Additional insulation was added in February 1979 to evaluate the effects of retrofitting a ceiling from R-12 (RSI- 2.11) to R-32 (RSI-6.63).

Ceiling Area = 528 square feet

Truss Spacing = 24 inches on center

Relative Wood Area = 6.25%

Relative Insulation Area = 83.75%

Wood Path Area = $0.0625 \times 528 = 33.0$ sq.ft.

Insulation Path Area = $0.8375 \times 528 = 495.0$ sq.ft.

A) Ceiling

a) Path 1 (framing)

$$\begin{aligned} R_1 &= 1/h_i + R_a + R_b + R_c + 1/h_o \\ &= 0.68 + 0.45 + 4.35 + 20.0 + 0.25 \\ &= 25.73 \text{ (hour-sq.ft.-deg.F)/Btu} \end{aligned}$$

$$U_1 = 1/R_1 = 0.039 \text{ Btu/(hour-sq.ft.-deg.F)}$$

b) Path 2 (insulation)

$$\begin{aligned} R_2 &= 1/h_i + R_a + R_b + R_c + 1/h_o \\ &= 0.68 + 0.45 + 12.0 + 20.0 + 0.25 \\ &= 33.38 \text{ (hour-sq.ft.-deg.F)/Btu} \end{aligned}$$

$$U_2 = 1/R_2 = 0.030 \text{ Btu/(hour-sq.ft.-deg.F)}$$

Overall Ceiling Transmission Coefficient

$$\begin{aligned}UxArea &= U1 \times Area1 + U2 \times Area2 \\&= 0.039 \times 33.0 + 0.030 \times 495.0 \\&= 16.1 \text{ Btu}/(\text{hour-deg.F}) \\&= 8.49\text{Watt}/\text{deg.K}\end{aligned}$$

Summary of Calculated Transmission
Coefficients - Active Air Module

Ceiling	16.1 (8.49)
Main Floor Walls	62.4 (32.91)
Above Grade Basement Walls	14.7 (7.75)
Below Grade Basement Walls	59.8 (31.54)
Basement Floor	15.3 (8.07)
Windows	29.8 (15.72)
Door	3.8 (2.00)
Total	201.9 Btu/(deg.F-hour) (106.5 Watt/deg.K)

Appendix A4

The calculation of heat loss from below grade structures as presented by Boileau and Latta (7) and included in the ASHRAE 1977 Fundamentals Handbook is based on the following assumptions.

- 1) 10 inch thick concrete walls
- 2) Soil conductivity $K_s = 9.6$
(Btu-in.)/(hr.-sq.ft.-deg.F)
- 3) Conductivity of concrete $K_c =$
 12 (Btu-in)/(hr.-sq.ft.-deg.F)
- 4) Internal air film $C_i = 1.5$ Btu/(hr.-sq.ft.-deg.F)
- 5) External air film $C_e = 6.0$ Btu/(hr.-sq.ft.-deg.F)
- 6) Radial isotherms

Thus for the modules tested it was necessary to calculate heat losses using the actual parameters of wall thickness and depth below grade so that a proper comparison of calculated vs measured heat fluxes could be carried out.

The first step is the calculation of equivalent soil path lengths for the air films, the wall, and any insulation which is placed on the wall.

Thus for the inner air film:

$$L_i = K_s/C_i = 9.6/1.5 = 6.4 \text{ inches}$$

Similarly for the outer film:

$$L_o = K_s/C_o = 9.6/6.0 = 1.6 \text{ inches}$$

For the concrete wall:

$$L_c = (K_c/K_s) \times 8 \text{ in} = (9.6/12.0) \times 8 \text{ in} = 6.4 \text{ inches}$$

Therefore the total path length is equal to the sum of the soil equivalents and the actual soil path length. As shown in figure A4.1 the heat loss area A is given by $dr \times 1$ foot and the soil path length is found by integrating the quarter arc length from h_1 to h_2 .

Thus:

$$Q = K_s \Delta T \int_{h_1}^{h_2} \text{Area} / (\pi r / 2 + L_i + L_c + L_o)$$

To illustrate the method consider the heat flow as would be seen by a heat flux meter placed in the uninsulated basement of the standard module at a location three feet below the exterior ground surface. The heat loss per foot of width was calculated as follows.

$$\begin{aligned} Q(\text{per foot of width}) &= K_s \Delta T \int_{h_1}^{h_2} dr / (\pi r / 2 + L_i + L_c + L_o) \\ &= 2K_s \Delta T / \pi \left[\ln(3.50/2) + 1.19 - \ln(2.50/2) + 1.19 \right] \\ &= 0.17 K_s \Delta T \end{aligned}$$

If a value of 0.8 is used for soil conductivity,

$$Q = 0.14 \Delta T \text{ Btu}/(\text{hr.} \cdot \text{sq. ft.} \cdot \text{deg. F})$$

A similar calculation for the depth corresponding to each below grade heat flux plate was done as follows to determine whether or not the methods outlined by Boileau and Latta (7) showed the same deviation from measured results at all depths.

The plates were located at three depths below grade so the calculations were done over a one foot depth centered on the plate location.

- 1) for the uninsulated basement

$$q = \frac{2k\Delta T}{\pi} \left[\ln \left(\frac{\pi h_2 / 2 + l}{\pi h_1 / 2 + l} \right) \right]$$

where $l = l_i + l_c + l_o$

2) for the insulated basement

$$q = \frac{2k\Delta T}{\pi} \left[\ln \left(\frac{\pi h_2 / 2 + l_1}{\pi h_1 / 2 + l_1} \right) \right]$$

where $l_1 = l_i + l_c + l_{ins} + l_o$

The following table summarizes the result of the calculations for the depths listed.

Depth (feet)	Uninsulated R (RSI)	Insulated R (RSI)
0.8-1.8	4.0(0.70)	14.0(2.47)
2.5-3.5	7.3(1.29)	17.3(3.05)
4.1-5.1	10.5(1.85)	20.5(3.61)

An approximation suggested by Bolieu and Latta (7) for the calculation of average loss from a basement floor assumes an average path length calculated using R_2 in Fig. A4.2 as $W/4$ or one quarter of the smaller basement dimension. (for rectangular basement shapes)

For the Test Modules a value of 6.83 feet was used for d_1 and the basement floor thickness used was 4 inches.

$$L = \frac{\pi r_1}{2} + \frac{\pi r_2}{2}$$

But $r_1 = d_1 + r_2$.

Therefore $L = \frac{\pi(d_1 + 2r_2)}{2}$

$$\begin{aligned} r_2 &= 5.5 \text{ feet} \\ d_1 &= 6.83 \text{ feet} \end{aligned}$$

The average path length:

$$\begin{aligned} L &= \frac{\pi(d_1 + 2r_2)}{2} + 0.93 \text{ feet} \\ &= \frac{\pi(6.83 + 11.0)}{2} + 0.93 \\ &= 28.9 \text{ feet} \end{aligned}$$

The average heat loss is given by:

$$\begin{aligned} q &= \frac{k \Delta T}{L} \\ &= 0.03 \Delta T \text{ Btu/hr.sq.ft} \end{aligned}$$

The path thermal resistance:

$$= 1 / 0.03 = 36.2 \text{ hr.sq.ft.F/Btu}$$

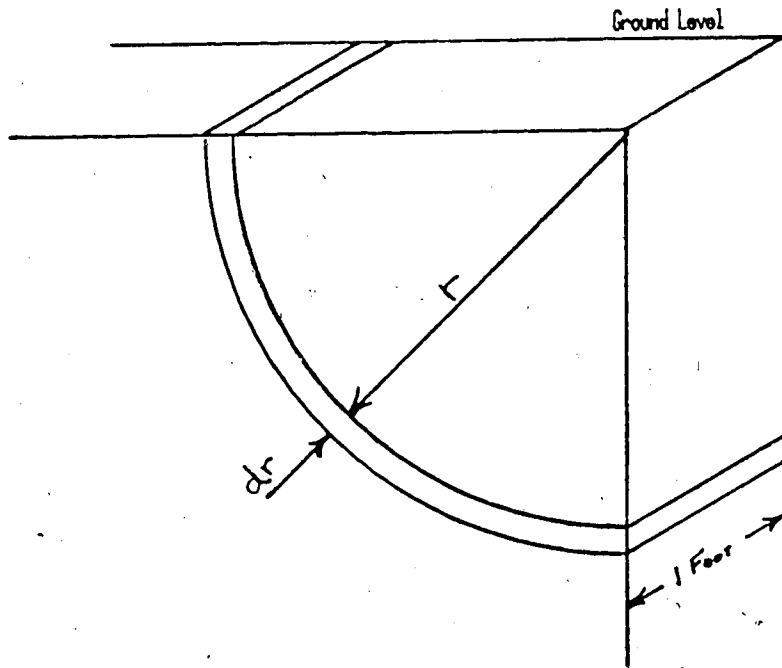

Figure A4.1 Calculation of Average Soil Path Length

