

INFORMATION TO USERS

This manuscript has been reproduced from the microfilm master. UMI films the text directly from the original or copy submitted. Thus, some thesis and dissertation copies are in typewriter face, while others may be from any type of computer printer.

The quality of this reproduction is dependent upon the quality of the copy submitted. Broken or indistinct print, colored or poor quality illustrations and photographs, print bleedthrough, substandard margins, and improper alignment can adversely affect reproduction.

In the unlikely event that the author did not send UMI a complete manuscript and there are missing pages, these will be noted. Also, if unauthorized copyright material had to be removed, a note will indicate the deletion.

Oversize materials (e.g., maps, drawings, charts) are reproduced by sectioning the original, beginning at the upper left-hand corner and continuing from left to right in equal sections with small overlaps. Each original is also photographed in one exposure and is included in reduced form at the back of the book.

Photographs included in the original manuscript have been reproduced xerographically in this copy. Higher quality 6" x 9" black and white photographic prints are available for any photographs or illustrations appearing in this copy for an additional charge. Contact UMI directly to order.

UMI

A Bell & Howell Information Company
300 North Zeeb Road, Ann Arbor MI 48106-1346 USA
313/761-4700 800/521-0600

University of Alberta

Genetic relations and phylogeography of woodland and barren-ground caribou

by

Gregory S. Dueck



**A thesis submitted to the Faculty of Graduate Studies and Research in partial
fulfillment of the requirements for the degree of Master of Science**

Department of Biological Sciences

Edmonton, Alberta

Fall 1998



National Library
of Canada

Acquisitions and
Bibliographic Services

395 Wellington Street
Ottawa ON K1A 0N4
Canada

Bibliothèque nationale
du Canada

Acquisitions et
services bibliographiques

395, rue Wellington
Ottawa ON K1A 0N4
Canada

Your file *Votre référence*

Our file *Notre référence*

The author has granted a non-exclusive licence allowing the National Library of Canada to reproduce, loan, distribute or sell copies of this thesis in microform, paper or electronic formats.

The author retains ownership of the copyright in this thesis. Neither the thesis nor substantial extracts from it may be printed or otherwise reproduced without the author's permission.

L'auteur a accordé une licence non exclusive permettant à la Bibliothèque nationale du Canada de reproduire, prêter, distribuer ou vendre des copies de cette thèse sous la forme de microfiche/film, de reproduction sur papier ou sur format électronique.

L'auteur conserve la propriété du droit d'auteur qui protège cette thèse. Ni la thèse ni des extraits substantiels de celle-ci ne doivent être imprimés ou autrement reproduits sans son autorisation.

0-612-34355-3

Canada

University of Alberta

Library Release Form

Name of Author: Gregory S. Dueck

Title of Thesis: Genetic relations and phylogeography of woodland and barrenground caribou

Degree: Master of Science

Year this Degree Granted: 1998

Permission is hereby granted to the University of Alberta to reproduce single copies of this thesis and to lend or sell such copies for private, scholarly, or scientific research purposes only.

The author reserves all other publication and other rights in association with the copyright in the thesis, and except as hereinbefore provided, neither the thesis nor any substantial portion thereof may be printed or otherwise reproduced in any material from whatever without the author's prior written permission.

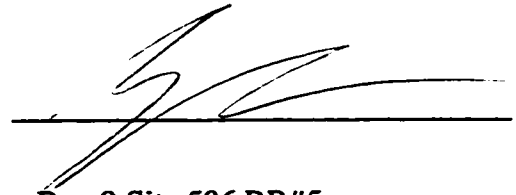

Box 9 Site 506 RR#5
Saskatoon, SK
S7K 3J8

Sep 25/98
Date

University of Alberta

Faculty of Graduate Studies and Research

The undersigned certify that they have read, and recommend to the Faculty of Graduate Studies and Research for acceptance, a thesis entitled "Genetic relations and phylogeography of woodland and barrenground caribou" submitted by Gregory S. Dueck in partial fulfillment of the requirements for the degree of Master of Science.

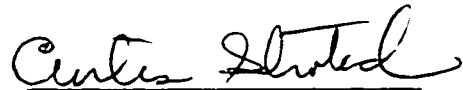
Dr. C. Strobeck

Dr. R.J. Hudson

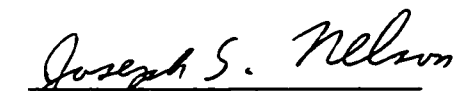
Dr. J.S. Nelson

Dr. A.R. Palmer

Sept 25, 1998
Date

Abstract

The genetic relationship between woodland (*Rangifer tarandus caribou*) and barren-ground caribou (*R.t. groenlandicus*) was investigated by sequencing part of the mitochondrial genome of 19 woodland caribou, 17 barren-ground caribou, and 2 Asian reindeer (*R.t. tarandus*). Two distinct mitochondrial DNA clades were found which only partially corresponded to existing taxonomic classifications. Barren-ground caribou were almost entirely comprised of the first (northern) mitochondrial clade. Reindeer, woodland caribou from Yukon, and some woodland caribou from British Columbia, northern Labrador, and Quebec's Ungava peninsula were also found to belong to the northern mitochondrial clade. The remaining woodland caribou comprised the second (southern) mitochondrial clade. Mitochondrial DNA sequencing results allowed for development of restriction digests which are diagnostic for the two mtDNA clades. 370 woodland and barren-ground caribou were analyzed with diagnostic restriction digests to reveal a phylogeographic pattern consistent with Wisconsinan glacial isolation and post-glacial dispersal of the two mitochondrial lineages. Differences in DNA sequence suggest the two mitochondrial lineages diverged approximately 49,000 years ago.

Table of Contents

1) Introduction	1
1.1) Nature of problem, and research objectives	1
1.2) Caribou taxonomy	2
1.3) Herds studied in this project	3
1.4) Pleistocene glaciations and their impact on the biogeography of caribou and other species	6
1.5) Caribou genetics	8
1.6) Methods of study and why they were chosen	9
2) Methods and materials	11
2.1) Samples	11
2.2) DNA extraction, mtDNA control region amplification and sequencing	11
2.3) MtDNA amplification and diagnostic restriction digests	12
2.4) Sequence analysis	13
3) Results	16
3.1) Sequence and features of the caribou mtDNA control region	16
3.2) Initial phylogenetic analysis using maximum parsimony	17
3.2.1) Trees reconstructed by including alignment gaps	18
3.2.2) Trees reconstructed by excluding alignment gaps	20
3.2.3) Trees reconstructed by considering alignment gaps as a fifth character state	21
3.2.4) The relationship between bootstrap and decay values	22
3.3) Diagnostic restriction digests	24
3.4) Phylogenetic analysis using MP of previously analyzed caribou in addition to caribou with unexpected and ambiguous restriction digest results	26
3.4.1) Trees reconstructed by excluding alignment gaps	27
3.4.2) Trees reconstructed by considering alignment gaps as a fifth character state	27
3.5) Phylogenetic analysis using NJ of previously analyzed caribou in addition to caribou with unexpected and ambiguous restriction digest results	28

4) Discussion	31
4.1) The genetic relationship of woodland and barrenground caribou based on sequence analysis	31
4.2) Geographic distribution of mtDNA clades, and the relationship of mtDNA clades to clades based on previous morphological data	33
4.3) An estimated time of divergence for the northern and southern mtDNA clades	35
4.4) The difference between gene trees and population trees, and the implications to the phylogeny of woodland and barrenground caribou	36
4.5) The relationship of caribou to the outgroups, elk and white-tailed deer	39
4.6) Caribou's relationship to reindeer	39
4.7) An explanation for the lack of phylogenetic resolution or population genetic substructuring within caribou subspecies	40
4.8) Caribou and comparative phylogeography of arctic animals	41
4.9) Taxonomic implications and practical applications	42
4.10) Summary of conclusions	43
5) Literature cited	45
6) Appendix	123

List of Tables

Table 1. Herd names and abbreviations used in this study 120
Table 2. Summary of diagnostic restriction digests 121
Table 3. Comparison of phylogeographic patterns of eight arctic mammals 122

List of Figures

Figure 1. Range of woodland and barrenground caribou, including locations of study herds	57
Figure 2a. Canada c. 18 kybp showing ice-free refugia inhabited by ancestral woodland and barrenground caribou	58
Figure 2b. Canada c. 11 kybp showing traditionally hypothesized post-glacial dispersal of woodland and barrenground caribou	59
Figure 2c. Canada c. 7 kybp showing traditionally hypothesized post-glacial dispersal of woodland and barrenground caribou	60
Figure 3. Aligned mtDNA sequences from 36 woodland and barrenground caribou, 2 European reindeer, elk, and white-tailed deer	61
Figure 4. Consensus of 84 equally most-parsimonious trees reconstructed from 1196 nt. alignment, including gaps, and weighting transitions:transversions 1:1	87
Figure 5. Consensus of 84 equally most-parsimonious trees reconstructed from 1197 nt. alignment, including gaps, and weighting transitions:transversions 1:1	88
Figure 6. Consensus of 28 equally most-parsimonious trees reconstructed from 1196 nt. alignment, including gaps, and weighting transitions:transversions 1:4	89
Figure 7. Consensus of 28 equally most-parsimonious trees reconstructed from 1197 nt. alignment, including gaps, and weighting transitions:transversions 1:4	90

Figure 8. Consensus of 28 equally most-parsimonious trees reconstructed from 1196 nt. alignment, including gaps, and weighting transitions:transversions 1:9	91
Figure 9. Consensus of 28 equally most-parsimonious trees reconstructed from 1197 nt. alignment, including gaps, and weighting transitions:transversions 1:9	92
Figure 10. Consensus of 84 equally most-parsimonious trees reconstructed from 1196 nt. alignment, excluding gaps, and weighting transitions:transversions 1:1	93
Figure 11. Consensus of 84 equally most-parsimonious trees reconstructed from 1197 nt. alignment, excluding gaps, and weighting transitions:transversions 1:1	94
Figure 12. Consensus of 28 equally most-parsimonious trees reconstructed from 1196 nt. alignment, excluding gaps, and weighting transitions:transversions 1:4	95
Figure 13. Consensus of 28 equally most-parsimonious trees reconstructed from 1197 nt. alignment, excluding gaps, and weighting transitions:transversions 1:4	96
Figure 14. Consensus of 28 equally most-parsimonious trees reconstructed from 1196 nt. alignment, excluding gaps, and weighting transitions:transversions 1:9	97
Figure 15. Consensus of 28 equally most-parsimonious trees reconstructed from 1197 nt. alignment, excluding gaps, and weighting transitions:transversions 1:9	98
Figure 16. Consensus of 224 equally most-parsimonious trees reconstructed from 1196 nt. alignment, treating gaps as a fifth character state, and weighting transitions:transversions 1:1	99

Figure 17. Consensus of 224 equally most-parsimonious trees reconstructed from 1197 nt. alignment, treating gaps as a fifth character state, and weighting transitions:transversions 1:1	100
Figure 18. Consensus of 14 equally most-parsimonious trees reconstructed from 1196 nt. alignment, treating gaps as a fifth character state, and weighting transitions:transversions 1:4	101
Figure 19. Consensus of 14 equally most-parsimonious trees reconstructed from 1197 nt. alignment, treating gaps as a fifth character state, and weighting transitions:transversions 1:4	102
Figure 20. Consensus of 14 equally most-parsimonious trees reconstructed from 1196 nt. alignment, treating gaps as a fifth character state, and weighting transitions:transversions 1:9	103
Figure 21. Consensus of 14 equally most-parsimonious trees reconstructed from 1197 nt. alignment, treating gaps as a fifth character state, and weighting transitions:transversions 1:9	104
Figure 22. Scatterplot of bootstrap values versus decay values showing a line joining mean bootstrap values for each decay value	105
Figure 23. Strict consensus of 28 equally most parsimonious trees reconstructed from 1197 nt. alignment, excluding gaps, and weighting transitions:transversions 1:9	106
Figure 24. Diagnostic restriction fragments cut by <i>Alu</i> 1	107
Figure 25. Diagnostic restriction fragments cut by <i>Rsa</i> 1	108

Figure 26. Regional distribution of mtDNA clades in woodland and barrenground caribou	109
Figure 27. Strict consensus of 438 equally most parsimonious trees reconstructed from 1197 nt. alignment, excluding gaps, and weighting transitions:transversions 1:9	110
Figure 28. Majority-rule consensus of 438 equally most parsimonious trees reconstructed from 1197 nt. alignment, excluding gaps, and weighting transitions:transversions 1:9	111
Figure 29. Strict consensus of 4666 equally most parsimonious trees reconstructed from 1197 nt. alignment, treating gaps as a fifth character state, and weighting transitions:transversions 1:9	112
Figure 30. Majority-rule consensus of 4666 equally most parsimonious trees reconstructed from 1197 nt. alignment, treating gaps as a fifth character state, and weighting transitions:transversions 1:9	113
Figure 31. Neighbor joining tree reconstructed from 1197 nt. alignment, and weighting transitions:transversions 1:1	114
Figure 32. Neighbor joining tree reconstructed from 1197 nt. alignment, and weighting transitions:transversions 1:9	115
Figure 33a. Canada c. 18 kybp showing ice-free refugia inhabited by ancestral woodland and barrenground caribou	116
Figure 33b. Canada c. 11 kybp showing hypothesized post-glacial dispersal of woodland and barrenground caribou based on results presented in this thesis	117

Figure 33c. Canada c. 7 kybp showing hypothesized post-glacial dispersal of woodland and barrenground caribou based on results presented in this thesis	118
Figure 34. Frequency distribution within and between mtDNA clades, based on 630 pairwise mtDNA control region sequence divergences among 36 caribou	119

1) INTRODUCTION

1.1) Nature of problem, and research objectives.

The purpose of this study is to examine the molecular phylogeography of two North American caribou (*Rangifer tarandus*; Linnaeus 1746) subspecies, and to contribute to traditional caribou taxonomy using molecular methods. Intraspecific phylogeography lies at the convergence between systematics and population genetics. In essence, phylogeography is the comparison of phylogenetic relationships and geographic distributions (Avice *et al.* 1987). Intraspecific phylogeography can be studied by analyzing the lineage of a gene or some other genetic marker (Avice 1989), and potentially, the gene lineage and its divergences can then be understood in the context of known historical and geological events.

A better understanding of a species' phylogeography may also contribute to a more formalized taxonomy for that species. This is often critical to management and conservation efforts since taxonomy is the basis for recognition and thus for management of a species (O'Brien 1994).

Although the taxonomy of *Rangifer* has been relatively stable since Banfield's revision (1961), several problems at the intraspecific level between North America's woodland (*R.t. caribou*; Gmelin 1788) and barrenground caribou (*R.t. groenlandicus*; Gmelin 1788) have received little or no attention, especially at the genetic level. In addition, management of caribou herds in Canada is becoming increasingly important as several barrenground herds expand, and almost all woodland herds decline (Mallory & Hillis 1998, COSEWIC 1998). In view of this, problems posed in this study include: 1) what are the major mtDNA lineages within the woodland and barrenground caribou? 2) how are the mtDNA lineages distributed geographically? 3) can substructuring within the geographic range of mtDNA lineages be identified? 4) can gene flow (past or present) between mtDNA lineages be identified? 5) do the major mtDNA lineages correspond to known historical and geological events? 6) can times of mtDNA lineage divergence be estimated? and 7) how does the phylogeography of mtDNA lineages correspond to the biogeography of the currently recognized woodland and barrenground caribou subspecies? This paper reports the results and the phylogenetic implications of sequencing and restriction digesting part of the mitochondrial genome of individuals from 21 herds of woodland and barrenground caribou across Canada.

1.2) Caribou taxonomy.

Although the ancestry and origins of *Rangifer* are not clear, the genus is thought to have originated in Beringia or the mountainous regions of north-east Asia (Banfield 1961, Kurten & Anderson 1980). The earliest record of *Rangifer* in North America is from the deposits of the Cape Deceit fauna in Alaska. These date from the mid-Irvingtonian age of North American land mammals, *ca.* 1 mybp or slightly older (Kurten & Anderson 1980).

The world's modern assemblage of *Rangifer* consists of a single holarctic species, *R. tarandus*, with several subspecies. The most significant historical factor in the subspeciation of *R. tarandus* is considered to be the world's last glacial cycle -- called the Wisconsinan in North America, and the Weichselian in Eurasia -- during which time alpine and continental ice sheets grew and shrank more than once between 100 kybp and 10 kybp (Goldthwait 1992). Caribou populations likely reached their current subspecific levels in the isolation of non-glaciated refugia (see pg.41 Banfield 1961).

The taxonomy presented here is based on Banfield's revision (1961) which remains widely accepted today. Because the term "caribou" is used in place of "reindeer" in North America, "reindeer" will only be used only to describe Eurasian *R. tarandus*. *R. tarandus* is divided into two major ecological groups; the tundra or Cylindricornis group (Jacobi), and the forest or Compressicornis group (Jacobi). Based on morphology, the Cylindricornis are further divided into six subspecies. *R.t. tarandus* (Linnaeus), the Eurasian tundra reindeer, has historically ranged throughout the tree-line and tundra regions of northern Europe and Asia. Although Asia has many more reindeer than Europe, Asian herds are declining more rapidly (Williams & Heard 1986). *R.t. groenlandicus* (Linnaeus), the North American tundra or barrenground caribou, has historically ranged throughout the tree-line and continental tundra regions of Canada from the Mackenzie River delta to the Hudson Bay. Barrenground caribou are also found on the southern Victoria Islands, Baffin Island, on parts of the West coast of Greenland, and on several islands in northern Hudson Bay. With a few exceptions, populations and ranges of barrenground caribou herds are stable or increasing (Mallory & Hillis 1998). *R.t. granti* (Allen), Grant's caribou, has historically ranged over much of Alaska, and into north and west Yukon Territory. Through most of its range, herds of Grant's caribou are increasing in population (Mallory & Hillis 1998). *R.t. pearyi* (Allen), Peary caribou, has historically ranged throughout Canada's Arctic islands with the exception of Baffin Island. Since 1991 it has been considered endangered or

threatened throughout its range (COSEWIC 1998). *R.t. eogroenlandicus* (Degerbol), the East Greenland Reindeer, has historically ranged along the East Greenland coast, although the subspecies has been extinct since about 1900 (Banfield 1961). *R.t. platyrhynchus* (Vrolik), the Svalbard or Spitsbergen reindeer, ranges throughout the Spitsbergen Archipelago (north of Norway) in small but stable numbers (Mallory & Hillis 1998).

The Compressicornis, or forest caribou, is divided into three morphological subspecies. *R.t. caribou* (Gmelin), the North American woodland caribou, has historically ranged throughout the boreal forest region in North America and the tundra of northern Labrador and Quebec, as well as in parts of the Rocky Mountains in Alberta, British Columbia, Montana, and Idaho. High levels of human disturbance and few opportunities for forage diversification (among other constraints) have resulted in the general decline of woodland caribou populations (Mallory & Hillis 1998). The Gaspé population of Quebec was designated as threatened in 1984, and in the same year the western population including all herds in Ontario, Manitoba, Saskatchewan, Alberta, British Columbia, and the Northwest Territories were designated as vulnerable (COSEWIC 1998). *R.t. dawsoni* (Seton), the Queen Charlotte Island caribou, are known only to have lived on British Columbia's Queen Charlotte Islands, and were probably extinct by the 1920's (COSEWIC 1998). *R.t.fennicus* (Lonnberg), the Eurasian forest reindeer, has ranged historically throughout much of Eurasia's boreal forest, from Scandinavia to eastern Siberia. Like their North American woodland counterparts, with a few exceptions, the size of *R.t.fennicus* herds are often small, and either stable or decreasing (Mallory & Hillis 1998).

1.3) Herds studied in this project.

The ranges of woodland and barrenground caribou, along with herds sampled in this study are shown on a map in Figure 1, and described below. Herd abbreviations and province or territory are included in parentheses. Barrenground herds studied include the following; Bluenose (BLN, Northwest Territories) which has a population of 80,000 and is considered stable in growth (Mallory & Hillis 1998), Bathurst (BAT, Northwest Territories) which has a population of 450,000 and is increasing (Mallory & Hillis 1998), Beverly (BEV, Northwest Territories and Saskatchewan) which has a population of 420,000 and is increasing (Mallory & Hillis 1998), Southampton Island (SIL, Northwest Territories) which has a population of 13,700 and is increasing (Heard & Ouellet 1994), South Baffin

(BFN, Northwest Territories) which has a population of >60,000 and whose growth trend is unknown (Williams & Heard 1986), and Kaminuriak which has a population of 450,000 and is increasing (Mallory & Hillis 1998). The Kaminuriak herd (Northwest Territories and Manitoba) is considered to be a single herd, however, because of the availability of samples from both the northern and southern limits of the herd -- one at Eskimo Point, Northwest Territories, and the other at Churchill, Manitoba where their range overlaps with Manitoba's woodland caribou -- I will treat the two sample areas as two populations, Kaminuriak Churchill (KMB) and Kaminuriak Northwest Territories (KAM). The ability to distinguish between those hybridizing with woodland caribou and those not hybridizing may be lost if all Kaminuriak caribou are clumped into one sample population. It should be noted that the Southampton Island caribou were hunted to extinction by 1953 (Parker 1975), and the current population was re-established in 1967 when 48 barrenground caribou from neighbouring Coats Island were captured and released on Southampton Island (see Heard & Ouellet 1994).

Woodland herds studied include the following; Aishihik (ASK, Yukon) which has a population of 750 and has recently increased after a recovery program for the herd began in 1993 (Farnell *et al.* 1998), Chisana (CHS, Yukon and Alaska) which has a population of 700 and is in rapid decline due to poor forage and heavy predation (Farnell *et al.* 1998), Hart River (HRV, Yukon) which has a population of 1,200 and whose growth trend is unknown (Farnell *et al.* 1998), Wolf Lake (WLF, Yukon) which has a population of 1,200 and is stable (Farnell *et al.* 1998), Cariboo Mountains (CAR, British Columbia) also called Quesnel Lake which has a population of 125 and is increasing (Heard & Vagt 1998), or is alternatively grouped together with other herds of east-central British Columbia with a decreasing population of 1,500 (Mallory & Hillis 1998), South Purcell (PRL, British Columbia) which has a population of 100 and is declining (Heard & Vagt 1998), Central Selkirk (SLK, British Columbia) which has a population of 220 and is declining (Heard & Vagt 1998), Jasper National Park (JNP, Alberta) which has a population of 200 and is declining (Edmonds 1988, Hervieux *et al.* 1996), Saskatchewan (SKN, Saskatchewan) which has a population of 2,500 and is declining (Rettie *et al.* 1998), North Lake Superior/Pukaskwa National Park (PUK, Ontario) which has a population of <70 and is declining (Cumming 1998), North East Ontario (NEO, Ontario and Quebec) which has a population of 4,500 and is declining (Mallory & Hillis 1998), George River (GRV, Quebec and Labrador) which has a population of 700,000 and is increasing (Mallory & Hillis 1998),

Mealy (MLY, Labrador) which has a population of 700 and is increasing (Mallory & Hillis 1998), Humber (HUM, insular Newfoundland) which has a population of 450 and is increasing, and Middle Ridge (MDR, insular Newfoundland) which has a population of 8,000 and is increasing. Although all the herds considered here to be woodland are generally thought of as *R.t. caribou*, including the Yukon woodland herds (Banfield 1961, Farnell *et al.* 1998), the Yukon study herds of Hart River, Chisana, and Aishihik have alternatively been classified as *R.t. granti* (Mallory & Hillis 1998). For the remainder of this thesis, refer to Table 1 for a list of herd names and abbreviations.

As stated previously, and as can be seen from the status of herds sampled for this research, woodland caribou in Ontario and western Canada are considered vulnerable (COSEWIC 1998) with many herds facing local extinction (Mallory & Hillis 1998). The several threats to woodland herds include forestry, mining, oil and gas development, and predation. One of the few regions into which caribou have been translocated as part of a recovery plan is the southern Selkirk Mountains of northern Idaho, however, the translocated caribou from southern and northern British Columbia had combined survival rates too low to re-establish a herd (Compton *et al.* 1995). Caribou translocated to Idaho from similar southern British Columbia ecotypes had survival and dispersal rates nearly twice that of translocated caribou from northern British Columbia ecotypes (Warren, *et al.* 1996). Indeed, the mountain caribou of Alberta, British Columbia, and Yukon are typically grouped into two ecotypes (Stevenson 1991). The first is called the mountain/arboreal type. It is found in southeastern British Columbia, and Northern Idaho. Because of deep snowfall in this region, caribou of the mountain/arboreal ecotype feed almost exclusively on arboreal lichens during winter. The second ecotype of woodland mountain caribou is the mountain/terrestrial type. It is found in northern British Columbia and Yukon. Because of less winter snowfall than in southern British Columbia, caribou of the mountain/terrestrial ecotype feed on terrestrial lichens year-round. The mountain caribou of Alberta's Banff and Jasper National Parks migrate annually between summer calving and rutting grounds in the Rocky Mountains, and winter grounds in the foothills east of the front range of the Rocky Mountains (Edmonds 1988). Although their winter range overlaps with the non-migratory woodland caribou of the foothills region near Grand Cache, their rutting sites do not (Edmonds 1988).

1.4) Pleistocene glaciations and their impact on the biogeography of caribou and other species.

Cycles of glacial advance and retreat during the Pleistocene are believed to have had a great impact on distributions and consequently on speciations or subspeciations of many taxa. Among vicariance events, only the biological implications of continental drift have inspired more discussion than those of the climatic and glacial cycles of the Pleistocene and the greater Quaternary (Bermingham *et al.* 1992).

The last interglacial period in North America, the Sangamonian, extended from 132 kybp to 80 kybp, although peak interglaciation occurred at about 125 kybp (Peteet *et al.* 1992). This was followed by the general cooling of the Wisconsinan glacial phase which ended 10 kybp. However, as early as 100 kybp the Laurentide ice sheet had developed in Quebec east of Hudson Bay (Clark 1992). The Laurentide ice sheet may have reached its northwestern maximum, or near maximum, in the region which is now the Mackenzie River delta very early during the Wisconsinan -- at about 80 kybp -- remaining at approximately the same position for the remainder of the Wisconsinan (Vincent 1992). The northern opening to the ice-free corridor between the Laurentide and Cordilleran ice sheets may have been blocked by glaciation and glacial flooding from before 36.9 kybp to as late as 12.4 kybp (Catto 1996). The southern margin of the Laurentide ice sheet advanced much more slowly, not reaching its maximum until 18 kybp (Vincent 1992). Meanwhile, the Cordilleran ice sheet may have reached its southern maximum as early as 65 kybp (Vincent 1992). At the same time the Cordilleran ice sheet in the Yukon region had not yet reached its maximum, although it may have been only slightly less extensive than during its maximum at about 18 kybp (Duk-Rodkin & Hughes 1991, Vincent 1992). Thus the growths of the Laurentide and Cordilleran ice sheets were cyclic and out of phase, resulting in an ice-free corridor between them for much of the late Wisconsinan. Although some evidence exists for a second, earlier closure of the ice-free corridor during the early Wisconsinan between about 100 kybp and 50 kybp (Rutter 1980), dating for such an event is both scarce and inaccurate (N.W. Rutter, pers. comm.).

By the time the Laurentide and Cordilleran ice sheets coalesced, at about 18 kybp in southern Alberta (Jackson *et al.* 1997), the ice free refugia in Yukon/Alaska (known as Beringia) and south of the ice sheets may have been ecologically isolated from one another for some time. Although a variety of large herbivore fossils dating from 43 kybp to 21 kybp have been found in the vicinity of the ice-free

corridor (Burns 1996), during some periods of the Wisconsinan, the region was cold and dry enough to prevent even arctic ground cover from forming in places (Mandryk 1990).

During the time of glacial maximum, *R. tarandus* were found both in Beringia and south of the ice sheets (see Figure 2a this paper; Kurten & Anderson 1980). After 18 kybp, the ice sheets began to recede and the ancestors of modern barren-ground caribou began to disperse out of Beringia, while the ancestors of modern woodland caribou began to disperse northward from their southern periglacial refugium (see Figure 2b). Because of the presence of what are considered to be *R.t. caribou* (woodland caribou) as far north as Yukon and the Mackenzie River delta, it is believed that caribou from south of the ice sheets were the first to recolonize the ice-free corridor opening between the Laurentide and the Cordilleran ice sheets, and that they dispersed northward where they met the barren-ground caribou that had crossed the Mackenzie River region on their way to the tundra of mainland Northwest Territories (see Figure 2c this paper; Banfield 1961, MacPherson 1965). Several other arctic mammals are believed to have dispersed from Beringia and from southern refugia in a similar pattern to that of caribou (MacPherson 1965).

While many studies have used molecular methods to study phylogeography in relation to Pleistocene and Quaternary climatic and glacial cycles, most have focused on species isolated in habitat refugia (i.e., forest fragments) due to climate changes (for example see Riddle & Honeycutt 1990 on grasshopper mice, Avise 1992 on several species in the southeastern U.S.A., and Wooding & Ward 1997 on black bears) rather than those isolated by the physical barrier of the ice sheets themselves. Even fewer have studied phylogeography on a continent-wide scale, and most that have are studies of birds (for example see Gill *et al.* 1993 on chickadees, and Zink 1996 on several bird species).

However, two studies on black bears have tested hypotheses about ice-free refugia and post-glacial colonization in Newfoundland bears (Paetkau and Strobeck 1996) and in bears of coastal British Columbia (Byun *et al.* 1997). On a broader geographic scale, studies of dunlins (Wenink *et al.* 1996) and whitefish (Bernatchez & Dodson 1994) have also found phylogeographic groups to be related to presumed isolation events during glacial periods of the Pleistocene. Of the extant mammals that are thought to have been isolated both in Beringia and south of the ice sheets during the Wisconsinan glaciation, only the masked shrew (*Sorex cinereus*) has been studied phylogeographically using molecular methods. Stewart & Baker

(1997) found mtDNA clades in the masked shrew to fit a hypothesis in which populations were isolated by glaciation after which they recolonized much of Canada. However, they found a lack of concordance between mtDNA clades and currently recognized subspecies.

Thus, very few molecular studies have focused on mammalian species hypothesized to have been isolated in more than one ice-free refugia after which they dispersed from both (or several) refugia to establish populations across the formerly glaciated region.

1.5) Caribou genetics.

Genetic studies have alternatively placed *R. tarandus* in the cervid subfamily Odocoileinae based on mitochondrial DNA sequence (Polziehn & Strobeck in press) and in its own subfamily, Rangiferlane, based on karyotype (Neitzel 1987). Using restriction digests of mitochondrial DNA, one study (Cronin 1991) found support for *R. tarandus*'s placement in Odocoileinae, Cervinae, and in a separate monophyletic group. Despite the disagreement, *R. tarandus* is usually considered to be a member of Odocoileinae (Groves & Grubb 1982).

Intraspecific studies of caribou genetics have usually focused on determining genetic variation within one or more subspecies. Using four microsatellite loci, high levels of variation have been found in barrenground, Peary, and woodland caribou (Kushny *et al.* 1996), and recently several more microsatellite loci have been characterized in caribou (Wilson *et al.* 1997). Microsatellite analysis has also shown herds of Yukon woodland caribou to be genetically distinguishable from one another (Zittlau *et al.* in press). Most other studies have used allele variations of the blood plasma protein, transferrin, to infer genetic diversity. Based on transferrin variation, European reindeer (Roed 1985a), and barrenground (Roed & Thomas 1990), Peary (Roed *et al.* 1986), Grant's (Roed & Whitten 1986), and woodland caribou (Roed *et al.* 1991) all have relatively high genetic variation, while Spitsbergen reindeer are much less genetically diverse (Roed 1985b). Another study of transferrin variation found most genetic variation within woodland caribou to be contained between herds, while variation within herds was low and variation among regions of herds was also low (van Staaden *et al.* 1995). However, a discrepancy between variation in transferrin and variation in other loci suggests significant selection on the transferrin gene (van Staaden *et al.* 1995). Indeed, direct evidence for selection of the maintenance of variation in transferrin has been found (Roed 1987). Since

woodland caribou typically range over relatively small areas, differences in selection are probably greater between specific habitats and ranges than between greater regions, especially because most regions considered lie within Canada's relatively homogeneous band of boreal forest. This may explain, in part, why transferrin variation in woodland caribou was found between herds but not within herds or between regions.

Also using transferrin variation, Roed & Thomas (1990) found barrenground caribou to be no more closely related to Grant's caribou than to Peary caribou, despite the belief that barrenground and Grant's caribou shared a common ancestor in Beringia during the Wisconsinan glaciation (Banfield 1961). Roed & Thomas' explanation was that after the ancestral woodland caribou dispersed northward through the ice-free corridor between the Cordilleran and Laurentide ice sheets, they met the ancestral Grant's caribou and Peary caribou in the northern Mackenzie River delta and introgressed to give rise to the barrenground caribou which then dispersed eastward across the tundra of mainland Northwest Territories. Results of transferrin variation have also found the barrenground herds of Beverly and Baffin Island to be less closely related than Beverly is to the woodland herds of George River and Leaf River in Quebec/Labrador, calling into question whether the barrenground caribou of mainland Northwest Territories are indeed *R.t. groenlandicus* (Roed *et al.* 1991). On a phylogeographic level, mitochondrial DNA restriction digests have failed to distinguish between woodland caribou in Newfoundland and Alberta, and Grant's caribou in Alaska (Cronin 1992).

1.6) Methods of study and why they were chosen.

Mitochondrial (mt) DNA has been used extensively in studies of microevolutionary gene-lineage analysis for two reasons. First, it evolves rapidly enough that new character states arise within the lifetime of a species (Awise *et al.* 1987), and most evolution happens through simple base substitutions (Brown *et al.* 1979). Second, it is inherited maternally, as a single unit, with no recombination, and thus its transmission is effectively haploid. This allows for the treatment of individuals as operational taxonomic units in a matriarchal tree (Awise *et al.* 1979, Awise 1989). For these reasons mtDNA was selected for use in this study.

Although the entire mt genome evolves rapidly, base changes occur most rapidly in the control region or D-loop region (Brown 1985). Because of the microevolutionary scale on which this study is focused, direct sequencing of the rapidly evolving mtDNA control region was selected as the source of data for

phylogeographic inferences. After using direct sequencing to find restriction sites which are diagnostic for mtDNA clades, the relatively low cost and high efficiency of restriction digests (or Restriction Fragment Length Polymorphisms, RFLP) was used in place of sequencing for a large scale geographic survey of caribou from many different herds. The technique of using only a few restriction enzymes that are diagnostic of mtDNA haplotypes is fairly common (Cronin *et al.* 1991).

While the interpretation of only a few diagnostic restriction sites is fairly simple, the interpretation of direct sequence for the mtDNA control region of many individuals is complex. For this reason, I chose two different methods to reconstruct evolutionary trees from sequence data. Although concordance of trees reconstructed using different methods should not be interpreted as support for a data set's phylogenetic accuracy (Felsenstein 1995), such concordance can be interpreted as support for what is the best tree (or trees) given the data set. The first method used for tree reconstruction is maximum parsimony, which searches for trees that require the fewest evolutionary steps to explain a given data set (*i.e.*, selects the shortest trees). The second method is neighbor joining (Saitou & Nei 1987), which constructs a tree using pairwise genetic distances calculated from differences in nucleotide sequence between individuals. In addition to reconstructing trees with different methods, several different sequence alignments and several different schemes of weighting transitions to transversions were tested to assess their influence on tree reconstruction, and in turn, their influence on phylogenetic inferences made from trees.

2) METHODS AND MATERIALS

2.1) Samples.

A total of 370 caribou were sampled from the following herds organized by province or territory -- name abbreviation and sample size follows herd name: British Columbia; Cariboo Mountains (CAR, 12), South Purcell (PRL, 31), Central Selkirk (SLK, 21). Alberta; Jasper National Park (JNP, 16). Saskatchewan; Saskatchewan (SKN, 10). Manitoba; Kaminuriak Churchill (KMB, 15). Ontario; North Lake Superior/Pukaskwa National Park (PUK, 4). Ontario and Quebec; North East Ontario (NEO, 8). Quebec and Labrador; George River (GRV, 19). Labrador; Mealy (MLY, 13). Newfoundland; Humber (HUM, 10), Middle Ridge (MDR, 10). Yukon Territory; Aishihik (ASK, 20), Chisana (CHS, 22), Hart River (HRV, 7), Wolf Lake (WLF, 23). Northwest Territories; Bathurst (BAT, 27), South Baffin (BFN, 7), Beverly (BEV, 24), Bluenose (BLN, 26), Kaminuriak North West Territories (KAM, 22), Southampton Island (SIL, 23). In addition, two Asian reindeer were sampled; one from an introduced Alaskan herd (herein named RND1), and one from a domestic herd near Dawson Creek, British Columbia (named RND2) which was founded by caribou from the forementioned Alaskan herd. White-tailed deer (*Odocoileus virginianus*) and Elk (*Cervus elaphus*) sequences obtained from Renee Polziehn were used as outgroups to caribou.

2.2) DNA extraction, mtDNA control region amplification and sequencing.

Many of the caribou DNA samples used in this study were obtained from the wildlife DNA repository maintained by Parks Canada at the University of Alberta's Department of Biological Sciences. Whole blood samples requiring DNA extraction were treated as follows. Red blood cells were lysed and removed by three washings with 1 X ACK (0.155 M NH₄, 10mM KHCO₃, 1mM EDTA, pH 7.4). Total DNA was isolated from the remaining white blood cells using the QIAamp Blood & Body Fluid Protocol (QIAamp Blood Kit and QIAamp Tissue Kit Handbook, January 1996, QIAGEN Inc., Mississauga, Ont.).

The control region and parts of the flanking genes for tRNA^{Thr}, tRNA^{Pro}, and tRNA^{Phe} of mtDNA were enzymatically amplified using the polymerase chain reaction or PCR (Mullis & Faloona 1987) on a total of 38 caribou. The two external primers used for amplification of the control region were CST 2 (5'-TAATATACTGGTCTTGTAAC-3') which binds to the mtDNA light strand in

the tRNA^{Thr} gene, and CST 39 (5'-GGGTCGGAAGGCTGGGACCAAACC-3') which binds to the mtDNA heavy strand in the tRNA^{Phe} gene. CST 2 and CST 39 were reported in Polziehn *et al.* (1996), and are based on conserved primer sequences described by Kocher *et al.* (1989) biased for domestic cow (Anderson *et al.* 1982).

Amplification reactions were performed with 1 unit of *Taq* polymerase, 1 X *Taq* magnesium-free polymerase buffer, 2.0 μ M MgCl₂, 20pM each of primers CST 2 and CST 39, 0.06 mM each of dATP, dTTP, dCTP, and dGTP, and 10-1000 ng total genomic DNA (*i.e.*, nuclear and mitochondrial). The reactions were brought up to 100 μ L volumes with deionized water. A Perkin Elmer 9600 GeneAmp PCR System was used for the following thermocycles: 94°C for 3 minutes; 94°C for 15 seconds, 56°C for 30 seconds, 72°C for 30 seconds (30 cycles); 72° for 30 seconds.

PCR products were purified using 1% agarose gels, and then extracted with the QIAquick Gel Extraction Kit Protocol (QIAquick Spin Handbook, July 1997, QIAGEN Inc., Mississauga, Ont.). Sequences were obtained by double-stranded DNA cycle sequencing (Murray 1989) as described in the ABI Prism™ Dye Terminator Cycle Sequencing Kit or the ABI Prism™ dRhodamine Terminator Cycle Sequencing Kit (PE Applied Biosystems, Foster City, Calif.) depending on the type of dye-labelled terminator used. The external primers CST 2 and CST 39 were used along with four internal primers designed for caribou by John Coffin (unpublished), two of which bind to the control region light strand -- CST 343 (5'-ATTATATGCCCATGCTTAT-3') and CST 344 (5'-ATCGCCCACTCATTCCTCTT-3') --, and two of which bind to the heavy strand -- CST 340 (5'-TTATGTCCTGCTACCATT-3') and CST 345 (5'-CCAAGCGGGTTGCTGGTTTC-3'). Cycle sequencing extension products were purified by spin column purification, and resuspended as described in the ABI Prism™ Dye Terminator Cycle Sequencing Kit or the ABI Prism™ dRhodamine Terminator Cycle Sequencing Kit (PE Applied Biosystems, Foster City, Calif.). Samples (1 μ L each) were electrophoresed on 4% polyacrylamide gels in an ABI Prism 377 DNA Sequencer.

2.3) mtDNA amplification and diagnostic restriction digests.

Based on initial phylogenetic analysis of control region sequences for 25 caribou, several sites were found to be diagnostic for determining "northern" versus "southern" mitochondrial haplotype. These results will be presented in detail in the

"Results" section of this paper. The restriction enzymes *Alu* 1 and *Rsa* 1 were found to cut at two of the diagnostic sites, and thus were used for diagnostic restriction digests. Restriction fragment length polymorphism (RFLP) analysis was performed on 370 caribou. Both diagnostic digests were performed on each caribou sample, using the following method. The primer pair CST 2 and CST 345 (previously discussed) were used to amplify a 512 nucleotide long fragment of the mtDNA control region, and the tRNA^{Pro} and tRNA^{Thr} genes using PCR, the chemistry of which was identical to that described for mtDNA control region amplification in the previous section of "Methods and Materials", except that primers CST 2 and CST 345 were used instead of CST 2 and CST 39. The following thermocycles were used: 94°C for 3 minutes; 94°C for 15 seconds, 54°C for 20 seconds, 72°C for 5 seconds (30 cycles); 72° for 30 seconds.

Similarly, the primer pair CST 1079 (5'-ATTACAGTTCTGCACTCAATAG-3') and CST 1080 (5'-ATGGTAGTTAAGCTCGTGA-3') was developed to amplify a 294 nucleotide long fragment of the mtDNA control region. It should be noted that unlike primers CST 2 and CST 39, primers CST 1079 and CST 1080 were not based on broadly conserved sequences, but were instead designed specifically for caribou. Again, the PCR chemistry was identical to that previously described except that primers CST 1079 and 1080 were used. The following thermocycles were used: 94°C for 3 minutes; 94°C for 15 seconds, 47°C for 20 seconds, 72°C for 5 seconds (30 cycles); 72° for 30 seconds.

Restriction digests used 100 - 1000 ng of amplified mtDNA, 10 units of enzyme, and 1X One-Phor-All Buffer *PLUS* (Pharmacia-Biotech, Uppsala, Sweden). The reactions were brought up to 20 μ L volumes with deionized water. The enzyme *Alu* 1 was used to digest the DNA amplified with primers CST 2 and CST 345, and the enzyme *Rsa* 1 was used to digest the DNA amplified with primers CST 1079 and CST 1080. Restriction digests were performed at a reaction temperature of 37°C until completion (at least one hour). The digested products were separated by electrophoresis on a BioRad vertical gel apparatus (BioRad, Richmond, Calif.) in 12% polyacrylamide 1 X TBE gels (Ausubel *et al.* 1994). They were then stained and photographed. RFLP band patterns diagnostic of "northern" and "southern" mt haplotypes will be discussed in "Results".

2.4) Sequence analysis.

Sequences were aligned by eye using Sequence Navigator software (PE Applied Biosystems, Foster City, Calif.). Gaps were introduced where necessary for aligning sequences. For phylogenetic analysis, gaps were alternatively included, excluded, and treated as fifth character states at each site where they occurred. Phylogenetic reconstructions were conducted by the maximum-parsimony (MP) method using PAUP 3.1 (Swofford 1993), and by the neighbor-joining (NJ) method (Saitou & Nei 1987) in NEIGHBOR which is found in the application package, PHYLIP version 3.572c (Felsenstein 1995).

Tree searches in PAUP were Heuristic using 10 replicates of random taxon addition and the tree-bisection-reconnection branch-swapping option. Multiple tree islands were found using tree-to-tree distances. Characters were weighted before searching for trees, and rooted after searching. In rooting, the ingroup (caribou) was made monophyletic relative to the outgroups (elk and white-tailed deer). Strict and 50% majority-rule consensus trees were constructed from all most-parsimonious trees. The distance matrix used for the NJ method was based on Kimura's (1980) model of nucleotide substitution (DNADIST, in PHYLIP version 3.572c; Felsenstein 1995).

Robustness of phylogenies reconstructed using NJ were assessed by the bootstrap method (SEQBOOT, in PHYLIP version 3.572c; Felsenstein 1995), with 100 resamplings. Robustness of phylogenies reconstructed using MP were also assessed by the bootstrap method (bootstrap option in PAUP 3.1) with 100 resamplings, and by decay analyses (Bremer 1988) which are used to determine the number of additional steps required to break up a clade appearing on the most parsimonious tree(s). I followed the method of decay analysis described by Johnson and Soltis (1994) as follows. After searching for MP trees, a strict consensus tree based on all MP trees was used as a constraint tree. PAUP was then instructed to save all trees one step longer than the MP trees that were *not* compatible with the constraint tree topology. This was done for 10 replicates of random taxon addition. Trees that *do* satisfy the constraint topology are typically more highly resolved forms of the constraint tree because they must be either identical to the constraint tree or they must be transformable into the constraint tree by collapsing one or more branches (Swofford 1993). Trees that *do not* satisfy the constraint topology are typically less resolved forms, thus searching for longer than MP trees that *do not* satisfy the constraint topology gives an estimation of the robustness of different branches and groupings on the MP trees. This method was repeated until all trees from one to 16 extra steps (depending on what was necessary

to break up all phylogenetic resolution within caribou) were examined in succession. After searching for longer than MP trees, the trees were filtered so that only those of the appropriate length were used to determine the respective decay values. For example, when MP trees had a length of 254, branches with a decay value of 3 were found by using trees of length 257. This was done by searching for trees of length ≤ 257 which did not satisfy the constraint tree topology. To exclude trees of length < 257 , trees were filtered to only retain trees of length ≥ 257 . Thus only trees of length 257 remained for decay analysis after the tree search and filter.

3) **RESULTS**

3.1) **Sequence and features of the caribou mtDNA control region.**

The nucleotide sequences of the mtDNA control region (heavy strand), all of the flanking gene tRNA^{Thr}, and portions of the flanking genes tRNA^{Pro} and tRNA^{Phe} for 38 caribou, aligned with elk and white-tailed deer, are reported in Figure 3. Of the 38 caribou sequences reported, 33 unique haplotypes were found. The entire region analyzed in caribou ranged from 1061 to 1063 nt in length, depending on the individual, and was composed of 16 nt of the 5' end of the tRNA^{Thr} gene, 66 nt of the 5' end of the tRNA^{Pro} gene complement, the control region ranging from 926 to 928 nt, and 53nt of the 3' end of the tRNA^{Phe} gene.

Aligned with elk and white-tailed deer, the sequences presented in Figure 3 are 1197 nt. The variation in length of the caribou control region is located at positions 979 to 993, where there is a sequence of 4 to 6 T repeats, followed by 6 to 9 C repeats. This was the only region where within caribou sequence alignment was not obvious. Two alternatives for alignment were to allow for one position of T/C transition and thus shortening the total sequence by 1 nt, or to assume that the region is one which generates tandem repeats and to favour an extra gap over a T/C mismatch. Both alternatives were tested phylogenetically, however, the sequences in Figure 3 are aligned using the second assumption. The only other site with an insertion/deletion within caribou is position 508, at which three of 38 caribou are missing one C. Between caribou, elk, and white-tailed deer, there are no insertions/deletions in either region of the tRNA genes, and only one 3 nt long insertion/deletion within the CR central conserved region at positions 676 to 679. Between species, several major insertions/deletions are found throughout the CR left and right domains.

Within the CR left domain (positions 83-526), two segments of interest are the TAS-1 motif and the 3' end of the D-loop. TAS-1 (positions 462-477), called TAS-A in cattle, is functionally associated with the termination of the D-loop (Madsen *et al.* 1993). The 3' end of the D-loop (positions 391-395) is located 67 nt upstream of TAS-1, at a GCCCC motif in caribou, elk, and white-tailed deer. In total, the CR left domain contains 37 sites of nucleotide variation within caribou, 33 of which are transitions and 4 of which are transversions. Thus, 37 of 351 sites, or 10.54%, in the caribou CR left domain are variable.

Within the CR central conserved region (positions 527-758), a number of conserved sequence blocks (CSBs) common to Cervidae (Douzery & Randi 1997)

were found in caribou, including CSB-F (positions 527-554), CSB-E (568-604), CSB-D (627-651), CSB-C (673-699), and CSB-B (741-758). Sequence variation among caribou, and between caribou, elk, and white-tailed deer, was limited in the CR central conserved region. Most within caribou sequence variation was found in three regions; one within CSB-E, one between CSB-E and CSB-D, and one between CSB-D and CSB-C. In total, the CR central conserved region holds 11 sites of nucleotide variation within caribou, all of which are transitions. Thus, 11 of 232 sites, or 4.74%, in the caribou CR central conserved region are variable.

Within the CR right domain (positions 759-1144), three additional CSBs common to mammals (Saccone *et al.* 1991) were found in caribou. CSB-1 (positions 924-948) has one variable position within caribou, and two between caribou, elk, and white-tailed deer. As with other ruminant Artiodactyls (see Douzery & Randi 1997) CSBs 2 & 3 are fused in caribou. The source of variation in length of the caribou mtDNA CR which is due to a region of T repeats followed by C repeats (discussed earlier in "Results") is found within the fused CSBs 2 & 3. Douzery & Randi (1997) also found low sequence conservation of this region despite its presumed functional importance. Another notable feature of the CR right domain is the position of the origin of heavy strand replication (OH). The site is strictly conserved among other Cervidae (Douzery & Randi 1997), and is the same in caribou. In total, the CR right domain holds 17 sites of nucleotide variation within caribou, 15 of which are transitions and 2 of which are transversions. Thus 17 of 335 sites, or 5.07%, in the caribou CR right domain are variable.

The sequenced portions of the genes tRNA^{Thr} (positions 1-16), tRNA^{Pro} (positions 17-82), and tRNA^{Phe} (1145-1197) were highly conserved among caribou, and between caribou, elk, and white-tailed deer. Of the 135 tRNA sites sequenced, 5 (or 3.70%) were variable among caribou, one of which was a transversion.

Throughout the entire region sequenced, the total number of transition sites within caribou was 63, and the total number of transversion sites was 7, resulting in a ratio of exactly 9 transitions:1 transversion.

3.2) Initial phylogenetic analysis using maximum parsimony.

Initially, sequencing was performed on the following 23 caribou: BAT1, BAT2, BAT3, BAT4, BEV1, BEV2, BFN1, BFN2, BLN1, BLN2, CAR1, CAR2, GRV1, GRV2, GRV3, HUM1, HUM2, JNP1, JNP2, PUK1, PUK2, SKN1, and SKN2. Phylogenetic analysis using MP was performed on the 23

caribou sequences along with elk and white-tailed deer sequences. Analysis was performed on both sequence alignments (as described in "Methods and Materials"), one of which had a total length of 1196 nt and the other a total length of 1197 nt. In addition to the two alignments, three treatments of alignment gaps were tested; 1) including gaps in which case PAUP treats gaps as unknown character states, 2) excluding characters which have a gap in at least one of the 23 sequenced caribou (i.e., excluding insertions and deletions), and 3) treating gaps as a fifth character state. For each of the two alignments and three gap treatments, three different weightings of transitions:transversions were also tested; 1) 1:1, 2) 1:4, and 3) 1:9. The three weightings were chosen to test an equal weighting (1:1), to test a weighting of the same ratio as transitions:transversions were found to be in the respective sequences (1:9), and to test a weighting intermediate to the others (1:4). Thus, a total of 18 different alignment, gap treatment, and weighting schemes were analyzed phylogenetically using MP. All strict consensus trees have decay values shown above branches, and bootstrap values below branches. Note that only bootstrap values of 50% or greater are reported.

3.2.1) Trees reconstructed by including alignment gaps.

Figure 4 shows strict and majority-rule consensus trees of the 84 MP trees reconstructed from the 1196 nt alignment, including gaps, with transitions:transversions weighted 1:1. All 84 trees were 293 steps long, had a consistency index (CI) of 0.846, and a rescaled consistency index (RC) of 0.705. Both consensus trees show a monophyletic clade including most woodland caribou, and a paraphyletic clade including barrenground and two woodland caribou (CAR2 and JNP2). CAR2 and JNP2 which are both considered "mountain" woodland caribou were expected to group more closely to barrenground than to other woodland caribou based on previous RFLP analysis (unpublished data, Kovithavongs & Strobeck). Although several smaller clades are well supported by decay and bootstrap values, the monophyly of woodland caribou is the only well supported clade with more than four individuals (bootstrap=99%, decay=9). Figure 5 shows consensus trees from the 1197 nt alignment using the same gap treatments and weighting scheme as the trees in Figure 4. Trees found using the 1197 nt alignment were identical in number of MP trees (84), and CI (0.846) to those found using the 1196 nt alignment, but the RC using the 1197 nt alignment was slightly lower (0.704). Bootstrap and decay values were also similar between trees based on the two alignments. However, at 292 steps, the length of the trees

using the 1197 nt alignment were one step shorter than those found using the 1196 nt.

Figures 6 and 7 show consensus trees from the 1196 nt alignment and the 1197 nt alignment respectively, including gaps in both, and weighting transitions:transversions 1:4 in both. As with 1:1 weighting, the number of MP trees (28), the CI (0.895), and the RC (0.762) were found to be the same using either alignment. Also as with 1:1 weighting, the consensus tree topologies for the two alignments were identical to each other, but trees were one step shorter in the 1197 nt alignment (474 steps) than in the 1196 nt alignment (475 steps). While only woodland caribou were found to be monophyletic using 1:1 weighting (Figures 4 and 5), both woodland and barrenground caribou were found to be monophyletic using 1:4 weighting (figures 6 and 7). The same two woodland caribou (CAR2 and JNP2) grouped with the barrenground clade using 1:4 weighting as did using 1:1 weighting. Support for woodland caribou's monophyly remained high using 1:4 weighting (bootstrap=94% and decay=8 in Figure 6, bootstrap=98% and decay=6 in Figure 7), but support for barrenground caribou's monophyly was low (bootstrap=57% and decay=1 in Figure 6, bootstrap<50% and decay=1 in Figure 7).

Figures 8 and 9 show consensus trees from the 1196 nt alignment and the 1197 nt alignment respectively, including gaps in both, and weighting transitions:transversions 1:9 in both. As with the other weighting schemes, the number of MP trees (28), the CI (0.929), and the RC (0.814) were found to be the same using either alignment. The consensus tree topologies for the two alignments were not only identical to each other, but also identical to the tree topologies found using 1:4 weighting. As with the other weighting schemes, the MP trees found using the 1197 nt alignment were one step shorter (774 steps) than those found using the 1196 nt alignment (775 steps). Both woodland and barrenground caribou were found to be monophyletic, with high support for the woodland clade (bootstrap=97% and decay=9 in Figure 8, bootstrap=98% and decay=7 in Figure 9) and higher support for the barrenground clade than in other weighting schemes (bootstrap=60% and decay=10 in Figure 8, bootstrap=65% and decay =7 in Figure 9), although bootstrap support for the barrenground clade was low relative to decay values. The relationship between bootstrap and decay values found in this research will be discussed further in the "Discussion" section of this paper.

3.2.2) Trees reconstructed by excluding alignment gaps.

Figures 10 and 11 show consensus trees from the 1196 nt alignment and the 1197 nt alignment respectively, excluding gaps in both, and weighting transitions:transversions 1:1 in both. The number of MP trees (84), the CI (0.823), and the RC (0.685) were found to be the same using either alignment. The consensus tree topologies for the two alignments were identical to each other, and identical to those reconstructed including gaps (Figures 4 and 5). Unlike trees reconstructed including gaps, however, the lengths of MP trees reconstructed excluding gaps were the same for both alignments (254 steps). As with trees reconstructed including gaps (Figures 4 and 5), the consensus trees in Figures 10 and 11 show strong support for woodland caribou's monophyly (bootstrap=99% and decay=8 in Figure 10, bootstrap=97% and decay=8 in Figure 11), and show a paraphyletic structure for barrenground caribou.

Figures 12 and 13 show consensus trees from the 1196 nt alignment and the 1197 nt alignment respectively, excluding gaps in both, and weighting transitions:transversions 1:4 in both. The number of MP trees (28), the CI (0.875), and the RC (0.744) were found to be the same using either alignment. The consensus tree topologies for the two alignments were identical to each other, and both were identical to those reconstructed including gaps (Figures 6 and 7). As with 1:1 weighting, the lengths of MP trees reconstructed excluding gaps with 1:4 weighting were the same for both alignments (400 steps). Similar to trees reconstructed including gaps, the change in weighting from 1:1 to 1:4 for trees excluding gaps changed the structure of barrenground caribou from paraphyletic to monophyletic. However, support for the barrenground clade in trees reconstructed excluding gaps (bootstrap=57% and decay=2 in Figures 12 and 13) was slightly stronger than in trees reconstructed including gaps (bootstrap=57% and decay=1 in Figure 6, bootstrap<50% and decay=1 in Figure 7).

Figures 14 and 15 show consensus trees from the 1196nt alignment and the 1197 nt alignment respectively, excluding gaps in both, and weighting transitions:transversions 1:9 in both. The number of MP trees (28), the CI (0.914), and the RC (0.801) were found to be the same using either alignment. The consensus tree topologies for the two alignments were identical to each other, and to the consensus tree topologies found with 1:4 weighting, and both were identical to those reconstructed including gaps (Figures 8 and 9). As with other weighting schemes, the lengths of MP trees reconstructed excluding gaps were the same for both alignments (640 steps). With 1:9 weighting, support for the monophyly of

woodland caribou was strong (bootstrap=97% and decay=6 in Figure 14, bootstrap=95% and decay=6 in Figure 15) and support for the monophyly of barrenground caribou was stronger than in other weighting schemes, although bootstrap values remained relatively low (bootstrap=57% and decay=6 in Figure 14, bootstrap=62% and decay=7 in Figure 15).

3.2.3) Trees reconstructed by considering alignment gaps as a fifth character state.

Figures 16 and 17 show consensus trees from the 1196 nt alignment and the 1197 nt alignment respectively, treating gaps as a fifth character state in both, and weighting transitions:transversions 1:1 in both. The number of MP trees (224) were found to be the same using either alignment, however, the CI (0.885 in Figure 16, 0.884 in Figure 17), and the RC (0.741 in Figure 16, 0.737 in Figure 17) were not the same using either alignment. As with trees reconstructed by including gaps, the lengths of MP trees reconstructed treating gaps as a fifth character state varied between alignments, however, unlike trees reconstructed by including gaps, the trees using the 1196 nt alignment (length=462 steps) were shorter than those using the 1197nt alignment (length=464 steps).

The consensus tree topologies for the two alignments were identical to each other. They were, however, very different from the consensus tree topologies reconstructed from either including gaps (Figures 4 and 5) or excluding gaps (Figures 10 and 11). Instead of paraphyly for the clade of barrenground caribou, the structure of the barrenground clade is largely unresolved in Figures 16 and 17. The lack of resolution is due to two conflicting tree families which were found using the tree-to-tree distances option in PAUP. A search for tree families was performed after every tree search, however, the consensus trees in Figures 16 and 17 are the only ones representing more than one tree family. Of the 224 MP trees making up the consensus trees in Figures 16 and 17, approximately one third reconstructed monophyly for both woodland and barrenground caribou, and approximately two thirds reconstructed monophyly for woodland caribou and the more typical paraphyly for barrenground caribou. Like all other alignments, gap treatments, and weighting schemes, support for the monophyly of woodland caribou was strong (bootstrap=99% and decay=9 in Figure 16, bootstrap=98% and decay=9 in Figure 17).

Figures 18 and 19 show consensus trees from the 1196 nt alignment and the 1197 nt alignment respectively, treating gaps as a fifth character state in both, and

weighting transitions:transversions 1:4 in both. The number of MP trees (14) was the same using both alignments, but the length (706 steps in Figure 18, 708 steps in Figure 19), the CI (0.919 in Figure 18, 0.918 in Figure 19), and the RC (0.785 in Figure 18, 0.782 in Figure 19) were different using the two alignments. The consensus tree topologies for the two alignments were identical to each other. Similar to trees reconstructed including and excluding gaps, the change in weighting from 1:1 to 1:4 for trees treating gaps as a fifth character state changed the structure of barrenground caribou to monophyletic. However, the consensus trees shown in Figures 18 and 19 are slightly different in topology relative to the corresponding consensus trees found including gaps (Figures 6 and 7) and excluding gaps (Figures 12 and 13). The difference is that the consensus trees in Figures 18 and 19 reconstruct the barrenground clade including BAT1, BAT3, BAT4, and BFN1 as slightly more resolved. Support for the barrenground clade was slightly higher (bootstrap=57% and decay=3 in Figure 18, bootstrap=60% and decay=3 in Figure 19) than in trees reconstructed including or excluding gaps. Support for the monophyly of woodland caribou remained high (bootstrap=98% and decay=7 in Figure 18, bootstrap=98% and decay=8 in Figure 19).

Figures 20 and 21 show consensus trees from the 1196 nt alignment and the 1197 nt alignment respectively, treating gaps as a fifth character state in both, and weighting transitions:transversions 1:9 in both. The number of MP trees (14) was the same using either alignment and the same as weighting 1:4, but the length (1111 steps in Figure 20, 1113 steps in Figure 21), the CI (0.944 in Figure 20, 0.943 in Figure 21), and the RC (0.827 in Figure 20, 0.825 in Figure 21) were different using the two alignments. The consensus tree topologies for the two alignments were identical to each other, and to those found by weighting 1:4. As usual with 1:9 weighting, support for the monophyly of woodland caribou was strong (bootstrap=93% and decay=6 in Figure 20, bootstrap=99% and decay=6 in Figure 21) and support for the monophyly of barrenground caribou was stronger than in other weighting schemes (bootstrap=65% and decay=8 in Figure 20, bootstrap=65% and decay=7 in Figure 21).

3.2.4) The relationship between bootstrap and decay values.

Support for evolutionary relationships reconstructed on phylogenetic trees is more commonly done by bootstrapping than by decay analyses, and it is quite rare that results of both methods are presented. Consequently, on Figure 22 I plotted decay values found on the trees in Figures 4 to 21 against their respective bootstrap

values. This was instructive in two ways. First, the relationship between results of the two methods can be seen. It should be remembered that only bootstrap values of $\geq 50\%$ were retained and shown on trees. Therefore, the mean bootstrap value for a decay value of 1 is biased upward on Figure 22. Decay values as low as 3 generally showed high bootstrap support, and decay values of 5 consistently showed very high bootstrap support. Second, six points (two of them having the same values of decay = 7 and bootstrap = 65%) are distant outliers. Data for all six points are from the branches leading to the monophyletic barrenground clade on the six trees reconstructed using 1:9 weighting. Thus, with higher weighting of transversions, decay support grew for the monophyly of barrenground caribou, but bootstrap support did not. In the case of woodland caribou monophyly, decay and bootstrap support was high and relatively stable, regardless of transversion weighting. This implies that transitions provided little support for the northern clade's monophyly relative to the support transitions provided for the southern clade's monophyly. For this reason, increased weighting of transversions had little effect on support for the southern clade, but a large effect on decay support for the northern clade. As decay support increased for the monophyly of the northern clade, bootstrap support did not because very few characters were effected by increasing the weight of transversions, and as such bootstrapping did not consistently sample those sites.

PAUP bootstrapping is pre-set to treat weighted characters by sampling with equal probability and to apply weights after sampling. However, it can be changed to treat character weights as repeat counts, or in other words, to treat a character given a weight of 9 as 9 characters. In this case, weight is not also applied to characters after sampling. This second bootstrapping method was done for the 1197 nt alignment, excluding gaps, and weighting transitions to transversions 1:9. Figure 23 shows the resulting consensus tree. It is identical to the tree shown in Figure 15 which was found using the same alignment, gap treatment, and weighting scheme. Along with the decay and bootstrap values found on the tree in Figure 15, the bootstrap values found treating character weights as repeat counts are also included on Figure 23. Except for one, all bootstrap values changed by 5% or less, and of those, all except one changed by 2% or less. Considering that 100 bootstrap replicates were performed, it is unlikely these differences have any significance. However, the bootstrap value for the monophyletic barrenground clade increased from 62% to 94%. In the case of intraspecific studies or any study involving low levels of DNA sequence

divergence, it seems that bootstrapping while treating character weights as repeat counts is a more reliable method for assessing branch support for groupings which rely on weighted characters such as transversions. For this reason, both bootstrapping techniques were performed during the second round of phylogenetic analysis, which included all caribou from initial analysis along with several more. Results of this will be presented in section 3.4.

3.3) Diagnostic restriction digests.

After initial phylogenetic analysis of 23 caribou using MP provided evidence for two monophyletic groups which corresponded roughly to the woodland and barrenground caribou subspecies, I searched for sequence character states that were diagnostic for the two monophyletic groups. To avoid confusion over speaking of a woodland caribou with barrenground mtDNA (as was the case with some mountain woodland caribou) or a barrenground caribou with woodland mtDNA, the terms "woodland" and "barrenground" will hereafter refer to the subspecies to which an individual or herd is believed to belong based on ecology and morphology, and the terms "southern" haplotype and "northern" haplotype will refer to the mtDNA types which are commonly found in woodland and barrenground caribou respectively.

Two sites were found that could distinguish between southern and northern haplotypes, and that were within the sequences recognized for cleavage by relatively common restriction enzymes. The first diagnostic site, with the variable sequence A-G-C-C/T, was found at nucleotide positions 33 to 36 (Figure 3). AGCT was the sequence found from nucleotide positions 33 to 36 in southern haplotypes, and AGCC was the corresponding sequence found in northern haplotypes. The sequence AGCT is recognized for cleavage between the adjacent G and C residues by *Alu* 1, but AGCC is not, thus the diagnostic site at positions 33 to 36 is cut by *Alu* 1 in southern haplotypes but not in northern haplotypes. As described in "Materials and Methods", the 512 nt region surrounding the first diagnostic site was PCR amplified using primers CST 2 and CST 345. There were either 5 or 6 *Alu* 1 cut sites in the 512 nt amplified region, resulting in the following fragments in both southern and northern haplotypes; 338 nt, ~65 nt (approximate because of the inability to sequence the region immediately adjacent to the primer annealing site), 43 nt, and 39 nt. The northern haplotype also had the diagnostic fragment of 27 nt, while the extra cut site in the southern haplotype resulted in two

diagnostic fragments of 21 nt and 6 nt. Figure 24 shows the diagnostic *Alu* I fragments for both haplotypes.

The second diagnostic site, with the variable sequence G-T-A-T/C, was found at nucleotide positions 350 to 353 (Figure 3). GTAC was the sequence found from nucleotide positions 350 TO 353 in southern haplotypes, and GTAT was the corresponding sequence found in northern haplotypes. The sequence GTAC is recognized for cleavage between the adjacent T and A residues by *Rsa* I, but GTAT is not, thus the diagnostic site at positions 350 to 353 is cut by *Rsa* I in southern haplotypes but not in northern haplotypes. The 294 nt region surrounding the second diagnostic site was PCR amplified using primers CST 1079 and CST 1080. There were either 9 or 10 *Rsa* I cut sites in the 294 nt amplified region, resulting in the following fragments in both southern and northern haplotypes; 77 nt, 70 nt, 35 nt, 19 nt, 19 nt, 16 nt, 11 nt, and 7 nt. The northern haplotype also had a fragment of 40 nt, while the extra cut site in the southern haplotype resulted in two fragments of 25 nt and 15 nt. Figure 25 shows the diagnostic *Rsa* I fragments for both haplotypes.

The results of all restriction digests are reported in Appendix 1, and summarized by herd in Table 2. Individuals were added to Table 2 only when digests with both restriction enzymes unambiguously provided the same answer as to the haplotype of the given individual. All 23 caribou which were originally sequenced and placed into either the southern or northern haplotype clade based on MP were diagnosed as belonging to the same clade when using restriction digests. Of the 138 barrenground caribou reported in Table 2, 131 (95%) were of the northern haplotype. The only barrenground herd with more than 4% southern haplotypes was the Kaminuriak/Churchill herd in northern Manitoba with 5 of 15 (33%) individuals of the southern haplotype. The Kaminuriak/Eskimo Point herd in the NWT had no individuals of the southern haplotype.

The woodland herds in Table 2 are subdivided into mountain woodland herds, Yukon woodland herds, and all other woodland herds. Of the 72 caribou from eight "other" woodland herds (ranging from Alberta to Newfoundland), 62 (86%) were of the southern haplotype. Notably, the George River herd from northern Quebec and Labrador and the Mealy herd from Labrador had 4 of 18 (22%) and 3 of 13 (23%) of the northern haplotype respectively. Of the 80 caribou from four mountain woodland herds, just 20 (25%) were of the southern haplotype, with the Purcell herd having the lowest proportion (2 of 31, or 6%) of southern haplotypes. Caribou from the four Yukon woodland herds were found to

be 100% (72 of 72) of the northern haplotype. The regional distribution of the southern and northern haplotypes relative to herd and subspecies ranges is shown on a map in Figure 26.

3.4) Phylogenetic analysis using MP of previously analyzed caribou in addition to caribou with unexpected and ambiguous restriction digest results.

As stated in the previous section, most barrenground caribou (95%) were found to have the northern haplotype, and most woodland caribou (86%) from non-mountain and non-Yukon herds were found to have the southern haplotype. Relatively few mountain woodland caribou (25%), and no Yukon woodland caribou were found to have the southern haplotype typical of other woodland caribou. To further test the power of the diagnostic restriction digests, four caribou with unexpected haplotypes based on RFLP were selected for sequencing, including; BAT7 (with a southern haplotype, but from a barrenground herd), NEO1 (with a northern haplotype, but from a woodland herd), SLK1 (with a northern haplotype, but from a mountain woodland herd), and WLF1 (with a northern haplotype, but from a Yukon woodland herd). "Unexpected" restriction digest results refers to an individual whose haplotype does not correspond to the haplotype expected for its subspecies (i.e., a woodland caribou with a northern haplotype). Because of the unusual dichotomy of haplotypes in the mountain woodland caribou herds, an additional caribou, SLK2 (with a southern haplotype, and from a mountain woodland herd), with the expected haplotype based on RFLP was sequenced.

The additional five sequences were added to those already analyzed phylogenetically. In addition, of the 370 caribou analyzed using restriction digests, eight caribou had ambiguous results because the two restriction enzymes provided different haplotype diagnoses. The eight caribou with ambiguous RFLP results included; BAT5, BAT6, BEV3, BLN3, GRV4, HUM3, KAM1, KAM2. These caribou were sequenced and added to those already analyzed phylogenetically. Sequence from the two reindeer, RND1 and RND2, were also added to the second round of phylogenetic analysis. Using MP, trees were reconstructed alternatively by excluding alignment gaps and by considering alignment gaps as a fifth character state. The 1197 nt alignment was used, and the weighting of transitions:transversions was 1:9.

3.4.1) Trees reconstructed by excluding alignment gaps.

Figures 27 and 28 show strict consensus and majority rule consensus trees respectively, using the 1197 nt alignment in both, excluding gaps in both, and weighting transitions:transversions 1:9 in both. The consensus trees are based on 438 MP trees, all with a length of 718, a CI of 0.851, and a RC of 0.718. Both the strict and majority rule consensus trees show strong support for the southern haplotype's monophyly (bootstrap=93% when sampling characters with equal weight or 95% when weights treated as repeat counts, and decay=5 in Figure 27), and variable support for the northern haplotype's monophyly depending on the method of bootstrapping (bootstrap<50% when sampling characters with equal weight or 68% when weights treated as repeat counts, and decay=6 in Figure 27). Both the strict (Figure 27) and majority rule (Figure 28) consensus trees show more resolution in the southern haplotype clade than in the northern haplotype clade. All of the unexpected RFLP results were supported by sequencing analysis (i.e., caribou diagnosed unexpectedly as northern haplotype by RFLP were grouped within the northern haplotype clade using MP). Of the caribou diagnosed ambiguously by the two restriction enzymes, all eight were found to group with the haplotype clade predicted by the restriction enzyme *Alu* 1, and not with the haplotype clade predicted by *Rsa* 1. Both reindeer, RND1 and RND2, were placed within the northern clade.

3.4.2) Trees reconstructed by considering alignment gaps as a fifth character state.

Figures 29 and 30 show strict consensus and majority rule consensus trees respectively, using the 1197 nt alignment in both, treating gaps as a fifth character state in both, and weighting transitions:transversions 1:9 in both. The consensus trees are based on 4666 MP trees, all with a length of 1199, a CI of 0.897, and a RC of 0.751. As with trees reconstructed by excluding gaps, both the strict and majority rule consensus trees show strong support for the southern clade's monophyly (bootstrap=98% when sampling characters with equal weight or 97% when weights treated as repeat counts, and decay=7 in Figure 29), and variable support for the northern clade's monophyly depending on the method of bootstrapping (bootstrap=55% when sampling characters with equal weight or 71% when weights treated as repeat counts, and decay=6 in Figure 29). Unlike, consensus trees based on excluding gaps, the strict consensus tree (Figure 29)

reconstructed by treating gaps as a fifth character state shows no more resolution in the southern haplotype clade than in the northern haplotype clade. The majority rule consensus (Figure 30), however, has an identical southern clade topology to that reconstructed by excluding gaps (Figure 28). Although many sub-groups reported in the majority rule consensus within the northern clade are similar regardless of the treatment of gaps (see Figures 28 and 30), their arrangement and resolution varies somewhat. As with MP analysis excluding gaps, all unexpected RFLP results were supported by sequencing analysis, and all caribou diagnosed ambiguously by the two restriction enzymes were found to group with the haplotype clade predicted by the restriction enzyme *Alu* 1, and not with the haplotype clade predicted by *Rsa* 1. Also as with analysis excluding gaps, both reindeer (RND1 and RND2) were placed within the northern clade.

3.5) Phylogenetic analysis using NJ of previously analyzed caribou in addition to caribou with unexpected and ambiguous restriction digest results.

As with phylogenetic analysis using MP, analysis using NJ included all 36 sequenced woodland and barren-ground caribou, including those with unexpected or ambiguous RFLP results. Also as with MP analysis, NJ analysis included the two reindeer and the outgroups, elk and white-tailed deer. Only the 1197 nt alignment was analyzed by NJ. The program DNADIST (in PHYLIP version 3.572c; Felsenstein 1995), which was used to determine genetic distances, treats gaps as unknown nucleotides. Information from the presence or absence of the gap is left out completely in the production of genetic distances. This is equivalent, in MP analysis, to reconstructing trees by including alignment gaps. It should be recalled that trees initially reconstructed using MP were identical in topology whether they were made by including or excluding gaps. Both trees reconstructed by NJ and presented in this paper on Figures 31 and 32 include bootstrap values. If tree branches are followed leading from the outgroups (elk and white-tailed deer), bootstrap values of $\geq 50\%$ are presented immediately before the node to which they refer. Bootstrapping in PHYLIP does not allow for the option of treating weighted characters as repeat counts as does PAUP, thus characters were sampled with equal probability and weights were applied after sampling. Branch lengths in Figures 31 and 32 are based on internodal lengths, however, the vertical scale is exaggerated by 17% to make the trees more readable. Branch lengths for elk and wtdeer are compressed in both figures by about 80% to allow their inclusion on the trees.

Figure 31 shows a NJ tree reconstruction, weighting transitions:transversions 1:1. It should be noted that elk's distance to caribou is 21% less than white-tailed deer's distance to caribou. Reasons for this will be examined further in the "Discussion" section. Both the southern and northern haplotype clades appear as monophyletic on the tree in Figure 31, however, while bootstrap support for the monophyly of the southern clade was 98%, it was <50% for the northern clade. The low bootstrap support for the northern clade is not surprising considering that the option of treating character weights as repeat counts was not available. As with MP analysis, all unexpected RFLP results were supported by sequencing analysis using NJ, and all caribou diagnosed ambiguously by the two restriction enzymes were found to group with the haplotype clade predicted by the restriction enzyme *AluI*, and not with the haplotype clade predicted by *RsaI*. Also, as with MP analysis, both reindeer (RND1 and RND2) were placed within the northern clade. The topology of the southern clade is similar to the topology found in the MP majority rule consensus trees made by excluding gaps (Figure 28) and treating gaps as a fifth character state (Figure 30). However, there are two differences. The first is that the group of BAT7 and SKN2 which constitutes the first bifurcation leading to the southern clade in NJ (Figure 31) is grouped internally with caribou from western herds in the southern haplotype clade in MP (Figures 28 and 30). The second difference is that PUK1 and PUK2 which are grouped together in NJ (Figure 31) are attached paraphyletically to the remaining caribou with southern haplotypes in MP (Figures 28 and 30). The topology of the northern clade in NJ (Figure 31) has similar sub-groupings to the northern clade in MP (Figures 28 and 30) although relationships between the sub-groups are different or unresolved using MP. It should be noted that the major sub-groups within the northern clade in NJ (Figure 31) are joined by very short branches, which is probably related to the lack of resolution in the northern clade using MP (Figures 28 and 30).

Figure 32 shows a NJ tree reconstruction, weighting transitions:transversions 1:9. Once again, all unexpected RFLP results were supported by sequencing analysis using NJ, and all caribou diagnosed ambiguously by the two restriction enzymes were found to group with the haplotype clade predicted by the restriction enzyme *AluI*, and not with the haplotype clade predicted by *RsaI*. Also, as with other analyses, both reindeer (RND1 and RND2) were placed within the northern clade. The southern clade is identical in topology to the NJ tree using 1:1 weighting (Figure 31). Much of the topology of the northern

clade based on 1:9 weighting (Figure 32) was similar to that based on 1:1 weighting (Figure 31). However, an important difference is that using 1:9 weighting the outgroups were joined within the northern clade instead of between the northern and southern clades. Thus, using 1:9 weighting in NJ, the northern clade became paraphyletic to the southern clade. Bootstrap support for the paraphyly of the northern clade was 100% and for the monophyly of the southern clade was 96%. It should be recalled that the reverse was true using MP to reconstruct trees; that is, using 1:1 weighting the northern clade was paraphyletic, while 1:4 or 1:9 weighting made the northern clade monophyletic.

Based on the second round of phylogenetic analysis using MP and NJ, of the 370 caribou diagnosed using RFLP, 370 (100%) were diagnosed correctly by *Alu1*, and 362 (97.8%) were diagnosed correctly by *Rsa1*. This assumes that *Alu1* and *Rsa1* were never simultaneously both incorrect at diagnosing haplotype. Considering how rarely *Alu1* and *Rsa1* disagreed (8 of 370 samples), and that *Alu1*'s diagnoses was correct in all disagreements, this assumption is probably reasonable.

Also based on the second round of phylogenetic analysis, four sites in the DNA sequences of the caribou were identified as diagnostic for the southern and northern clades. This second diagnosis is more reliable than the first because it is based on 36 instead of 23 sequences, and it takes into account several haplotypes which are known to be unusual based on restriction digests. The first site is a transition (T/C) at nucleotide position 1 in the tRNA^{Thr} gene (Figure 3). The second site is a transition (T/C) at position 36 in the tRNA^{Pro} gene, and is the site chosen for diagnosis using the restriction digest *Alu1*. The third site is a transition (G/A) at position 356 in the CR's left domain. The fourth site is a transversion (T/A) at position 1066 in the CR's right domain.

4) Discussion

4.1) The genetic relationship of woodland and barrenground caribou based on sequence analysis.

Using parsimony analysis, I initially investigated what effect different alignments, weighting schemes, and gap treatments had on the phylogenetic tree topology of woodland and barrenground caribou. To summarize the major differences: 1) Trees reconstructed using the 1197 nt alignment were more parsimonious than those reconstructed by the 1196 nt alignment when gaps were included as characters, equally parsimonious when gaps were excluded as characters, and less parsimonious when gaps were treated as a fifth character state. This last difference was expected since the 1197 nt alignment has one more alignment gap in each sequence than does the 1196 nt alignment. 2) Tree topology was the same either by including or excluding alignment gaps. 3) Trees reconstructed by including and excluding alignment gaps, and weighting transitions to transversions 1:1, belonged to a single tree island, while trees reconstructed by treating alignment gaps as a fifth character state, and weighting transitions to transversions 1:1, belonged to two tree islands. 4) All trees reconstructed by weighting transitions to transversions 1:1 found the southern clade to be monophyletic and the northern clade to be paraphyletic relative to the southern clade. 5) All trees reconstructed by weighting transitions to transversions 1:4 or 1:9 found both clades to be monophyletic.

Put in biological terms, the woodland caribou of Canada's boreal regions which made up the southern mtDNA clade were consistently found to have a common ancestor unique from that of the barrenground caribou and the woodland caribou in the Cordilleran region. The barrenground and woodland caribou which made up the northern mtDNA clade were found alternatively to have a common ancestor or not, depending on the weighting of transitions to transversions. As stated previously, sequences were well conserved among all caribou, and just four sites in the sequenced region of mtDNA were diagnostic for the two mtDNA lineages, and of these only one site was a transversion. Thus, when weighting of transversions was increased four or nine fold, it had a great influence over the resulting phylogenetic tree reconstruction. A high ratio of transitions to transversions is common among conspecifics (Thomas *et al.* 1990, Douzery & Randi 1997), and the ratio generally decreases with evolutionary distance (Douzery & Randi 1997) as sequences become saturated with nucleotide substitutions. For

this reason, a ratio as high as the one found in caribou is a good indicator that the sequences have not yet become saturated with substitutions, and that the ratio is probably a reasonable one to use for the purpose of character weighting. This logic leads to support of the conclusion that the barrenground and woodland caribou which make up the northern mtDNA clade have a common ancestor unique from that of the woodland caribou which make up the southern mtDNA clade. An alternate conclusion which accepts the paraphyletic results of 1:1 weighting will be discussed later.

Relative to MP, the effect of increasing weighting of transversions from 1 to 9 was reversed using NJ. This peculiar result can be explained by the different methods used for tree reconstruction in MP and NJ. As a distance method, NJ is unable to detect homoplasies, and the increased weighting simply resulted in a shift of the outgroup's placement relative to the two caribou clades. Parsimony analysis, on the other hand, is unlike distance methods such as NJ, in that it uses shared characters to detect homoplasies and infer phylogeny (Stewart 1993). Furthermore, parsimony analysis is an especially appropriate method for phylogeny reconstruction when sequence divergence is low (Nei & Tajima 1981). For these reasons the shift in tree topology with increased weighting of transversions is probably more reliable in trees made using MP than those made using NJ.

One problem with concluding that the northern and southern mtDNA clades are mutually monophyletic was the relatively low bootstrap support for the monophyletic northern clade. Even after treating weighted characters as repeated characters in bootstrap analysis, bootstrap support for the northern clade was only 68% to 71% (depending on the alignment) compared to 95% to 97% (depending on the alignment) for the southern clade. Clearly, the sequence data do not support a monophyletic northern clade as strongly as a monophyletic southern clade. However, the use of bootstrapping for assessing confidence has been challenged for several reasons. Of most importance to this study is the finding that when $\leq 20\%$ of characters change among nodes of a phylogenetic tree (as is the case in almost all intraspecific phylogenies, including the one of caribou), bootstrap values of $\geq 70\%$ usually correspond to a probability of $\geq 95\%$ that the relevant clade is real (Hillis & Bull 1993). Especially considering the tiny fraction of characters that distinguish the two mtDNA clades in woodland and barrenground caribou, bootstrap support for the monophyletic northern clade is probably an underestimate.

Another explanation for the relatively low support of the northern clade's monophyly is the choice of outgroups. NJ trees on Figures 31 and 32 show the

northern and southern clade to be distinct from one another regardless of the position of the outgroups. Even on the tree in Figure 31, where both clades were found to be monophyletic, the branch leading to the outgroup is much closer to the northern clade than to the southern clade. If a different outgroup (or outgroups) had been selected, which attached to caribou half way between the northern and southern clades, bootstrap support may have been high for the monophyly of both clades.

4.2) Geographic distribution of mtDNA clades, and the relationship of mtDNA clades to clades based on previous morphological data.

Diagnostic restriction digests generally proved to be consistent with sequencing results, with 100% correct diagnoses by *AluI*, and 97.8% by *RsaI*. As shown on the map in Figure 26, the geographic distribution of the northern and southern mtDNA clades corresponds only in part to the geographic distribution of *R.t. groenlandicus* (barrenground caribou) and *R.t. caribou* (woodland caribou) as described by Banfield (1961). It seems that mtDNA suggests a slightly different scenario for post-glacial dispersion of caribou than what is usually considered to have taken place (Banfield 1961, MacPherson 1965). Based on the distribution of mtDNA clades shown on the map in Figure 26, the ancestors of modern non-Cordilleran woodland caribou which resided south of the Wisconsinan ice-sheets were not the first caribou to disperse through the ice-free corridor. Since all Yukon woodland caribou were found to have northern haplotypes, and most mountain woodland caribou were found to have northern haplotypes, the ancestors of modern barrenground caribou, which resided in Beringia, must have dispersed south through at least part of the corridor, and then continued south and west into the Cordilleran region after the Cordilleran glaciers receded. Compare a map series of this theorized dispersal pattern (Figures 33a, b, and c) to the traditional theory of post-glacial dispersal by ancestral woodland and barrenground caribou (Figures 2a, b, and c). Although ancestors of the northern mtDNA clade must have dispersed

While Banfield's theory of post-glacial caribou dispersal, and his subspecific classifications for caribou have been widely accepted and applied, he also described several "demes" below the subspecific level which he did not find to have statistically significant differences in morphology, but which he treated and described as potential subspecies of the future (Banfield 1961). The barrenground caribou were divided into *arcticus* (including the Bathurst, Beverly, and Bluenose herds), and *keewatin* (including the Kaminuriak and Southampton Island herds,

and possibly the South Baffin herd). These two barrenground demes were not found using either MP or NJ analysis of mtDNA sequences. Restriction digests resulted in 92% northern haplotype in the *keewatin* herds and 97% northern haplotype in the *arcticus* herds. It should be noted that five of six southern haplotypes in the *keewatin* herds were from Churchill, Manitoba, thus no genetic evidence was found for the existence of two barrenground demes.

Banfield divided the woodland caribou into *stonei* (including all the Yukon woodland herds, which he considered to be woodland caribou with some barrenground characteristics), *sylvestris* (including all woodland mountain herds), *caribou* (including boreal herds from Alberta to southern Quebec), *caboti* (including herds from Labrador to the Ungava peninsula), and *terraenovae* (including all herds on insular Newfoundland). Although some geographic structuring of haplotypes was found using MP and NJ analysis, it did not correspond exactly to the woodland demes proposed by Banfield. Using MP, the Saskatchewan caribou (representing *caribou*) grouped much more closely to woodland mountain caribou with southern mtDNA haplotypes (representing *sylvestris*) than to the other boreal (*caribou*) herd of Pukaskwa/North Lake Superior. Humber caribou (representing *terraenovae*) grouped more closely together in NJ than in MP analysis. George River caribou (representing *caboti*), however, all grouped closely together.

Restriction digests resulted in 0% southern mtDNA clade in *stonei* herds, 25% southern clade in *sylvestris* herds, 86% southern clade in *caribou* herds, 100% southern clade in *terraenovae* herds, and 77% southern clade in *caboti* herds. Thus, from Yukon herds (*stonei*), to mountain herds (*sylvestris*), and on to boreal and eastern herds (*caribou*, *terraenovae*, and *caboti*) the fraction of northern mtDNA haplotypes drops greatly and then increases again in Labrador and northern Quebec. In a study of seven skull measurements in male caribou from the proposed woodland demes, Banfield (1961) found that six of the measurements showed *stonei* at one extreme, followed by *sylvestris*, and then by the remaining boreal and eastern demes at the other extreme (see Banfield 1961 Table 18). A similar correspondence between restriction digest results and morphological measurements of female caribou was not evident (see Banfield 1961 Table 19). However, there remains some genetic evidence for the existence of several woodland demes, although it remains unclear how closely mtDNA demes correspond to the morphologic demes described Banfield.

It is interesting that despite having mostly or all northern mtDNA haplotypes, woodland caribou in the western Canadian mountains and Yukon are

morphologically much more like other woodland caribou than like barren-ground caribou who share their northern mtDNA haplotypes. Incongruence between mtDNA characters and morphological characters has also been found in the red wolf (Wayne & Jenks 1991) and the Florida panther (O'Brien et al. 1990). In both cases, the incongruence is thought to be associated with historical introgression between two subspecies or closely related species. In addition, morphological patterns of geographic variation often have a non-genetic component. In studies of ermine (Eger 1990) and collared lemming (Eger 1995) some geographic variation of skull shape was found to be correlated with climate (winter temperatures), and some geographic variation was consistent with isolation of populations in Wisconsin glacial refugia. Thus, both historical introgression and environmental influences have probably contributed to the lack of concordance between mtDNA and morphology in woodland and barren-ground caribou. Relative climatic and ecological similarities in the ranges of mountain woodland and non-mountain woodland caribou may have also resulted in an evolutionary convergence of the two types of woodland caribou which is masked genetically because of the nature of mtDNA inheritance.

4.3) An estimated time of divergence for the northern and southern mtDNA clades.

Although molecular clocks used for estimating times of evolutionary divergence require many assumptions that are known to be largely invalid (see Hillis *et al.* 1996 for a review), they remain a useful tool as long as their predictions are used with caution. Based on the 36 woodland and barren-ground caribou sequences shown on Figure 3, a frequency distribution of all 630 pairwise sequence divergences was plotted against relative frequency of sequence divergence on Figure 34. Sequence divergences within mtDNA clades and between mtDNA clades resulted in two distinct frequency peaks, and it is clear that divergence between clades is distinct from -- and about twice the magnitude of -- divergence within clades.

The average divergence of individuals within the southern clade was 0.917% (SD=0.331%), and of individuals within the northern clade was found 1.120% (SD=0.328%). The average divergence of individuals between the southern clade and the northern clade was 2.044% (SD=0.241%). Between clade divergence was corrected for within clade divergence using the following formula: $p_{corr.} = p_{xy} - 0.5(p_x + p_y)$ where p_x and p_y are the mean pairwise distances of

mtDNA haplotypes within regions *x* and *y* respectively. The resulting p_{corr} was 1.025% sequence divergence between the southern and northern mtDNA clade.

The rate of DNA sequence divergence in caribou is not known. However, divergence rates of mtDNA have been found to correlate with body size for various vertebrates (Martin & Palumbi 1993). Primates weighing 33-35 kg are estimated to have a divergence rate of 2.1% per million years (Brown *et al.* 1979), and horses weighing 100-400 kg are estimated to have a divergence rate of 1.5-2.6% per million years (George & Ryder 1986). Since woodland and barrenground caribou weigh approximately 125 kg (Banfield 1961), a mtDNA divergence rate of 2.1% per million years seems reasonable for caribou. The mtDNA control region evolves about five times faster than the rest of the mt genome (Cann *et al.* 1987, Greenberg *et al.* 1983), thus an estimate of divergence rate specific to the caribou mtDNA control region is 10.5% per million years. This is similar to the divergence rate estimated for the human mtDNA control region of 11.8% per million years (Stoneking *et al.* 1992). With a corrected sequence divergence between clades of 1.025% and a rate of sequence divergence of 10.5% per million years, the time of divergence between the two clades is estimated to be $1/2(1.025/10.5) \times 10^6$ years = 48,810 ybp.

A simple estimate of 95% confidence limits for the divergence time is based on Poisson probabilities (see Hillis *et al.* 1996, pg. 532), and results in a range of time from 22 kybp to 76 kybp. This range seems large because unlike most calculations of confidence limits, it is not based on the variance of the molecular estimate (i.e., variance of divergence rates) but rather on the major source of error in the estimate which is the random variation in the speed of the clock itself (Hillis *et al.* 1996). Even based on this broad confidence interval, it seems that the southern and northern mtDNA clades of caribou shared their last common ancestor some time in the early (80 kybp - 65 kybp) to mid-Wisconsinan (65 kybp - 23 kybp) period of glaciation. Claiming much more chronological precision based on a single genetic locus would probably be erroneous.

4.4) The difference between gene trees and population trees, and the implications to the phylogeny of woodland and barrenground caribou.

When an evolutionary tree is based on the lineage of a gene or a stretch of DNA, the alleles themselves (or the haplotypes in the case of mtDNA) act as operational taxonomic units. However, the real evolutionary tree of one or more

taxa is based on the lineages of population groups, in which case the populations or species act as operational taxonomic units (Avice 1989). The lineage of a population or species represents the compilation of many gene lineages, and for this reason it is expected that many different gene trees could be found to represent a single population tree. Avice (1989) suggests four reasons why a gene tree may be different than a population tree: 1) too small a number of nucleotides sampled, 2) differences in evolutionary rate across gene or organismal lineages, 3) random or unpredictable sorting of allele lineages from ancestral to daughter populations, and 4) hybridization which involves the transfer of genetic material between lineages. While the first problem is one of sample error, the last three are known to have occurred in the phylogenetic history of many species or populations (Avice 1989).

Sample error may have been a problem in this study. Because of the intraspecific nature of the study, the quickly evolving mtDNA control region (~1,100 nt) was the focus of sequence and restriction digest analysis. However, it has been shown that in order to reconstruct a reliable tree of humans and apes, about 2,600 nt should be examined (Saitou & Nei 1986). Considering that 2,600 nt was calculated as needed for the analysis of inter-family relationships, the number of nt required is probably lower for the intra-specific relationships analyzed in this study. A more important source of discord between the woodland and barrenground caribou population tree and the gene tree(s) reconstructed in this study, is that the source of the gene tree was a single genetic locus (as suggested in the previous section on estimated time of divergence). To significantly increase the probability of reconstructing the correct population tree from gene lineages, the number of loci (which have evolved independently) used in analysis must be increased (Pamilo & Nei 1988).

Although it is not known what the relative evolutionary rates of the mtDNA control region are in woodland and barrenground caribou, based on genetic distances shown in NJ trees, the southern mtDNA clade is more derived than the northern mtDNA clade. This may be an artifact of the choice of outgroups as discussed in section 4.1. However, excluding the choice of outgroups, one explanation for the seemingly ancestral state of the northern clades is that the southern clade has a higher rate of sequence evolution, or in other words, a slightly faster molecular clock. Another explanation, however, is Avice's (1989) third reason for disagreement between gene trees and population trees, which is lineage sorting. A combination of the matrilineal nature of mitochondrial inheritance and the random sorting of mitochondria in the resulting lineages may often lead to the

extinction of mitochondrial lineages or haplotypes. In other words, after many generations a clade may be mitochondrially monophyletic, but when lineage sorting is taken into account, it can not be concluded that the monophyletic clade must all be descendent from a single maternal source (Avice *et al.* 1984). This has two implications for the phylogenetics of woodland and barren-ground caribou. The first is that what seems like a relatively high rate of mitochondrial evolution in the southern mtDNA clade, may instead be explained by a relatively high rate of mitochondrial lineage extinction in the same clade. Extinction of ancestral mitochondrial lineages may have been the result of random lineage sorting, or may have been the result of unusual selective forces acting on the ancestors of woodland caribou while they were forced into southern glacial refugia.

Another consequence of lineage sorting is if a species is young or has expanded since its origin, as caribou did post-glacially, it is likely that some modern mtDNA lineages predate the expansion and separation of the ancestral population (Wiley 1981). The result is a population with a common ancestor, but based on mtDNA appears to be paraphyletic relative to a different monophyletic group. An example of this has been found in two species of deer mouse (Avice *et al.* 1983). This could explain why the northern mtDNA clade of caribou was found to be paraphyletic relative to the monophyletic southern mtDNA clade in certain weighting schemes. If so, it implies that paralogy in the northern clade does not exclude a common ancestor for all caribou belonging to the northern mtDNA clade.

The final reason suggested by Avice (1989) for disagreement between gene trees and a population tree is introgression. In the study of a species complex of passerine birds in Australia, past introgression is blamed for the unusual gene tree produced by mtDNA relative to trees produced by nuclear loci and morphological data (Degnan 1993). Two problems are associated with mtDNA gene trees in groups that have introgressed genetically. The first is that since mtDNA is inherited maternally, any mtDNA gene tree must be interpreted as one representing female lineages only, and that past or present introgression may be sex-specific for each group which contributes genetic material. In the case of the caribou mtDNA gene tree, it seems highly unlikely that only males or only females of either mtDNA clade dispersed alone into deglaciated regions of the Yukon or Cordilleran. Therefore, sex-specific dispersal and introgression have probably not contributed greatly to the geographic patterns of mtDNA lineages in woodland and barren-ground caribou.

The second problem associated with mtDNA gene trees in groups that have introgressed genetically is that while mtDNA retains a record of introgression --

possibly even if such events have been rare -- recombination in nuclear genes usually erases such a record. In interpreting the mtDNA gene tree of woodland and barren-ground caribou, this "memory" of mtDNA was taken into account. For instance, it was not concluded that British Columbia's mountain caribou populations are in fact pockets of woodland caribou, interspersed with pockets of barren-ground caribou.

4.5) The relationship of caribou to the outgroups, elk and white-tailed deer.

Phylogenetic trees reconstructed using NJ (Figures 31 and 32) show elk to be more closely related than white-tailed deer to caribou, which disagrees with classifications based on molecular (Polziehn & Strobeck in press) and morphological data (Groves & Grubb 1982). In the case of an intraspecific study, a phylogeny can only be estimated from a rapidly evolving region of the genome such as the mtDNA control region. Because the same region is also evolving rapidly in the outgroup, a derived character state unique to the outgroup (an autapomorphy) may appear as a derived character state shared by individuals of the ingroup (a synapomorphy) (Routman *et al.* 1994). Probably of even more importance to the conclusions of this study are problems created by analyzing the outgroup with a phylogenetic inference method chosen to be appropriate for finding relationships within the ingroup. For example, PAUP is unable to directly weight transitions differently than transversions. Instead, the user must find transitions and transversions in the sequences, then instruct PAUP to weight those character sites differentially. In the case of caribou, elk, and white-tailed deer, sites which had transversions among caribou often did not between caribou, elk, and white-tailed deer. Similarly, many character sites which were part of long sequences of alignment gaps in the outgroups were phylogenetically informative among caribou. To have reconstructed a reasonably good inter-specific phylogenetic tree, large sections of poorly aligned sequence along with insertions and deletions should have been excluded from analysis. However, the value of many such sites to reconstruct the intra-specific phylogenetic tree of caribou was too great to be sacrificed for accurate analysis of outgroup relationships.

4.6) Caribou's relationship to reindeer.

The two reindeer sequenced were found to group within the northern mtDNA clade, and they did not group closely together within the clade. In a study

using DNA sequencing and restriction digests of mt and nuclear DNA, reindeer were found to be distinct from Grant's and barrenground caribou which grouped together (Cronin *et al.* 1995.), thus reindeer would have been expected to at least group together within the northern mtDNA clade in this study. The first explanation for this result is that the sequenced reindeer are hybrids of reindeer and barrenground caribou. Although female reindeer have been deliberately bred with wild male woodland caribou in a United States Department of Agriculture project in 1925 (Stern *et al.* 1980), there is currently little genetic evidence for introgression of reindeer and Grant's caribou in Alaska (Cronin *et al.* 1995).

A second explanation for the position of reindeer within the northern mtDNA clade is that barrenground caribou and reindeer share a recent common ancestor, and have not yet developed further genetic substructuring. Because the Bering land bridge connected Eurasia and North America until about 14 or 15 kybp (Hopkins 1982), the common ancestor would have to be no older than this. In a study of genetic variation in transferrin (Roed *et al.* 1991), reindeer grouped very closely to Grant's caribou, and barrenground caribou grouped more closely to reindeer and Grant's caribou than to woodland caribou. However, even if this were the case, reindeer would still be expected to group together within the northern mtDNA clade.

4.7) An explanation for the lack of phylogenetic resolution or population genetic substructuring within caribou subspecies.

Results suggest very little population genetic substructuring within caribou subspecies. This may be the case in reality, however, methodological reasons for the finding will be discussed first. DNA sequencing is not typically used for studies of population substructure for several reasons, the most important of which is that molecular markers with a more fine scale resolution, such as microsatellites, are often required (Hillis *et al.* 1996). As stated earlier, microsatellite analysis has been used successfully to distinguish between three herds of Yukon woodland caribou (Zittlau *et al.* in press). Although restriction digests were used in my study, they were designed for the purpose of distinguishing large scale phylogenetic clades, and for this reason were not able to find more detailed population structure.

Although there is almost certainly more population genetic substructure among woodland and barrenground caribou than revealed by this study, there may also be ecological and historical factors that contribute to a real lack of genetic substructure within the subspecies studied. Woodland caribou range throughout a

relatively uniform habitat of boreal forest (Elliott-Fisk 1988), and barrenground caribou migrate annually from boreal forest, to low arctic tundra, and sometimes to high arctic tundra (Kelsall 1968). In addition to this lack of habitat specialization, caribou are also known to forage on a wide variety of fungi, lichens, mosses, and plants throughout their ranges (Kelsall 1968). With the exception of the mountain woodland caribou in southern British Columbia which feed almost exclusively on arboreal lichens in the winter (Stevenson 1991), on a broad geographic level, population substructure within caribou subspecies should not be expected based on ecological factors. Furthermore, caribou are well suited for long distance dispersal, and barrenground caribou are known -- even in relatively large numbers -- to travel from one herd to another (Kelsall 1968). This may further explain the lack of structure within the northern mtDNA clade.

Along with ecological factors, two historical factors (discussed in relation to gene trees in section 4.4) may contribute to the lack of genetic structure within woodland and barrenground caribou. Young species or subspecies, as barrenground and woodland caribou are believed to be, are generally not known to display geographic variation because such variation has not yet evolved (Zink 1996). In addition, species which have recently expanded their range, as caribou did post-glacially, are usually found to exhibit little mtDNA differentiation (Gill *et al.* 1993).

4.8) Caribou and comparative phylogeography of arctic animals.

Vicariance events, such as the Wisconsinan glaciation, are known to have influenced phylogeographic patterns in many species. By comparing the phylogeographic patterns of several species, a better understanding can be gained of a vicariance event, and of the event's impact on the geographic population structure of a wide variety of taxa in the region of interest. The only prerequisite for comparing taxa is that they are currently codistributed (Zink 1996).

Very few genetic studies of wide ranging arctic and boreal North American animals exist. Fewer still are of animals which are thought to have dispersed into previously glaciated regions from ice-free refugia after the last ice age (the Wisconsinan). One such study on whitefish found samples from almost all of Canada to be of the same mtDNA clade which was thought to have originated south of the ice-sheets (Bernatchez & Dodson 1994). The one exception was in the Mackenzie delta region of the Northwest Territories, where haplotypes of a Eurasian/Alaskan clade were found. This clade is thought to have originated in

Eurasia. There seems to be little concordance between the phylogeography of whitefish and of caribou. A study of masked shrews (Stewart & Baker 1997) found the geographic distribution of mtDNA clades to fit a hypothesis of isolation during the Wisconsinan in ice-free refugia, however, a time of divergence between clades of about 0.5 mybp seems to place the study beyond the realm of comparison to woodland and barren-ground caribou.

Phylogeographic patterns of a wider variety of arctic and subarctic animals have been studied using morphological data. The masked shrew, along with arctic hare, varying lemming, ermine, ground squirrel, brown lemming, red-backed vole, and caribou are all thought to have been isolated both in Beringia and south of the ice-sheets during the Wisconsinan glacial period, and all of these taxa are included in a study by MacPherson (1965). Table 3 shows a comparative analysis of these eight taxa, comparing the phylogeographic pattern of woodland and barren-ground caribou to phylogeographic patterns of seven other taxa. It is evident that caribou followed similar dispersal patterns as other mammals post-glacially, however, the dispersal of Beringian caribou into the Cordilleran region is unusual. Only the ground squirrel similarly dispersed from Beringia into the Cordilleran, but the Beringian ground squirrel did not disperse as far south as did the Beringian caribou. Aside from caribou, the largest mammal studied by MacPherson (1965) which is thought to have survived the Wisconsinan in both Beringian and southern periglacial refugia, is the arctic hare. Indeed, caribou, muskox, and possibly elk are the only large extant herbivores thought to have survived the Wisconsinan both in Beringia and south of the ice sheets (Kurten & Anderson). However, because neither muskox nor elk are widely co-distributed with modern caribou (Banfield 1981) neither species is suitable for inclusion in the present analysis of comparative phylogeography.

4.9) Taxonomic implications and practical applications.

MtDNA clades support the subspecific status of woodland and barren-ground caribou. In a variety of cervids, intraspecific mtDNA sequence divergences are less than 3%, while interspecific divergences within subfamilies are 4 to 12% (Cronin 1991). Sequence divergence between the two mtDNA clades in woodland and barren-ground caribou was found to be well within the upper range of 3% for intraspecific divergence in cervids. It should be noted that mtDNA sequence divergences as low as 0.17% have been found between good biological species of rainbow smelt (Taylor & Bentzen 1993). Thus, evidence that woodland

and barrenground caribou maintain distinct gene pools in sympatry would support raising the taxonomy of the two subspecies to the specific level, however, restriction digest results from Kaminuriak/Churchill seem to suggest otherwise.

As mentioned in the "Introduction" section, formalized taxonomy is important in our understanding of biological diversity, which makes it critical to conservation biology. Taxonomic inaccuracy has led to "splitting" of genetically indistinct species of sparrows (Avice & Nelson 1989), and to "lumping" of three genetically distinct species of tuatara (Daugherty *et al.* 1990). While woodland and barrenground subspecies of caribou are in no danger of being "lumped" together, diagnostic restriction digests suggest a clinal pattern including four (or five) genetic subdivisions of woodland caribou which correspond to Banfield's woodland demes (1961) but are often not recognized, including the Yukon woodland herds, the mountain woodland herds of British Columbia and Alberta, the boreal woodland herds, and the woodland herds of Labrador and northern Quebec. The possible fifth subdivision is the insular Newfoundland herds which would otherwise be grouped with other boreal woodland herds. Although the unit of caribou management is typically on the scale of a herd or group of associated herds, the genetically unique nature of both mountain woodland herds and Yukon herds should be considered along with any unique ecotypes when determining risk status and management plans on a scale larger than herds. Considering the genetic history of Yukon and mountain woodland herds, their classification as *R.t. caribou* should be reconsidered.

4.10) Summary of conclusions.

Within the woodland and barrenground subspecies of caribou, two mtDNA clades were found. Barrenground caribou were almost entirely comprised of the first mitochondrial clade. Reindeer, woodland caribou from Yukon, and some woodland caribou from British Columbia, northern Labrador, and Quebec's Ungava peninsula were found to belong to the same mitochondrial clade as barrenground caribou. The remaining woodland caribou comprised the second mitochondrial clade. This suggests that the classification of Yukon and mountain woodland caribou should be reconsidered. In phylogenetic analysis, the southern clade was found to be monophyletic, and the northern clade was found to be either monophyletic or paraphyletic relative to the southern clade depending on analysis conditions. Paraphyly in the northern clade can be explained by events in the evolutionary history of the northern clade, by inherent differences between

evolutionary trees that reconstruct the lineage of a gene versus those that reconstruct the lineage of a population or species, or by the choice of outgroups.

Neither mtDNA sequencing nor diagnostic restriction digests developed for identifying the geographic pattern of mtDNA clades were able to identify population substructure within barren-ground caribou. However, some evidence for a clinal pattern of mtDNA was found in the woodland caribou. The pattern was similar to one based on skull morphology of male caribou as described by Banfield (1961). One of the greatest benefits of using diagnostic restriction digests in this study was their ability to identify geographic regions of current or historical introgression between northern and southern mtDNA clade caribou. Zones of gene transfer between the mitochondrial clades included Labrador and northern Quebec, northern Manitoba, and the Cordilleran region. While northern Manitoba and Labrador/northern Quebec may represent regions of either current or historical dispersal followed by introgression, the flow of northern clade mitochondria far south into British Columbia is best explained by historical southward dispersal of Beringian caribou after the Wisconsinan glacial period.

The geographic ranges of mtDNA lineages in woodland and barren-ground caribou suggest that lineages were formed in Wisconsinan glacial refugia in Beringia and south of the ice-sheets. This conclusion is supported by comparing the phylogeography of caribou to several other arctic mammals which are believed to have been isolated in the same refugia as caribou during the Wisconsinan glaciation. Based on differences in mtDNA sequence, the age of divergence of the northern and southern mtDNA clades was estimated to be about 49 kybp with a 95% confidence interval ranging from 22 kybp to 76 kybp, placing the isolation of the two clades at some point in the mid to late Wisconsinan.

5) Literature cited

- Anderson, S., de Bruijn, M.H.S., Coulson, A.R., Eperon, I.C., Sanger, F., and Young, I.G. 1982. Complete sequence of bovine mitochondrial DNA: conserved features of the mammalian mitochondrial genome. *J. Mol. Biol.* 156:683-717.
- Avise, J.C. 1989. Gene trees and organismal histories: a phylogenetic approach to population biology. *Evolution* 43:1192-1208.
- Avise, J.C. 1992. Molecular population structure and the biogeographic history of a regional fauna: a case history with lessons for conservation biology. *Oikos* 63:62-76.
- Avise, J.C., Arnold, J., Ball, R.M., Bermingham, E., Lamb, T., Neigel, J.E., Reeb, C.A., and Saunders, N.C. 1987. Intraspecific phylogeography: the mitochondrial DNA bridge between population genetics and systematics. *Ann. Rev. Ecol. Syst.* 18:489-522.
- Avise, J.C., Giblin-Davidson, G., Laerm, J., Patton, J.C., and Lansman, R.A. 1979. Mitochondrial DNA clones and matriarchal phylogeny within and among geographic populations of the pocket gopher, *Geomys pinetis*. *Proc. Natl. Acad. Sci. USA* 76:6694-6698.
- Avise, J.C., Neigel, J.E., and Arnold, J. 1984. Demographic influences on mitochondrial DNA lineage survivorship in animal populations. *J. Mol. Evol.* 20:99-105.
- Avise, J.C., and Nelson, W.C. 1989. Molecular genetic relationships of the extinct dusky seaside sparrow. *Science* 243:646-648.
- Avise, J.C., Shapira, J.F., Daniel, S.W., Aquadro, C.F. and Lansman, R.A. 1983. Mitochondrial DNA differentiation during the speciation process in *Peromyscus*. *Mol. Biol. Evol.* 1:38-56.

- Ausubel, F.M., Brent, R., Kingston, R.E., Moore, D.D., Seidman, J.G., Smith, J.A., and Struhl, K., eds. 1994. *Current Protocols in Molecular Biology*. Greene Publishing Associates and John Wiley & Sons, New York.
- Banfield, A.W.F. 1961. A revision of the reindeer and caribou, genus *Rangifer*. *Bull. Natl. Mus. Can., Biol. Ser. No. 66*.
- Banfield, A.W.F. 1981. *The mammals of Canada*. National Museum of Natural Sciences, National Museums of Canada. University of Toronto Press, Toronto.
- Bermingham, E., Rohwer, S., Freeman, S., and Wood, C. 1992. Vicariance biogeography in the Pleistocene and speciation in North American wood warblers: a test of Mengel's model. *Proc. Natl. Acad. Sci. USA* 89:6624-6628.
- Bernatchez, L., and Dodson, J.J. 1994. Phylogenetic relationships among Palearctic and Nearctic whitefish (*Coregonus* sp.) populations as revealed by mitochondrial DNA variation. *Can. J. Fish. Aquat. Sci.* 51 (Suppl. 1):240-251.
- Bremer, K. 1988. The limits of amino acid sequence data in angiosperm phylogenetic reconstruction. *Evolution* 42:795-803.
- Brown, W.M. 1985. The mitochondrial genome of animals, in MacIntyre, R.J., ed., *Molecular evolutionary genetics*. Plenum, N.Y. pp.95-130.
- Brown, W.M., George, M. Jr., and Wilson, A.C. 1979. Rapid evolution of animal mitochondrial DNA. *Proc. Nat. Acad. Sci. USA* 76:1967-1971.
- Burns, J.A. 1996. Vertebrate paleontology and the alleged ice-free corridor: the meat of the matter, in Mandryk, C.A.S., and Rutter, N., *The ice free corridor revisited*. *Quat. Internatl.* 32:107-112.

- Byun, S.A., Koop, B.F., and Reimchen, T.E. 1997. Black bear mtDNA phylogeography and Haida Gwaii glacial refugium controversy. *Evolution* 51:1647-1653.
- Cann, R.L., Stoneking, M., and Wilson, A.C. 1987. Mitochondrial DNA and human evolution. *Nature* 325:31-36.
- Catto, N.R. 1996. Richardson mountains, Yukon-Northwest Territories: the northern portal of the postulate 'ice-free corridor', *in* Mandryk, C.A.S., and Rutter, N., The ice free corridor revisited. *Quat. Internatl.* 32:3-19.
- Clark, P.U. 1992. The last interglacial-glacial transition in North America: introduction, *in* Clark, P.U., and Lea, P.D., eds., The last interglacial-glacial transition in North America: Boulder, Colorado, Geological Society of America Special Paper 270., pp. 1-12.
- Compton, B.B., Zager, P., and Servheen, G. 1995. Survival and mortality of translocated woodland caribou. *Wildl. Soc. Bull.* 23:490-496.
- COSEWIC. 1998. List of Canadian species at risk, April 1998. Committee on the Status of Endangered Wildlife in Canada.
- Cronin, M.A. 1991. Mitochondrial-DNA phylogeny of deer (Cervidae). *J. Mamm.* 72:533-566.
- Cronin, M.A. 1992. Intraspecific variation in mitochondrial DNA of North American cervids. *J. Mamm.* 73:70-82.
- Cronin, M.A., Nelson, M.E., and Pac, D.F. 1991. Spatial heterogeneity of mitochondrial DNA and allozymes among populations of white-tailed deer and mule deer. *J. Heredity* 82:118-127.
- Cronin, M.A., Renecker, L., Pierson, B.J., and Patton, J.C. 1995. Genetic variation in domestic reindeer and wild caribou in Alaska. *Anim. Genet.* 26:427-434.

- Cumming, H.G. 1998. Status of woodland caribou in Ontario: 1996. *Rangifer*, Special Issue No.10:99-104.
- Daugherty, C.H., Cree, A., Hay, J.M., & Thompson, M.B. 1990. Selected taxonomy and continuing extinctions of tuatara (*Sphenodon*). *Nature* 347:177-179.
- Degnan, S.M. 1993. The perils of single gene trees - mitochondrial versus single-copy nuclear DNA variation in white-eyes (Aves: Zosteropidae). *Mol. Ecol.* 2:219-225.
- Douzery, E., and Randi, E. 1997. The mitochondrial control region of Cervidae: evolutionary patterns and phylogenetic content. *Mol. Biol. Evol.* 14:1154-1166.
- Duk-Rodkin, A., and Hughes, O.L. 1991. Age relationships of Laurentide and montane glaciations, Mackenzie mountains, Northwest Territories. *Geog. Phys. et Quat.* 45:79-90.
- Edmonds, E.J. 1988. Population status, distribution, and movements of woodland caribou in west central Alberta. *Can.J. Zool.* 66:817-826.
- Eger, J.L. 1990. Patterns of geographic variation in the skull of nearctic ermine (*Mustela erminea*). *Can. J. Zool.* 68:1241-1249.
- Eger, J.L. 1995. Morphometric variation in the nearctic collared lemming (*Dicrostonyx*). *J. Zool. Lond.* 235:143-161.
- Elliott-Fisk, D.L. 1988. The boreal forest, *in* Barbour, M.G., and Billings, W.D., eds., North American terrestrial vegetation, Cambridge University Press, New York. pp. 33-62.
- Farnell, R., Florkiewicz, R., Kuzyk, G., and Egli, K. 1998. The status of *Rangifer tarandus caribou* in Yukon, Canada. *Rangifer*, Special Issue No.10.

- Felsenstein, J. 1995. PHYLIP (phylogeny inference package). Version 3.572c. Department of Genetics, University of Washington, Seattle.
- George, M.Jr., and Ryder, O.A. 1986. Mitochondrial DNA evolution in the genus *Equus*. *Mol. Biol. Evol.* 3:535-546.
- Gill, F.B., Mostrom, A.M., and Mack, A.L. 1993. Speciation in North American chickadees: I. Patterns of mtDNA genetic divergence. *Evolution* 47:195-212.
- Goldthwait, R.P. 1992. Historical overview of early Wisconsin glaciation, *in* Clark, P.U. and Lea, P.D. eds., *The last interglacial-glacial transition in North America*. Geological Society of America Special Paper 270., pp. 13-18.
- Greenberg, B.D., Newbold, J.E., and Sugino, W. 1983. Intraspecific nucleotide sequence variability surrounding the origin of replication in human mitochondrial DNA. *Gene* 21:33-49.
- Groves, C.P., and Grubb, P. 1982. Relationships of living deer, *in* Wemmer, C.M. ed., *Biology and management of the Cervidae*. Smithsonian Institution Press. Washington, D.C., pp. 21-59.
- Heard, D.C., and Ouellet, J. 1994. Dynamics of an introduced caribou population. *Arctic* 47:88-95.
- Heard, D.C., and Vagt, K.L. 1998. Caribou in British Columbia: a 1996 status report. *Rangifer*, Special Issue No. 10.
- Hervieux, D., Edmonds, J., Bonar, R., and McCammon, J. 1996. Successful and unsuccessful attempts to resolve caribou management and timber harvesting issues in west central Alberta. *Rangifer*, Special Issue No.9:185-190.
- Hillis, D.M., and Bull, J.J. 1993. An empirical test of bootstrapping as a method for assessing confidence in phylogenetic analysis. *Syst. Biol.* 42:182-192.

- Hillis, D.M., Mable, B.K., and Moritz, C. 1996. Applications of molecular systematics: the state of the field and a look to the future, *in* Hillis, D., Moritz, C., and Mable, B.K. eds., *Molecular systematics*. Sinauer Associates, Inc. Sunderland, MA., pp. 515-543.
- Hoffmann, R.S. 1981. Different voles for different holes: environmental restrictions on refugial survival of mammals, *in* Scudder, G.G.E. and Reveal, J.L. eds., *Evolution today, Proceedings of the second international congress of systematic and evolutionary biology*, pp. 25-45.
- Hopkins, D.M. 1982. Aspects of the paleogeography of Beringia during the late Pleistocene, *in* Hopkins, D.M., Matthews, J.V.Jr., Schweger, C.E., and Young, S.B. eds., *Paleoecology of Beringia*. Academic Press, Inc., New York., pp. 3-28.
- Jackson, L.E., Phillips, F.M., Shimamura, K., and Little, E.C. 1997. Cosmogenic ^{36}Cl dating of the Foothills erratics train, Alberta, Canada. *Geology* 25:195-198.
- James, F.C. 1983. Environmental component of morphological differences in birds. *Science* 221: 184-187.
- Johnson, L.A., and Soltis, D.E. 1994. *matK* DNA sequences and phylogenetic reconstruction in Saxifragaceae sensu stricto. *Syst. Bot.* 19:143-156.
- Kelsall, J.P. 1968. The migratory barren-ground caribou of Canada. Department of Indian Affairs and Northern Development, Ottawa, Ont.
- Kimura, M. 1980. A simple model for estimating evolutionary rates of base substitutions through comparative studies of nucleotide sequences. *J. Mol. Evol.* 16:111-120.
- Kocher, T.D., Thomas, W.K., Meyer, A., Edwards, S.V., Paabo, S., and Villablanca, F.X. 1989. Dynamics of mitochondrial DNA evolution in animals: amplification and sequencing with conserved primers. *Proc. Nat. Acad. Sci.* 86:6196-6200.

- Kurten, B., and Anderson, E. 1980. Pleistocene mammals of North America. Columbia Univ. Press. New York.
- Kushney, J.E.E., Coffin, J.W., and Strobeck, C. 1996. Genetic survey of caribou populations using microsatellite DNA. *Rangifer*, Special Issue No. 9:351-354.
- MacPherson, A.H. 1965. The origin of diversity in mammals of the Canadian arctic tundra. *Syst. Zool.* 14:153-173.
- Madsen, C.S., Ghivizzani, S.C., and Hauswirth, W.M. 1993. Protein binding to a single termination-associated sequence in the mitochondrial DNA D-loop region. *Mol. Cell. Biol.* 13:2162-2171.
- Mallory, F.F., and Hillis, T.L. 1998. Demographic characteristics of circumpolar caribou populations: ecotypes, ecological constraints, releases, and population dynamics. *Rangifer*, Special Issue No. 10:49-60.
- Mandryk, C.A. 1990. Could humans survive the ice-free corridor? Late-glacial vegetation and climate *in* west central Alberta, in Agenbroad, L.D., Mead, J.I., and Nelson, L.W. eds., *Megafauna & man; discovery of America's heartland*, pp.67-79.
- Martin, A.P., and Palumbi, S.R. 1993. Body size, metabolic rate, generation time, and the molecular clock. *Proc. Natl. Acad. Sci. USA* 90:4087-4091.
- Mullis, K.B., and Faloona, F.A. 1987. Specific synthesis of DNA *in vitro* via a polymerase catalyzed chain reaction. *Meth. Enzymol.* 155:335-350.
- Murray, V. 1989. Improved double-stranded DNA sequencing using the linear polymerase chain reaction. *Nucl. Acids Res.* 17:8889.
- Nei, M. and Tajima, F. 1981. DNA polymorphism detectable by restriction endonucleases. *Genetics* 97:145-163.

- Neitzel, H. 1987. Chromosome evolution of Cervidae: karyotypic and molecular aspects, *in* Obe, G., and Basler, A., eds., *Cytogenetics*. Berlin: Springer-Verlag, pp.90-112.
- O'Brien, S.J. 1994. A role for molecular genetics in biological conservation. *Proc. Natl. Acad. Sci. USA*. 91:5748-5755.
- O'Brien, S.J., Roelke, M.E., Yuhki, N., Richards, K.W., Johnson, W.E., Franklin, W.L., Anderson, A.E., Bass, O.L., Belden, R.C., and Martenson, J.S. 1990. Genetic introgression within the Florida Panther *Felis concolor coryi*. *Natl. Geogr. Res.* 6:486-494.
- Paetkau, D., and Strobeck, C. 1996. Mitochondrial DNA and the phylogeography of Newfoundland black bears. *Can. J. Zool.* 74:192-196.
- Pamilo, P., and Nei, M. 1988. Relationships between gene trees and species trees. *Mol. Biol. Evol.* 5:568-583.
- Parker, G.R. 1975. An investigation of caribou range on Southampton Island, Northwest Territories. Canadian Wildlife Service Report Series No. 33.
- Peteet, D., Rind, D., and Kukla, G. 1992. Wisconsinan ice-sheet initiation: Milankovitch forcing, paleoclimatic data, and global climate modeling, *in* Clark, P.U., and Lea, P.D., eds., *The last interglacial-glacial transition in North America: Boulder, Colorado, Geological Society of America Special Paper 270.*, pp. 53-70.
- Polziehn, R.O., Beech, R., Sheraton, J., and Strobeck, C. 1996. Genetic relationships among North American bison populations. *Can. J. Zool.* 74:738-749.
- Polziehn, R.O., and Strobeck, C. in press. Phylogeny of wapiti, red deer, sika deer, and other North American cervids as determined from mitochondrial DNA sequencing. *Mol. Phyl. Evol.*

- Rettie, J., Rock, T., and Messier, F. 1998. Status of woodland caribou in Saskatchewan. *Rangifer*, Special Issue No.10:105-109.
- Riddle, B.R., and Honeycutt, R.L. 1990. Historical biogeography in North American arid regions: an approach using mitochondrial-DNA phylogeny in grasshopper mice (Genus *Onychomys*). *Evolution* 44:1-15.
- Roed, K.H. 1985a. Genetic differences at the transferrin locus in Norwegian semi-domestic and wild reindeer (*Rangifer tarandus* L.). *Hereditas* 102:199-206.
- Roed, K.H. 1985b. Comparison of the genetic variation in Svalbard and Norwegian reindeer. *Can. J. Zool.* 63:2038-2042.
- Roed, K.H. 1987. Transferrin variation and body size in reindeer, *Rangifer tarandus* L. *Hereditas* 106:67-71.
- Roed, K.H., Ferguson, M.A.D., Crete, M., and Bergerud, T.A. 1991. Genetic variation in transferrin as a predictor for differentiation and evolution of caribou from eastern Canada. *Rangifer* 11:65-74.
- Roed, K.H., Staaland, H., Broughton, E., and Thomas, D.C. 1986. Transferrin variation in caribou (*Rangifer tarandus* L.) on the Canadian Arctic islands. *Can. J. Zool.* 64:94-98.
- Roed, K.H., and Thomas, D.C. 1990. Transferrin variation and evolution of Canadian barren-ground caribou. *Rangifer*, Special Issue No. 3:385-389.
- Roed, K.H., and Whitten, K.R. 1986. Transferrin variation and evolution of Alaskan reindeer and caribou, *Rangifer tarandus* L. *Rangifer*, Special Issue No. 1:247-251.
- Routman, E., Rosalind, W., and Templeton, A.R. 1994. Parsimony, molecular evolution, and biogeography: the case of the North American giant salamander. *Evolution* 48:1799-1809.

- Rutter, N.W. 1980. Late Pleistocene history of the western Canadian ice-free corridor, *in* Rutter, N.W., and Schweger, C.E., eds. The ice-free corridor and peopling of the new world, *Can. J. Anthropol.* 1:1-8.
- Saccone, C., Pesole, G., and Sbisà, E. 1991. The main regulatory region of mammalian mitochondrial DNA: structure-function model and evolutionary pattern. *J. Mol. Evol.* 33:83-91.
- Saitou, N., and Nei, M. 1986. The number of nucleotides required to determine the branching order of three species with special reference to the human-chimpanzee-gorilla divergence. *J. Mol. Evol.* 24:189-204.
- Saitou, N., and Nei, M. 1987. The neighbor-joining method: a new method for reconstructing phylogenetic trees. *Mol. Biol. Evol.* 4:406-425.
- Stern, R.O., Arobio, E.L., Naylor, L.L., and Thomas, W.C. 1980. Eskimos, reindeer and land. Agricultural experiment station, School of agriculture and land resources management, University of Alaska, Fairbanks.
- Stevenson, S.K. 1991. Forestry and caribou in British Columbia. *Rangifer*, Special Issue No.7:124-129.
- Stewart, C. 1993. The powers and pitfalls of parsimony. *Nature* 361:603-607.
- Stewart, D.T., and Baker, A.J. 1997. A phylogeny of some taxa of masked shrews (*Sorex cinereus*) based on mitochondrial-DNA, D-loop sequences. *J. Mamm.* 78:361-376.
- Stoneking, M., Sherry, S.T., Redd, A.J., and Vigilant, L. 1992. New approaches to dating suggest a recent age for the human mtDNA ancestor. *Philos. Trans. R. Soc. London B* 337:167-175.
- Swofford, D.L. 1993. PAUP: Phylogenetic Analysis Using Parsimony, Version 3.1. Computer program distributed by the Illinois Natural History Survey, Champaign, Illinois.

- Taylor, E.B., and Bentzen, P. 1983. Evidence for multiple origins and sympatric divergence of trophic ecotypes of smelt (*Osmerus*) in northeastern North America. *Evolution* 47:813-832.
- Thomas, W.K., Paabo, S., Villablanca, F.X., and Wilson, A.C. 1990. Spatial and temporal continuity of kangaroo rat populations shown by sequencing mitochondrial DNA from museum specimens. *J. Mol. Evol.* 31:101-112.
- van Staaden, M.J., Hamilton, M.J., and Chesser, R.K. 1995. Genetic variation of woodland caribou (*Rangifer tarandus*) in North America. *Z. Saugetierkunde* 60:150-158.
- Vincent, J. 1992. The Sangamonian and early Wisconsinan glacial record in the western Canadian arctic, *in* Clark, P.U., and Lea, P.D., eds., *The last interglacial-glacial transition in North America: Boulder, Colorado*, Geological Society of America Special Paper 270., pp. 233-252.
- Warren, C.D. Peek, J.M., Servheen, G.L., and Zager, P. 1996. Habitat use and movements of two ecotypes of translocated caribou in Idaho and British Columbia. *Conserv. Biol.* 10:547-553.
- Wayne, R.K., and Jenks, S.M. 1991. Mitochondrial DNA analysis implying extensive hybridization of the endangered red wolf *Canis rufus*. *Nature* 351:565-567.
- Wenink, P.W., Baker, A.J., Rosner, H., and Tilanus, M.G.J. 1996. Global mitochondrial DNA phylogeography of holarctic breeding dunlins (*Calidris alpina*). *Evolution* 50:318-330.
- Wiley, E.O. 1981. *Systematics: the theory and practice of phylogenetic systematics*. John Wiley and Sons, New York.
- Williams, T.M., and Heard, D.C. 1986. World status of wild *Rangifer tarandus* populations. *Rangifer*, Special Issue No. 1:19-28.

- Wilson, G.A., Strobeck, C., Wu, L., and Coffin, J.W. 1997. Characterization of microsatellite loci in caribou *Rangifer tarandus*, and their use in other Artiodactyls. *Mol. Ecol.* 6:697-699.
- Wooding, S., and Ward, R. 1997. Phylogeography and Pleistocene evolution in the North American black bear. *Mol. Biol. Evol.* 14:1096-1105.
- Zink, R.M. 1996. Comparative phylogeography in North American birds. *Evolution* 50:308-317.
- Zittlau, K., Coffin, J., Farnell, R., Kuzyk, G., and Strobeck, C. in press. Determination of the genetic relationships between Yukon woodland caribou herds by DNA typing using microsatellites. *Rangifer*.

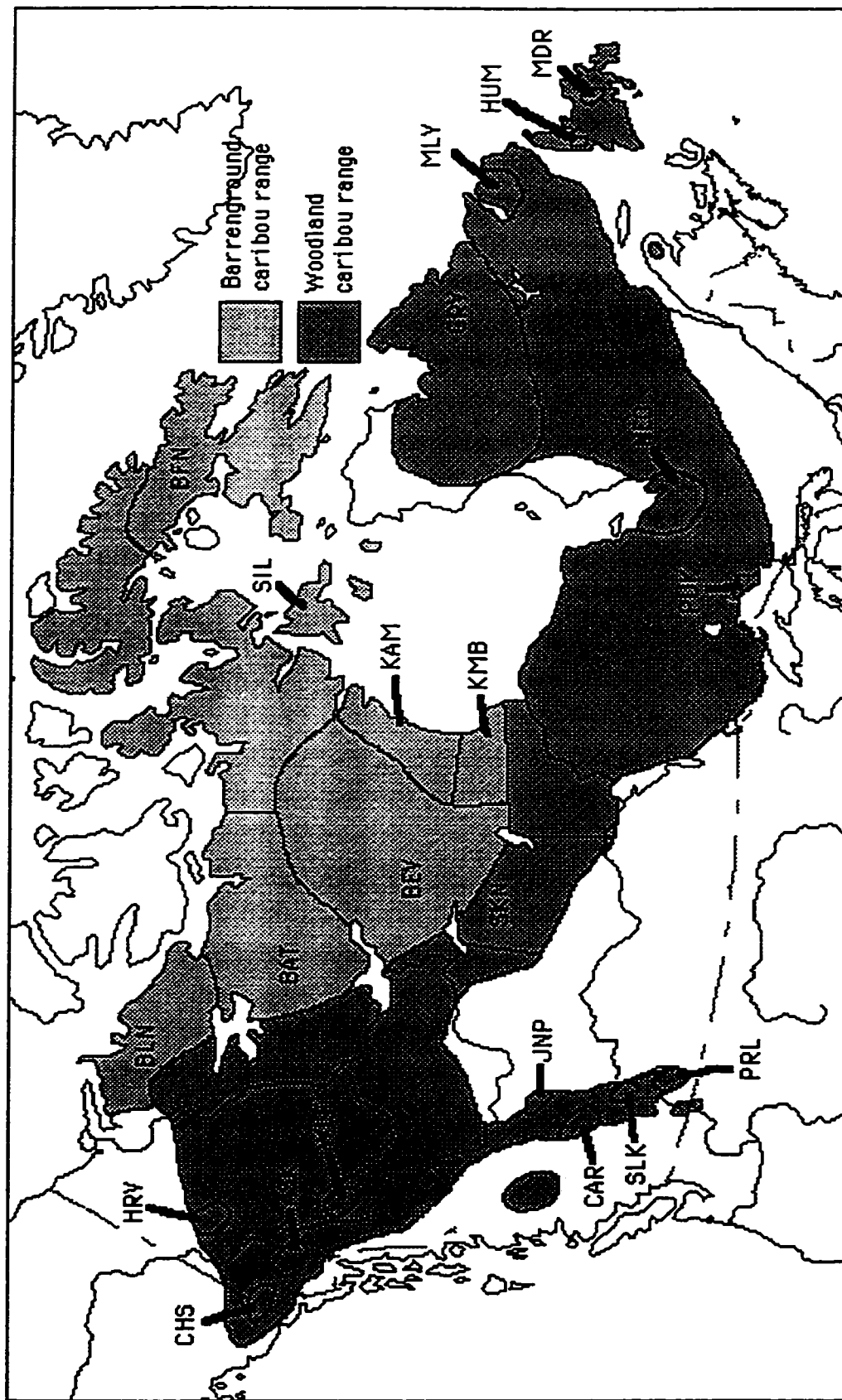

Figure 1. Range of woodland and barrenground caribou, including locations of study herds.

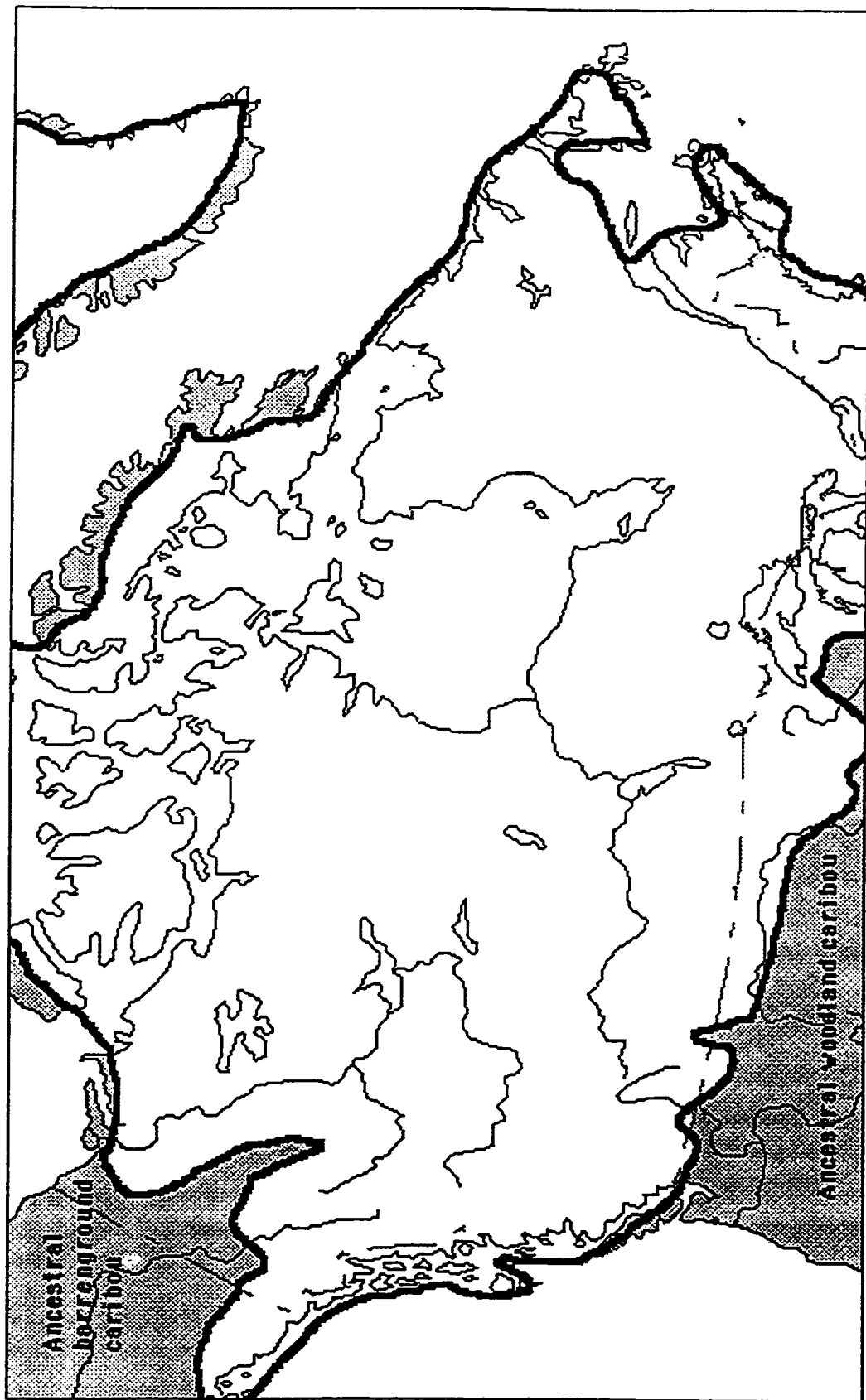

Figure 2a. Canada c. 18 kybp showing ice-free refugia inhabited by ancestral woodland and barrenground caribou.

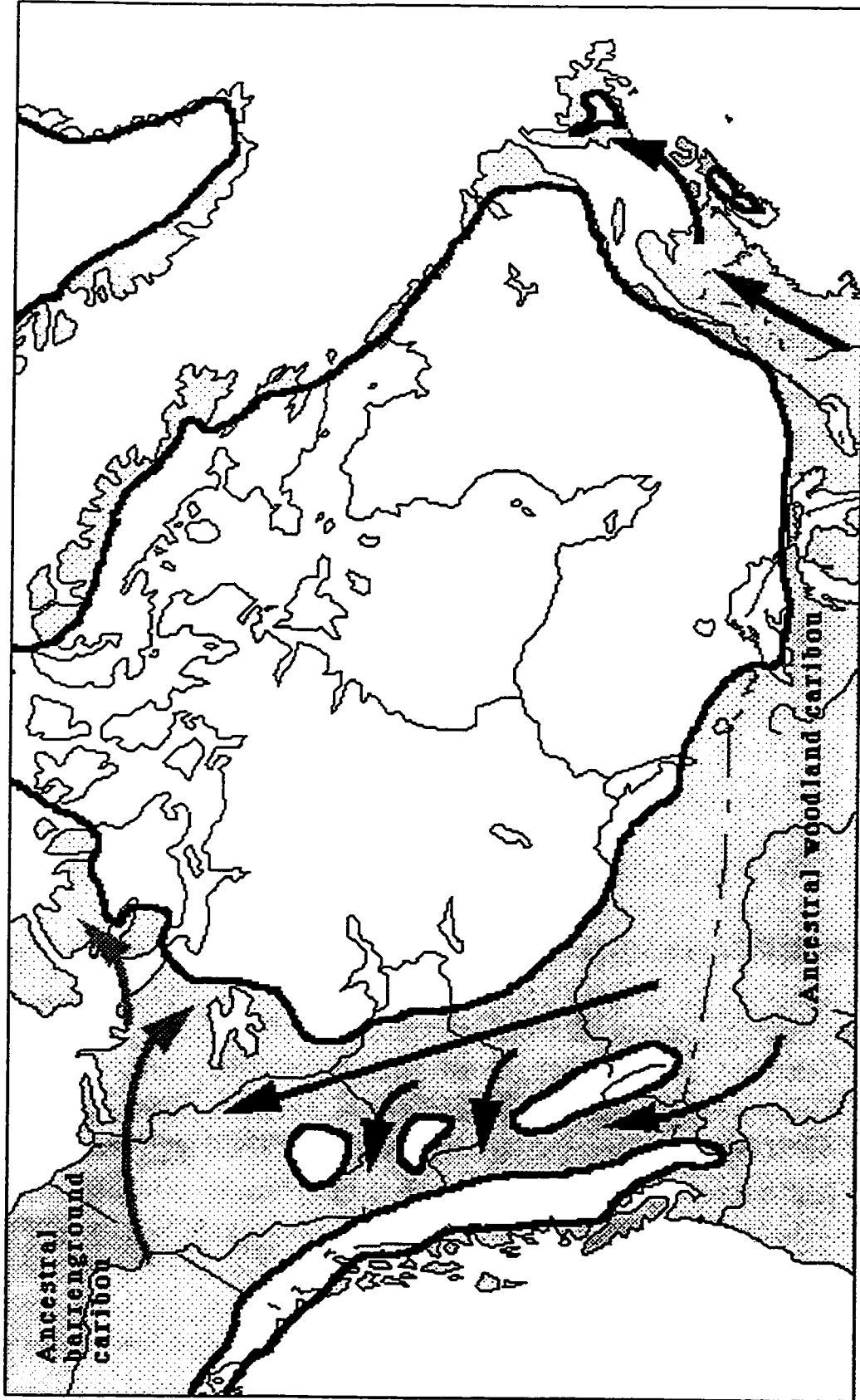

Figure 2b. Canada c. 11 kybp showing traditionally hypothesized post-glacial dispersal of woodland and borenground caribou.

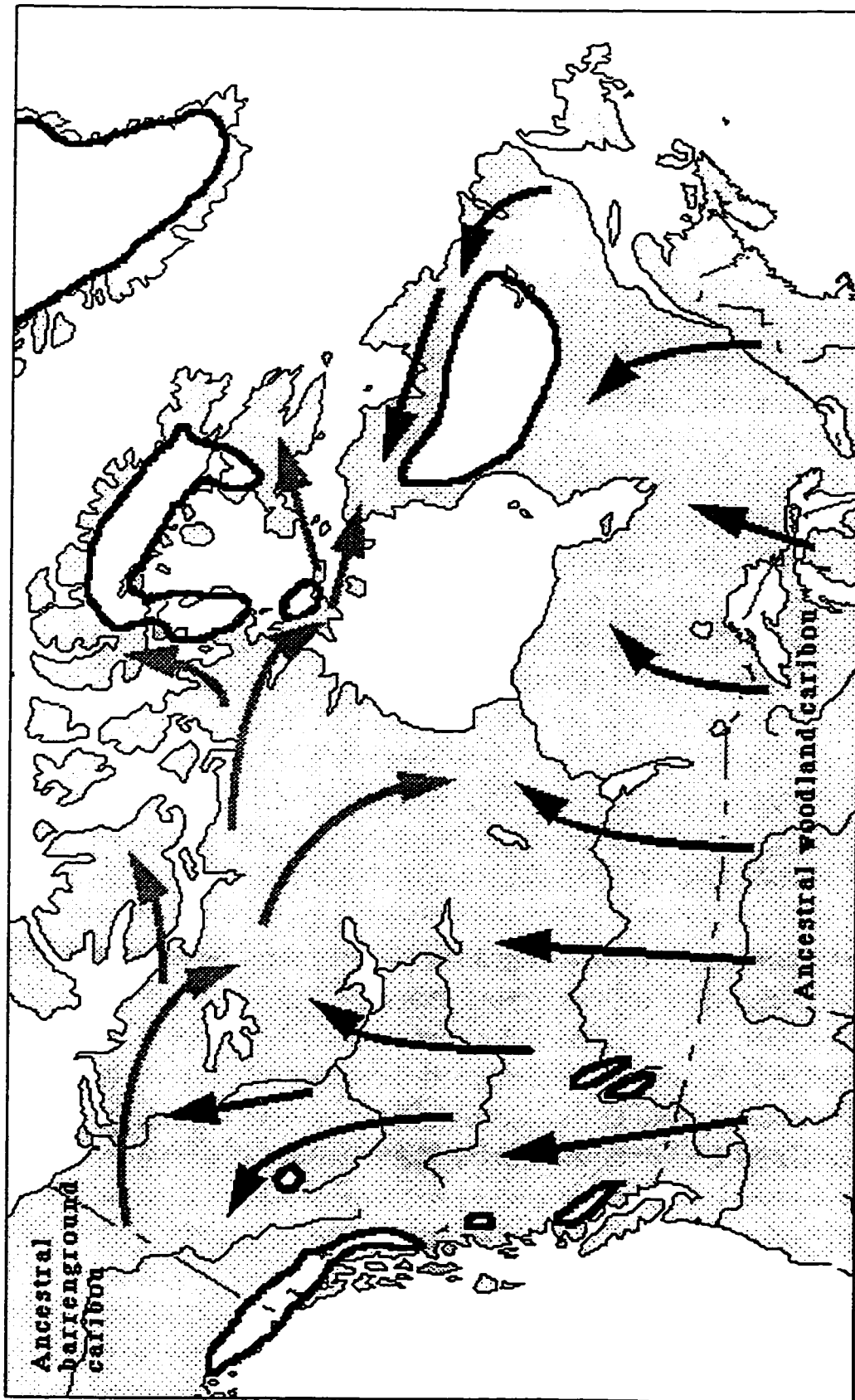

Figure 2c. Canada c. 7 kybp showing traditionally hypothesized post-glacial dispersal of woodland and barrenground caribou.

1111111111222222222233333333334444444
1234567890123456789012345678901234567890123456

```

ELK          CTAATCTCCCTAAGACTCAAGGAAGAAGCCATAGCCCCACTATCAA
WTDEER       .C..C.....
BAT7         TC.....T.....T.....
CAR1         TC.....T.....T.....
GRV1         T.....T.....T.....
GRV2         T.....T.....T.....
GRV3         T.....T.....T.....
GRV4         T.....T.....T.....
HUM1         TC.....T.....T.....
HUM2         TC.....T.....T.....
HUM3         TC.....T.....T.....
JNP1         TC.C.....T.....T.....
PUK1         TC.C.....T.....T.....C.....
PUK2         TC.....T.....T.....
SKN1         TC.....T.....T.....
SKN2         TC.....T.....T.....
SLK2         TC.....T.....T.....
SouthCon     Tc.....T.....T.....
BAT1         .C.....T.....
BAT2         .C.....T.....
BAT3         .C.....T.....
BAT4         .C.....T.....
BAT5         .C.....T.....
BAT6         .C.....T.....
BEV1         .C.....T.....
BEV2         .C.....T.....
BEV3         .C.....T.....
BFN1         .C.....T.....
BFN2         .C.....T.....
BLN1         .C.....T.....
BLN2         .C.....T.....
BLN3         .C.....T.....
CAR2         .C.....T.....
JNP2         .C.....T.....
KAM1         .C.....T.....
KAM2         .C.....T.....
NEO1         .C.....T.....
SLK1         .C.....T.....
WLF1         .C.....T.....
NorthCon     .C.....T.....
RND1         .C.....T.....
RND2         .C.....T.....
Sequence     [Alu1]
Features     tRNA-Thr  --><--  tRNA-Pro

```

Figure 3. Aligned mtDNA sequences from 36 woodland and barrerground caribou, 2 European reindeer, elk, and white-tailed deer. Caribou are arranged into two clades based on phylogenetic analysis. Consensus sequences of the southern and northern mtDNA clades are reported immediately following the last sequenced member of each clade. Sequence features are reported below all sequences.

444555555555666666666677777777778888888888999
 7890123456789012345678901234567890123456789012

ELK	CACCCAAAGCTGAAGTTCATTTAAACTATTCCCTGACGCATATTA
WTDEERT.....
BAT7A.....G.T.....
CAR1A.....G.T.....
GRV1A.....G.T.....
GRV2A.....G.T.....
GRV3A.....G.T.....
GRV4A.....G.T.....
HUM1A.....G.T.....
HUM2A.....G.T.....
HUM3A.....G.T.....
JNP1A.....G.T.....
PUK1A.....G.T.....
PUK2A.....G.T.....
SKN1A.....G.T.....
SKN2A.....G.T.....
SLK2A.....G.T.....
SouthConA.....G.T.....
BAT1A.....G.T.....
BAT2A.....G.T.....
BAT3A.....G.T.....
BAT4A.....G.T.....
BAT5A.....G.T.....
BAT6A.....G.T.....
BEV1A.....G.T.....
BEV2A.....G.T.....
BEV3A.....G.T.....
BFN1A.....G.T.....
BFN2A.....G.T.....
BLN1A.....G.T.....
BLN2A.....G.T.....
BLN3A.....G.T.....
CAR2A.....G.T.....
JNP2A.....G.T.....
KAM1A.....G.T.....
KAM2A.....G.T.....
NEO1A.....G.T.....
SLK1A.....G.T.....
WLF1A.....G.T.....
NorthConA.....G.T.....
RND1A.....G.T.....
RND2A.....G.T.....
Sequence	
Features	tRNA-Pro -><- CR

Figure 3 continued.

111
9999999000000000011111111122222222223333333333
3456789012345678901234567890123456789012345678

ELK	ATATAGCTCCATAAAACCCAAGAGCTTTATCAGTATTAAATTTTA
WTDEERT.....AT.....A.....CC-
BAT7C.....TT.....C.....C..
CAR1C.....TT.....C.....C..
GRV1C.....TT.....C.G.....C..
GRV2C.....TT.....C.G.....C..
GRV3C.....TT.....C.G.....C..
GRV4C.....TT.....C.G.....C..
HUM1C.....TT.....C.G.....C..
HUM2C.....TT.....C.G.....C..
HUM3C.....TT.....C.G.....C..
JNP1C.....TT.....C.....C..
PUK1C.....TT.....C.G.....C..
PUK2C.....TT.....C.G.....C..
SKN1C.....TT.....C.....C..
SKN2C.....TT.....C.....C..
SLK2C.....TT.....C.....C..
SouthConC.....TT.....C.g.....C..
BAT1C.....TT.....C.G.....C..
BAT2C.....TT.....C.G.....C..
BAT3C.....TT.....C.G.....C..
BAT4C.....TT.....C.G.....C..
BAT5C.....TT.....C.G.....C..
BAT6C.....TT.....C.G.....C..
BEV1C.....TT.....C.G.....C..
BEV2C.....TT.....C.G.....C..
BEV3C.....TT.....C.G.....C..
BFN1C.....TT.....C.G.....C..
BFN2C.....TT.....C.G.....C..
BLN1C.....TT.....C.G.....C..
BLN2C.....TT.....C.....C..
BLN3C.....TT.....C.G.....C..
CAR2C.....TT.....C.G.....C..
JNP2C.....TT.....C.G.....C..
KAM1C.....TT.....C.G.....C..
KAM2C.....TT.....C.G.....C..
NEO1C.....TT.....C.G.....C..
SLK1C.....TT.....C.G.....C..
WLF1C.....TT.....C.G.....C..
NorthConC.....TT.....C.G.....C..
RND1C.....TT.....C.G.....C..
RND2C.....TT.....C.G.....C..
Sequence Features	CR left domain

Figure 3 continued.

```

11111111111111111111111111111111111111111111111111111111
344444444444555555555566666666667777777777888888
9012345678901234567890123456789012345678901234

```

```

ELK      AAAATTTTAAATAATTTAATACAGTTTTCGCACTCAATAGCCATATT
WTDEER   ....AA.....T.....C...CT.....C.T...AT..
BAT7     ....CC..C..G.....C.....
CAR1     ....CC..C..G.....C.....
GRV1     ....CC..C..G.....C.....
GRV2     ....CC..C..G.....C.....
GRV3     ....CC..C..G.....C.....
GRV4     ....CC..C..G.....C.....
HUM1     ....CC..C..G.....C.....
HUM2     ....CC..C..G.....C.....
HUM3     ....CC..C..G.....C.....
JNP1     ....CC..C..G.....C.....
PUK1     ....CC..C..G.....C.....
PUK2     ....CC..C..G.....C.....
SKN1     ....CC..C..G.....C.....
SKN2     ....CC..C..G.....C.....
SLK2     ....CC..C..G.....C.....
SouthCon  ....CC..C..G.....C.....
BAT1     ....CC..C..G.....C.....
BAT2     ....CC..C..G.....C.....
BAT3     ....CC..C..G.....C.....
BAT4     ....CC..C..G.....C.....
BAT5     ....CC..C..G.....C.....
BAT6     ....CC..C.....C.....
BEV1     ....CC..C..G.....C.....
BEV2     ....CC..C..G.....C.....
BEV3     ....CC..C.....C.....
BFN1     ....CC..C..G.....C.....
BFN2     ....CC..C..G.....C.....
BLN1     ....CC..C..G.....C.....
BLN2     ....CC..C..G.....C.....
BLN3     ....CC..C..G.....C.....
CAR2     ....CC..C..G.....C.....
JNP2     ....CC..C..G.....C.....
KAM1     ....CC..C..G.....C.....
KAM2     ....CC..C..G.....C.....
NEO1     ....CC..C..G.....C.....
SLK1     ....CC..C..G.....C.....
WLF1     ....CC..C..G.....C.....
NorthCon  ....CC..C..G.....C.....
RND1     ....CC..C..G.....C.....
RND2     ....CC..C.....C.....
Sequence
Features                                CR left domain

```

Figure 3 continued.

1111111111111111122222222222222222222222222222222222
88888999999999990000000001111111111222222222223
5678901234567890123456789012345678901234567890

ELK	ACATTCTTTAATACCATTACCTACACAAACTGTACAACAATGTATT
WIDEERT.A.GTC-.T.C..AT....-----C.GC.A..CACG.G
BAT7	.T.....
CAR1	.T.....
GRV1	.T.....
GRV2	.T.....
GRV3	.T.....
GRV4	.T.....
HUM1	.T.....
HUM2	.T.....
HUM3	.T.....
JNP1	.T.....
PUK1	.T.....
PUK2	.T.....
SKN1	.T.....
SKN2	.T.....
SLK2	.T.....
SouthCon	.T.....
BAT1	.T.....
BAT2	.T.....
BAT3	.T.....
BAT4	.T.....
BAT5	.T.....
BAT6	.T.....
BEV1	.T.....
BEV2	.T.....
BEV3	.T.....
BFN1	.T.....
BFN2	.T.....
BLN1	.T.....
BLN2	.T.....
BLN3	.T.....
CAR2	.T.....
JNP2	.T.....
KAM1	.T.....
KAM2	.T.....
NEO1	.T.....
SLK1	.T.....
WLF1	.T.....
NorthCon	.T.....
RND1	.T.....
RND2	.T.....
Sequence Features	

CR left domain

Figure 3 continued.

333
 2222222333
 34567890123456789012345678901234567890123456789012345678

ELK	CT-TATAAGCAAGTACATAAAATTAATGTATTAAAACATATTATGT
WTDEER	T.A.G..TAAT.....-.....G.....
BAT7	..A.-----.....C.GG.....C.....
CAR1	..A.-----.....C.GG.....C.....
GRV1	T.A.-----.....C.GG.....
GRV2	T.A.-----.....C.GG.....
GRV3	T.A.-----.....C.GG.....
GRV4	T.A.-----.....GG.....
HUM1	T.A.-----.....C.GG.....C.....
HUM2	T.A.-----.....C.GG.....
HUM3	T.A.-----.....C.GG.....C.....
JNP1	..A.-----.....C.GG.....C.....
PUK1	T.A.-----.....C.GG.....C.....
PUK2	T.A.-----.....C.GG.....
SKN1	..A.-----.....C.GG.....C.....
SKN2	..A.-----.....C.GG.....C.....
SLK2	..A.-----.....C.GG.....C.....
SouthCon	t.A.-----.....C.GG.....c.....
BAT1	..A.-----.....G.....C.....
BAT2	..A.-----.....G.....
BAT3	..A.-----.....G.....C.....
BAT4	..A.-----.....G.....C.....
BAT5	..A.-----.....G.....
BAT6	..A.-----.....G.....C.....
BEV1	T.A.-----.....C.G.....C.....
BEV2	T.A.-----.....C.G.....C.....
BEV3	..A.-----.....G.....C.....
BFN1	..A.-----.....G.....
BFN2	..A.-----.....G.....
BLN1	..A.-----.....G.....
BLN2	..A.-----.....G.....
BLN3	T.A.-----.....C.G.....C.....
CAR2	..A.-----.....G.....C.....
JNP2	..A.-----.....G.....C.....
KAM1	T.A.-----.....CC.G.....C.....
KAM2	T.A.-----.....CC.G.....C.....
NEO1	..A.-----.....G.....C.....
SLK1	..A.-----.....G.....
WLF1	..A.-----.....G.....
NorthCon	c.A.-----.....t.G.....c.....
RND1	..A.-----.....G.....
RND2	..A.-----.....G.....C.....
Sequence	[Rsa1]
Features	CR left domain

Figure 3 continued.

```

33333333333333333333333333333333334444444444444444
6777777777778888888888888899999999999900000000011111
9012345678901234567890123456789012345678901234

```

ELK	ATAATAGTACATTAAACTATACACCCCATGCTTACAAGCAAGTACA										
WTDEER	.	T.	T.	.	TG.	.	T.	.	T.	.	T.
BAT7	T.	.	TG.	.	T.	.	T.
CAR1	T.	.	TG.	.	T.	.	T.
GRV1	T.	.	TG.	.	T.	.	T.
GRV2	T.	.	TG.	.	T.	.	T.
GRV3	T.	.	TG.	.	T.	.	T.
GRV4	T.	.	TG.	.	T.	.	T.
HUM1	T.	.	TG.	.	T.	.	T.
HUM2	T.	.	TG.	.	T.	.	T.
HUM3	T.	.	TG.	.	T.	.	T.
JNP1	T.	.	TG.	.	T.	.	T.
PUK1	T.	.	TG.	.	T.	.	T.
PUK2	T.	.	TG.	.	T.	.	T.
SKN1	T.	.	TG.	.	T.	.	T.
SKN2	T.	.	TG.	.	T.	.	T.
SLK2	T.	.	TG.	.	T.	.	T.
SouthCon	T.	.	TG.	.	T.	.	T.
BAT1	T.	.	TG.	.	T.	.	T.
BAT2	T.	.	TG.	.	T.	.	T.
BAT3	T.	.	TG.	.	T.	.	T.
BAT4	T.	.	TG.	.	T.	.	T.
BAT5	T.	.	TG.	.	T.	.	T.
BAT6	T.	.	TG.	.	T.	.	T.
BEV1	T.	.	TG.	.	T.	.	T.
BEV2	T.	.	TG.	.	T.	.	T.
BEV3	T.	.	TG.	.	T.	.	T.
BFN1	T.	.	TG.	.	T.	.	T.
BFN2	T.	.	TG.	.	T.	.	T.
BLN1	T.	.	TG.	.	T.	.	T.
BLN2	T.	.	TG.	.	T.	.	T.
BLN3	TG.	.	T.	.	C
CAR2	.	.	A.	.	T.	.	TG.	.	T.	.	T.
JNP2	.	.	A.	.	T.	.	TG.	.	T.	.	T.
KAM1	TG.	.	T.	.	C
KAM2	TG.	.	T.	.	C
NEO1	T.	.	TG.	.	T.	.	T.
SLK1	TG.	.	T.	.	T.
WLF1	T.	.	TG.	.	T.	.	T.
NorthCon	T.	.	TG.	.	T.	.	T.
RND1	T.	.	TG.	.	T.	.	T.
RND2	T.	.	TG.	.	T.	.	T.
Sequence					3' end of D-loop		<--->				
Features							CR left domain				

Figure 3 continued.

444
 11111222222222222333333333333444444444444555555555556
 5678901234567890123456789012345678901234567890

ELK	TACAATCACTTCAAGTACATAGTACATACTATTATTAATCGTCCAT
WTDEER	.CTC.CT.TC.G.....A.G..G..C.....A...
BAT7	.GAC..T.T..AC.....G.....AC...G..G.....A...
CAR1	.GAC..T.T..AC.....G..G....A.....G.....G....
GRV1	.GAC..T.T..AC.....G.....A.....G.....A....
GRV2	.GAC..T.T..AC.....G.....A.....G.....A....
GRV3	.GAT..T.T..AC.....G.....A.....G.....A....
GRV4	.GAT..T.T..AC.....G.....A.....G.....A....
HUM1	.GAC..T.T..AC.....G.....A.....G.....A....
HUM2	.GAT..T.T..AC.....G.....A.....G.....A....
HUM3	.GAC..T.T..AC.....G.....A.....G.....A....
JNP1	.GAC..T.T..AC.....G..G....A.....G.....G....
PUK1	.GAT..T.T..AC.....A.....G.....A....
PUK2	.GAT..T.T..AC.....A.....G.....A....
SKN1	.GAC..T.T..AC.....G..G....A.....G.....G....
SKN2	.GAC..T.T..AC.....A...G..G.....A....
SLK2	.GAC..T.T..AC.....G..G....A.....G.....G....
SouthCon	.Gac..T.T..AC.....G.a...A...a..G.....a....
BAT1	.GAT..T.T..AT.....A.....G.C..A....
BAT2	.GAT..T.T..AC.....A.....G.....A....
BAT3	.GAT..T.T..AT.....A.....G.C..A....
BAT4	.GAT..T.T..AT.....A.....G.C..A....
BAT5	.GAC..T.T..AC.....G..A.....G.....A....
BAT6	.GAT..T.T..AT.....G..A.....G.....A....
BEV1	.GAT..T.T..AC.....A.....G.....A....
BEV2	.GAT..T.T..AC.....A.....G.....A....
BEV3	.GAT..T.T..AT.....G..A.....G.....A....
BFN1	.GAT..T.T..AT.....A.....G.....A....
BFN2	.GAT..T.T..AC.....A.....G.....A....
BLN1	.GAT..T.T..AC.....A.....G.....A....
BLN2	.GAC..T.T..AT.....A.....G..T..A....
BLN3	.GAC..T.T..AT.....A.....G.....A....
CAR2	.GAC..T.T..AC.....A.....G.....A....
JNP2	.GAC..T.T..AC.....A.....G.....A....
KAM1	.GAC..T.T..AC.....A.....G.....A....
KAM2	.GAC..T.T..AC.....A.....G.....A....
NEO1	.GAT..T.T..AT.....A.....G.....A....
SLK1	.GAC..T.T.AAC.....A.....G.....A....
WLF1	.GAT..T.T..AC.....A.....G.....A....
NorthCon	.GAt..T.T..Ac.....A.....G.....A....
RND1	.GAT..T.T..AC.....A...G..G.....A....
RND2	.GAT..T.T..AT.....G..A.....G.....A....

Sequence
 Features CR left domain

Figure 3 continued.

66666666677
 9999999990000000000111111111122222222223333333
 1234567890123456789012345678901234567890123456

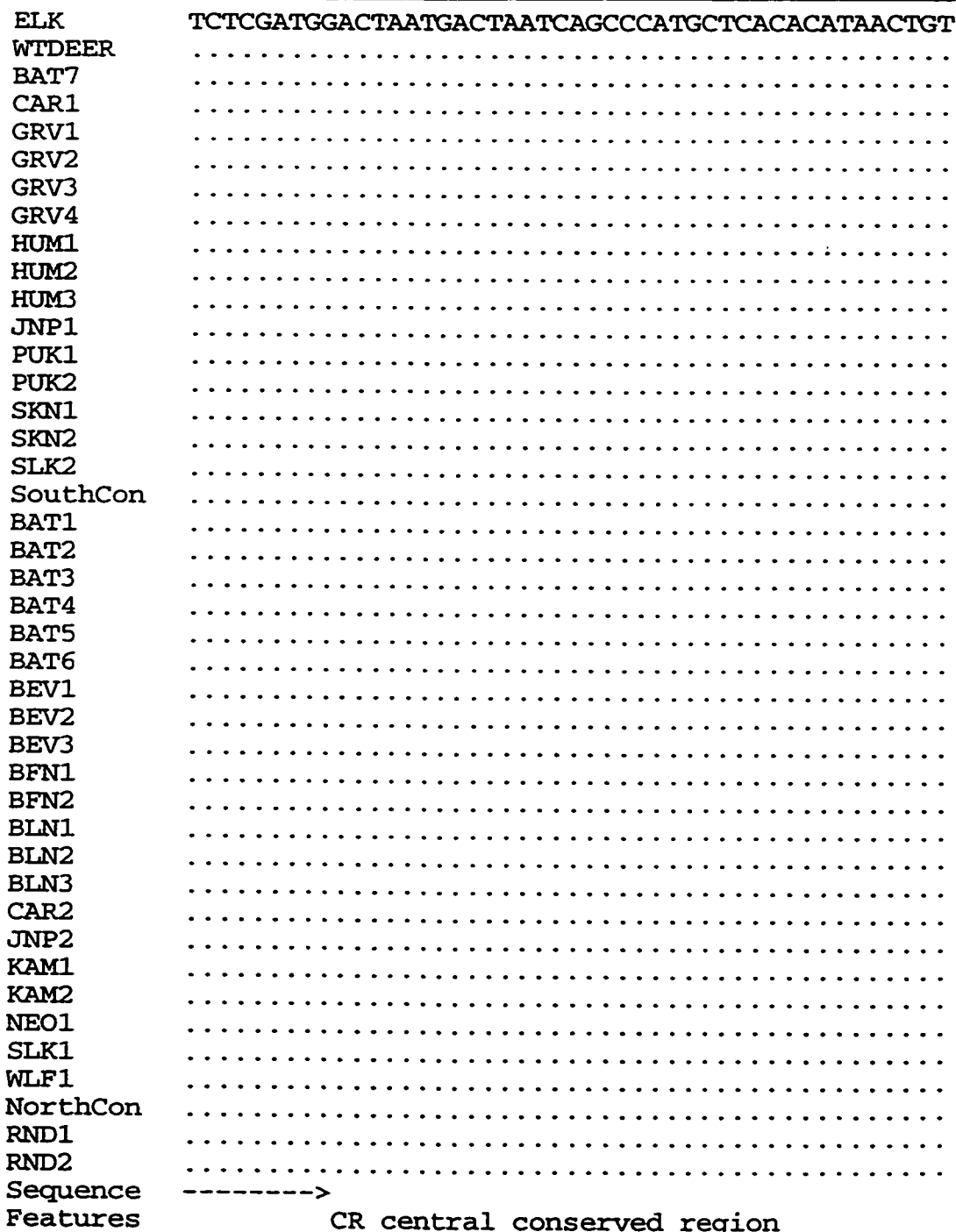

Figure 3 continued.

```

111111111111111111111111111111111111111111111111111111111111111111111
000000000000000000000000000000000000000000000000000000000000000
111111122222222222233333333333444444444445555555555
3456789012345678901234567890123456789012345678

ELK      TATATGGTTACCACAATTTTTAACACACTTCTCCCTAGATAGTATT
WTDEER   .....A.....T...C.....TC.....TA...
BAT7     .....T.TC.....G...T.....A...
CAR1     .....TC.....G...T.....A...
GRV1     .....TC.....G...T.....A...
GRV2     .....TC.....G...T.....A...
GRV3     .....TC.....G...T.....A...
GRV4     .....TC.....G...T.....A...
HUM1     .....TC.....G...T.....A...
HUM2     .....TC.....G...T.....A...
HUM3     .....TC.....G...T.....A...
JNP1     .....TC.....G...T.....A...
PUK1     .....TC.....G...T.....A...
PUK2     .....TC.....G...T.....A...
SKN1     .....TC.....G...T.....A...
SKN2     .....TC.....G...T.....A...
SLK2     .....TC.....G...T.....A...
SouthCon.....TC.....G...T.....A...
BAT1     .....TC.....G...T.....A...
BAT2     .....TC.....G...T.....A...
BAT3     .....TC.....G...T.....A...
BAT4     .....TC.....G...T.....A...
BAT5     .....TC.....G...T.....A...
BAT6     .....TC.....G...T.....A...
BEV1     .....TC.....G...T.....A...
BEV2     .....TC.....G...T.....A...
BEV3     .....TC.....G...T.....A...
BFN1     .....TC.....G...T.....A...
BFN2     .....TC.....G...T.....A...
BLN1     .....TC.....G...T.....A...
BLN2     .....TC.....G...T.....A...
BLN3     .....TC.....G...T.....A...
CAR2     .....TC.....G...T.....A...
JNP2     .....TC.....G...T.....A...
KAM1     .....TC.....G...T.....A...
KAM2     .....TC.....G...T.....A...
NEO1     .....TC.....G...T.....A...
SLK1     .....TC.....GG..T.....TA...
WLF1     .....TC.....G...T.....A...
NorthCon.....TC.....G...T.....A...
RND1     .....T.TC.....G...T.....A...
RND2     .....TC.....G...T.....A...
Sequence
Features                       CR right domain

```

Figure 3 continued.

11
00011111
566666666666777777777778888888888899999999999900000
90123456789012345678901234567890123456789012345678901234

	<u>TTAAATTTATCGCATTTTCAATACTCAAT-TAGTACTCCAGGGCAA</u>					
ELK						
WTDEER	.	A.	.	C.	.	AA. .C.A.GG.
BAT7	.	A.	.	.	.	-A. .C.AT..
CAR1	.	A.	.	.	.	-A. .C.AT..
GRV1	.	A.	.	.	.	-A. .C.AT..
GRV2	.	A.	.	.	.	-A. .C.AT..
GRV3	.	A.	.	.	.	-A. .C.AT..
GRV4	.	A.	.	.	.	-A. .C.AT..
HUM1	.	A.	.	.	.	-A. .C.AT..
HUM2	.	A.	.	.	.	-A. .C.AT..
HUM3	.	A.	.	.	.	-A. .C.AT..
JNP1	.	A.	.	.	.	-A. .C.AT..
PUK1	.	A.	.	.	.	-A. .C.AT..
PUK2	.	A.	.	.	.	-A. .C.AT..
SKN1	.	A.	.	.	.	-A. .C.AT..
SKN2	.	A.	.	.	.	-A. .C.AT..
SLK2	.	A.	.	.	.	-A. .C.AT..
SouthCon	.	A.	.	.	.	-A. .C.AT..
BAT1	.	A.	A.	.	.	-A. .C.AT..
BAT2	.	A.	A.	.	.	-A. .C.AT..
BAT3	.	A.	A.	.	.	-A. .C.AT..
BAT4	.	A.	A.	.	.	-A. .C.AT..
BAT5	.	A.	A.	.	.	-A. .C.T..
BAT6	C.	A.	A.	.	.	-A. .C.AT..
BEV1	.	A.	A.	.	.	-A. .C.AT..
BEV2	.	A.	A.	.	.	-A. .C.AT..
BEV3	C.	A.	A.	.	.	-A. .C.AT..
BFN1	.	A.	A.	.	.	-A. .C.AT..
BFN2	.	A.	A.	.	.	-A. .C.AT..
BLN1	.	A.	A.	.	.	-A. .C.AT..
BLN2	.	A.	A.	.	.	-A. .C.AT..
BLN3	C.	A.	A.	.	.	-A. .C.AT..
CAR2	C.	A.	A.	.	.	-A. .C.AT..
JNP2	C.	A.	A.	.	.	-A. .C.AT..
KAM1	C.	A.	A.	.	.	-A. .C.AT..
KAM2	C.	A.	A.	.	.	-A. .C.AT..
NEO1	.	A.	A.	.	.	-A. .C.AT..
SLK1	.	A.	A.	.	.	-A. .C. .T. . .AT..
WLF1	.	A.	A.	.	.	-A. .C.AT..
NorthCon	t.	A.	A.	.	.	-A. .C.AT..
RND1	.	A.	A.	.	.	-A. .C.AT..
RND2	C.	A.	A.	.	.	-A. .C.AT..
Sequence Features						CR right domain

Figure 3 continued.

111
111
5555555556666666666677777777778888888888999999999
12345678901234567890123456789012345678901234567

ELK	GTAGCTTAAACAATAAAGCAAGGCACTGAAAATGCCTAGATGAGTAT
WTDEERGC.....
BAT7C.....
CAR1C.....
GRV1C.....
GRV2C.....
GRV3C.....
GRV4C.....
HUM1C.....
HUM2C.....
HUM3C.....
JNP1C.....
PUK1C.....
PUK2C.....
SKN1C.....
SKN2C.....
SLK2C.....
SouthConC.....
BAT1C.....
BAT2T.....C.....
BAT3C.....
BAT4C.....
BAT5C.....
BAT6C.....
BEV1C.....
BEV2C.....
BEV3C.....
BFN1C.....
BFN2T.....C.....
BLN1T.....C.....
BLN2C.....
BLN3C.....
CAR2C.....
JNP2C.....
KAM1C.....
KAM2C.....
NEO1C.....
SLK1C.....
WLF1C.....
NorthConC.....
RND1C.....
RND2C.....

Sequence Features

tRNA-Phe

Figure 3 continued.

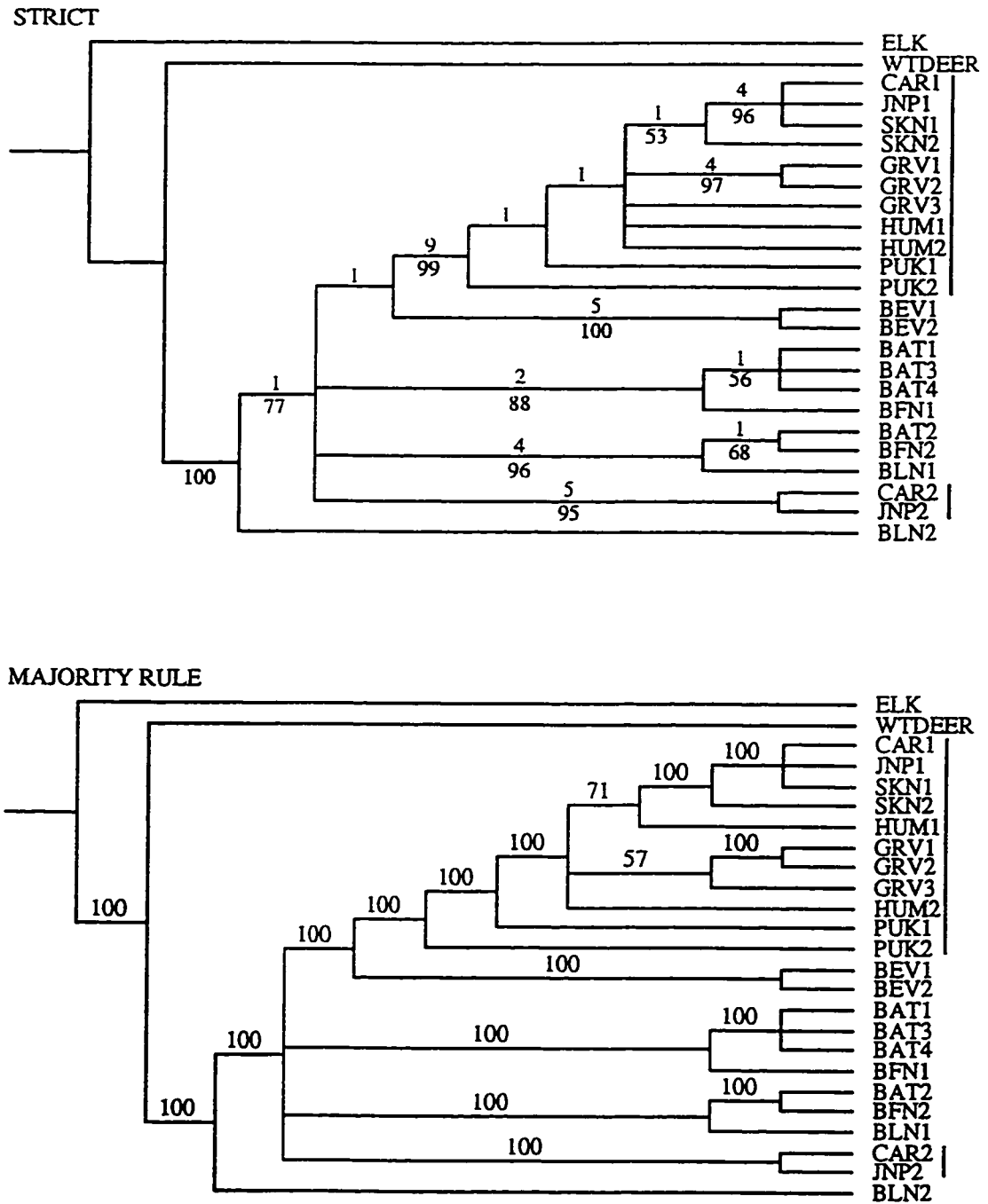

Figure 4. Consensus of 84 equally most parsimonious trees reconstructed from 1196 nt. alignment, including gaps, and weighting transitions:transversions 1:1. Caribou from woodland herds are labelled with a bar beside their name. For all trees, length = 293, CI = 0.846, and RC = 0.705.

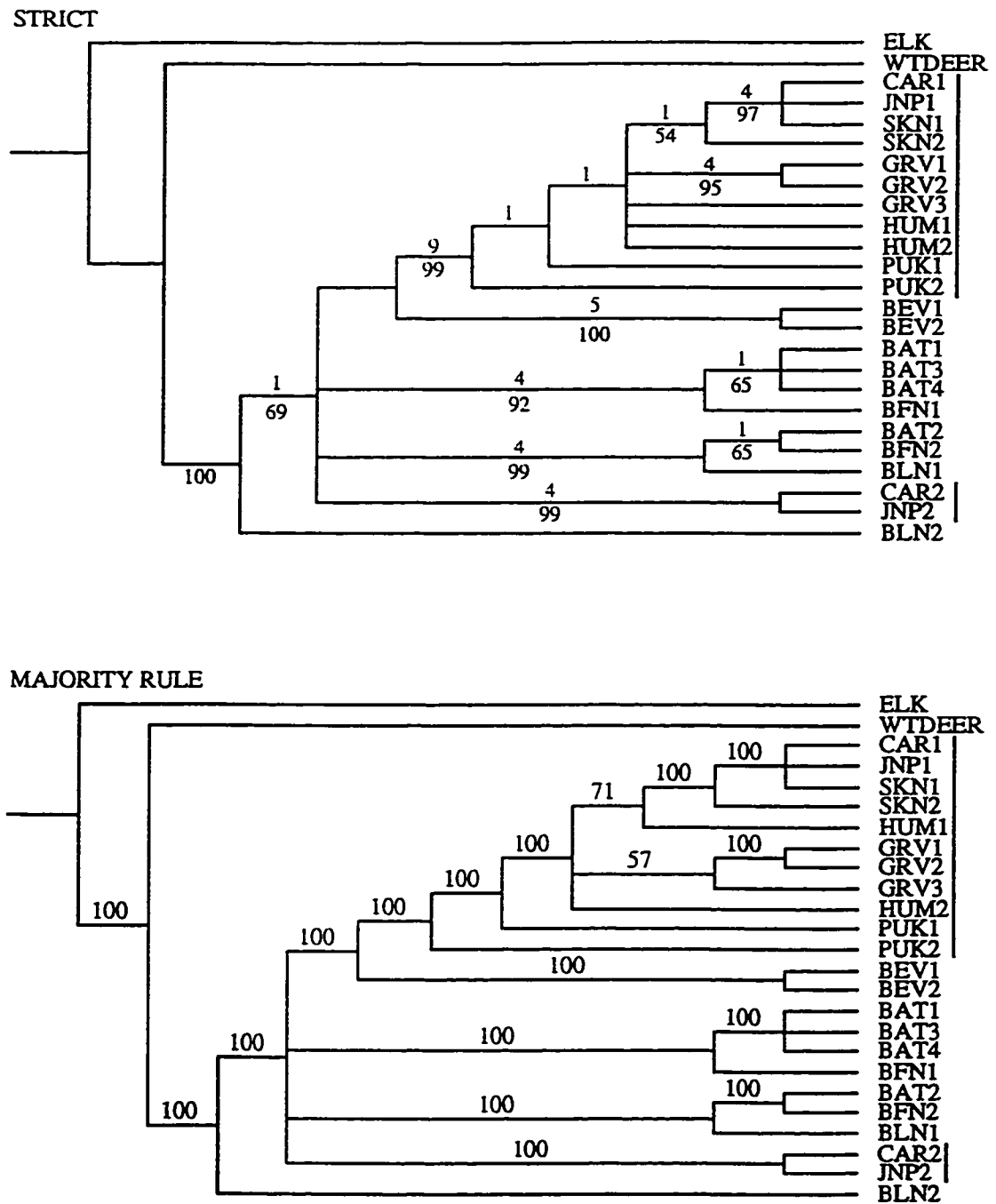

Figure 5. Consensus of 84 equally most parsimonious trees reconstructed from 1197 nt. alignment, including gaps, and weighting transitions:transversions 1:1. Caribou from woodland herds are labelled with a bar beside their name. For all trees, length = 292, CI = 0.846, and RC = 0.704.

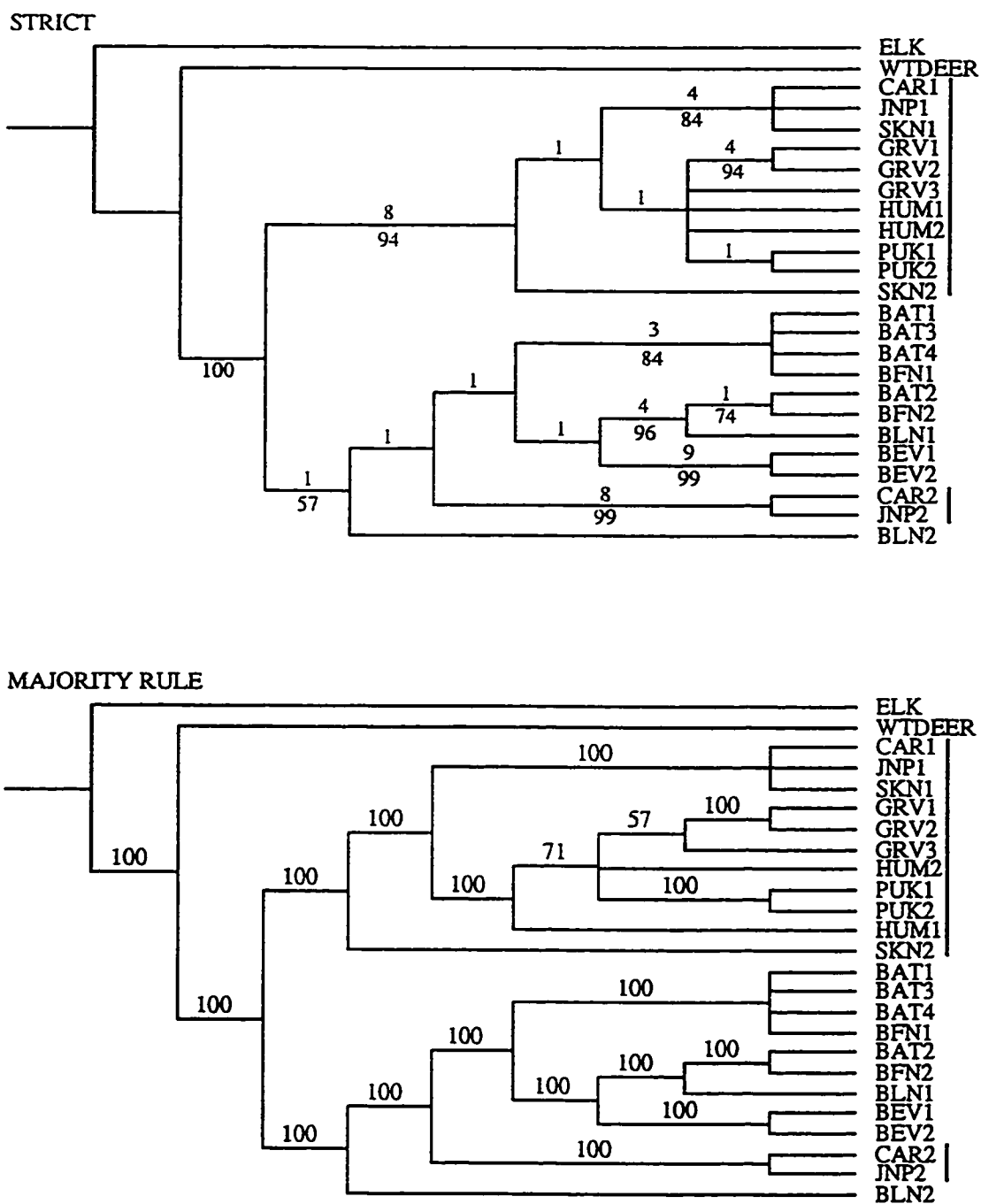

Figure 6. Consensus of 28 equally most parsimonious trees reconstructed from 1196 nt. alignment, including gaps, and weighting transitions:transversions 1:4. Caribou from woodland herds are labelled with a bar beside their name. For all trees, length = 475, CI = 0.895, and RC = 0.762.

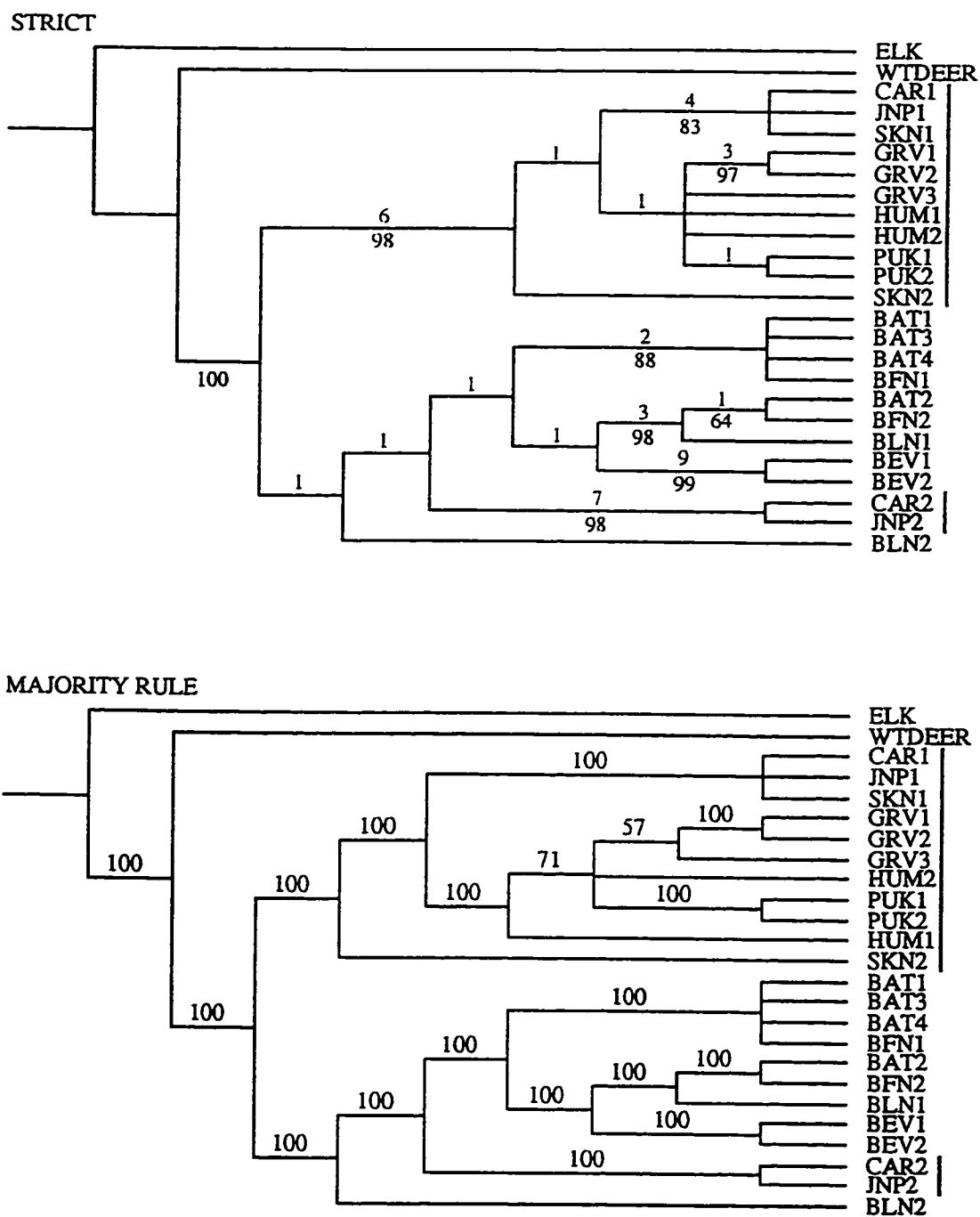

Figure 7. Consensus of 28 equally most parsimonious trees reconstructed from 1197 nt. alignment, including gaps, and weighting transitions:transversions 1:4. Caribou from woodland herds are labelled with a bar beside their name. For all trees, length = 474, CI = 0.895, and RC = 0.762.

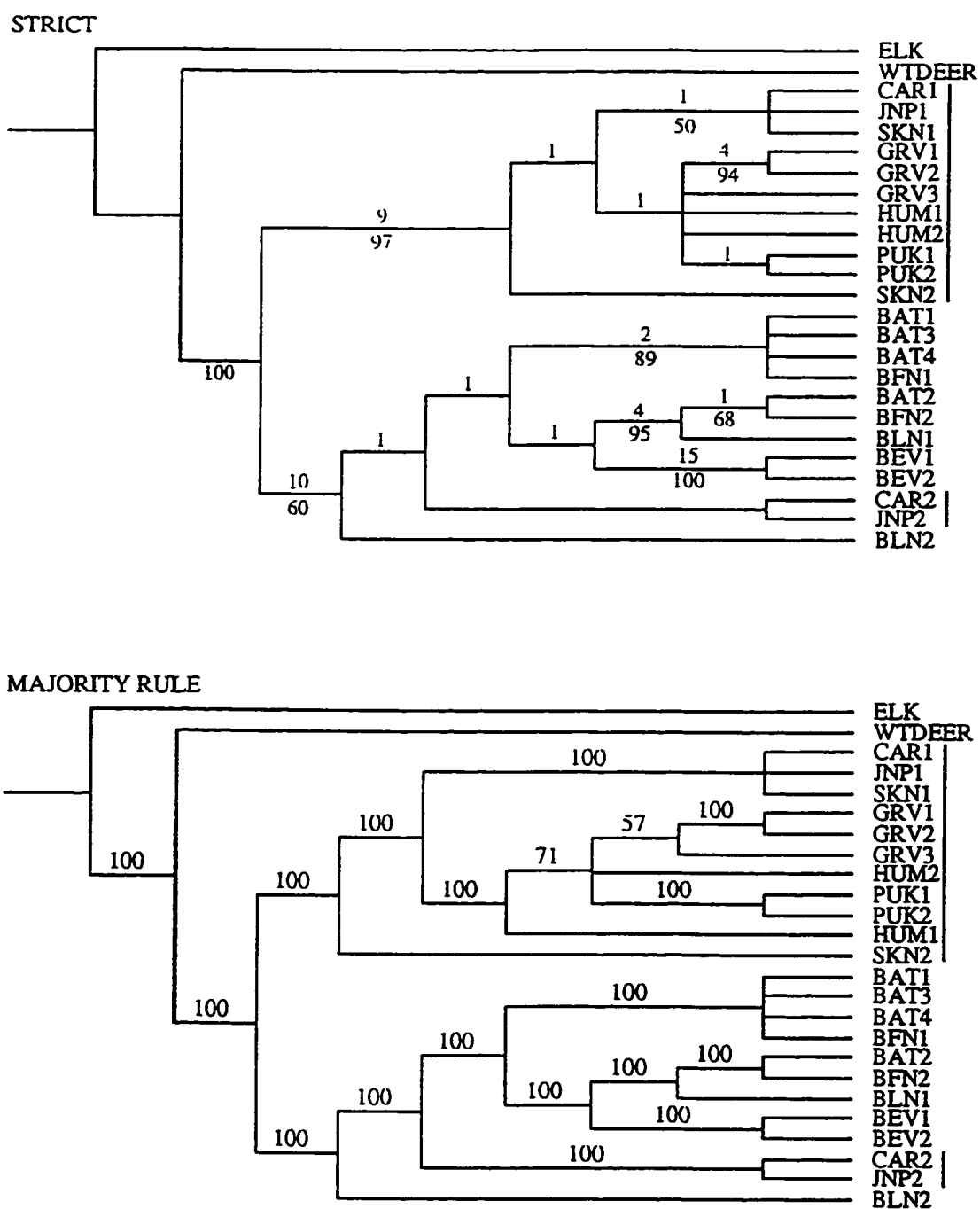

Figure 8. Consensus of 28 equally most parsimonious trees reconstructed from 1196 nt. alignment, including gaps, and weighting transitions:transversions 1:9. Caribou from woodland herds are labelled with a bar beside their name. For all trees, length = 775, CI = 0.929, and RC = 0.814.

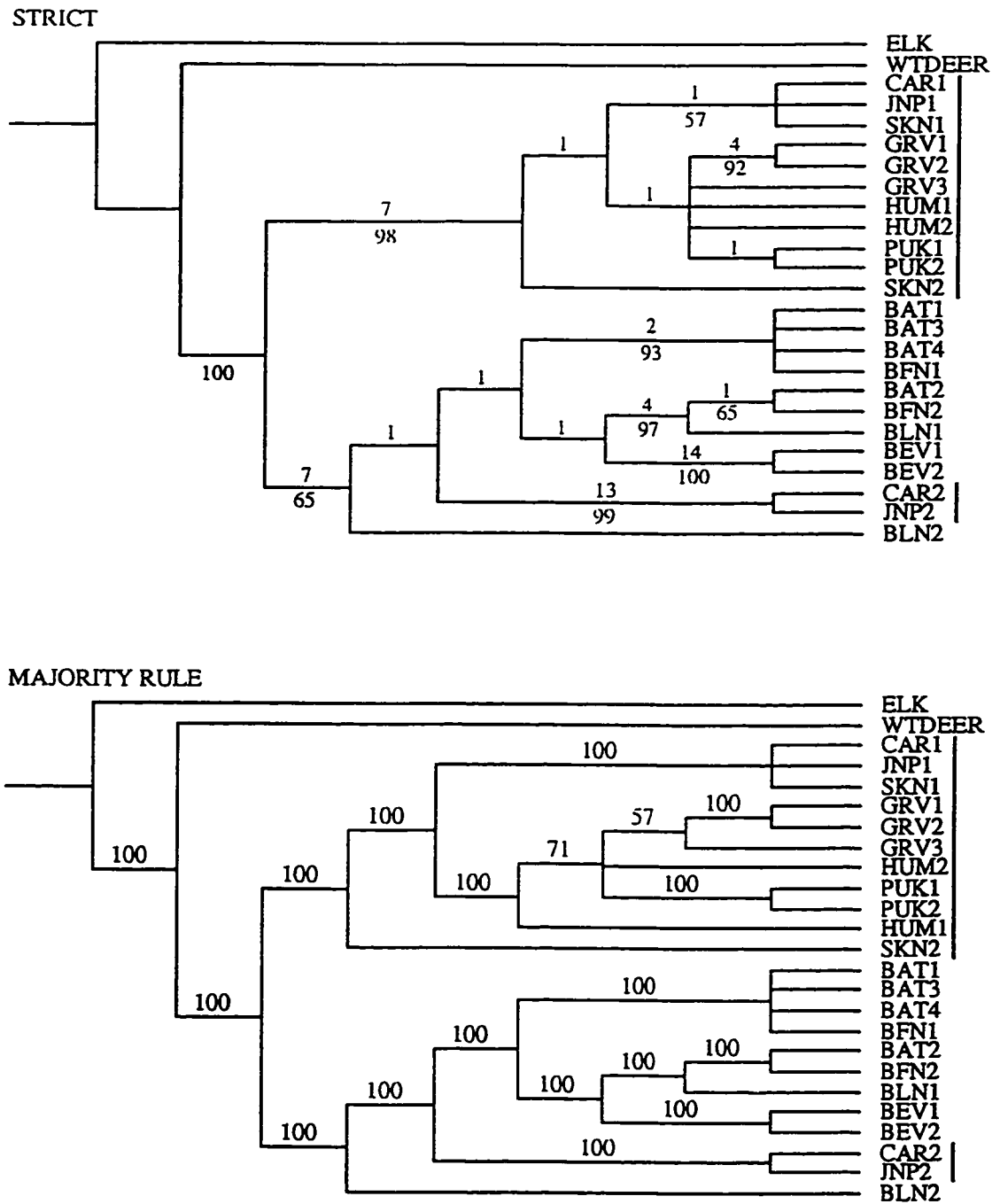

Figure 9. Consensus of 28 equally most parsimonious trees reconstructed from 1197 nt. alignment, including gaps, and weighting transitions:transversions 1:9. Caribou from woodland herds are labelled with a bar beside their name. For all trees, length = 774, CI = 0.929, and RC = 0.814.

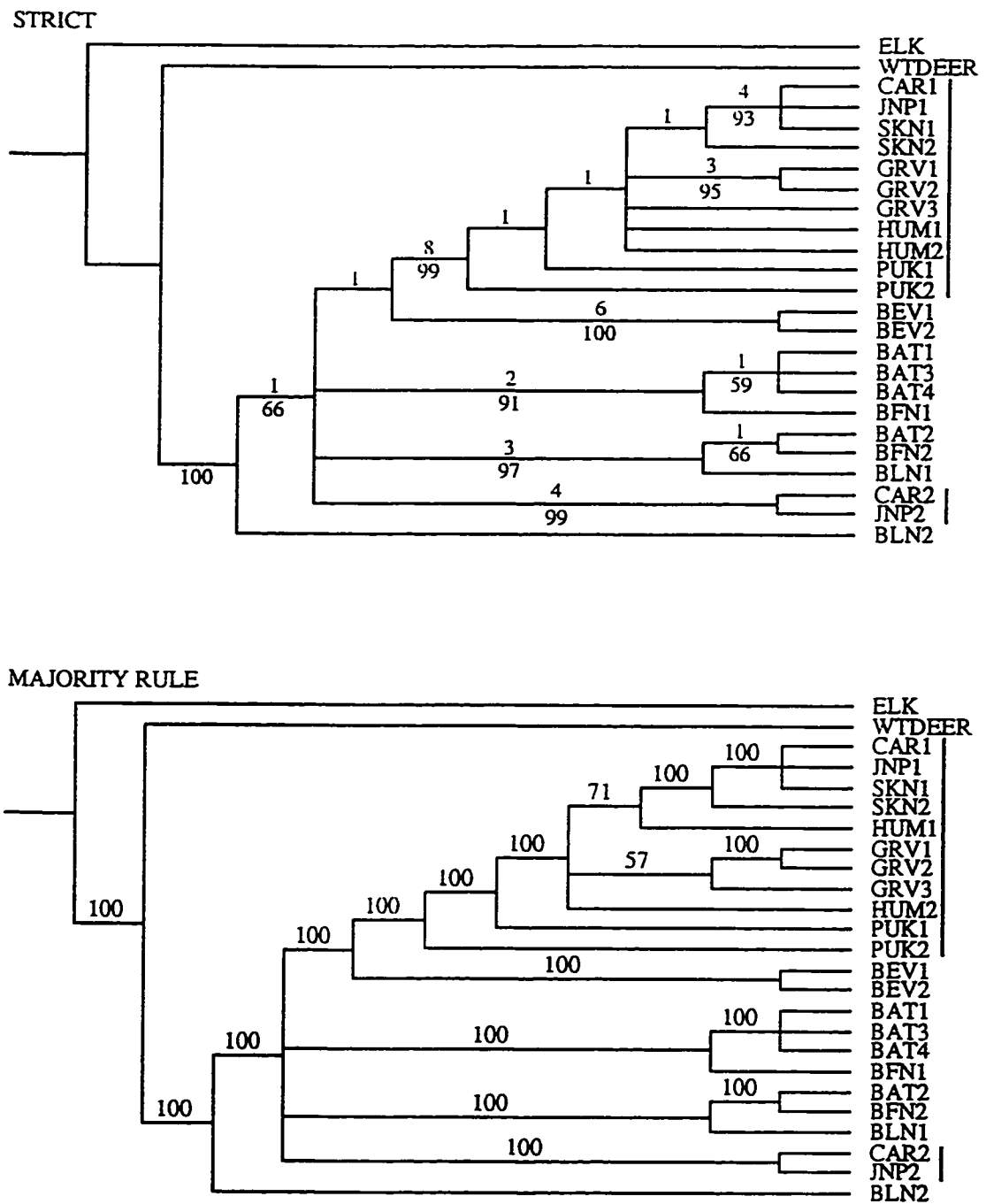

Figure 10. Consensus of 84 equally most parsimonious trees reconstructed from 1196 nt. alignment, excluding gaps, and weighting transitions:transversions 1:1. Caribou from woodland herds are labelled with a bar beside their name. For all trees, length = 254, CI = 0.823, and RC = 0.685.

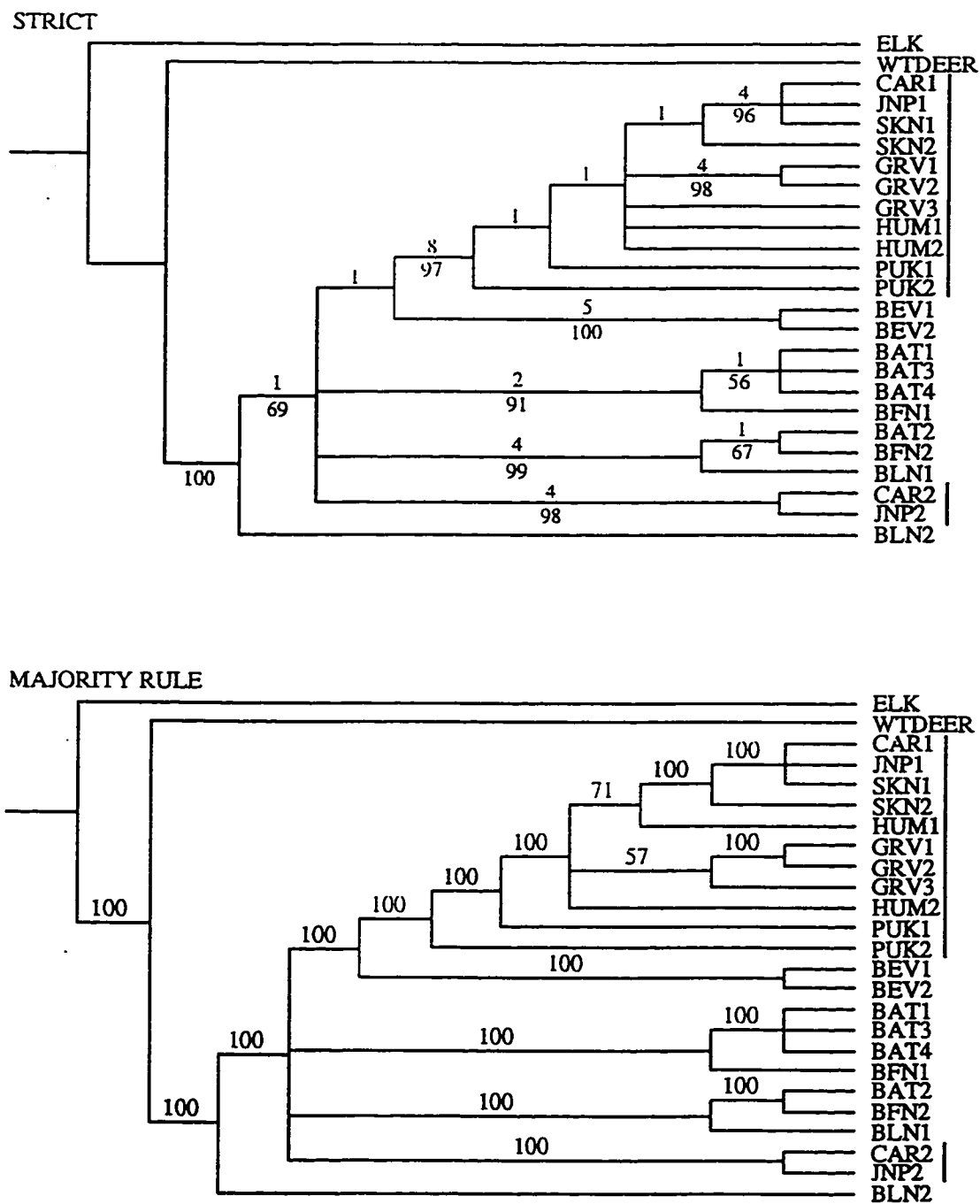

Figure 11. Consensus of 84 equally most parsimonious trees reconstructed from 1197 nt. alignment, excluding gaps, and weighting transitions:transversions 1:1. Caribou from woodland herds are labelled with a bar beside their name. For all trees, length = 254, CI = 0.823, and RC = 0.685.

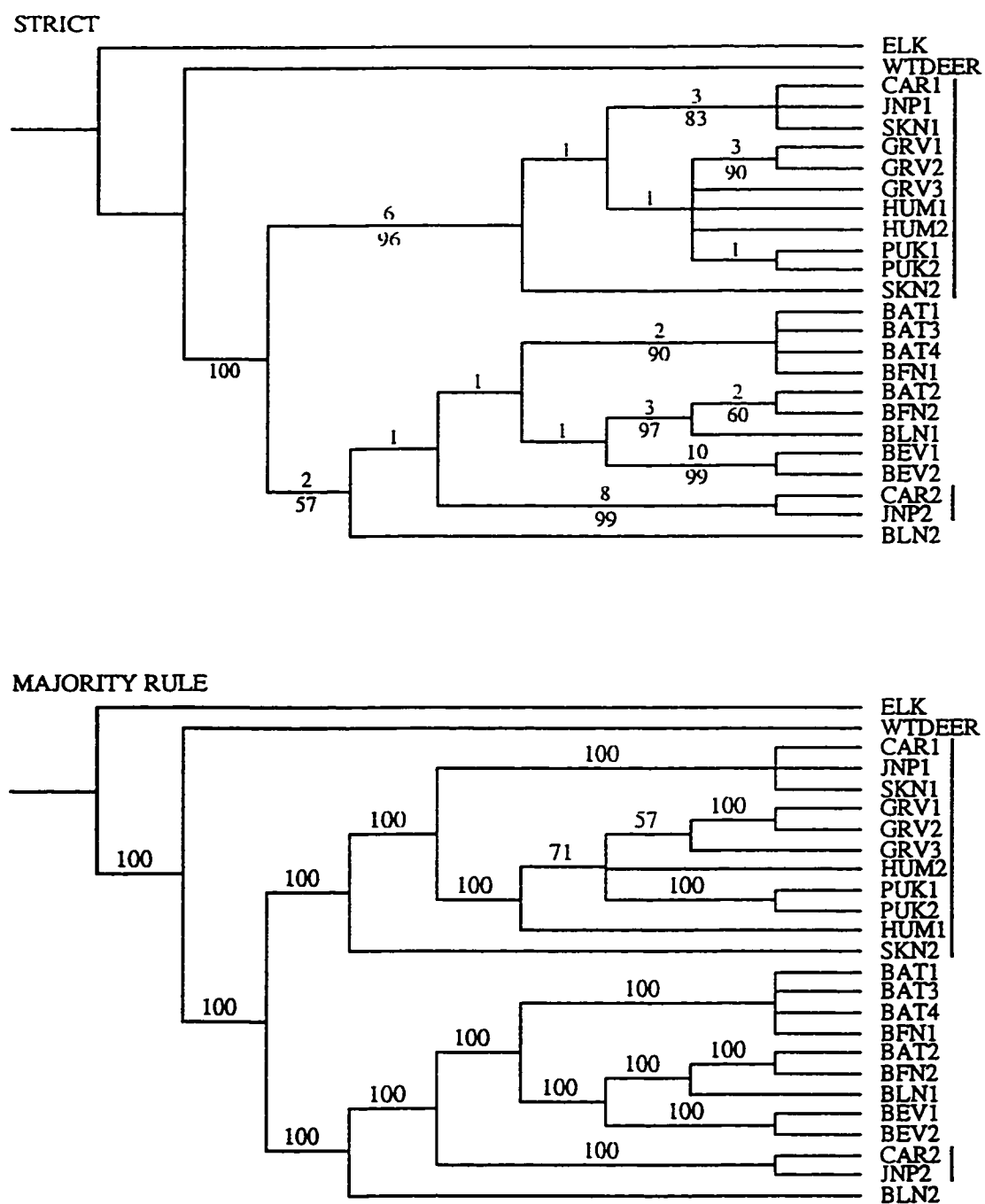

Figure 12. Consensus of 28 equally most parsimonious trees reconstructed from 1196 nt. alignment, excluding gaps, and weighting transitions:transversions 1:4. Caribou from woodland herds are labelled with a bar beside their name. For all trees, length = 400, CI = 0.875, and RC = 0.744.

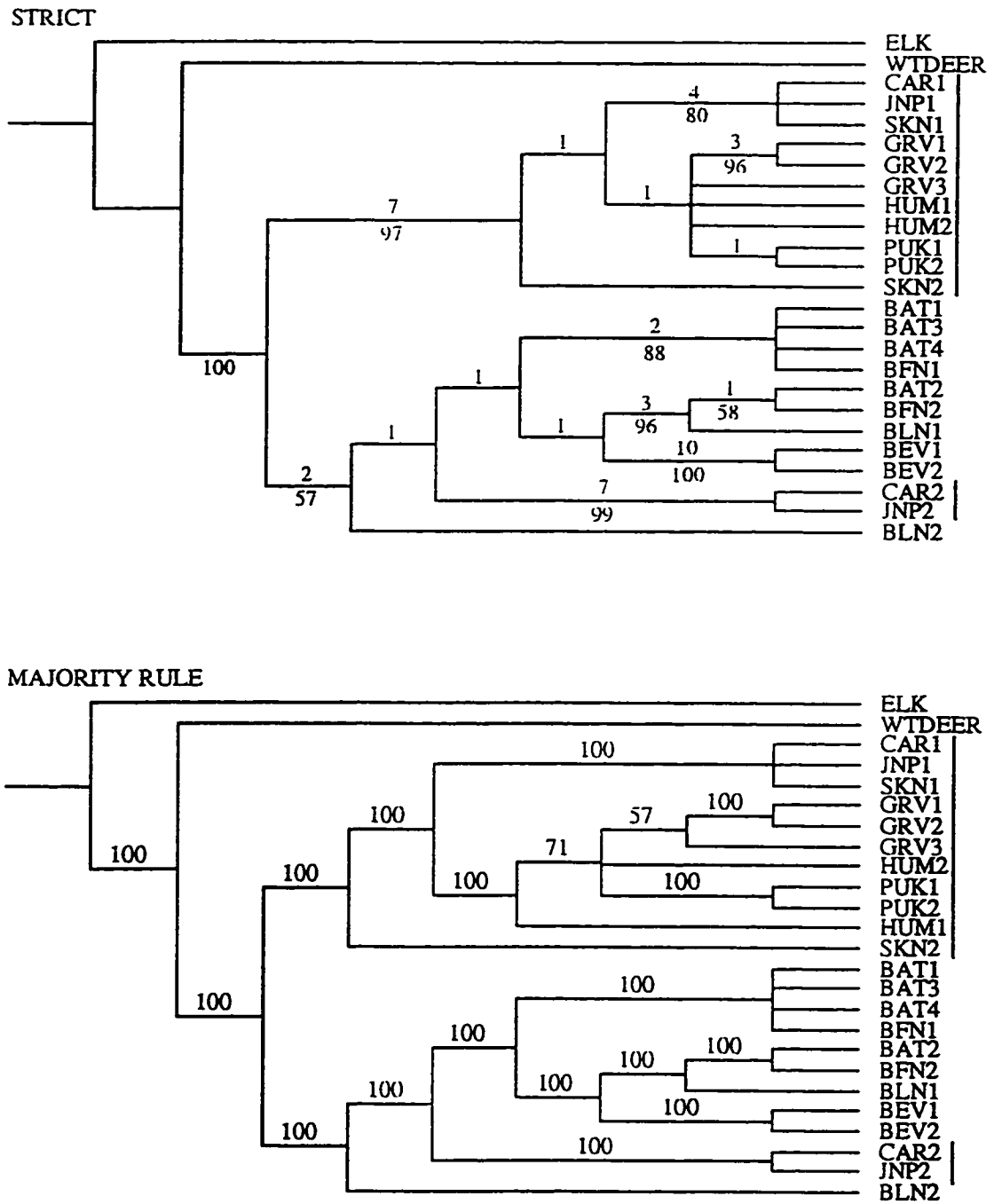

Figure 13. Consensus of 28 equally most parsimonious trees reconstructed from 1197 nt. alignment, excluding gaps, and weighting transitions:transversions 1:4. Caribou from woodland herds are labelled with a bar beside their name. For all trees, length = 400, CI = 0.875, and RC = 0.744.

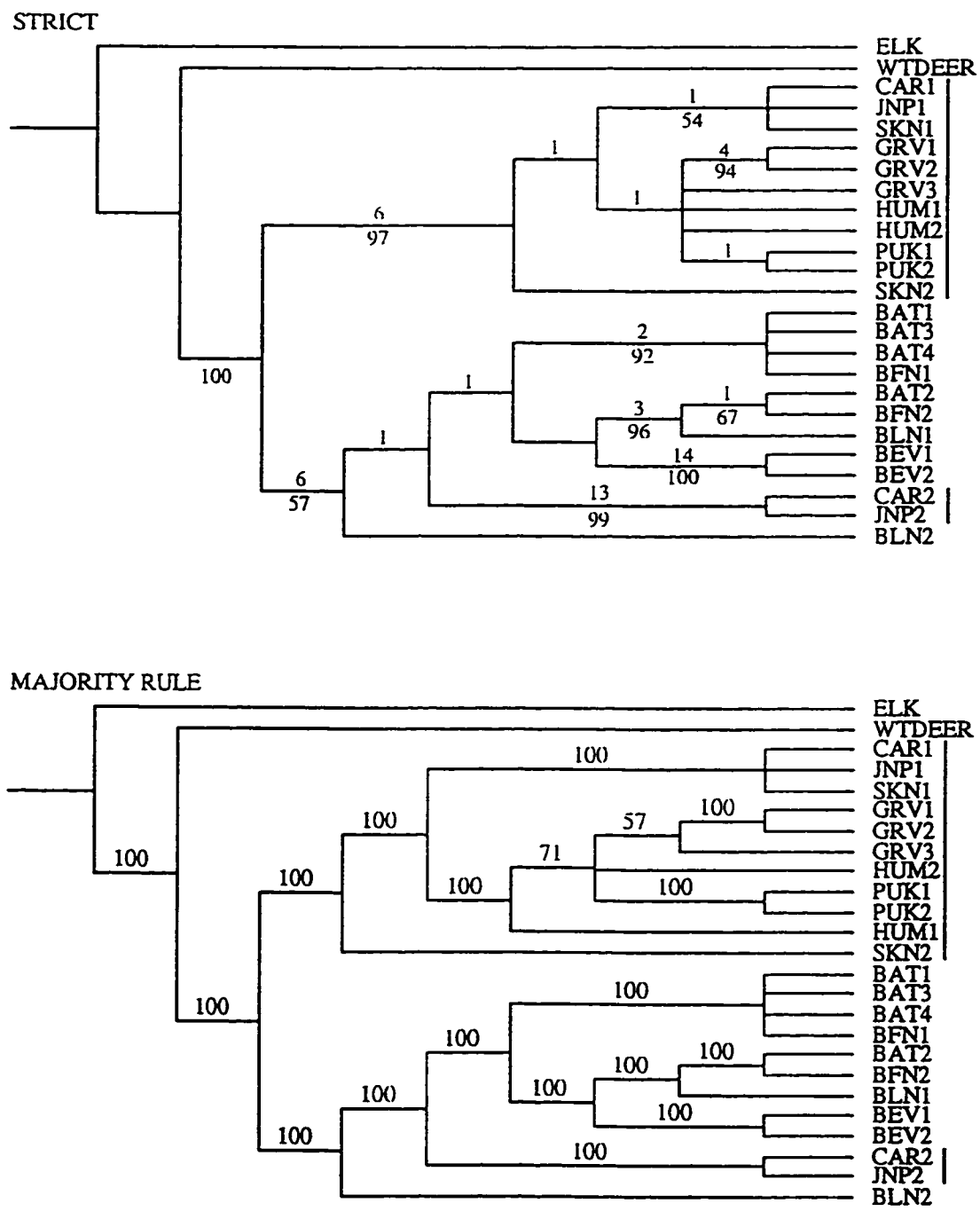

Figure 14. Consensus of 28 equally most parsimonious trees reconstructed from 1196 nt. alignment, excluding gaps, and weighting transitions:transversions 1:9. Caribou from woodland herds are labelled with a bar beside their name. For all trees, length = 640, CI = 0.914, and RC = 0.801.

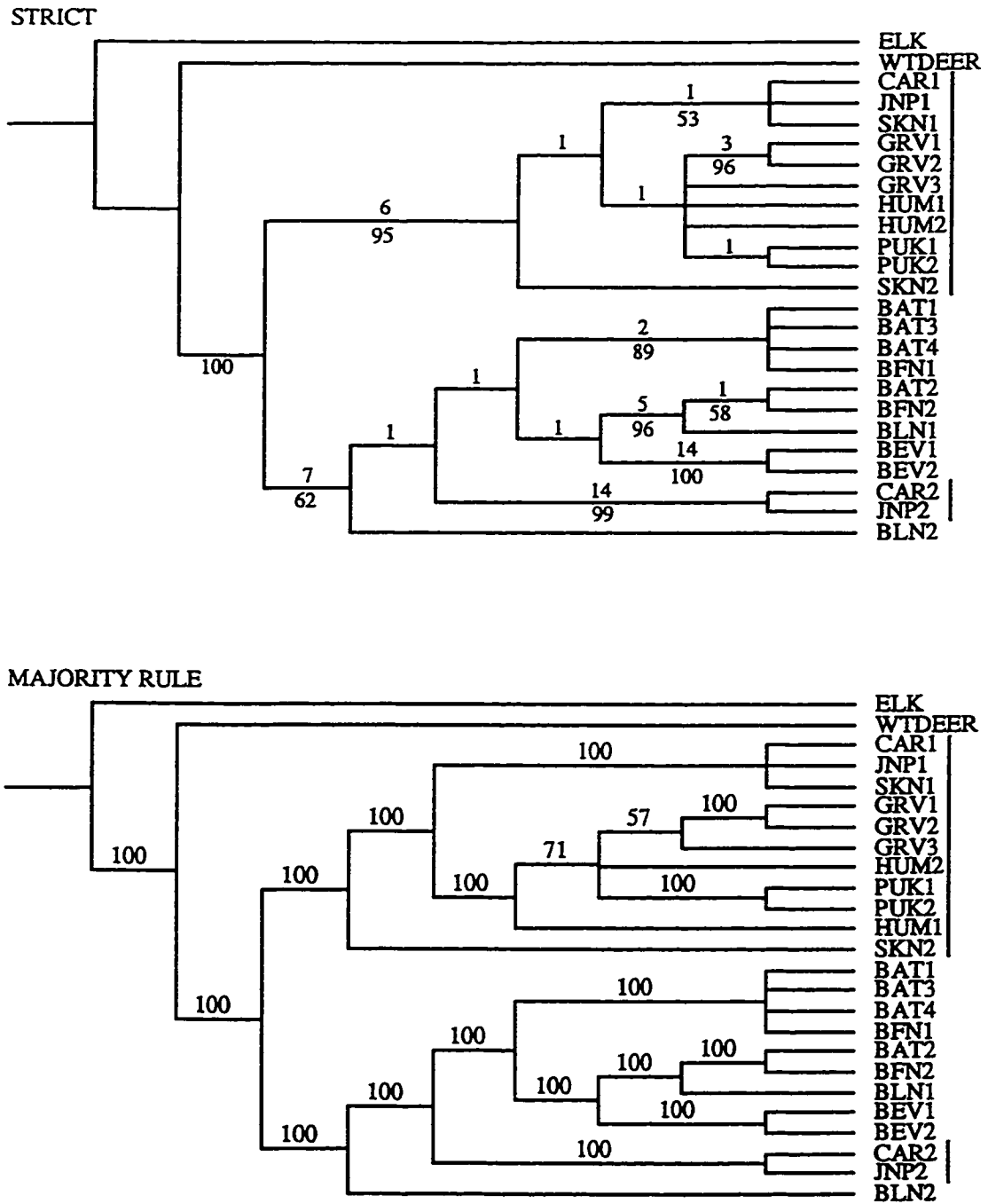

Figure 15. Consensus of 28 equally most parsimonious trees reconstructed from 1197 nt. alignment, excluding gaps, and weighting transitions:transversions 1:9. Caribou from woodland herds are labelled with a bar beside their name. For all trees, length = 640, CI = 0.914, and RC = 0.801.

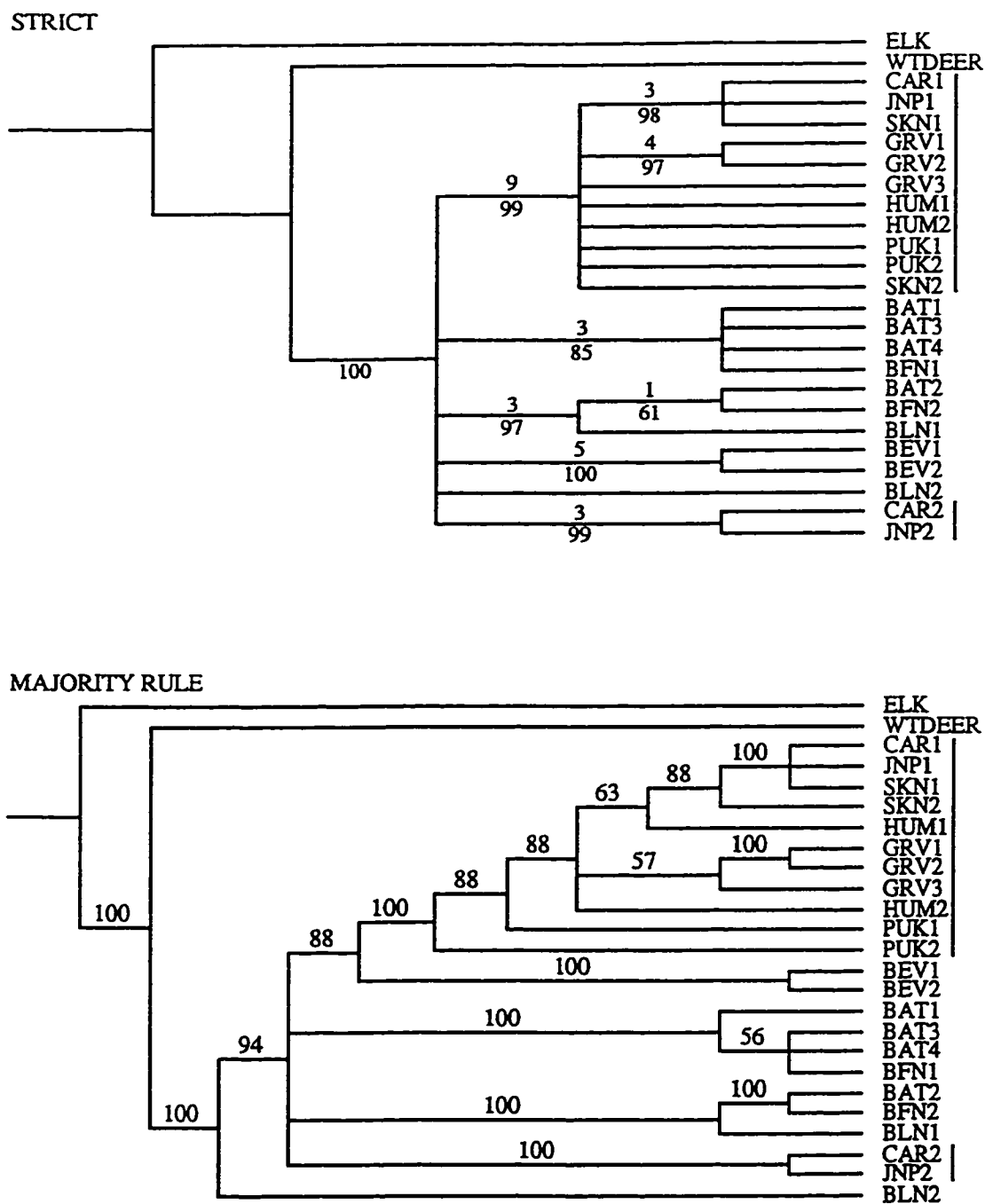

Figure 16. Consensus of 224 equally most parsimonious trees reconstructed from 1196 nt. alignment, treating gaps as a fifth character state, and weighting transitions:transversions 1:1. Caribou from woodland herds are labelled with a bar beside their name. For all trees, length = 462, CI = 0.885, and RC = 0.741.

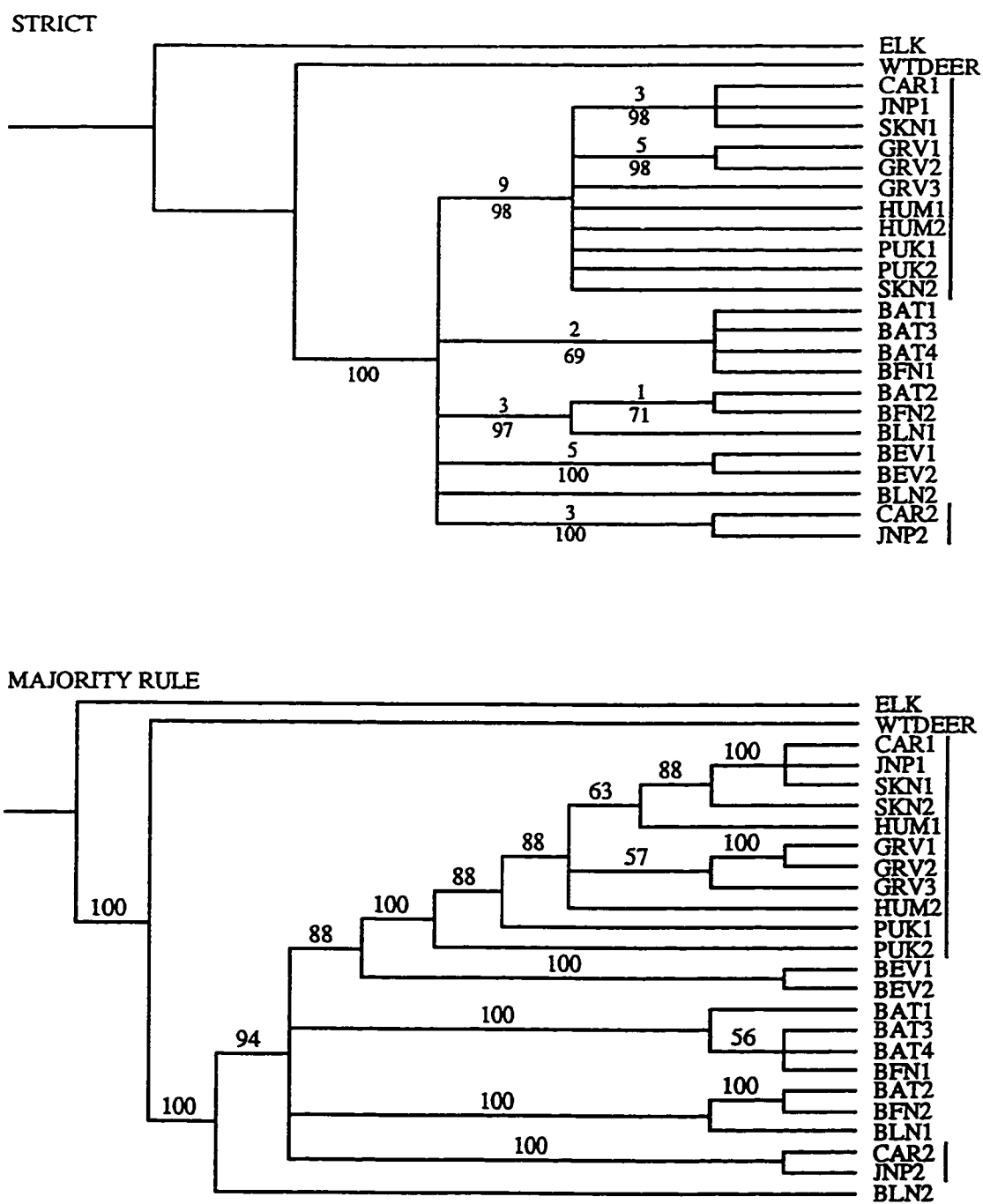

Figure 17. Consensus of 224 equally most parsimonious trees reconstructed from 1197 nt. alignment, treating gaps as a fifth character state, and weighting transitions:transversions 1:1. Caribou from woodland herds are labelled with a bar beside their name. For all trees, length = 464, CI = 0.884, and RC = 0.737.

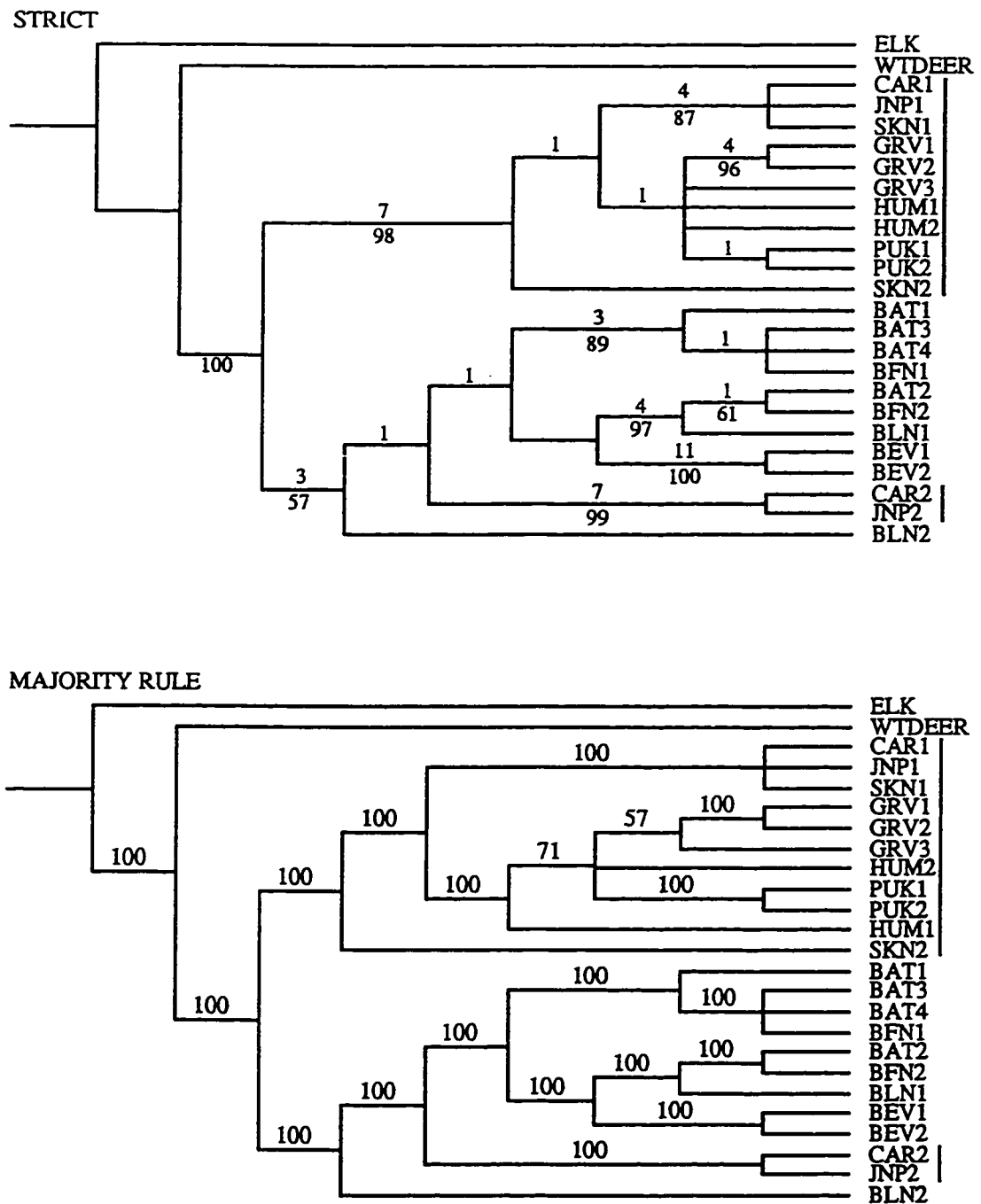

Figure 18. Consensus of 14 equally most parsimonious trees reconstructed from 1196 nt. alignment, treating gaps as a fifth character state, and weighting transitions:transversions 1:4. Caribou from woodland herds are labelled with a bar beside their name. For all trees, length = 706, CI = 0.919, and RC = 0.785.

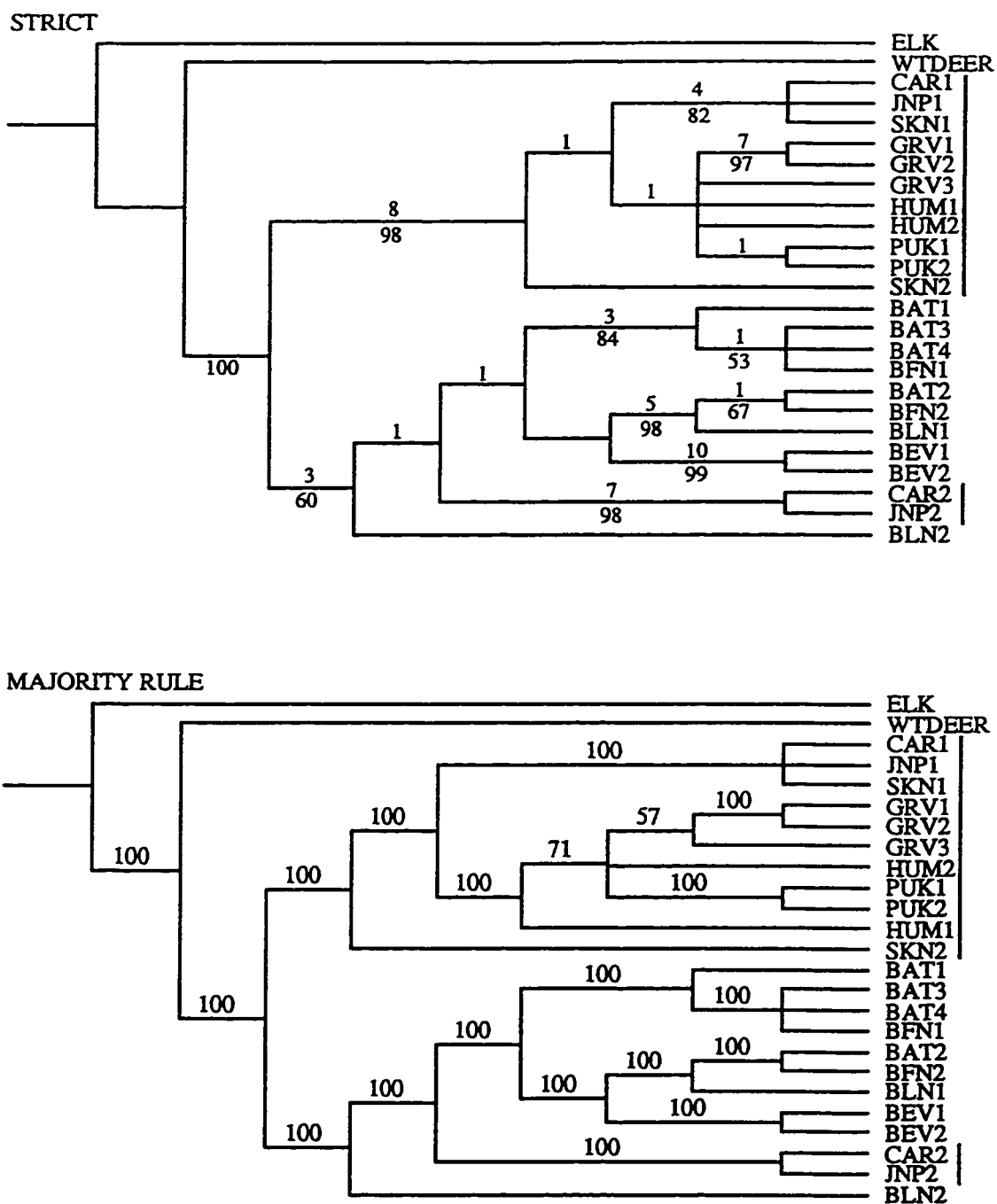

Figure 19. Consensus of 14 equally most parsimonious trees reconstructed from 1197 nt. alignment, treating gaps as a fifth character state, and weighting transitions:transversions 1:4. Caribou from woodland herds are labelled with a bar beside their name. For all trees, length = 708, CI = 0.918, and RC = 0.782.

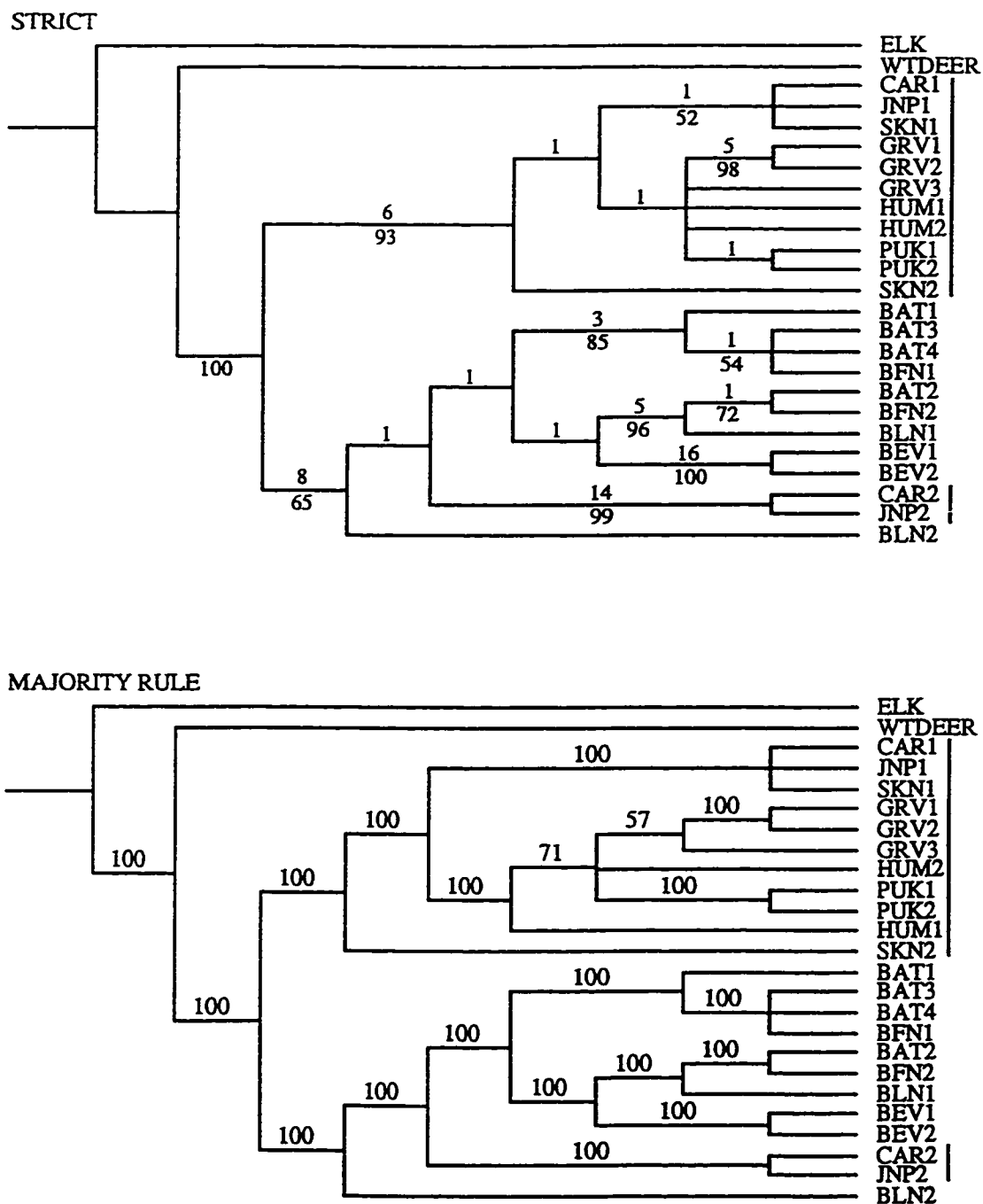

Figure 20. Consensus of 14 equally most parsimonious trees reconstructed from 1196 nt. alignment, treating gaps as a fifth character state, and weighting transitions:transversions 1:9. Caribou from woodland herds are labelled with a bar beside their name. For all trees, length = 1111, CI = 0.944, and RC = 0.827.

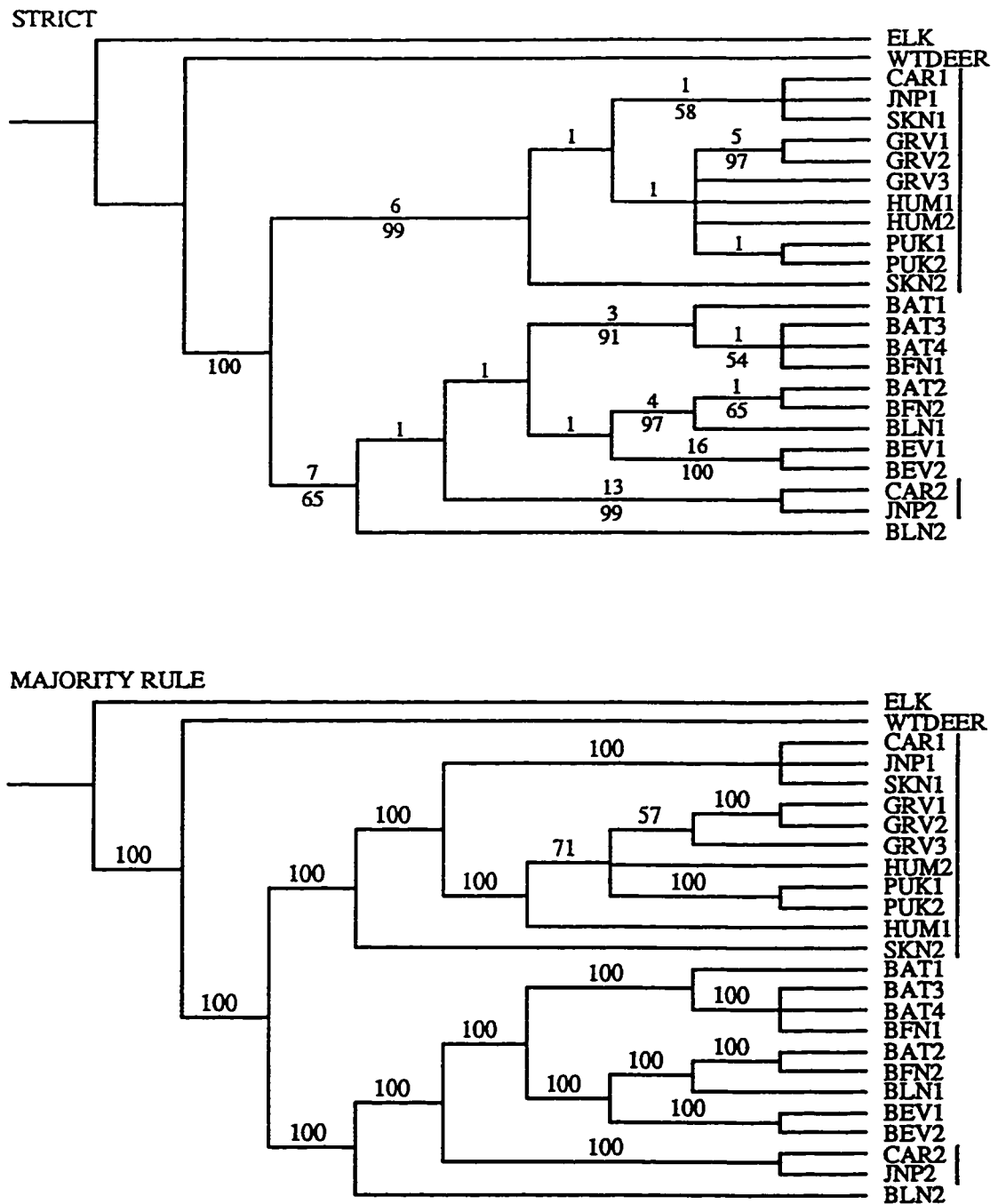

Figure 21. Consensus of 14 equally most parsimonious trees reconstructed from 1197 nt. alignment, treating gaps as a fifth character state, and weighting transitions:transversions 1:9. Caribou from woodland herds are labelled with a bar beside their name. For all trees, length = 1113, CI = 0.943, and RC = 0.825.

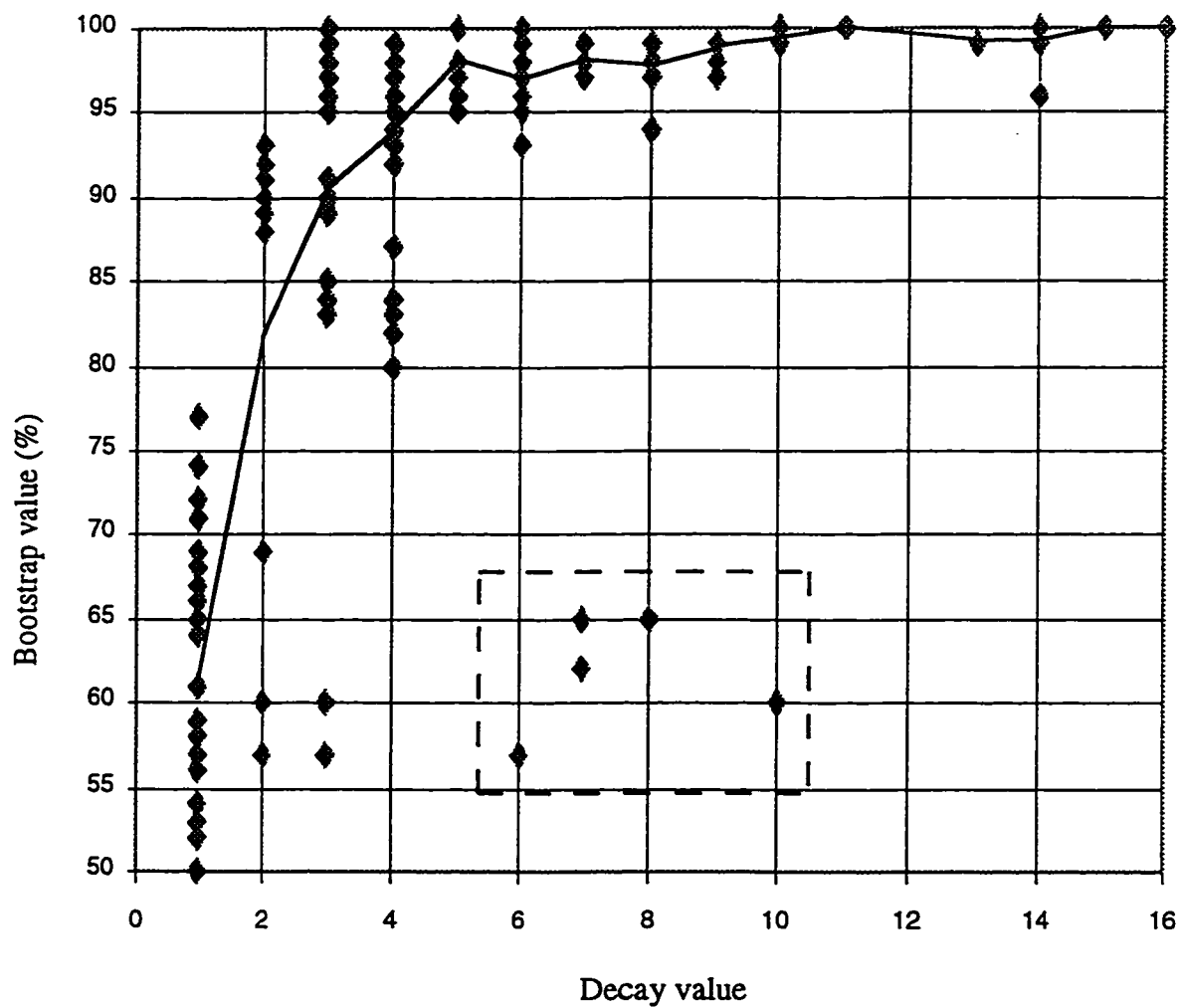

Figure 22. Scatterplot of bootstrap values versus decay values showing a line joining mean bootstrap values for each decay value. Note: decay=7 and bootstrap=65 contains two data points. Means do not include the six outlying points of low bootstrap value and high decay value.

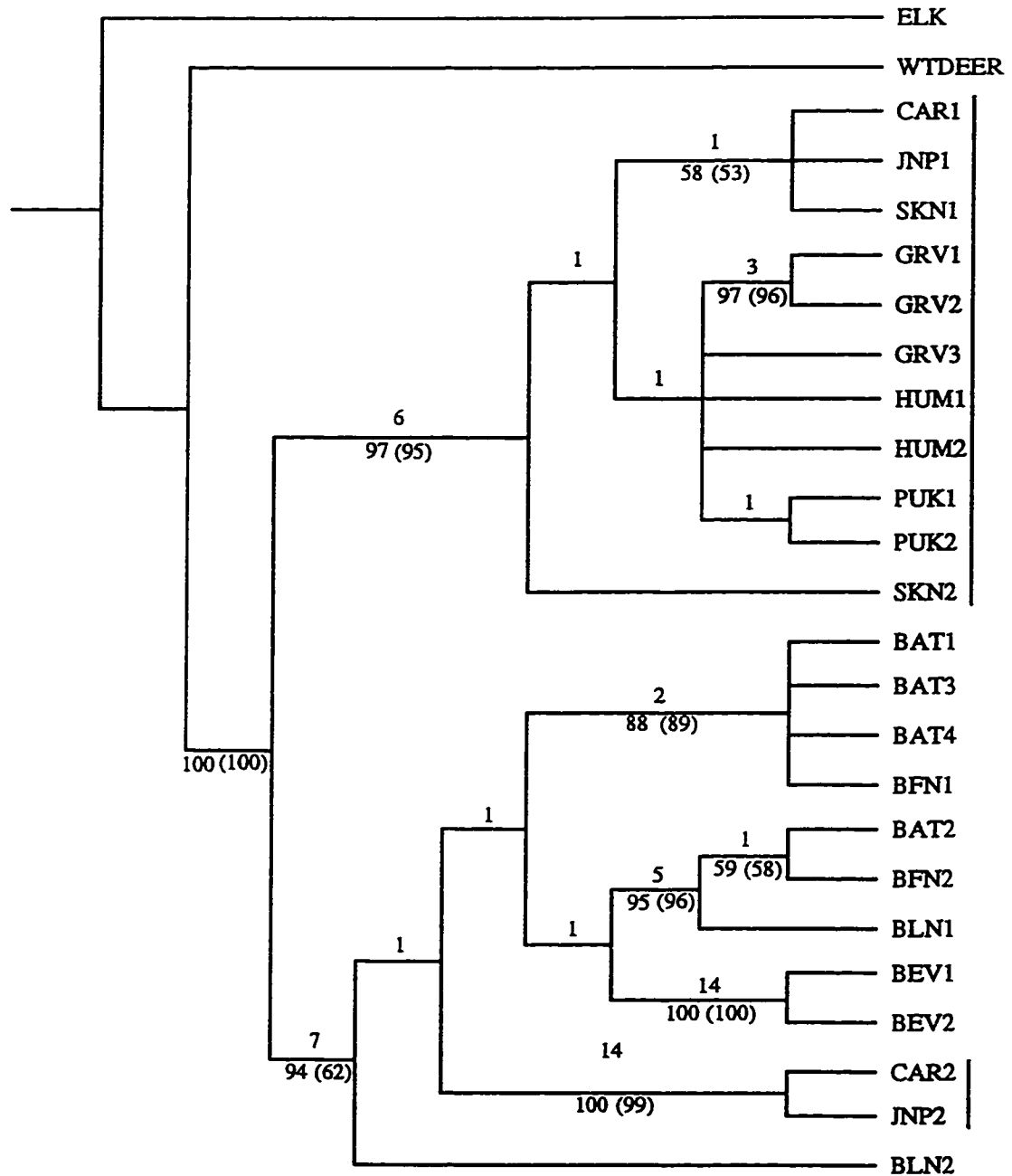

Figure 23. Strict consensus of 28 equally most parsimonious trees reconstructed from 1197 nt. alignment, excluding gaps, and weighting transitions:transversions 1:9. Caribou from woodland herds are labelled with a bar beside their name. For all trees, length =640, CI = 0.914, and RC = 0.801. Bootstrap values found by treating weighted characters by sampling with equal probability are in brackets, and bootstrap values found by treating weighted characters as repeat counts are not in brackets.

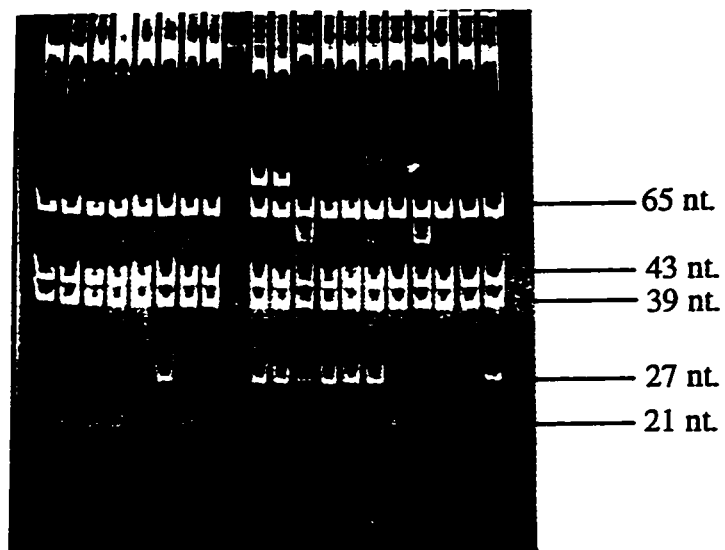

Figure 24. Diagnostic restriction fragments cut by *Alu* I.
A 27 nt. fragment is diagnostic of the northern mtDNA clade,
and a 21 nt. fragment is diagnostic of the southern mtDNA clade.

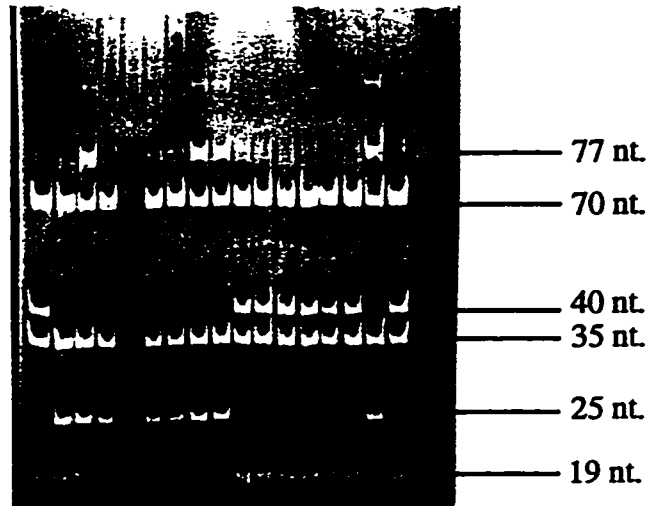

Figure 25. Diagnostic restriction fragments cut by *Rsa* I. A 40 nt. fragment is diagnostic of the northern mtDNA clade, and 25 nt. and 15 nt. fragments are diagnostic of the southern mtDNA clade.

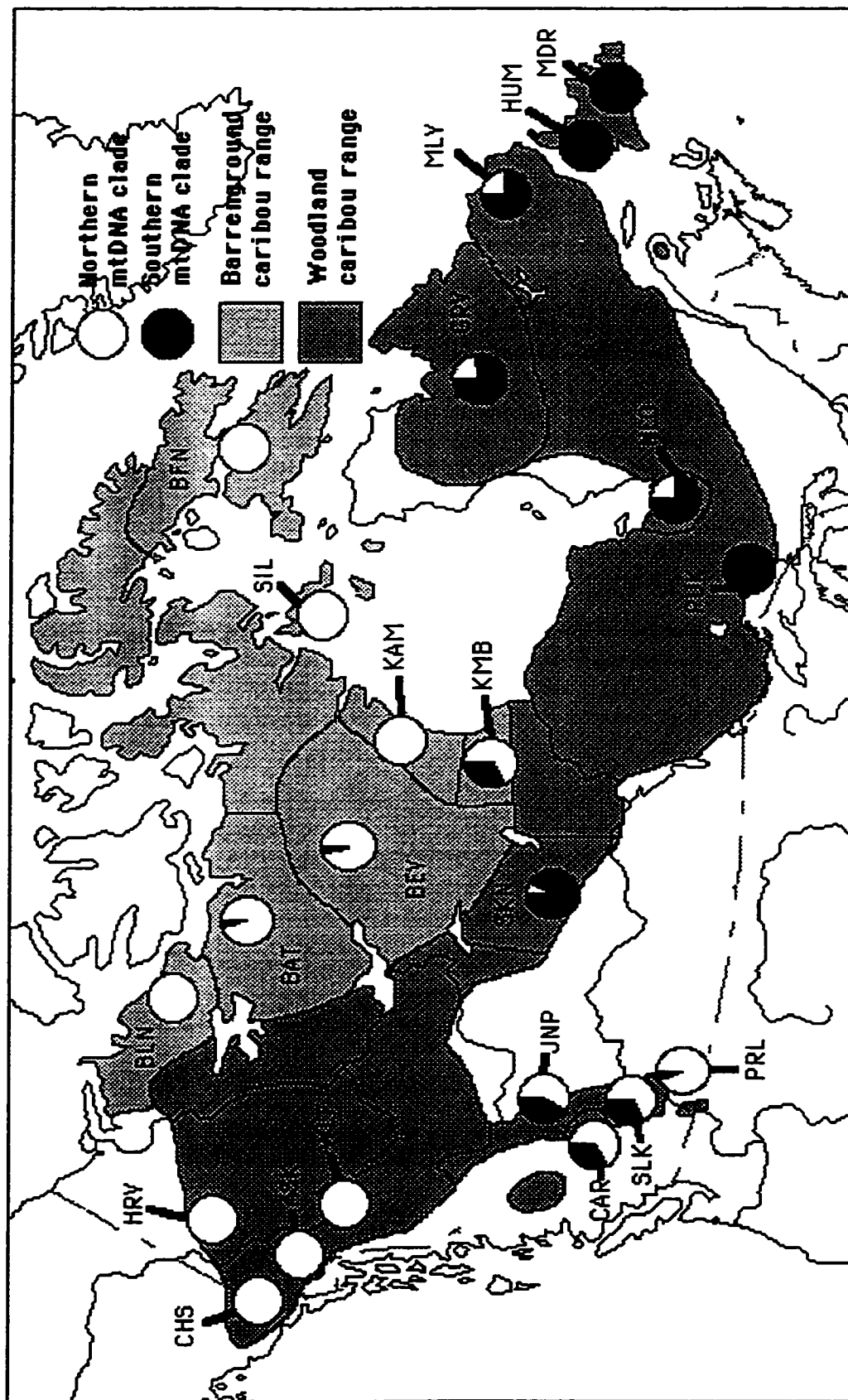

Figure 26. Regional distribution of mtDNA clades in woodland and borenground caribou.

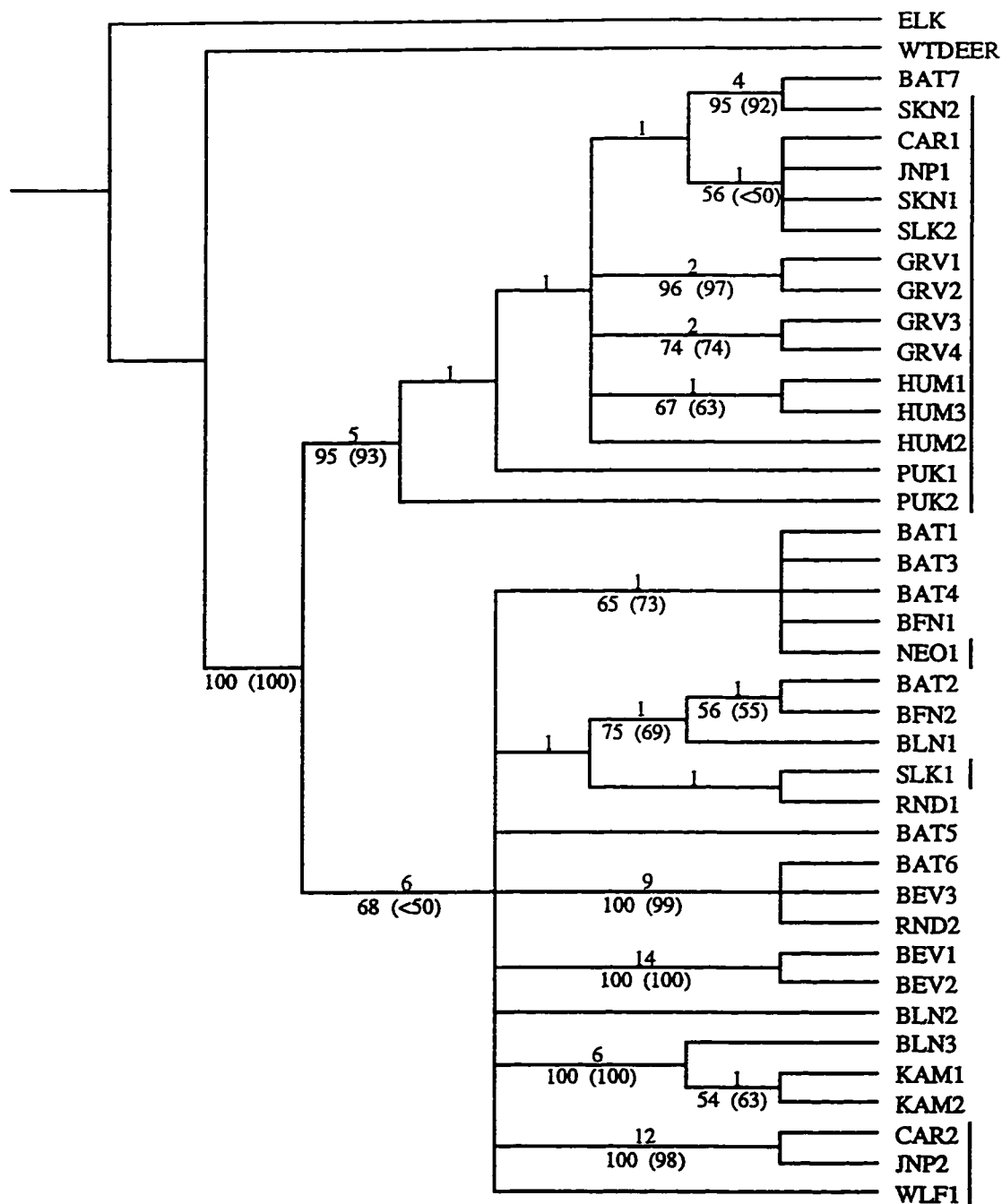

Figure 27. Strict consensus of 438 equally most parsimonious trees reconstructed from 1197 nt. alignment, excluding gaps, and weighting transitions:transversions 1:9. Caribou from woodland herds are labelled with a bar beside their name. For all trees, length =718, CI = 0.851, and RC = 0.718. Bootstrap values found by treating weighted characters by sampling with equal probability are in brackets, and bootstrap values found by treating weighted characters as repeat counts are not in brackets.

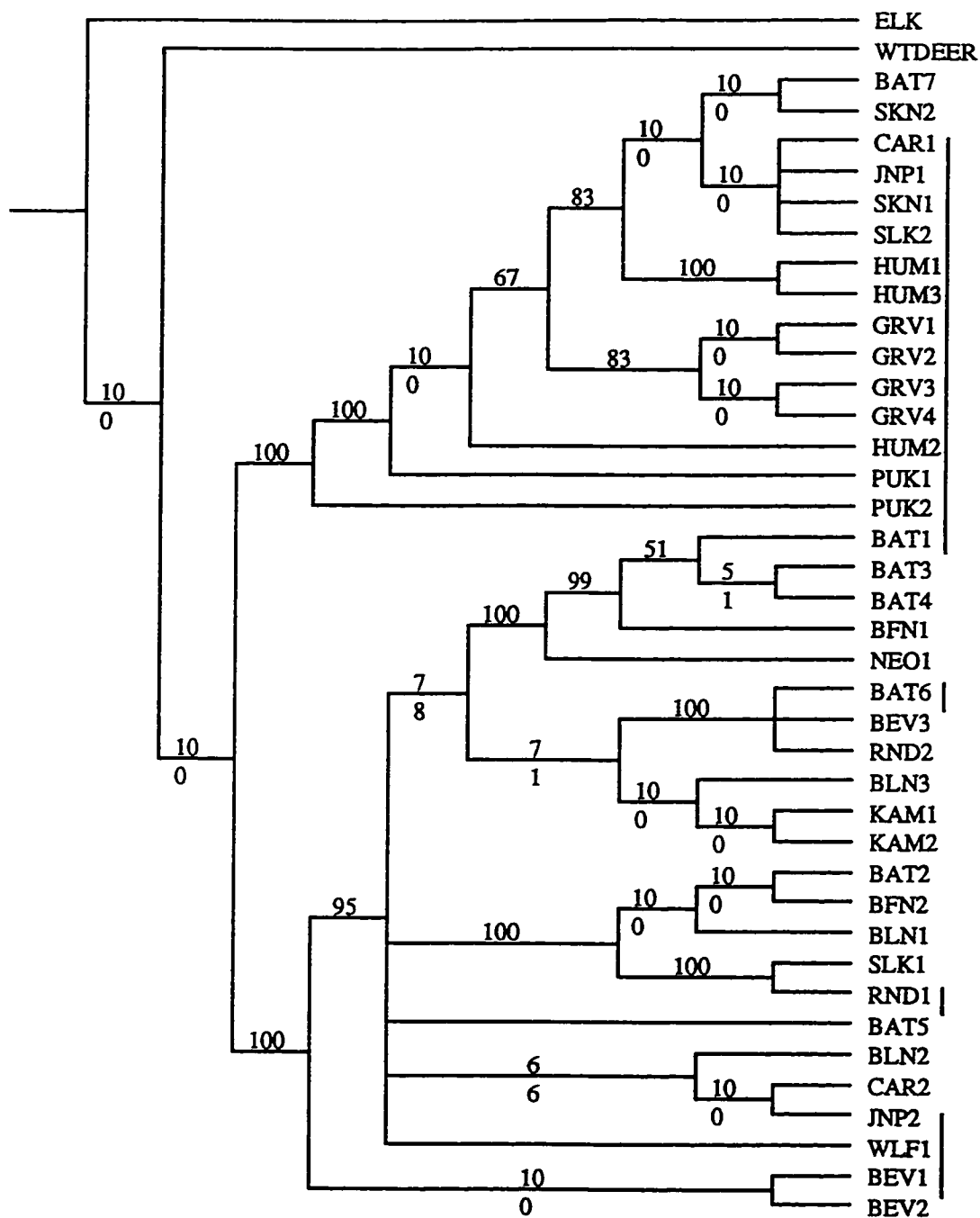

Figure 28. Majority-rule consensus of 438 equally most parsimonious trees reconstructed from 1197 nt. alignment, excluding gaps, and weighting transitions:transversions 1:9. Caribou from woodland herds are labelled with a bar beside their name. For all trees, length =718, CI = 0.851, and RC = 0.718.

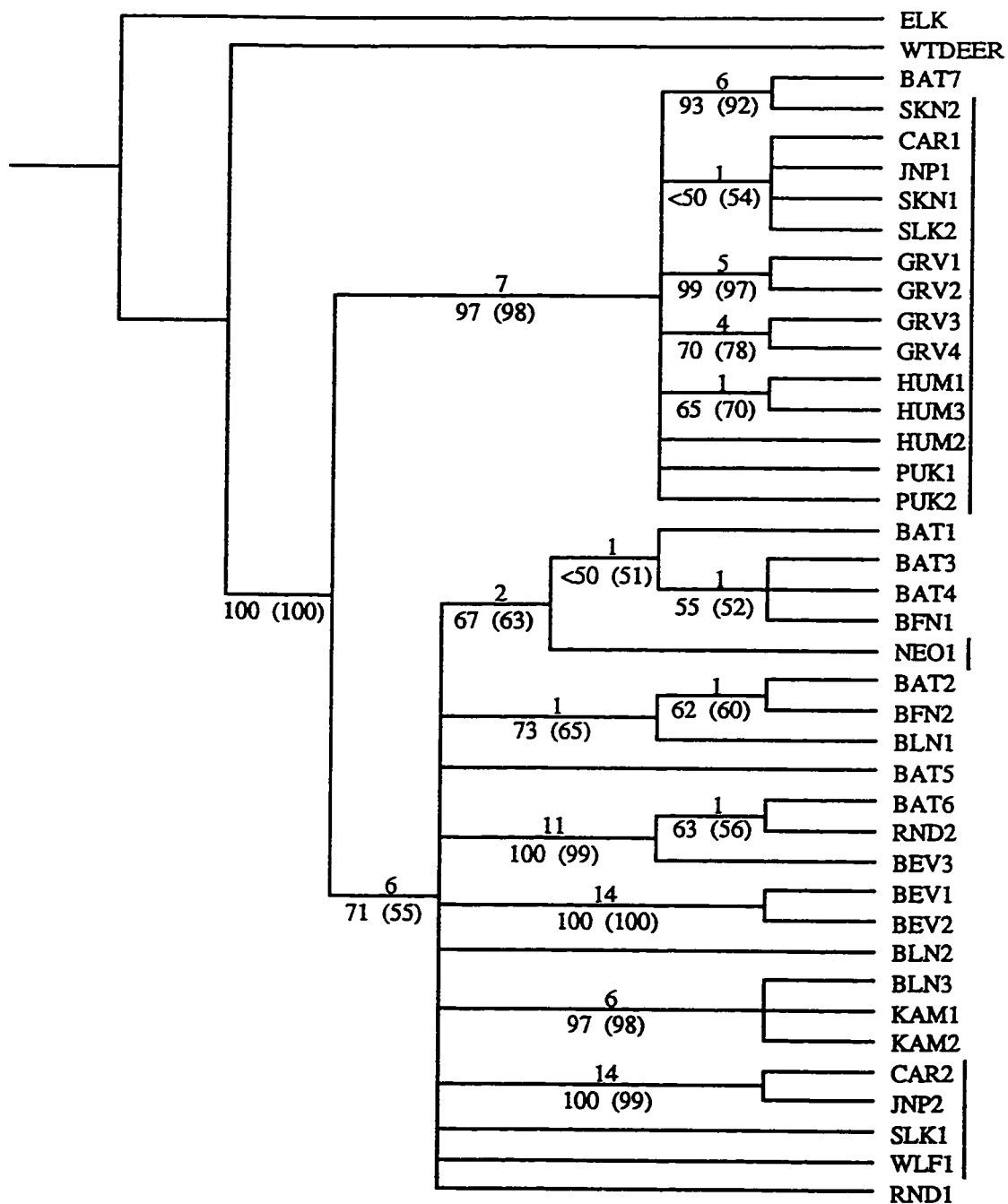

Figure 29. Strict consensus of 4666 equally most parsimonious trees reconstructed from 1197 nt. alignment, treating gaps as a fifth character state, and weighting transitions:transversions 1:9. Caribou from woodland herds are labelled with a bar beside their name. For all trees, length = 1199, CI = 0.897, and RC = 0.751. Bootstrap values found by treating weighted characters by sampling with equal probability are in brackets, and bootstrap values found by treating weighted characters as repeat counts are not in brackets.

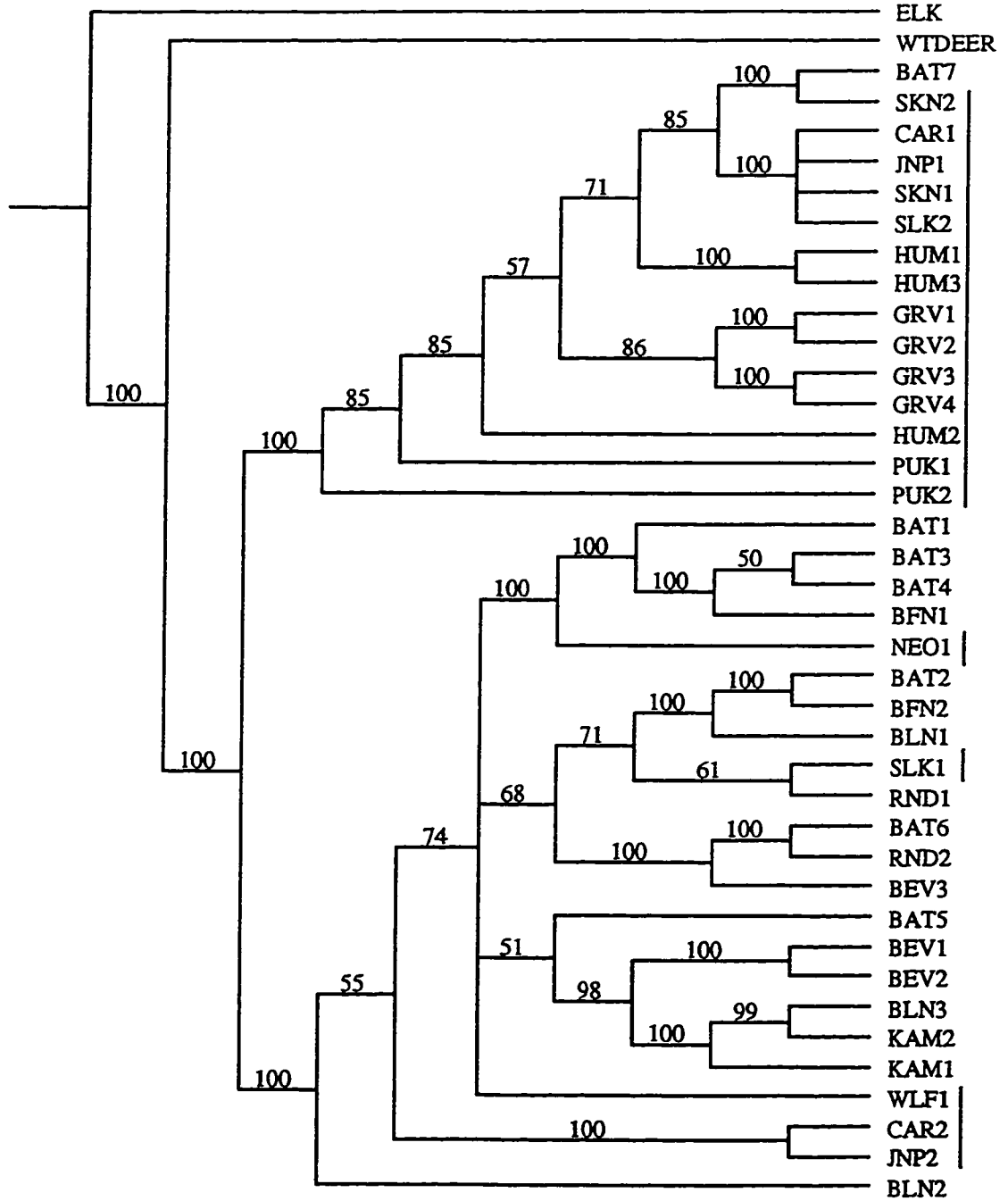

Figure 30. Majority-rule consensus of 4666 equally most parsimonious trees reconstructed from 1197 nt. alignment, treating gaps as a fifth character state, and weighting transitions:transversions 1:9. Caribou from woodland herds are labelled with a bar beside their name. For all trees, length = 1199, CI = 0.897, and RC = 0.751.

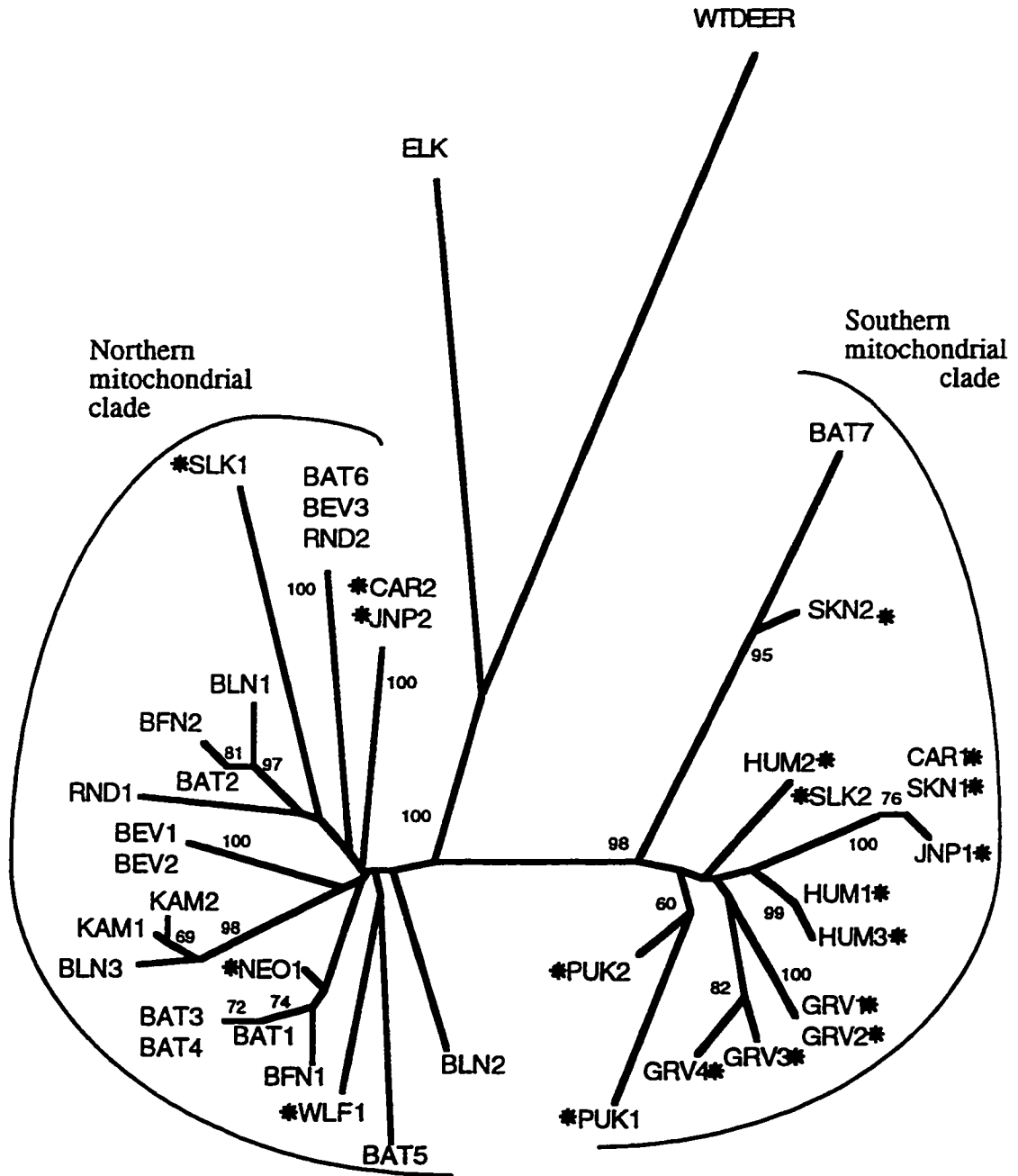

Figure 31. Neighbor joining tree reconstructed from 1197 nt. alignment, and weighting transitions:transversions 1:1. * represents caribou from woodland herds.

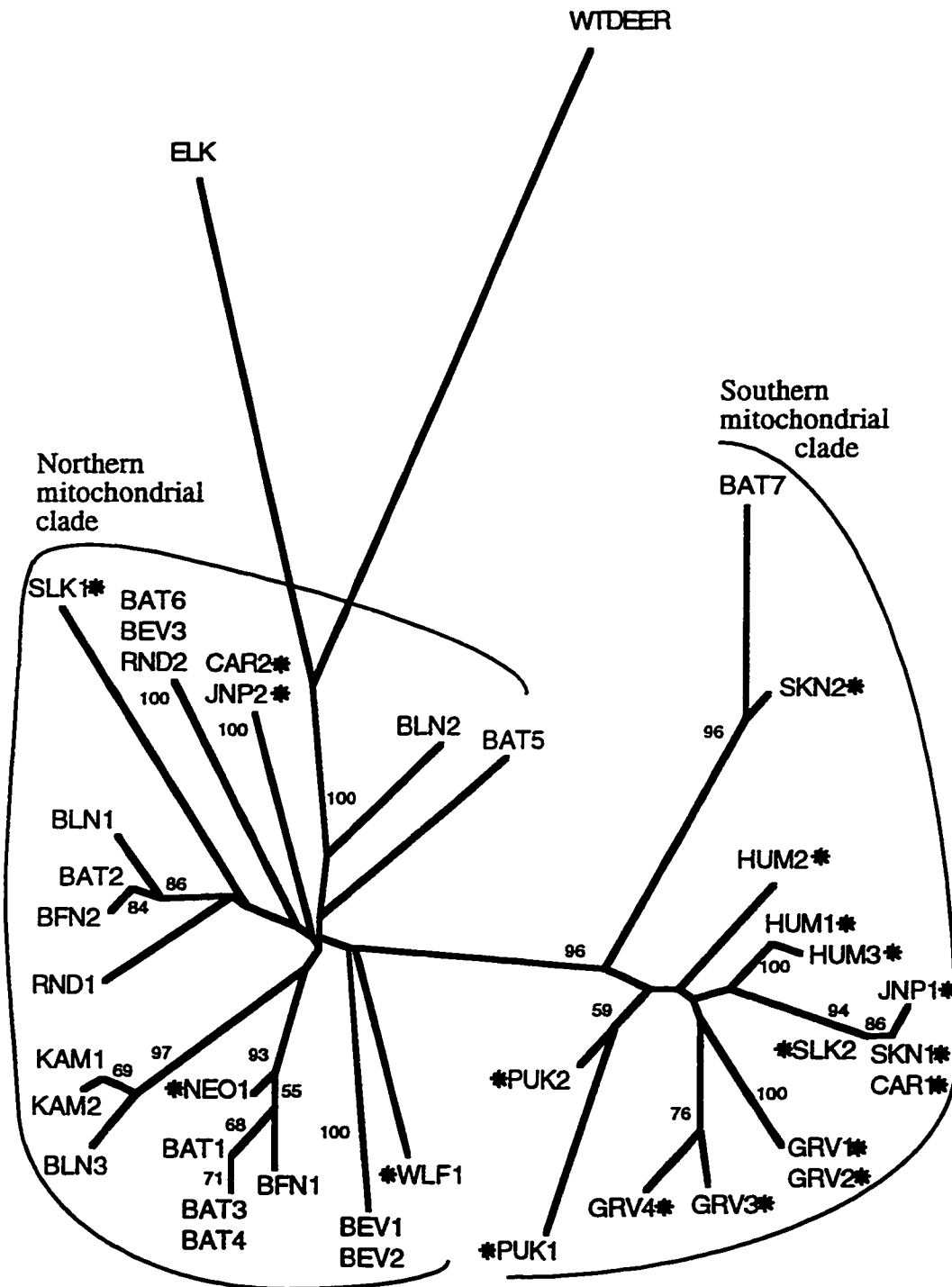

Figure 32. Neighbor joining tree reconstructed from 1197 nt. alignment, and weighting transitions:transversions 1:9. * represents caribou from woodland herds.

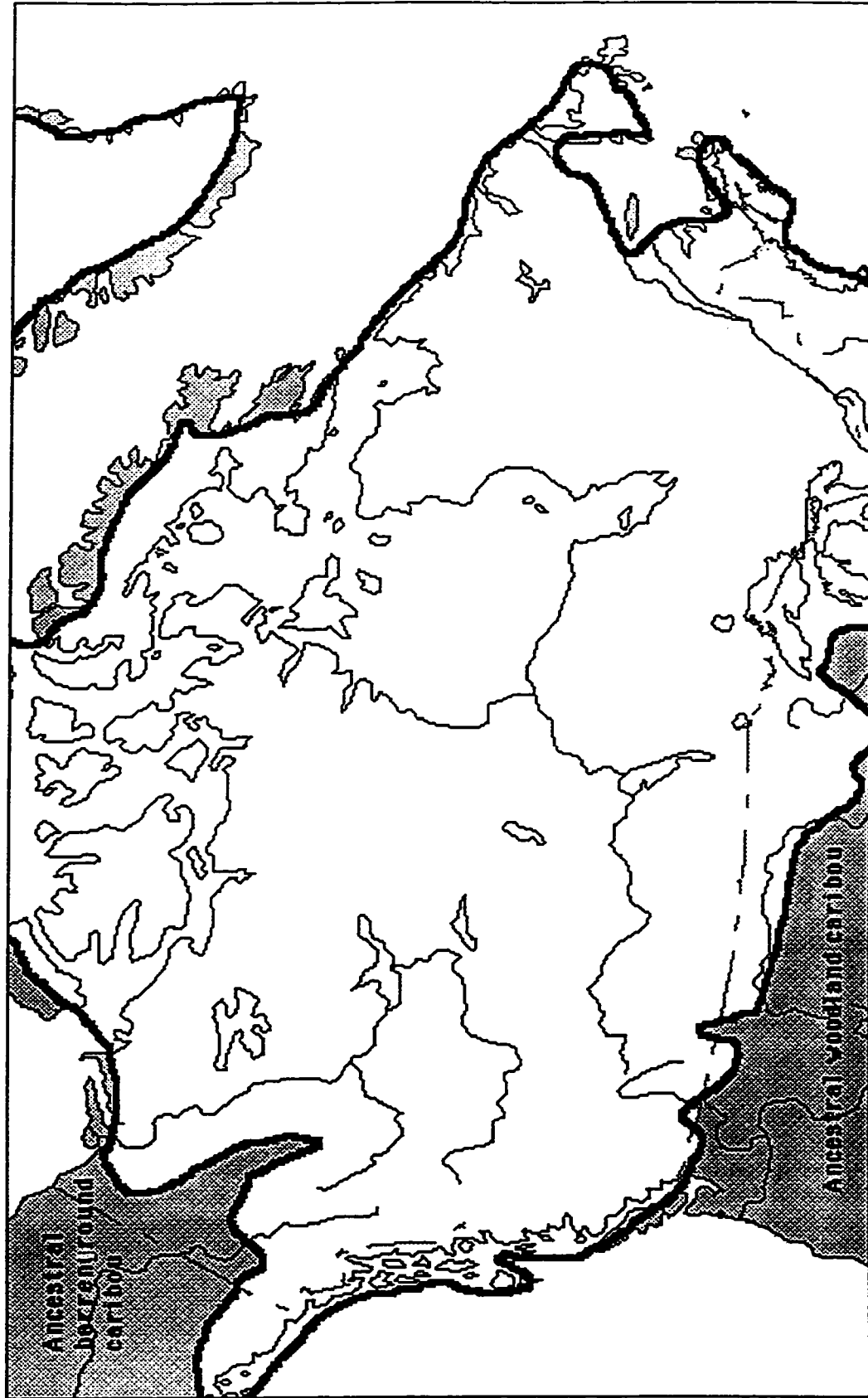

Figure 33a. Canada c. 18 kybp showing ice-free refugia inhabited by ancestral woodland and barren-ground caribou.

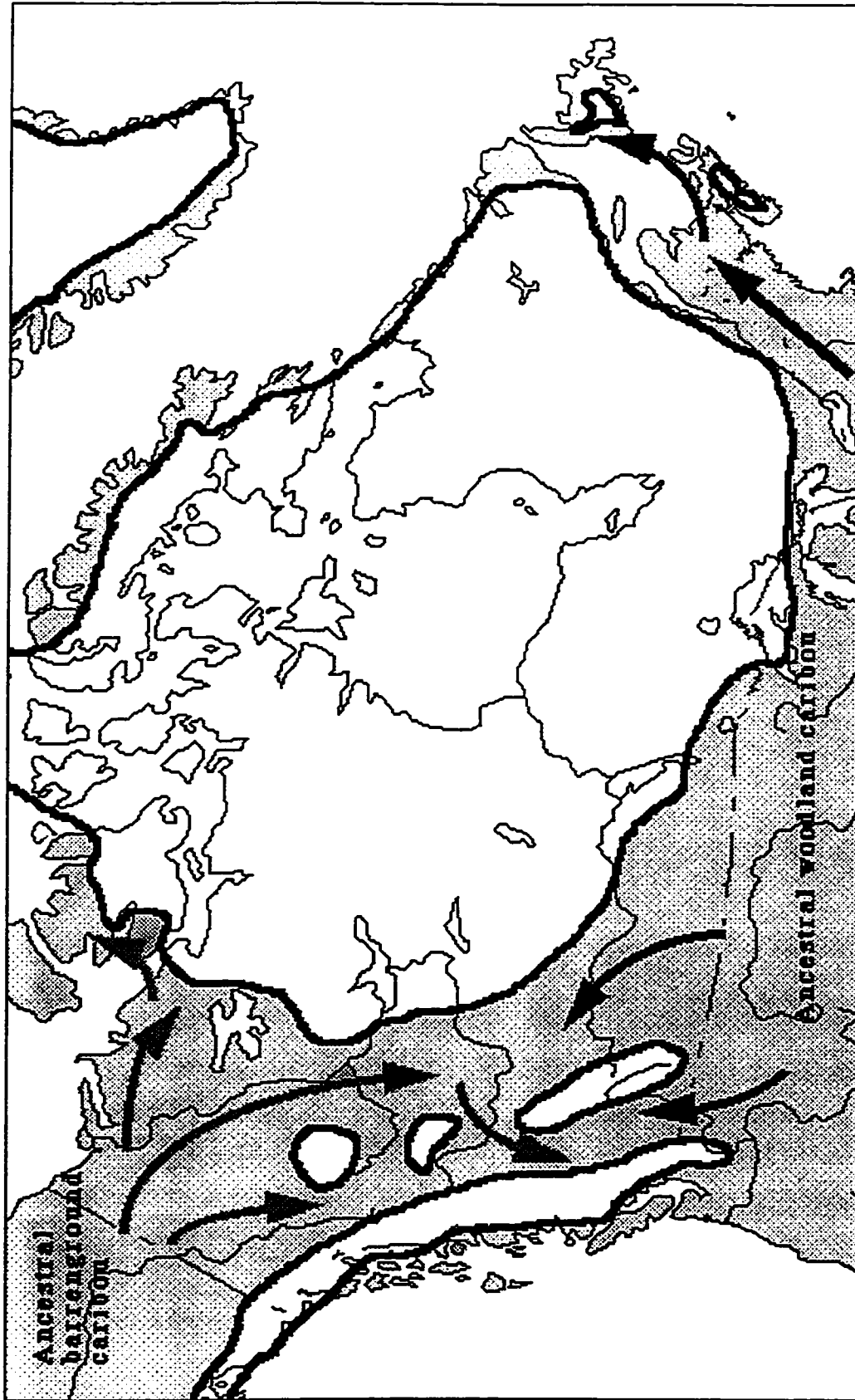

Figure 33b. Canada c. 11 kybp showing hypothesized post-glacial dispersal of woodland and barrenground caribou based on results presented in this thesis.

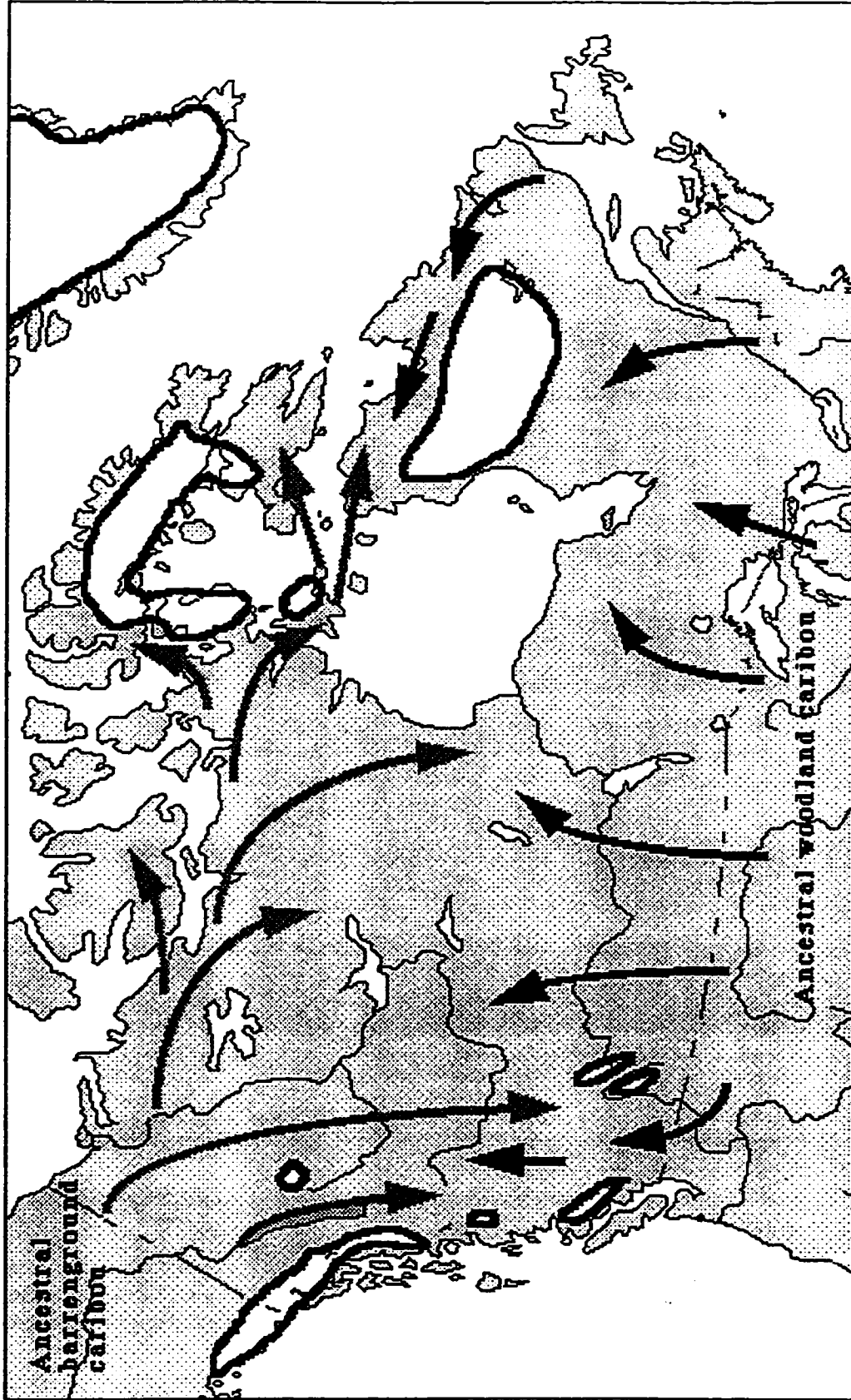

Figure 33c. Canada c. 7 kybp showing hypothesized post-glacial dispersal of woodland and barren-ground caribou based on results presented in this thesis.

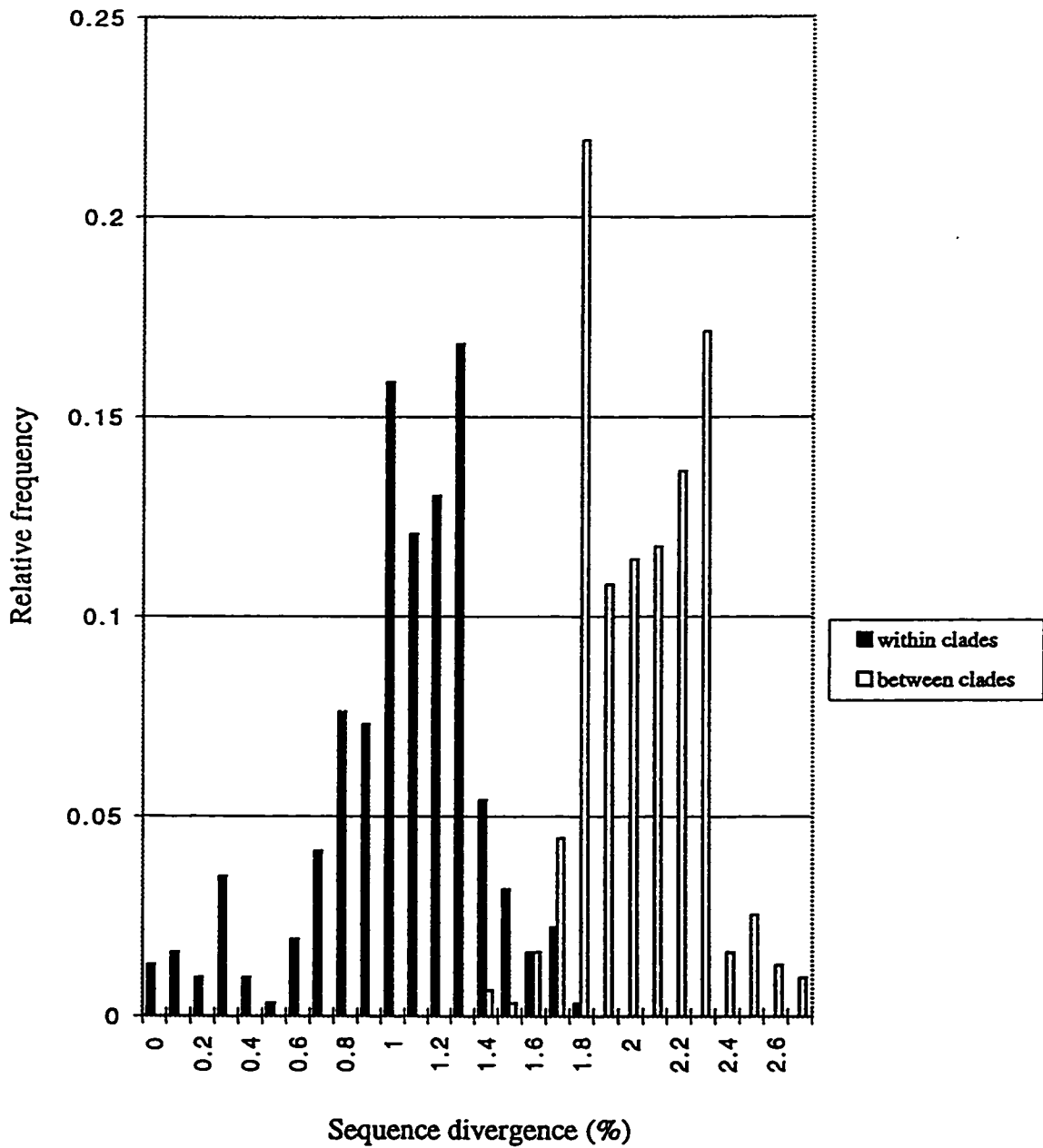

Figure 34. Frequency distribution within and between mtDNA clades, based on 630 pairwise mtDNA control region sequence divergences among 36 caribou

Abbreviation	Herd name and subspecies	Province or Territory
ASK	Aishihik, Woodland	Yukon Territory
BAT	Bathurst, Barrenground	Northwest Territories
BEV	Beverly, Barrenground	Northwest Territories
BFN	South Baffin, Barrenground	Northwest Territories
BLN	Bluenose, Barrenground	Northwest Territories
CAR	Cariboo Mountains, Woodland	British Columbia
CHS	Chisana, Woodland	Yukon Territory
GRV	George River, Woodland	Quebec & Labrador
HRV	Hart River, Woodland	Yukon Territory
HUM	Humber, Woodland	Newfoundland
JNP	Jasper National Park, Woodland	Alberta
KAM	Kaminuriak NWT, Barrenground	Northwest Territories
KMB	Kaminuriak Churchill, Barrenground	Manitoba
MDR	Middle Ridge, Woodland	Newfoundland
MLY	Mealy, Woodland	Labrador
PRL	South Purcell, Woodland	British Columbia
PUK	N. Lk. Superior/Pukaskwa, Woodland	Ontario
SIL	Southampton Island, Barrenground	Northwest Territories
SKN	Saskatchewan, Woodland	Saskatchewan
SLK	Central Selkirk, Woodland	British Columbia
WLF	Wolf Lake, Woodland	Yukon Territory

Table 1. Herd names and abbreviations used in this study.

<u>BARRENGROUND HERDS</u>	Northern mtDNA	Southern mtDNA	TOTAL
South Baffin, NWT	7 (100%)	0 (0%)	7
Bathurst, NWT	24 (96%)	1 (4%)	25
Beverly, NWT	22 (96%)	1 (4%)	23
Bluenose, NWT	25 (100%)	0 (0%)	25
Kaminuriak/Churchill, NWT/MB	10 (67%)	5 (33%)	15
Kaminuriak/Eskimo Point, NWT	20 (100%)	0 (0%)	20
Southampton Island, NWT	23 (100%)	0 (0%)	23
Total Barrenground	131 (95%)	7 (5%)	138
<u>WOODLAND HERDS</u>	Northern mtDNA	Southern mtDNA	
-MOUNTAIN WOODLAND			
Cariboo, BC	8 (67%)	4 (33%)	12
Jasper National Park, AB	9 (56%)	7 (44%)	16
South Purcell, BC	29 (94%)	2 (6%)	31
Central Selkirk, BC	14 (67%)	7 (33%)	21
Total Mountain Woodland	60 (75%)	20 (25%)	80
-YUKON WOODLAND			
Aishihik, YK	20 (100%)	0 (0%)	20
Chisana, YK	22 (100%)	0 (0%)	22
Hart River, YK	7 (100%)	0 (0%)	7
Wolf Lake, YK/BC	23 (100%)	0 (0%)	23
Total Yukon Woodland	72 (100%)	0 (0%)	72
-OTHER WOODLAND			
George River, NF/PQ	4 (22%)	14 (78%)	18
Humber, NF	0 (0%)	9 (100%)	9
Mealy, NF	3 (23%)	10 (77%)	13
Middle Range, NF	0 (0%)	10 (100%)	10
North Lake Superior, ON	0 (0%)	4 (100%)	4
North-East Ontario, ON/PQ	2 (25%)	6 (75%)	8
Saskatchewan, SK	1 (10%)	9 (90%)	10
Total Other Woodland	10 (14%)	62 (86%)	72

Table 2. Summary of diagnostic restriction digests.

	Alaska	Yukon	West- Mainland Tundra	East- Mainland Tundra	Baffin Island	Ungava peninsula	Rocky Mountains	Boreal region
Arctic Hare	Beringia	Beringia	Beringia	Beringia & south of ice-sheets	South of ice- sheets	South of ice- sheets	none	South of ice- sheets (limited to insular NF)
Collared & Ungava Lemming	Beringia	Beringia	Beringia	Beringia & south of ice-sheets	Beringia	South of ice- sheets	none	none
Brown Lemming	Beringia	Beringia	Beringia	Beringia	Beringia	none	South of ice- sheets	none
Red-backed vole	Beringia	Beringia	Beringia	Beringia	none	none	South of ice- sheets	South of ice- sheets
Ground squirrel	Beringia	Beringia	Beringia	Beringia	none	none	Beringia & south of ice-sheets	none
Masked shrew	Beringia & south of ice-sheets	Beringia & south of ice-sheets	Beringia	Beringia	none	none	South of ice- sheets	South of ice- sheets
Ermine	Beringia	Beringia & south of ice-sheets	Beringia	Beringia & south of ice-sheets	Beringia	South of ice- sheets	South of ice- sheets	South of ice- sheets
Caribou	Beringia	Beringia	Beringia	Beringia	Beringia	Beringia & south of ice-sheets	Beringia & south of ice-sheets	South of ice- sheets
Majority	Beringia	Beringia	Beringia	Beringia	Beringia	South of ice- sheets	South of ice- sheets	South of ice- sheets

Table 3. Comparison of phylogeographic patterns of eight arctic mammals. Interior cells of the table (not in bold) show the source of animals now living in the geographic regions at the top of the table. Caribou sources are based on results presented in this thesis. The last row in the table gives the source of the majority of the eight mammals for each geographic region.

SAMPLE	SEQUENCED	HERD	<i>Alu</i> 1 result	<i>Rsa</i> 1 result
1	no	Aishihik (YT)	northern	northern
2	no	Aishihik (YT)	northern	northern
3	no	Aishihik (YT)	northern	northern
4	no	Aishihik (YT)	northern	northern
5	no	Aishihik (YT)	northern	northern
6	no	Aishihik (YT)	northern	northern
7	no	Aishihik (YT)	northern	northern
8	no	Aishihik (YT)	northern	northern
9	no	Aishihik (YT)	northern	northern
10	no	Aishihik (YT)	northern	northern
11	no	Aishihik (YT)	northern	northern
12	no	Aishihik (YT)	northern	northern
13	no	Aishihik (YT)	northern	northern
14	no	Aishihik (YT)	northern	northern
15	no	Aishihik (YT)	northern	northern
16	no	Aishihik (YT)	northern	northern
17	no	Aishihik (YT)	northern	northern
18	no	Aishihik (YT)	northern	northern
19	no	Aishihik (YT)	northern	northern
20	no	Aishihik (YT)	northern	northern
5g-6f(BAT5)	yes	Bathurst (NWT)	northern	ambig
5g-3g(BAT6)	yes	Bathurst (NWT)	northern	ambig
5g-1h	no	Bathurst (NWT)	northern	northern
5g-3e	no	Bathurst (NWT)	northern	northern
5g-3i	no	Bathurst (NWT)	northern	northern
5g-4h	no	Bathurst (NWT)	northern	northern
5g-6d	no	Bathurst (NWT)	northern	northern
5g-6e	no	Bathurst (NWT)	northern	northern
5g-6i	no	Bathurst (NWT)	northern	northern
5g-7h	no	Bathurst (NWT)	northern	northern
5g-9d	no	Bathurst (NWT)	northern	northern
5g-9e	no	Bathurst (NWT)	northern	northern
5g-9f	no	Bathurst (NWT)	northern	northern
5g-9g	no	Bathurst (NWT)	northern	northern
5g-9i	no	Bathurst (NWT)	northern	northern
5h-3a	no	Bathurst (NWT)	northern	northern
5h-3b	no	Bathurst (NWT)	northern	northern
5h-3c	no	Bathurst (NWT)	northern	northern
5h-6a	no	Bathurst (NWT)	northern	northern
5h-6b	no	Bathurst (NWT)	northern	northern
5h-9a	no	Bathurst (NWT)	northern	northern
5h-9b	no	Bathurst (NWT)	northern	northern
5g-3c(BAT4)	yes	Bathurst (NWT)	northern	northern

Appendix. Summary of all samples.

SAMPLE	SEQUENCED	HERD	AluI result	RsaI result
5g-3d(BAT3)	yes	Bathurst (NWT)	northern	northern
5g-6c(BAT1)	yes	Bathurst (NWT)	northern	northern
5g-9c(BAT2)	yes	Bathurst (NWT)	northern	northern
5g-3f(BAT7)	yes	Bathurst (NWT)	southern	southern
5h-9f(BEV3)	yes	Beverly (NWT)	northern	ambig
11k-1b	no	Beverly (NWT)	northern	northern
11k-2b	no	Beverly (NWT)	northern	northern
11k-3b	no	Beverly (NWT)	northern	northern
11k-4b	no	Beverly (NWT)	northern	northern
11k-5b	no	Beverly (NWT)	northern	northern
11k-6b	no	Beverly (NWT)	northern	northern
11k-7b	no	Beverly (NWT)	northern	northern
11k-8b	no	Beverly (NWT)	northern	northern
5h-3f	no	Beverly (NWT)	northern	northern
5h-3g	no	Beverly (NWT)	northern	northern
5h-6f	no	Beverly (NWT)	northern	northern
5h-6g	no	Beverly (NWT)	northern	northern
5h-9e	no	Beverly (NWT)	northern	northern
5i-3a	no	Beverly (NWT)	northern	northern
5i-3e	no	Beverly (NWT)	northern	northern
5i-6a	no	Beverly (NWT)	northern	northern
5i-7e	no	Beverly (NWT)	northern	northern
5l-3d	no	Beverly (NWT)	northern	northern
5l-7d	no	Beverly (NWT)	northern	northern
5l-8c	no	Beverly (NWT)	northern	northern
5h-3e(BEV1)	yes	Beverly (NWT)	northern	northern
5h-6e(BEV2)	yes	Beverly (NWT)	northern	northern
5i-6f	no	Beverly (NWT)	southern	southern
11l-2g(BLN3)	yes	Bluenose (NWT)	northern	ambig
11l-1f	no	Bluenose (NWT)	northern	northern
11l-1g	no	Bluenose (NWT)	northern	northern
11l-2e	no	Bluenose (NWT)	northern	northern
11l-2f	no	Bluenose (NWT)	northern	northern
11l-3e	no	Bluenose (NWT)	northern	northern
11l-3f	no	Bluenose (NWT)	northern	northern
11l-3g	no	Bluenose (NWT)	northern	northern
11l-4f	no	Bluenose (NWT)	northern	northern
11l-4g	no	Bluenose (NWT)	northern	northern
11l-5e	no	Bluenose (NWT)	northern	northern
11l-5f	no	Bluenose (NWT)	northern	northern
11l-5g	no	Bluenose (NWT)	northern	northern
11l-6e	no	Bluenose (NWT)	northern	northern
11l-6f	no	Bluenose (NWT)	northern	northern

Appendix continued.

SAMPLE	SEQUENCED	HERD	AluI result	RsaI result
111-6g	no	Bluenose (NWT)	northern	northern
111-7e	no	Bluenose (NWT)	northern	northern
111-7f	no	Bluenose (NWT)	northern	northern
111-7g	no	Bluenose (NWT)	northern	northern
111-8e	no	Bluenose (NWT)	northern	northern
111-8f	no	Bluenose (NWT)	northern	northern
111-8g	no	Bluenose (NWT)	northern	northern
111-9e	no	Bluenose (NWT)	northern	northern
111-9f	no	Bluenose (NWT)	northern	northern
111-1e(BLN2)	yes	Bluenose (NWT)	northern	northern
111-4e(BLN1)	yes	Bluenose (NWT)	northern	northern
5f-1f	no	Cariboo (BC)	northern	northern
5f-3f	no	Cariboo (BC)	northern	northern
5f-4e	no	Cariboo (BC)	northern	northern
5f-4f	no	Cariboo (BC)	northern	northern
5f-5f	no	Cariboo (BC)	northern	northern
5f-6f	no	Cariboo (BC)	northern	northern
5f-8f	no	Cariboo (BC)	northern	northern
5f-2f(CAR2)	yes	Cariboo (BC)	northern	northern
5f-2e	no	Cariboo (BC)	southern	southern
5f-3e	no	Cariboo (BC)	southern	southern
5f-7f	no	Cariboo (BC)	southern	southern
5f-1e(CAR1)	yes	Cariboo (BC)	southern	southern
5f-2a	no	Central Selkirk (BC)	northern	northern
5f-3a	no	Central Selkirk (BC)	northern	northern
5f-3c	no	Central Selkirk (BC)	northern	northern
5f-4a	no	Central Selkirk (BC)	northern	northern
5f-4b	no	Central Selkirk (BC)	northern	northern
5f-4c	no	Central Selkirk (BC)	northern	northern
5f-5a	no	Central Selkirk (BC)	northern	northern
5f-5b	no	Central Selkirk (BC)	northern	northern
5f-6b	no	Central Selkirk (BC)	northern	northern
5f-7a	no	Central Selkirk (BC)	northern	northern
5f-9a	no	Central Selkirk (BC)	northern	northern
5f-9b	no	Central Selkirk (BC)	northern	northern
5f-6a(SLK1)	yes	Central Selkirk (BC)	northern	northern
5f-1b	no	Central Selkirk (BC)	southern	southern
5f-1c	no	Central Selkirk (BC)	southern	southern
5f-3b	no	Central Selkirk (BC)	southern	southern
5f-7b	no	Central Selkirk (BC)	southern	southern
5f-8a	no	Central Selkirk (BC)	southern	southern
5f-8b	no	Central Selkirk (BC)	southern	southern
5f-2c(SLK2)	yes	Central Selkirk (BC)	southern	southern

Appendix continued.

SAMPLE	SEQUENCED	HERD	AluI result	RsaI result
1	no	Chisana (YT)	northern	northern
2	no	Chisana (YT)	northern	northern
3	no	Chisana (YT)	northern	northern
4	no	Chisana (YT)	northern	northern
5	no	Chisana (YT)	northern	northern
6	no	Chisana (YT)	northern	northern
7	no	Chisana (YT)	northern	northern
8	no	Chisana (YT)	northern	northern
9	no	Chisana (YT)	northern	northern
10	no	Chisana (YT)	northern	northern
11	no	Chisana (YT)	northern	northern
12	no	Chisana (YT)	northern	northern
13	no	Chisana (YT)	northern	northern
14	no	Chisana (YT)	northern	northern
15	no	Chisana (YT)	northern	northern
16	no	Chisana (YT)	northern	northern
17	no	Chisana (YT)	northern	northern
18	no	Chisana (YT)	northern	northern
19	no	Chisana (YT)	northern	northern
20	no	Chisana (YT)	northern	northern
21	no	Chisana (YT)	northern	northern
22	no	Chisana (YT)	northern	northern
5a-1i	no	George River (NF/QC)	northern	northern
5a-6g	no	George River (NF/QC)	northern	northern
5d-1g	no	George River (NF/QC)	northern	northern
5e-4i	no	George River (NF/QC)	northern	northern
5d-4h(GRV4)	yes	George River (NF/QC)	southern	northern
5a-4i	no	George River (NF/QC)	southern	southern
5a-7h	no	George River (NF/QC)	southern	southern
5a-7i	no	George River (NF/QC)	southern	southern
5d-7f	no	George River (NF/QC)	southern	southern
5e-1i	no	George River (NF/QC)	southern	southern
5e-2i	no	George River (NF/QC)	southern	southern
5e-3i	no	George River (NF/QC)	southern	southern
5f-1h	no	George River (NF/QC)	southern	southern
5f-3i	no	George River (NF/QC)	southern	southern
5f-7g	no	George River (NF/QC)	southern	southern
5j-1h	no	George River (NF/QC)	southern	southern
5a-4f(GRV1)	yes	George River (NF/QC)	southern	southern
5d-7e(GRV2)	yes	George River (NF/QC)	southern	southern
5j-1i(GRV3)	yes	George River (NF/QC)	southern	southern
1	no	Hart River (YT)	northern	northern
2	no	Hart River (YT)	northern	northern

Appendix continued.

SAMPLE	SEQUENCED	HERD	AluI result	RsaI result
3	no	Hart River (YT)	northern	northern
4	no	Hart River (YT)	northern	northern
5	no	Hart River (YT)	northern	northern
6	no	Hart River (YT)	northern	northern
7	no	Hart River (YT)	northern	northern
8	no	Hart River (YT)	northern	northern
5d-7c(HUM3)	yes	Humber (NF)	southern	ambig
5d-1d	no	Humber (NF)	southern	southern
5d-3b	no	Humber (NF)	southern	southern
5d-3c	no	Humber (NF)	southern	southern
5d-3d	no	Humber (NF)	southern	southern
5d-4b	no	Humber (NF)	southern	southern
5d-5b	no	Humber (NF)	southern	southern
5d-5d	no	Humber (NF)	southern	southern
5d-1c(HUM2)	yes	Humber (NF)	southern	southern
5d-5c(HUM1)	yes	Humber (NF)	southern	southern
5a-1b	no	Jasper National Park (AB)	northern	northern
5a-2c	no	Jasper National Park (AB)	southern	southern
5a-3d	no	Jasper National Park (AB)	northern	northern
5a-4e	no	Jasper National Park (AB)	southern	southern
5a-5a	no	Jasper National Park (AB)	northern	northern
5a-6b	no	Jasper National Park (AB)	southern	southern
5a-7c	no	Jasper National Park (AB)	northern	northern
5a-8d	no	Jasper National Park (AB)	northern	northern
5e-2h	no	Jasper National Park (AB)	southern	southern
5f-1a	no	Jasper National Park (AB)	southern	southern
5j-2d(JNP2)	yes	Jasper National Park (AB)	northern	northern
5j-3c	no	Jasper National Park (AB)	northern	northern
5j-5d(JNP1)	yes	Jasper National Park (AB)	southern	southern
5j-8c	no	Jasper National Park (AB)	southern	southern
5j-8d	no	Jasper National Park (AB)	northern	northern
5j-8e	no	Jasper National Park (AB)	northern	northern
11f-2g	no	Kaminuriak/Churchill (MB)	northern	northern
11f-3f	no	Kaminuriak/Churchill (MB)	northern	northern
11f-3g	no	Kaminuriak/Churchill (MB)	northern	northern
11f-4f	no	Kaminuriak/Churchill (MB)	northern	northern
11f-4g	no	Kaminuriak/Churchill (MB)	northern	northern
11f-5f	no	Kaminuriak/Churchill (MB)	northern	northern
11f-5g	no	Kaminuriak/Churchill (MB)	northern	northern
11f-7f	no	Kaminuriak/Churchill (MB)	northern	northern
11f-8f	no	Kaminuriak/Churchill (MB)	northern	northern
11f-9f	no	Kaminuriak/Churchill (MB)	northern	northern
11f-1f	no	Kaminuriak/Churchill (MB)	southern	southern

Appendix continued.

SAMPLE	SEQUENCED	HERD	AluI result	RsaI result
11f-1g	no	Kaminuriak/Churchill (MB)	southern	southern
11f-2f	no	Kaminuriak/Churchill (MB)	southern	southern
11f-6f	no	Kaminuriak/Churchill (MB)	southern	southern
11f-6g	no	Kaminuriak/Churchill (MB)	southern	southern
5b-1f	no	Kaminuriak/Eskimo Pt. (NWT)	northern	northern
5b-1h	no	Kaminuriak/Eskimo Pt. (NWT)	northern	northern
5b-2f	no	Kaminuriak/Eskimo Pt. (NWT)	northern	northern
5b-2g	no	Kaminuriak/Eskimo Pt. (NWT)	northern	northern
5b-2h	no	Kaminuriak/Eskimo Pt. (NWT)	northern	northern
5b-3g	no	Kaminuriak/Eskimo Pt. (NWT)	northern	northern
5b-4f	no	Kaminuriak/Eskimo Pt. (NWT)	northern	northern
5b-4g	no	Kaminuriak/Eskimo Pt. (NWT)	northern	northern
5b-4h	no	Kaminuriak/Eskimo Pt. (NWT)	northern	northern
5b-5f	no	Kaminuriak/Eskimo Pt. (NWT)	northern	northern
5b-5g	no	Kaminuriak/Eskimo Pt. (NWT)	northern	northern
5b-5h	no	Kaminuriak/Eskimo Pt. (NWT)	northern	northern
5b-6f	no	Kaminuriak/Eskimo Pt. (NWT)	northern	northern
5b-6g	no	Kaminuriak/Eskimo Pt. (NWT)	northern	northern
5b-6h	no	Kaminuriak/Eskimo Pt. (NWT)	northern	northern
5b-7f	no	Kaminuriak/Eskimo Pt. (NWT)	northern	northern
5b-7g	no	Kaminuriak/Eskimo Pt. (NWT)	northern	northern
5b-8h	no	Kaminuriak/Eskimo Pt. (NWT)	northern	northern
5b-9f	no	Kaminuriak/Eskimo Pt. (NWT)	northern	northern
5b-9g	no	Kaminuriak/Eskimo Pt. (NWT)	northern	northern
5b-7h(KAM2)	yes	Kaminuriak/Eskimo Pt. (NWT)	northern	southern
5b-1g(KAM1)	yes	Kaminuriak/Eskimo Pt. (NWT)	northern	southern
5j-1a	no	Mealy (NF)	northern	northern
5j-1b	no	Mealy (NF)	northern	northern
5j-8b	no	Mealy (NF)	northern	northern
5j-2a	no	Mealy (NF)	southern	southern
5j-3a	no	Mealy (NF)	southern	southern
5j-3b	no	Mealy (NF)	southern	southern
5j-4b	no	Mealy (NF)	southern	southern
5j-5a	no	Mealy (NF)	southern	southern
5j-5b	no	Mealy (NF)	southern	southern
5j-6a	no	Mealy (NF)	southern	southern
5j-7a	no	Mealy (NF)	southern	southern
5j-7b	no	Mealy (NF)	southern	southern
5j-9a	no	Mealy (NF)	southern	southern
5d-1a	no	Middle Ridge (NF)	southern	southern
5d-1b	no	Middle Ridge (NF)	southern	southern
5d-2b	no	Middle Ridge (NF)	southern	southern
5d-3a	no	Middle Ridge (NF)	southern	southern

Appendix continued.

SAMPLE	SEQUENCED	HERD	AluI result	RsaI result
5d-4a	no	Middle Ridge (NF)	southern	southern
5d-5a	no	Middle Ridge (NF)	southern	southern
5d-6a	no	Middle Ridge (NF)	southern	southern
5d-7a	no	Middle Ridge (NF)	southern	southern
5d-8a	no	Middle Ridge (NF)	southern	southern
5d-9a	no	Middle Ridge (NF)	southern	southern
5a-1f	no	N. Lk. Superior/Pukaskwa (ON)	southern	southern
9l-1h	no	N. Lk. Superior/Pukaskwa (ON)	southern	southern
5a-2f(PUK2)	yes	N. Lk. Superior/Pukaskwa (ON)	southern	southern
9l-4h(PUK1)	yes	N. Lk. Superior/Pukaskwa (ON)	southern	southern
11g-1i(NEO1)	yes	North-East Ontario (ON)	northern	northern
11g-2i	no	North-East Ontario (ON)	southern	southern
11g-3i	no	North-East Ontario (ON)	southern	southern
11g-4i	no	North-East Ontario (ON)	southern	southern
11g-5i	no	North-East Ontario (ON)	southern	southern
11g-6i	no	North-East Ontario (ON)	southern	southern
11g-9i	no	North-East Ontario (QC)	northern	northern
11g-7i	no	North-East Ontario (QC)	southern	southern
6a-8c	no	Saskatchewan (SK)	northern	northern
6a-1c	no	Saskatchewan (SK)	southern	southern
6a-2d	no	Saskatchewan (SK)	southern	southern
6a-3c	no	Saskatchewan (SK)	southern	southern
6a-3d	no	Saskatchewan (SK)	southern	southern
6a-5c	no	Saskatchewan (SK)	southern	southern
6a-6c	no	Saskatchewan (SK)	southern	southern
6a-6d	no	Saskatchewan (SK)	southern	southern
6a-2c(SKN1)	yes	Saskatchewan (SK)	southern	southern
6a-8d(SKN2)	yes	Saskatchewan (SK)	southern	southern
5k-3b	no	South Baffin (NWT)	northern	northern
5k-3c	no	South Baffin (NWT)	northern	northern
5k-6b	no	South Baffin (NWT)	northern	northern
5k-9a	no	South Baffin (NWT)	northern	northern
5k-9b	no	South Baffin (NWT)	northern	northern
5k-3a(BFN2)	yes	South Baffin (NWT)	northern	northern
5k-6a(BFN1)	yes	South Baffin (NWT)	northern	northern
11g-1a	no	South Purcell (BC)	northern	northern
11g-1b	no	South Purcell (BC)	northern	northern
11g-2a	no	South Purcell (BC)	northern	northern
11g-2b	no	South Purcell (BC)	northern	northern
11g-3a	no	South Purcell (BC)	northern	northern
11g-4a	no	South Purcell (BC)	northern	northern
11g-5a	no	South Purcell (BC)	northern	northern
11g-6a	no	South Purcell (BC)	northern	northern

Appendix continued.

SAMPLE	SEQUENCED	HERD	AluI result	RsaI result
11g-7a	no	South Purcell (BC)	northern	northern
11g-8a	no	South Purcell (BC)	northern	northern
11g-9a	no	South Purcell (BC)	northern	northern
6a-2i	no	South Purcell (BC)	northern	northern
6a-3i	no	South Purcell (BC)	northern	northern
6a-1i	no	South Purcell (BC)	southern	southern
17	no	South Purcell (BC)	northern	northern
18	no	South Purcell (BC)	northern	northern
19	no	South Purcell (BC)	northern	northern
20	no	South Purcell (BC)	northern	northern
21	no	South Purcell (BC)	northern	northern
22	no	South Purcell (BC)	northern	northern
24	no	South Purcell (BC)	northern	northern
26	no	South Purcell (BC)	northern	northern
29	no	South Purcell (BC)	northern	northern
30	no	South Purcell (BC)	northern	northern
33	no	South Purcell (BC)	northern	northern
35	no	South Purcell (BC)	northern	northern
36	no	South Purcell (BC)	northern	northern
39	no	South Purcell (BC)	northern	northern
3c	no	South Purcell (BC)	northern	northern
3e	no	South Purcell (BC)	northern	northern
23	no	South Purcell (BC)	southern	southern
5b-1b	no	Southampton Island (NWT)	northern	northern
5b-1c	no	Southampton Island (NWT)	northern	northern
5b-2a	no	Southampton Island (NWT)	northern	northern
5b-2b	no	Southampton Island (NWT)	northern	northern
5b-2c	no	Southampton Island (NWT)	northern	northern
5b-2d	no	Southampton Island (NWT)	northern	northern
5b-3a	no	Southampton Island (NWT)	northern	northern
5b-3d	no	Southampton Island (NWT)	northern	northern
5b-4b	no	Southampton Island (NWT)	northern	northern
5b-4d	no	Southampton Island (NWT)	northern	northern
5b-5b	no	Southampton Island (NWT)	northern	northern
5b-5c	no	Southampton Island (NWT)	northern	northern
5b-6a	no	Southampton Island (NWT)	northern	northern
5b-6b	no	Southampton Island (NWT)	northern	northern
5b-6c	no	Southampton Island (NWT)	northern	northern
5b-7a	no	Southampton Island (NWT)	northern	northern
5b-7c	no	Southampton Island (NWT)	northern	northern
5b-8a	no	Southampton Island (NWT)	northern	northern
5b-8b	no	Southampton Island (NWT)	northern	northern
5b-8c	no	Southampton Island (NWT)	northern	northern

Appendix continued.

SAMPLE	SEQUENCED	HERD	Alu1 result	Rsa1 result
5b-9a	no	Southampton Island (NWT)	northern	northern
5b-9b	no	Southampton Island (NWT)	northern	northern
5b-9c	no	Southampton Island (NWT)	northern	northern
1(WLF1)	yes	Wolf Lake (YT)	northern	northern
2	no	Wolf Lake (YT)	northern	northern
3	no	Wolf Lake (YT)	northern	northern
4	no	Wolf Lake (YT)	northern	northern
5	no	Wolf Lake (YT)	northern	northern
6	no	Wolf Lake (YT)	northern	northern
7	no	Wolf Lake (YT)	northern	northern
8	no	Wolf Lake (YT)	northern	northern
9	no	Wolf Lake (YT)	northern	northern
10	no	Wolf Lake (YT)	northern	northern
11	no	Wolf Lake (YT)	northern	northern
12	no	Wolf Lake (YT)	northern	northern
13	no	Wolf Lake (YT)	northern	northern
14	no	Wolf Lake (YT)	northern	northern
15	no	Wolf Lake (YT)	northern	northern
16	no	Wolf Lake (YT)	northern	northern
17	no	Wolf Lake (YT)	northern	northern
18	no	Wolf Lake (YT)	northern	northern
19	no	Wolf Lake (YT)	northern	northern
20	no	Wolf Lake (YT)	northern	northern
21	no	Wolf Lake (YT)	northern	northern
22	no	Wolf Lake (YT)	northern	northern
23	no	Wolf Lake (YT)	northern	northern
5e-5b(RND1)	yes	Reindeer (Alaska)	not analyzed	
13f-7d(RND2)	yes	Reindeer, Dawson Creek (BC)	not analyzed	

Appendix continued.

IMAGE EVALUATION TEST TARGET (QA-3)

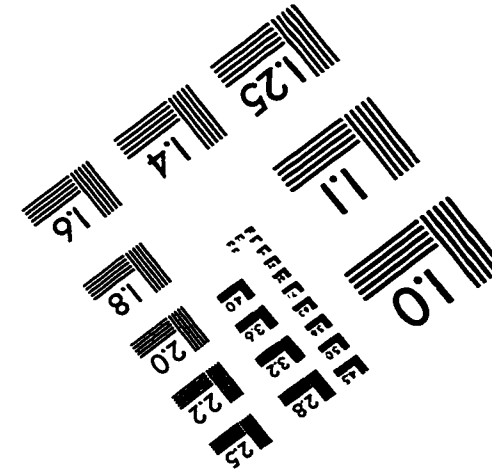
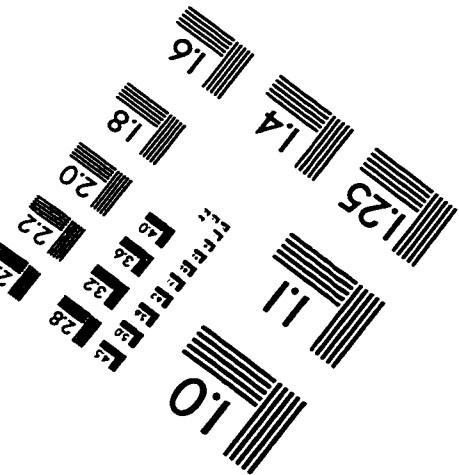
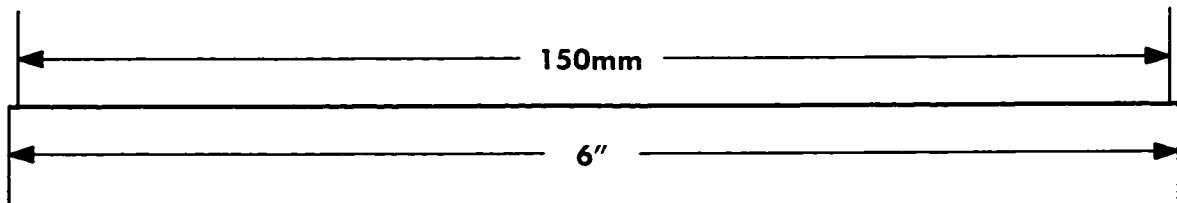
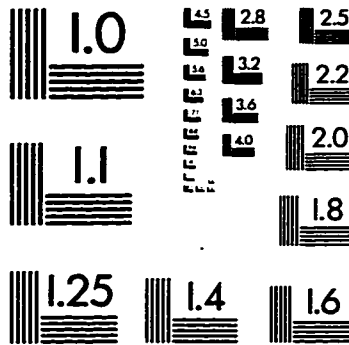
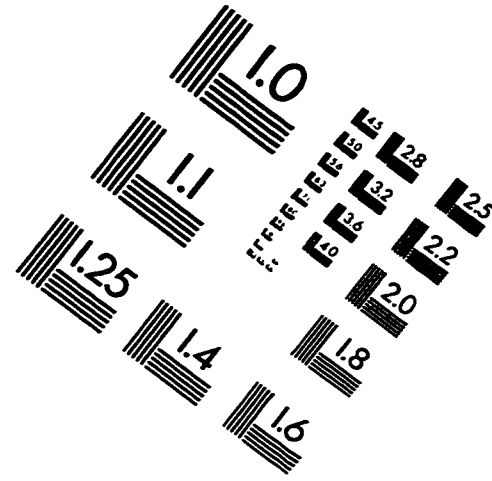
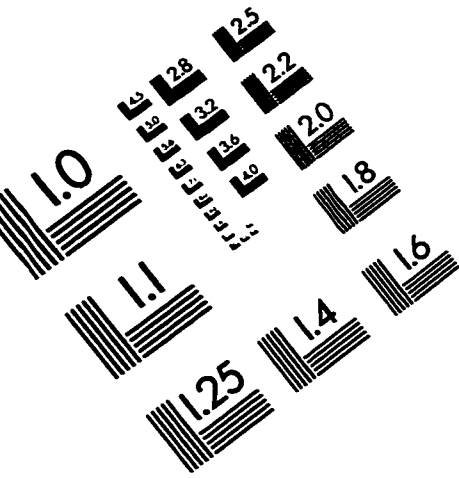

APPLIED IMAGE, Inc
1653 East Main Street
Rochester, NY 14609 USA
Phone: 716/482-0300
Fax: 716/288-5989

© 1993, Applied Image, Inc., All Rights Reserved