

University of Alberta
Department of Civil &
Environmental Engineering



Structural Engineering Report No. 71

Experimental Data for Concrete Masonry Walls

by
M. Hatzinikolas
J. Longworth
and
J. Warwaruk

September, 1978

THE UNIVERSITY OF ALBERTA
EXPERIMENTAL DATA FOR CONCRETE MASONRY WALLS

by

M. Hatzinikolas¹, J. Longworth², and J. Warwaruk³

September 1978

DEPARTMENT OF CIVIL ENGINEERING

EDMONTON, ALBERTA

1. Former Graduate Student, Dept. of Civil Engineering, University of Alberta, Edmonton, Canada, currently Director of Technical Services for the Alberta Masonry Institute.
2. Professor and Chairman of Civil Engineering, University of Alberta, Edmonton, Canada, T6G 2G7.
3. Professor of Civil Engineering, University of Alberta, Edmonton, Canada, T6G 2G7.

ABSTRACT

As part of a research program to study the behaviour of "concrete masonry walls", 68 walls with h/t ratio varying from 12 to 22 (nominal) were tested at the I.F. Morrison Structural Engineering Laboratory of the University of Alberta.

The primary objective of these tests was to investigate the strength and the factors affecting the structural performance of the walls under various combinations of vertical load and bending moments. The analysis of the test results is presented in Structural Engineering Report No. 70 of the Civil Engineering Department of the University of Alberta.

In this report the data obtained from the experimental investigation are presented in the form of computer plotted figures of load-deflection, load-deformation and load-reinforcing steel strains.

ACKNOWLEDGEMENTS

This investigation was made possible through funds from both the Natural Sciences and Engineering Research Council of Canada and the Alberta Masonry Institute, with additional facilities provided by the Department of Civil Engineering.

This report was prepared by M. Hatzinikolas as a doctoral thesis under the joint direction of Profs. Longworth and Warwaruk.

TABLE OF CONTENTS

CHAPTER		PAGE
I	INTRODUCTION	1
II	TEST DATA	2
	2.1 Introduction	2
	2.2 Deflected Slopes	2
	2.3 Vertical Deformations	2
	2.4 Reinforcement Strains	3
	2.5 Masonry Strains	3

LIST OF FIGURES

Figures 2-1 to 2-63 Deflected Shapes of Walls	Page 4 to Page 66
Figures 2-64 to 2-77 Vertical Deformations of Walls	Page 67 to Page 80
Figures 2.78 to 2.107 Reinforcement Strains	Page 81 to Page 110
Figures 2.108 to 2.113 Masonry Strains	Page 111 to Page 116
Figures 2.114 and 2.115 Block Strains	Page 117 to Page 118
Figures 2.116 Centreline Deflections	Page 119 to Page 126

CHAPTER I

Introduction

The data presented in this report supplement the analysis and conclusions reached in Structural Engineering Report No. 70 of the Department of Civil Engineering of the University of Alberta. The data refers to full scale walls tested with pin-end conditions in axial compression or in double or single curvature. The data are presented in four groups namely deflected shapes, vertical deformations, reinforcing strains, masonry strains.

The test procedure and physical properties of the walls are given in Report No. 70, where also the instrumentation of the test specimens is described.

The investigation of the behaviour of plain and reinforced concrete masonry walls also included tests on small specimens and mortars, the results of which are included in Report No. 70.

CHAPTER II

Test Data

2.1 Introduction

The data were recorded and processed automatically using a NOVA computer. After processing the data were transferred to the AMDAHL 470 computer for further processing and it is in the form of computer plotting that the data are reported here. The data are also available in the form of tables but they are not included in this report.

2.2 Deflected Shapes

The deflected shape of each wall specimen was monitored at selected load levels. Figures 2.1 to 2.63 give the deflected shapes of most of the walls tested. The position of the load and reaction together with the length of the wall between supports is shown in a sketch.

2.3 Vertical Deformations

Vertical deformations were monitored by the movement of the piston of the M.T.S. testing machine with an accuracy of 0.0001" and were automatically recorded for selected load levels. The results are plotted in groups of similar walls in Figures 2.64 through 2.77.

2.4 Reinforcement Strains

Figures 2.78 to 2.107 show the strains in the reinforcement versus the total vertical load on the wall.

Strain gauges were attached to the reinforcing steel at locations where maximum strain was expected. In most cases, the values plotted are averages of three strain gauges positioned, one on each of the three reinforcing bars, at a particular height in the wall.

2.5 Masonry Strains

For a number of walls 4-inch concrete strain gauges were mounted in such a way as to include a mortar joint. One gauge was mounted on the compression face of the wall (when eccentrically loaded) and one on the tension side. Both strain gauges were at the same level. The results of these measurements are shown in Figures 2.108 to 2.115.

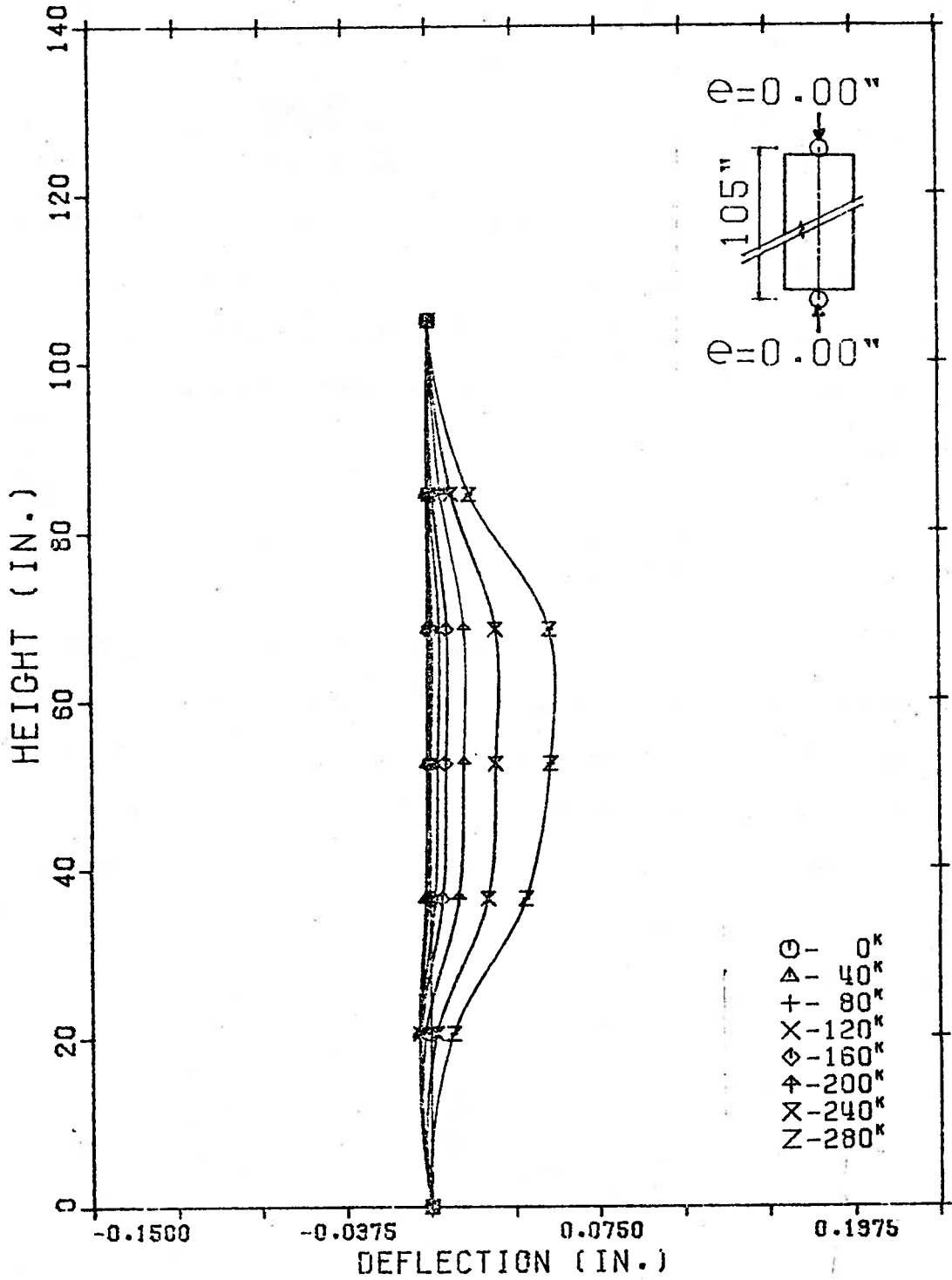

FIG. 2-1 Deflected Shape of Wall A1

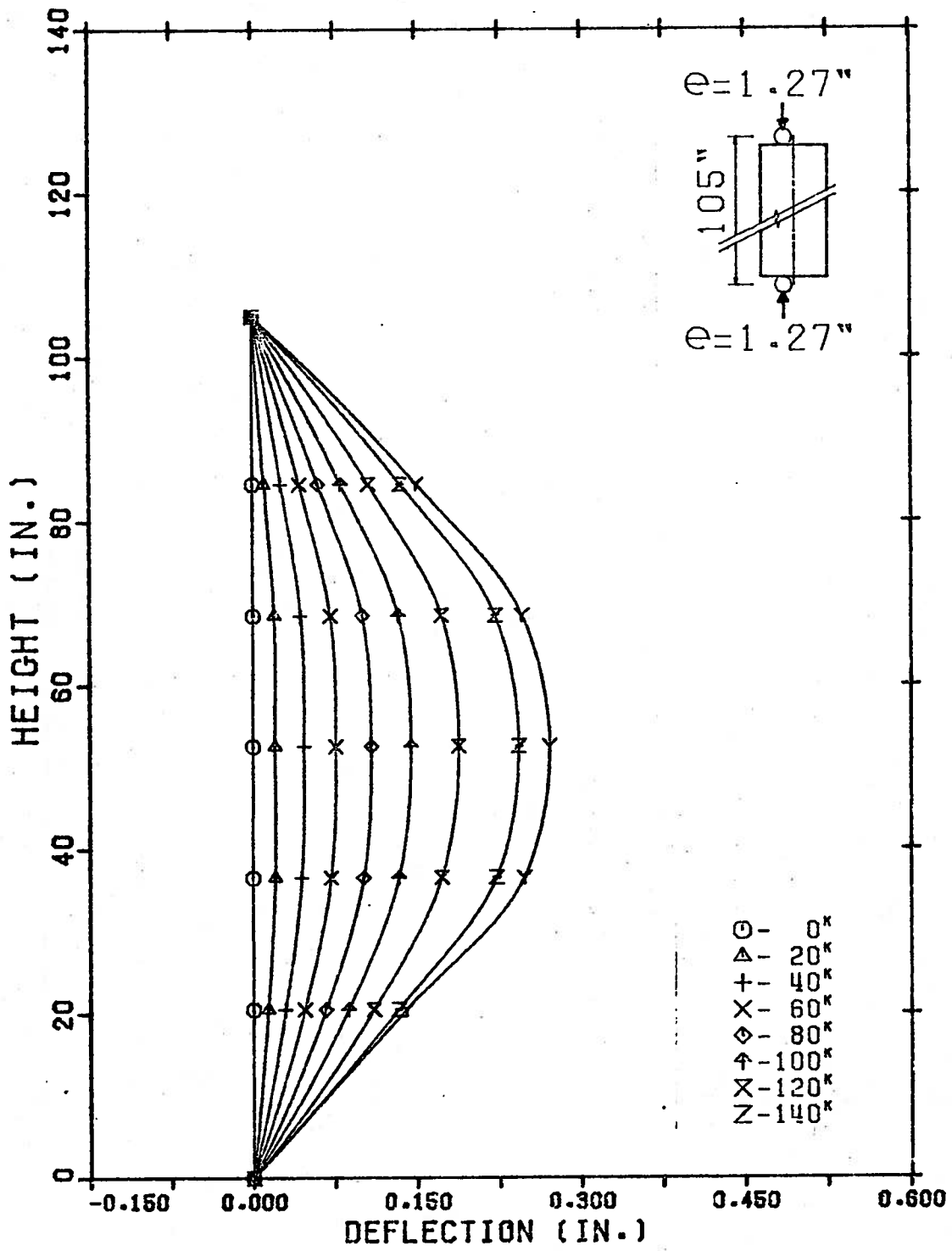

FIG. 2-2 Deflected Shape of Wall A2

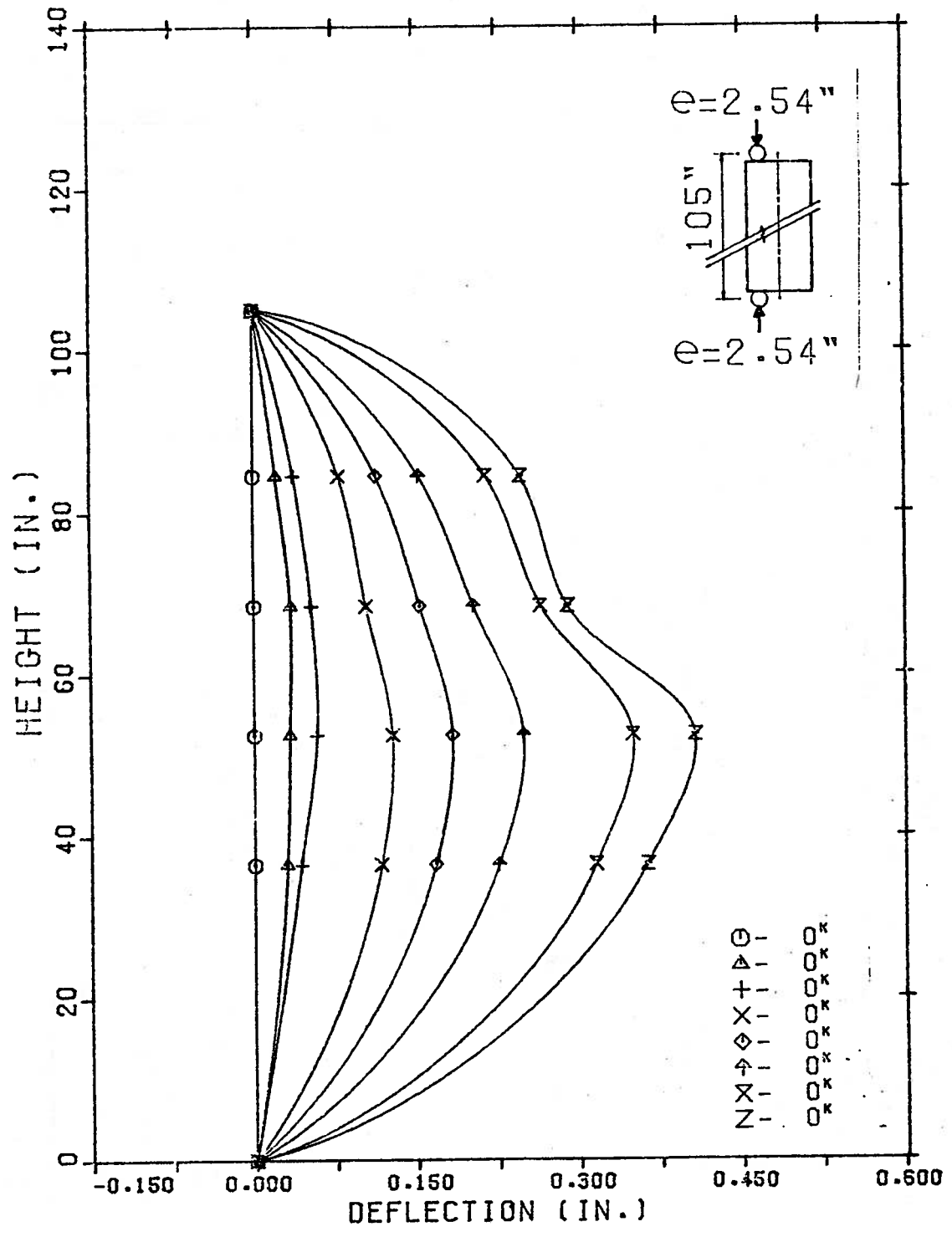

FIG. 2-3 Deflected Shape of Wall A3

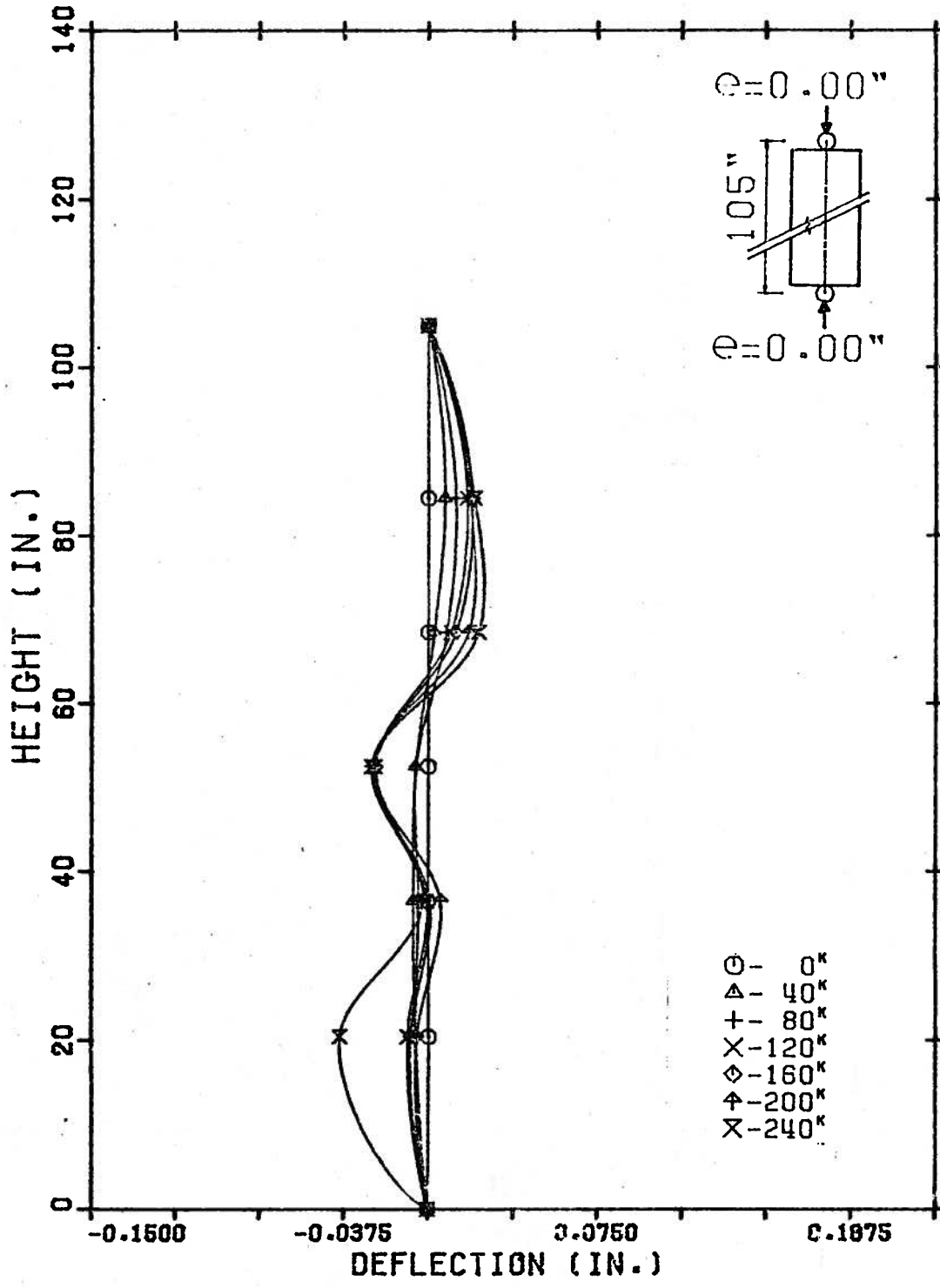

FIG. 2-4 Deflected Shape of Wall A4

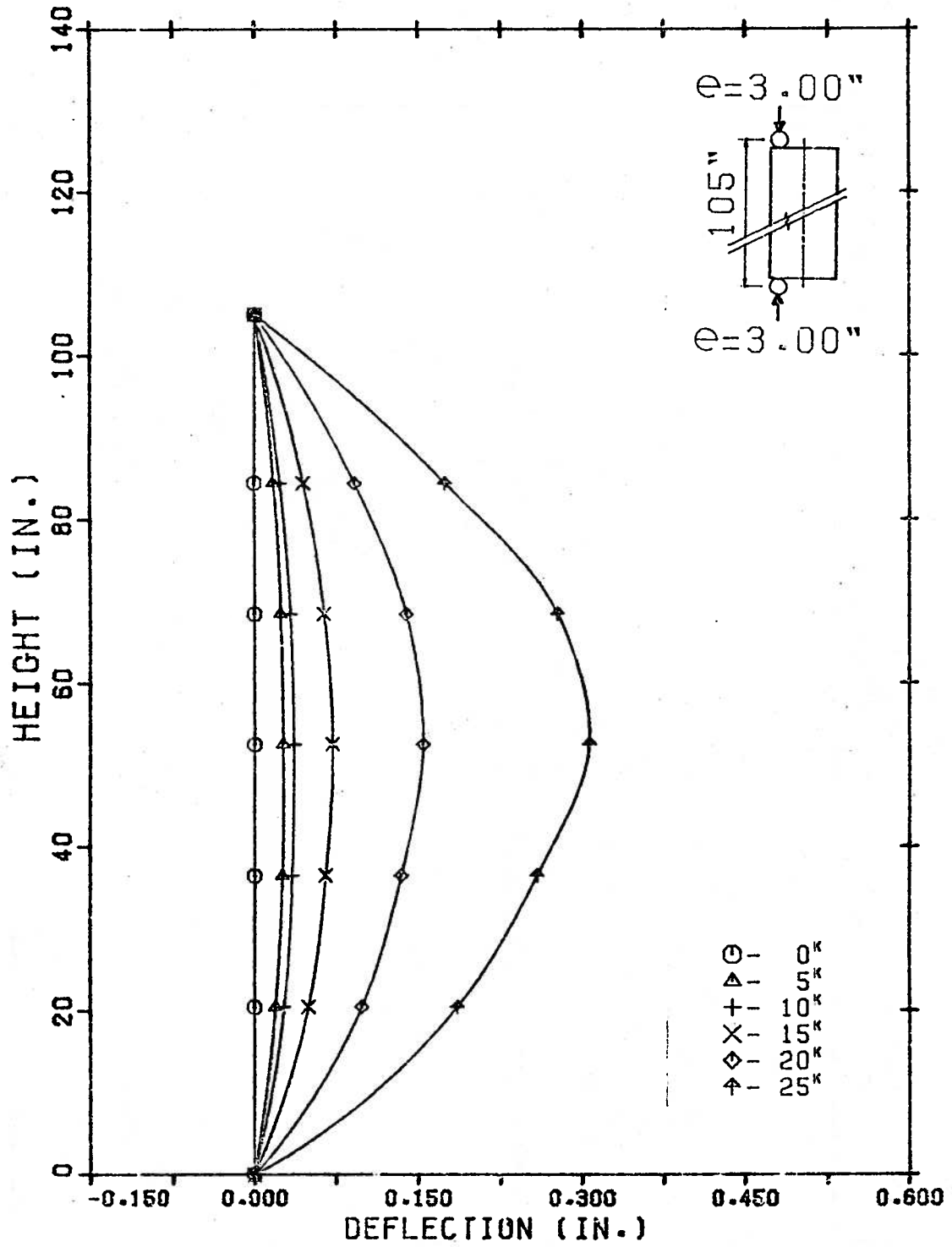

FIG. 2-5 Deflected Shape of Wall A5

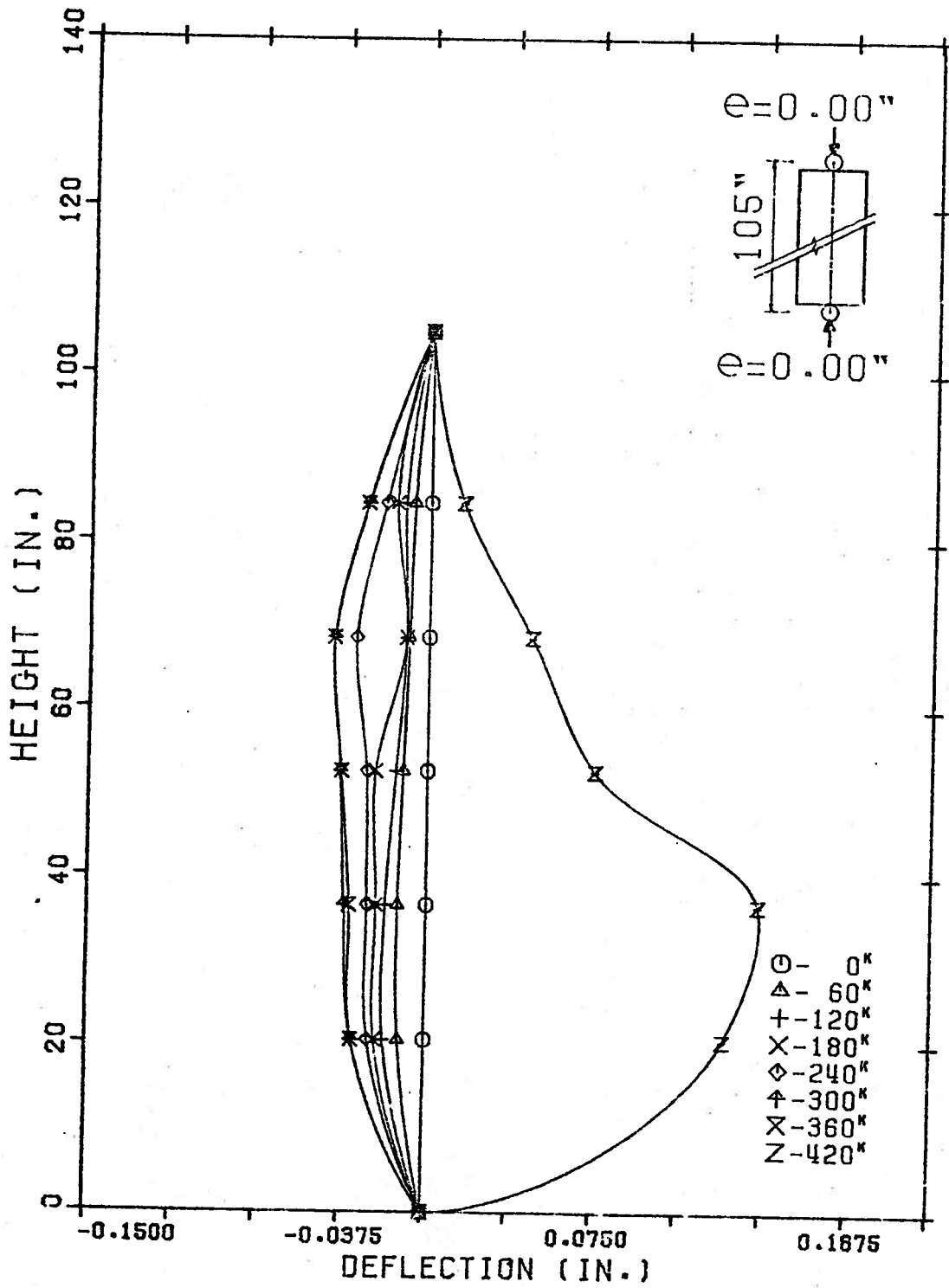

FIG. 2-6 Deflected Shape of Wall B1

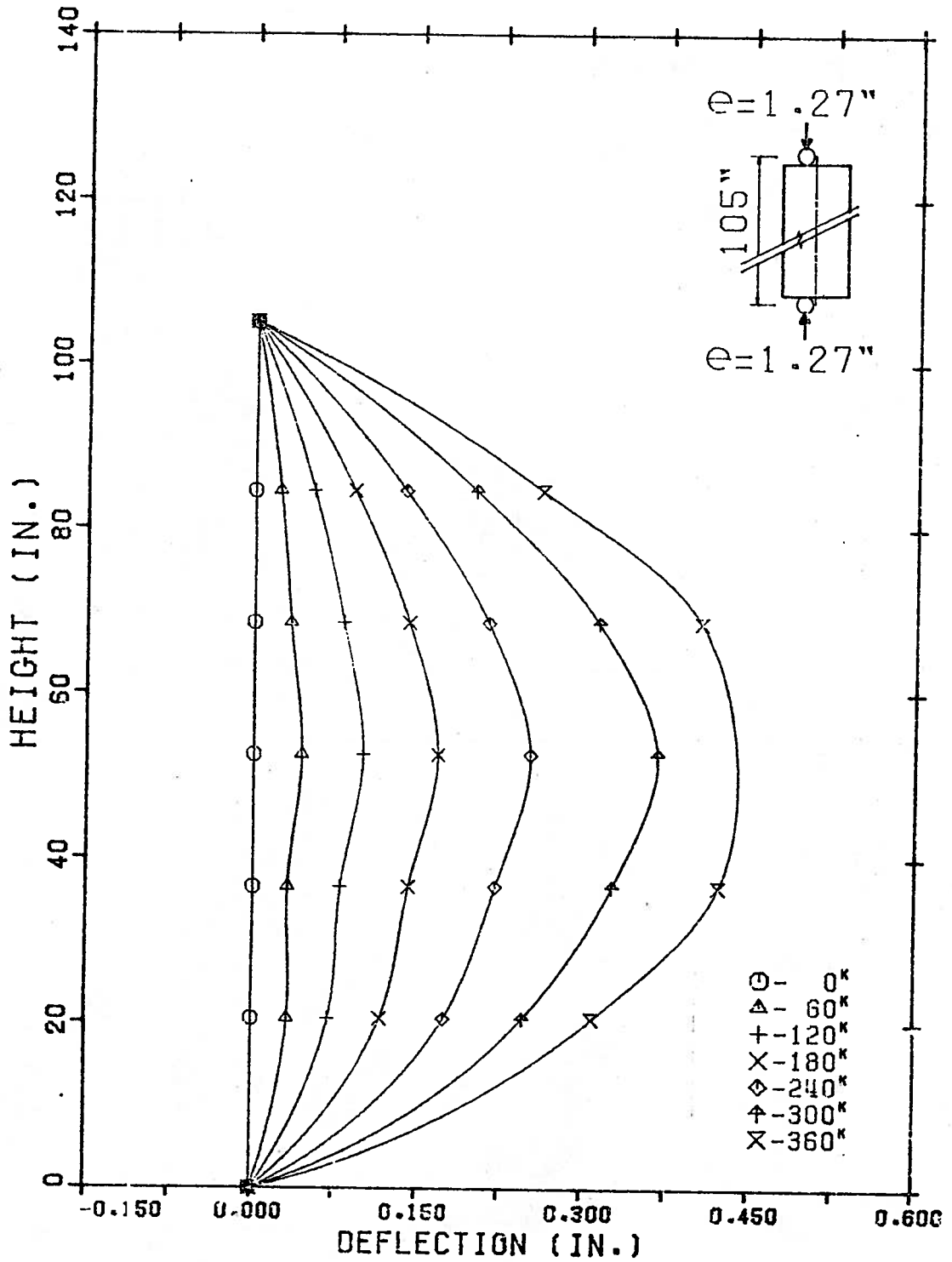

FIG. 2-7 Deflected Shape of Wall B2

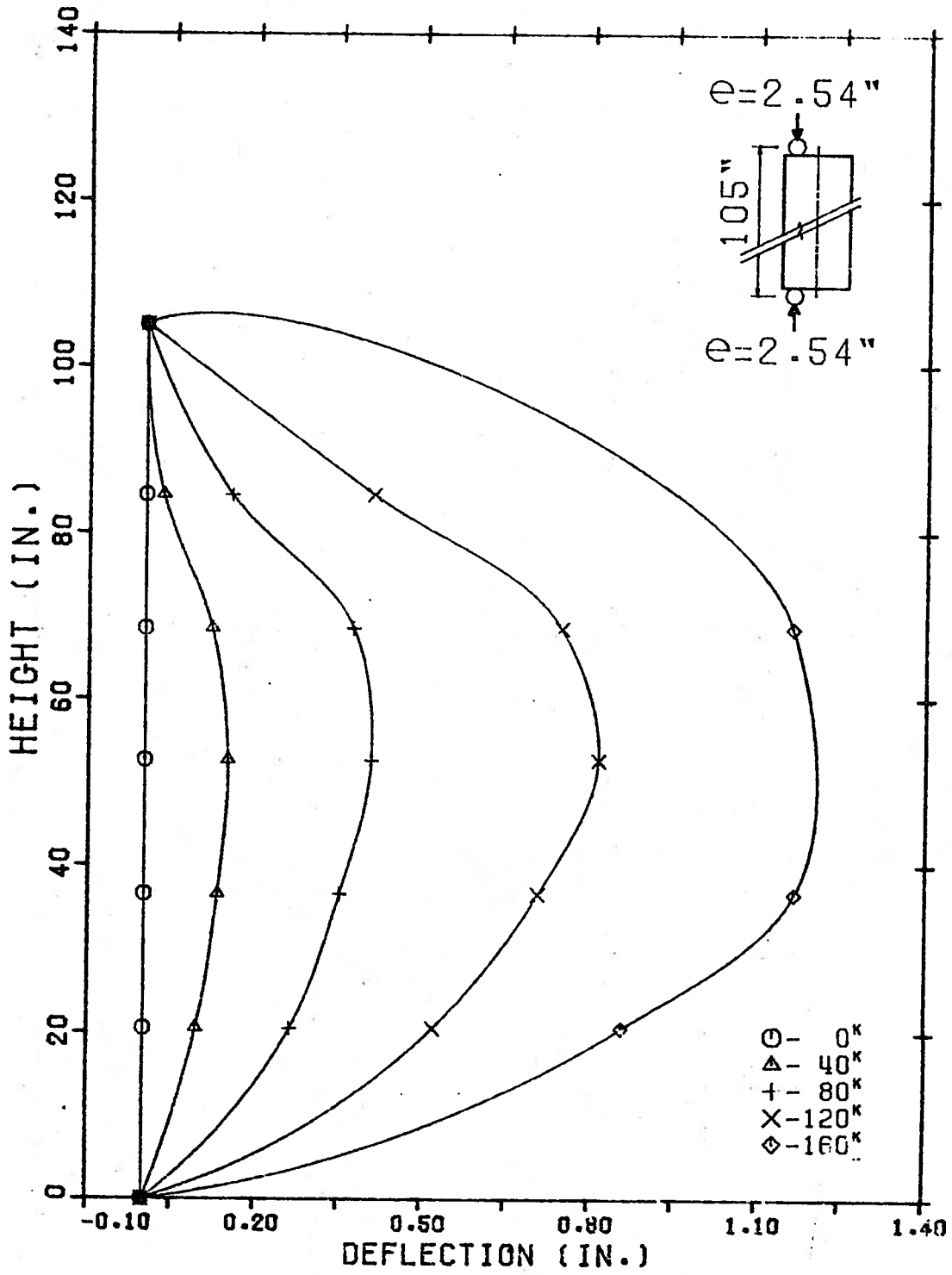

FIG. 2-8 Deflected Shape of Wall B3

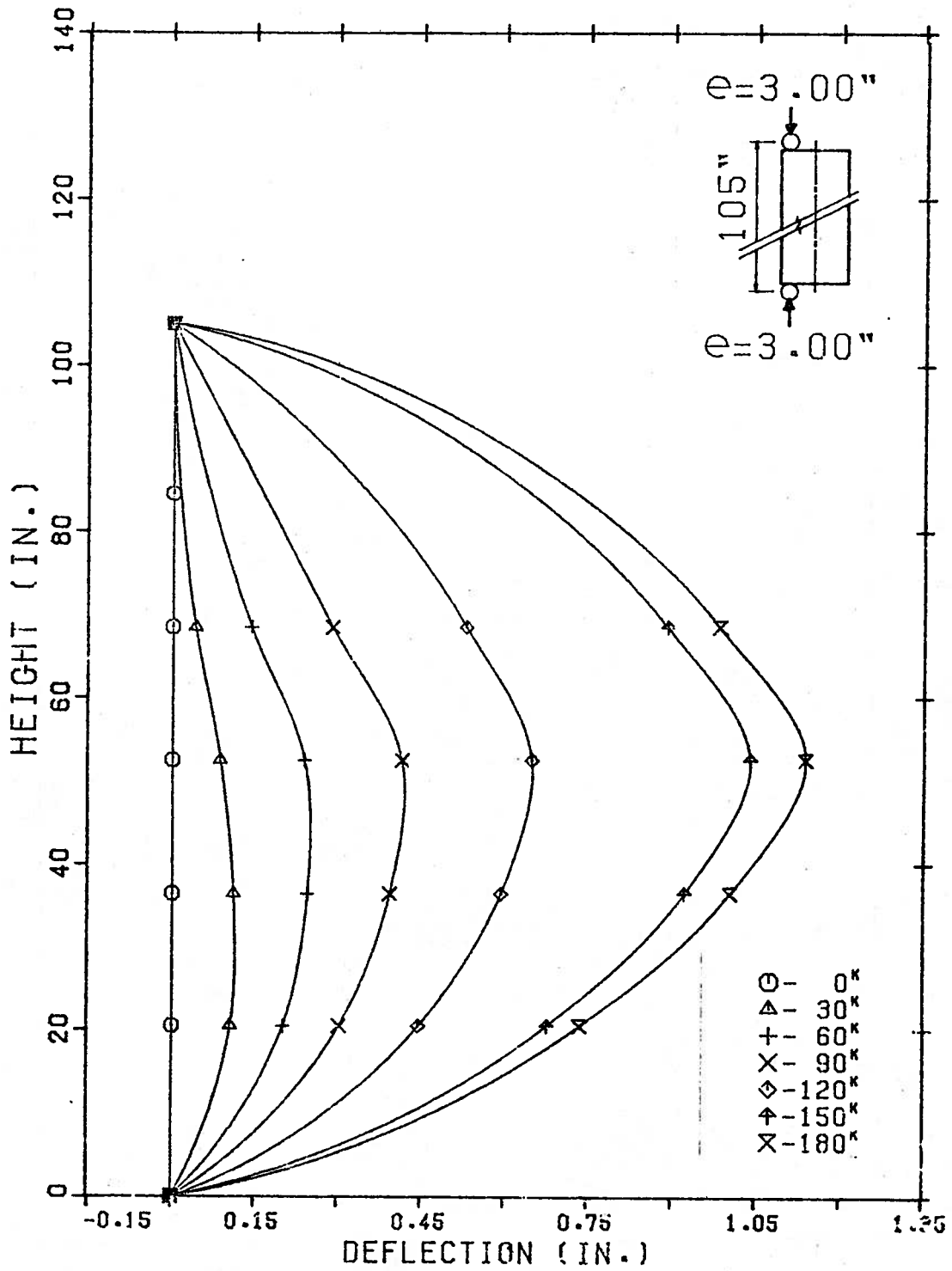

FIG. 2-9 Deflected Shape of Wall B4

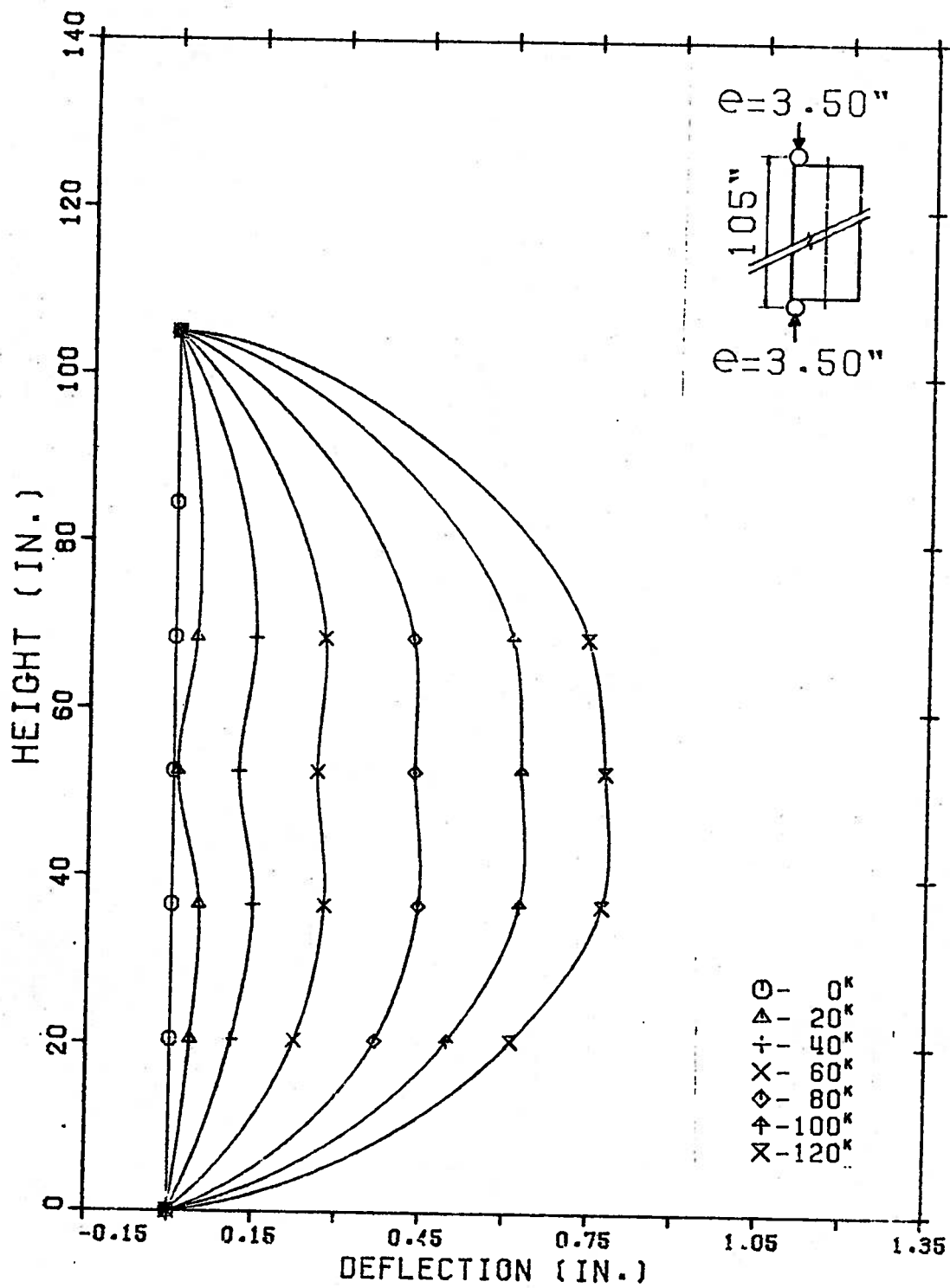

FIG. 2-10 Deflected Shape of Wall B5

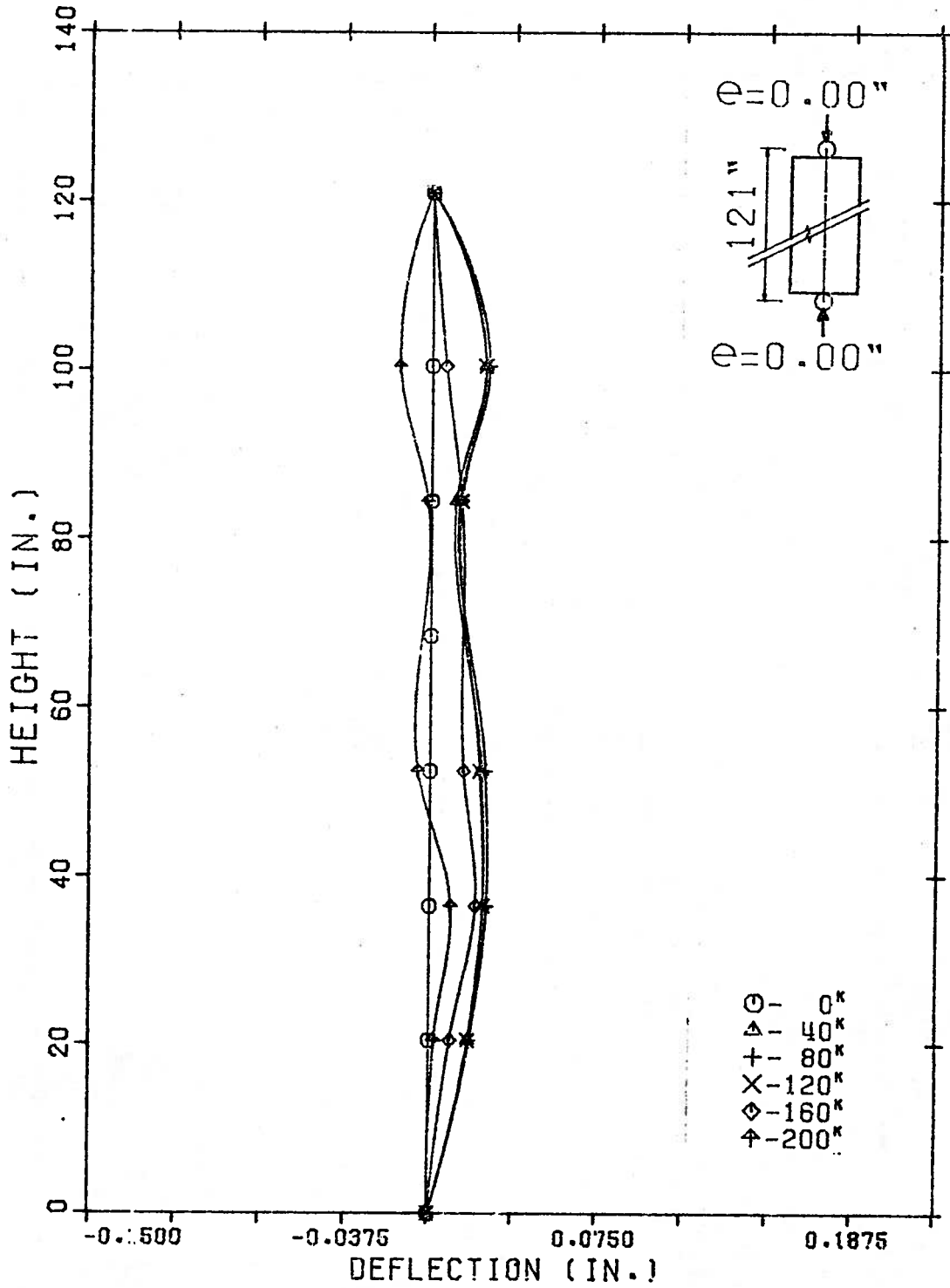

FIG. 2-11 Deflected Shape of Wall C1

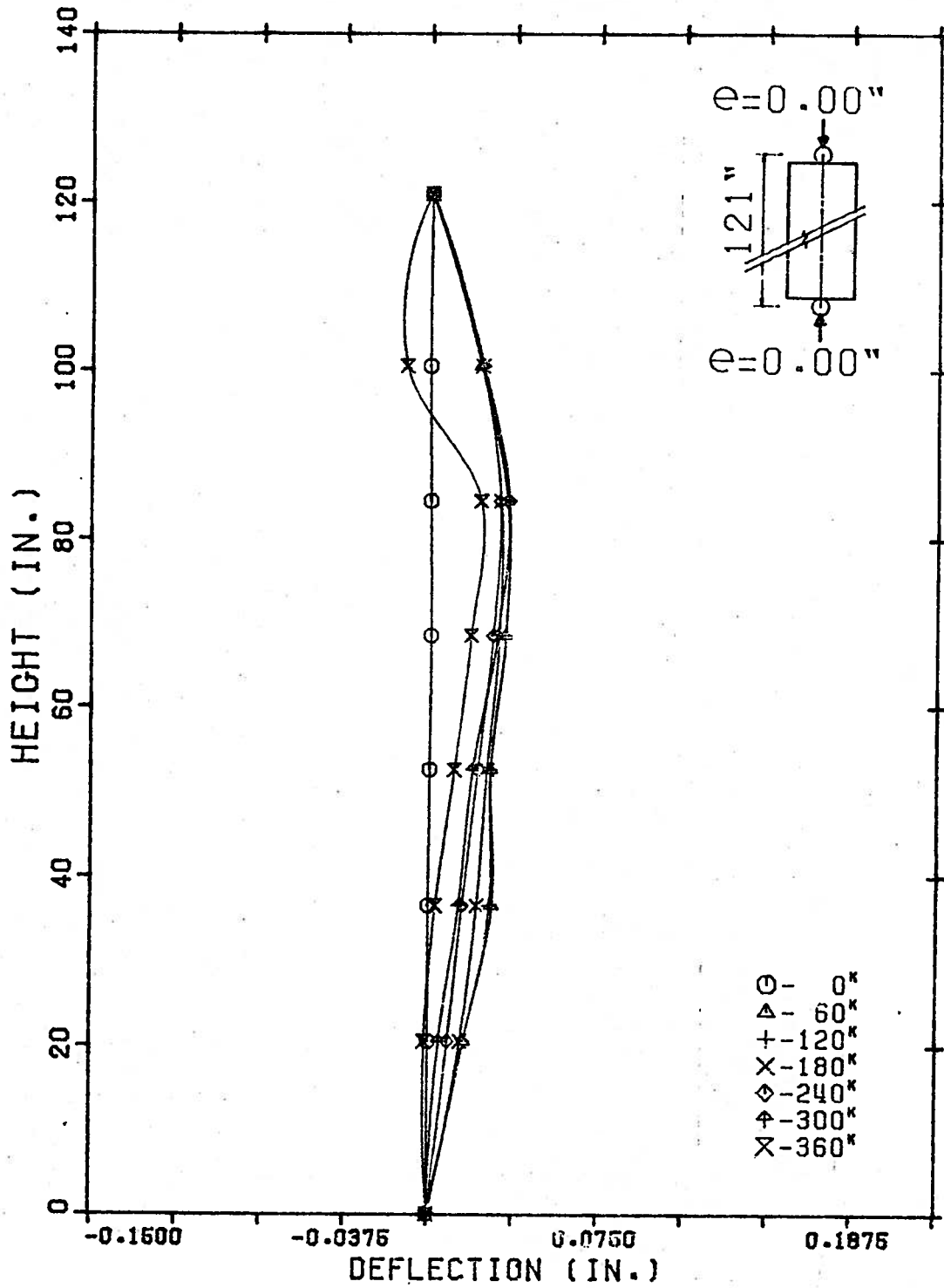

FIG. 2-12 Deflected Shape of Wall C2

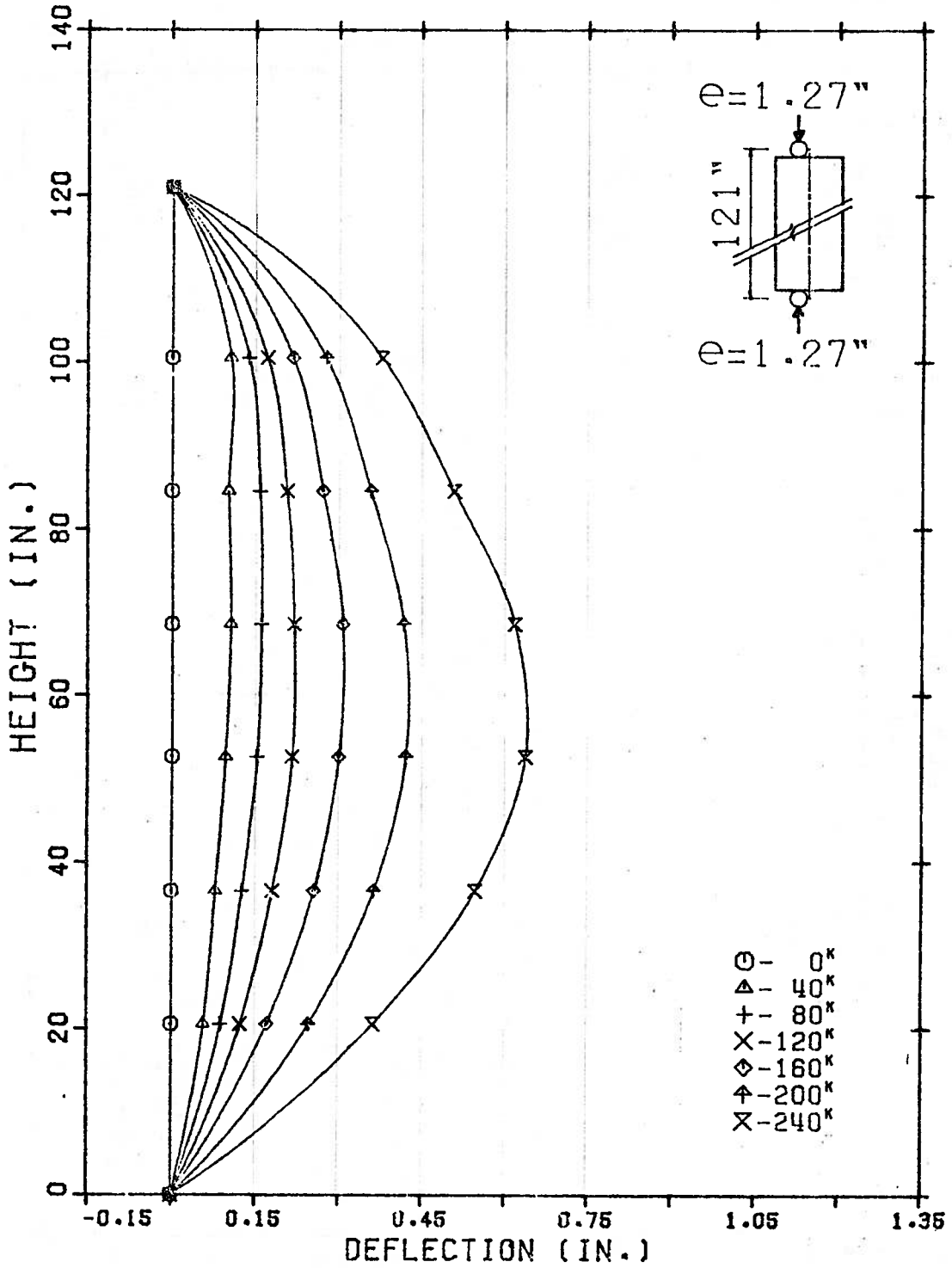

FIG. 2-13 Deflected Shape of Wall C3

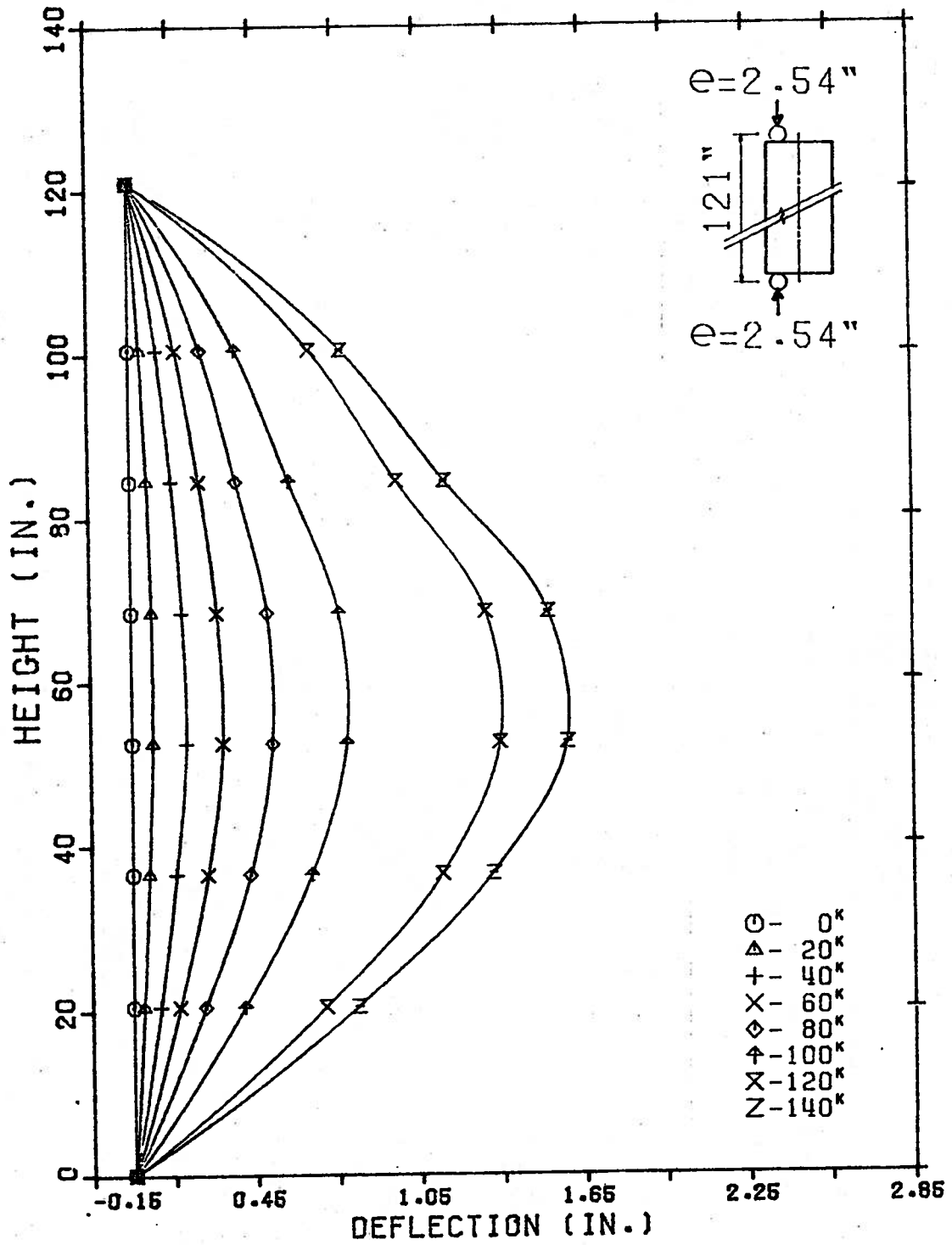

FIG. 2-14 Deflected Shape of Wall C4

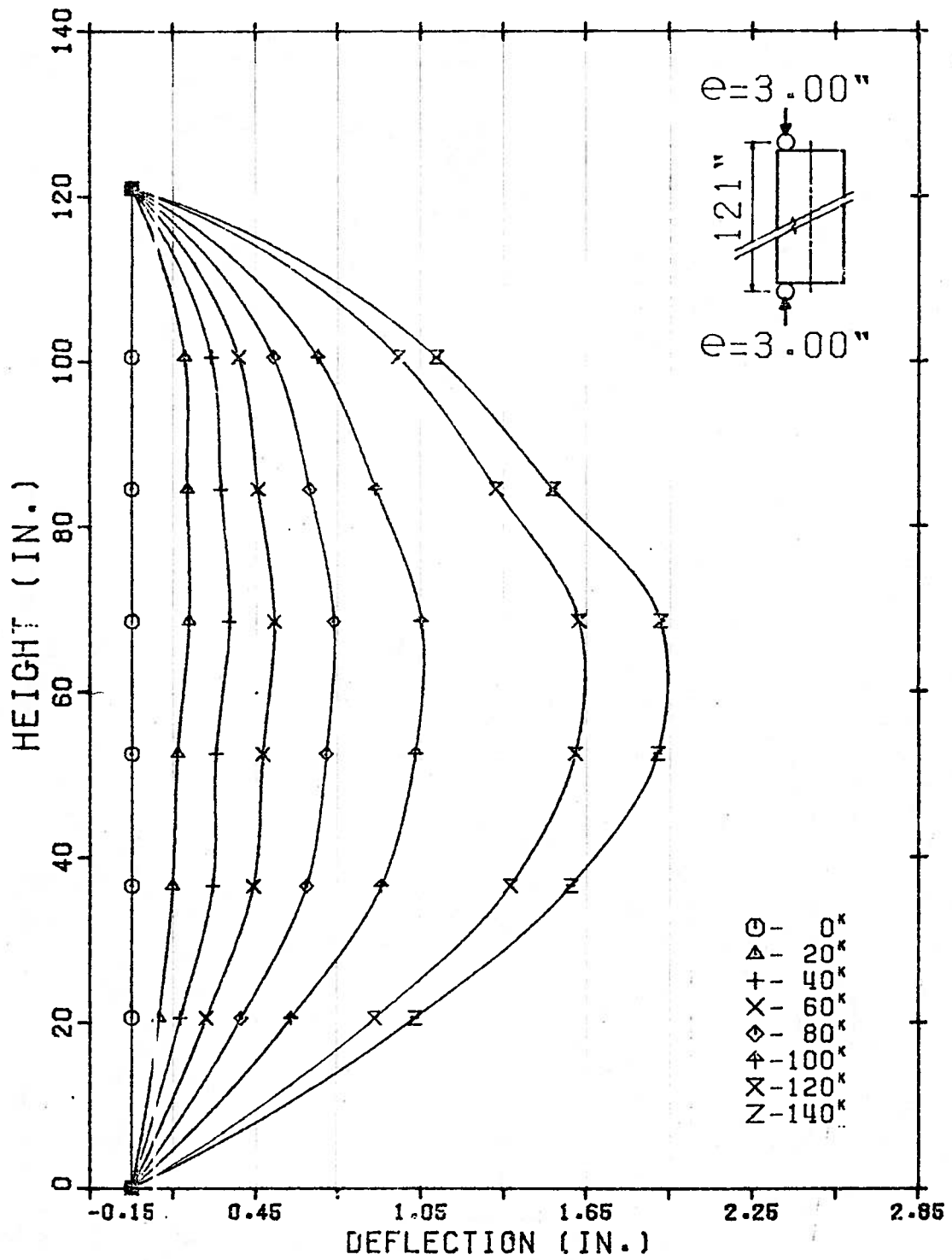

FIG. 2-15 Deflected Shape of Wall C5

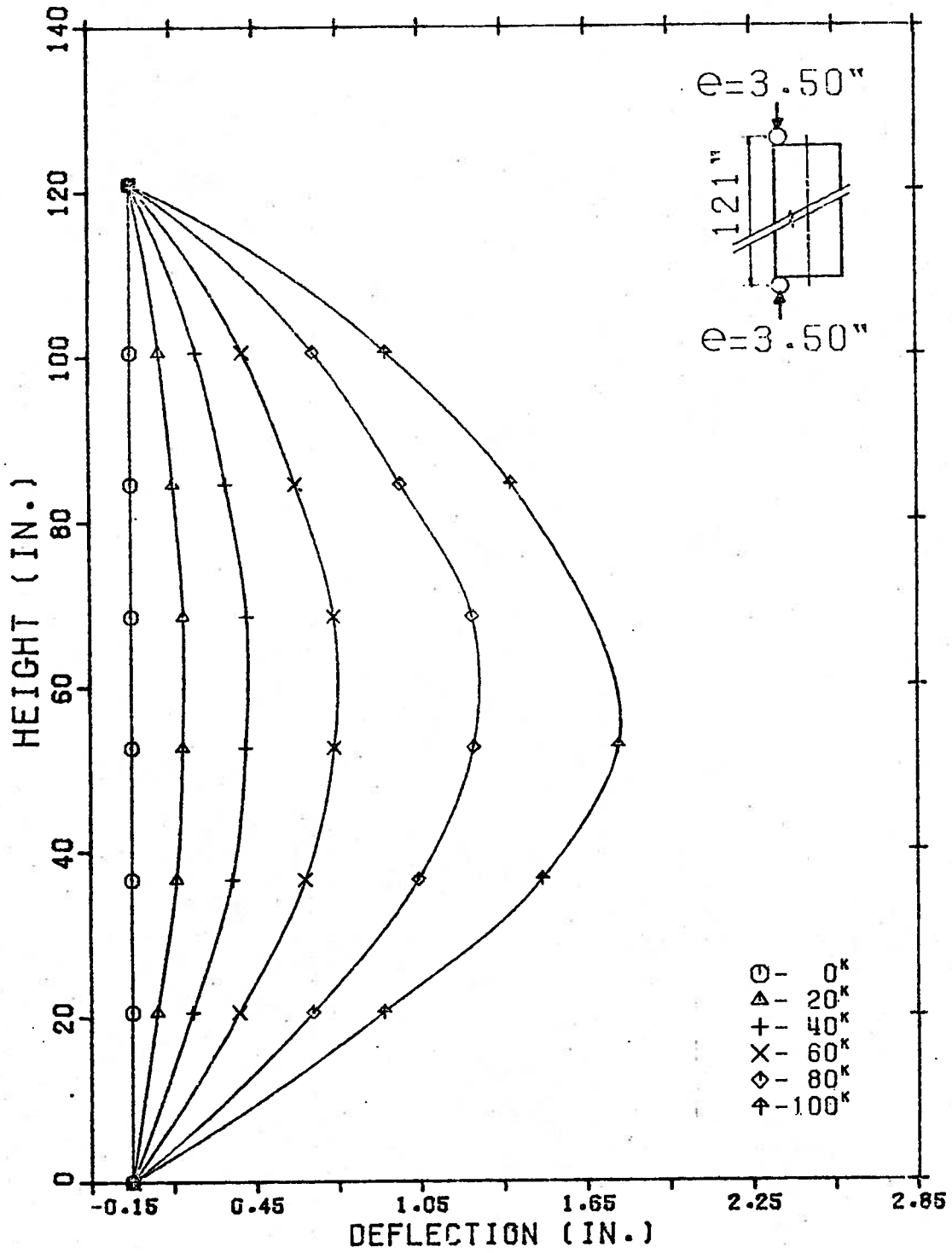

FIG. 2-16 Deflected Shape of Wall C6

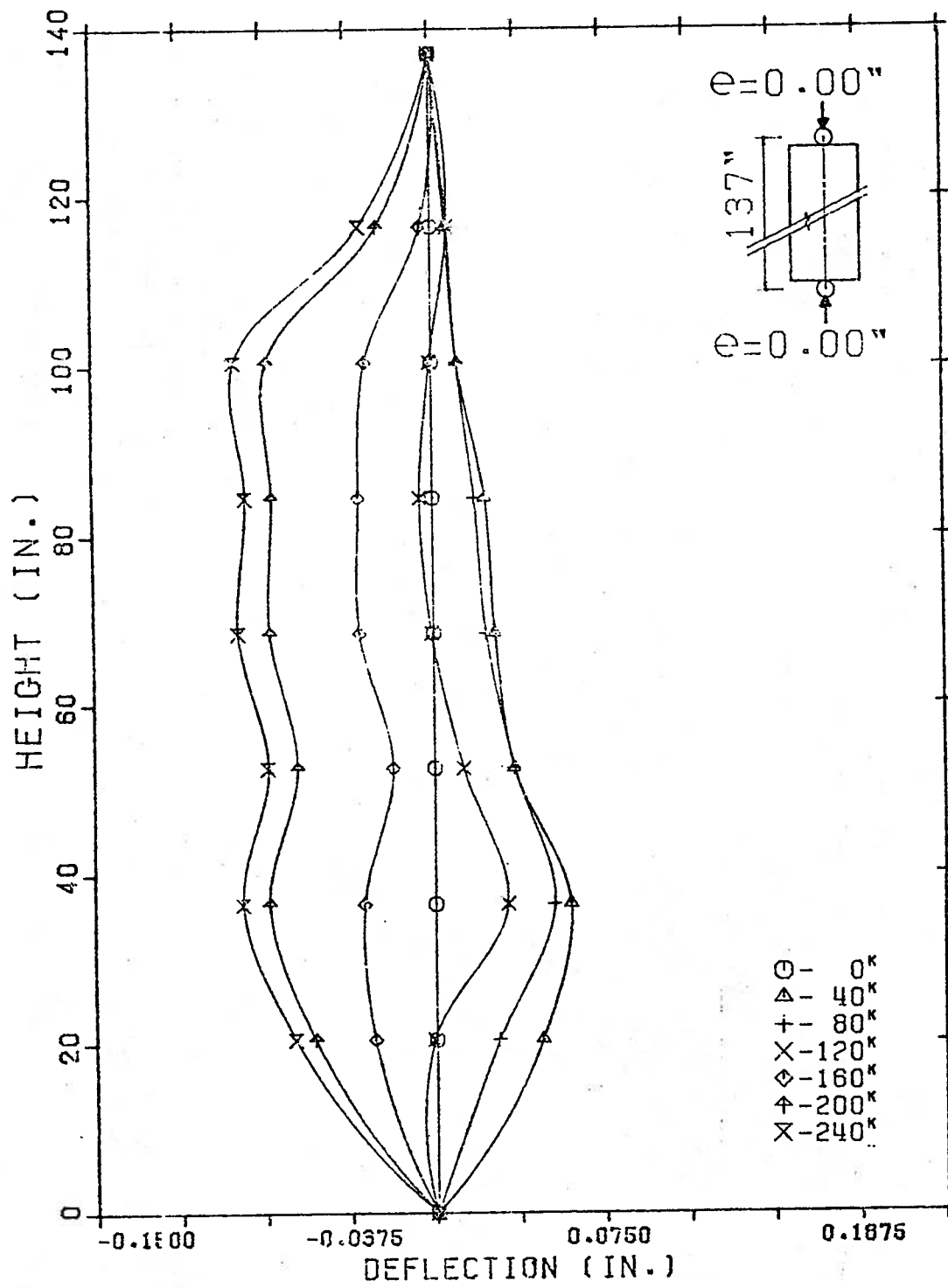

FIG. 2-17 Deflected Shape of Wall D1

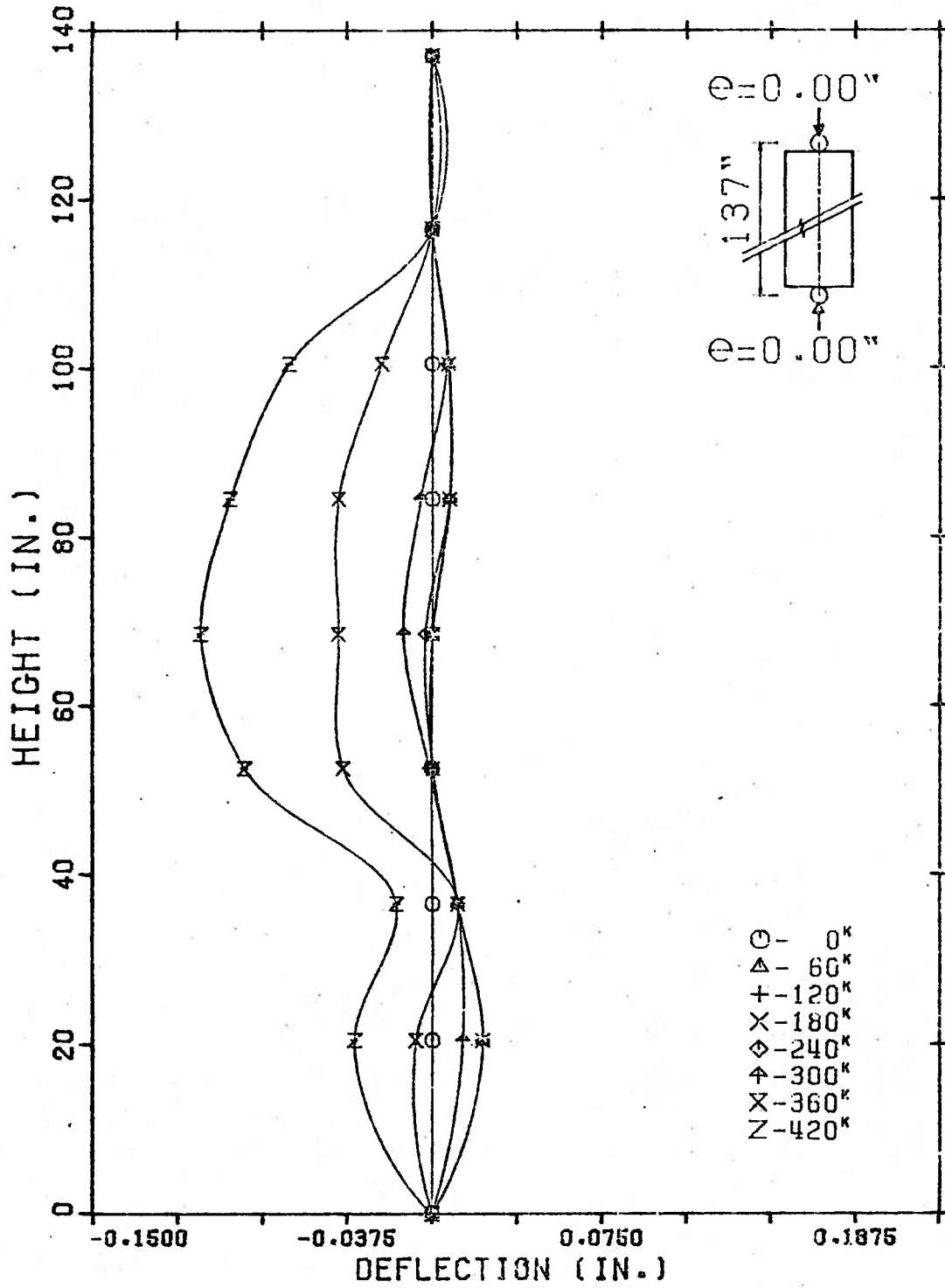

FIG. 2-18 Deflected Shape of Wall D2

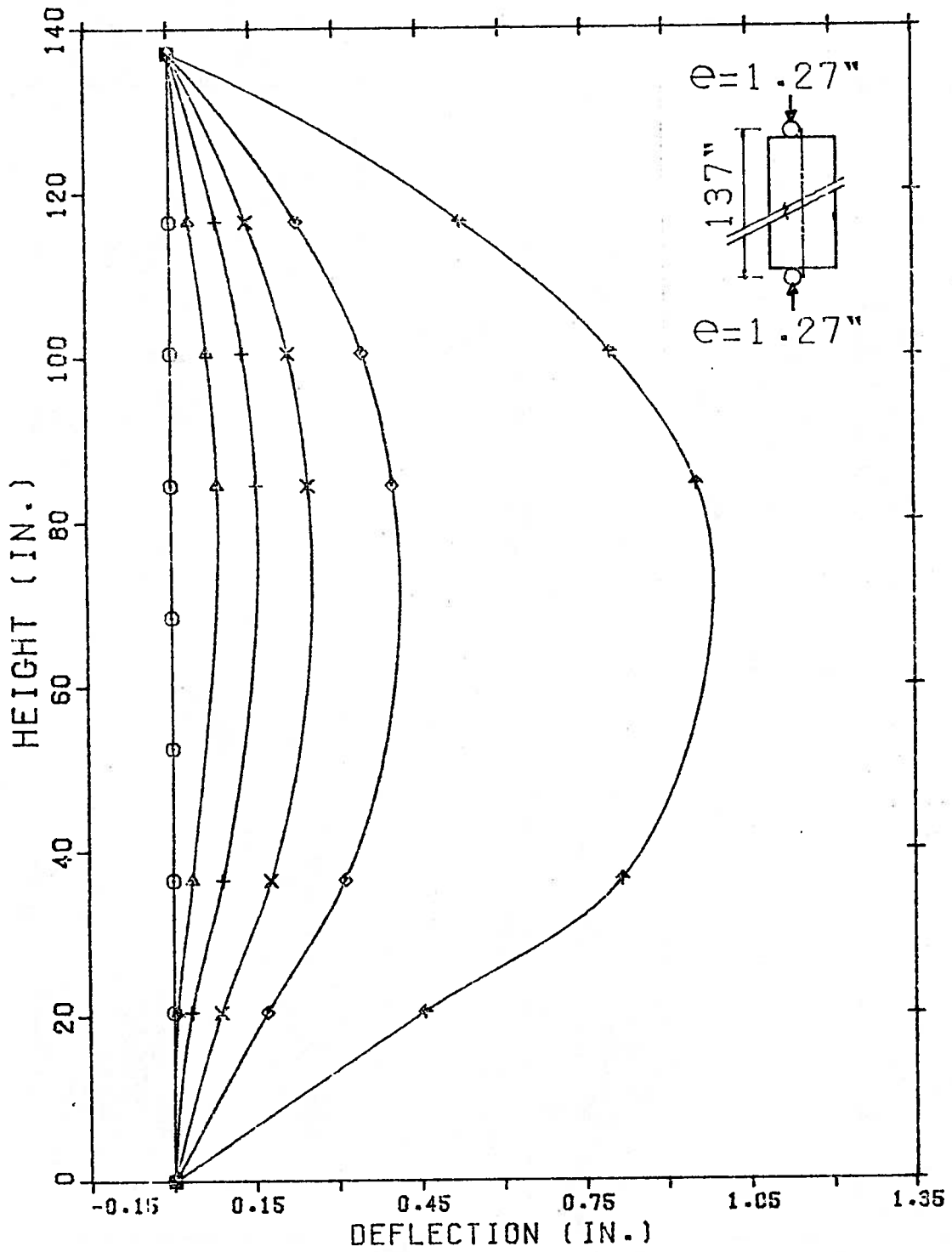

FIG. 2-19 Deflected Shape of Wall D3

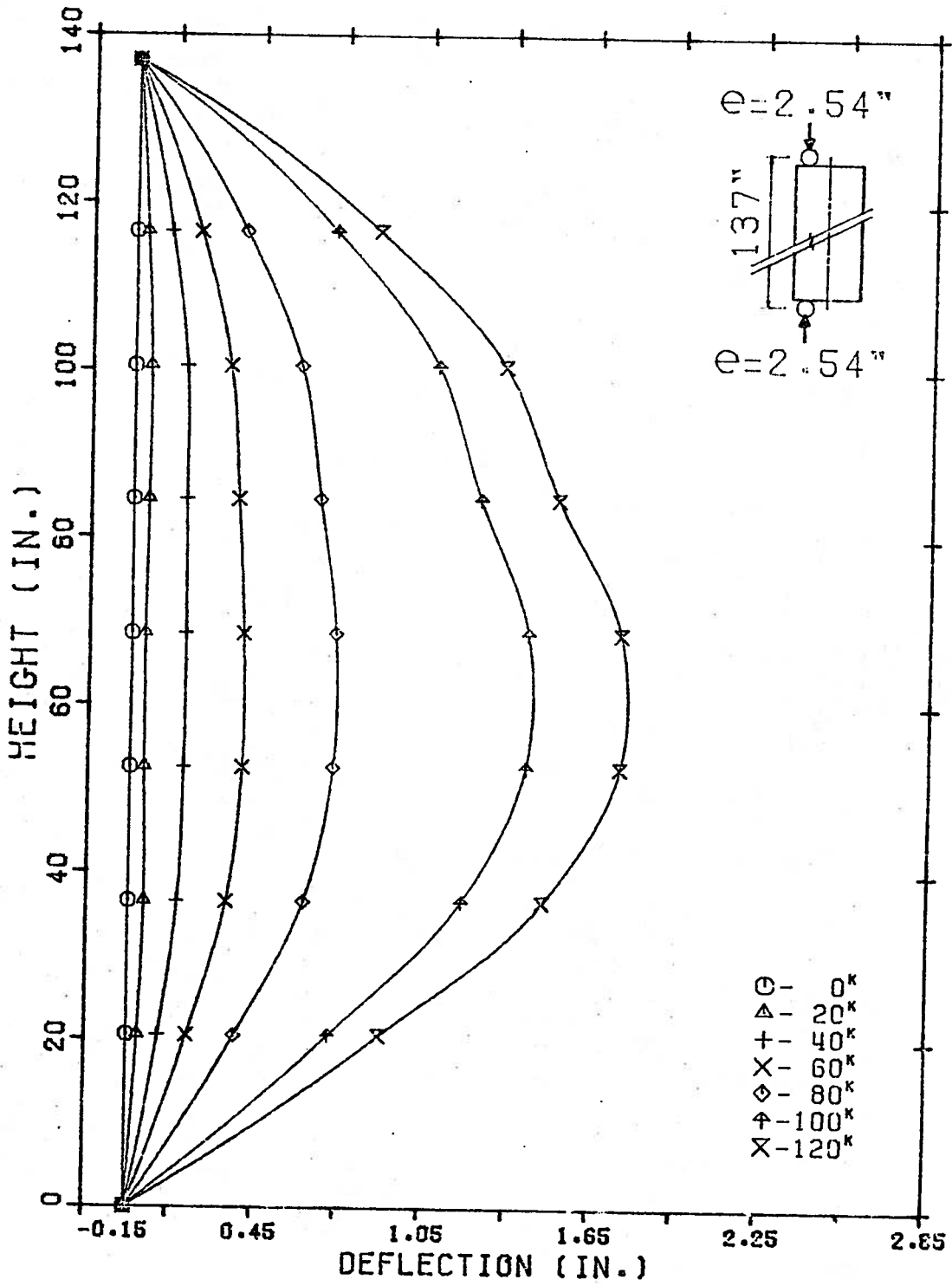

FIG. 2-20 Deflected Shape of Wall D4

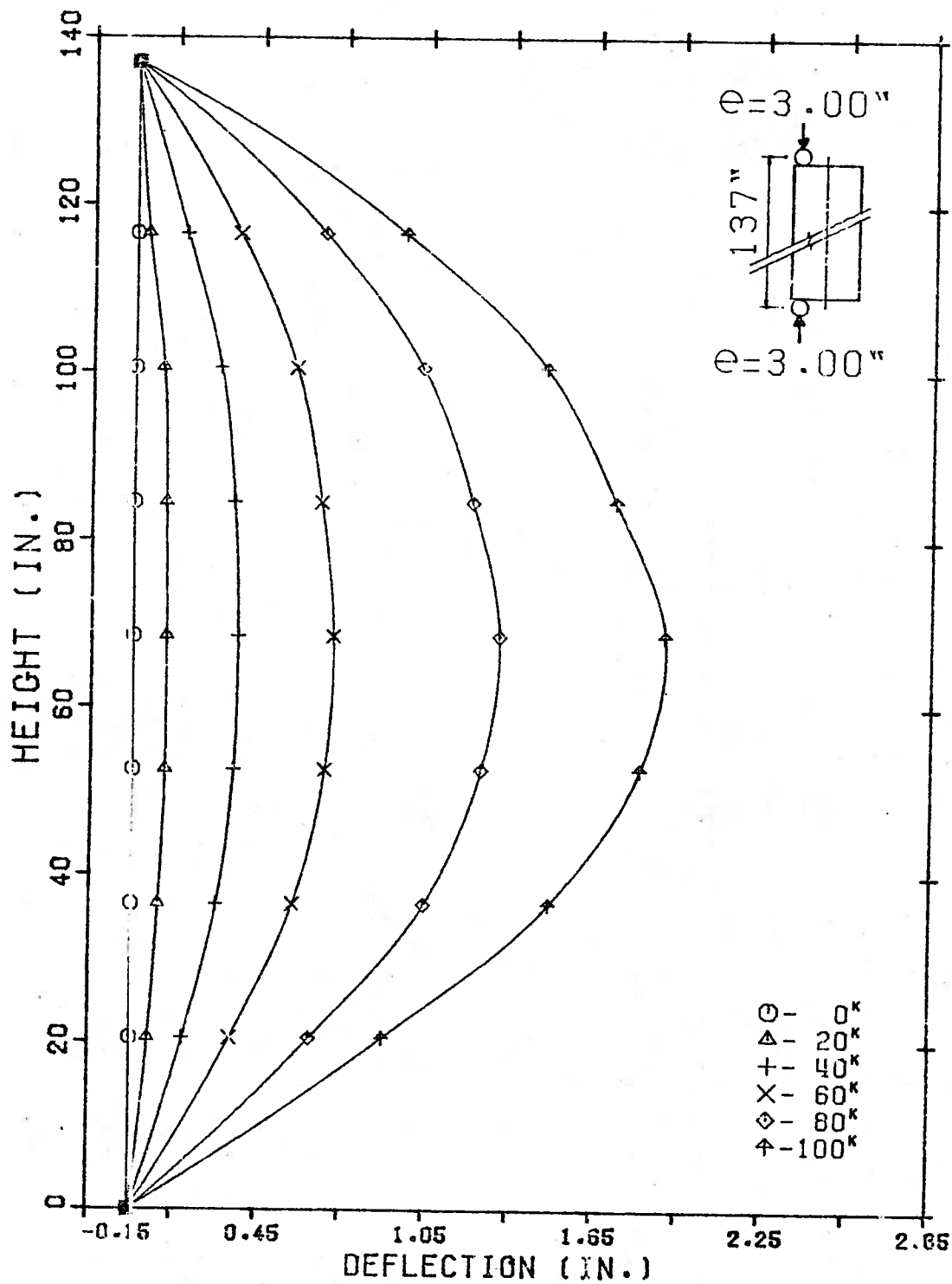

FIG. 2-21 Deflected Shape of Wall D5

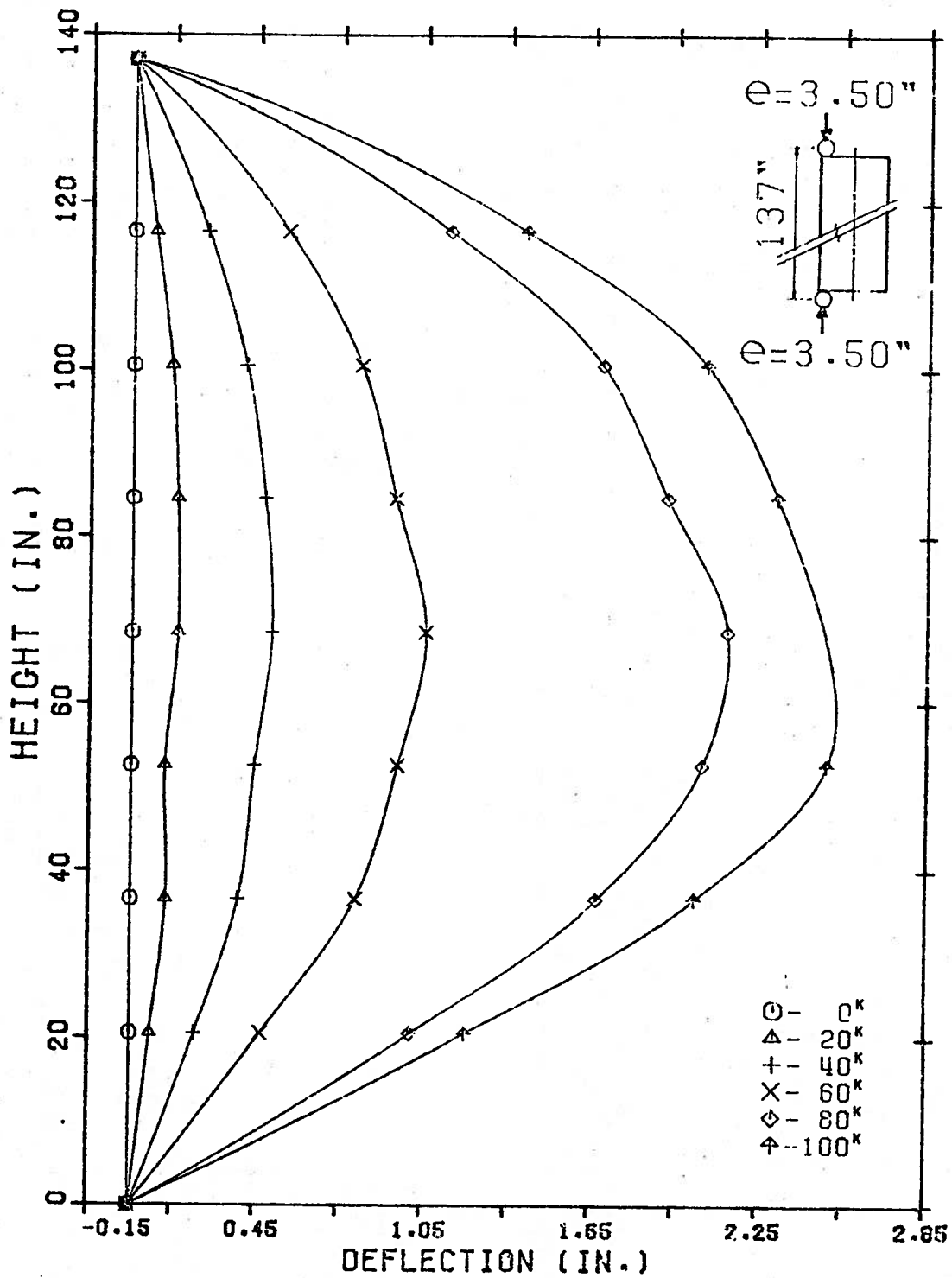

FIG. 2-22 Deflected Shape of Wall D6

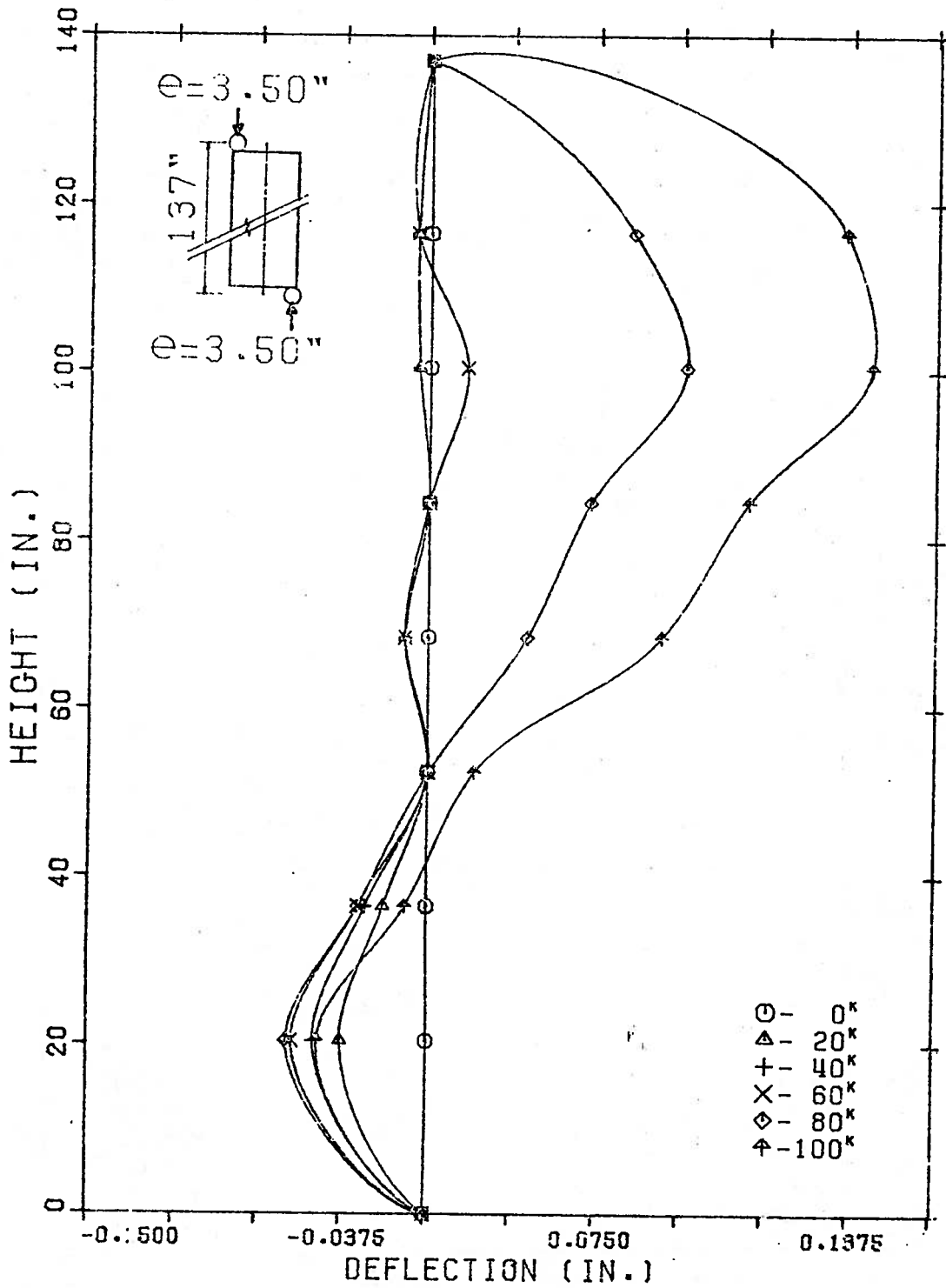

FIG. 2-23 Deflected Shape of Wall E1

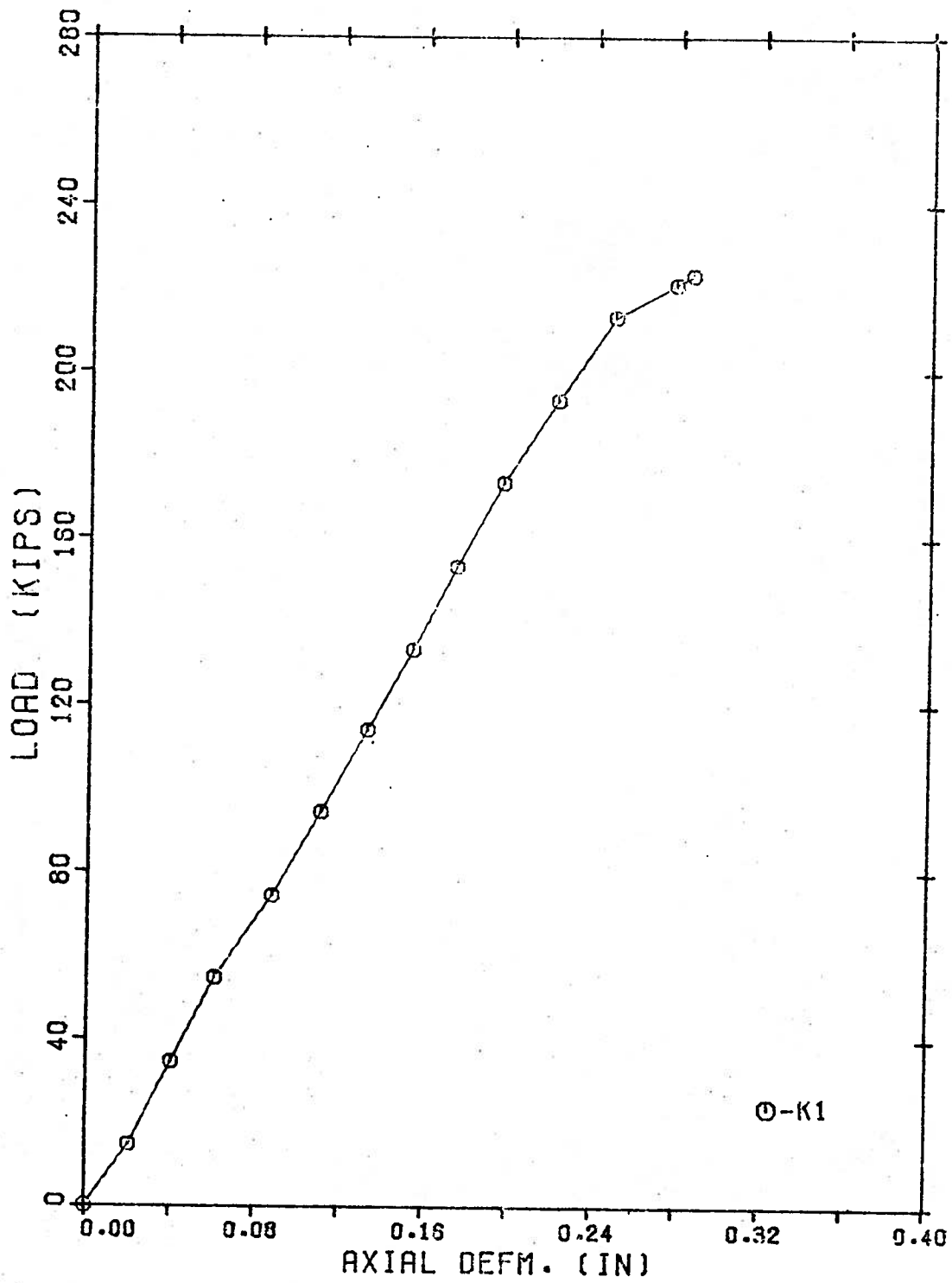

FIG. 2-75 Vertical Deformation of Series K

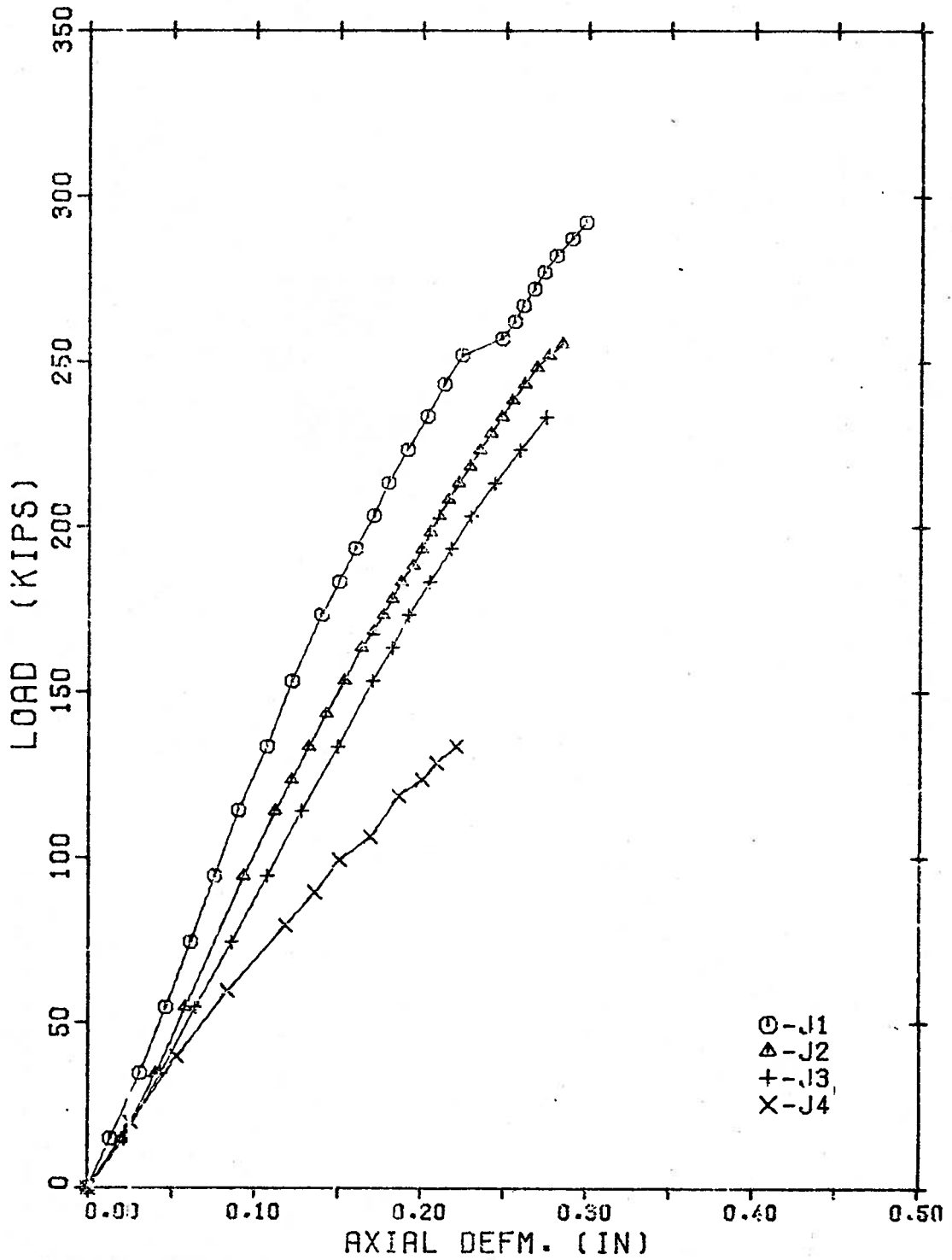

FIG. 2-74 Vertical Deformation of Series J

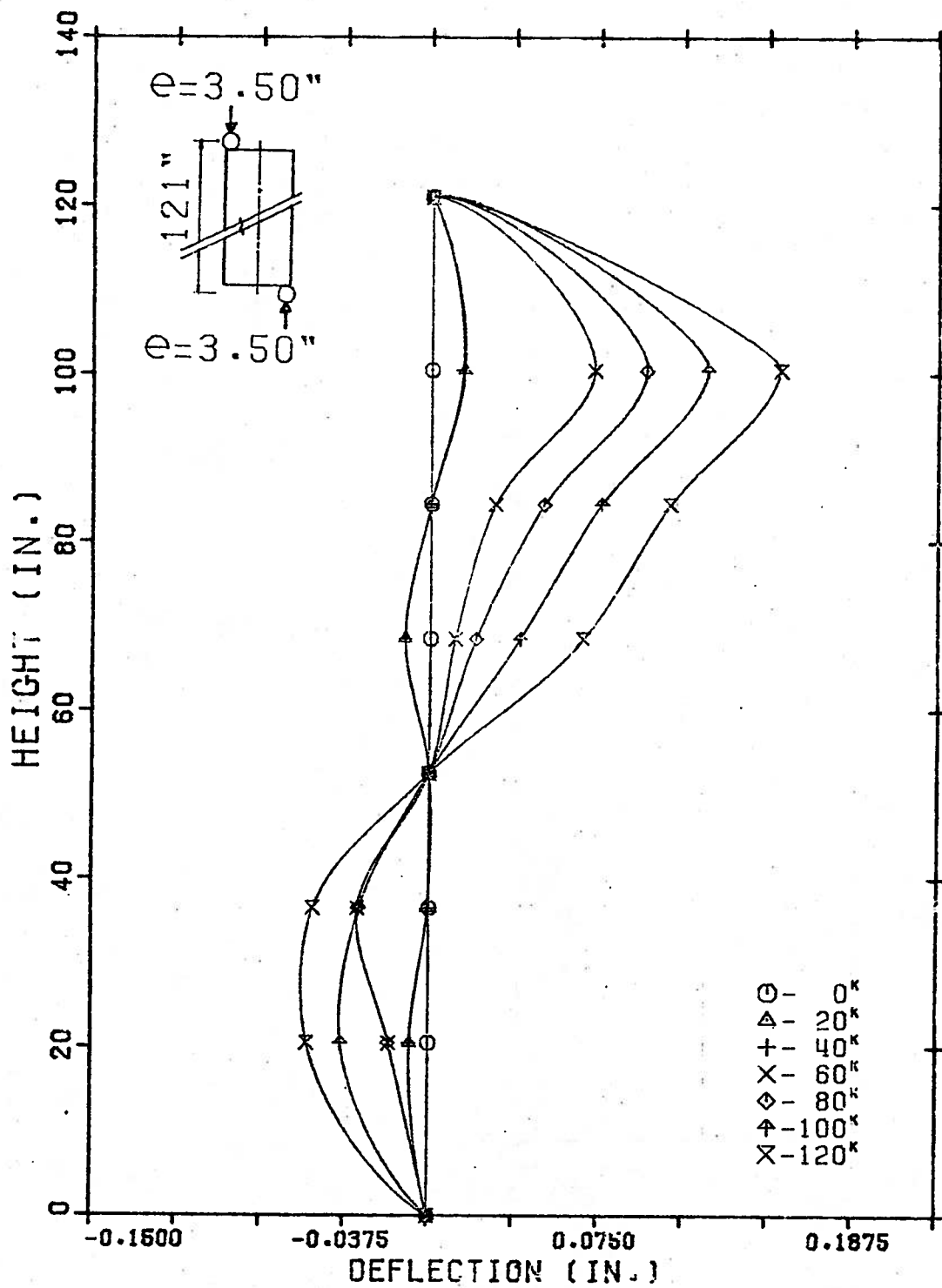

FIG. 2-24 Deflected Shape of Wall E2

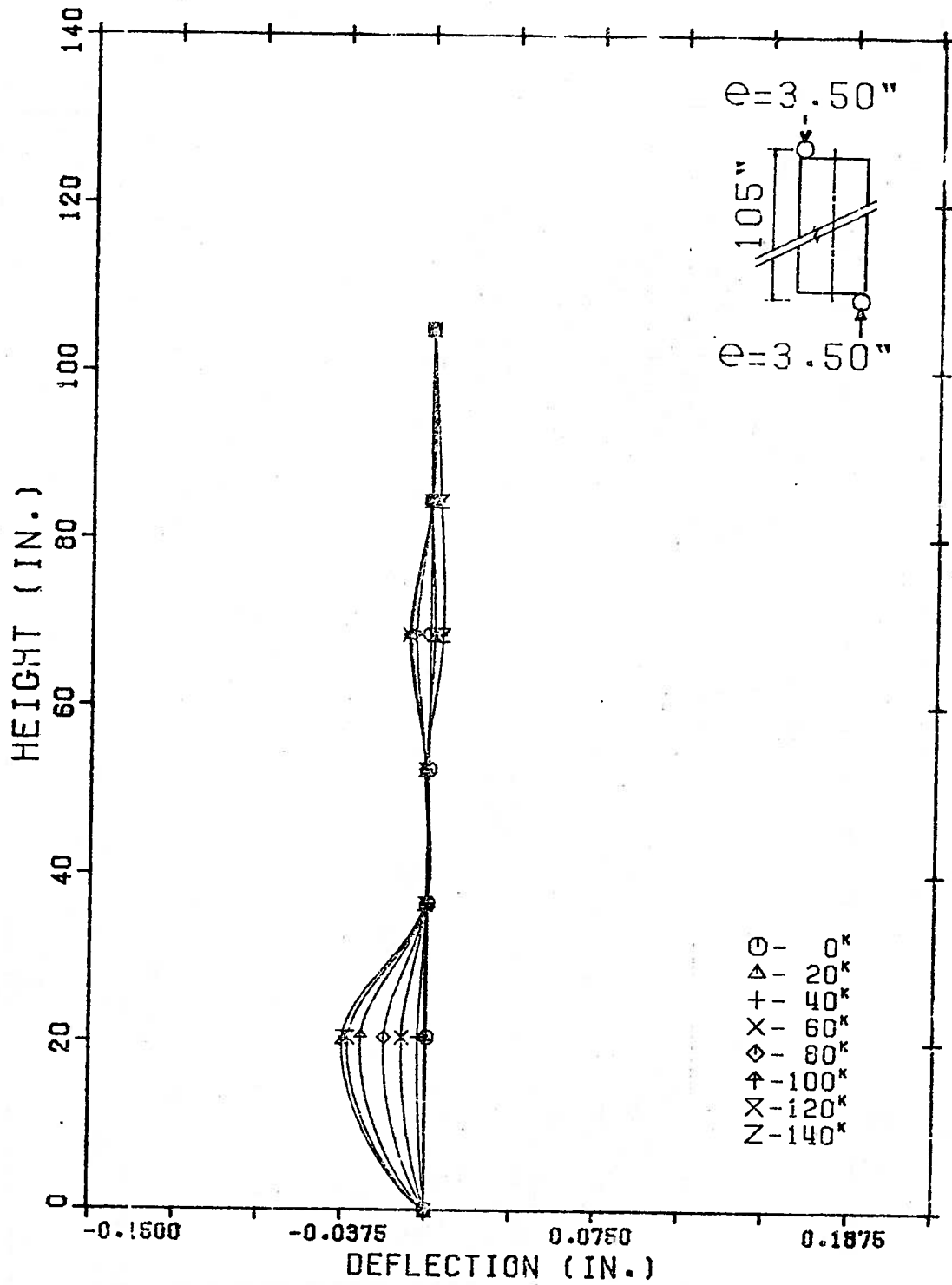

FIG. 2-25 Deflected Shape of Wall E3

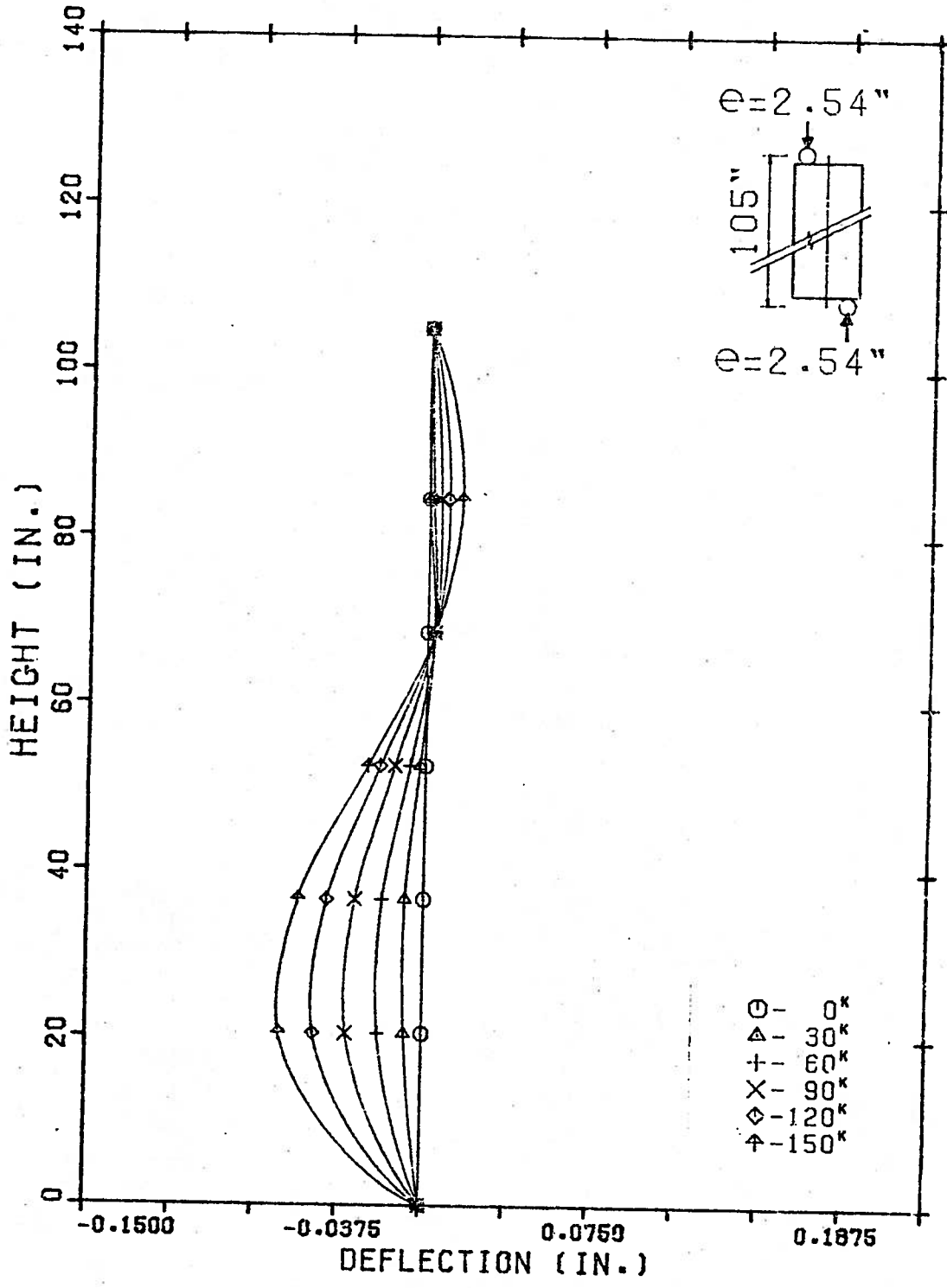

FIG. 2-26 Deflected Shape of Wall E4

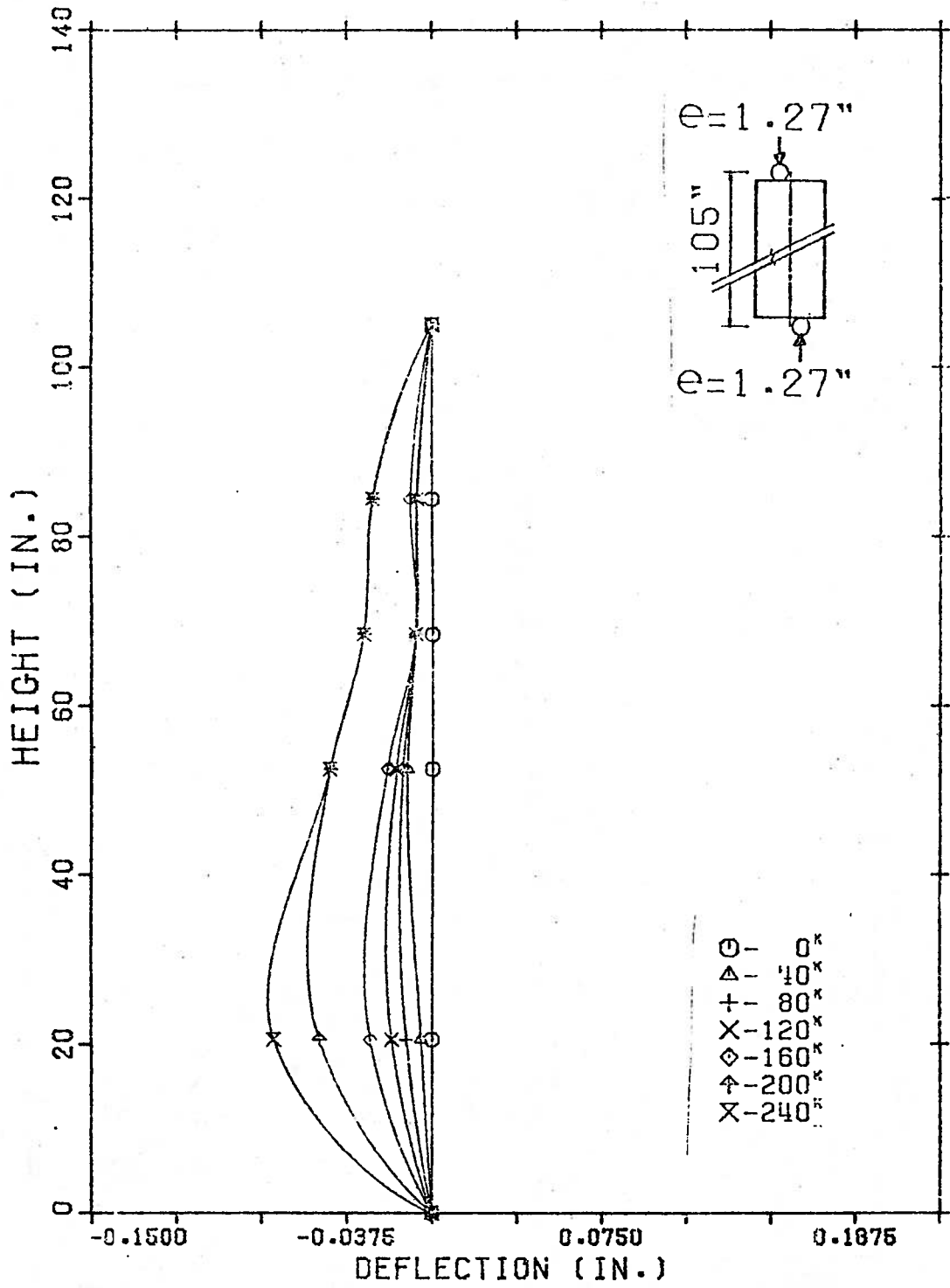

FIG. 2-27 Deflected Shape of Wall E5

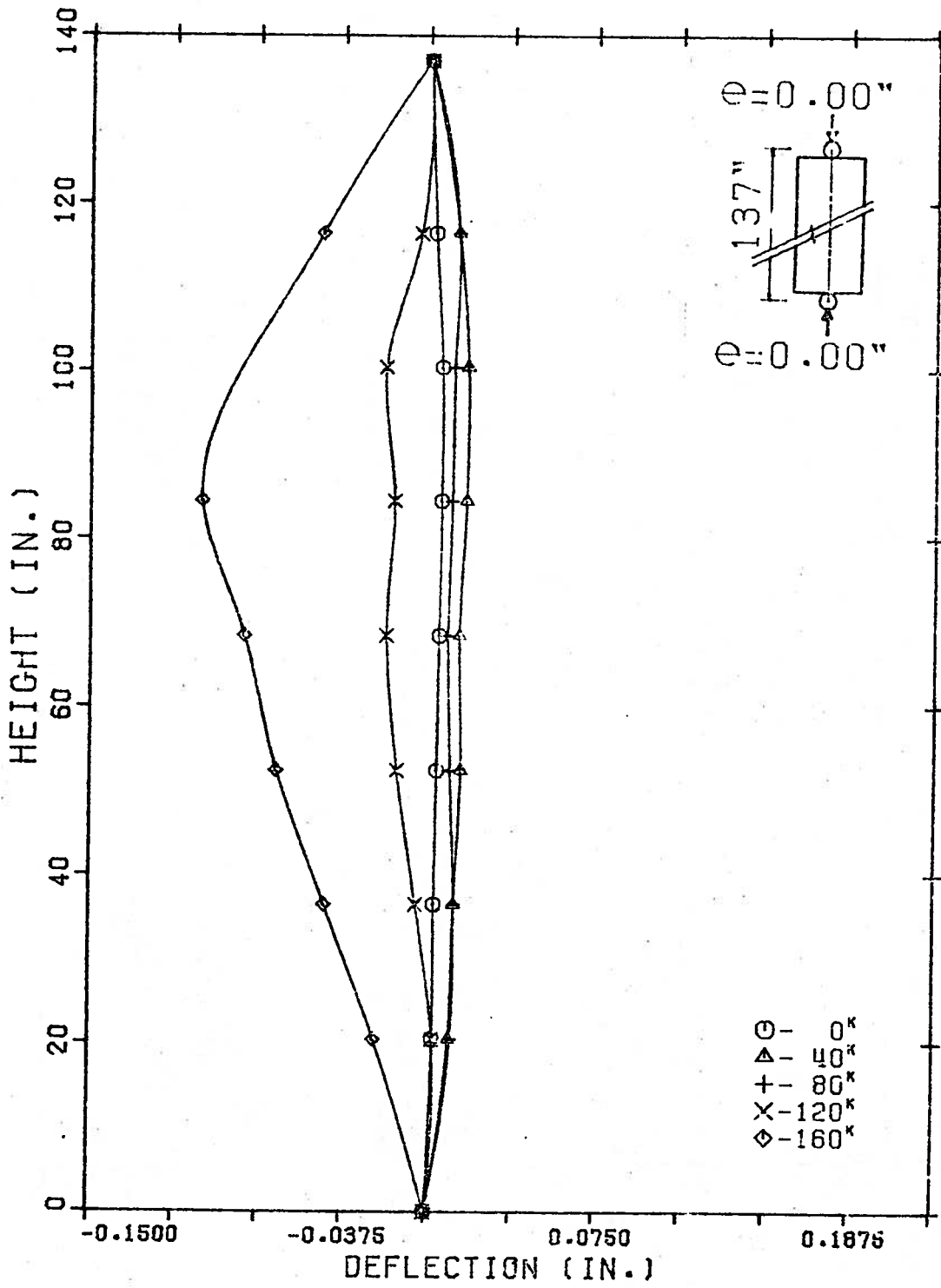

FIG. 2-28 Deflected Shape of Wall F1

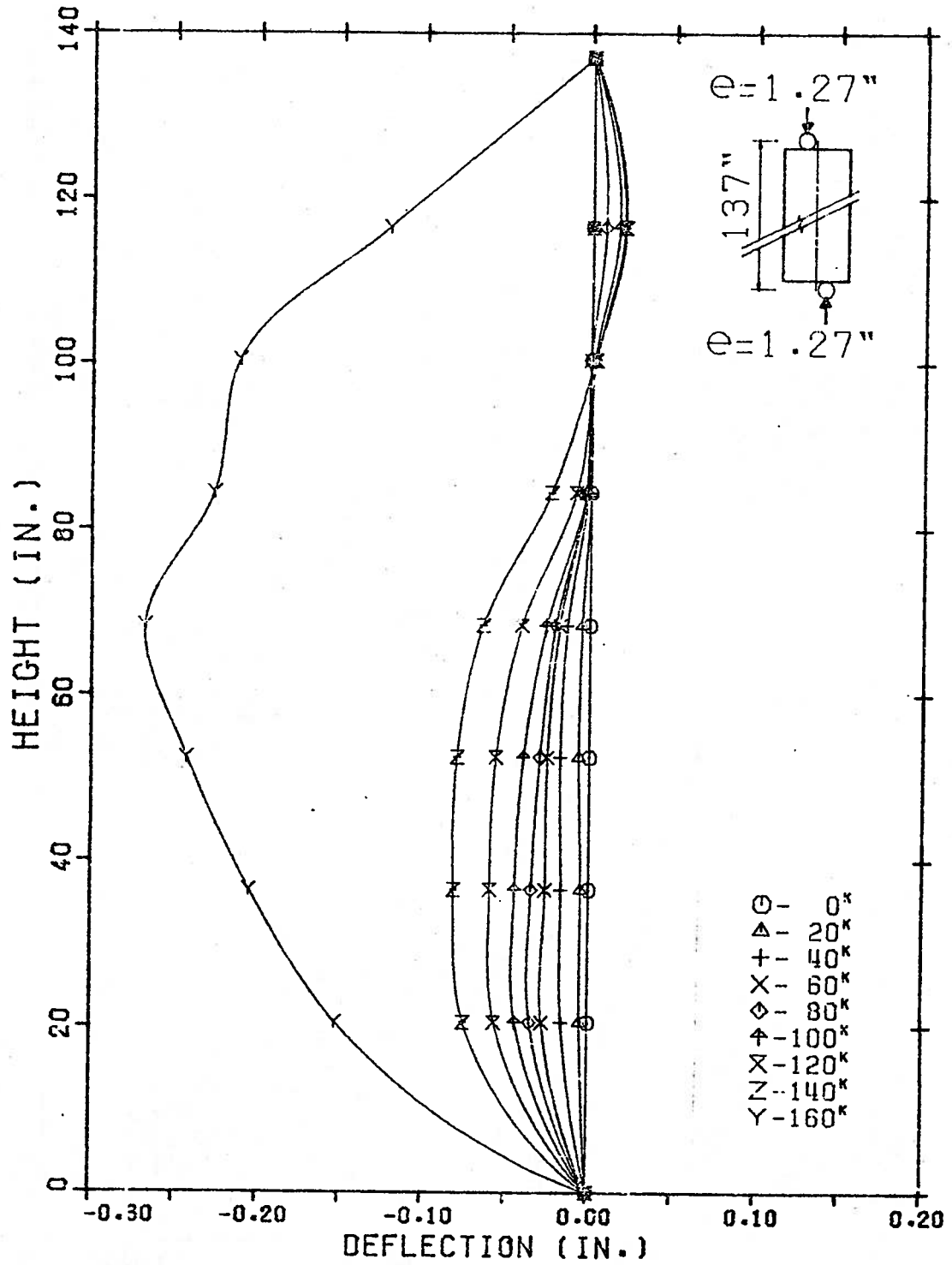

FIG. 2-29 Deflected Shape of Wall F2

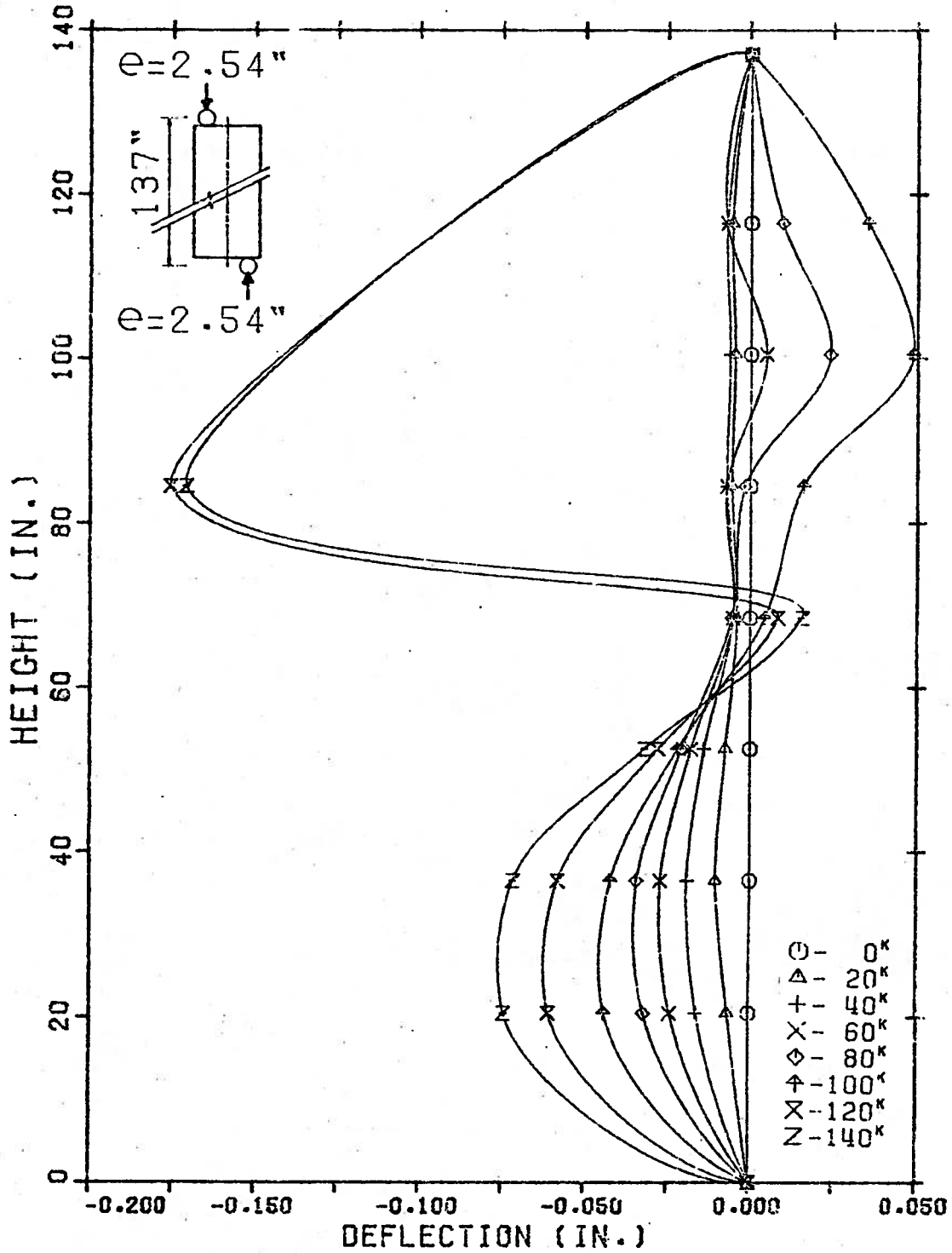

FIG. 2-30 Deflected Shape of Wall F3

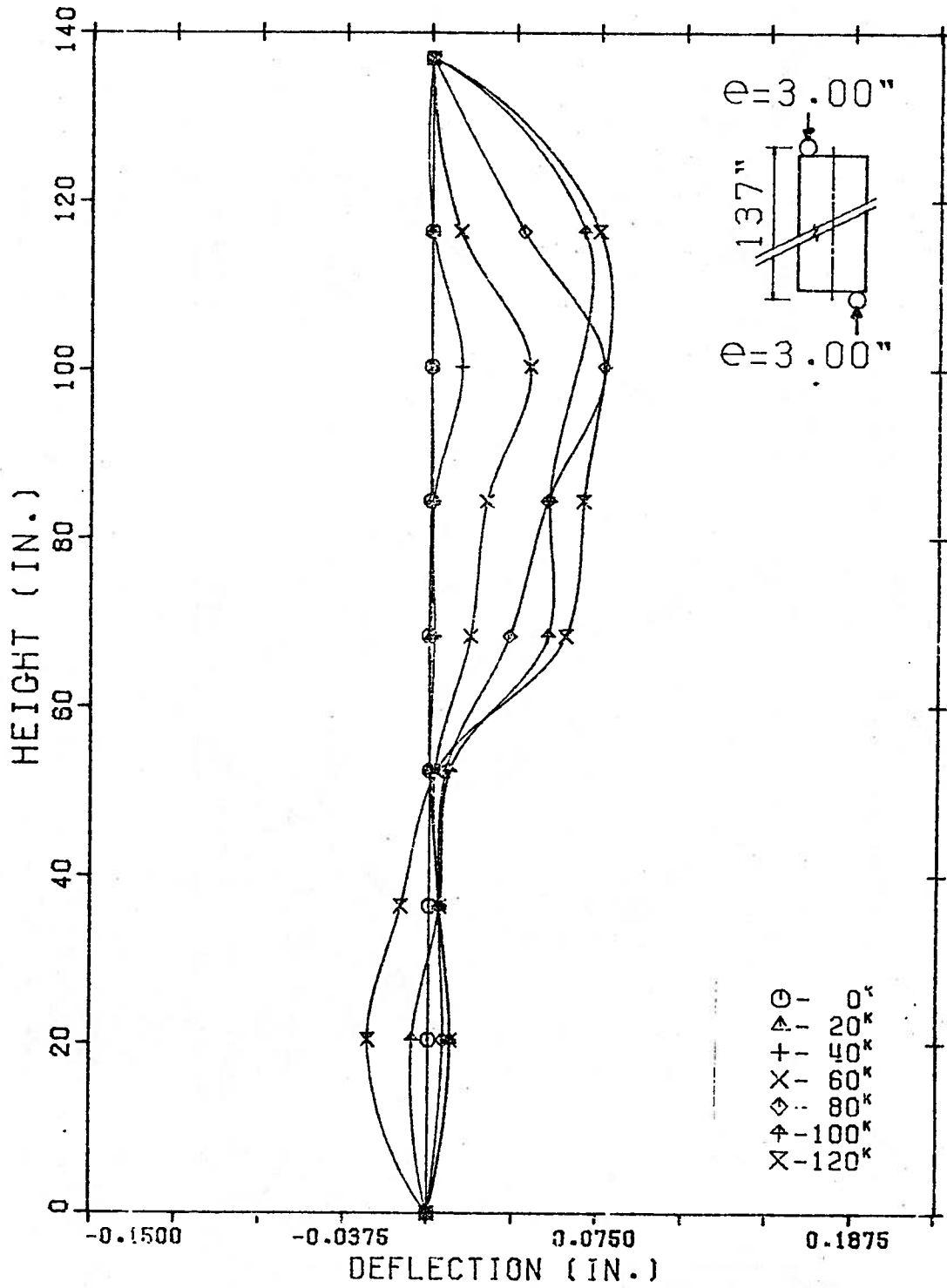

FIG. 2-31 Deflected Shape of Wall F4.

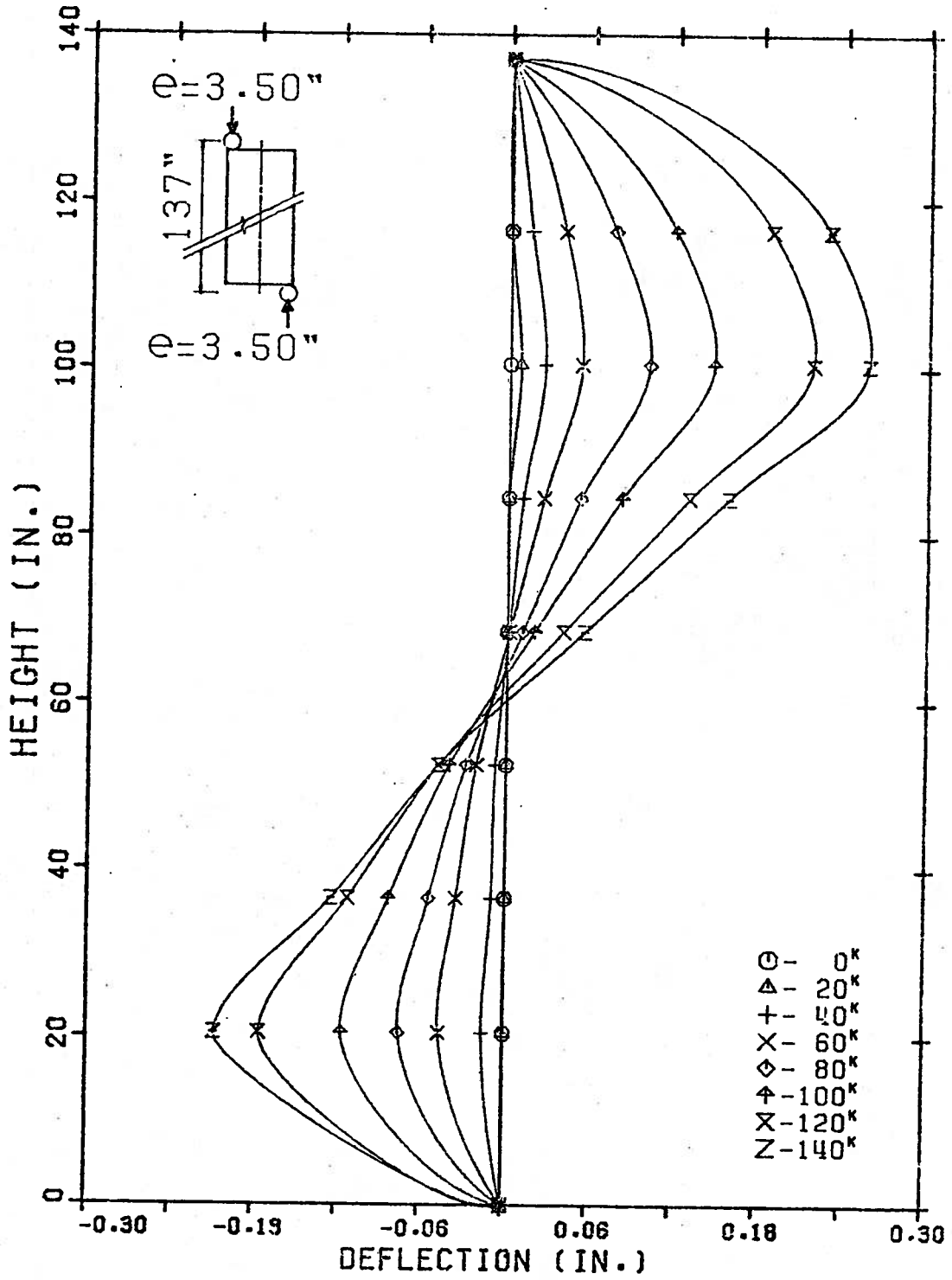

FIG. 2-32 Deflected Shape of Wall F5

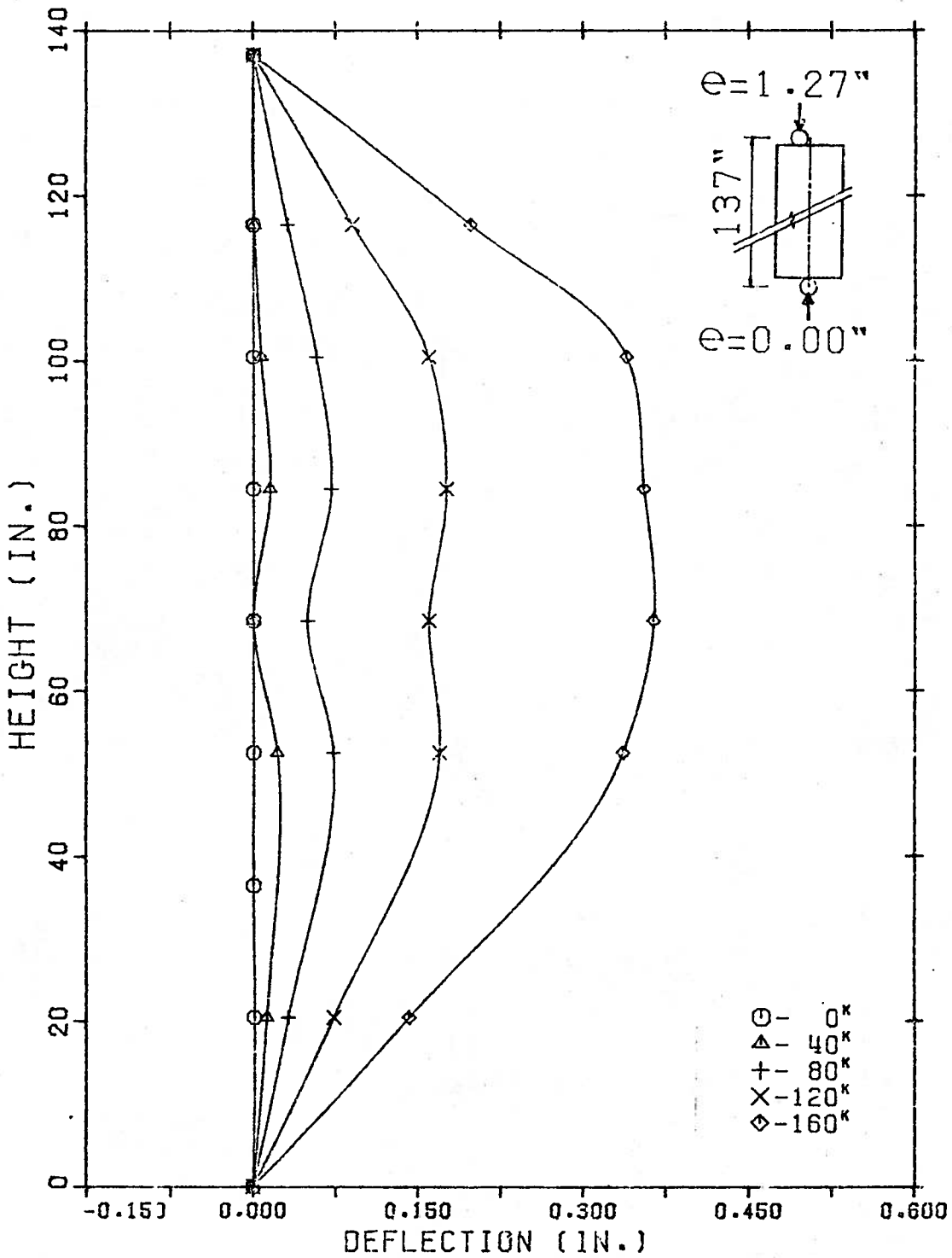

FIG. 2-33 Deflected Shape of Wall G1

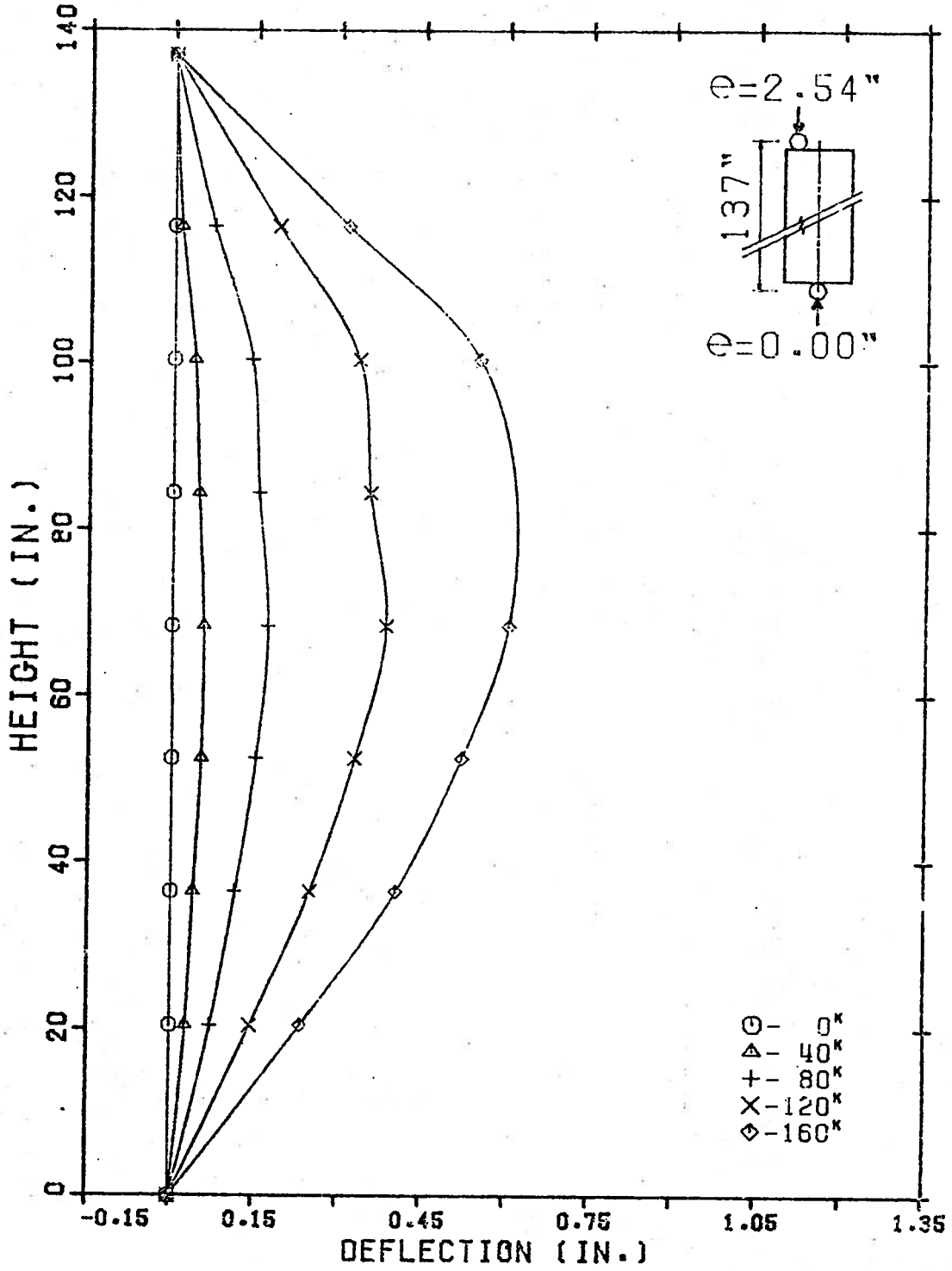

FIG. 2-34 Deflected Shape of Wall G2

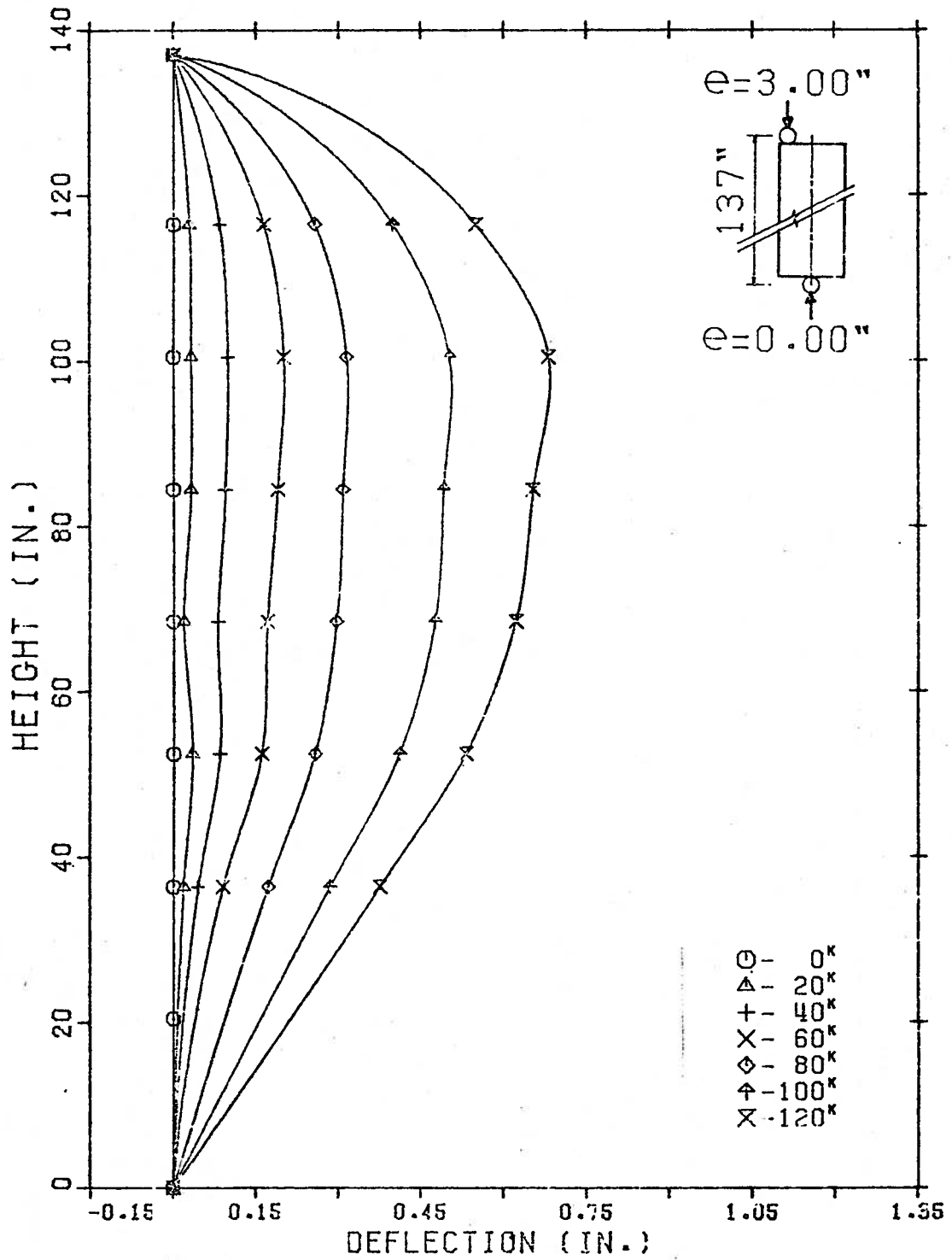

FIG. 2-35 Deflected Shape of Wall G3

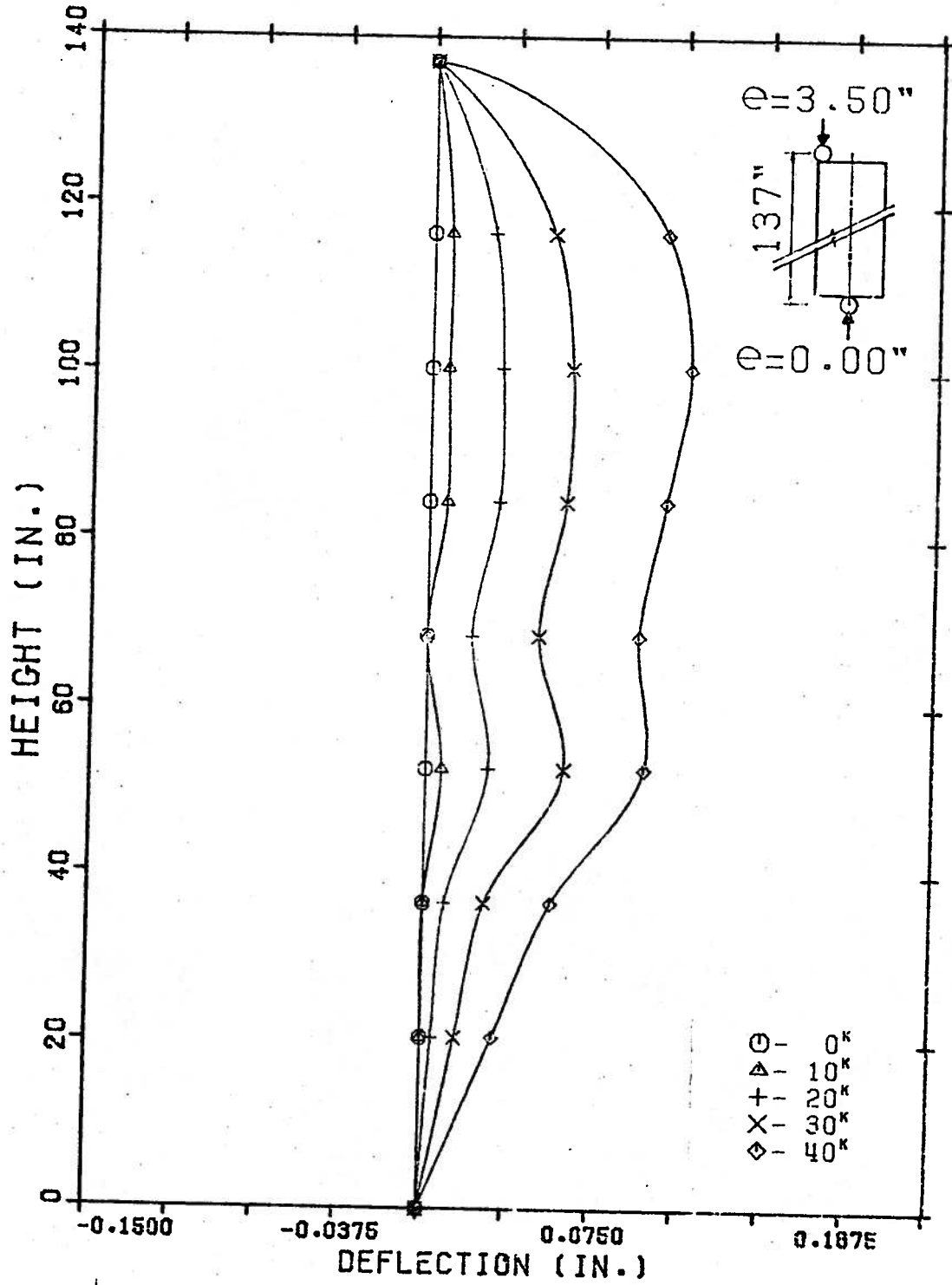

FIG. 2-36 Deflected Shape of Wall G4

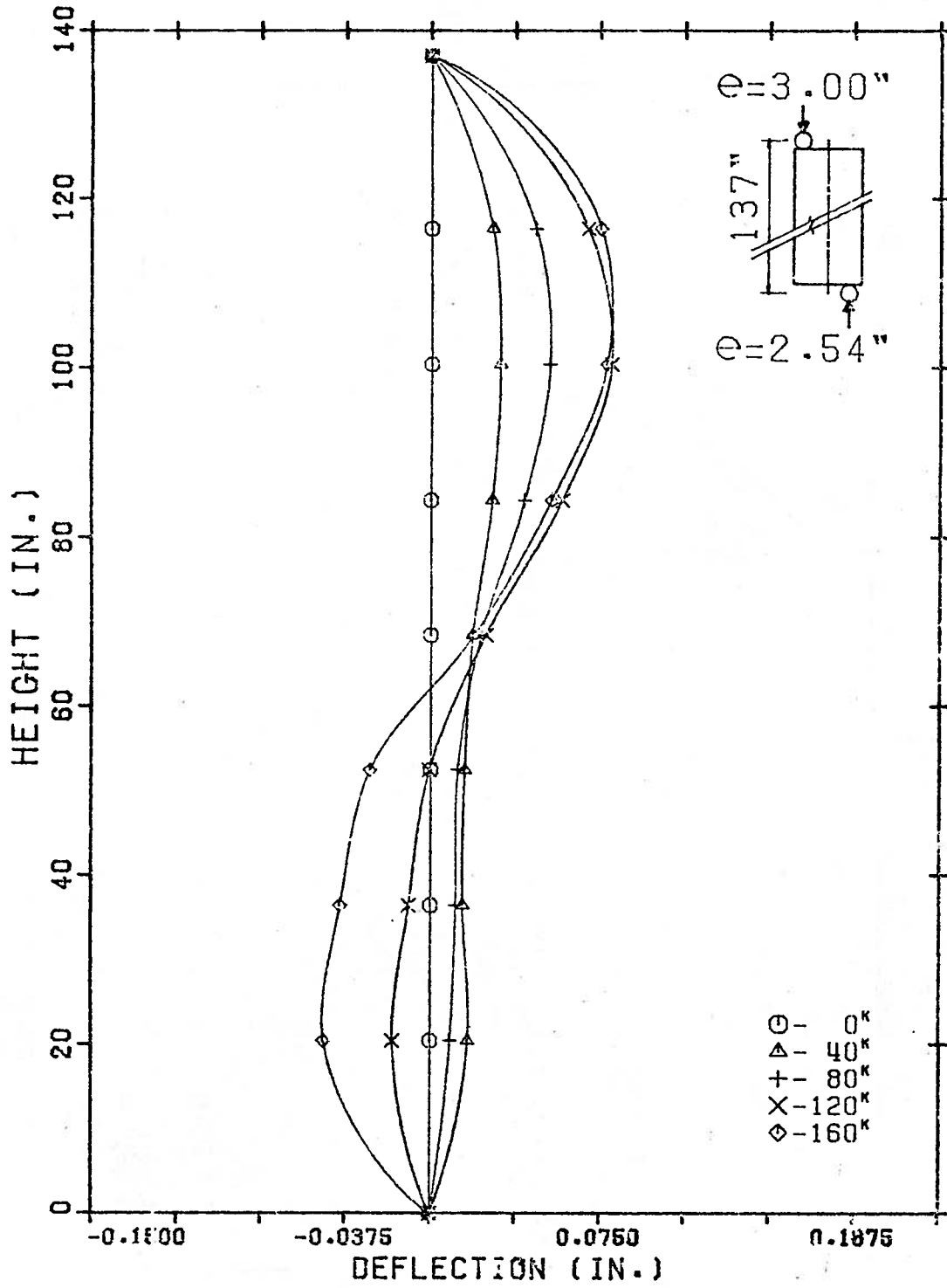

FIG. 2-37 Deflected Shape of Wall G5

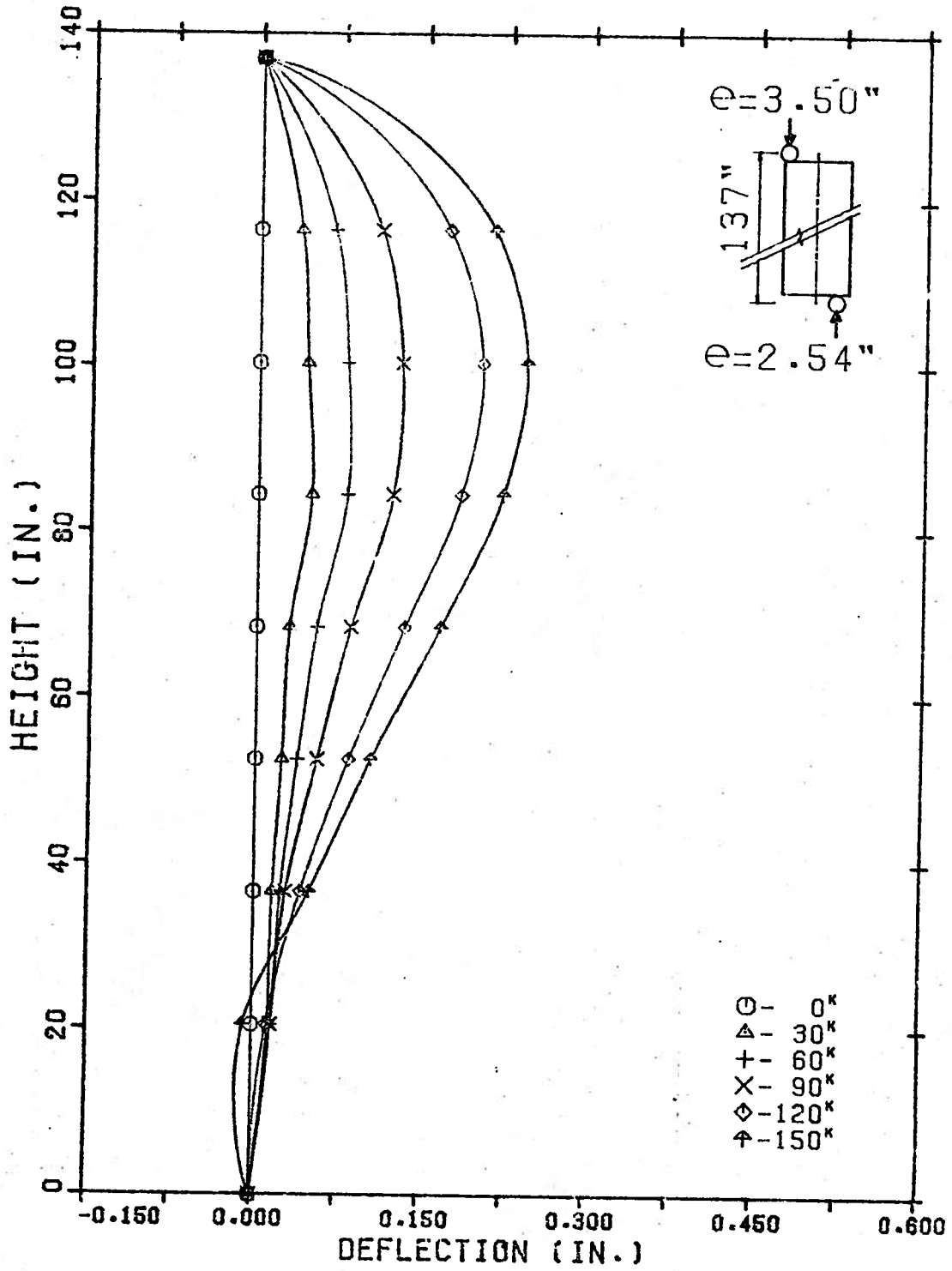

FIG. 2-38 Deflected Shape of Wall G6

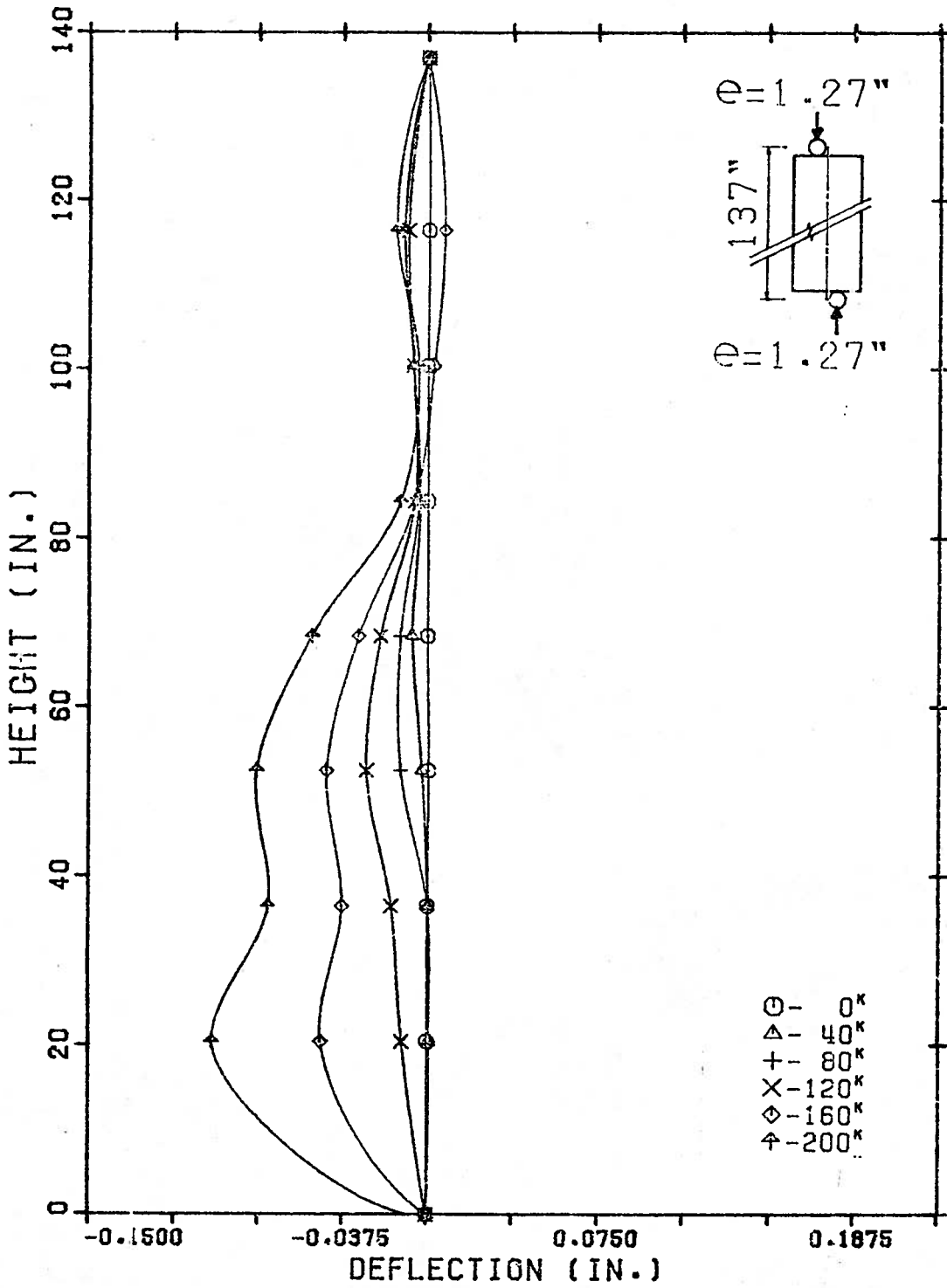

FIG. 2-39 Deflected Shape of Wall G7

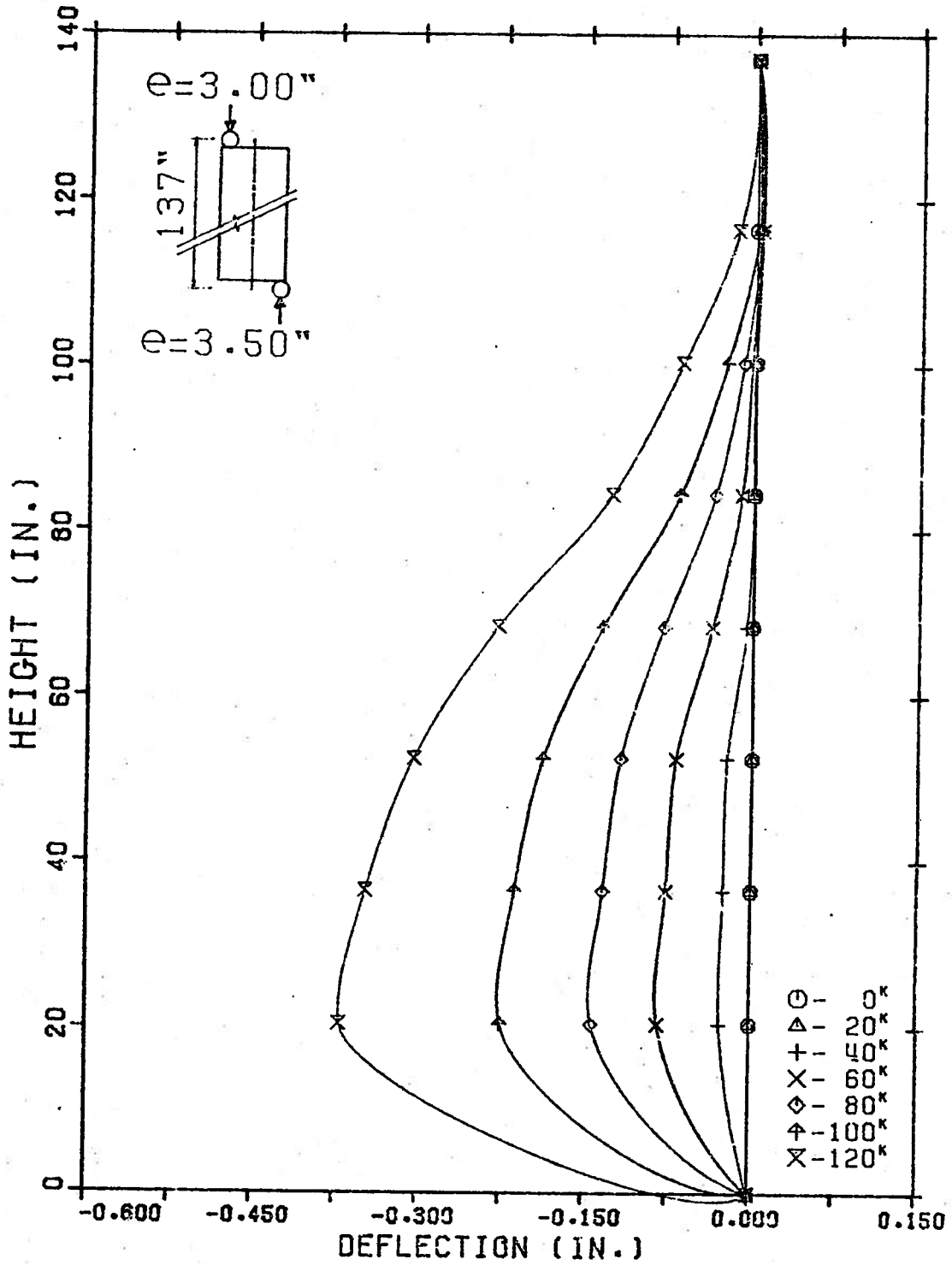

FIG. 2-40 Deflected Shape of Wall G8

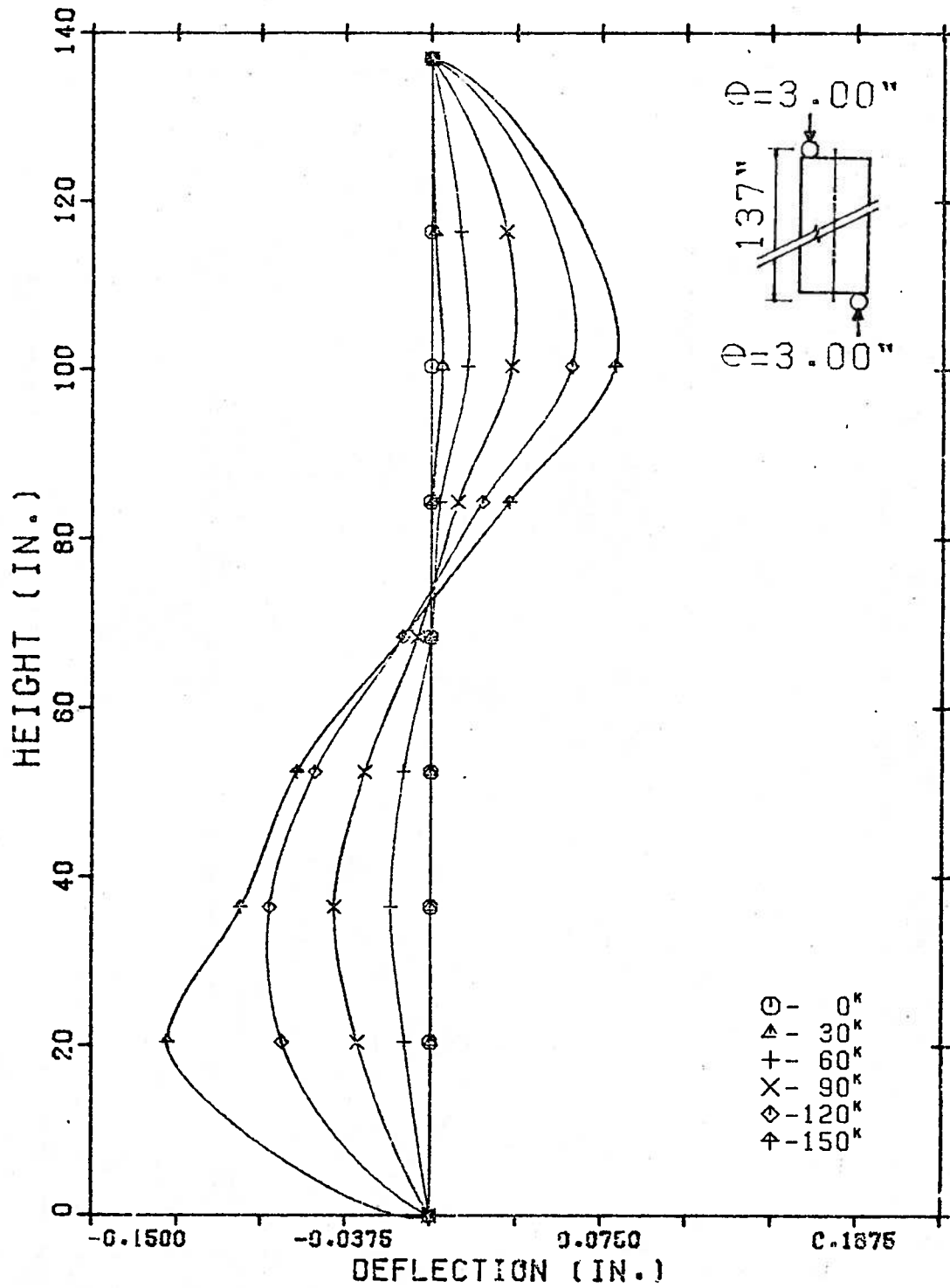

FIG. 2-41 Deflected Shape of Wall G9

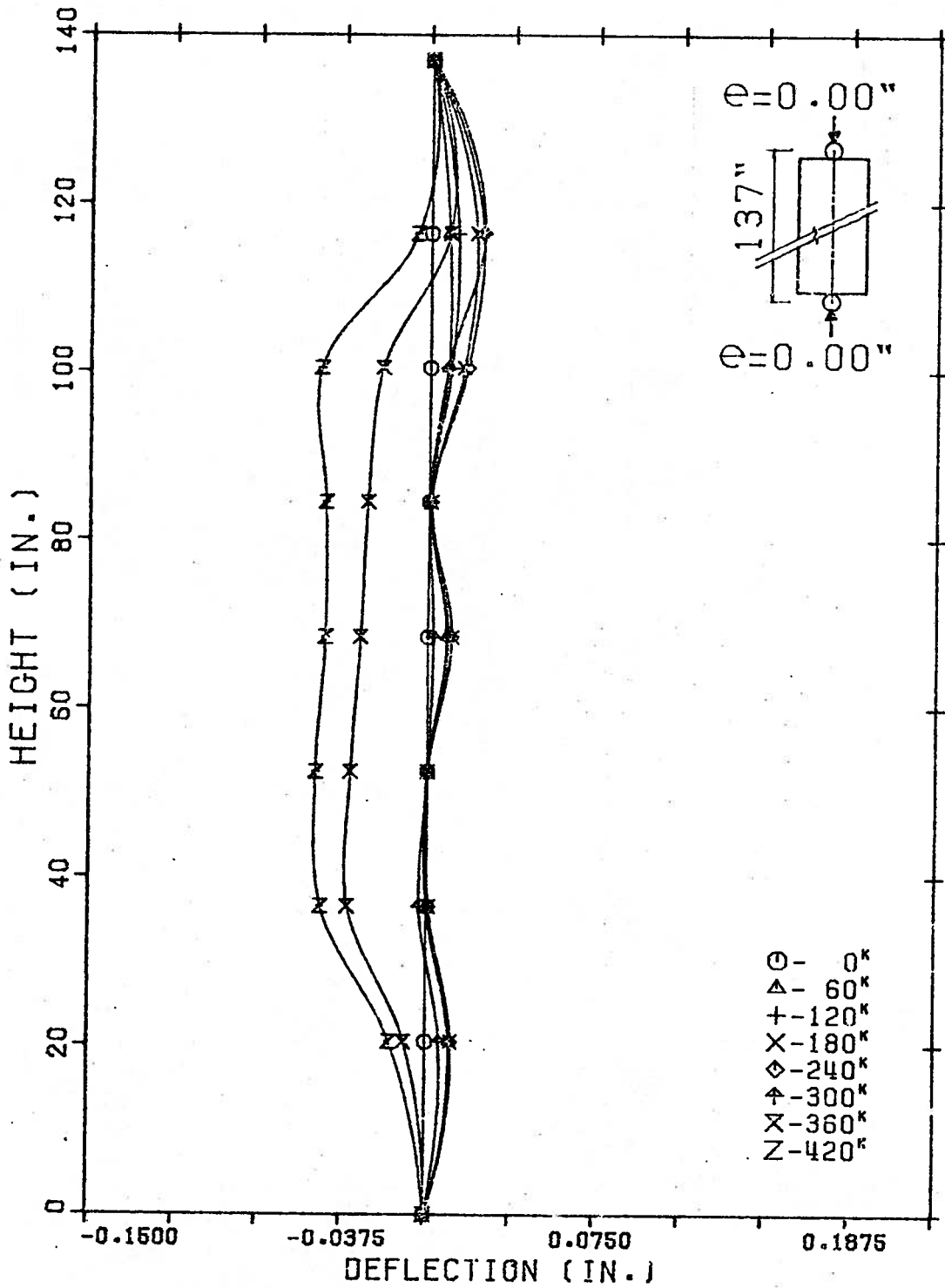

FIG. 2-42 Deflected Shape of Wall H1

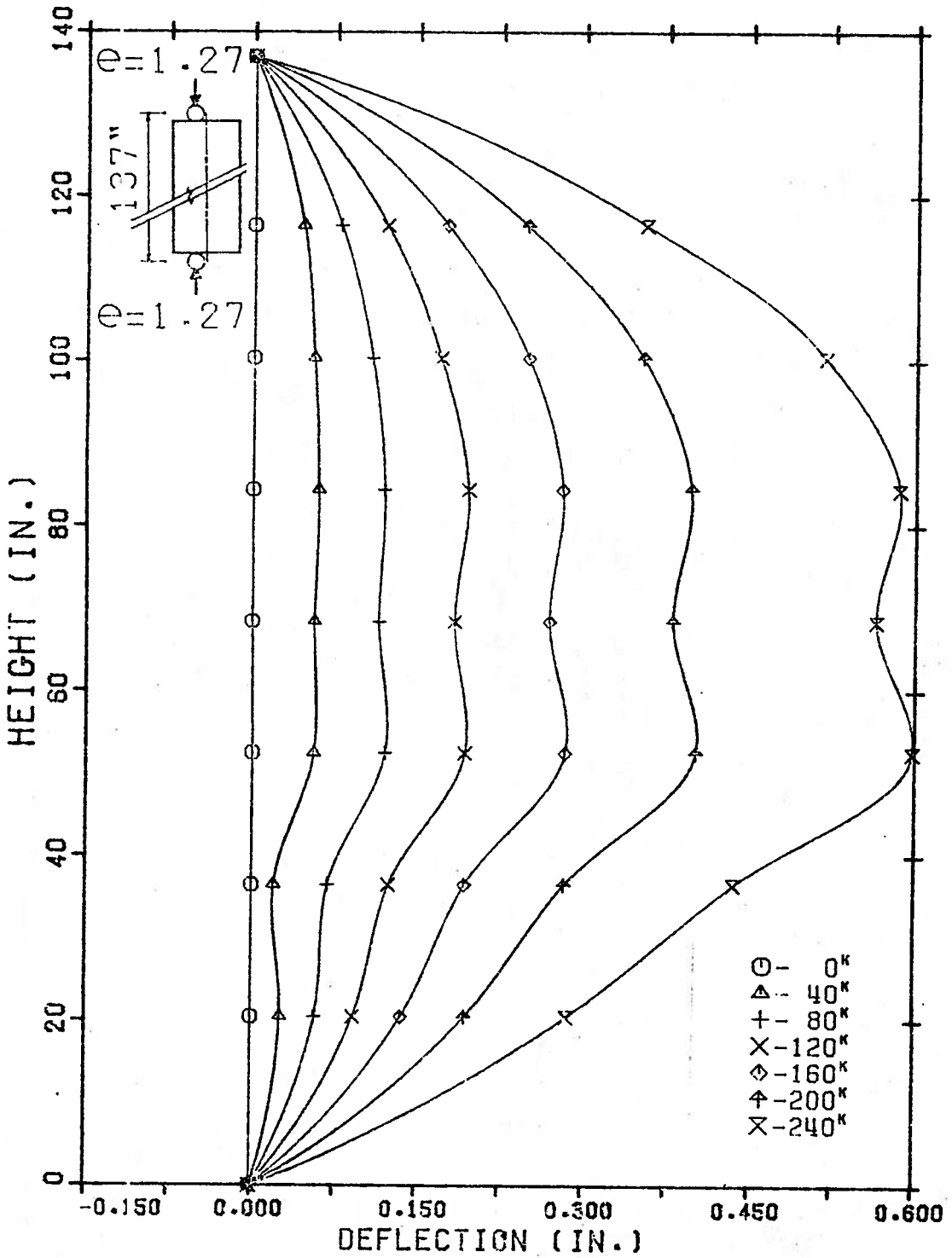

FIG. 2-43 Deflected Shape of Wall H2

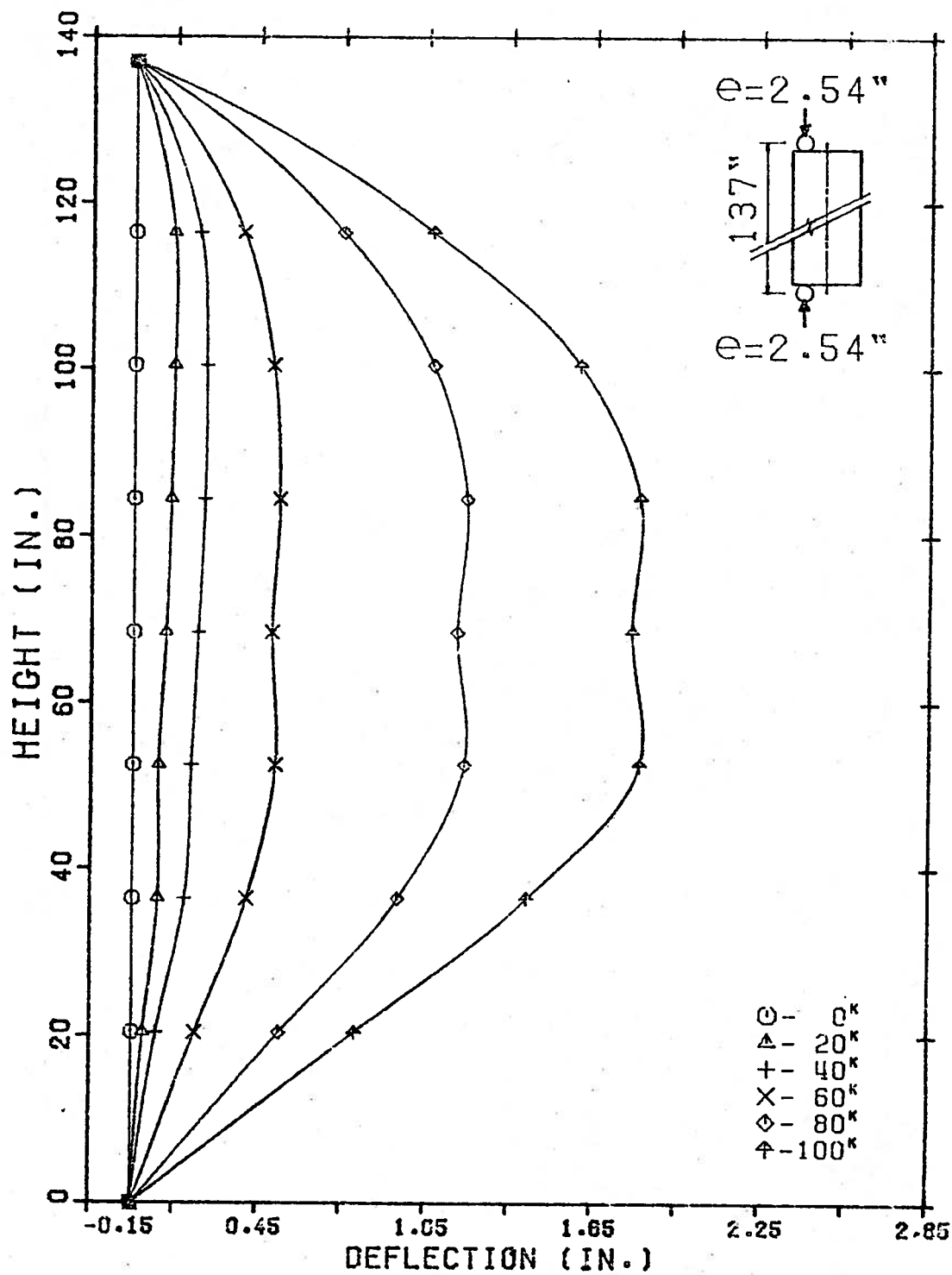

FIG. 2-44 Deflected Shape of Wall H3

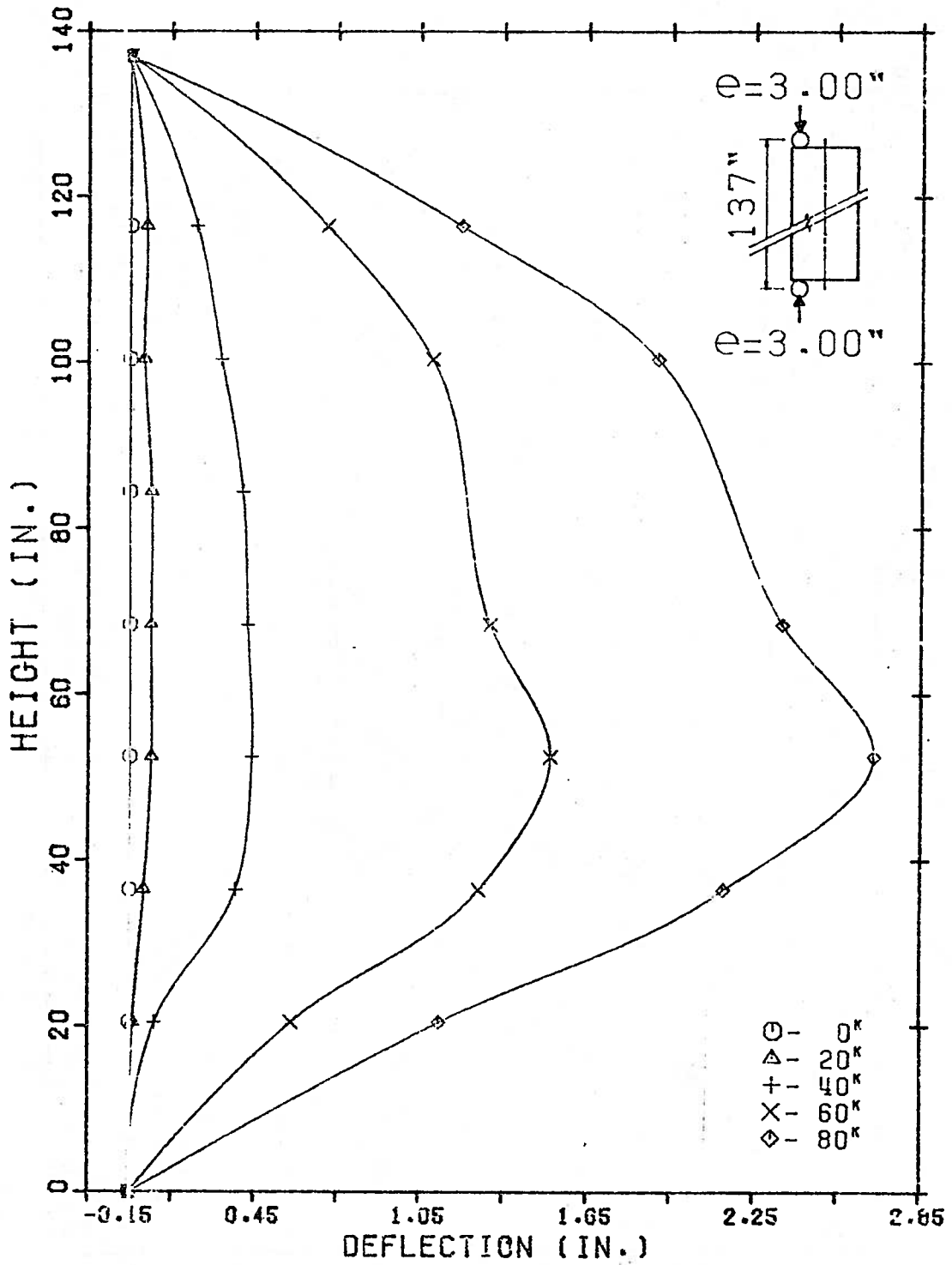

FIG. 2-45 Deflected Shape of Wall H4

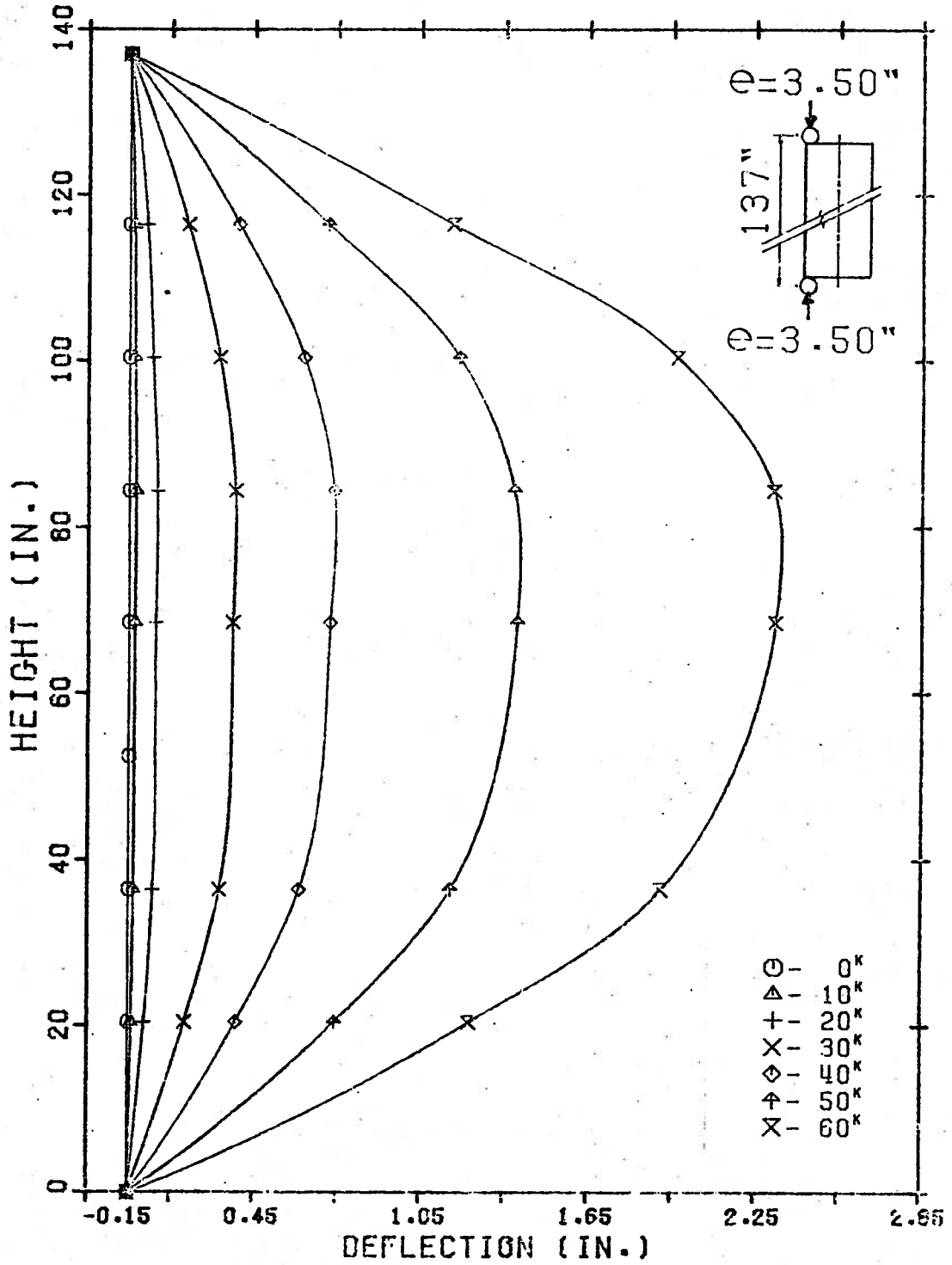

FIG. 2-46 Deflected Shape of Wall H5

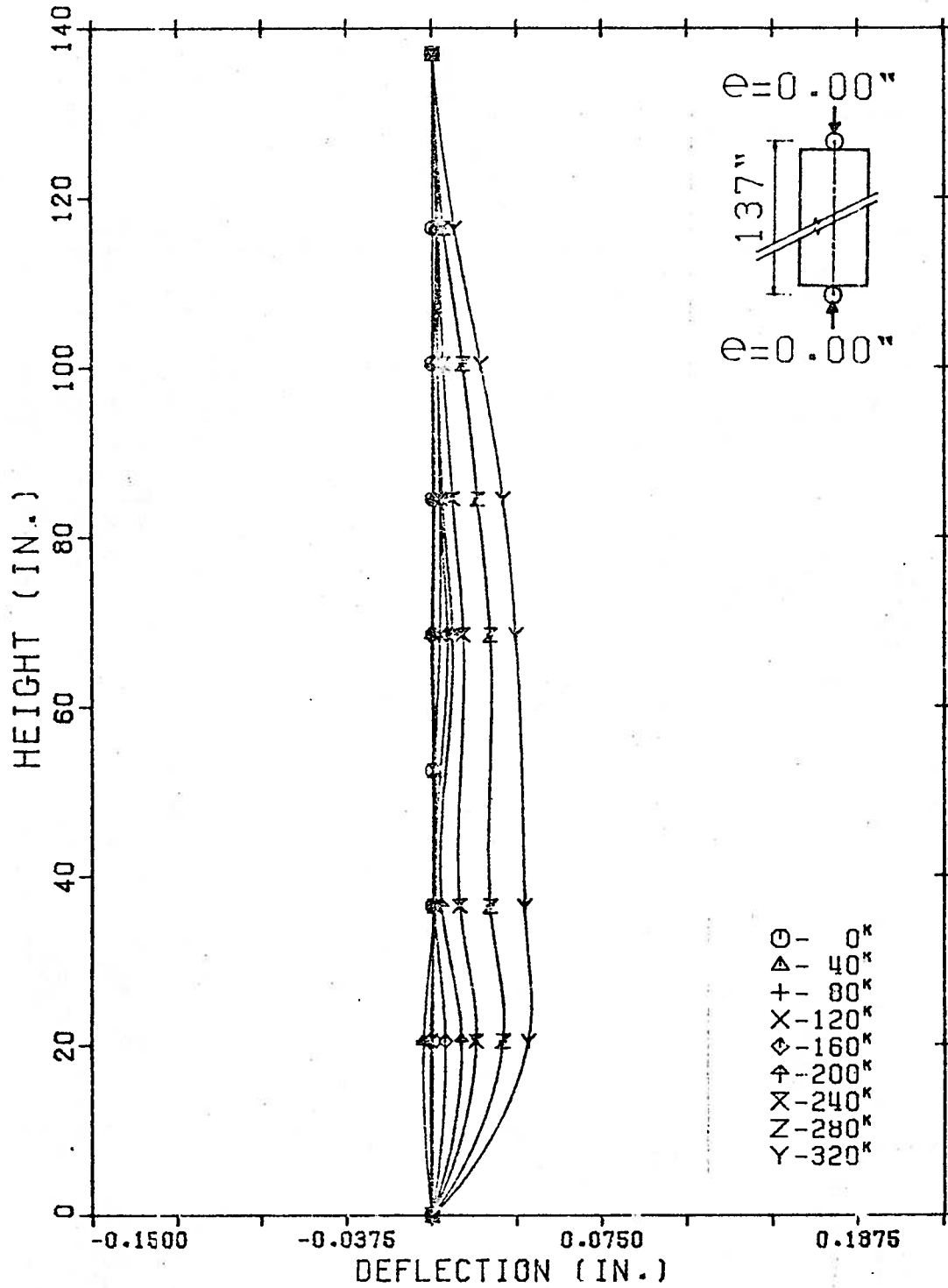

FIG. 2-47 Deflected Shape of Wall II

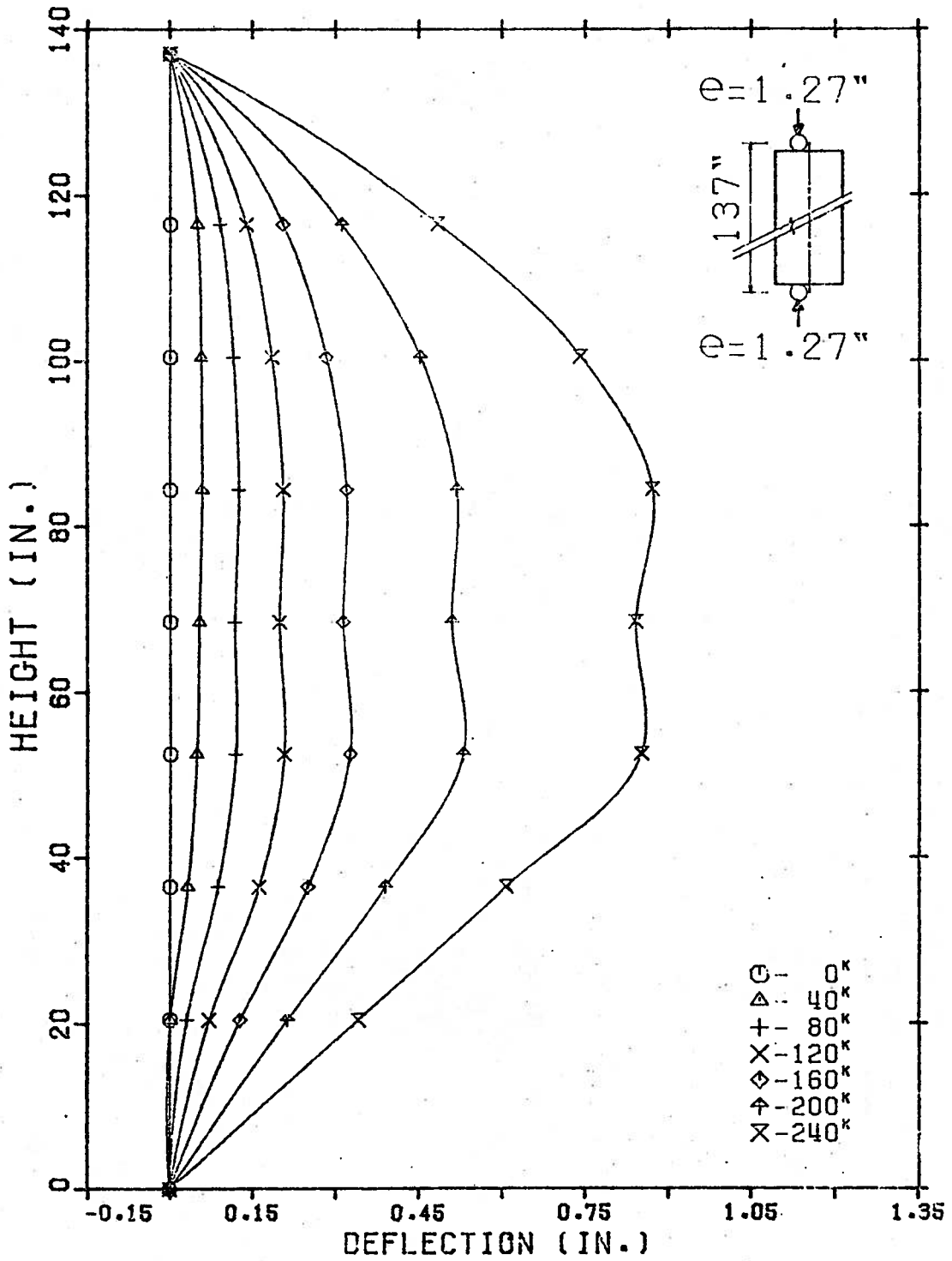

FIG. 2-48 Deflected Shape of Wall I2

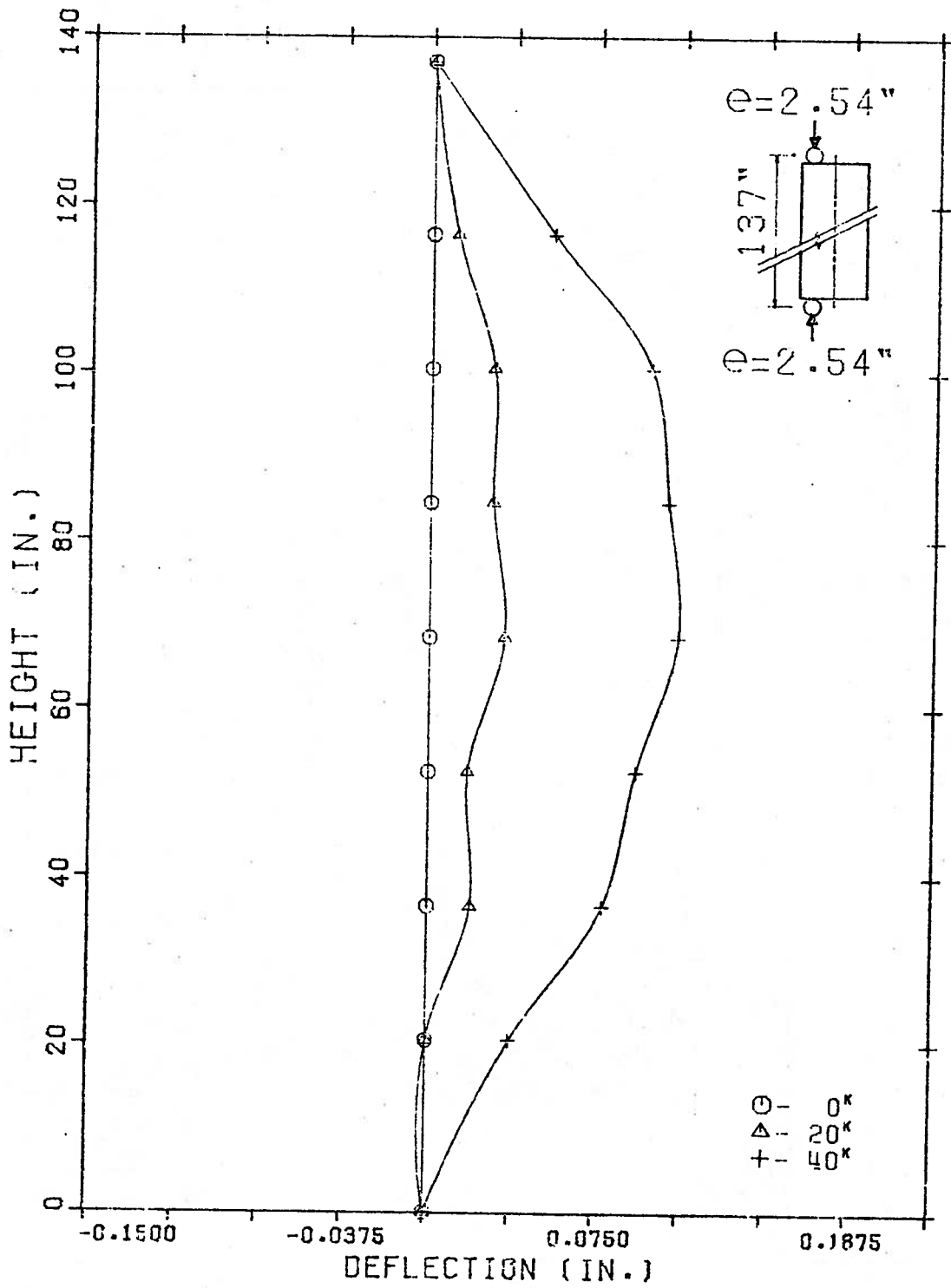

FIG. 2-49 Deflected Shape of Wall I3

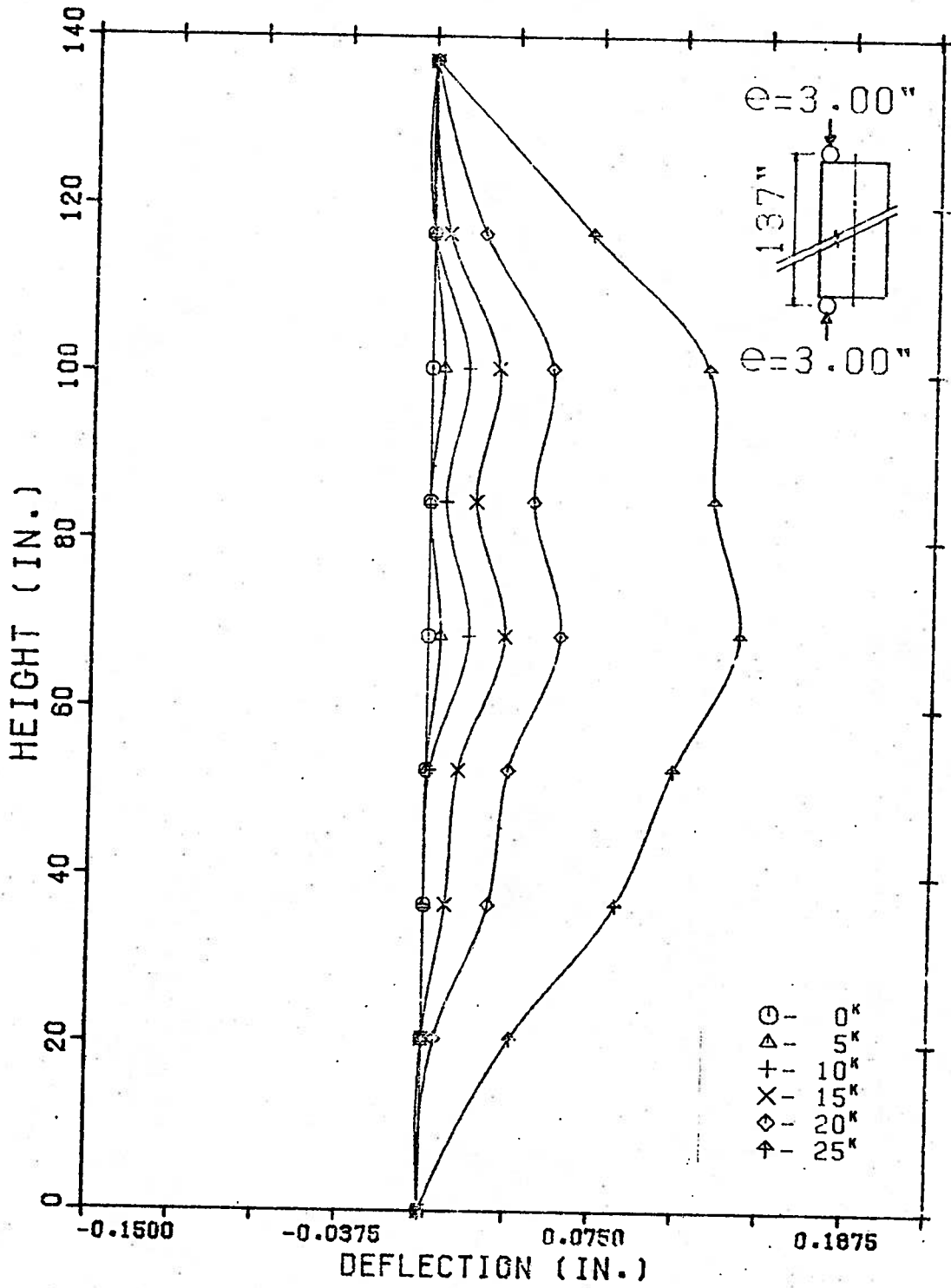

FIG. 2-50 Deflected Shape of Wall I4

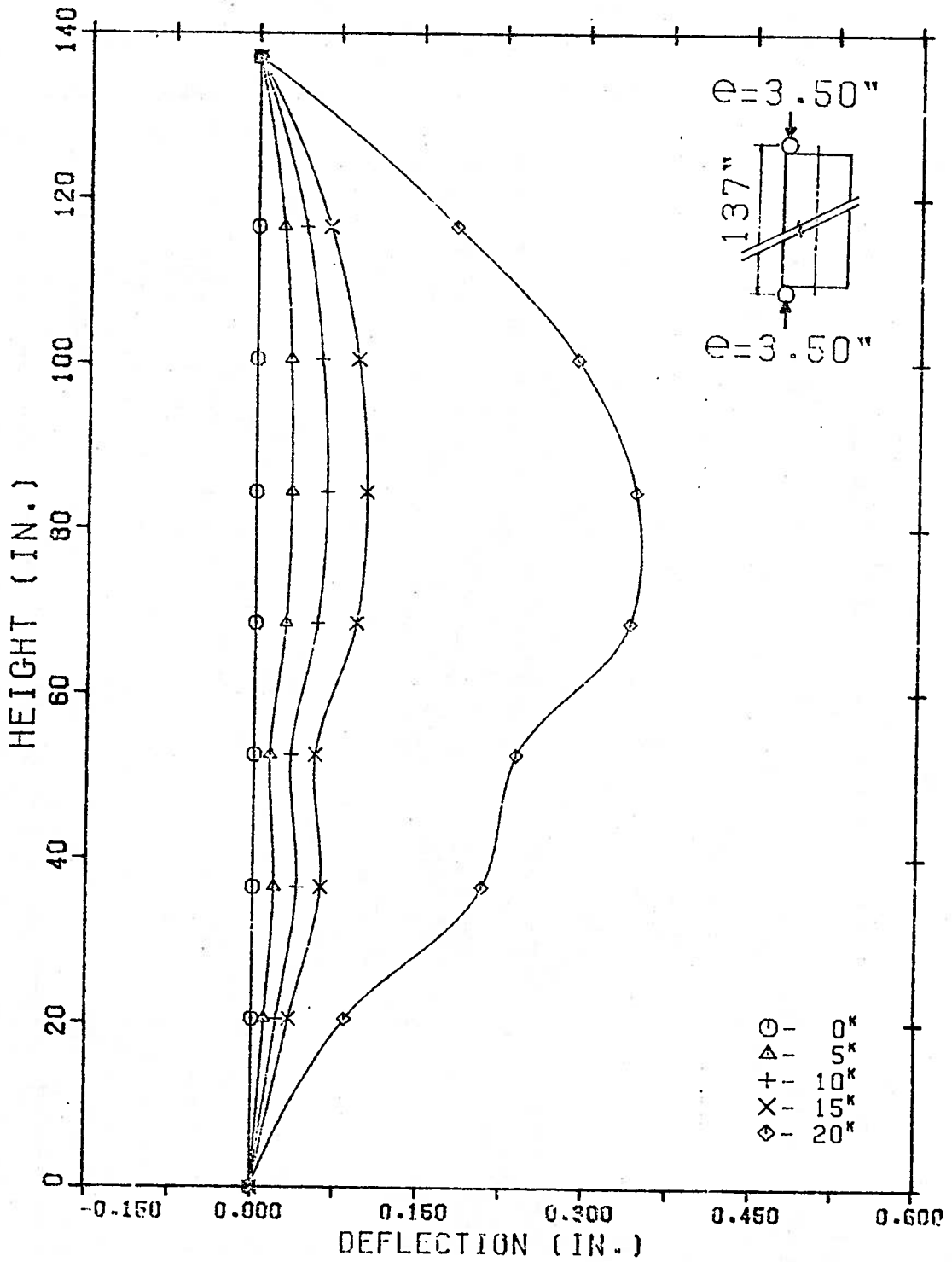

FIG. 2-51 Deflected Shape of Wall 15

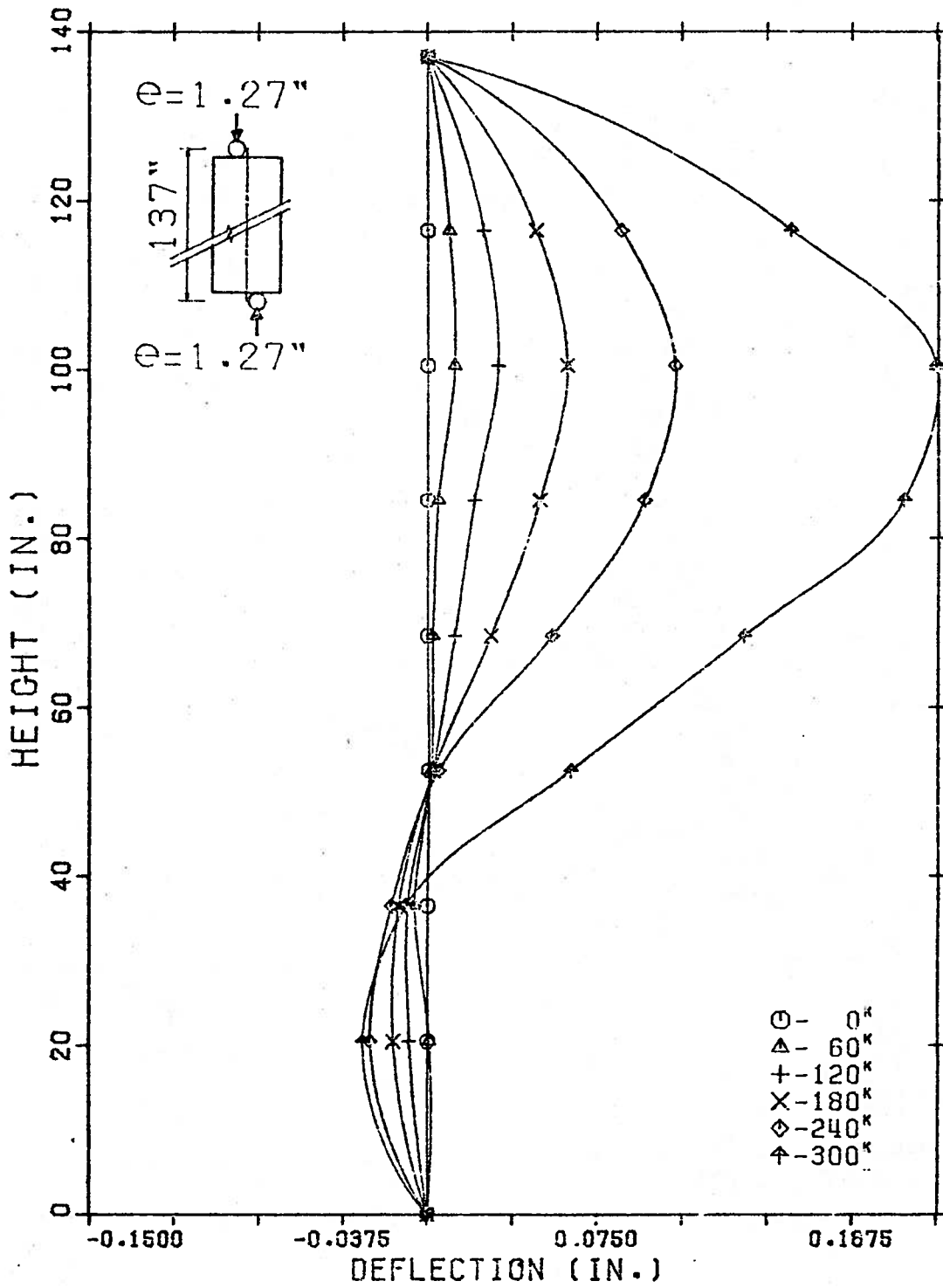

FIG. 2-52 Deflected Shape of Wall J1

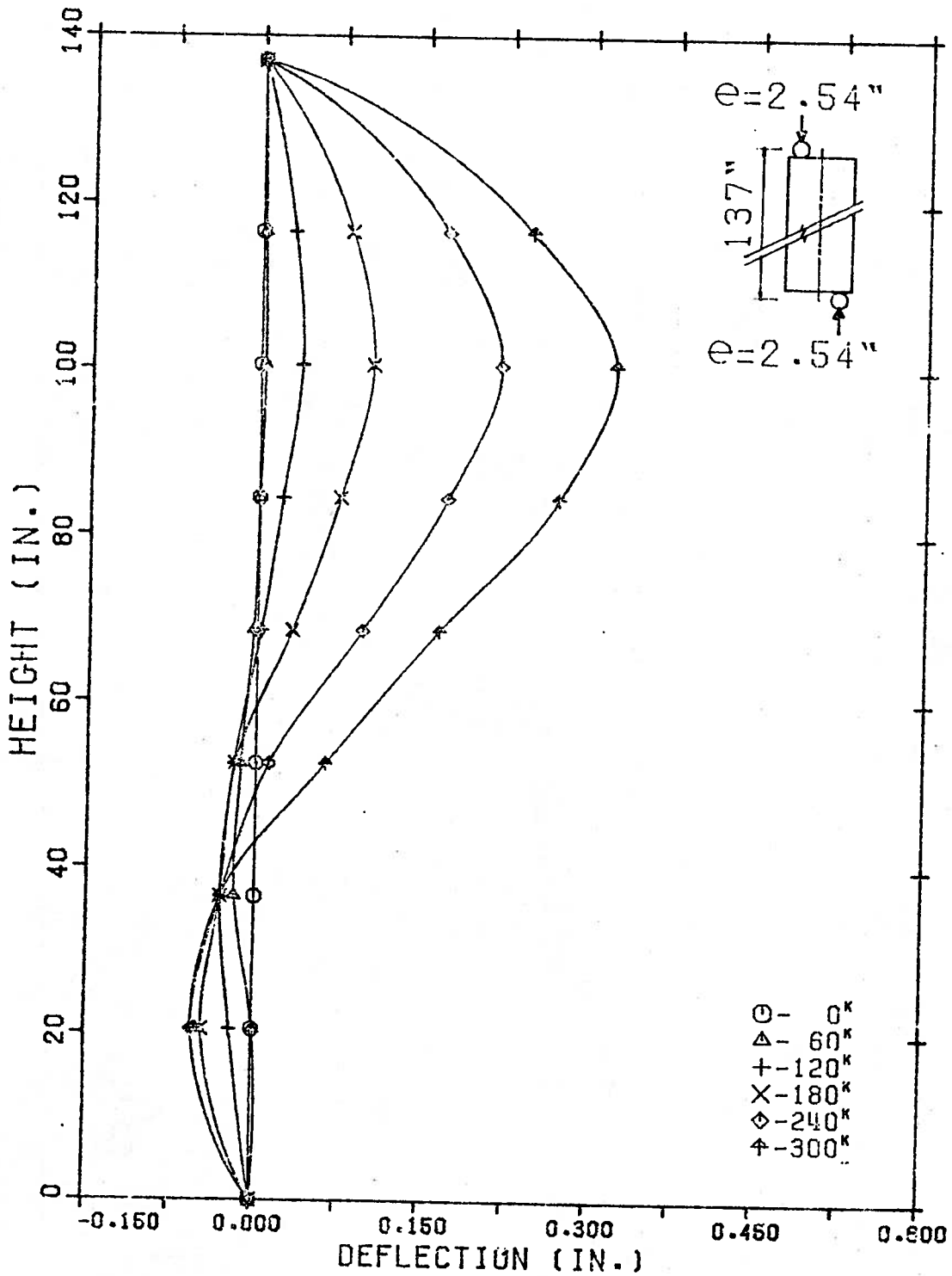

FIG. 2-53 Deflected Shape of Wall J2

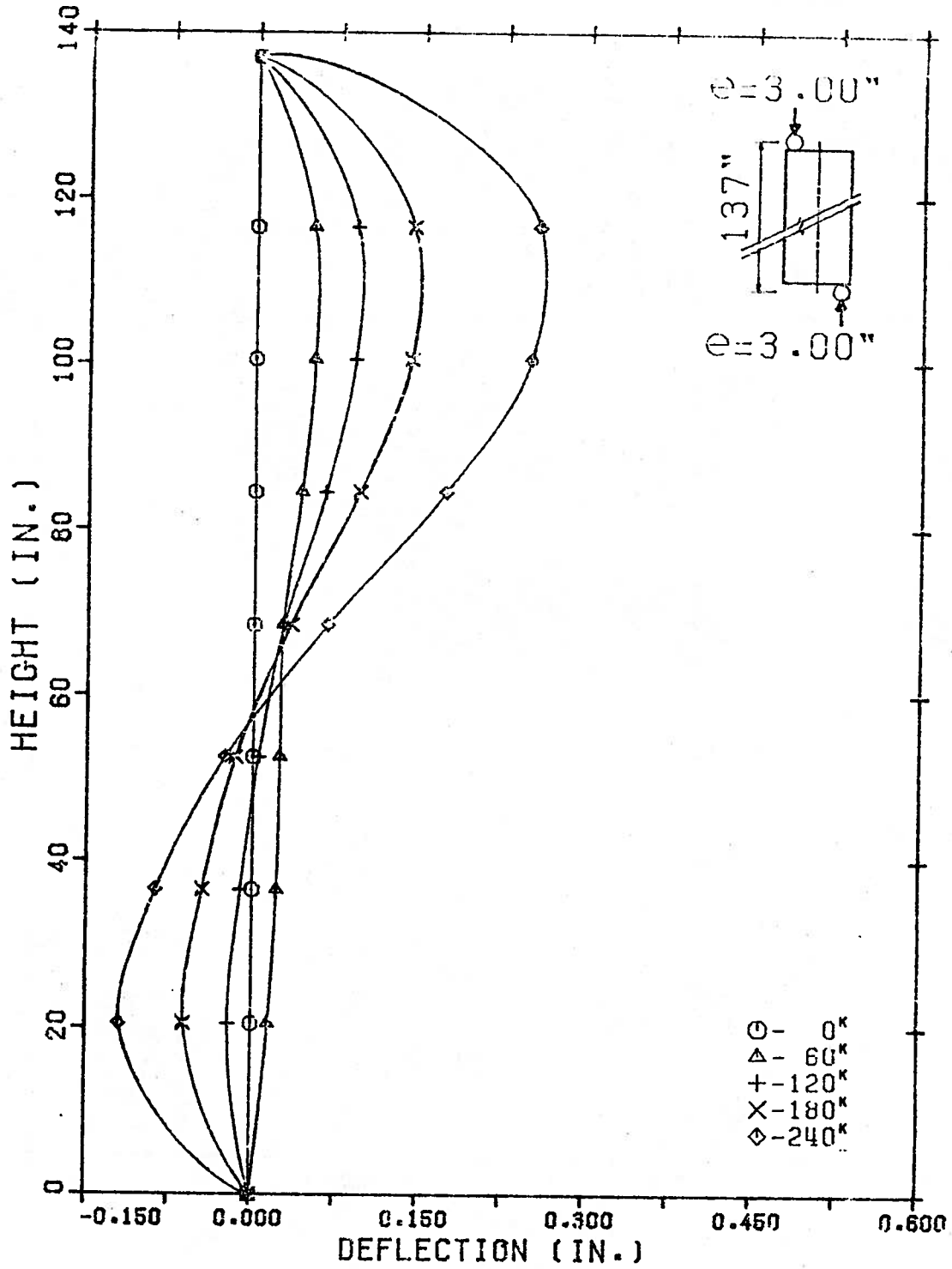

FIG. 2-54 Deflected Shape of Wall J3

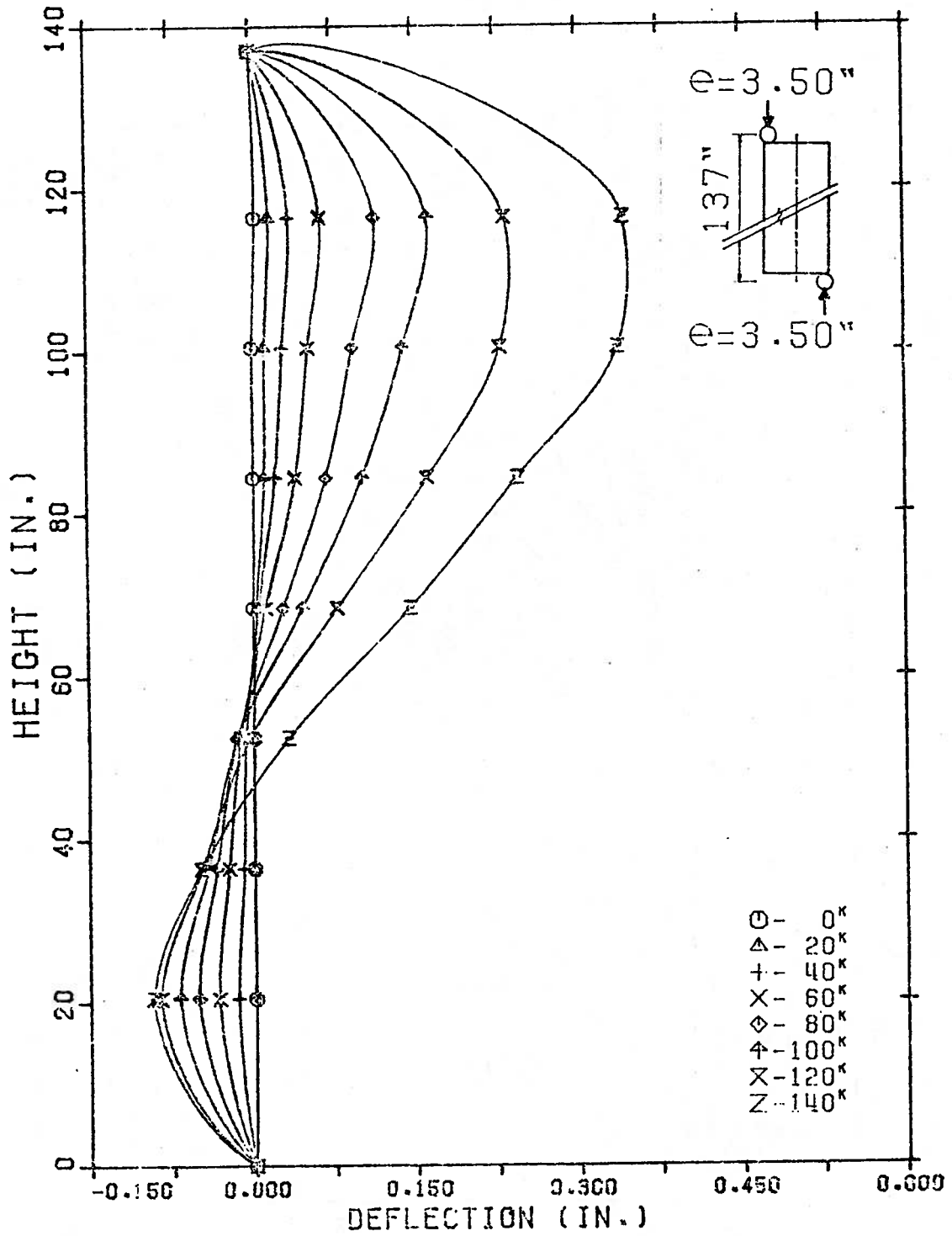

FIG. 2-55 Deflected Shape of Wall J4

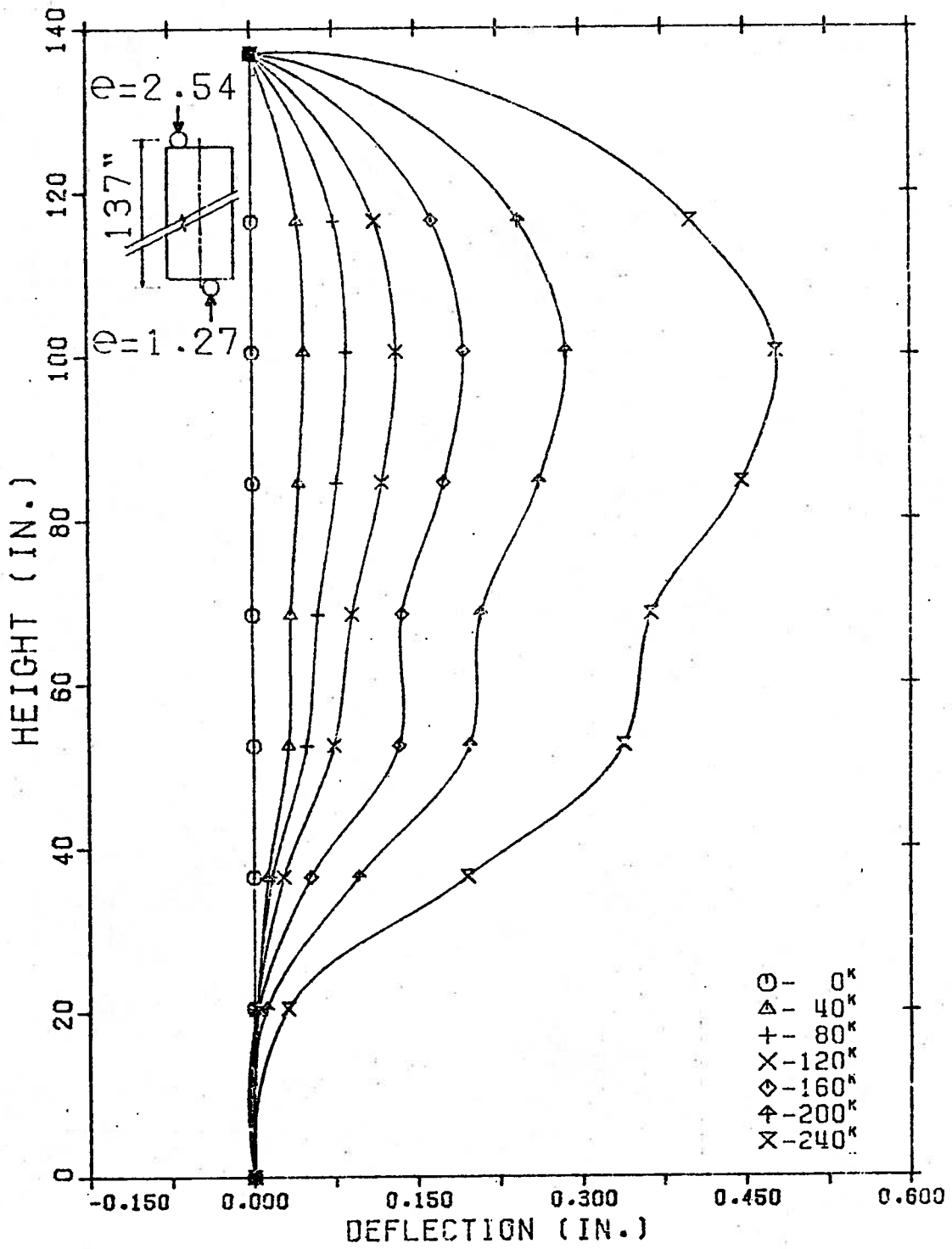

FIG. 2-56 Deflected Shape of Wall K1

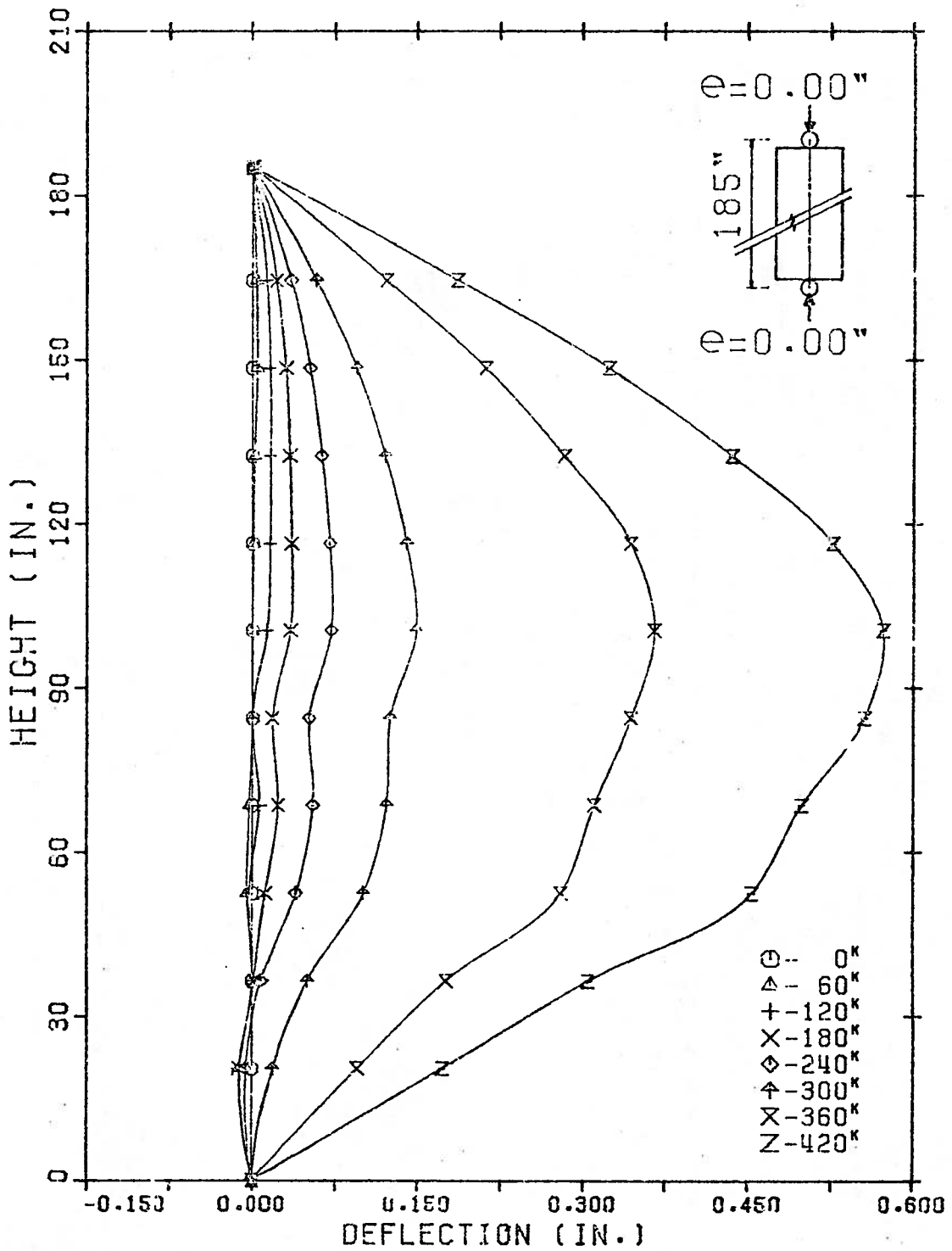

FIG. 2-57 Deflected Shape of Wall I.1

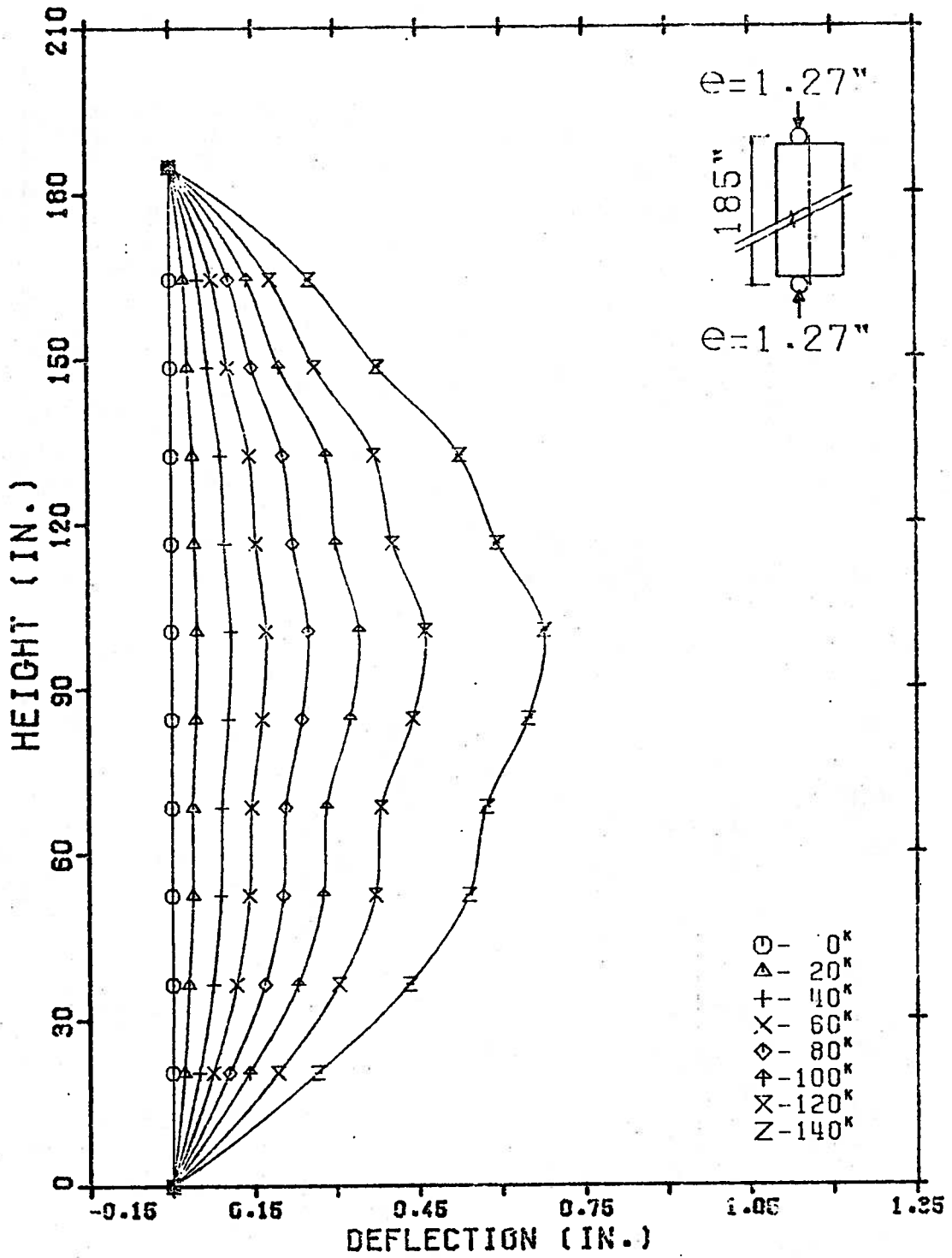

FIG. 2-58 Deflected Shape of Wall L2

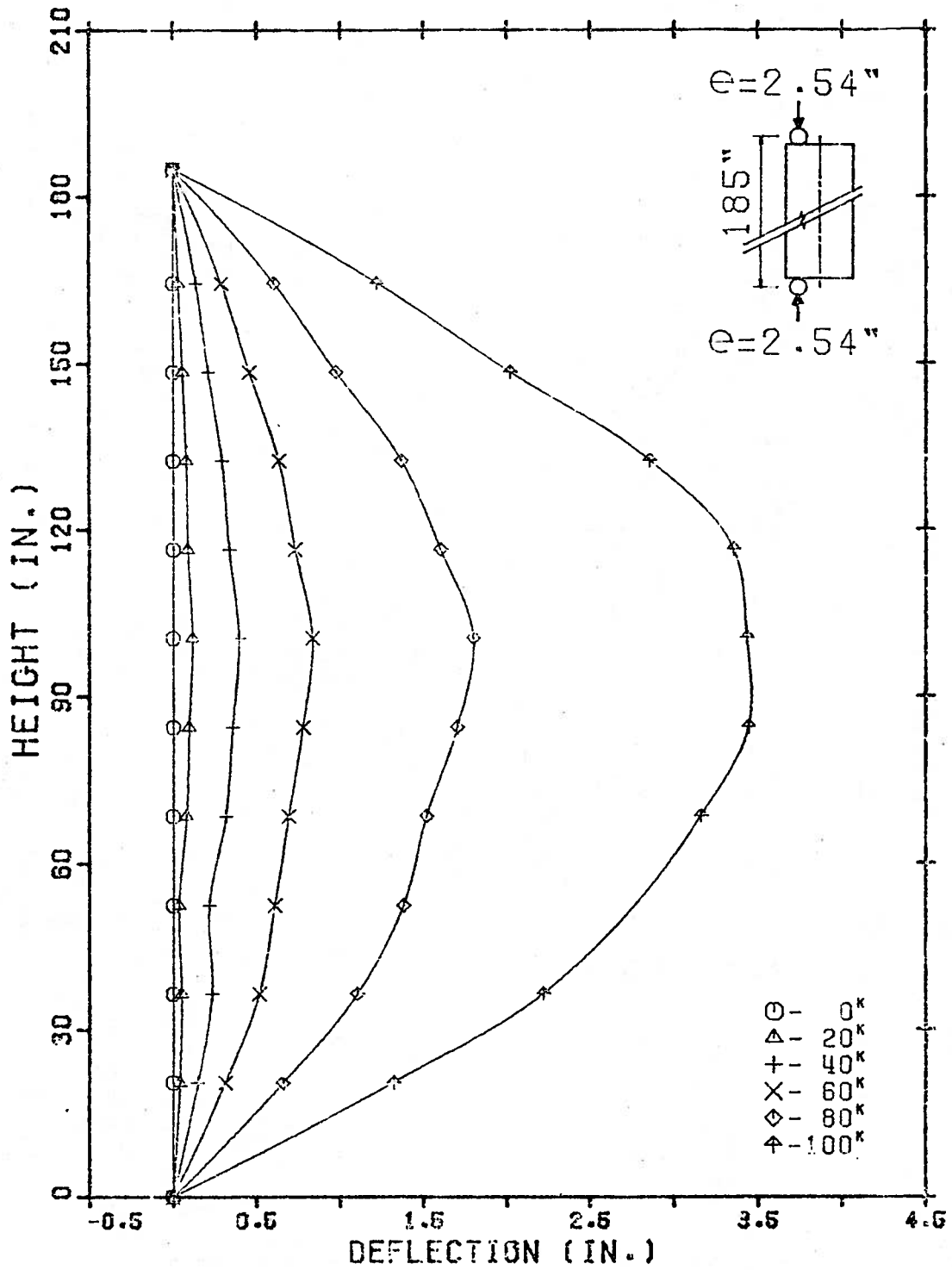

FIG. 2-59 Deflected Shape of Wall L3

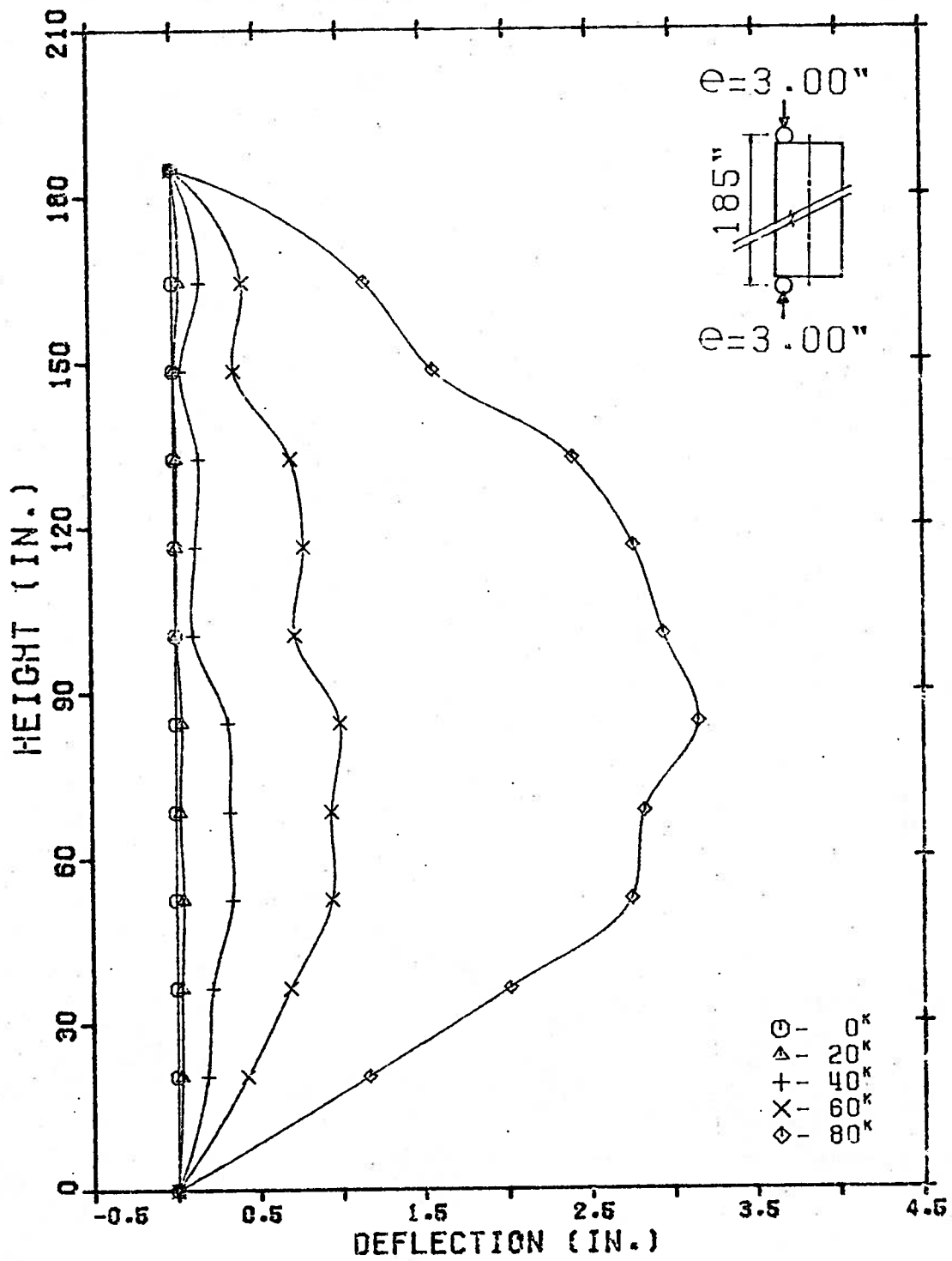

FIG. 2-60 Deflected Shape of Wall L4

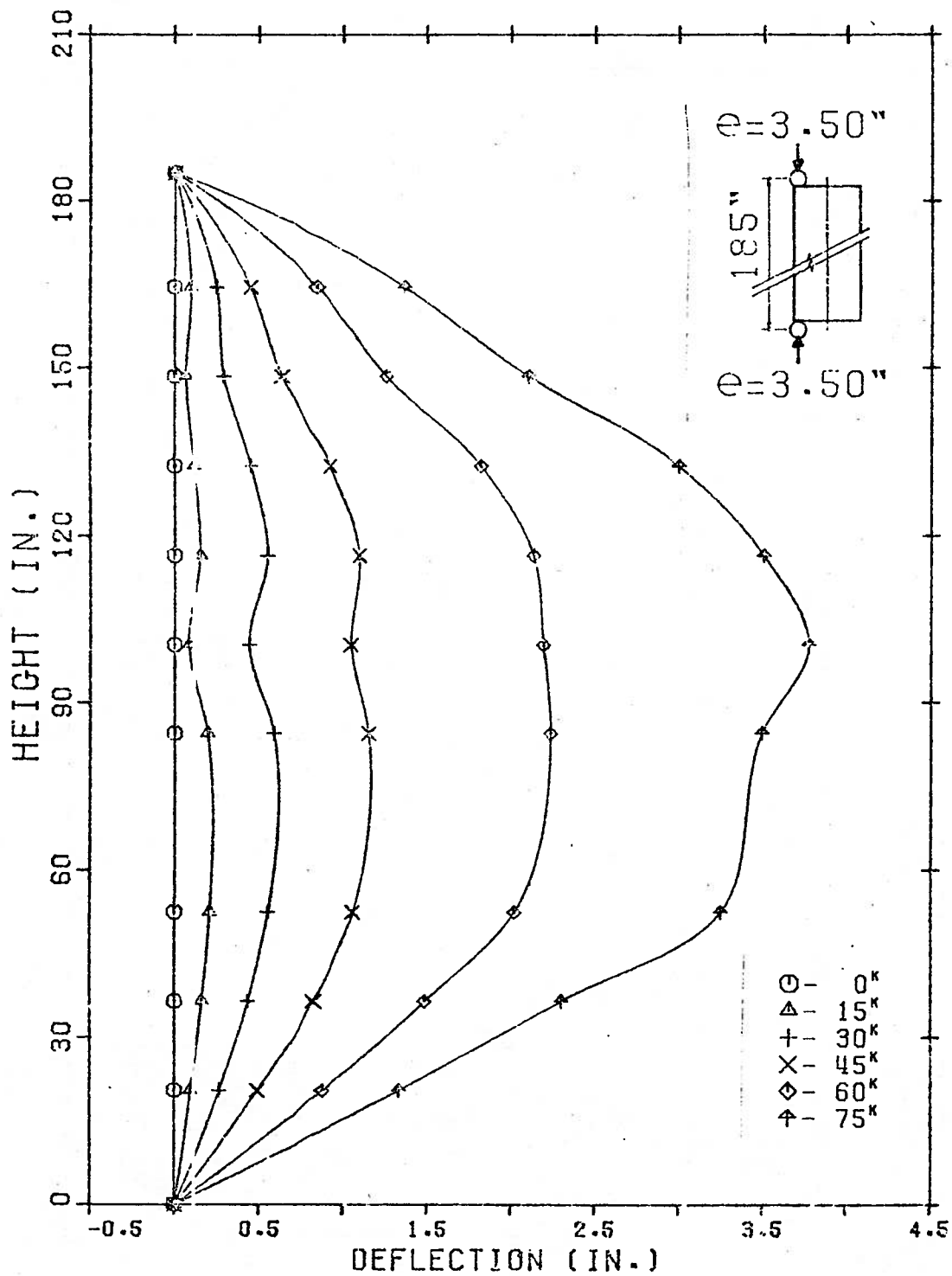

FIG. 2-61 Deflected Shape of Wall L5

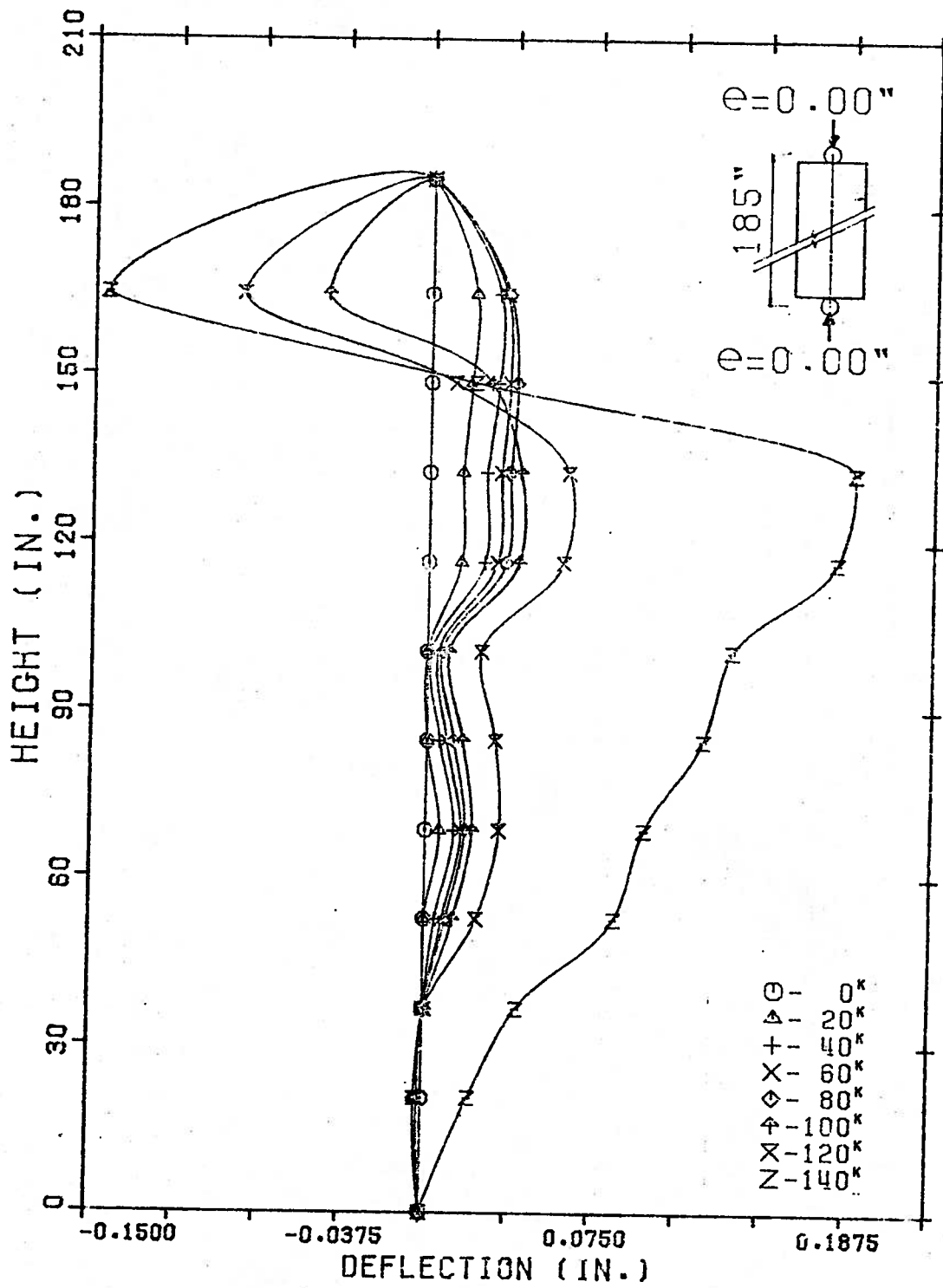

FIG. 2-62 Deflected Shape of Wall M1

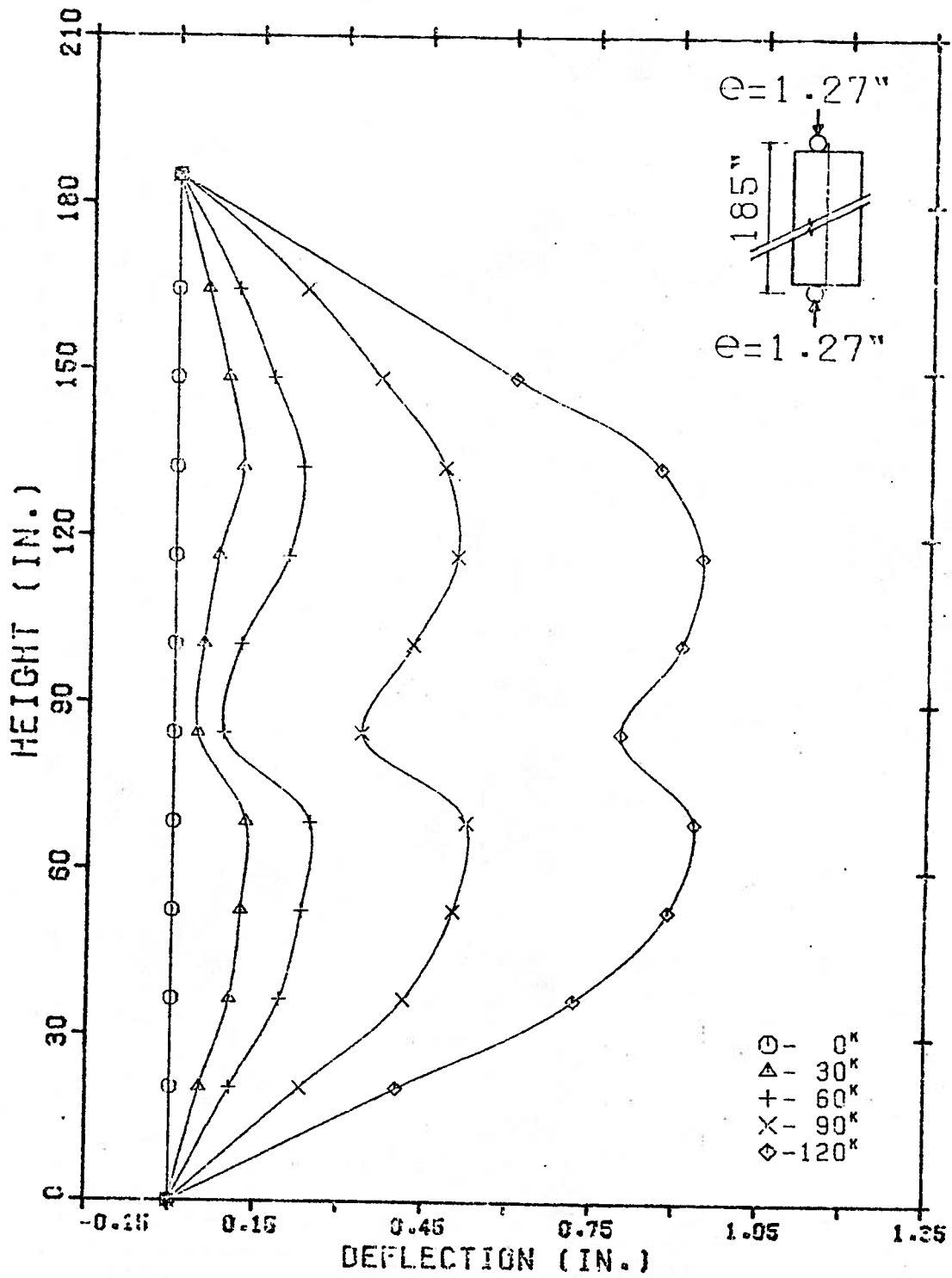

FIG. 2-63 Deflected Shape of Wall M2

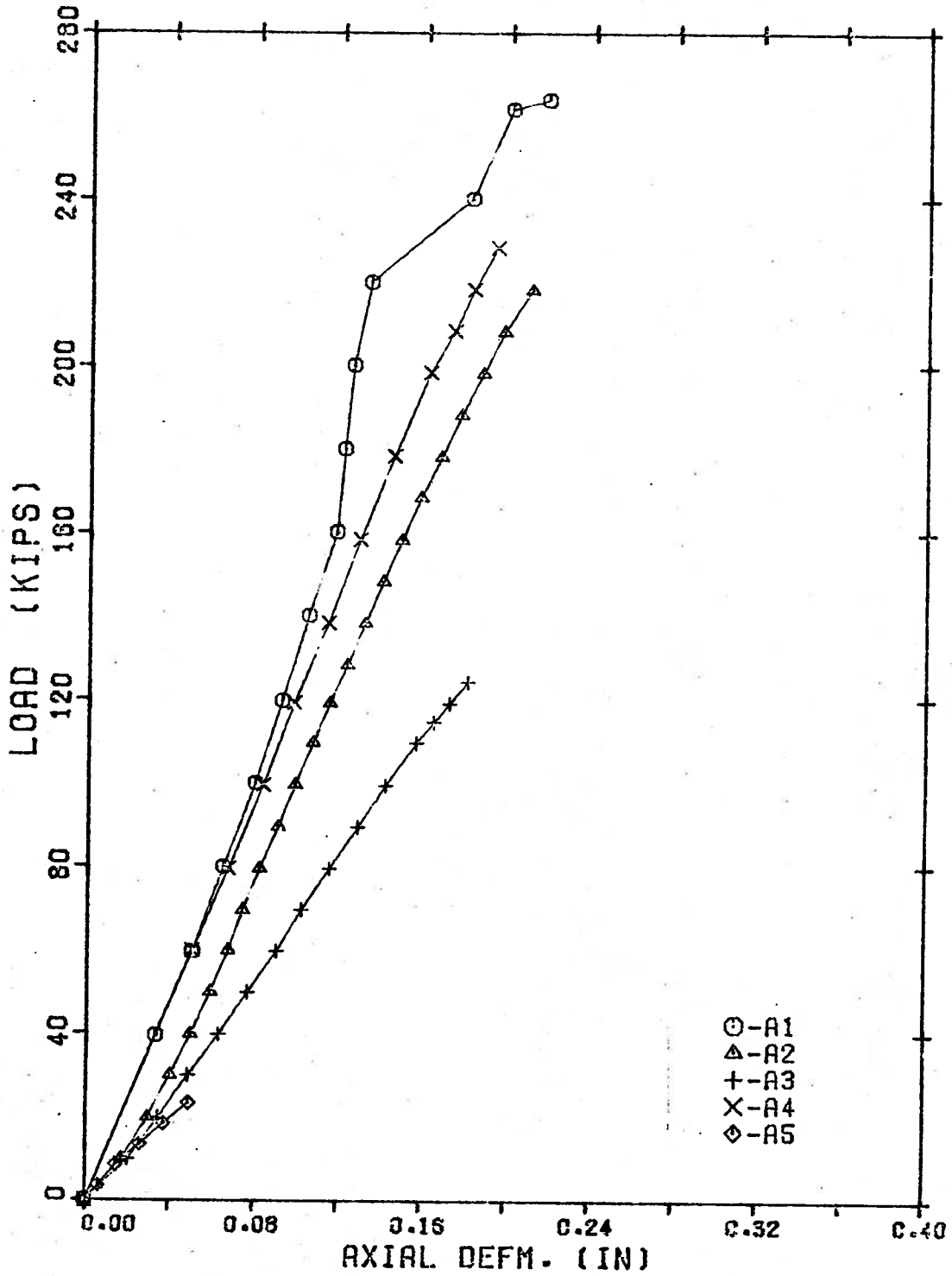

FIG. 2-64 Vertical Deformation of Series A

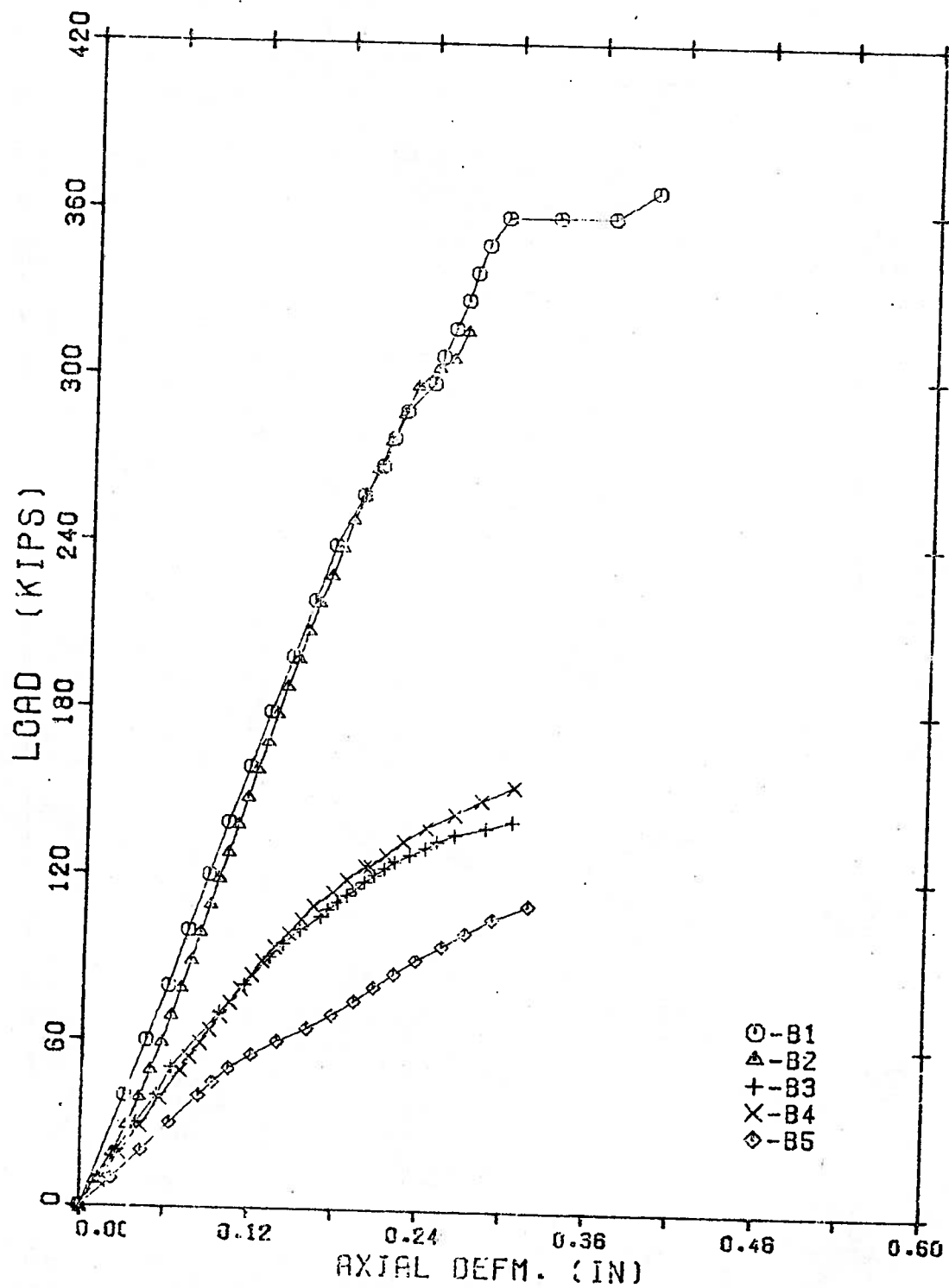

FIG. 2-65 Vertical Deformation of Series B

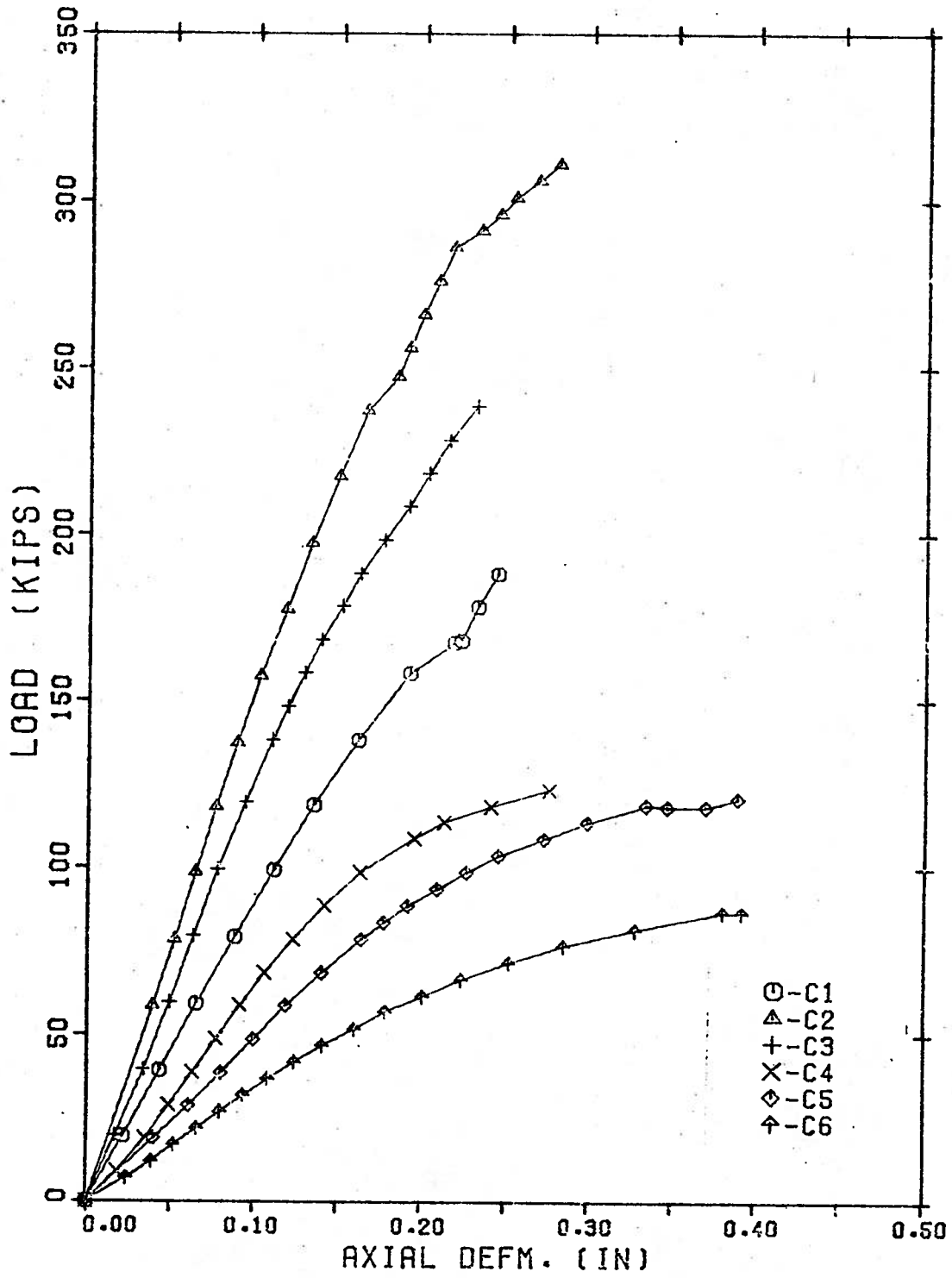

FIG. 2-66 Vertical Deformation of Series C

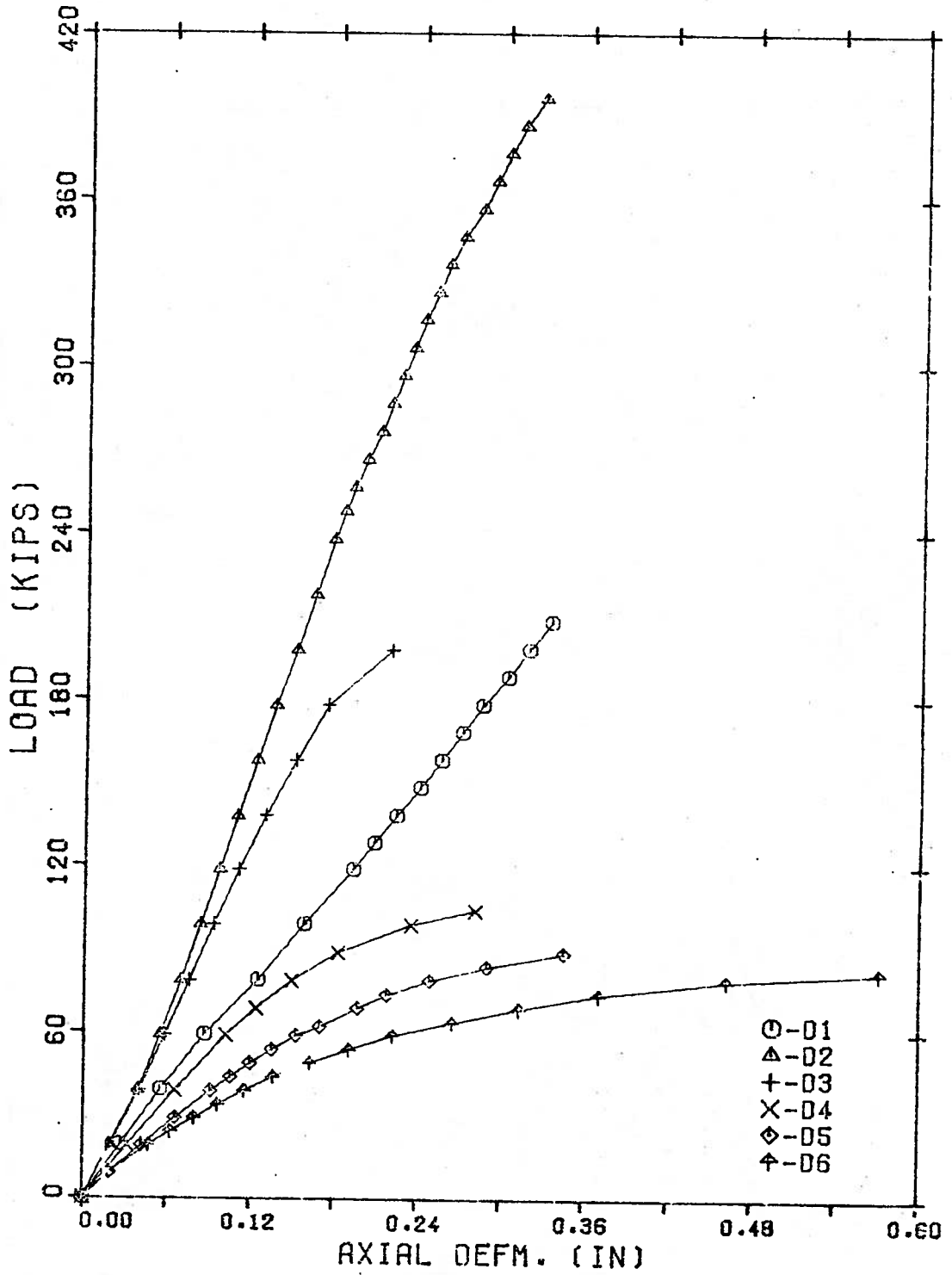

FIG. 2-67 Vertical Deformation of Series D

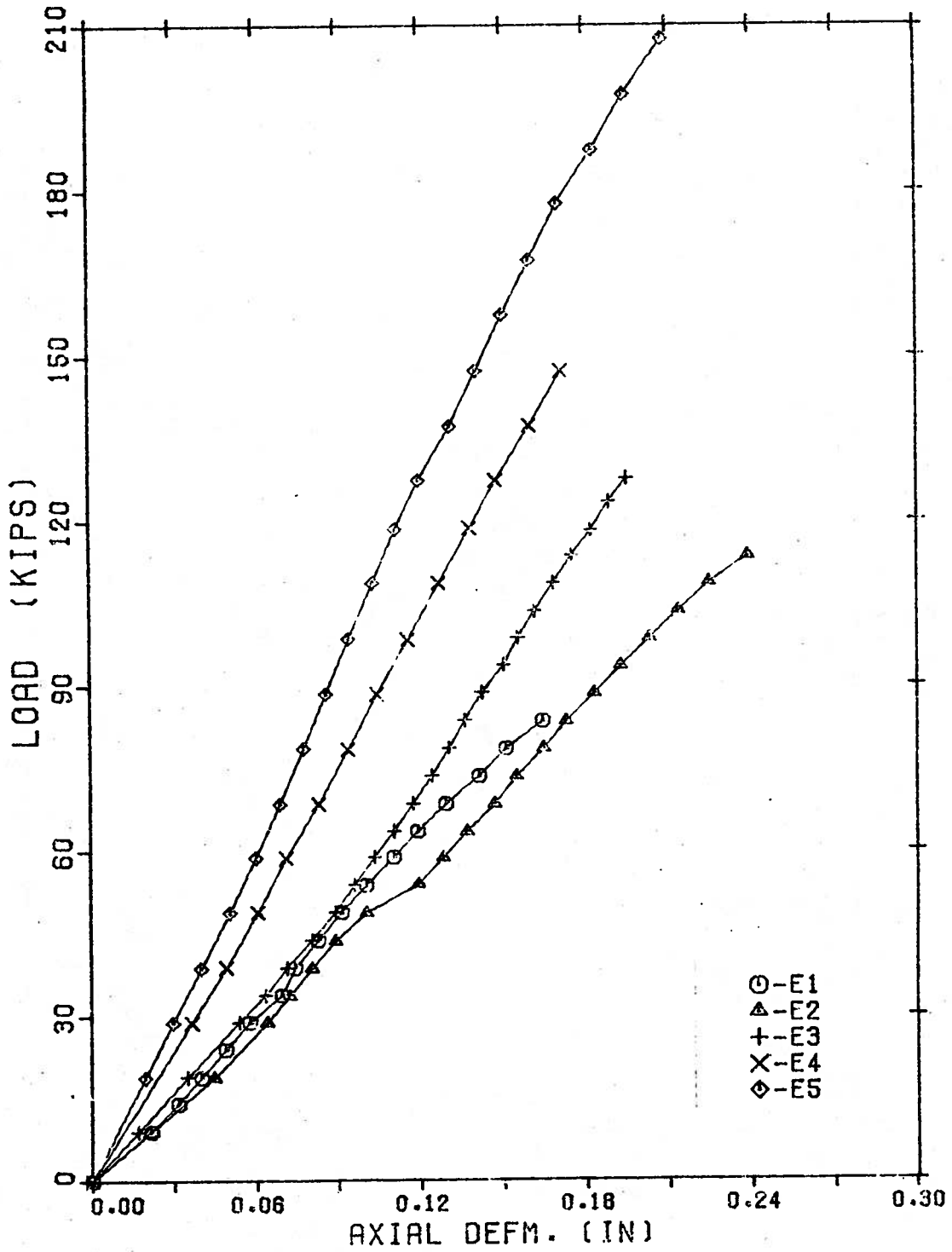

FIG. 2-68 Vertical Deformation of Series E

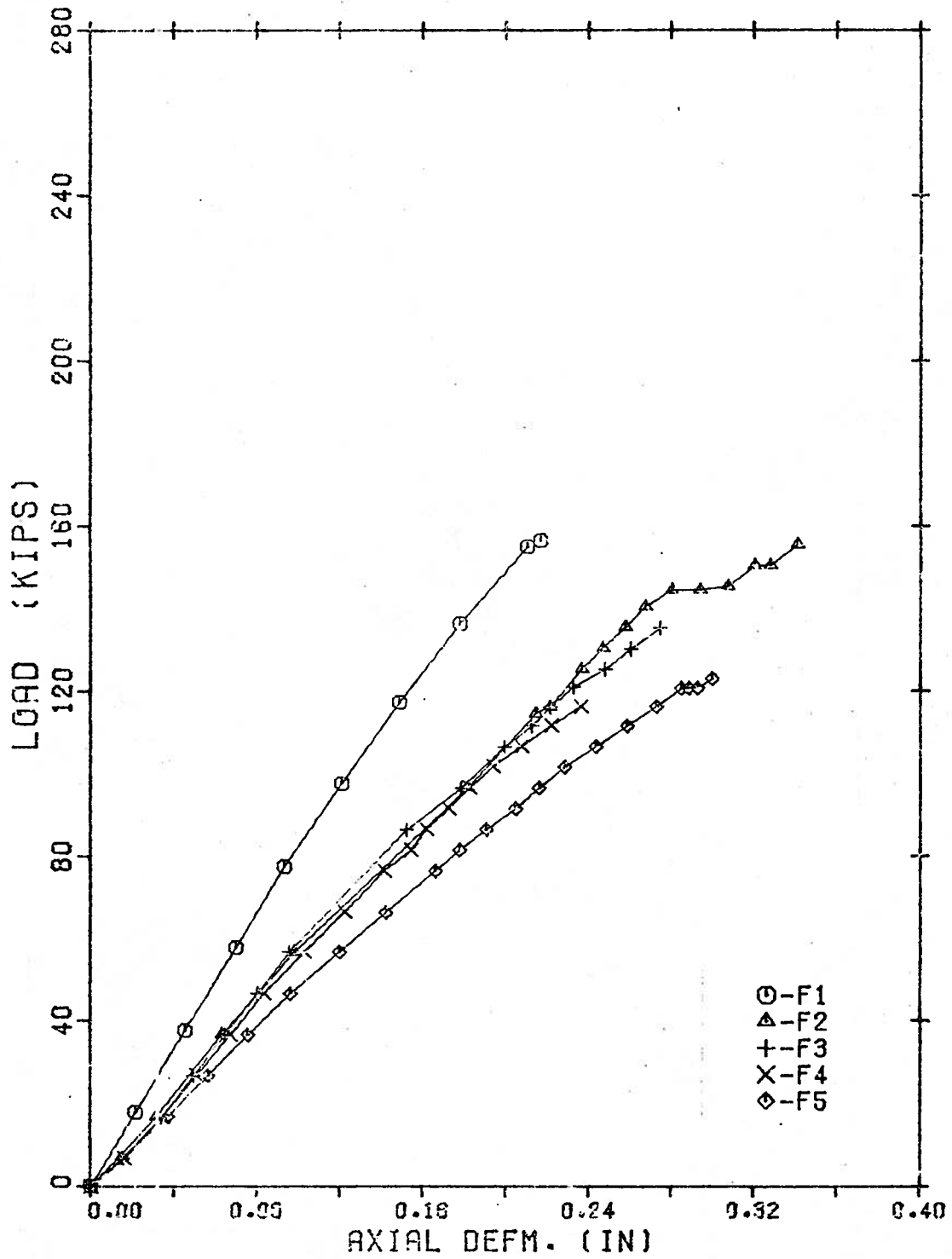

FIG. 2-69 Vertical Deformation of Series F

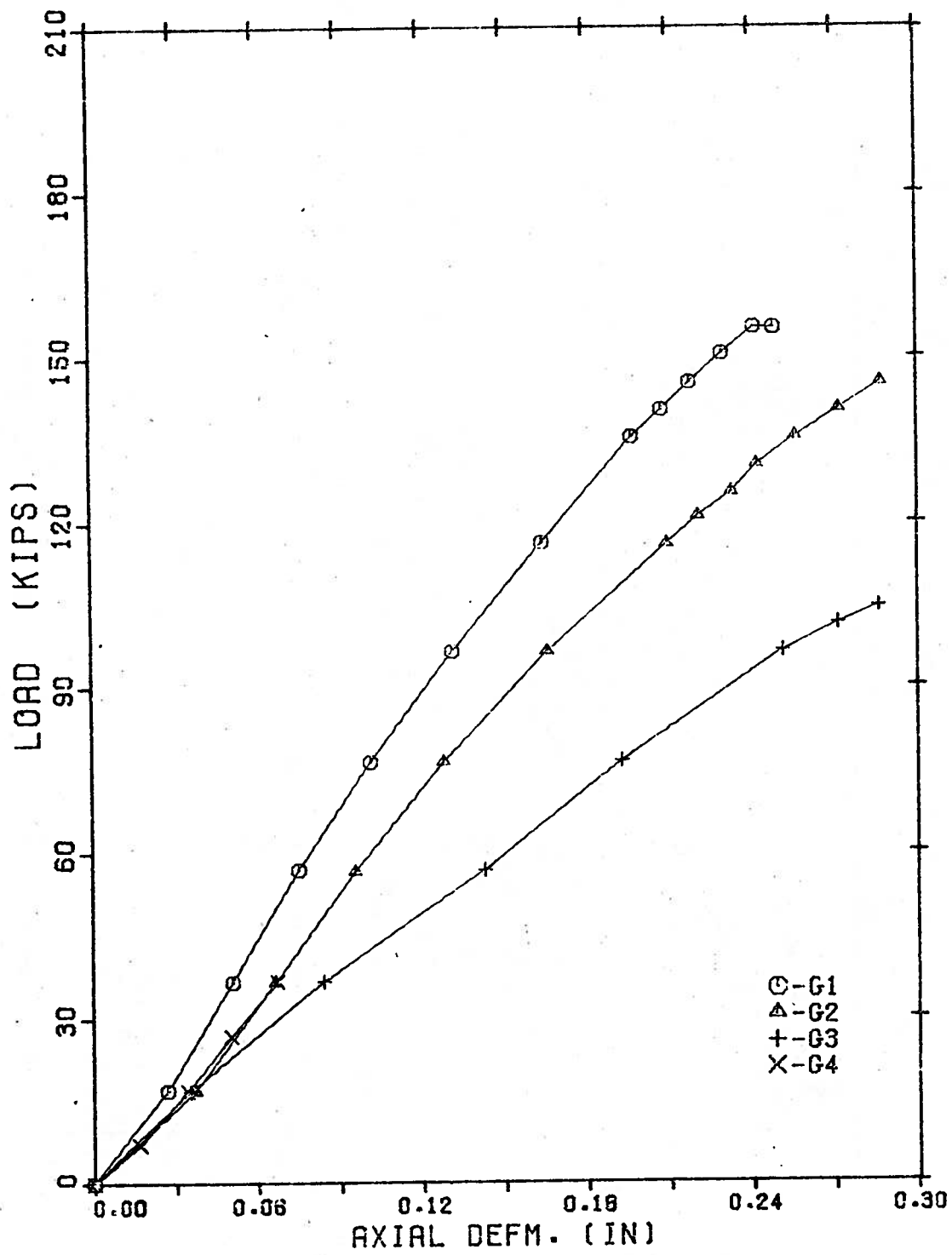

FIG. 2-70 Vertical Deformation of Series GA

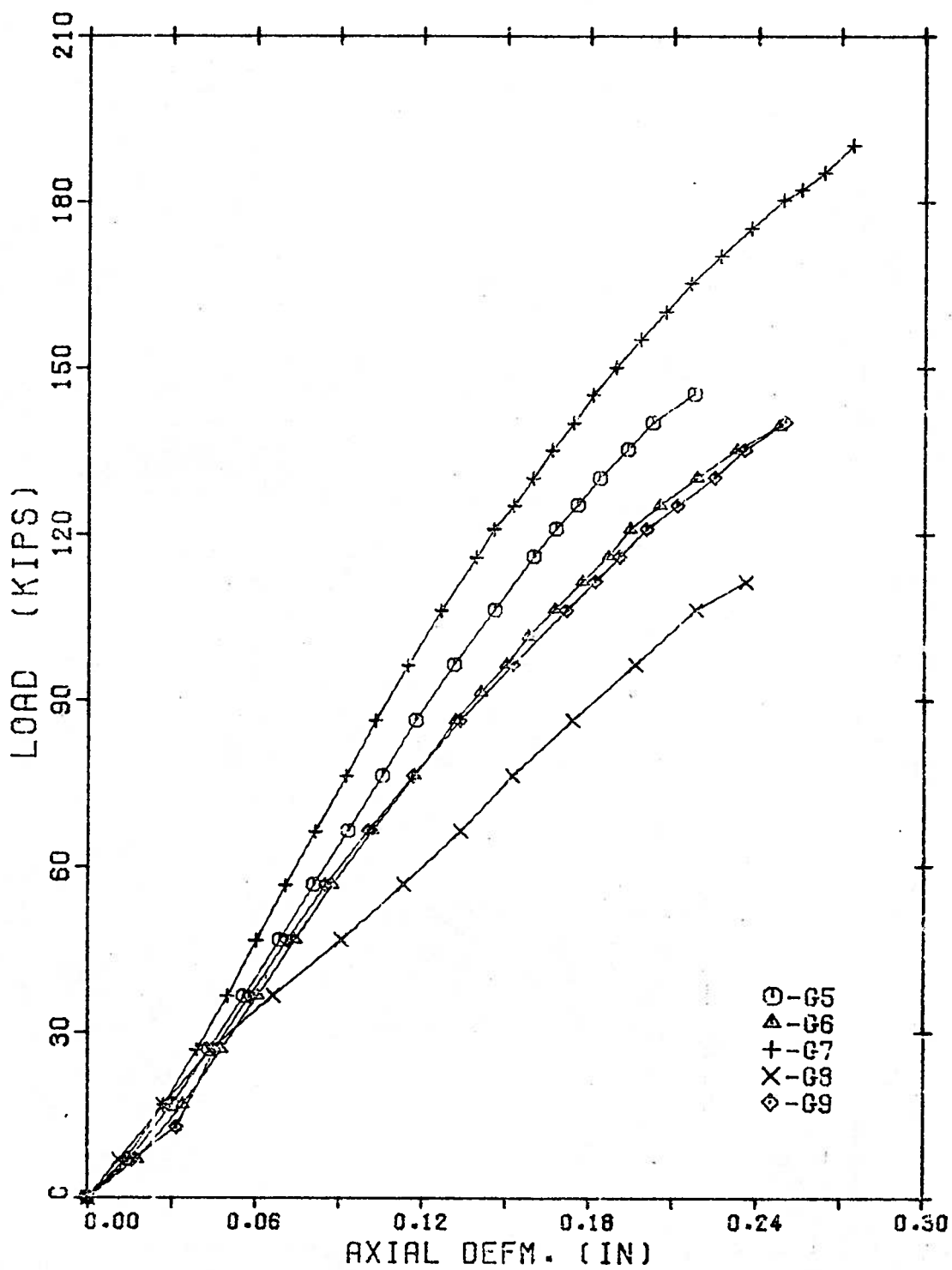

FIG. 2-71 Vertical Deformation of Series GB

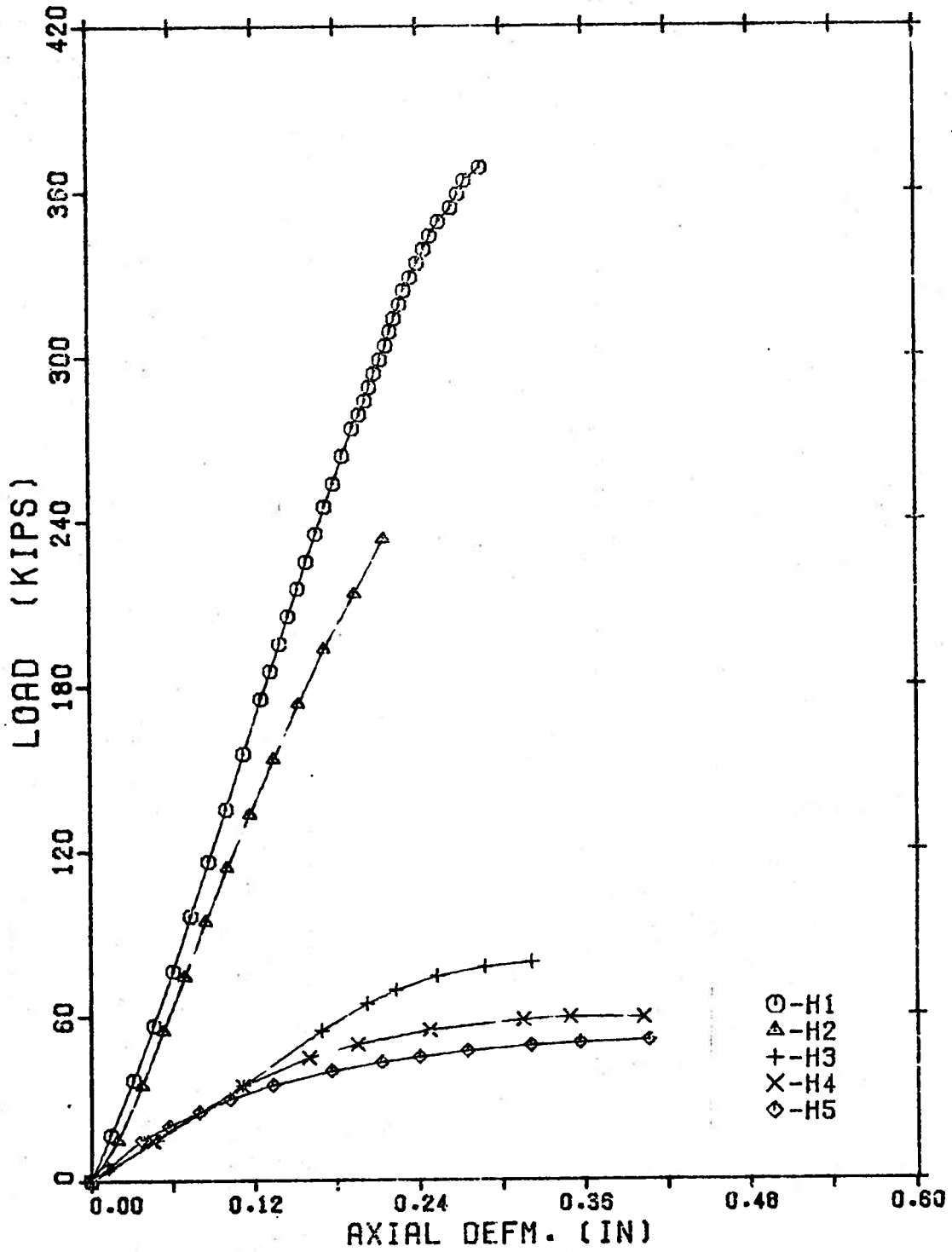

FIG. 2-72 Vertical Deformation of Series H

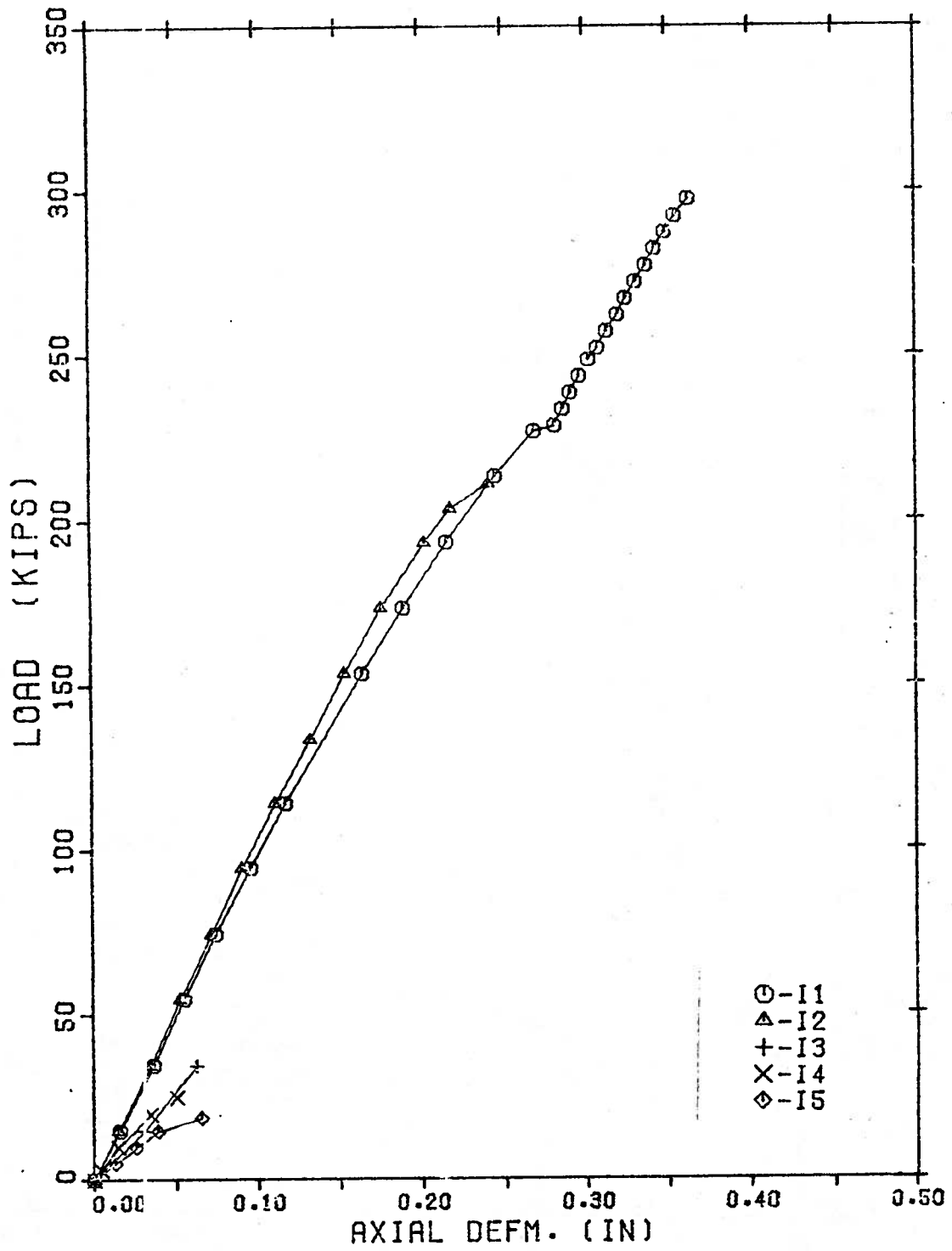

FIG. 2-73 Vertical Deformation of Series I

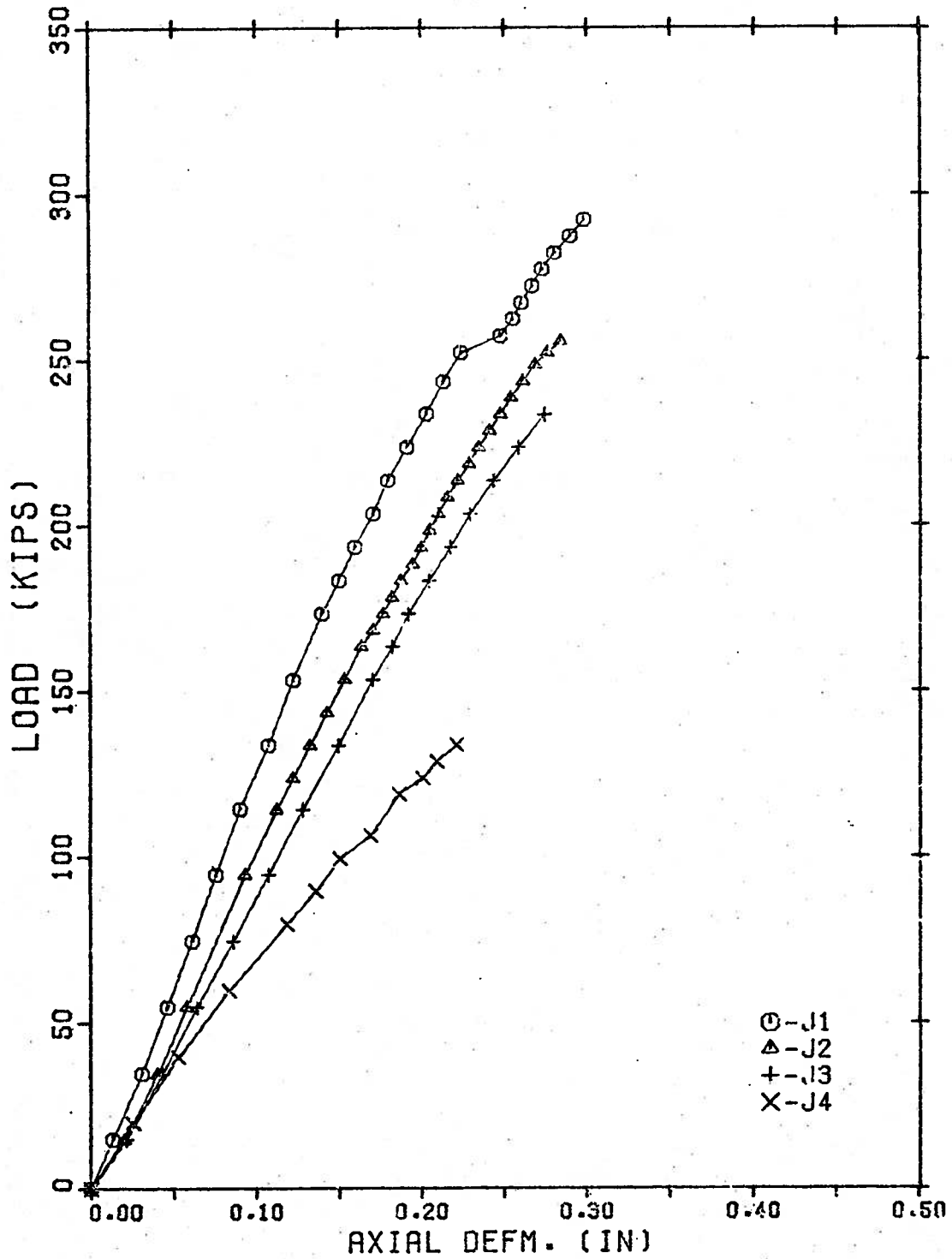

FIG. 2-74 Vertical Deformation of Series J

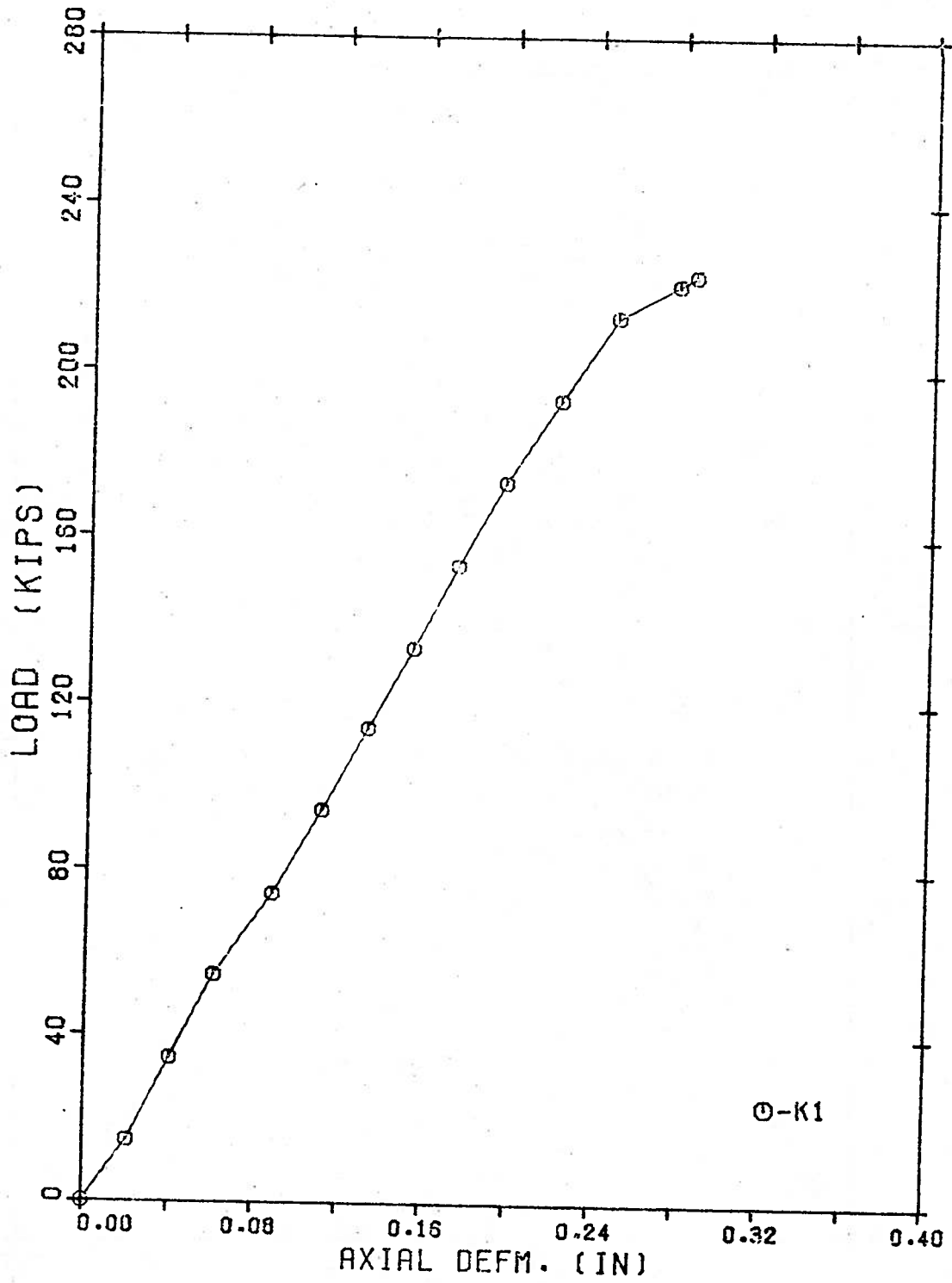

FIG. 2-75 Vertical Deformation of Series K

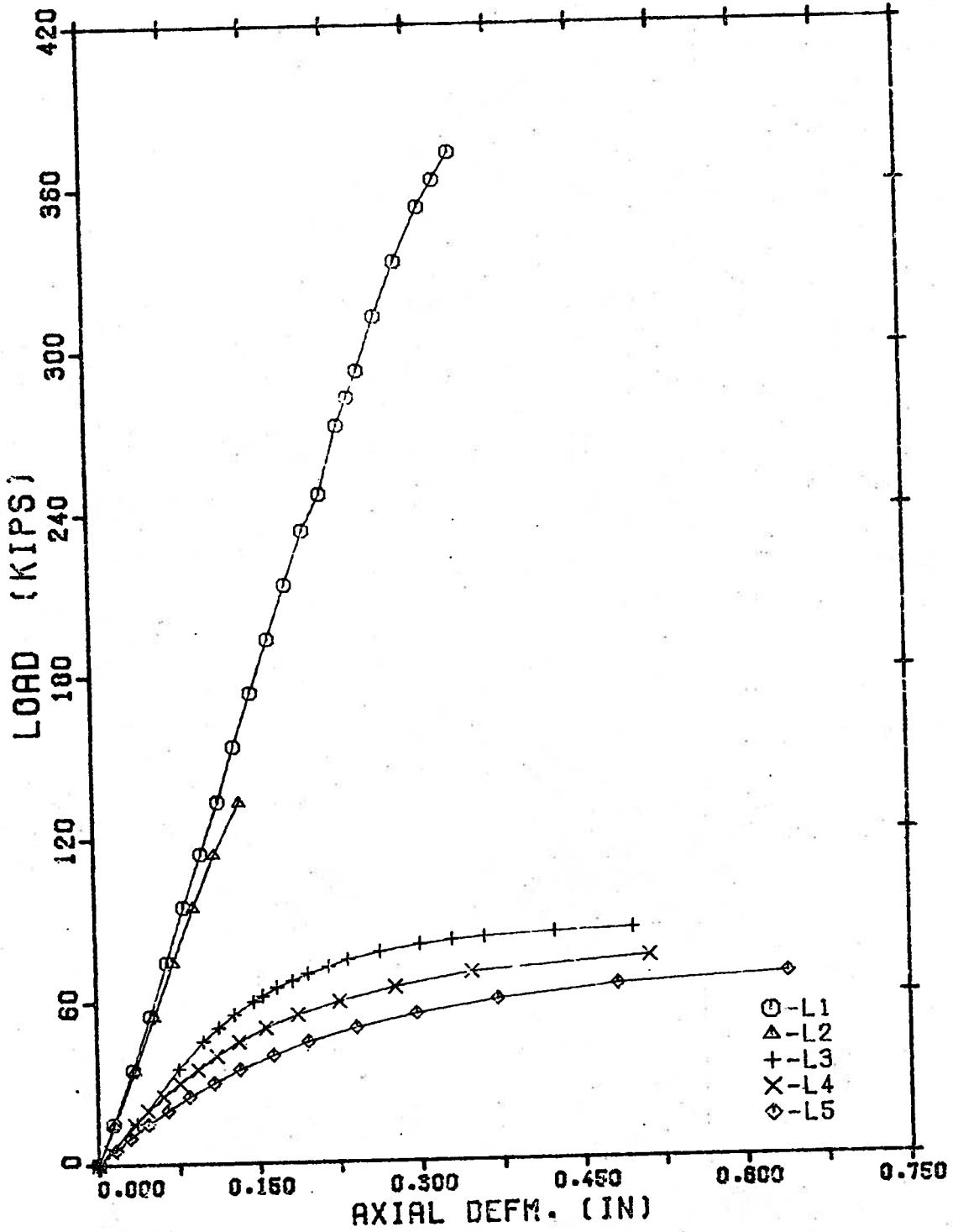

FIG. 2-76 Vertical Deformation of Series L

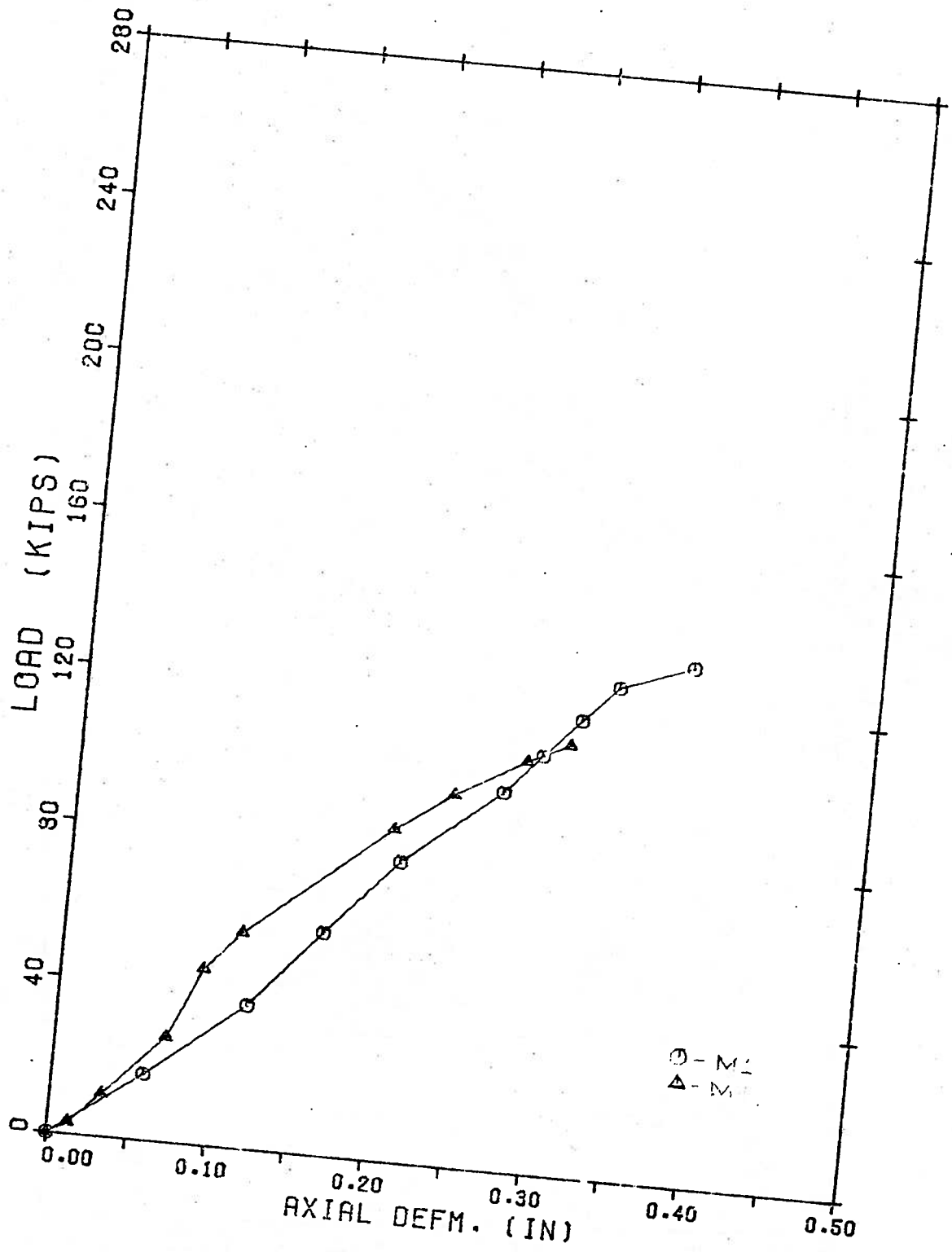

FIG. 2-77 Vertical Deformation of Series M

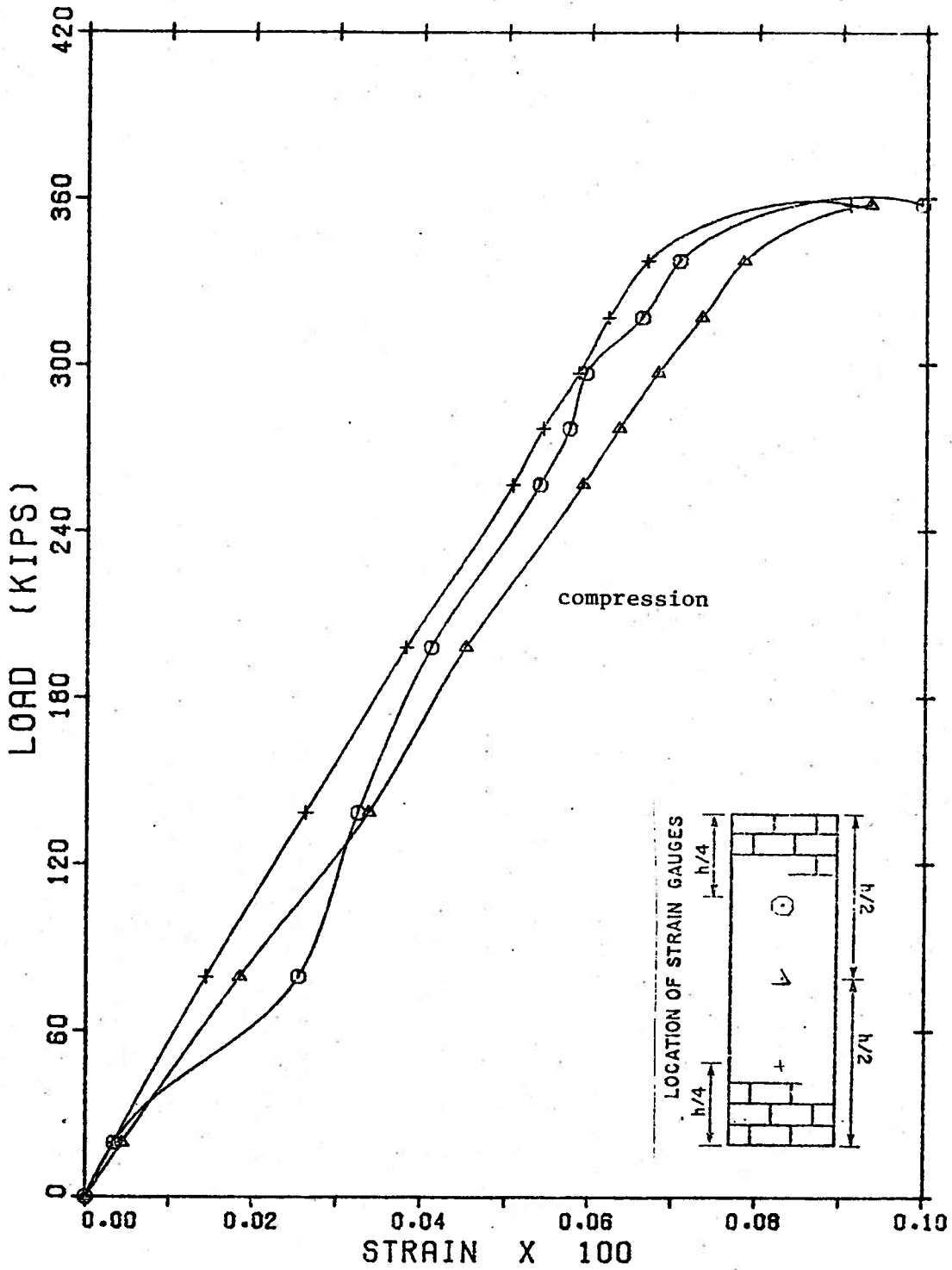

FIG. 2.78 Reinforcement Strain for Wall B1

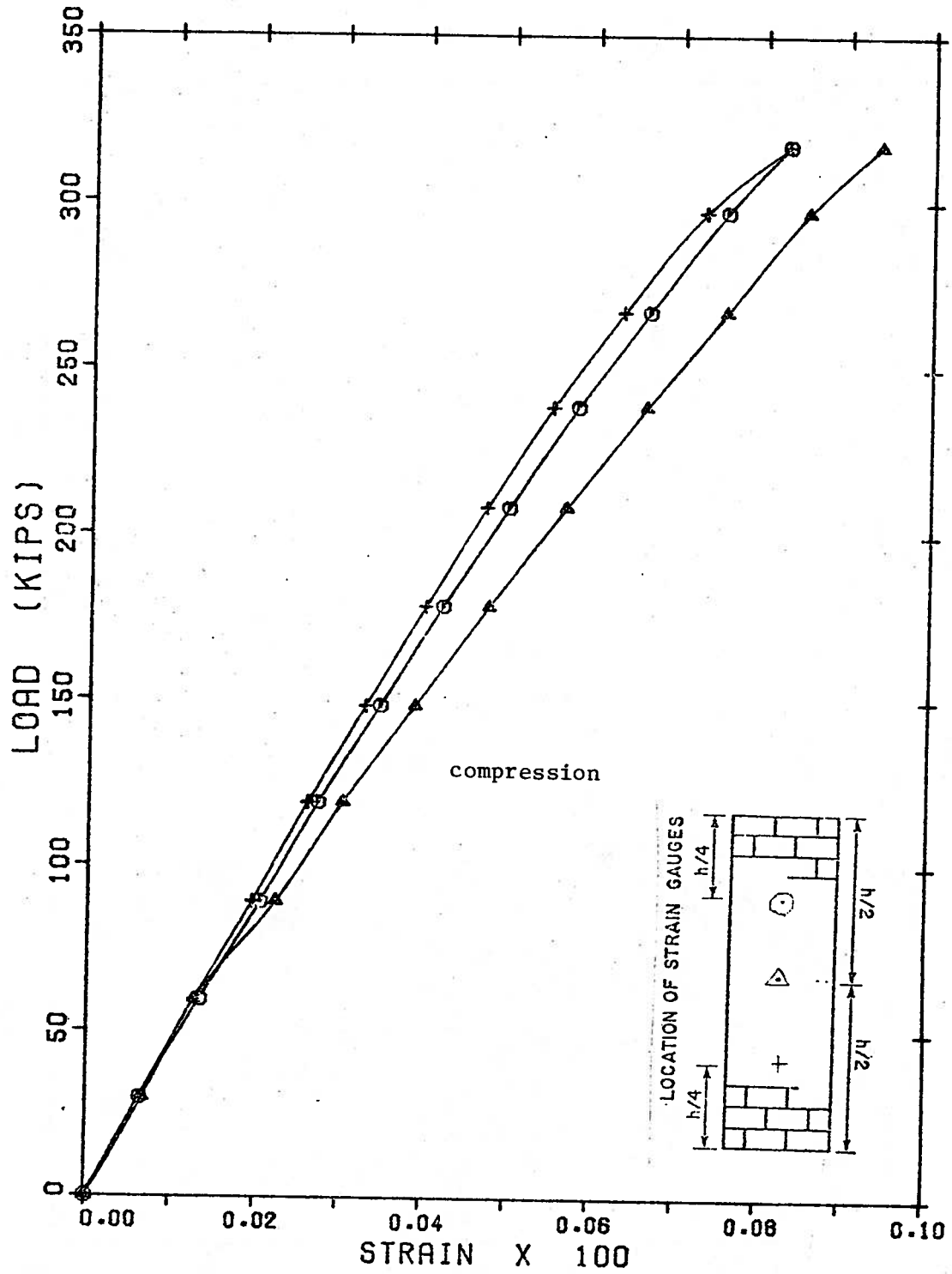

FIG. 2.79 Reinforcement Strain for Wall B2

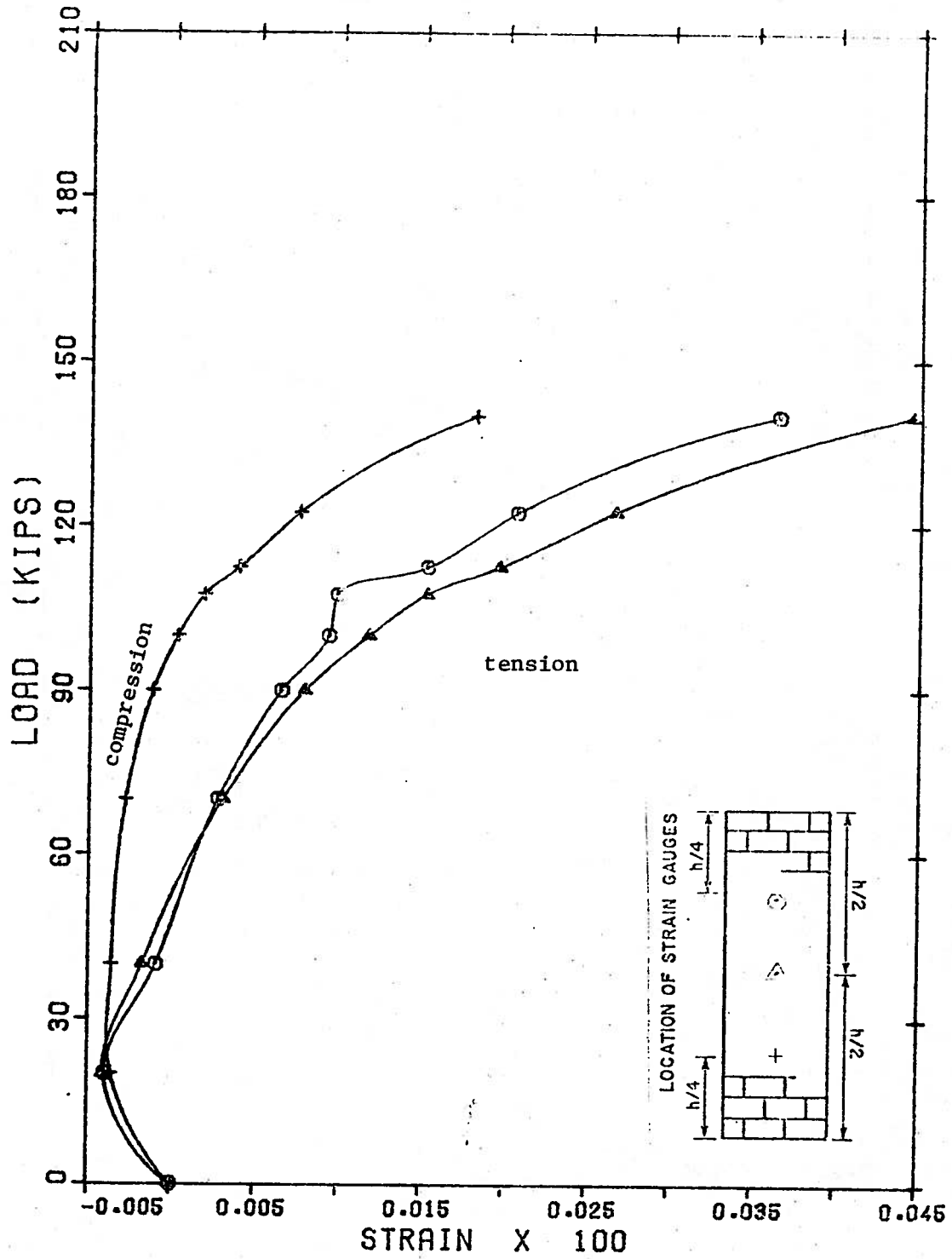

FIG. 2.80 Reinforcement Strain for Wall B3

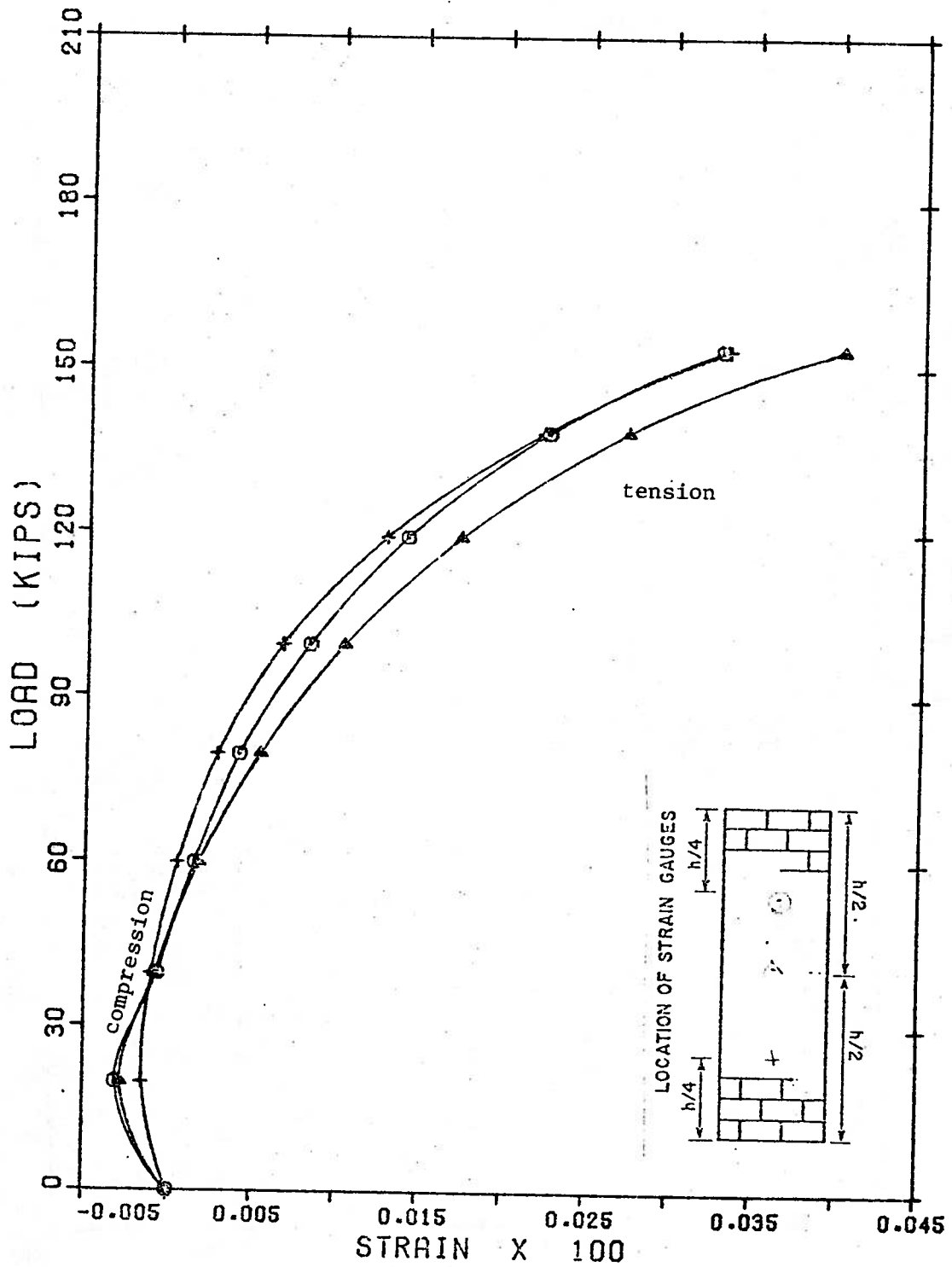

FIG. 2.81 Reinforcement Strain for Wall B4

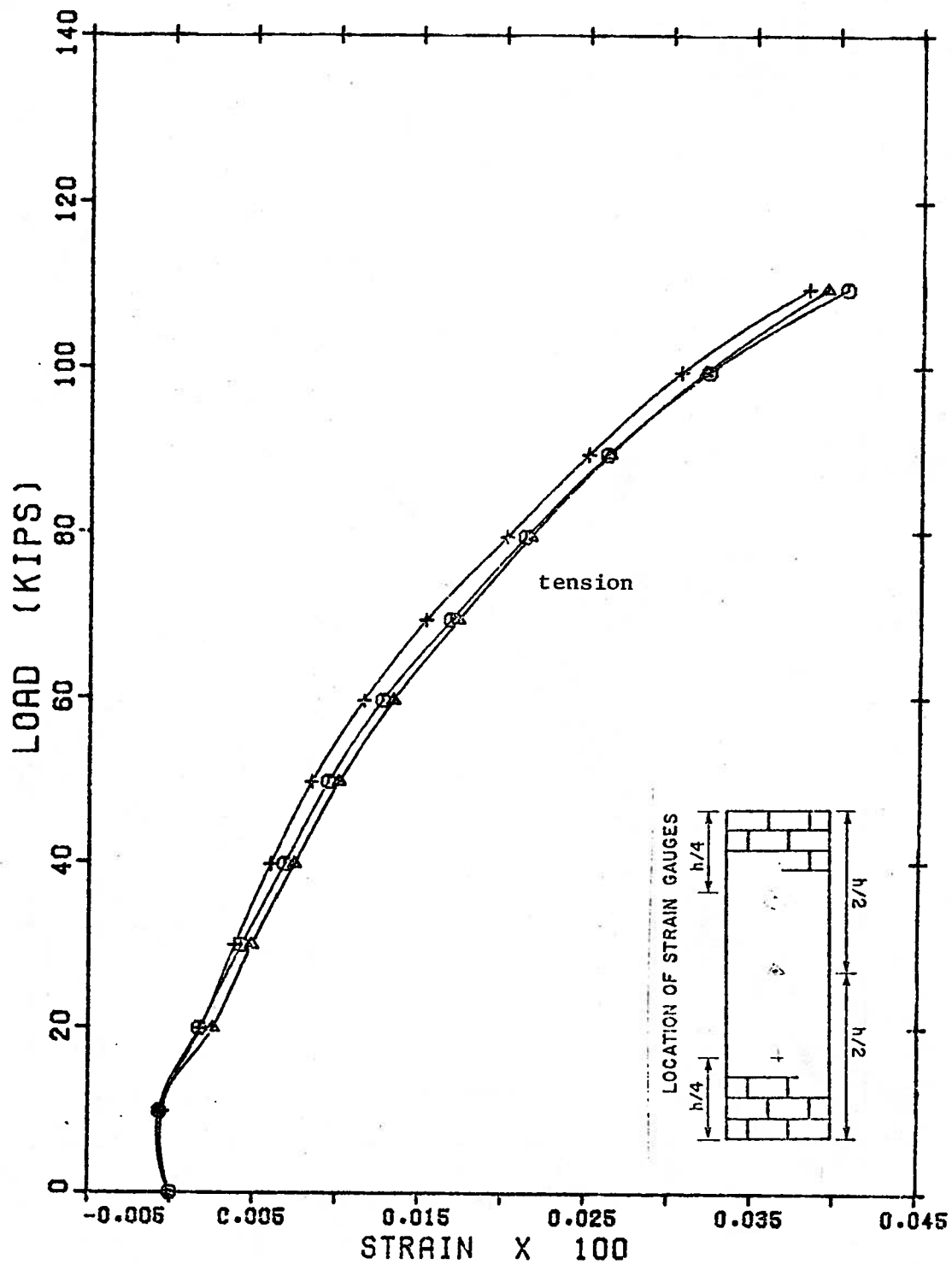

FIG. 2.82 Reinforcement Strain for Wall B5

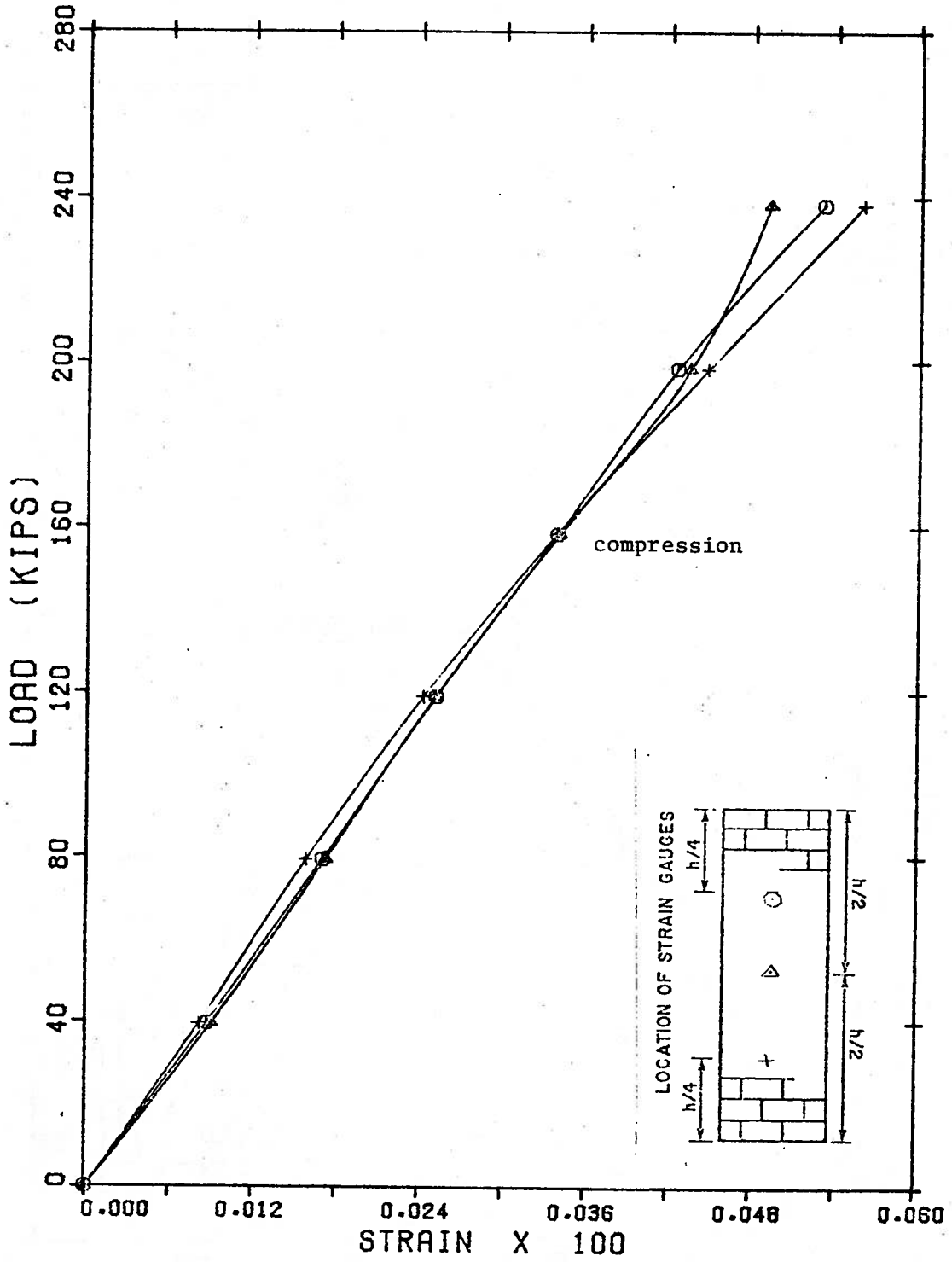

FIG. 2.83 Reinforcement Strain for Wall C2

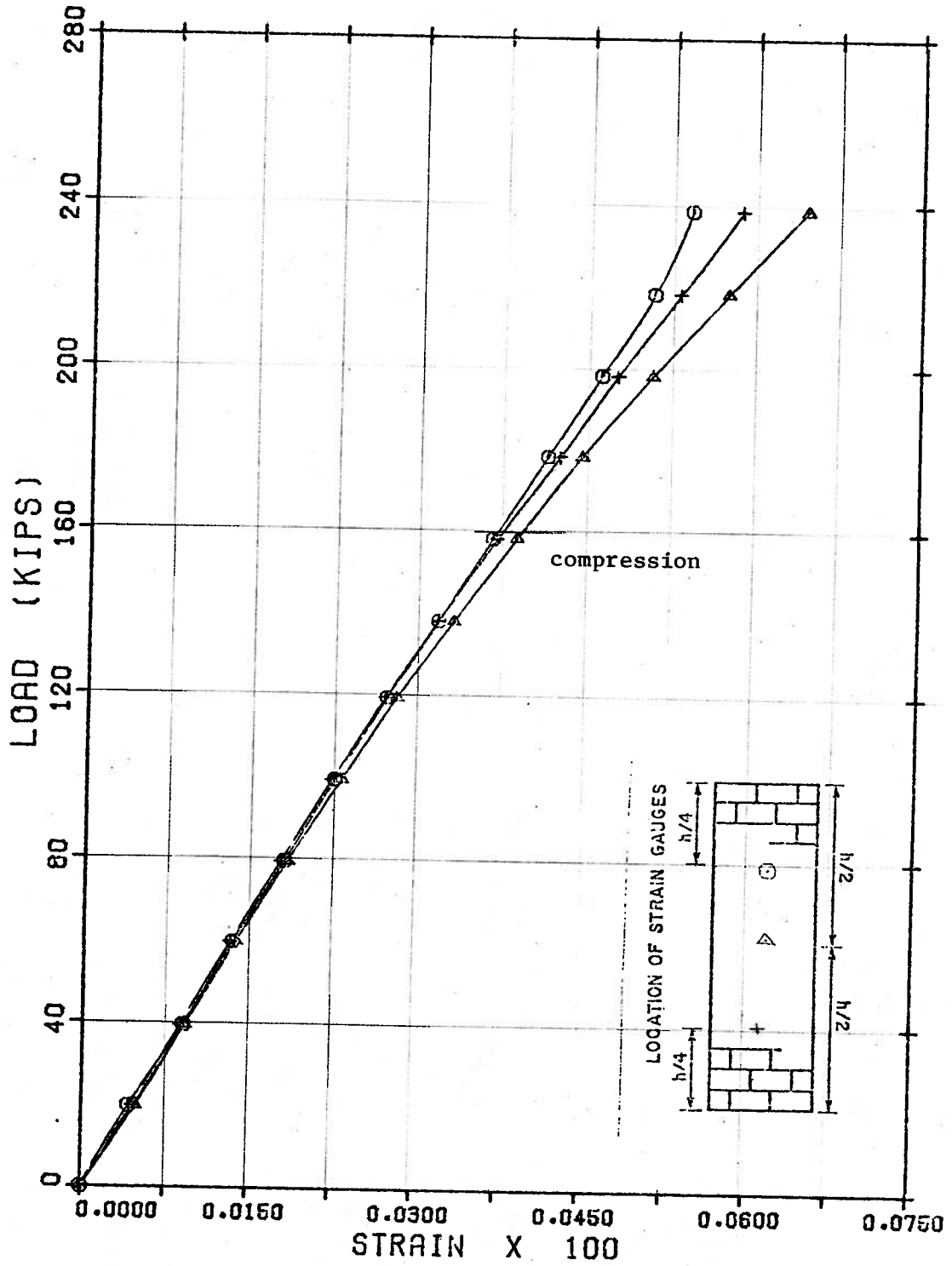

FIG. 2.84 Reinforcement Strain for Wall C3

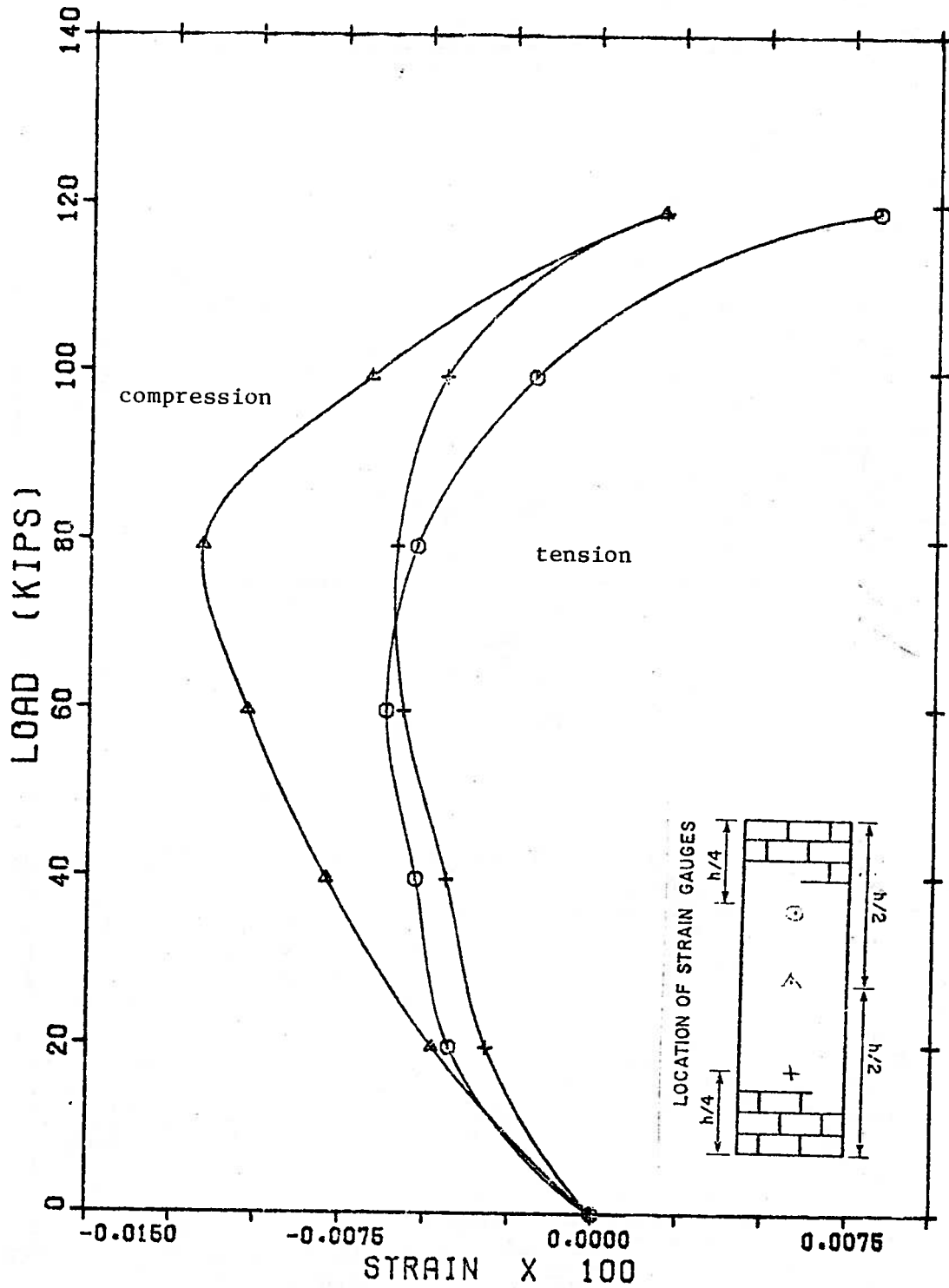

FIG. 2.85 Reinforcement Strain for Wall C4

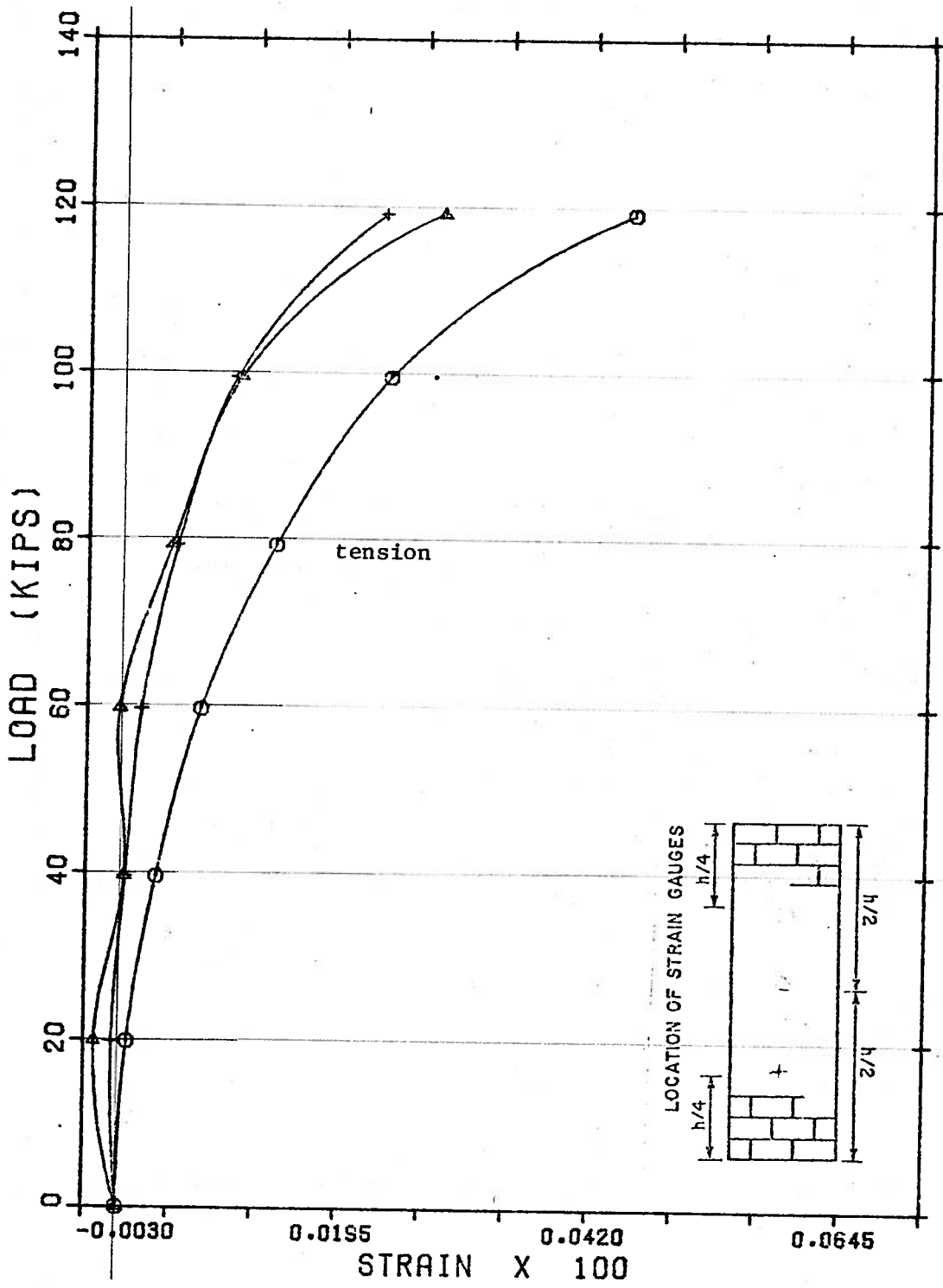

FIG. 2.86 Reinforcement Strain for Wall C5

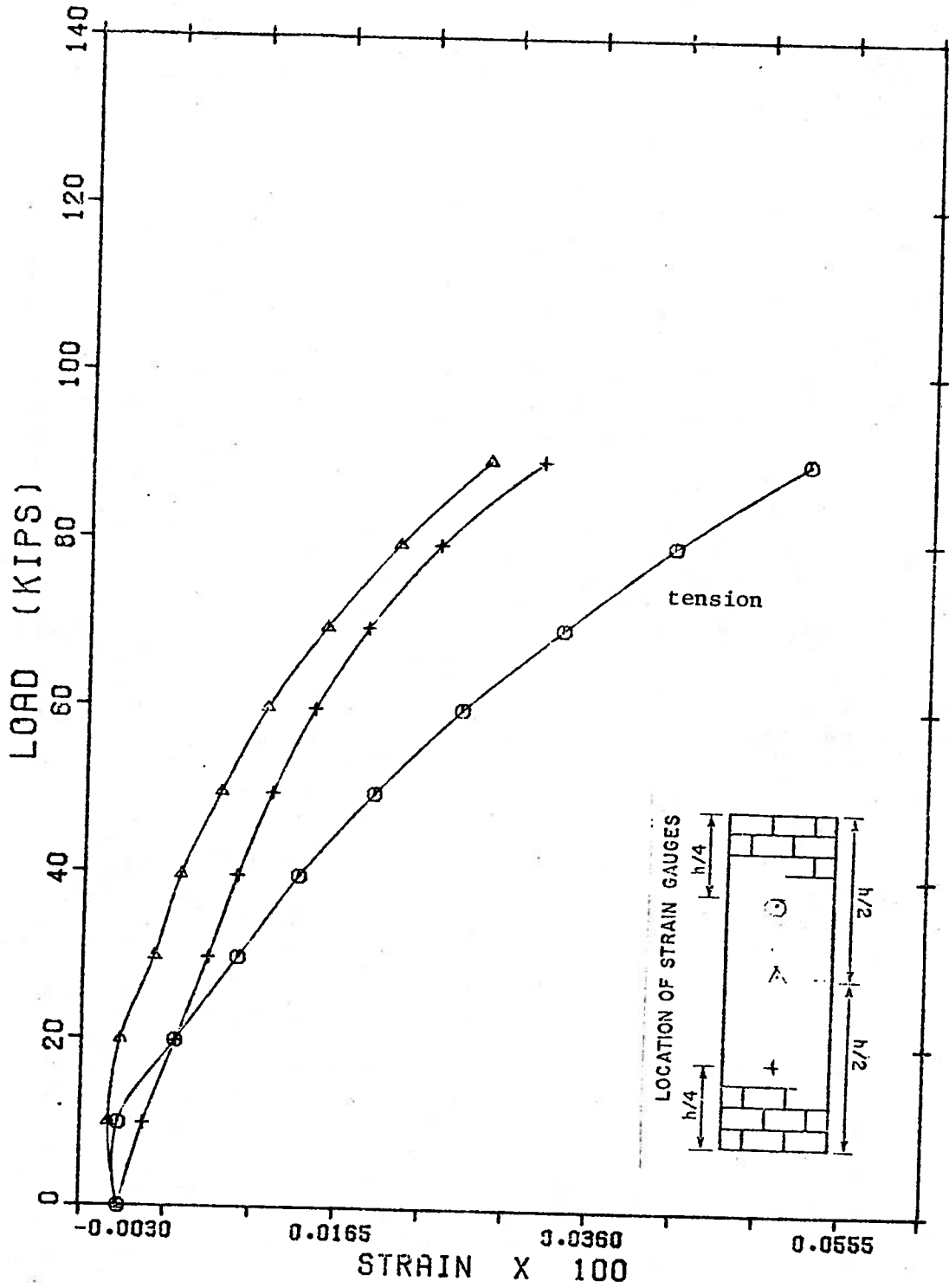

FIG. 2.87 Reinforcement Strain for Wall C6

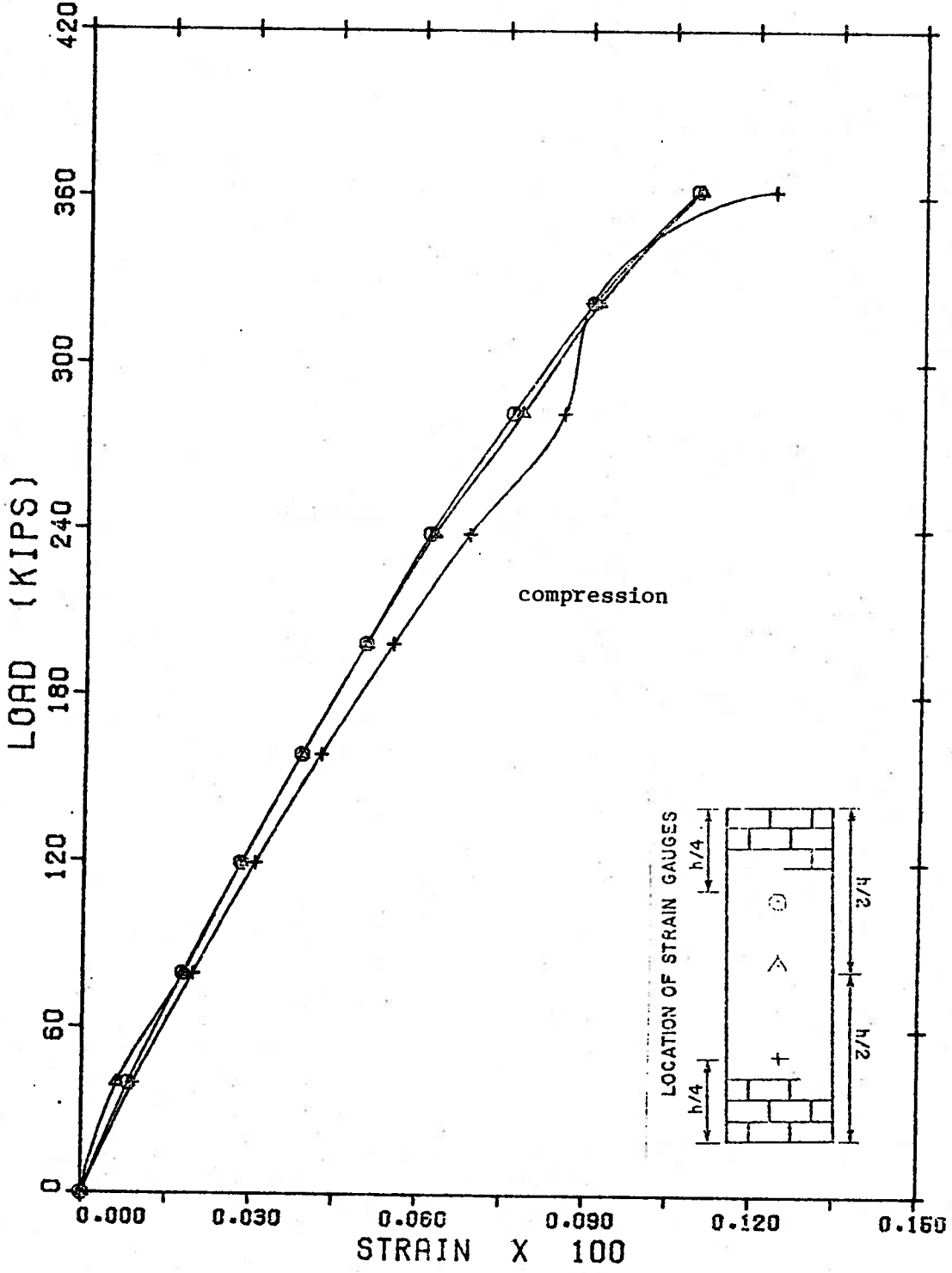

FIG. 2.88 Reinforcement Strain for Wall H1

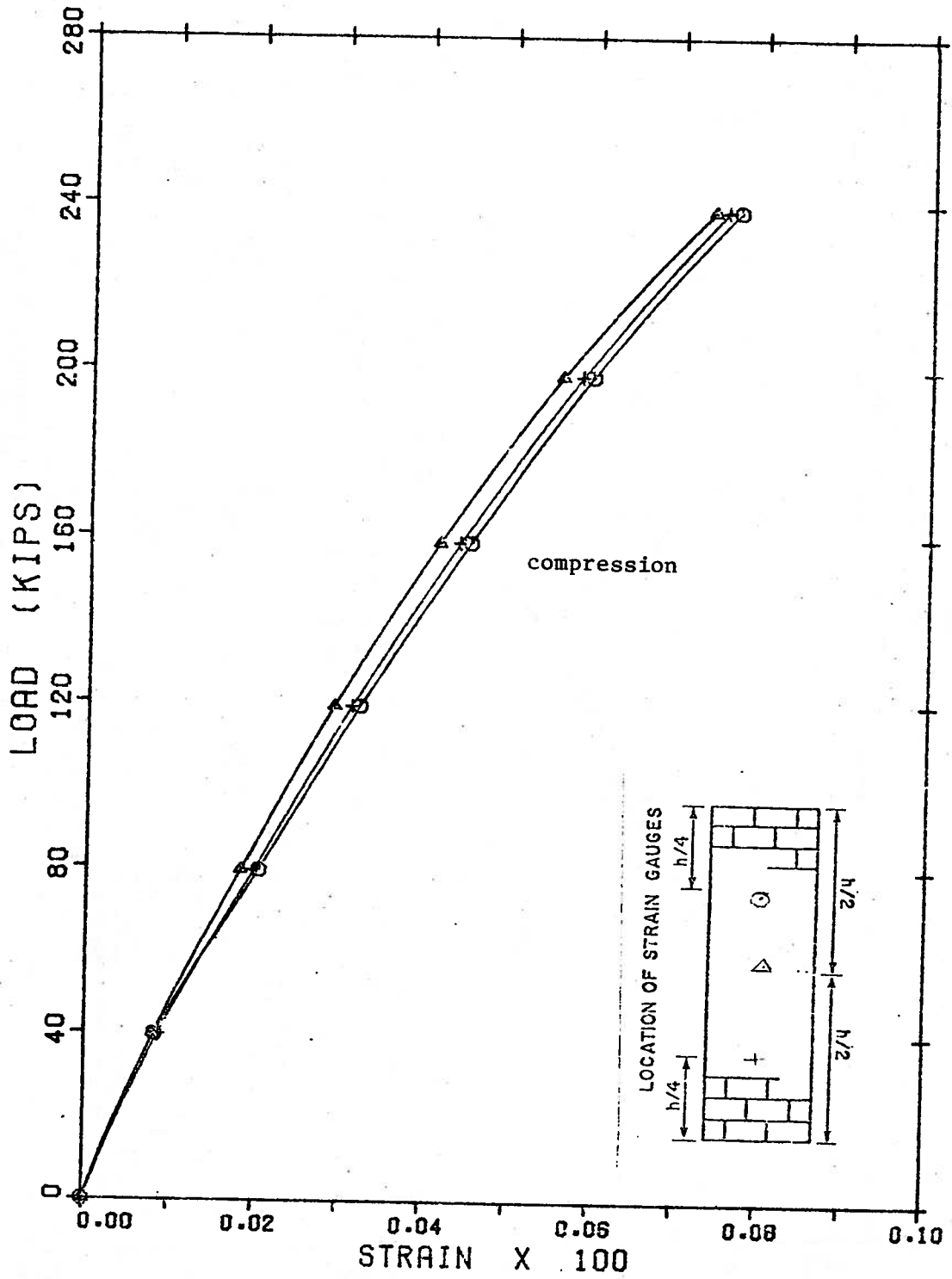

FIG. 2.89 Reinforcement Strain for Wall H2

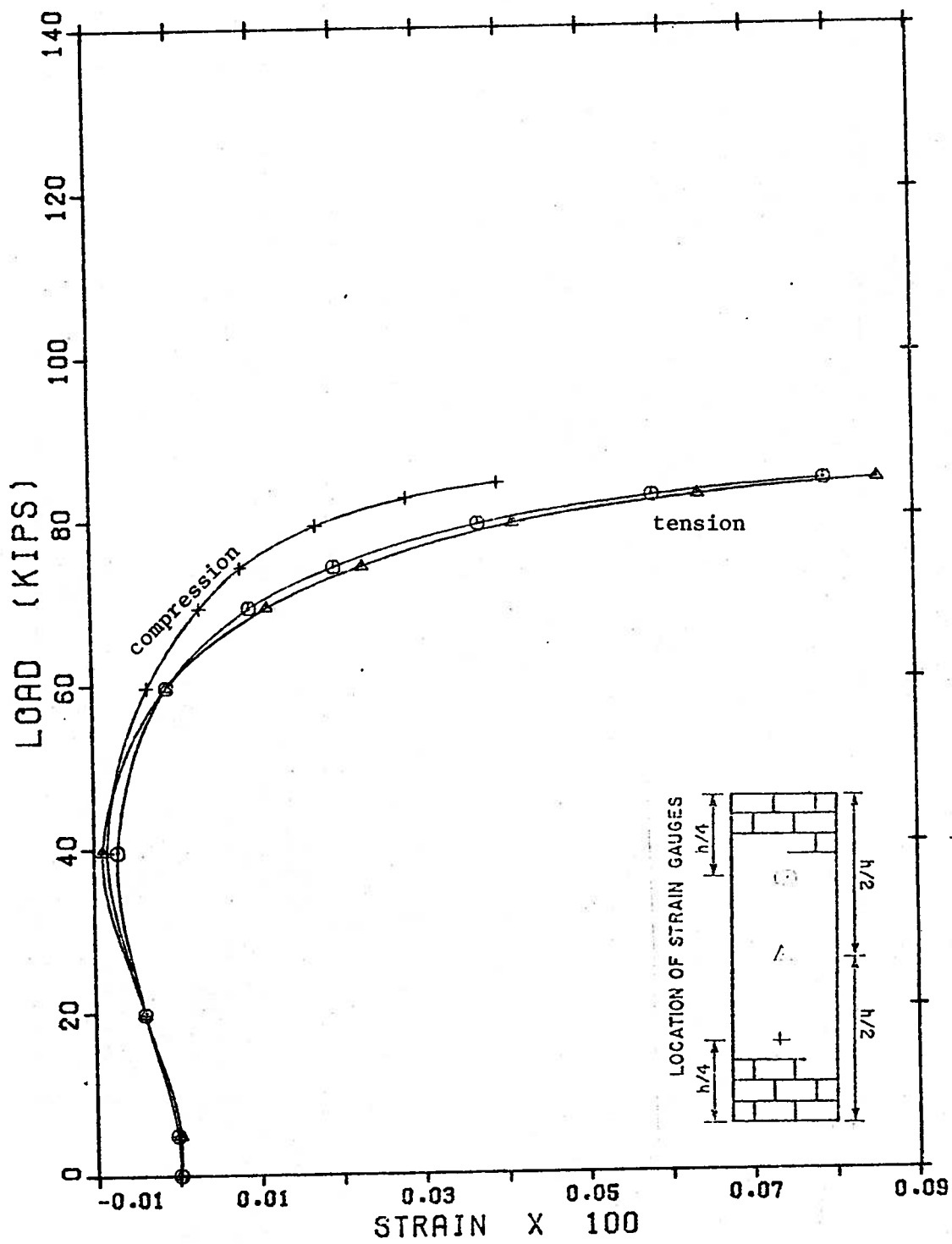

FIG. 2.90 Reinforcement Strain for Wall H3

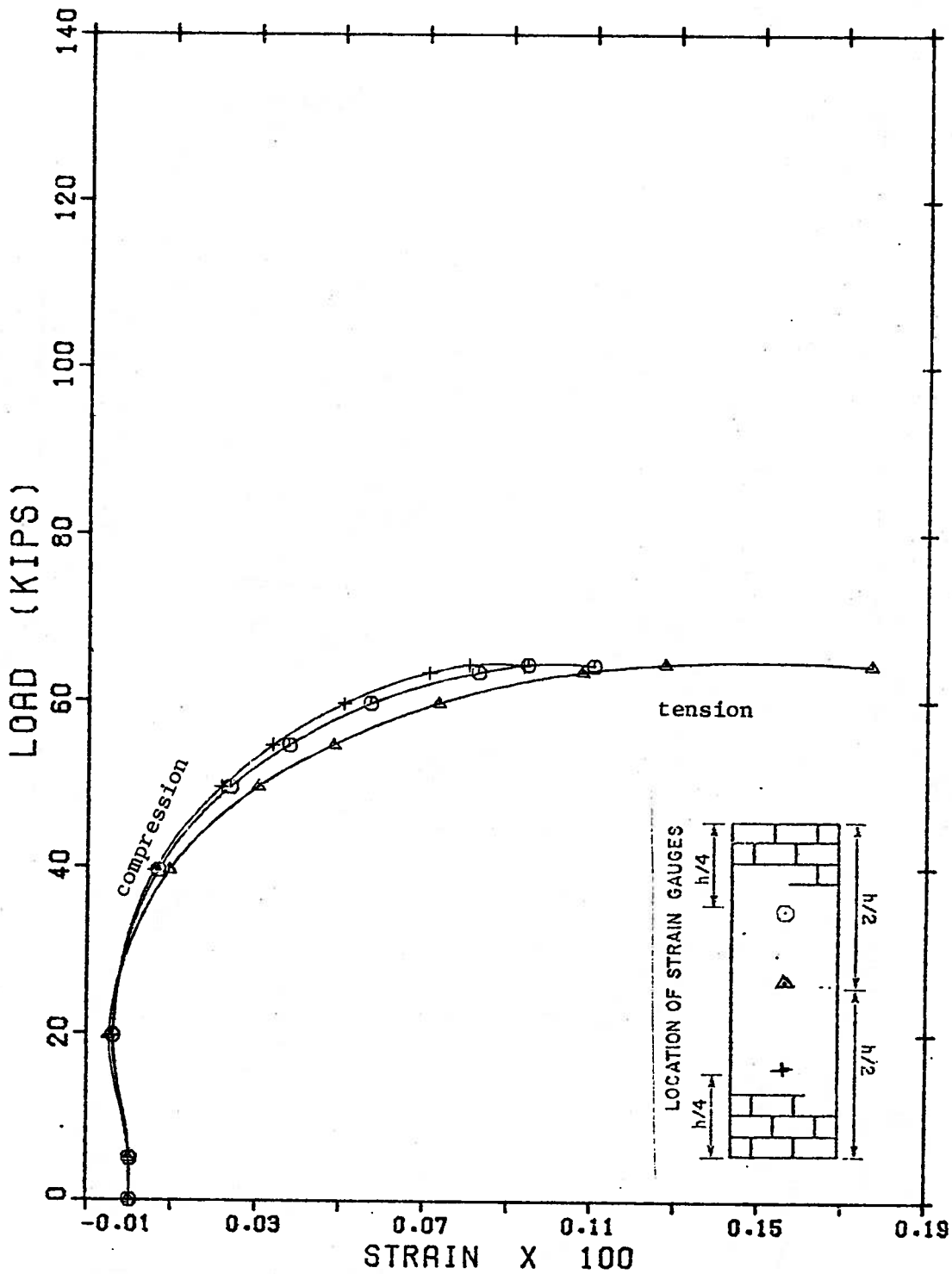

FIG. 2.91 Reinforcement Strain for Wall H4

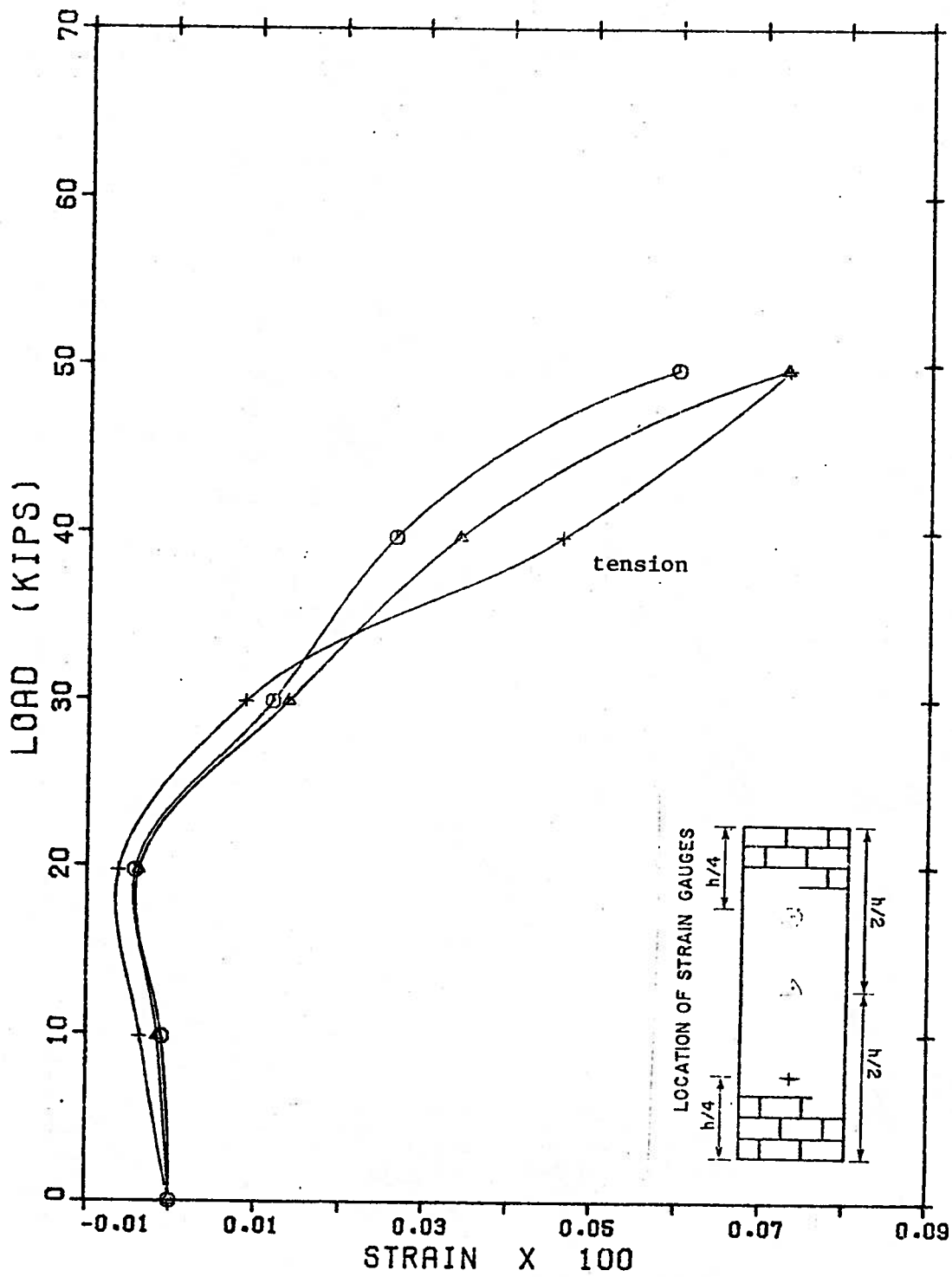

FIG. 2.92 Reinforcement Strain for Wall H5

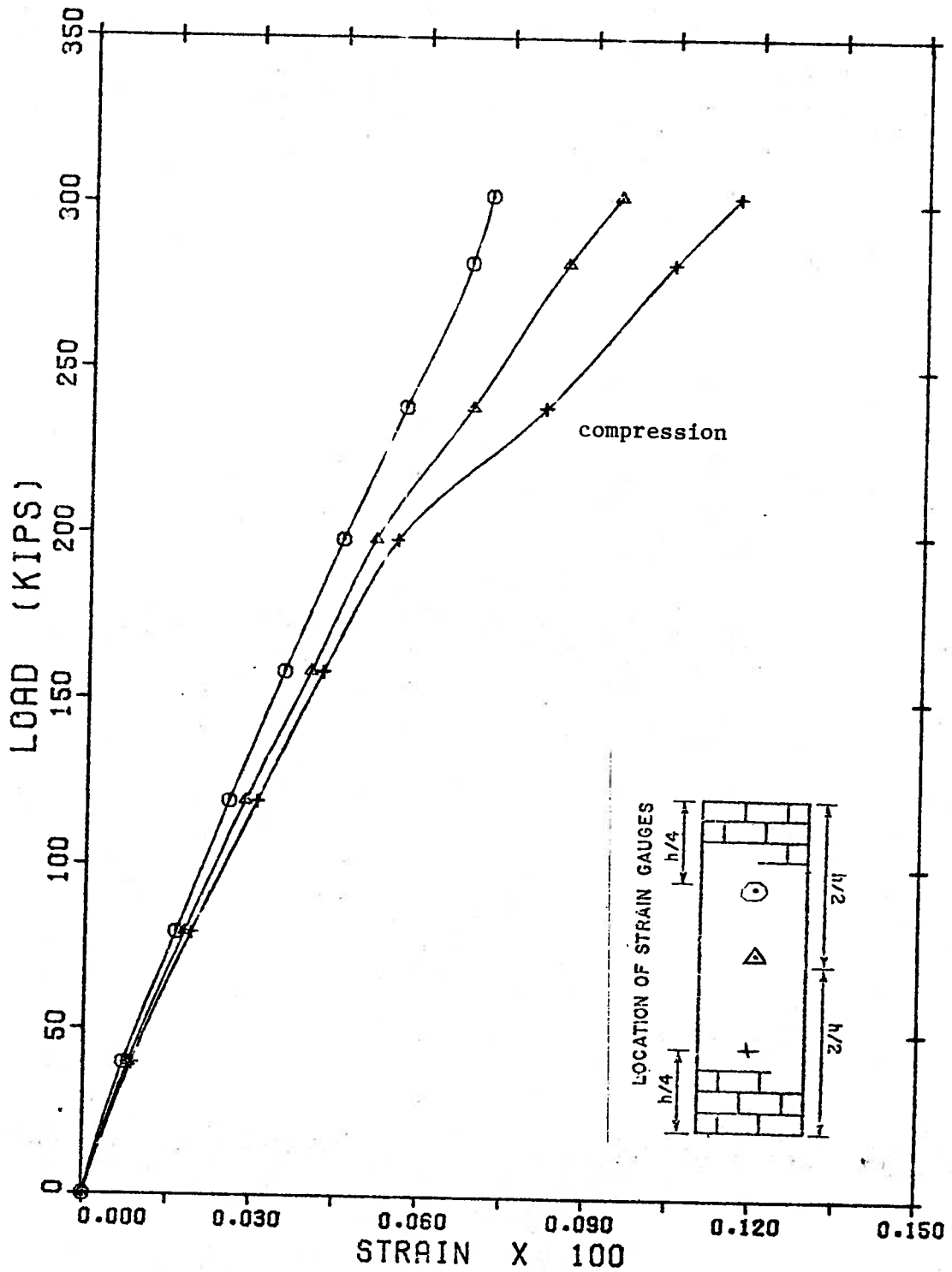

FIG. 2.93 Reinforcement Strain for Wall I1

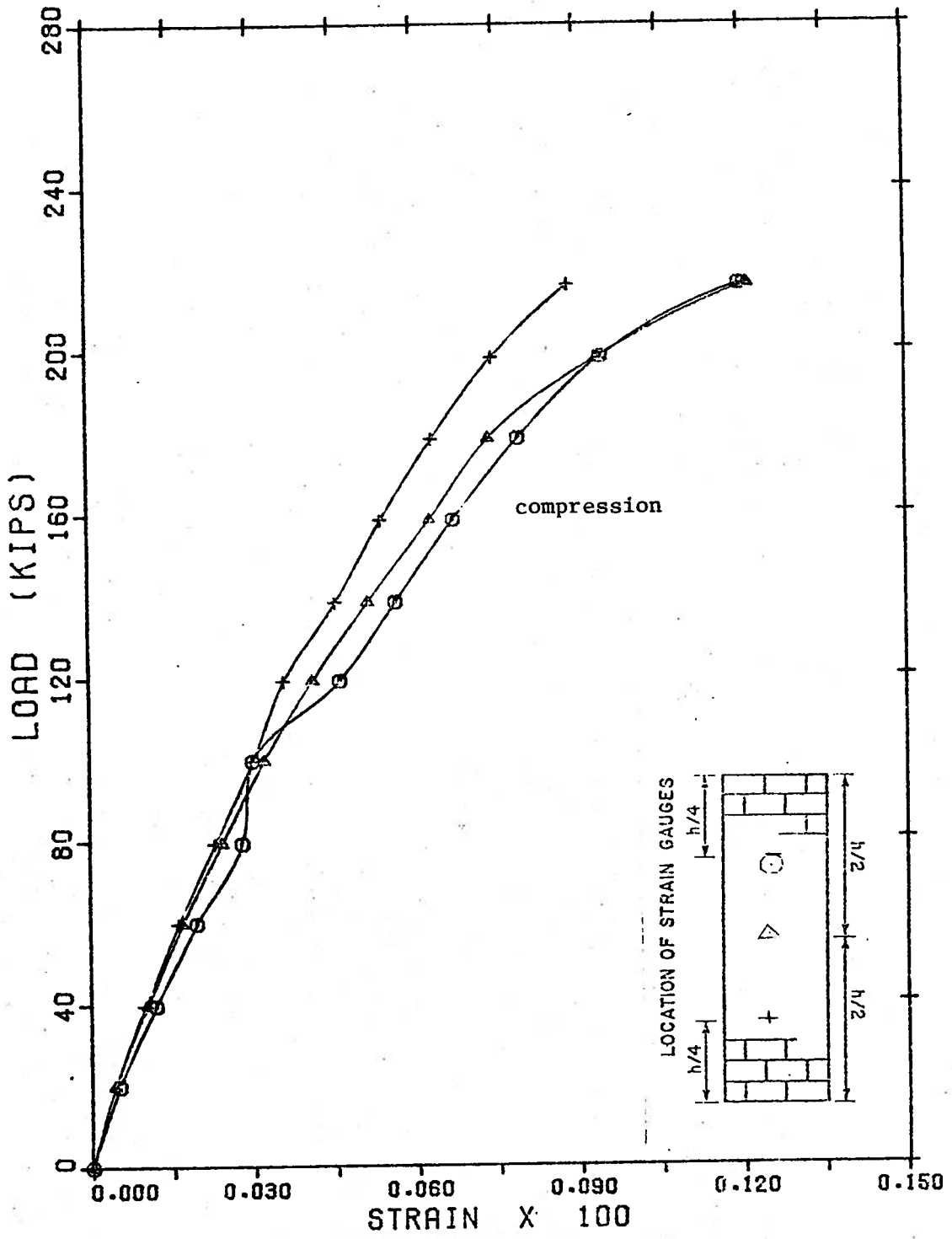

FIG. 2.94 Reinforcement Strain for Wall I2

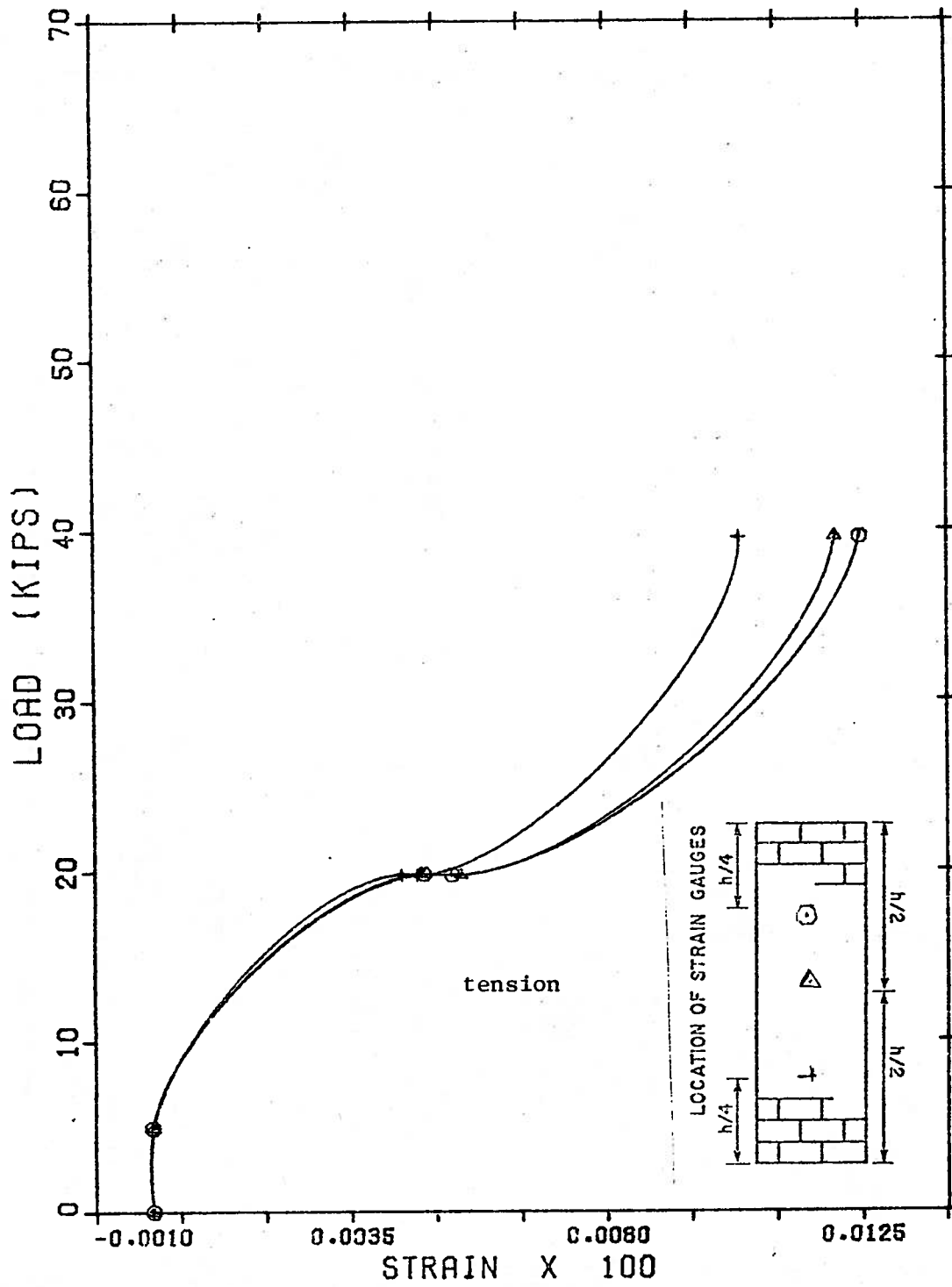

FIG. 2.95 Reinforcement Strain for Wall I3

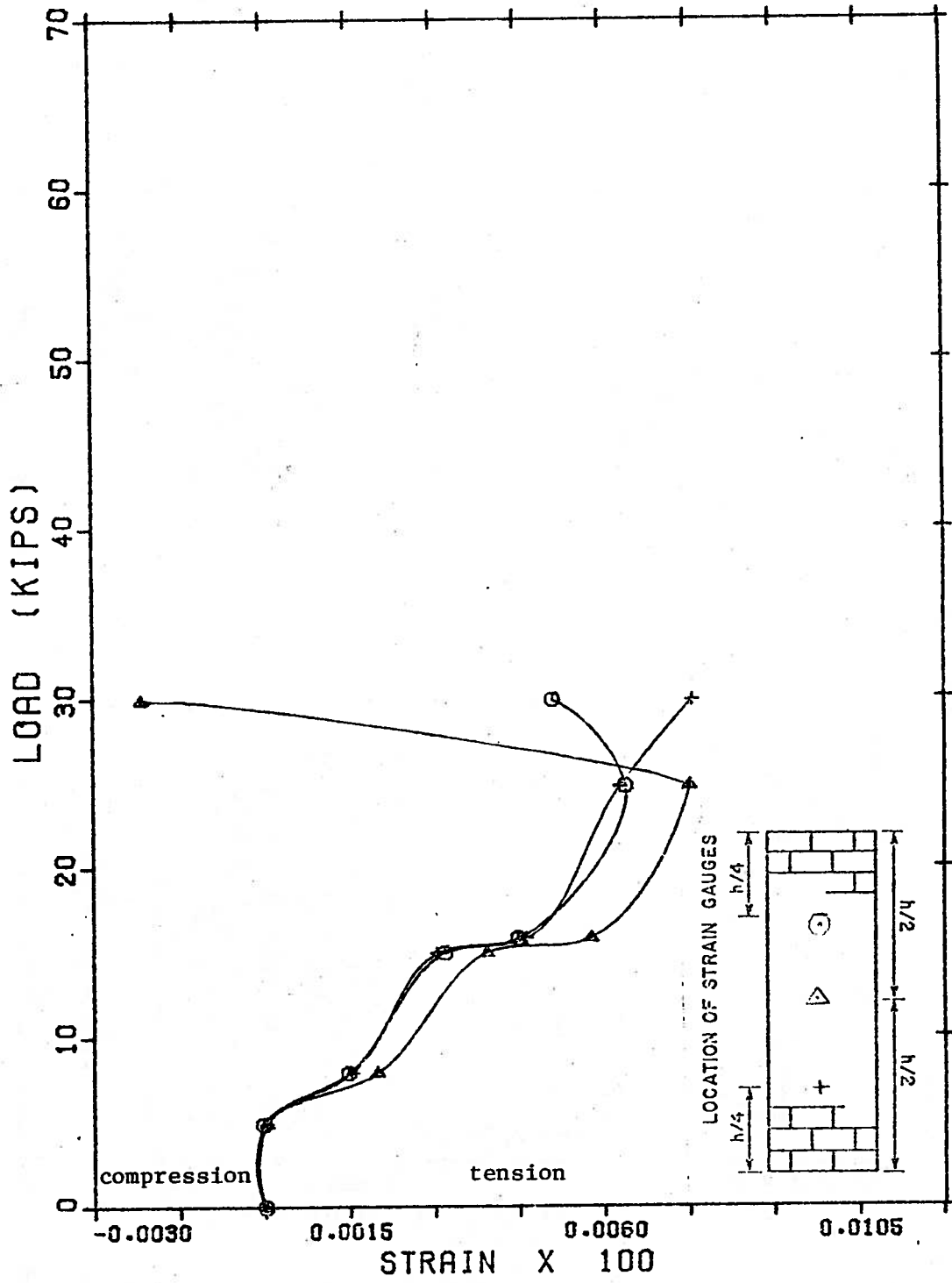

FIG. 2.96 Reinforcement Strain for Wall I4

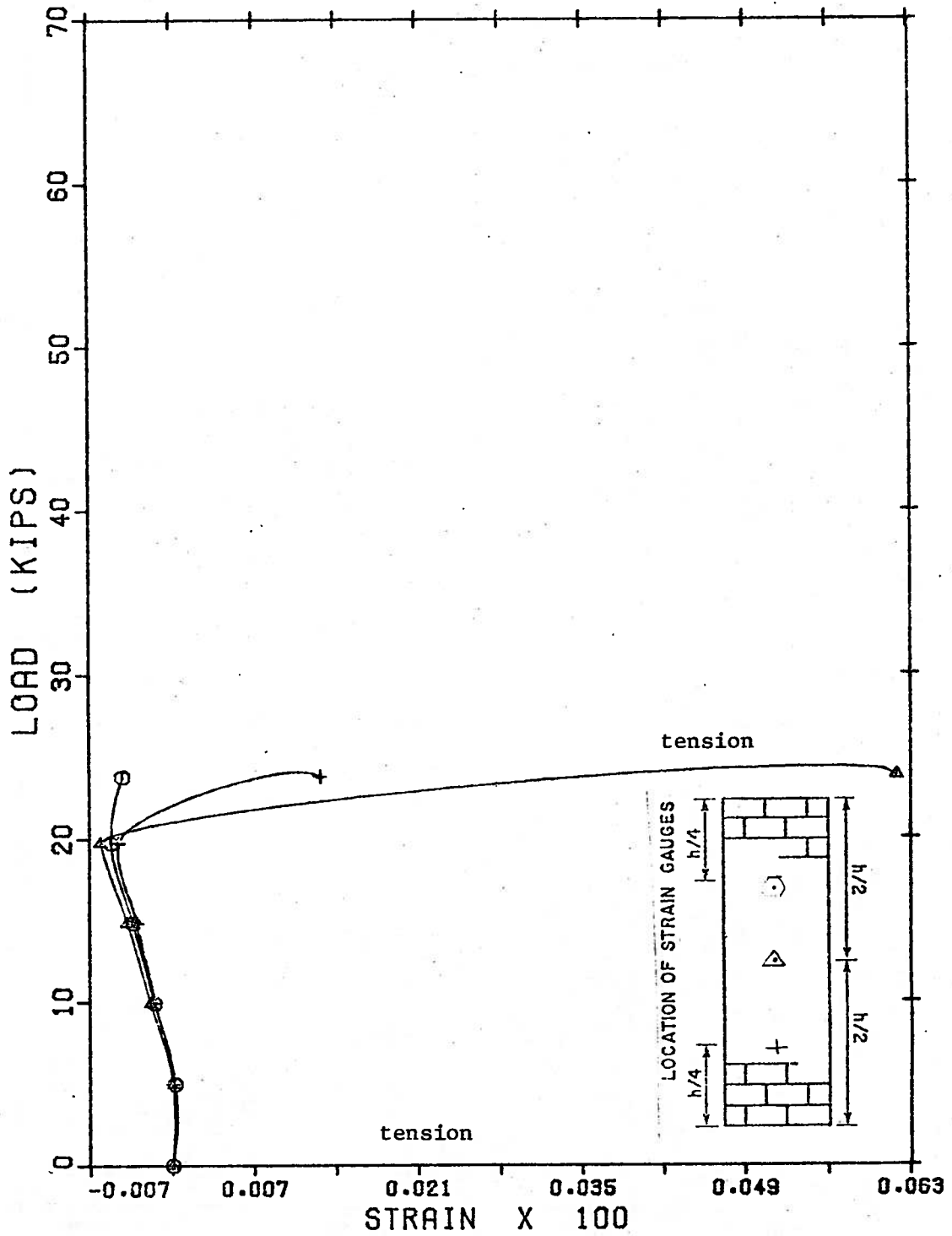

FIG. 2.97 Reinforcement Strain for Wall I5

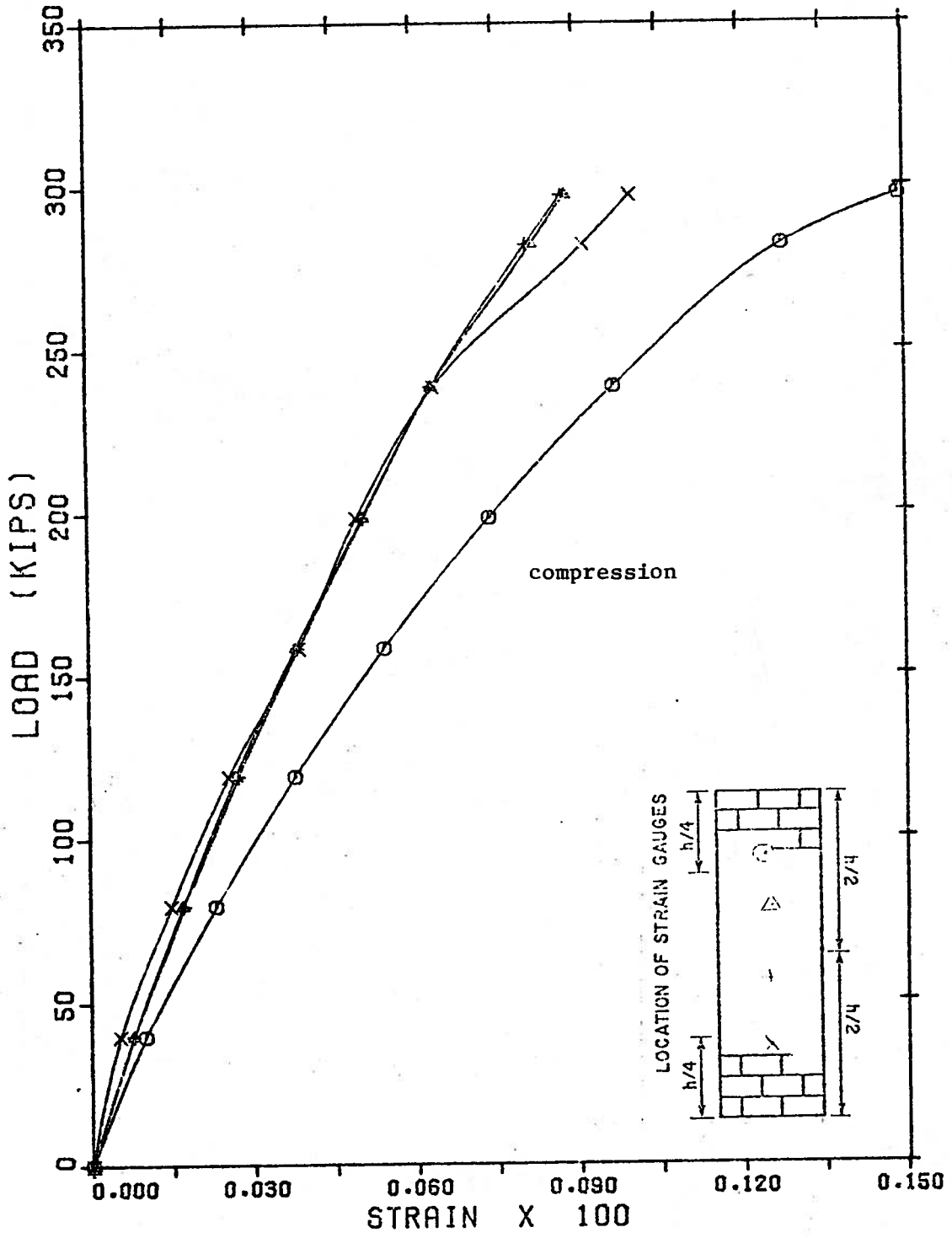

FIG. 2.98 Reinforcement Strain for Wall J1

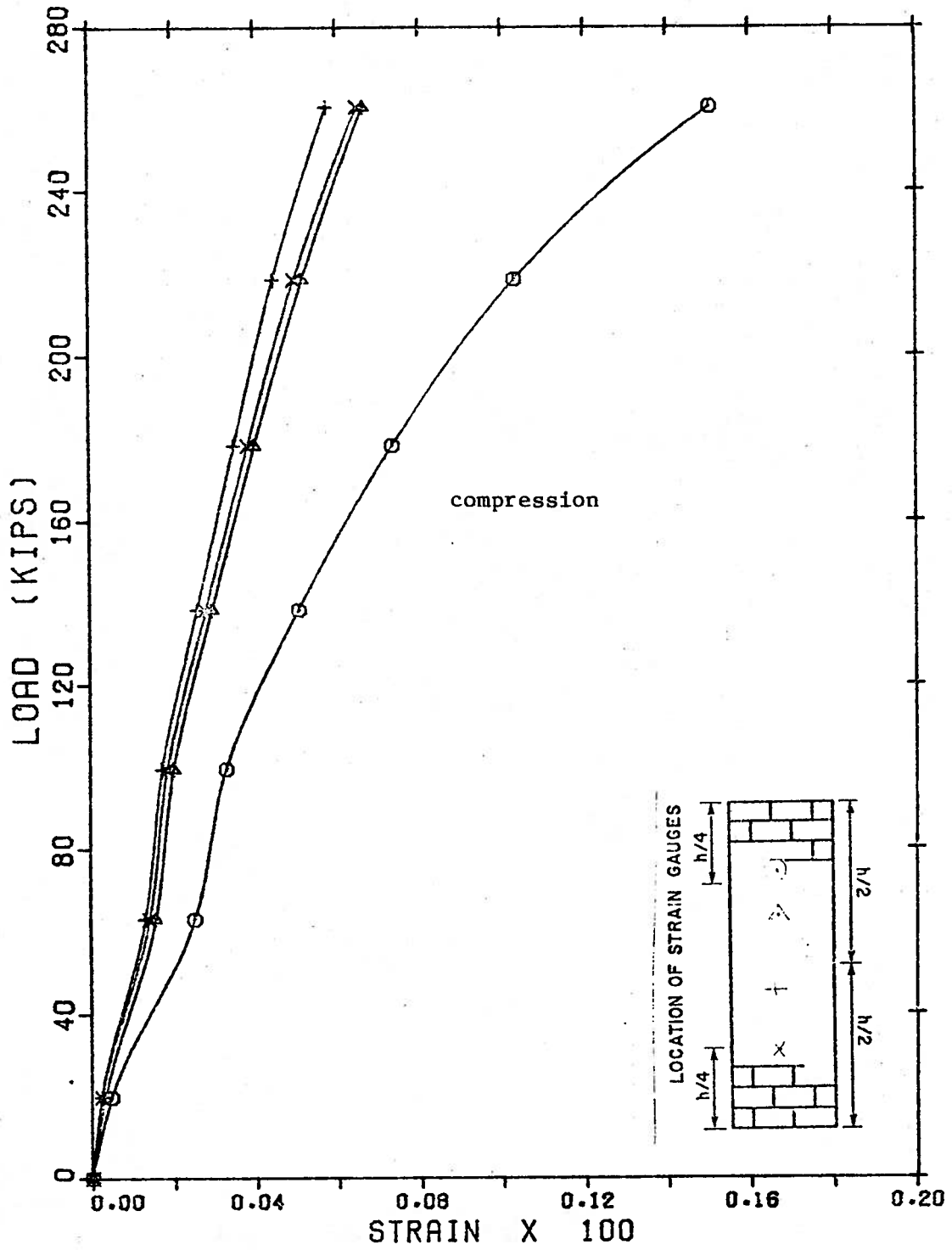

FIG. 2.99 Reinforcement Strain for Wall J2

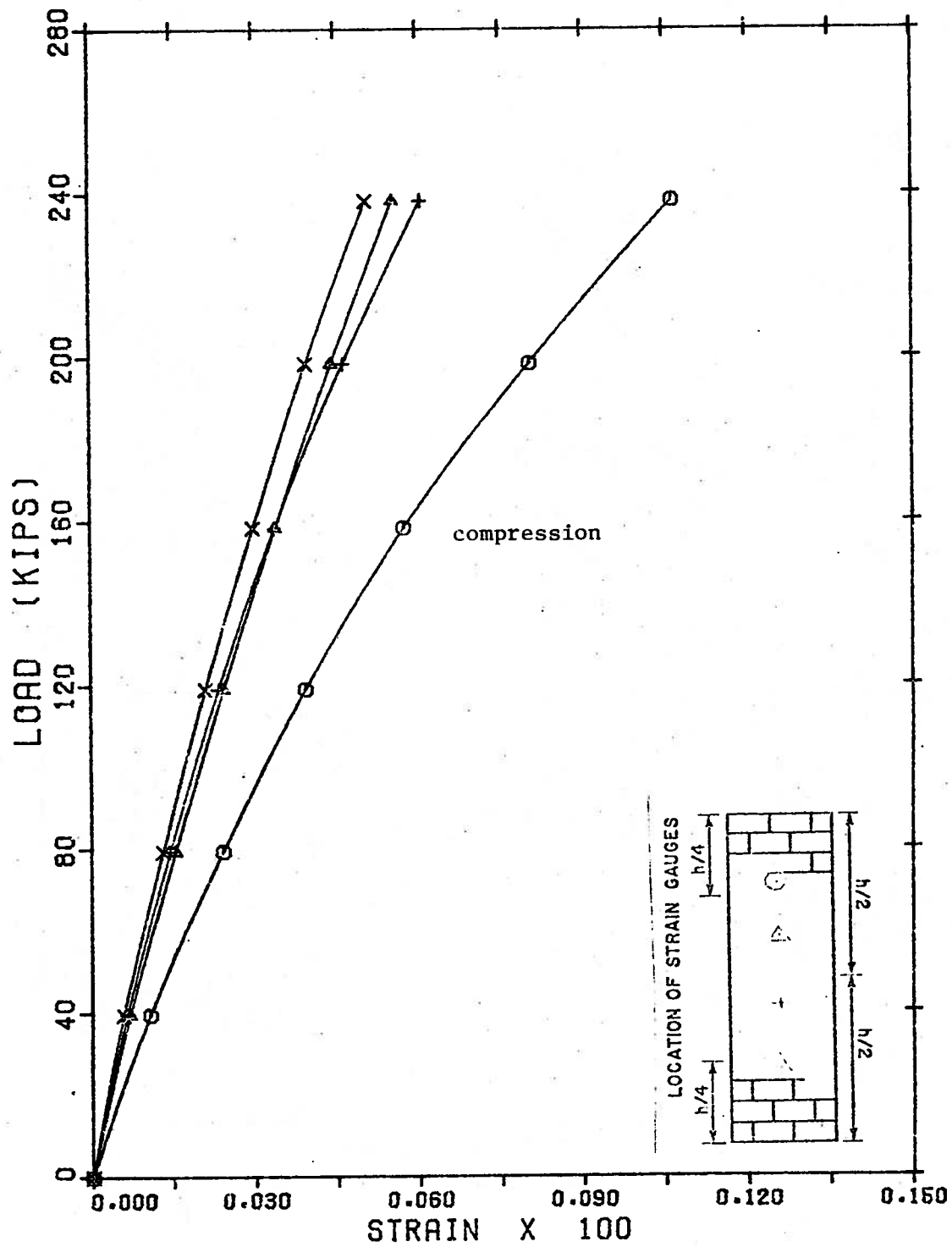

FIG. 2.100 Reinforcement Strain for Wall J3

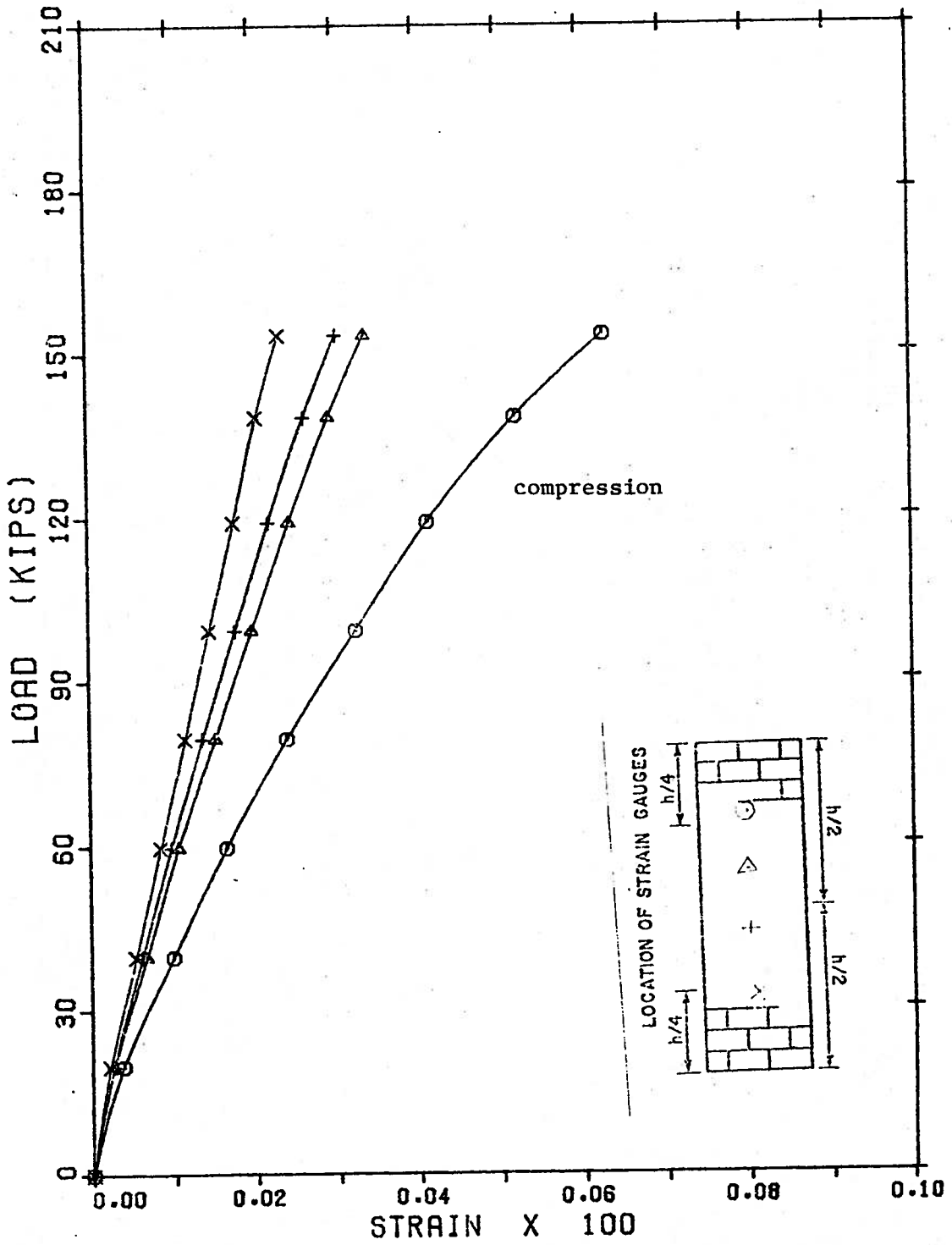

FIG. 2.101 Reinforcement Strain for Wall J4

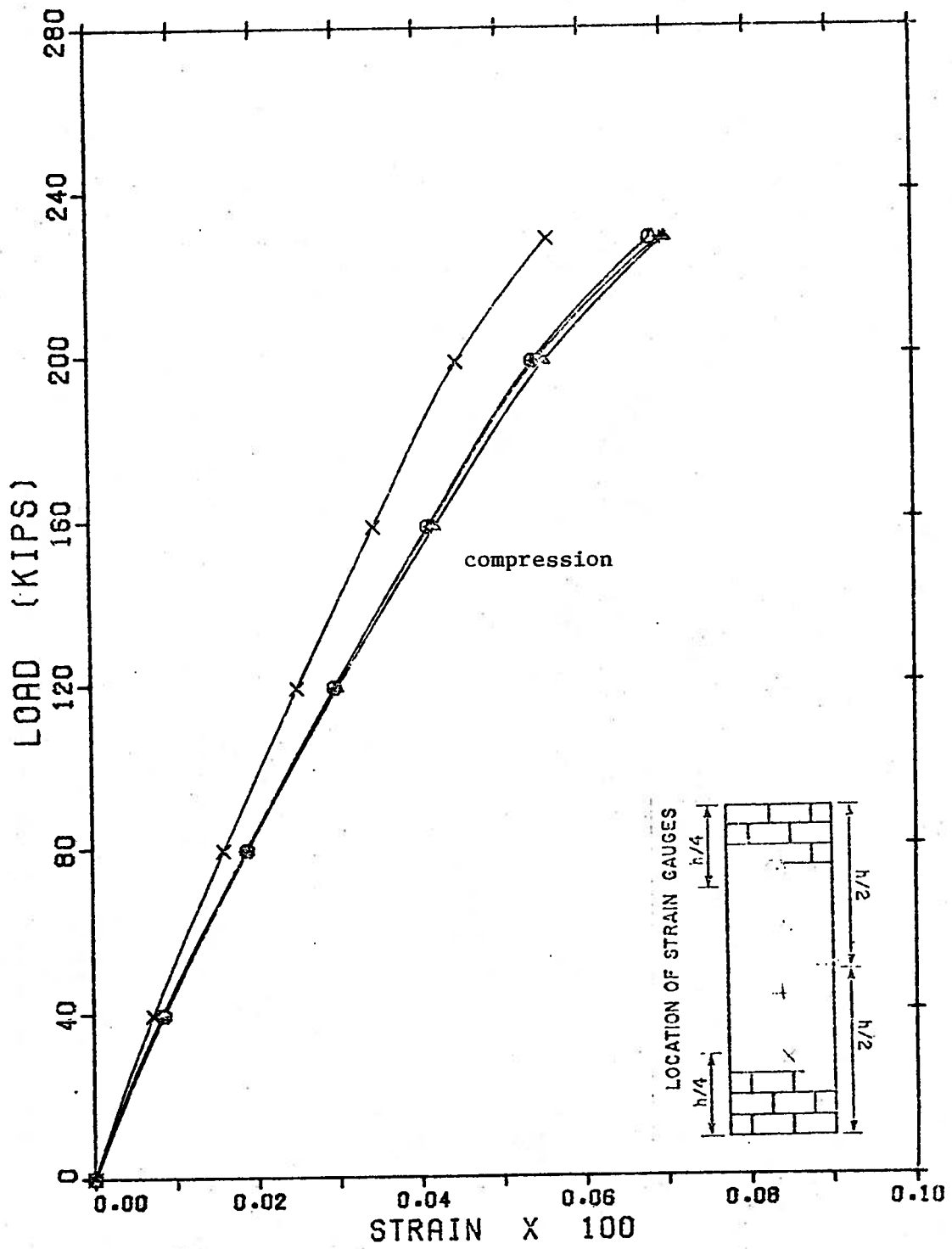

FIG. 2.102 Reinforcement Strain for Wall K1

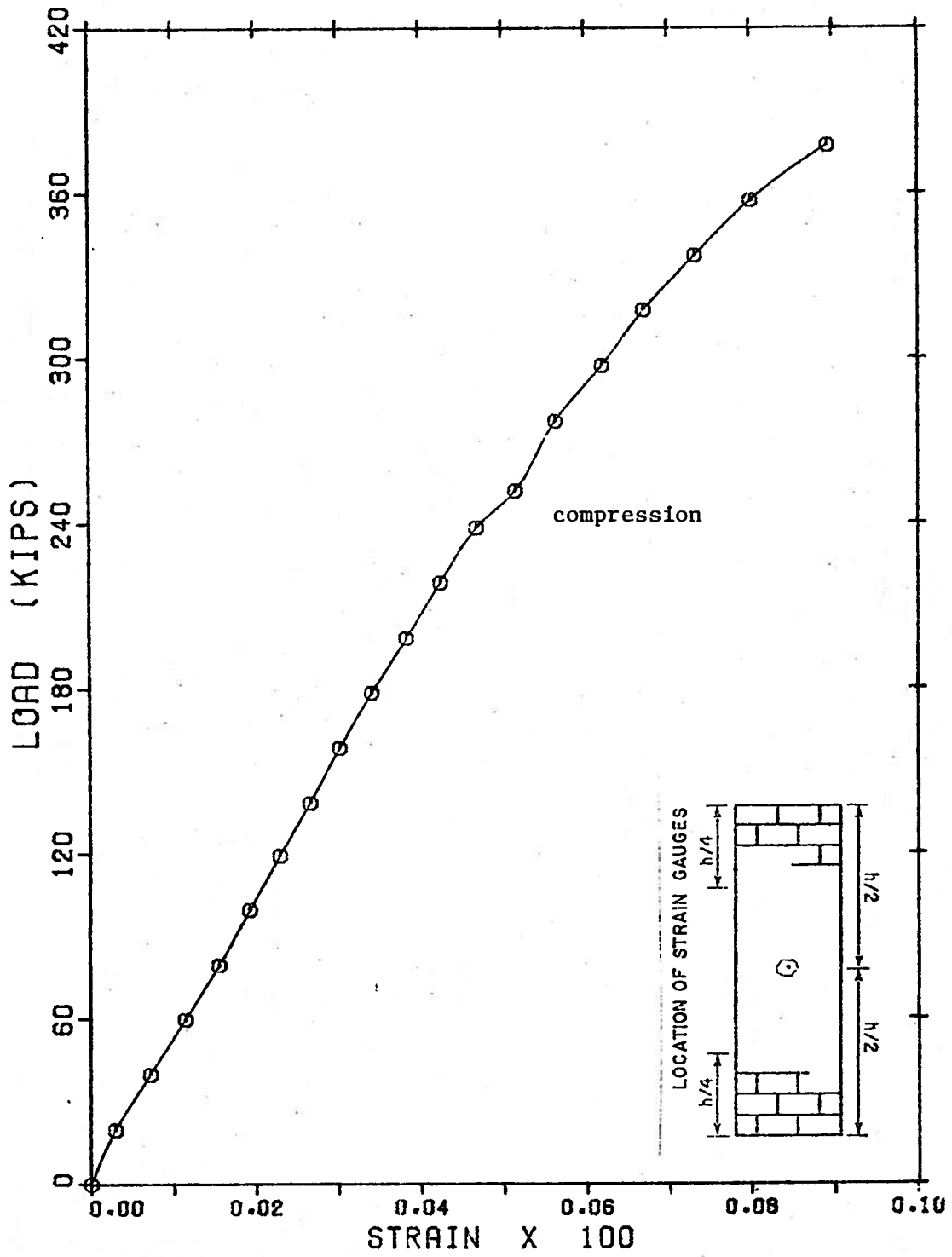

FIG. 2.103 Reinforcement Strain for Wall L1

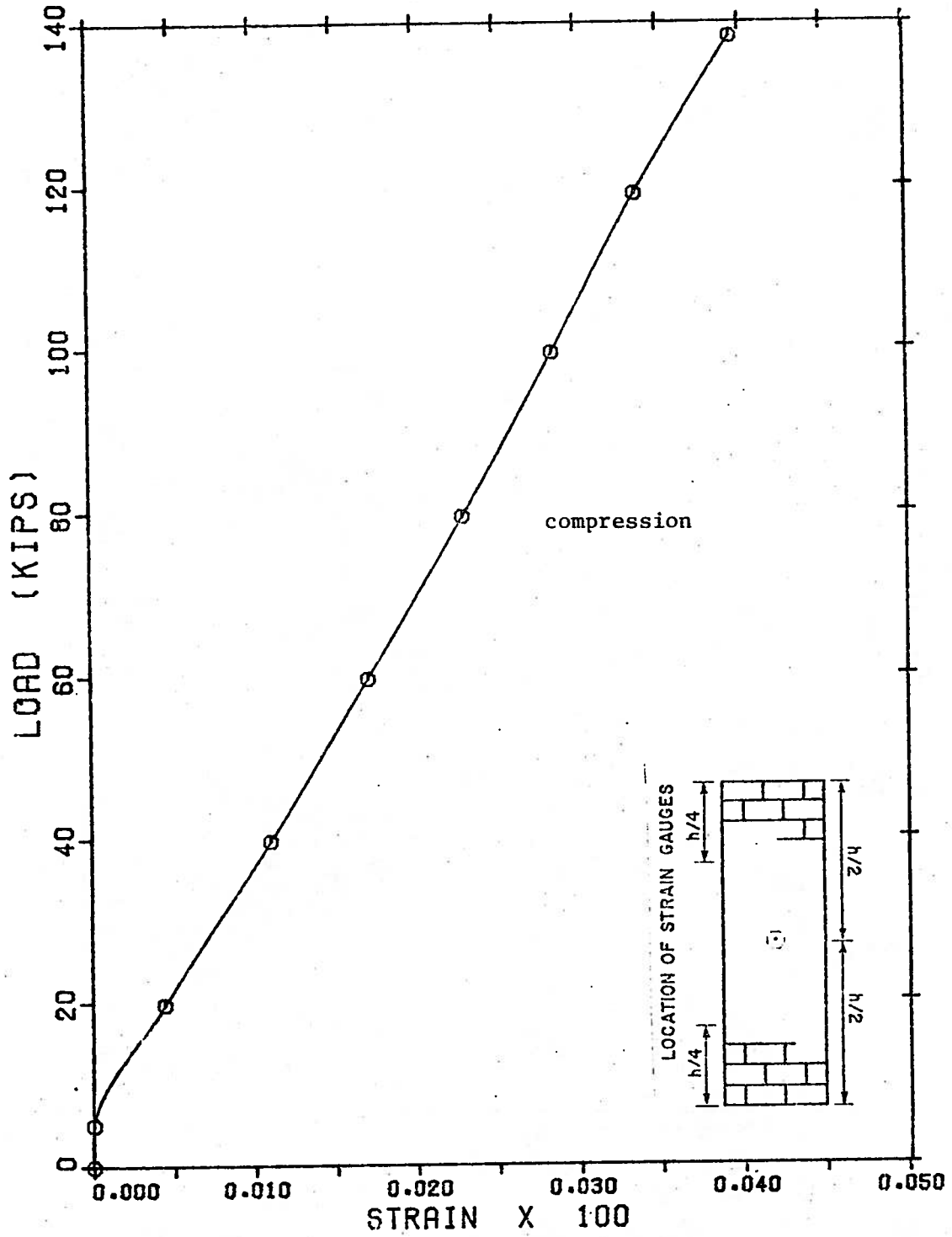

FIG. 2.104 Reinforcement Strain for Wall L2

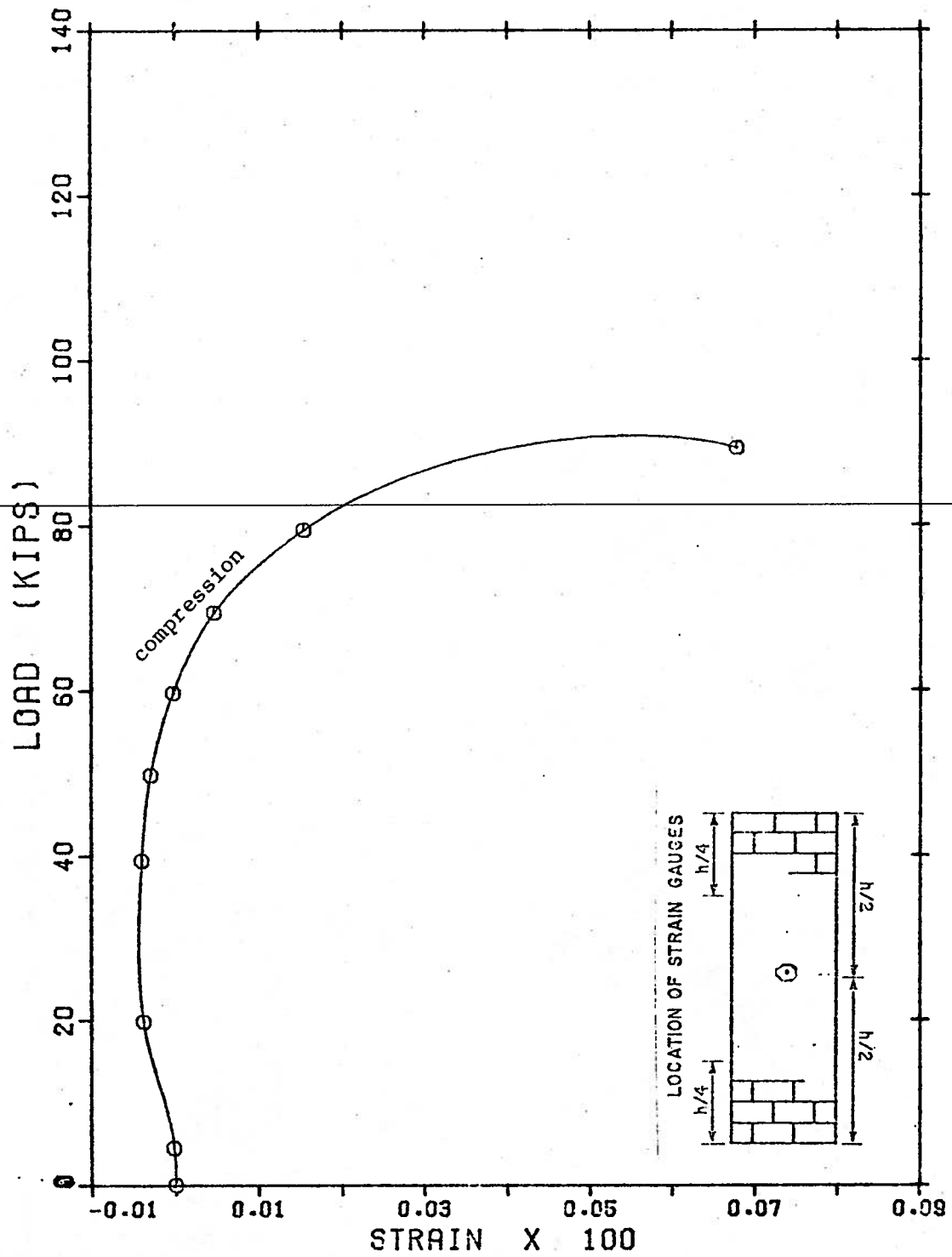

FIG. 2.105 Reinforcement Strain for Wall L3

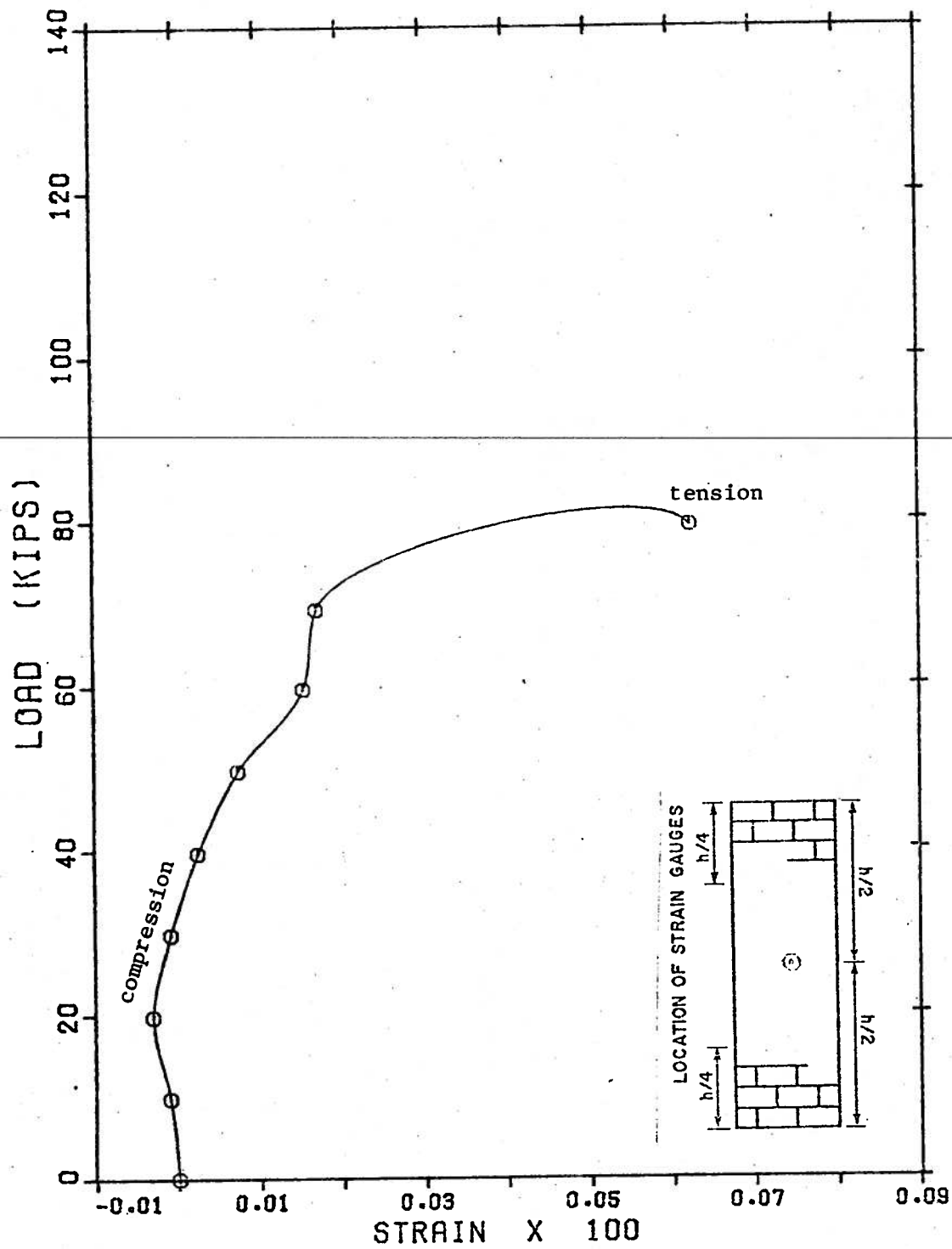

FIG. 2.106 Reinforcement Strain for Wall L4

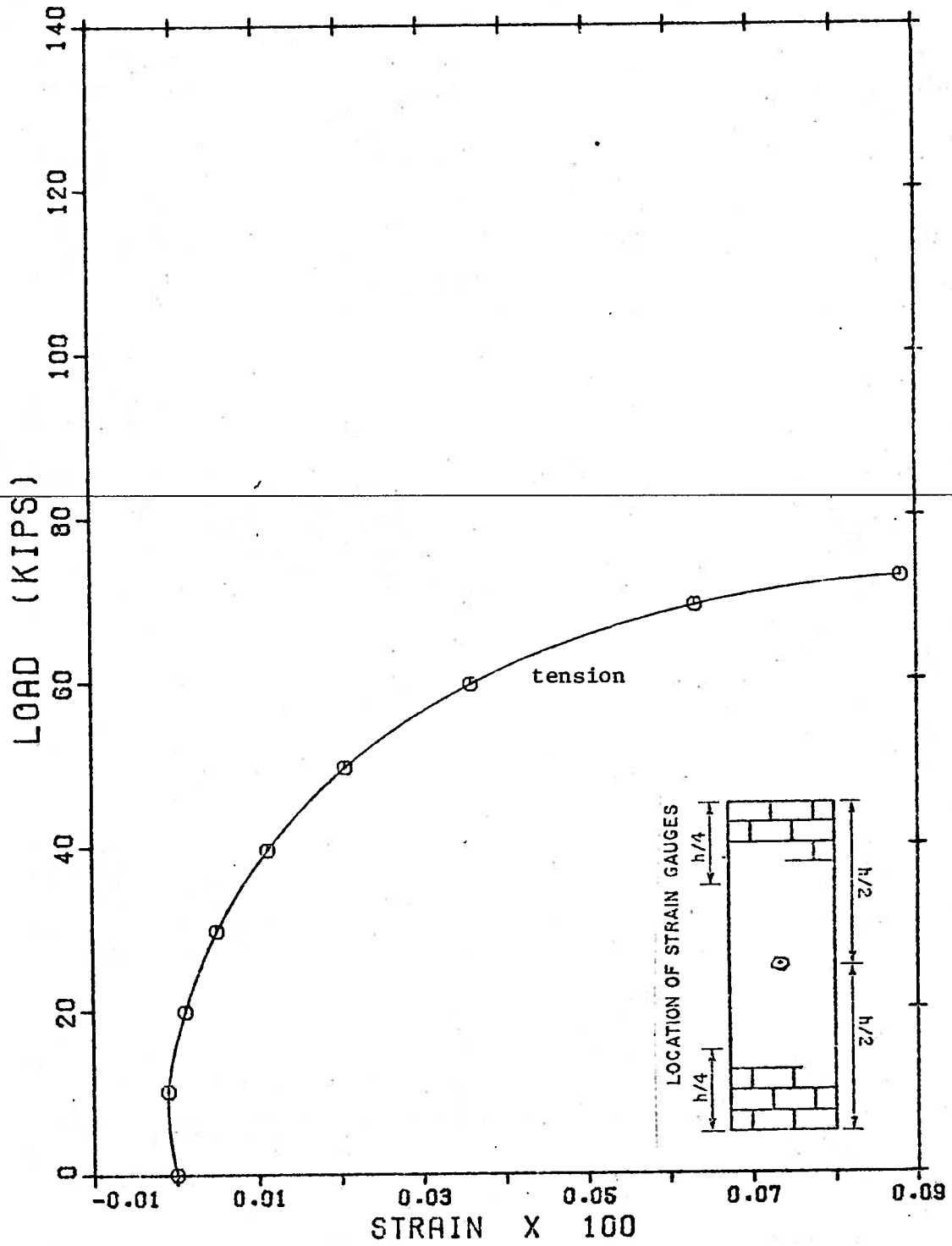

FIG. 2.107 Reinforcement Strain for Wall L5

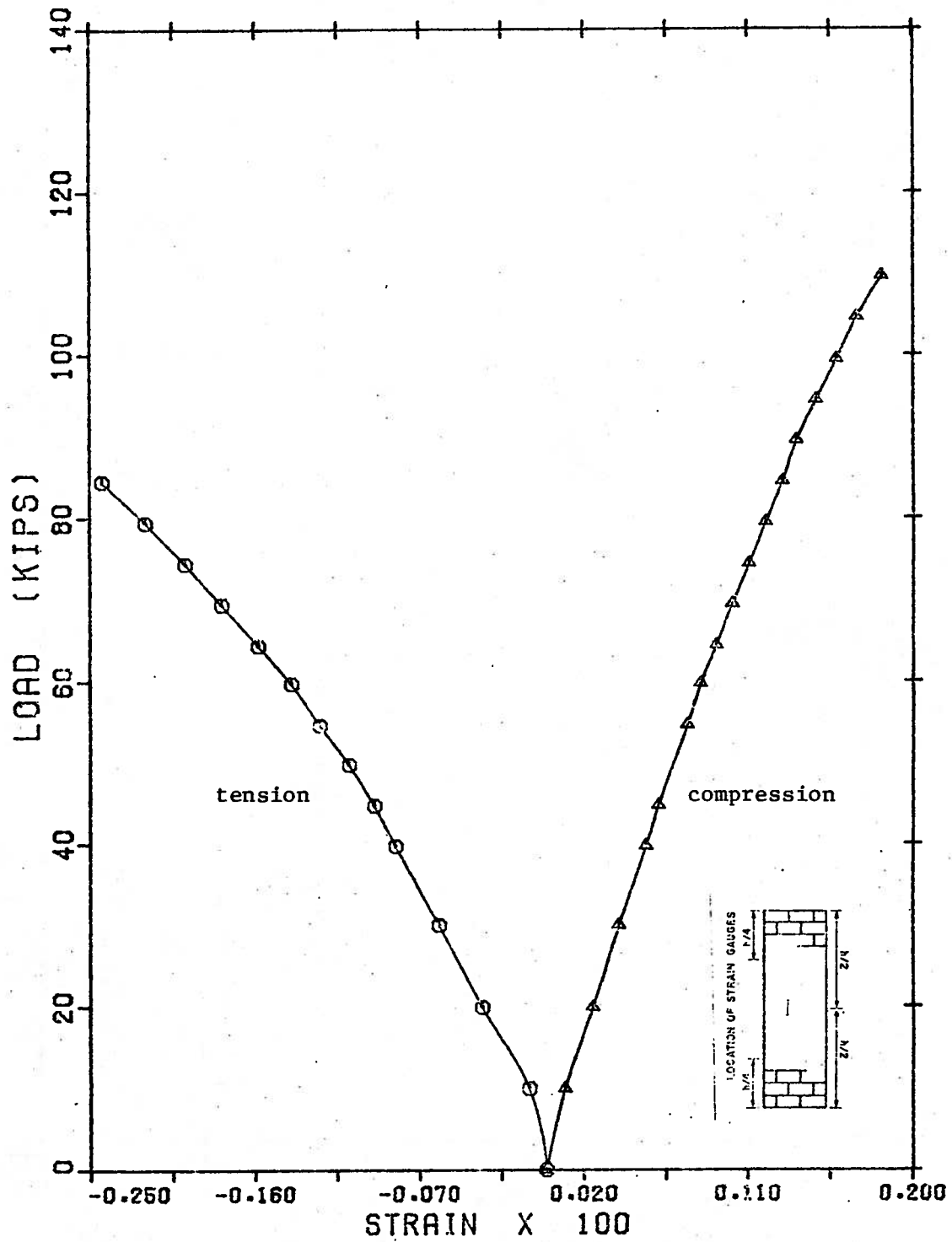

FIG. 2.108 Masonry Strain for Wall B5

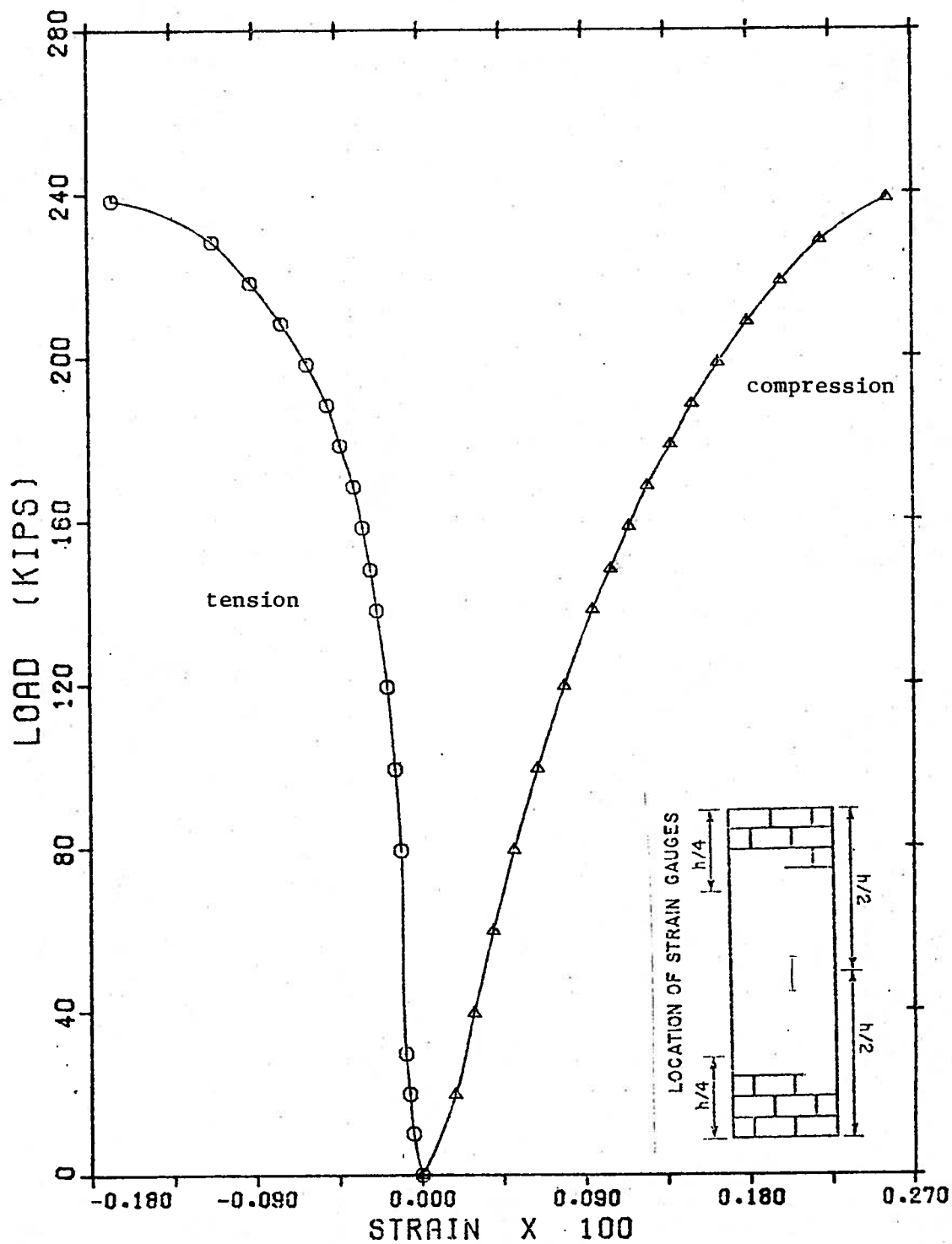

FIG. 2.109 Masonry Strain for Wall C3

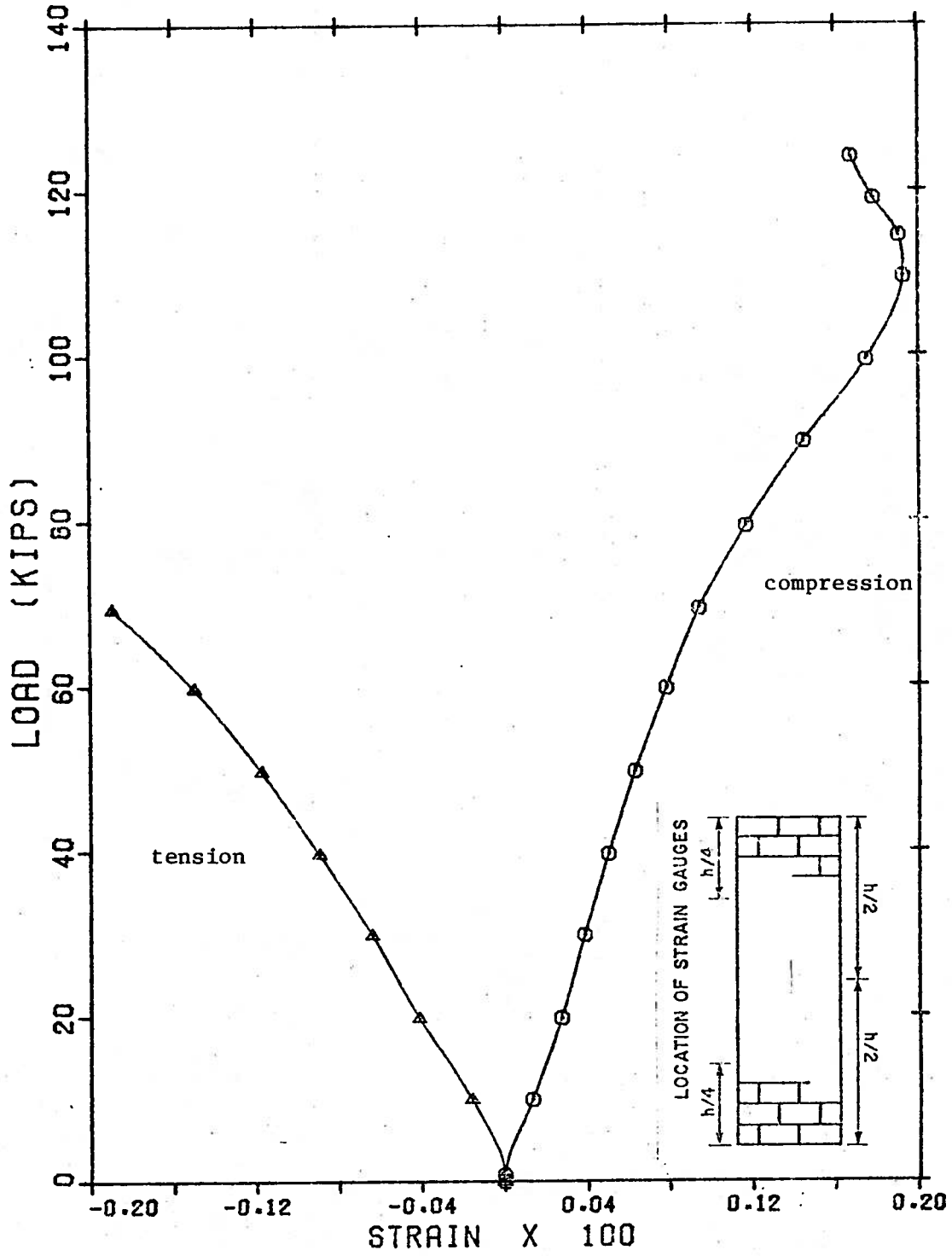

FIG. 2.110 Masonry Strain for Wall C4

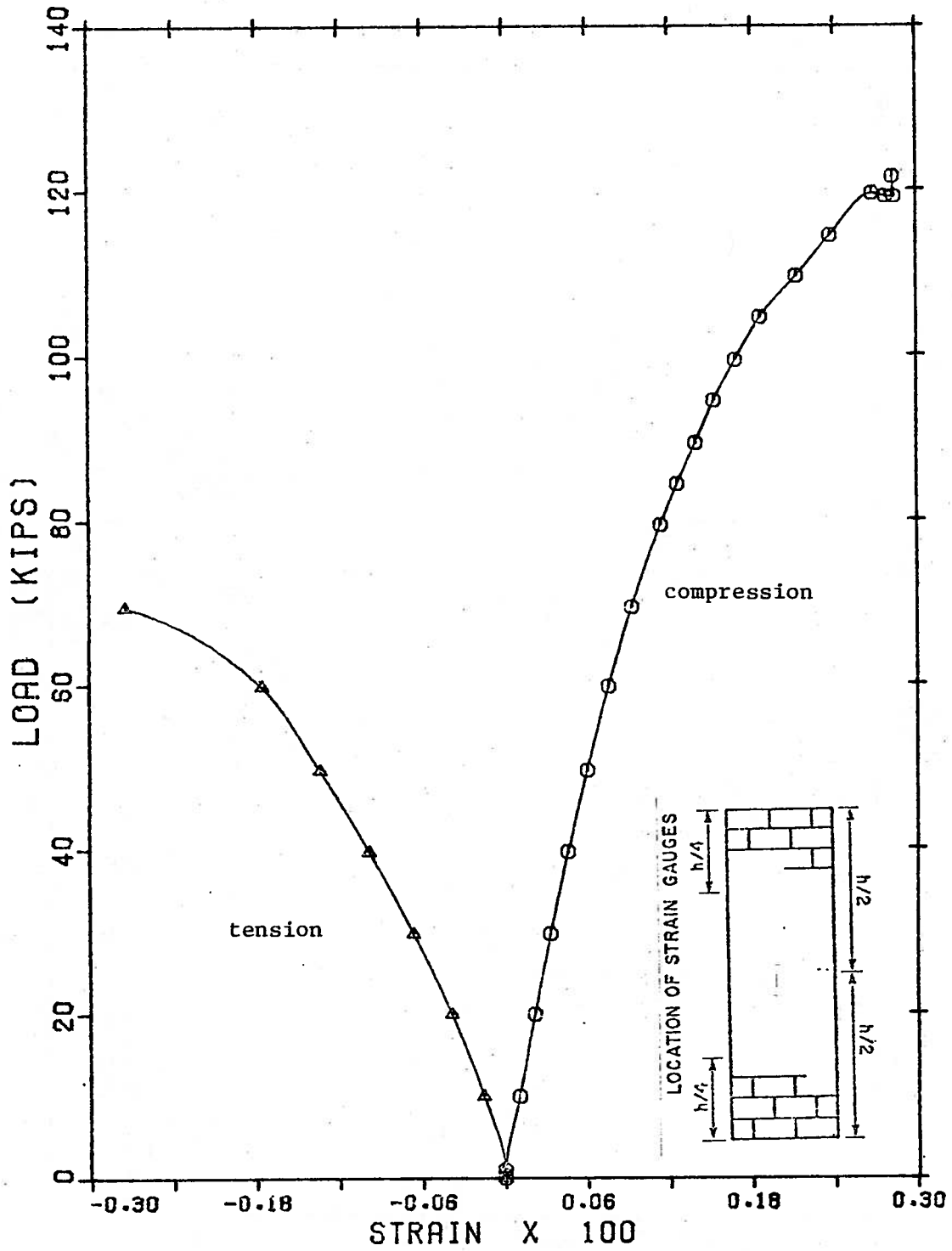

FIG. 2.111 Masonry Strain for Wall C5

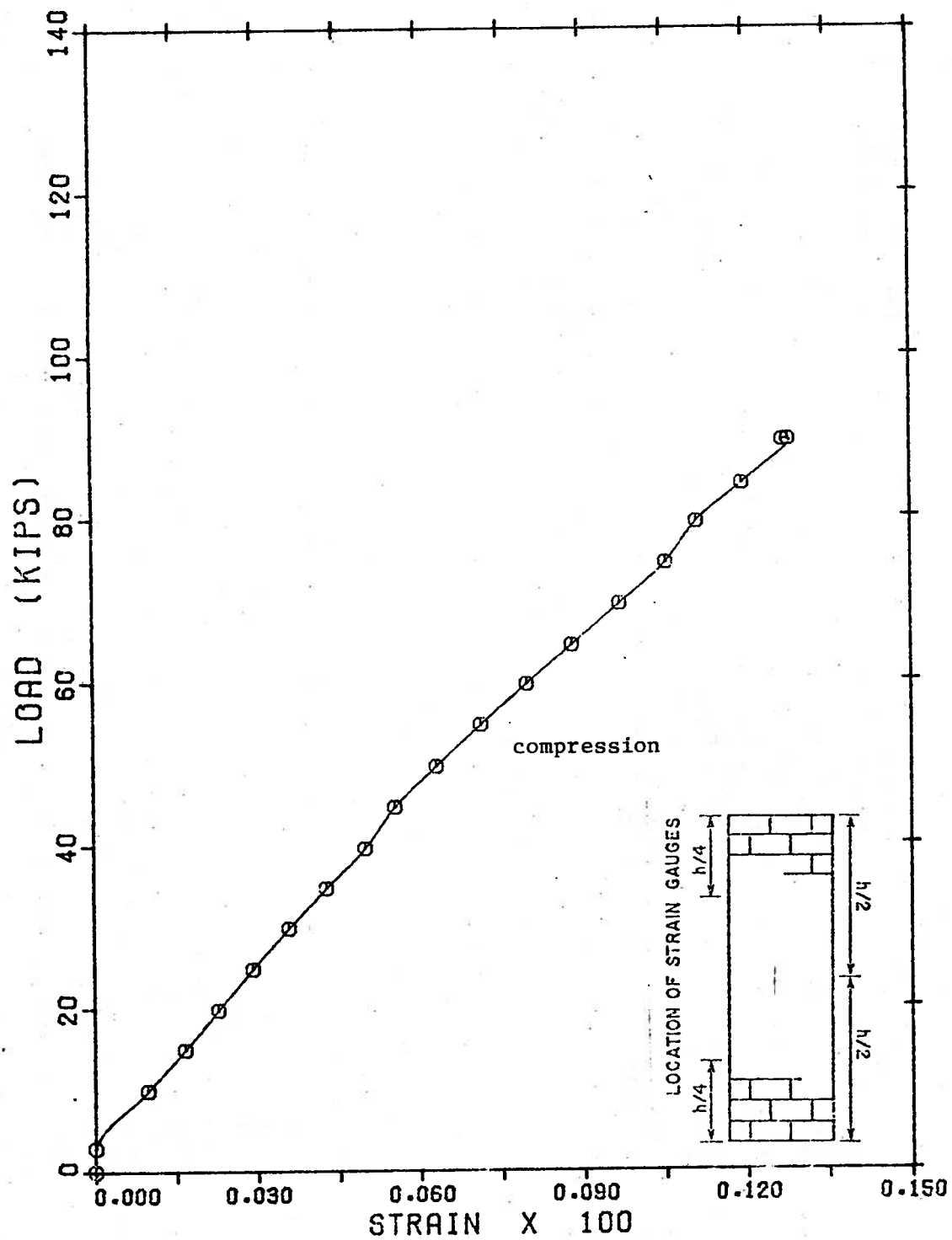

FIG. 2.112 Masonry Strain for Wall C6

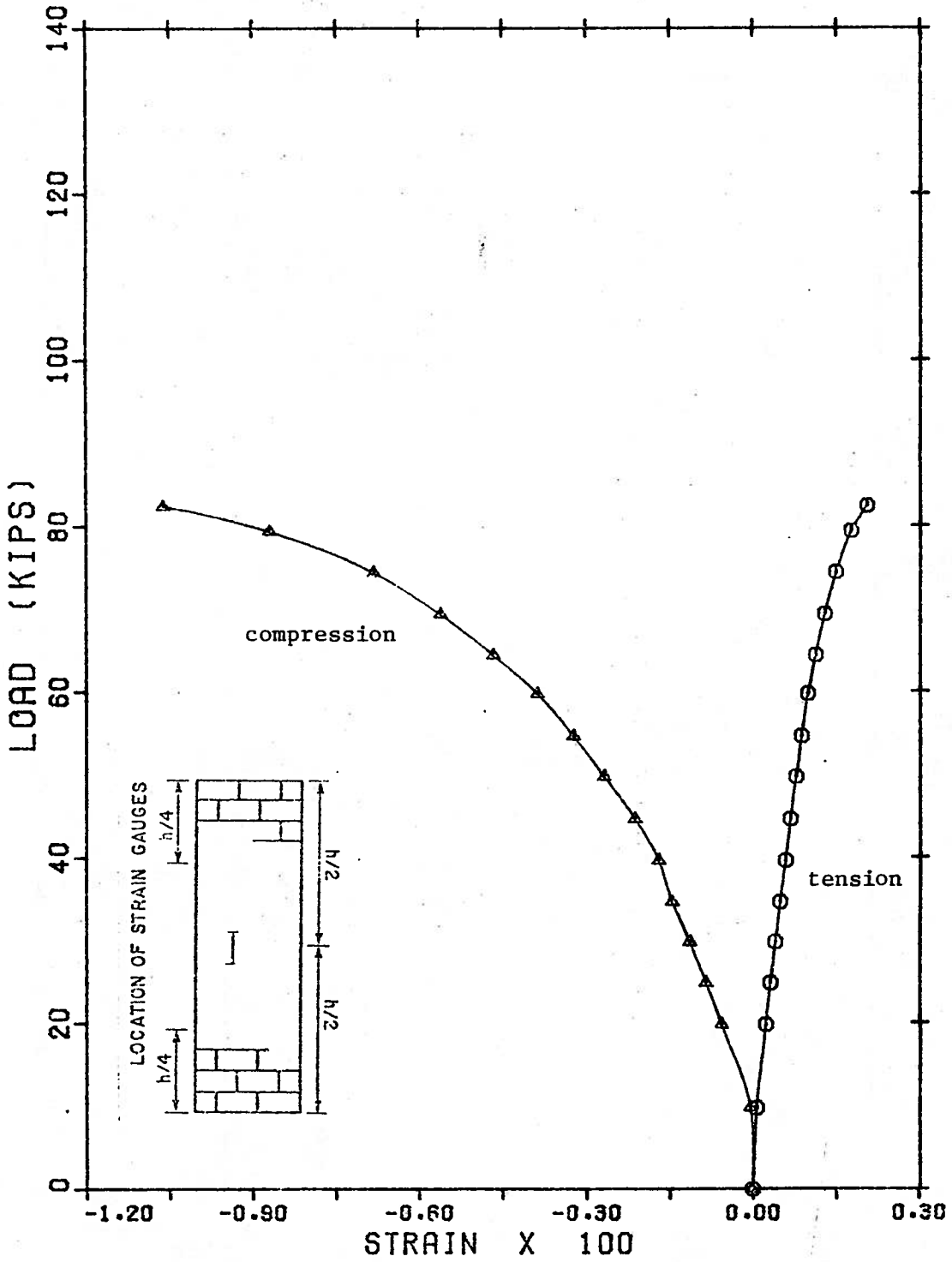

FIG. 2.113 Masonry Strain for Wall D6

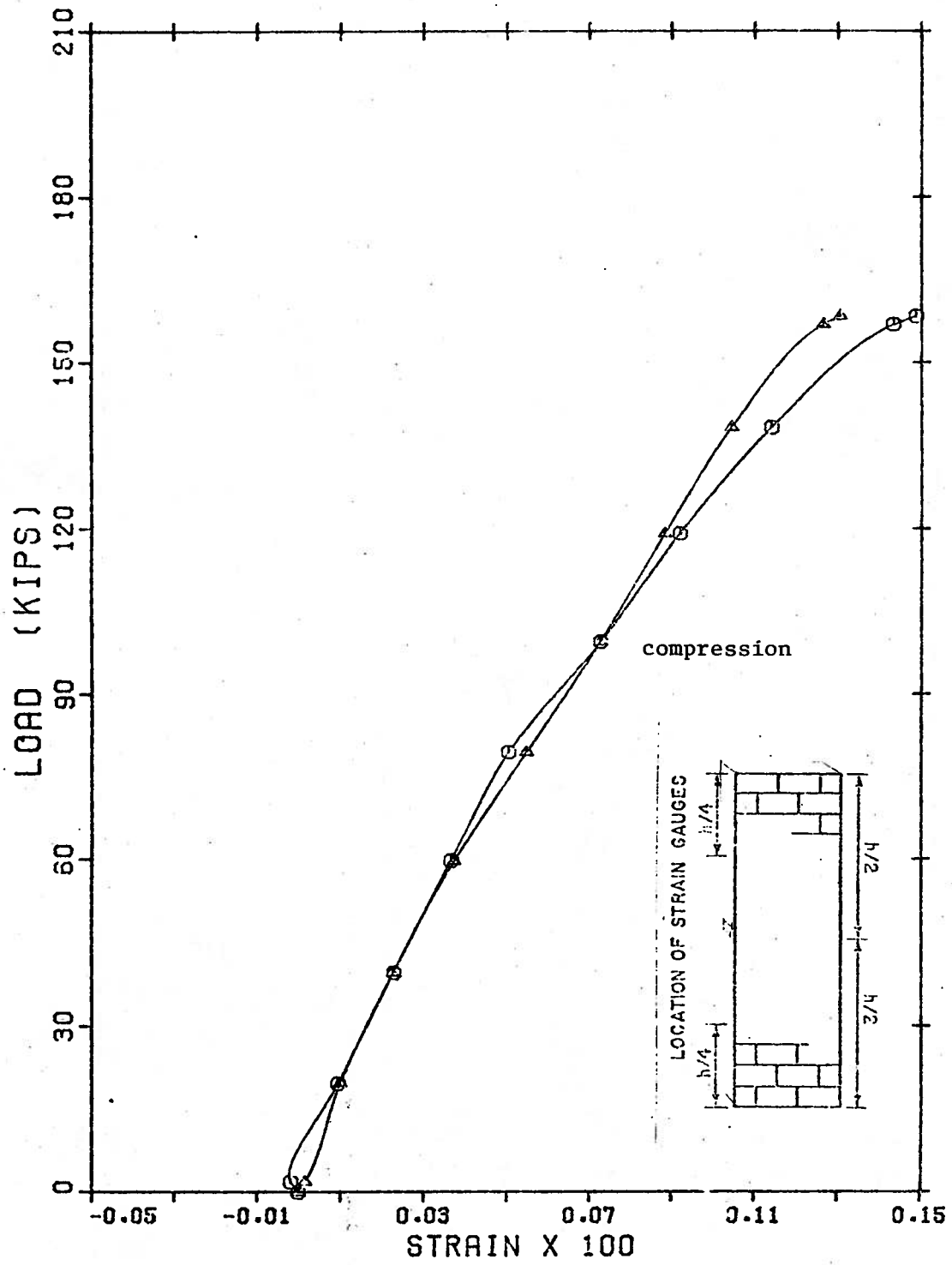

FIG. 2.114 Block Strain for Wall F1

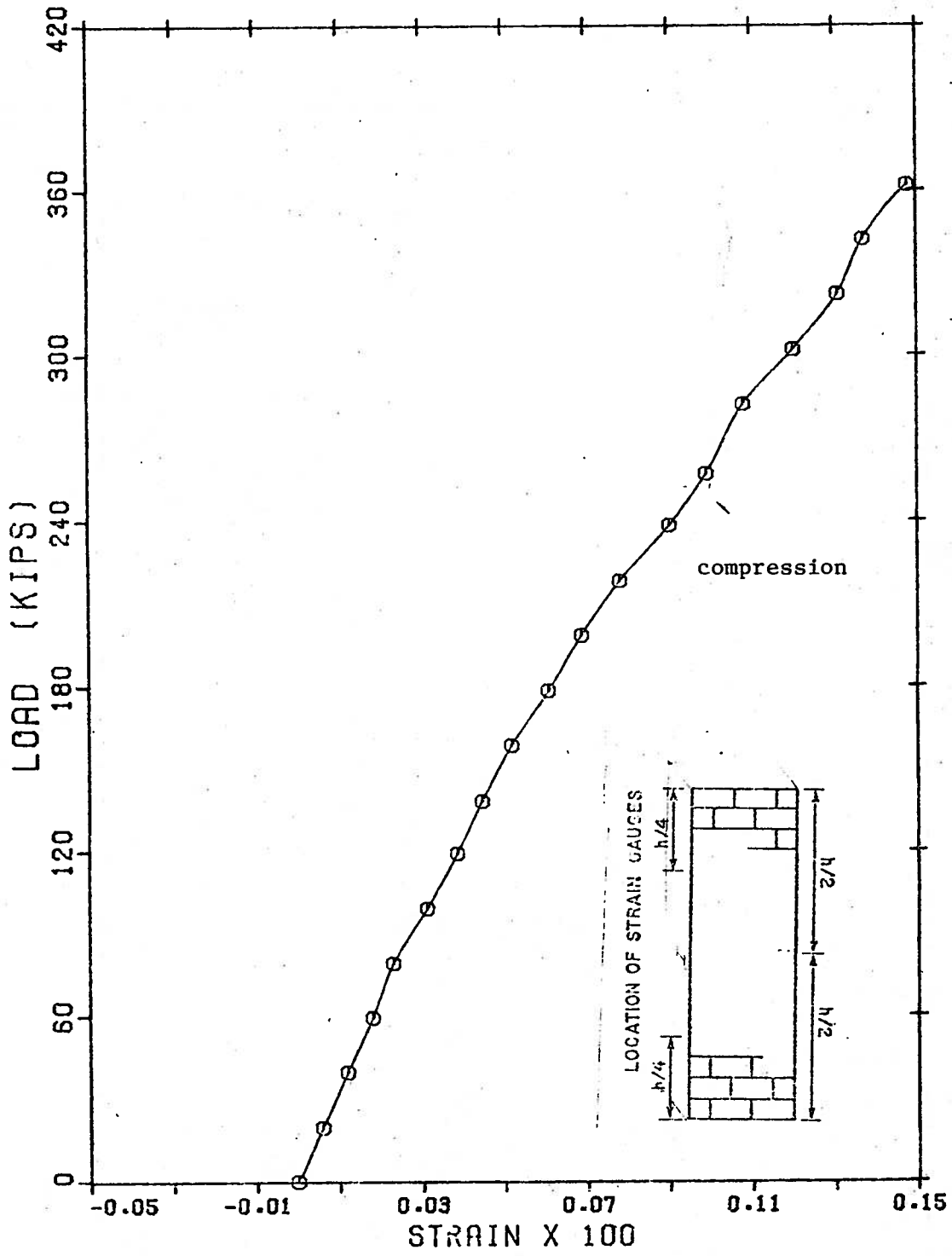

FIG. 2.115 Block Strain for Wall H1

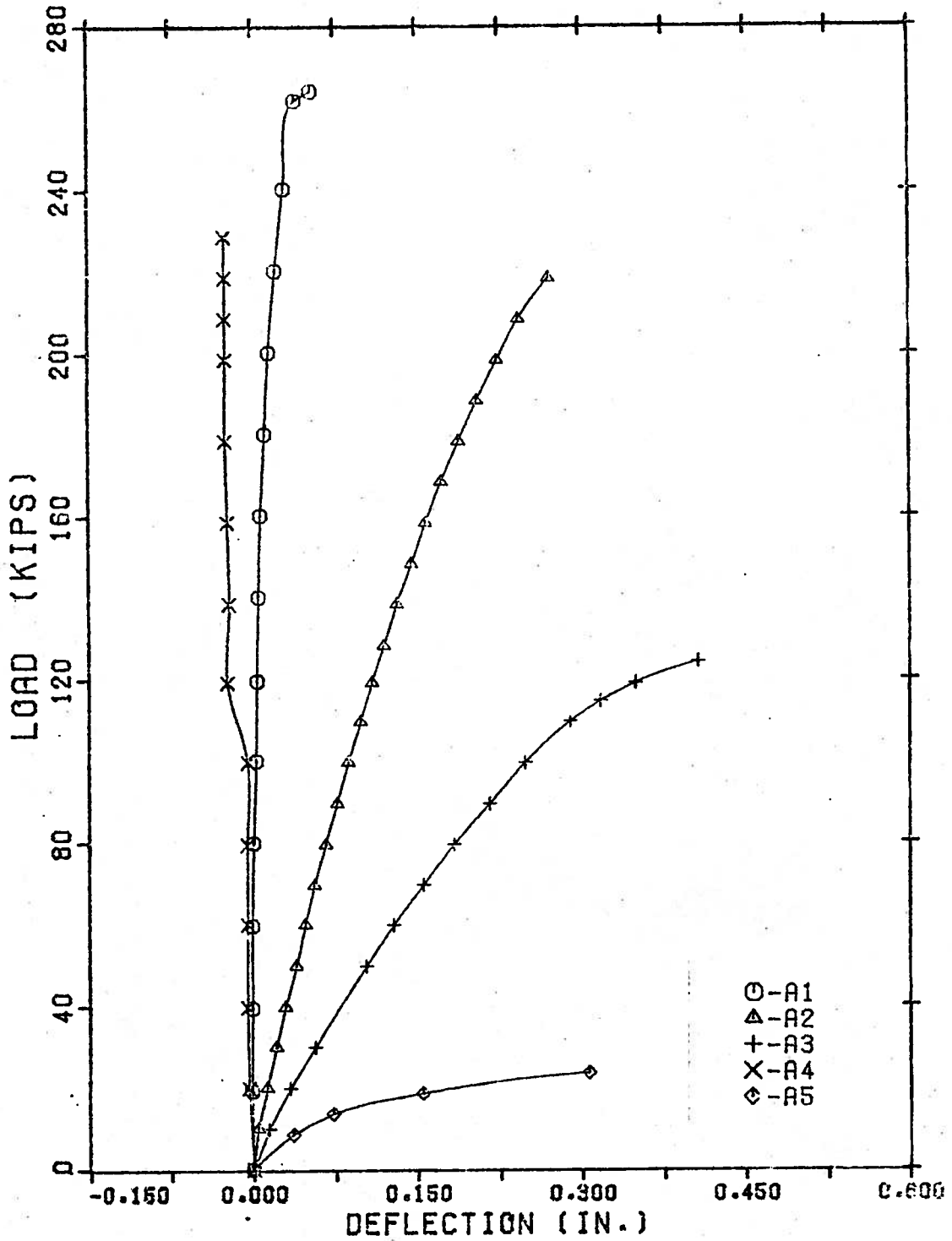

FIG. 2.116 Centerline Deflection of Series A

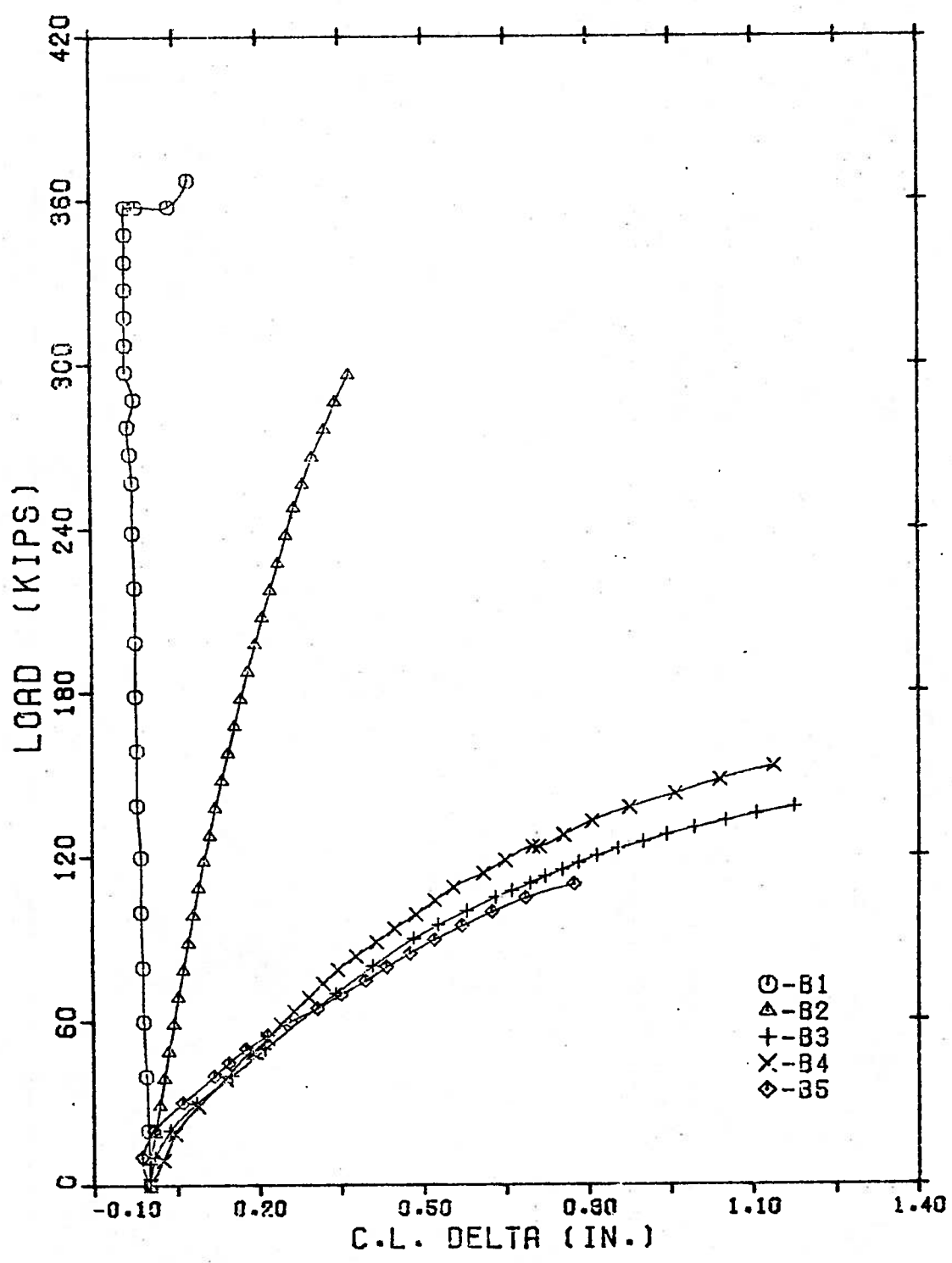

FIG. 2.117 Centerline Deflection of Series B

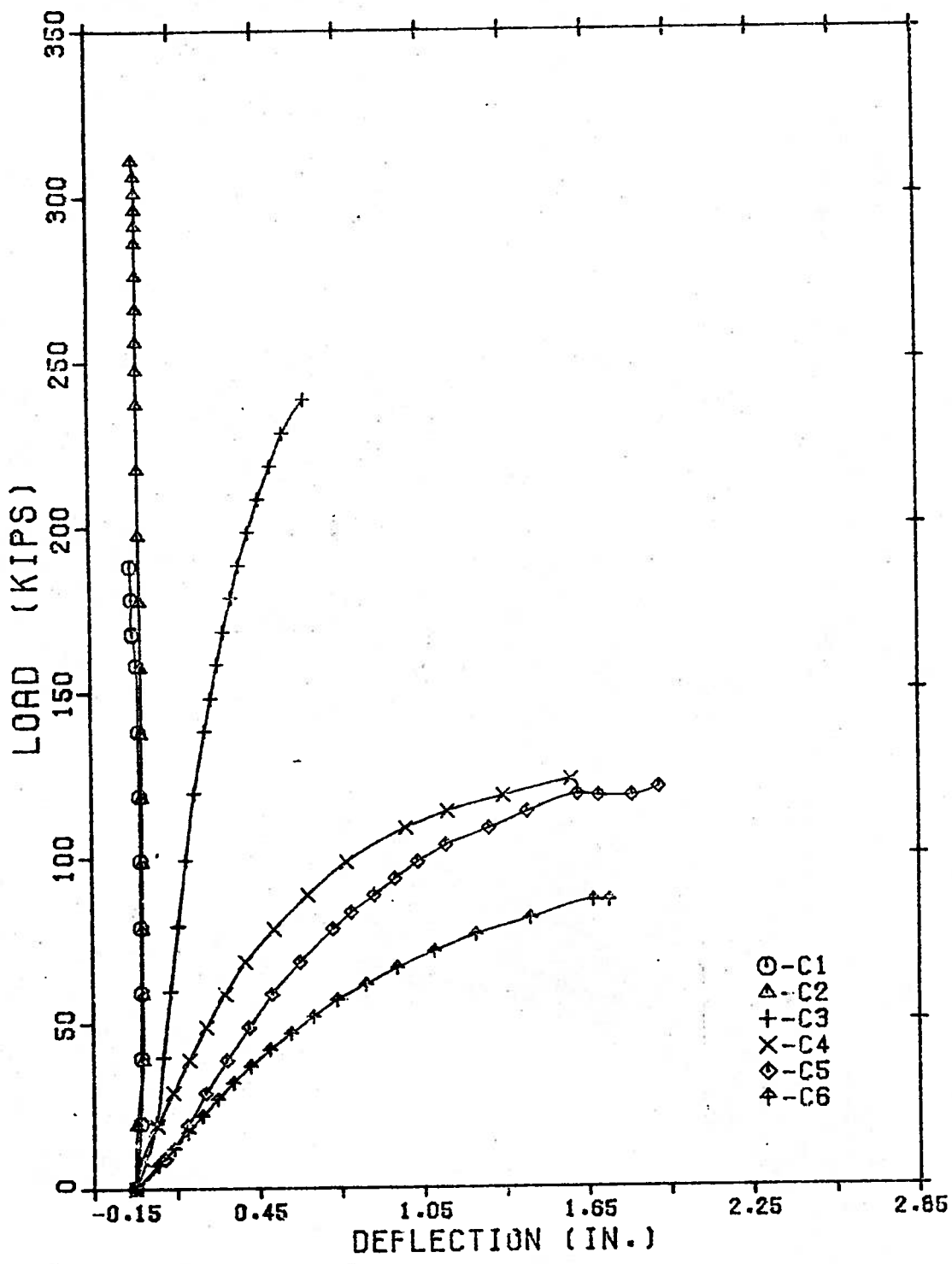

FIG. 2.118 Centerline Deflection of Series C

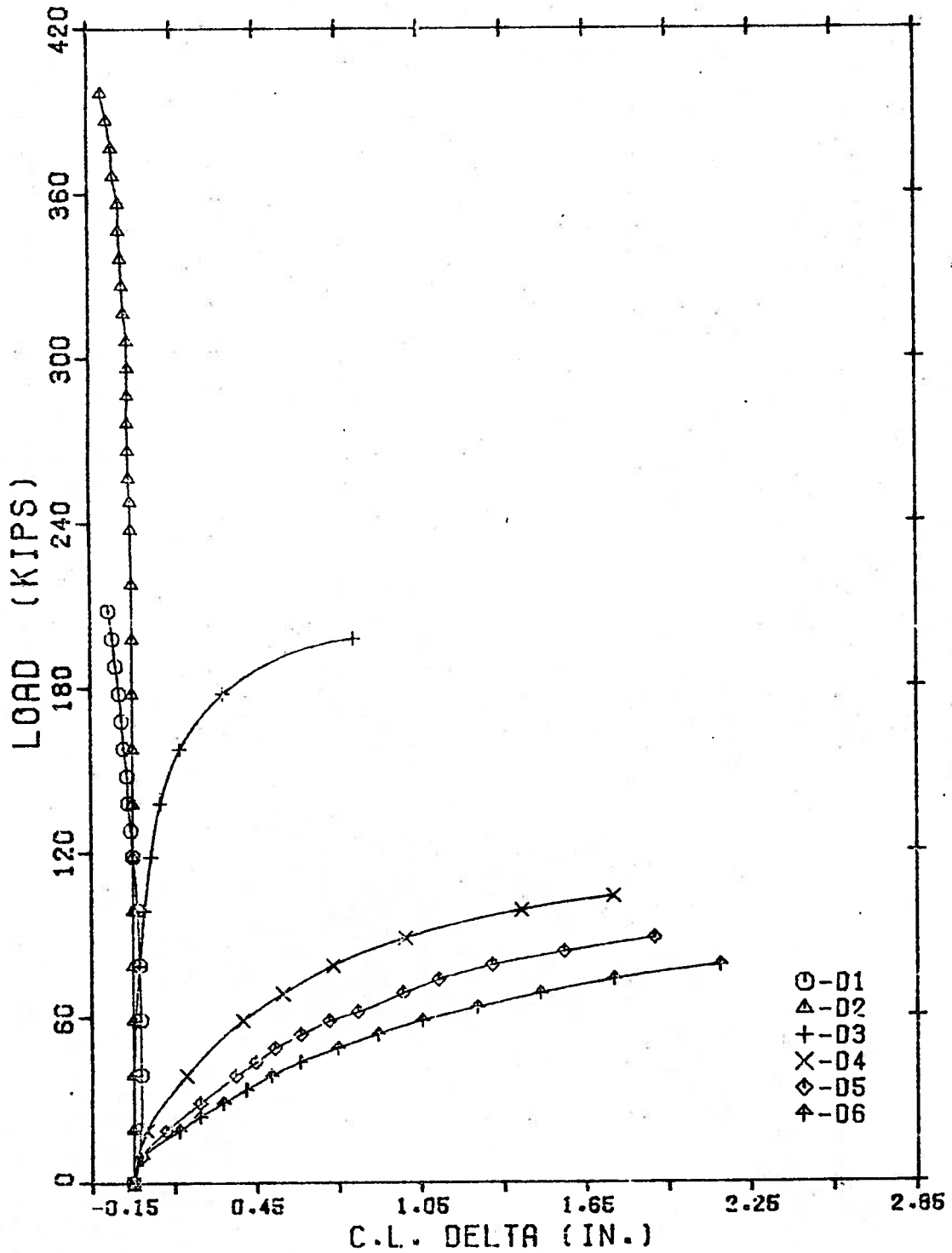

FIG. 2.119 Centerline Deflection of Series D

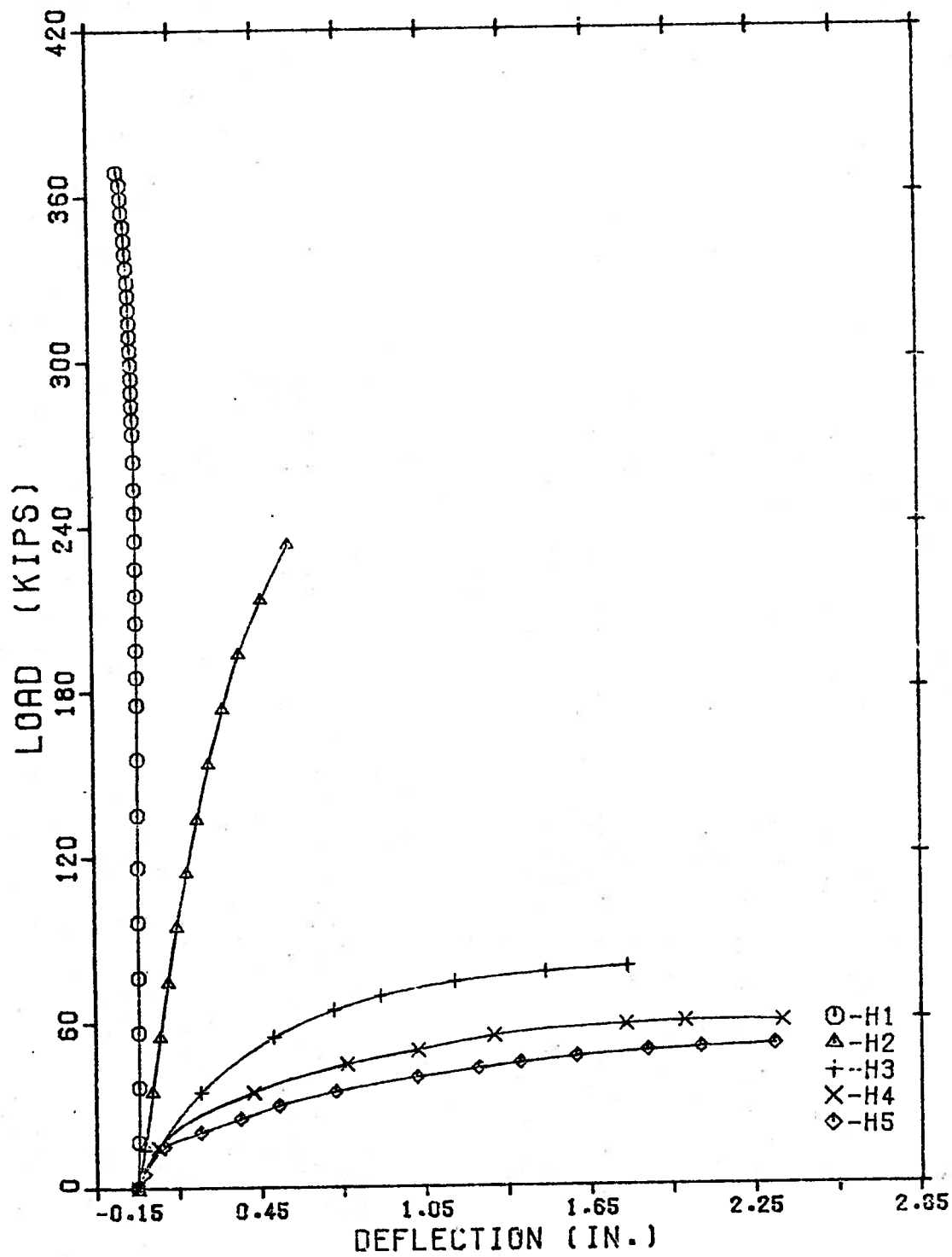

FIG. 2.120 Centerline Deflection of Series H

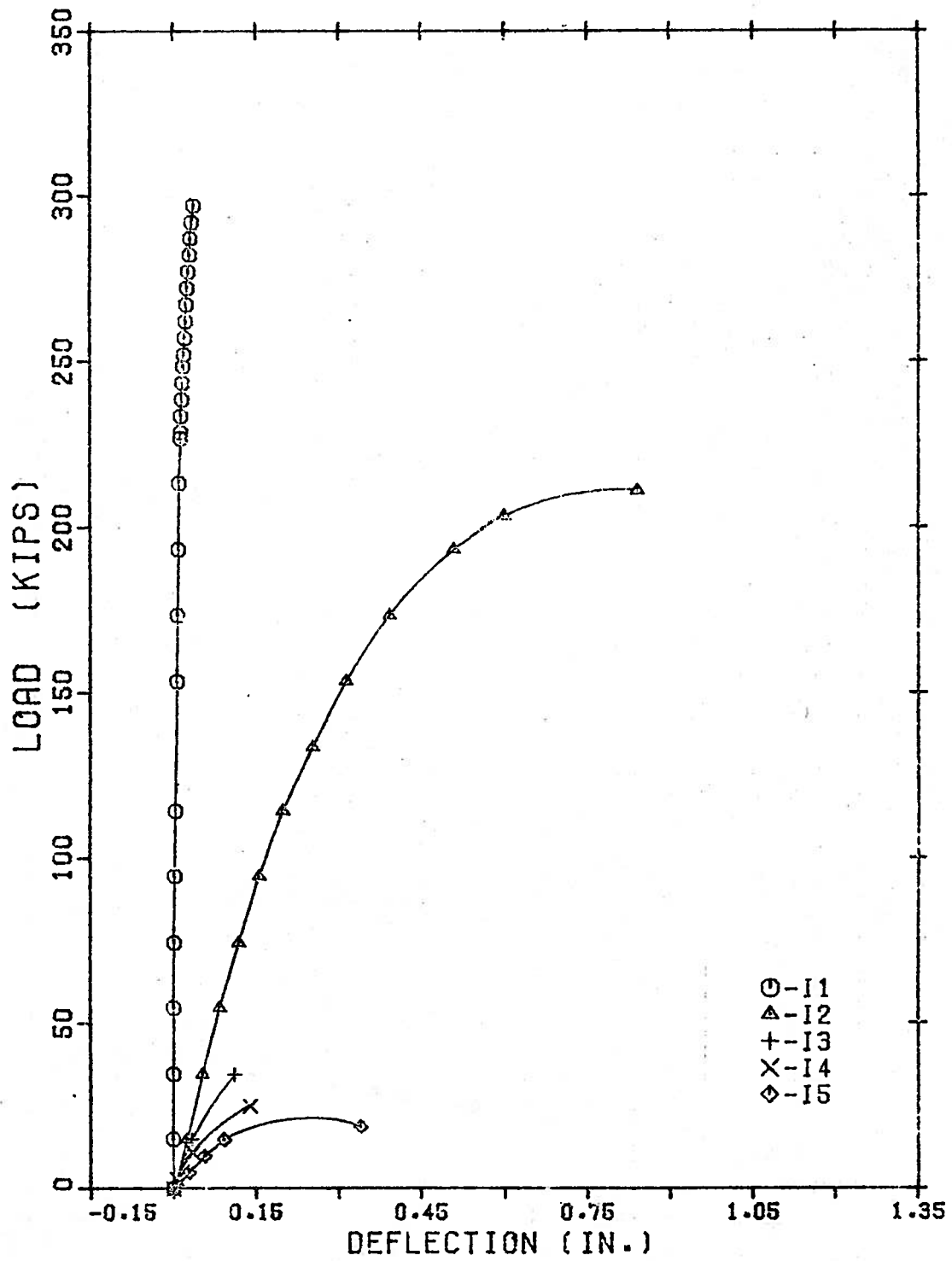

FIG. 2.121 Centerline Deflection of Series I

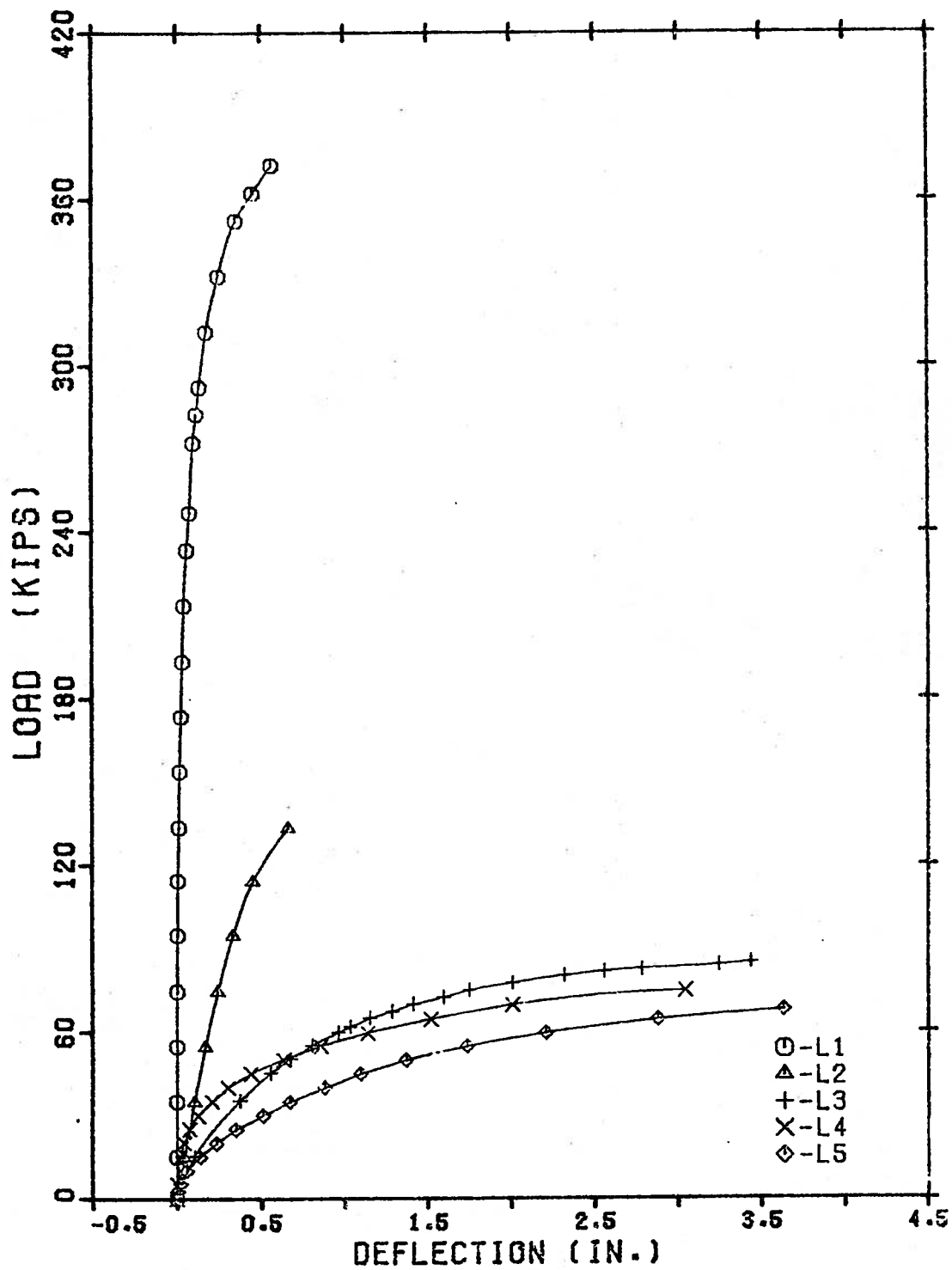

FIG. 2.122 Centerline Deflection of Series L

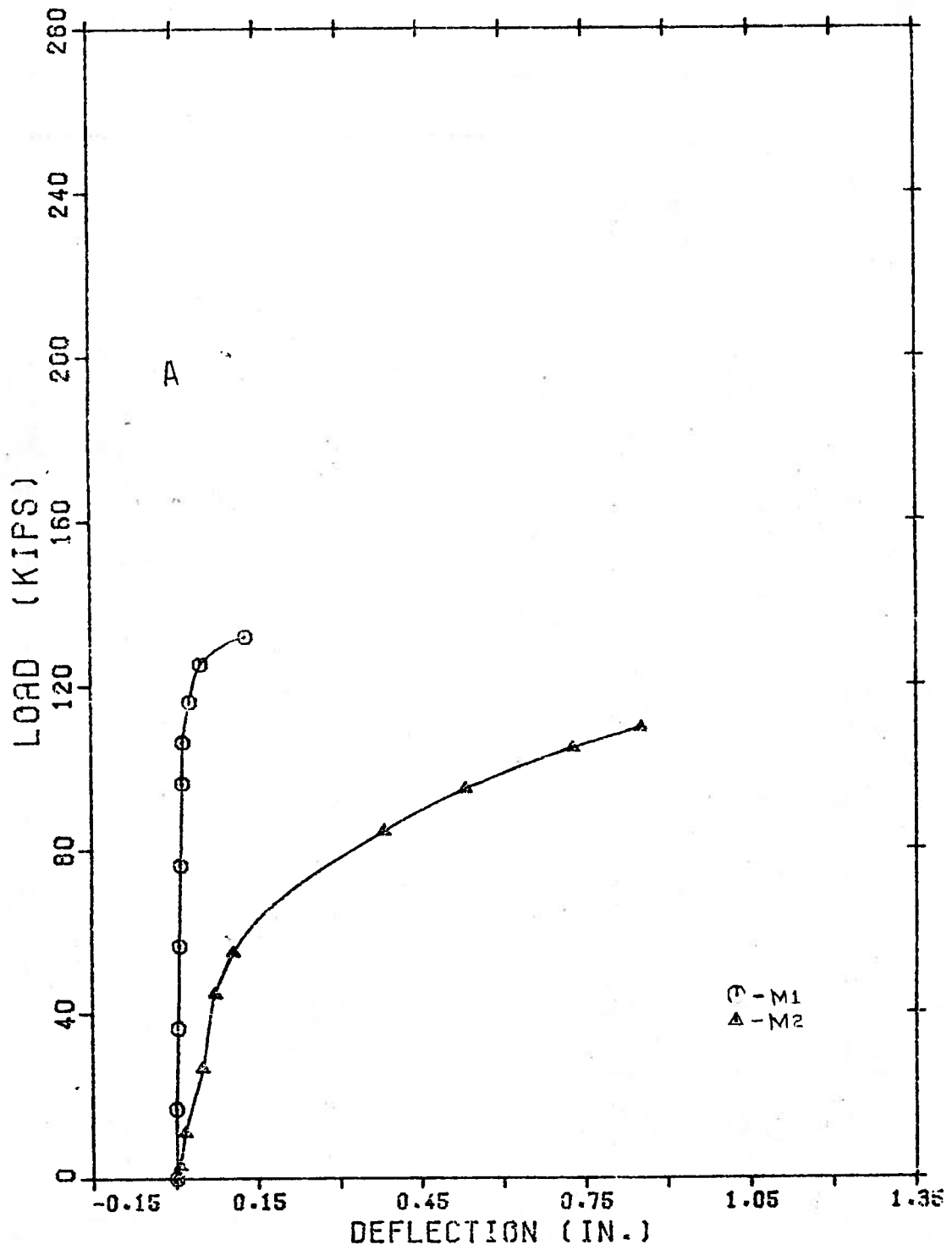

FIG. 2.123 Centerline Deflection of Series M